

GPSMAP 378/478 *chartplotting receiver*



GPSMAP 478 shown

© 2009 Garmin Ltd. or its subsidiaries

Garmin International, Inc.
1200 East 151st Street,
Olathe, Kansas 66062, USA
Tel. (913) 397.8200 or (800) 800.1020
Fax (913) 397.8282

Garmin (Europe) Ltd.
Liberty House
Hounslow Business Park,
Southampton, Hampshire, SO40 9RB UK
Tel. +44 (0) 870.8501241 (outside the UK)
0808 2380000 (within the UK)
Fax +44 (0) 870.8501251

Garmin Corporation
No. 68, Jangshu 2nd Road,
Shijr, Taipei County, Taiwan
Tel. 886/2.2642.9199
Fax 886/2.2642.9099

All rights reserved. Except as expressly provided herein, no part of this manual may be reproduced, copied, transmitted, disseminated, downloaded or stored in any storage medium, for any purpose without the express prior written consent of Garmin. Garmin hereby grants permission to download a single copy of this manual onto a hard drive or other electronic storage medium to be viewed and to print one copy of this manual or of any revision hereto, provided that such electronic or printed copy of this manual must contain the complete text of this copyright notice and provided further that any unauthorized commercial distribution of this manual or any revision hereto is strictly prohibited.

Information in this document is subject to change without notice. Garmin reserves the right to change or improve its products and to make changes in the content without obligation to notify any person or organization of such changes or improvements. Visit the Garmin Web site (www.garmin.com) for current updates and supplemental information concerning the use and operation of this and other Garmin products.

Garmin®, the Garmin logo, AutoLocate®, TracBack®, BlueChart®, City Select®, MapSource®, and See-Thru® are trademarks of Garmin Ltd. or its subsidiaries, registered in the USA and other countries. These trademarks may not be used without the express permission of Garmin.

INTRODUCTION

Thank you for choosing the Garmin® GPSMAP® 378/478, which utilizes the proven performance of Garmin GPS and full-featured mapping to create an unsurpassed portable marine navigation chartplotter and automobile navigation device. Take a moment to compare the contents of this package with the packing list on the outside of the box; if any pieces are missing, contact your Garmin dealer immediately.

About This Manual

To get the most out of your new navigation system, take time to read this manual and learn the operating procedures for your unit. This manual is organized into the following sections:

The **Introduction** contains the Table of Contents, Care Information, and Warnings.

The **Getting Started** section provides an overview of the unit, how to turn the unit on, and how to simulate navigation.

The **Marine Mode** section provides you with information about navigating with the GPSMAP 378/478 in Marine Mode.

The **Marine Mode Pages** section reviews the main pages in Marine Mode.

The **Automotive Mode** section provides you with information about navigating with the GPSMAP 378/478 in Automotive Mode.

The **Automotive Mode Pages** section reviews the main pages in Automotive Mode.

The **Main Menu** section describes features found on the Main Menu, and information on how to change settings.

The **Using XM WX Weather** section describes how to use XM WX Satellite Weather features on your GPSMAP 378/478.

The **Setting Up and Using Sonar** section provides instructions on using a Garmin GSD 20 or GSD 21 Sounder Module with your GPSMAP 378/478.

The **Appendix** contains specifications, optional accessories, maintenance information, and other product information.

An **Index** is provided at the end of the manual for reference.

Table of Contents

Introduction.....	i	Active Route Page.....	50
Caring for the GPSMAP 378/478	iv	Position Data Page.....	51
Warnings	v	XM Audio Page	52
Important Information	vi	Automotive Mode	56
Battery Warnings.....	vi	Automotive Mode Pages.....	56
Getting Started.....	1	Navigating in Automotive Mode.....	57
Unit Overview	1	Editing Your Route	60
Charging the GPSMAP 378/478.....	2	Following an Automotive Route.....	63
Turning On the GPSMAP 378/478	3	Automotive Mode Pages.....	64
Getting Satellite Signals	4	Map Page.....	64
Using the GPSMAP 378/478 Keypad.....	7	Current Route Page.....	65
Using the GPSMAP 378/478.....	8	Trip Computer Page	66
Using Simulator Mode	12	Main Menu	67
Marine Mode.....	13	Main Menu Tabs.....	67
Marine Mode Pages	13	GPS Tab.....	68
Navigating to a Destination	14	Weather Tab	68
Finding an Item.....	17	XM Tab	69
Creating and Using Routes	20	Route Tab	70
Creating and Using Waypoints	24	Points Tab	70
Managing Your Tracks	34	Track Tab	71
Marine Mode Pages.....	38	DSC Tab.....	71
Map Page.....	38	Sonar Tab	75
Compass Page.....	45	Alarms Tab	76
Highway Page.....	48	Calendar Tab.....	78
		Celestial Tab.....	79

Message Tab	83	What is Differential GPS (DGPS)?	122
Display Tab.....	84	LORAN TD Setup.....	124
Sound Tab	85	Map Datums and Location Formats	126
Setup Tab	86	Digital Selective Calling (DSC).....	127
Using XM WX Weather	95	Messages	129
Viewing XM WX Weather.....	95	Data Field Options.....	131
Setting XM WX Weather Options	95	Software License Agreement	133
Using the Weather Tab.....	98	Product Registration	133
Finding Weather Information.....	101	Limited Warranty	134
Setting Up and Using Sonar	103	Weather Data Warranty	135
Showing Sonar on the Map Page.....	103	XM Satellite Radio Service Agreement.....	136
Using the Sonar Page	104	FCC Compliance.....	137
Setting Up Sonar	108	Index	138
Understanding Sonar	112		
Appendix	115		
Specifications	115		
Optional Accessories.....	116		
Installation Information.....	117		
Satellite Information.....	122		

Caring for the GPSMAP 378/478

The GPSMAP 378/478 case is constructed of high quality materials and does not require user maintenance except cleaning.

Cleaning the Case

Clean the unit's outer casing (except for the screen) using a cloth dampened with a mild detergent solution and then wipe dry.

Avoid chemical cleaners and solvents that might damage plastic components.

Cleaning the Screen

The GPSMAP 378/478 screen should be cleaned using a soft, clean, lint-free cloth. Water, isopropyl alcohol, or eyeglass cleaner can be used if needed. If these are used, apply the liquid to the cloth and then gently wipe the screen with the moistened cloth.

Storage

Do not store the GPSMAP 378/478 where prolonged exposure to temperature extremes might occur (such as in the trunk of a car) as permanent damage could result. User information, such as waypoints and routes, is retained in the unit's memory without the need for external power. It is always a good practice to back up important user data by manually recording it or downloading it to a computer (transferring it to MapSource).

Water Immersion

The GPSMAP 378/478 is waterproof to IEC Standard 60529 IPX7. It can withstand immersion in 1 meter of water for 30 minutes. Prolonged submersion can cause damage to the unit. After submersion, be certain to wipe and air dry the unit before reuse or charging.

Warnings

Failure to avoid the following potentially hazardous situations could result in an accident or collision resulting in death or serious injury.

- When installing the unit in a vehicle, place the unit securely so that it does not obstruct the driver's view of the road or interfere with vehicle operating controls, such as the steering wheel, foot pedals, or transmission levers. Do not place in front of or above any airbag. (See diagram.)

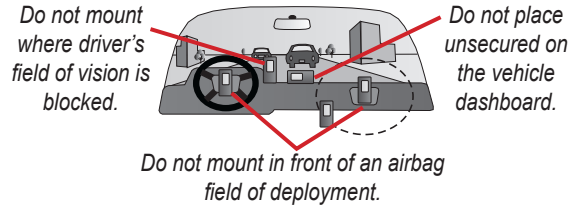

- When navigating, carefully compare information displayed on the unit to all available navigation sources, including information from street signs, visual sightings, and maps. For safety, always resolve any discrepancies or questions before continuing navigation and defer to posted road signs.

- Always operate the vehicle in a safe manner. **Do not become distracted by the unit while driving, and always be fully aware of all driving conditions.** Minimize the amount of time spent viewing the unit's screen while driving and use voice prompts when possible. Do not input destinations, change settings, or access any functions requiring prolonged use of the unit's controls while driving. Pull over in a safe and legal manner before attempting such operations.
- This unit is designed to provide route suggestions. It is not designed to replace the need for driver attentiveness regarding road closures or road conditions, traffic congestion, weather conditions, or other factors that may affect safety while driving.
- Use the electronic chart in the unit only to facilitate, not to replace, the use of authorized government charts. Official government charts and notices to mariners contain all information needed to navigate safely.
- Use this unit only as a navigational aid. Do not attempt to use the unit for any purpose requiring precise measurement of direction, distance, location, or topography.

WARNING: This product, its packaging, and its components contain chemicals known to the State of California to cause cancer, birth defects, or reproductive harm. This Notice is provided in accordance with California's Proposition 65. See www.garmin.com/prop65 for more information.

Important Information

MAP DATA INFORMATION: One of the goals of Garmin is to provide customers with the most complete and accurate cartography that is available to us at a reasonable cost. We use a combination of governmental and private data sources, which we identify in product literature and copyright messages displayed to the consumer. Virtually all data sources contain some inaccurate or incomplete data. In some countries, complete and accurate map information is either not available or is prohibitively expensive.

NOTICE REGARDING WINDSHIELD MOUNTING; SPECIAL

NOTICE TO DRIVERS IN CALIFORNIA AND MINNESOTA: State law prohibits drivers in California and Minnesota from using suction mounts on their windshields while operating motor vehicles. Check your state and local laws and ordinances for similar restrictions. Other Garmin dashboard or friction mounting options should be used. Garmin does not take any responsibility for any fines, penalties, or damages that may be incurred as a result of disregarding this notice or as a result of any other state or local law or ordinance relating to use of the unit. (See California Vehicle Code Section 26708(a); Minnesota Statutes 2005, Section 169.71.)

The California Electronic Waste Recycling Act of 2003 requires the recycling of certain electronics. For more information on the applicability to this product, see www.erecycle.org.

Battery Warnings

If these guidelines are not followed, the internal lithium-ion battery may experience a shortened life span or may present a risk of damage to the GPS unit, fire, chemical burn, electrolyte leak, and/or injury.

- Do not leave the unit exposed to a heat source or in a high temperature location, such as in the sun in an unattended vehicle. To prevent damage, remove the unit from the vehicle or store it out of direct sunlight, such as in the glove box.
- Do not puncture or incinerate.
- When storing the unit for an extended time, store within the following temperature range: 32° to 77°F (0° to 25°C).
- Do not operate the unit outside of the following temperature range: -4° to 131°F (-20° to 55°C).
- Contact your local waste disposal department to properly recycle/dispose of the unit/battery.

Additional User-Replaceable Battery Warnings:

- Do not use a sharp object to remove the battery.
- Keep the battery away from children.
- Do not disassemble, puncture, or damage the battery.
- If using an external battery charger, only use the Garmin accessory approved for your product.
- Only replace the battery with the correct replacement battery. Using another battery presents a risk of fire or explosion. To purchase a replacement battery, see your Garmin dealer or the Garmin Web site.

GETTING STARTED

Unit Overview

The GPSMAP 378/478 is an all-in-one, versatile color chartplotter and automobile navigator—perfect for land or water. This portable GPS navigator features a 256-color TFT display that is easy to read in bright sun and includes built-in g2 cartography (GPSMAP 478) or built-in lake cartography (GPSMAP 378), and preloaded City Navigator NT® to provide you with automatically generated turn-by-turn directions. With the optional GXM 30 antenna and a subscription to XM WX Satellite Weather, users have constant access to NEXRAD radar, lightning, wind speed, wave direction, and more. In addition, the GPSMAP 378/478 offers XM Satellite Radio capabilities featuring more than 160 digital channels of commercial-free music; more than 30 channels of news, sports, talk, and entertainment; and more than 20 dedicated channels of XM Instant Traffic & Weather.

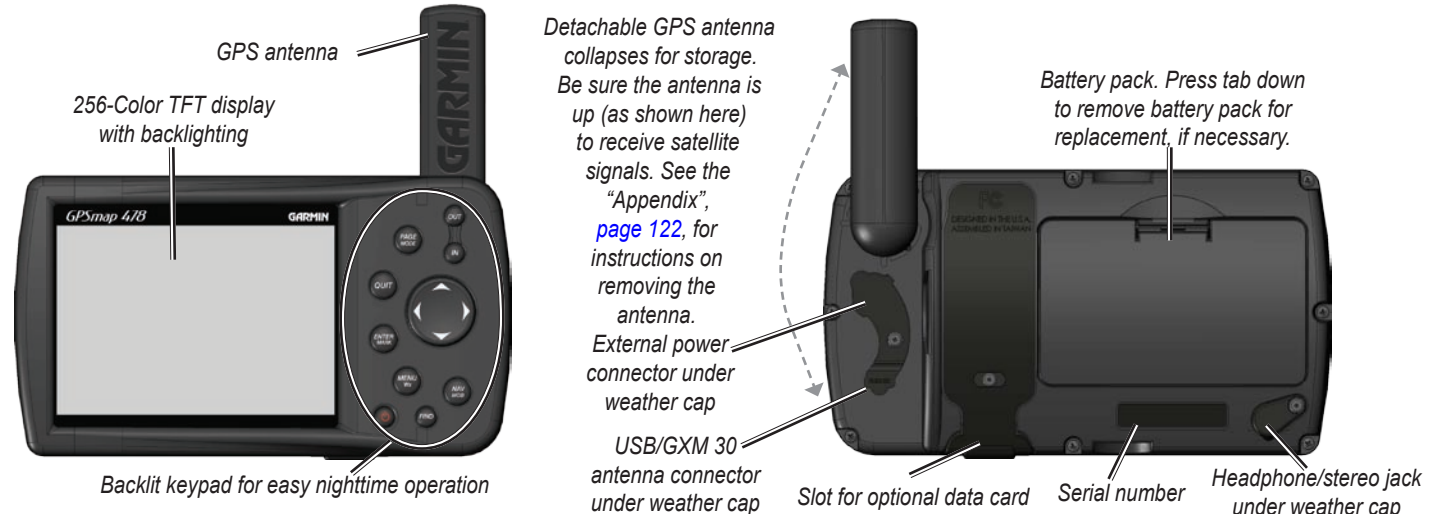

Charging the GPSMAP 378/478



Before using the GPSMAP 378/478, you might need to charge the battery. Plug the power cable into an external power source to charge. You can use the unit while it is charging.

To charge the unit's battery:

1. Lift the rubber weather cap to expose the power connector on the back of the unit. See the image on page 1 for connector location.
2. Align the notches and push the plug into the connector until fully seated.
3. Plug the 12-Volt adapter into an available AC outlet, or cigarette lighter receptacle if you have a cigarette lighter adapter. Use care when routing the cable; make sure it does not interfere with vehicle operation. The unit begins charging as soon as external power is applied.



TIP: Placing the unit in Charge Mode charges the unit more quickly than when the unit is turned on, and reduces draw on the vehicle/vessel battery.

When you turn on the GPSMAP 378/478 the power source indicator on the GPS tab shows the unit is operating off battery power () , that the unit is charging () , or that an external power source is in use () .

Using Charge Mode

If you want to charge the battery when you are not using the unit, you can put the unit into Charge Mode.



NOTE: While in Charge Mode, the GPSMAP 378/478 draws a small amount of current from the vessel/vehicle battery. To avoid discharging the vehicle's battery, disconnect the external power cable from the unit when not in use for several days.

Over time, you might notice that the lithium-ion battery in the unit is not holding a charge any more. This is common for lithium-ion batteries. Contact Garmin or your Garmin dealer to order a battery pack replacement if you are experiencing charging issues.

Turning On the GPSMAP 378/478

Before you turn on the GPSMAP 378/478, be sure the antenna is up as shown on page 1, and it has a clear and unobstructed view of the sky to receive satellite signals.

The first time you turn on your GPSMAP 378/478, the GPS receiver must collect satellite data and establish its current location. To ensure proper initialization, the GPSMAP 378/478 is shipped from the factory in AutoLocate Mode, which allows the receiver to “find itself” anywhere in the world.

To turn the GPSMAP 378/478 on and off:

1. Press and hold the **POWER** key. When the unit turns on, a tone sounds and the Warning Page opens.



Warning Page

2. Read the warning, and then press **ENTER** to continue.
3. To turn off the GPSMAP 378/478, press and hold the **POWER** key again.

Adjusting the Backlight and Volume

You can adjust the backlight to see the screen better. If you are using the external speaker with 12/24-Volt adapter cable with the GPSMAP 378/478 or you have headphones plugged into the headphone jack, you can adjust the volume level of the audio output.

To adjust the backlight level or volume:

1. Press and quickly release the **POWER** key.
2. Press up on the **ROCKER** to increase the brightness or press down to decrease. Press right to raise the volume or left to lower.
3. Press **ENTER** or **QUIT** to close the Backlight/Volume adjustment window.

Battery time remaining and power source indicator

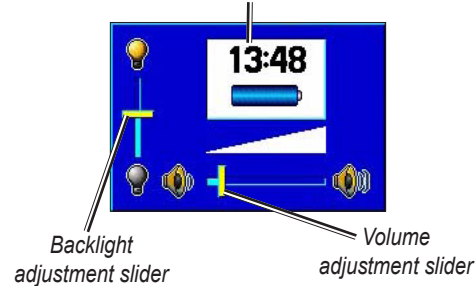

Getting Satellite Signals

After you turn on the GPSMAP 378/478, the unit automatically begins searching for satellites. The GPS Page appears while the unit is gathering satellite signals and acquiring a fix, which should take only a few minutes. While the GPSMAP 378/478 is getting satellite signals, the GPS Page shows the status as “Acquiring Satellites.”

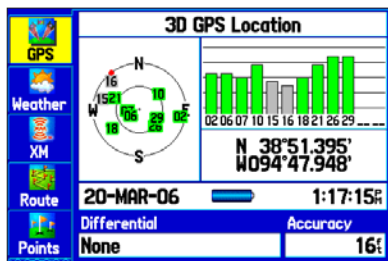

GPS Tab



NOTE: While acquiring satellites, the Map Page might show the wrong location, such as China. You need to wait a few more minutes to acquire satellites and find your current location.

Viewing GPS Status with the GPS Tab

The GPS tab provides a visual reference of satellite acquisition, receiver status, and accuracy. The sky view and signal strength bars show what satellites are visible to the receiver and whether they are being tracked.

As the receiver locks onto satellites, a signal strength bar appears for each satellite in view, with the appropriate satellite number underneath each bar. The numbers below each bar represent the particular satellite that is being received. Numbers above 33 indicate WAAS satellites.

The sky view shows a bird’s eye view of the position of each satellite relative to the receiver’s last known position. The outer circle represents the horizon (north up), the inner circle represents 45° above the horizon, and the center point represents a position directly overhead. You can also set the sky view to a Track Up configuration, causing the top of the sky view to align along your current track heading. Press **MENU** to change the configuration of the sky view.

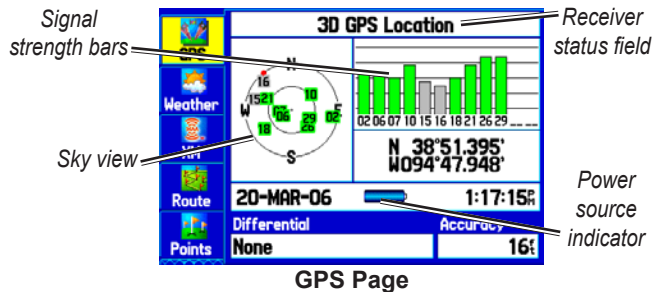

GPS Page

The progress of satellite acquisition is shown in three stages:

- **No signal strength bars**—the receiver is looking for the satellites indicated.
- **White signal strength bars**—the receiver has found the satellite and is collecting data.
- **Green signal strength bars**—the receiver has collected the necessary data from this satellite.

When the GPSMAP 378/478 collects the necessary data from the best satellites in view to calculate a fix, the status field indicates the status of the receiver. The unit then updates the location, date and time.

Receiver Status

The Receiver Status field shows one of the following conditions:

- **Searching the Sky**—the receiver is looking for satellites.
- **AutoLocate**—the receiver is looking for any satellite whose almanac was collected, which can take up to five minutes.
- **Acquiring Satellites**—the receiver is looking for and collecting data from satellites visible at its last known or initialized location but has not acquired a fix.

- **2D GPS Location**—At least three satellites were acquired and a two-dimensional position fix was calculated. “2D Differential” appears when you are receiving DGPS corrections in 2D mode, and a “D” appears on the strength bar of satellites being corrected.
- **3D GPS Location**—At least four satellites were acquired and a three-dimensional fix was calculated. “3D Differential” appears when you are receiving DGPS corrections in 3D mode, and a “D” appears on the strength bar of satellites being corrected.
- **Lost Satellite Reception**—the receiver is no longer tracking enough satellites for a 2D or 3D fix.
- **Receiver Not Usable**—the receiver is unusable, possibly due to interference or abnormal satellite conditions. Turn the unit off and back on to reset it.
- **Simulating GPS**—the receiver is in Simulator Mode.
- **GPS Off**—the GPS receiver is turned off.

GPS Options

Press **MENU** twice to open the Main Menu. Use the **ROCKER** to highlight the **GPS** tab. Press **MENU** to open the options menu.



Start/Stop Simulator—starts and stops Simulator Mode, which is helpful when learning how to use your unit.

Enable/Disable WAAS—enables or disables WAAS capability. See [page 124](#) of the “Appendix” for more information about WAAS.

Track Up Skyview/North Up Skyview—orients the sky view display on the GPS Page to North up or Track up.

New Altitude—allows you to manually enter your altitude.

New Location—allows you to enter a new location automatically or using the map.

GPS Tips

While the receiver is gathering information, your location on the map might appear different from where you are actually located. As soon as the receiver gathers enough satellite information, your proper location appears on the map.

Any time you have traveled more than 600 miles with the GPS receiver turned off, the receiver might take longer than normal to initialize and find your location.

The GPS receiver can lose satellite signals due to interference from such items as buildings, tunnels, and heavy tree cover. Monitoring the GPS status is recommended.

To learn about GPS, visit www.garmin.com/aboutGPS/.

Using the GPSMAP 378/478 Keypad

PAGE/MODE Key

- Press to cycle through main pages in sequence and exit a submenu page.
- Press and hold to switch between Marine and Automotive Modes.

QUIT Key

- Press to cycle through main pages in reverse sequence, revert to the previous value in a data entry field, or cancel an unintended function.

ENTER/MARK Key

- Press to select a highlighted option.
- Press and hold to mark your current location as a waypoint.

MENU/Wx Key

- Press to open the options menu for the current page.
- Press twice to show the Main Menu.
- Press and hold to toggle XM WX weather on or off on the Map Page.

POWER Key

- Press and hold to turn the unit on or off.
- Press and release to adjust the backlighting and external speaker volume.

IN Key/OUT Key

- Press to adjust map scale to show a larger area with less detail (zoom out) or a smaller area with more detail (zoom in).

ROCKER

- Press up, down, left, or right to highlight options and to enter data, or use to pan the arrow  on the Map Page.

NAV/MOB Key

- Press to show the Navigate Menu.
- In Marine Mode, press and hold to start the MOB function.

In Automotive Mode, press and hold to show the Next Turn page and announce the next turn when using the external speaker.

FIND Key

- Press to quickly search for and access user waypoints, cities, and other items used for navigation.



Using the GPSMAP 378/478

The advanced keypad system on the GSPMAP 378/478 is designed to allow you to select options and enter data quickly and conveniently. As you progress through this owner's manual, you are directed to press a specific key or highlight a field on the screen. When you are directed to press a key, you should press and quickly release the key. If the key needs to be held down for a period of time to start a secondary function, the instructions will tell you to do so. When a field is selected on the screen, it is highlighted in yellow.

The following terms are used throughout this manual:

- **Highlight**—move the highlighted area on the screen up, down, left, or right with the **ROCKER** to select individual fields. Moving the highlight to a given location allows you to make a selection, begin data entry, or scroll through a list.
- **Field**—the location on a page where data or an option can be shown and entered. Select (highlight) a field using the **ROCKER** to begin entering data or selecting options.
- **On-screen button**—use the **ROCKER** to highlight a button and press **ENTER** to select the button.
- **Scroll bar**—when viewing a list of items too long to appear on the screen, a scroll bar appears along the right side of the list. To scroll through a list, press up or down on the **ROCKER**.

- **Default**—the factory setting saved in the unit's memory. You can change the settings, and you can also revert to the factory (default) settings when you select **Restore Defaults**.

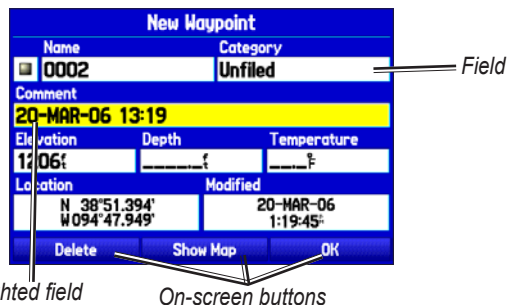

Cartography

The GPSMAP 378 system contains preloaded U.S. inland freshwater cartography to its enhanced worldwide basemap information. The preloaded inland maps offer 50-meter shoreline resolution throughout the US, with even more detailed 10-meter resolution on select lakes. Other details include depth contours, tide and current data, boat ramps, mile markers, hazards, marinas, campgrounds, area roads, and more.

The GPSMAP 478 system contains preloaded marine map detail utilizing BlueChart® g2 technology. Coverage is for US coastal areas.

Selecting Options and Entering Data

To enter data and select options use the **ROCKER** to highlight, select, or choose an item in a list or a field on the screen. Use the **ENTER** key and the **ROCKER** to select options, enter names and numbers in data fields, and activate your selections.

To select and activate an option:

1. From any page, press **MENU**. An options menu shows a list of optional features to that page.

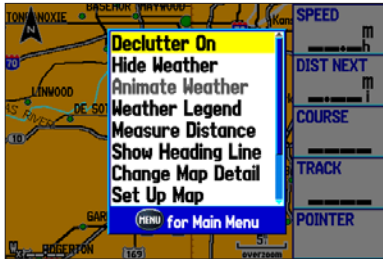

2. Use the **ROCKER** to move the highlight up, down, right, or left on the menu to the option you want to select.
3. Press **ENTER** to select the feature. Another window with more options might appear. If so, select an option and press **ENTER** again.

To exit a menu or return to the previous setting:

Press **QUIT**. The **QUIT** key moves backward through your steps. Press **QUIT** repeatedly to return to the starting page.

To select an on-screen button:

On a page with on-screen buttons, use the **ROCKER** to highlight an on-screen button, and press **ENTER**.



To mark your current location as a waypoint, press and hold **ENTER/MARK** until the New Waypoint Page opens.

To enter data in a data field:

1. Use the **ROCKER** to highlight the data field you want, and press **ENTER** to edit it.
2. Press up or down on the **ROCKER** to select characters. Press right to move to the next character or press left to move back to the previous character. If there are two lines of data, keep pressing right on the **ROCKER** to drop to the next line.



TIP: To clear the entire data field, highlight the left-most character field and press left on the **ROCKER** again.

3. Press **ENTER**.

Not all fields are programmable. When you are on a page with fields that are not selectable, the highlight skips over them.

Restoring Default Settings

You can restore factory defaults for the following Main Menu tabs: Track, Alarms, Display, Sound, and Setup. For more information about the Main Menu, see the “Main Menu” section beginning on page 67.

To restore default settings:

1. Press **MENU** twice to open the Main Menu.
2. Use the **ROCKER** to highlight a tab, and then press **MENU** to open the options menu.

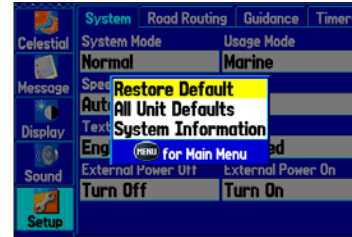

Setup Tab Options Menu

3. Highlight **Restore Default**, and press **ENTER**.

Using the Main Menu

Use the Main Menu on your GPSMAP 378/478 to access various waypoint, system, navigation and interface management, and setup menus. Press the **MENU** key twice from any page to open the Main Menu. For more information, see the “[Main Menu](#)” section on [page 67](#).

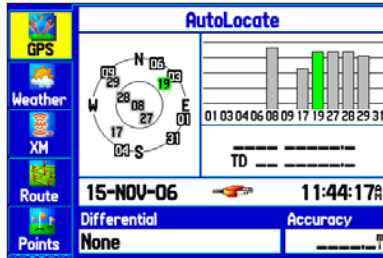

Main Menu

To select a tab from the Main Menu:

1. From any page, press **MENU** twice to open the Main Menu.
2. Press up or down on the **ROCKER** to highlight a tab. The information for the highlighted tab automatically appears on the right. To highlight a sub tab, press left or right on the **ROCKER**, and then press up and down to select individual fields.

By default, the Main Menu tabs are shown as icons along the left side of the screen. You can change the Main Menu to show tabs in a text-only format.

To view the Main Menu icons in text-only format:

1. Highlight the **Display** tab, and press **ENTER**.
2. Select the **Main Menu** field. Press **ENTER**.
3. Highlight **Text Only**, and press **ENTER**.

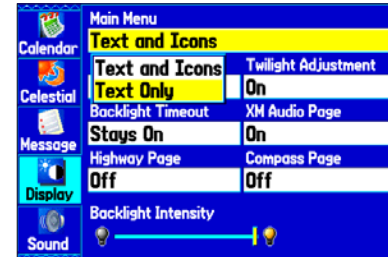

Display Tab

Using Simulator Mode

Simulator Mode is great for practicing with the unit if you are indoors or when satellite signals are not available. All waypoints and routes created in Simulator Mode are retained in memory for future use.

By unplugging the GXM 30 antenna and placing the unit in Simulator Mode, you can view simulated weather information.



NOTE: Do not try to navigate using Simulator Mode. When the unit is set to Simulator Mode, the GPS receiver is turned off. Any satellite signal strength bars shown are only simulations and do not represent the strength of actual satellite signals.

To turn on Simulator Mode:

1. Highlight the **GPS** tab on the Main Menu.
2. Press **MENU** to open the GPS tab options menu.
3. Highlight **Start Simulator**, and press **ENTER**.

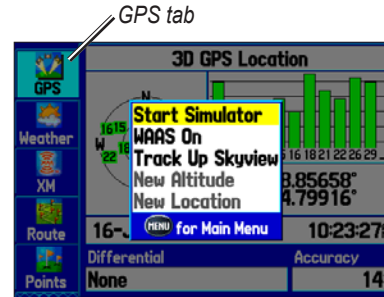

Starting Simulator Mode from the GPS tab

Entering a New Location

Use the GPS options menu to enter a new location from which to simulate.

To enter a New Location using the map:

1. Highlight the **GPS** tab on the Main Menu.
2. Press **MENU** to open the options menu.
3. Highlight **New Location**, and press **ENTER**.
4. Highlight **Use Map**, and press **ENTER**.
5. Use the **ROCKER** to move the panning arrow to the location you want on the map, and press **ENTER**.

MARINE MODE

This section explains some of the more common operations you will perform with your GPSMAP 378/478.

To switch usage modes:

1. Press and hold the **PAGE/MODE** key. The Usage Mode Menu appears.
2. Use the **ROCKER** to select either **Automotive** or **Marine**, and press **ENTER**.

Marine Mode Pages

Marine Mode has five main pages: Map, Compass, Highway, Active Route, and Position Data. An optional XM Audio Page can be enabled. An optional Sonar Page is available when a GSD 21 is connected. See the “[Setting Up and Using Sonar](#)” section beginning on [page 103](#) for more information.



Map Page

Compass Page

Highway Page

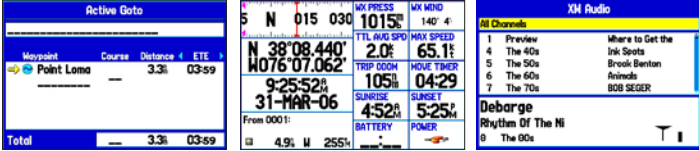

Active Route Page

Position Data Page

XM Audio Page (Optional)

Navigating to a Destination

You can navigate to your destination using the Map Page. As you travel, you see a magenta line that always runs from your current location to the destination or to the next turn on the Map Page. You can use the Map Page, Compass Page, Highway Page, and Position Data Page to help navigate.

You can navigate to a destination using one of the following methods:

- Select a point on the map and press **NAV**.
- Press **NAV** to start a new route using the Find Menu or start a saved route or track.
- Press the **FIND** key to search for a particular item and create a route to it.

Marine Mode and Automotive Mode are similar. Most of the features discussed here also apply to Automotive Mode.

Navigate Options Menu

Press **NAV** to open the Navigate Menu.

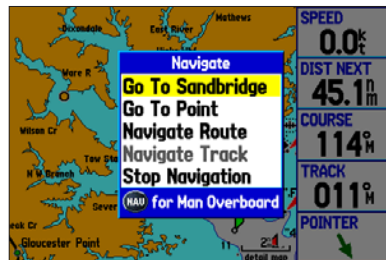

Navigate Menu in Marine Mode

Go To Point—allows you to select a waypoint or point of interest from the Find Menu to which to navigate.

Navigate Route—allows you to select a route to navigate. You can also start a saved route through the Routes tab on the Main Menu. For information about routes, see [page 20](#).

Navigate Track (TracBack)—allows you to select a saved track to navigate. You can also start a saved track through the Track tab of the Main Menu. For information about tracks, see [page 34](#).

MOB (Man OverBoard)—creates a MOB waypoint and navigates to that location. For more information about MOB, see [page 16](#).

To navigate (Go To) a point on the map:

1. On the Map Page, highlight a point to navigate to, and press **NAV**.
2. Highlight **Go To <point name>**, and press **ENTER**.

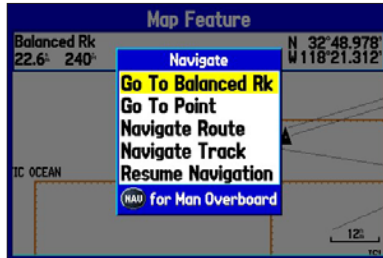

Navigate Menu

3. Follow the magenta route created on the Map Page.

To stop navigation:

1. While navigating to a point, press **NAV**.
2. Highlight **Stop Navigation**, and press **ENTER**.
3. Highlight **Resume Navigation**, and press **ENTER** to resume navigation.

To start a new route using the Find Menu:

1. Press the **NAV** key to open the Navigate Menu.
2. Highlight **Go To Point** (or **New Route** when in Automotive Mode) and press **ENTER** to open the Find Menu.
3. From the Find Menu, highlight **Waypoints** and press **ENTER**.
4. Select a waypoint from the list, and press **ENTER** to open the Waypoint Review Page.

Waypoint Review		
Name	Category	
ANCHOR	Unfiled	
Comment		
31-MAR-06 16:50		
Elevation	Depth	Temperature
115'	43.4'	60.7'
Location		Modified
N 36°53.183'		31-MAY-05
W 075°58.802'		4:52:12
Delete	Show Map	Go To

Waypoint Review Page

5. With the **Go To** button highlighted, press **ENTER** to begin navigation.

To search for an item and route to it:

1. Press **FIND** to open the Find Menu.
2. Highlight a category, and press **ENTER**.
3. Press **ENTER** and press the **ROCKER** up or down to enter letters contained in the item name. Press **ENTER** when finished.

Food & Drink - From Current Location		
Containing A		
El Embarcadero Restaurant	016M	6.1M
A J's American Grill	016M	6.1M
Blue Wave Bar & Grill	017M	6.5M
Bay Club Hotel	018M	6.6M
Humphrey's By the Bay	018M	6.7M
La Scala Italian Restaurant	014M	6.7M
Old Venice Italian Restaurant	014M	6.7M
Grandstand Pizza	013M	6.8M
Con Pane Rustic Breads & C	013M	6.8M

Finding an item using the Containing field: The unit searches for items containing the letter combination you enter and shows them in the list.

4. Highlight the item from the list, and press **ENTER**.
5. Press **ENTER** when the **Go To** button is highlighted.

For complete information about finding an item, see the “[Finding an Item](#)” section.

Man OverBoard (MOB)

Use the MOB function to simultaneously mark your current location and create a direct route back to that location for quick response to emergency situations.

To start the MOB function:

1. Press and hold the **NAV/MOB** key, or press the **NAV/MOB** key twice.



2. Press **ENTER** to confirm and begin navigating to the MOB location.

When a MOB is activated, a MOB waypoint with an international MOB symbol is created, and the unit begins actively navigating to that point. Use any of the navigation pages to guide you back to the MOB point. The MOB waypoint is stored in the waypoint list and can be deleted like any other waypoint.

Finding an Item

Use the Find Menu to easily search for addresses, food & drink, fuel services, lodging, banks/ATMs, cities, shopping, stored waypoints and points of interest (POIs). To open the Find Menu, press the **FIND** key.

The Find Menu is comprised of several default categories: Waypoints, Cities, Exits, Transportation, Tide Stations, and Weather Data. Additional categories appear depending on the optional BlueChart g2 or MapSource data card in the unit.



Find Menu

Follow the directions on [page 15](#) to navigate a new route using the Find Menu.

Using the Find From Feature

You can use the Find Menu to center your search around an item you just found. For example, you search for Restricted Areas and the search shows an “Anchoring Prohibited” search result. If you press **FIND** again, you will see “From Anchoring Prohibited” as the new search from point. You can also use the Find feature to center your search from any waypoint, route list entry, map item, or tide station.

To find an item from another location on the map:

1. Open the Map Page. Use the **ROCKER** to pan the arrow (pointer) to the location you want, and press **FIND**. The Find Menu opens, showing “From Map Pointer.” The list of items is sorted to show items nearest the selected location.
2. Highlight a category from the list, and press **ENTER**.
3. Highlight an item from the list, and press **ENTER**. The item’s Information Page automatically opens, allowing you to save the item as a waypoint, show the item on the map, or automatically create a route to (Go To) the item.

To find an item from another location:

1. From any page, press **FIND**.
2. Highlight a category from the list, and press **ENTER**.
3. Press **MENU** to open the options menu.

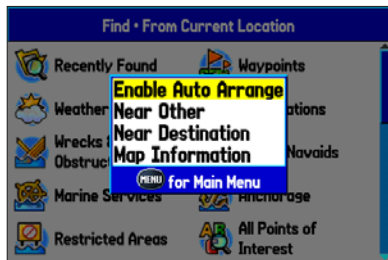
**Find From Options Menu**

4. Highlight **Near Other** and press **ENTER**. If you are actively following a route, you can also choose one of the other options listed in the Find From list.
5. Select a reference location on the map, and press **ENTER**. The list shows items nearest to the new map location.

To find an item near another item:

1. Press **FIND**. The Find Menu opens.
2. Highlight the item you want to “Find From.”
3. Press **FIND**. The Find Menu opens again with items near the previously-selected item. Search for the item you want.

Viewing Recently Found Items

The Recently Found Page shows a list of the items you have searched for or gone to recently.

To view recently found items:

1. Press **FIND** to open the Find Menu.
2. Highlight **Recently Found**, and press **ENTER** to open the list of recently found items.
3. Press **MENU** to show the options menu.
4. Select **Show Find History** to view the list of items you have searched for recently.
5. Highlight **Remove Point**, and press **ENTER** to delete the selected recently found point.

Viewing the Information Page

Each item on the map and each item listed in the results list has an information page.

To view details about an item:

1. Highlight a point on the map or in the search results list, and press **ENTER**.

An information page appears with details about the item, in a tabbed format. Depending on the type of item, additional options are available for viewing the item on the map, viewing a tide chart, viewing the list of maps on your data card, and viewing the next item in the search results list.

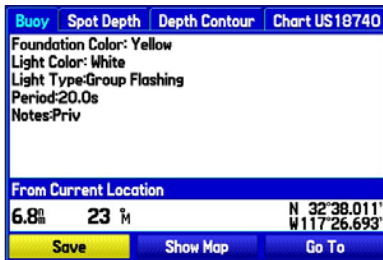

Map Feature Information Page

2. Press **PAGE** or **QUIT** to exit the information page. You can also highlight one of the on-screen buttons, and press **ENTER**.

Find Menu Options

To view additional Find Menu options, press **FIND**, and then press **MENU**. The following options are available:

- **Enable Auto Arrange**—automatically arranges the Find Menu. When selected, **Disable Auto Arrange** and **Restore Default** options are available.
- **Near Other**—select a new location from which to compile the Find items lists. Using the **ROCKER**, move the map arrow to the location you want, and press **ENTER**.
- **Map Information**—shows information about the detailed map data stored on the data card and allows you to select which maps appear on the Map Page.

Additional selections are included in the options menu when you are navigating:

- **Near Next**—compiles the Find items lists based on the next turn in the route.
- **Near Destination**—compiles the Find items lists based on the route destination.
- **Near Current Route**—compiles the Find items lists based on the active route.

Creating and Using Routes

The GPSMAP 378/478 allows you to create and store up to 50 reversible routes, with up to 300 points each.

Creating a New Route

Use the Route tab to create a route by selecting waypoints from the Find Menu, or by selecting waypoints or map items from the Map Page.

To create a route using the Find Menu:

1. Highlight the **Route** tab on the Main Menu.

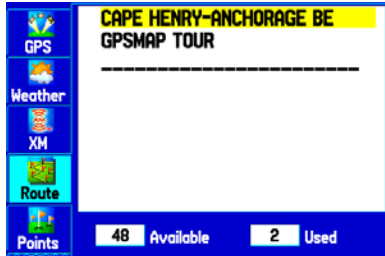

Route Tab with the Route List

2. Press **MENU** to open the Route options menu.
3. Highlight **New Route**, and press **ENTER**.
4. Press **ENTER** to find items to add to the route.

5. Highlight **OK**, and press **ENTER** to add a route point.
6. Repeat step 5 to define additional route points.

To create a route using the map:

1. Highlight the **Route** tab on the Main Menu.
2. Press **MENU** to open the Route options menu.
3. Highlight **New Route**, and press **ENTER**.
4. Press **MENU** to open the options menu.
5. Highlight **Edit on Map**, and press **ENTER**.
6. Highlight a location on the map, and press **ENTER**.
7. Repeat step 5 to define additional route points



NOTE: If you select an area of the map that is not a feature or waypoint, a new waypoint is created for that location. Press **ENTER** on the New Waypoint Page to save the location as a waypoint and continue adding points to your route. You can edit the properties of this waypoint as you can with any waypoint.

Navigating a Saved Route

Use the Navigate Route option to select and navigate a saved route.

To navigate a saved route:

1. Press the **NAV** key.
2. Highlight **Navigate Route**, and press **ENTER**.
3. Highlight a route, and press **ENTER**.

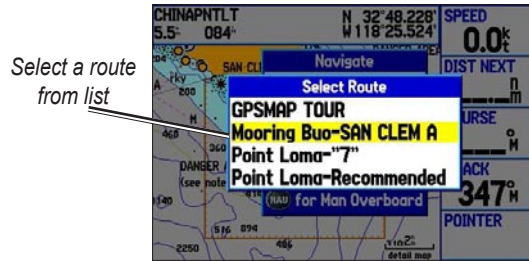

Editing a Route

After you create a route, use the Route Review Page to edit, change the name, and review route points of a selected route.

To change the name of the route:

1. Highlight the **Route** tab on Main Menu.
2. Highlight the name of the route, and press **ENTER**.
3. With the Route Review Page open, highlight the route name field at the top of the page, and press **ENTER**.

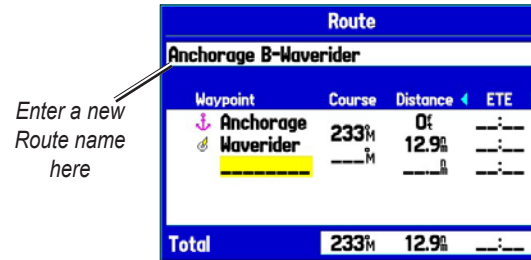

Route Review Page

4. Use the **ROCKER** to enter the route name, and press **ENTER**.

To review individual route points:

1. Highlight the **Route** tab on the Main Menu.
2. From the Route List Page, highlight the name of the route, and press **ENTER**.
3. From the Route Review Page, highlight a point, and press **ENTER**.
4. On the Point Review Page, choose **Next** (highlight the next point on the route list), **Show Map** (show the point on a map window), or **Save** (save the point as a waypoint), and press **ENTER**. If the route point is a user waypoint, you can edit any of the waypoint properties on the Waypoint Page (see the “[Creating and Using Waypoints](#)” section beginning on [page 24](#) for details).

When you return to the Route Review Page, the next point in the route is automatically highlighted. You can review each point on the route by pressing **ENTER** repeatedly.

To add points to the route:

1. Highlight the **Route** tab on the Main Menu.
2. Select a route, and press **ENTER**.
3. Highlight the spot in the route that you want to add the new point. (The new point is added before the highlighted route point).
4. Press **MENU**.
5. Highlight **Insert Waypoint**, and press **ENTER**. The Find Menu opens for you to search for and select the point you want to add to the route.

Route			
Anchorage B-Waverider			
Waypoint	Course	Distance	ETE
⚓ Anchorage	233M	0f	---
🚤 Waverider	---	12.9h	---
Total	233M	12.9h	---

Route Review Page

6. In the Point Review Page, highlight **OK**, and press **ENTER** to add the new point to the route.

To edit the route on the map:

1. Highlight the **Route** tab on the Main Menu.
2. Select a route, and press **ENTER**. Press **MENU** to open the Route Review Page options menu.
3. Highlight **Edit on Map**, and press **ENTER**.
4. Select a location on the route (the route turns red when the arrow is over the route), and press **ENTER**.
5. Use the **ROCKER** to drag the route to the new point location, and press **ENTER**.

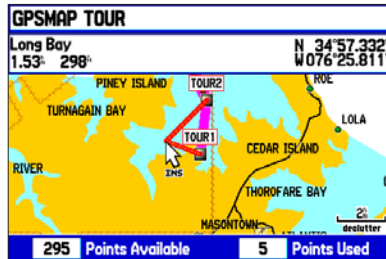
*Editing the route on the map*

6. If the New Waypoint Page opens, edit the waypoint as needed, highlight **OK**, and press **ENTER**.
7. Repeat steps 4 through 6 until all points are added to the route. Press **QUIT** when finished.

You can enter information about your trip so the GPSMAP 378/478 can estimate information about your trip.

GPSMAP 378/478 Owner's Manual

To plan your route:

1. Open the Route Review Page options menu.
2. Highlight **Plan Route**, and press **ENTER**.

*Entering Speed and Fuel Flow for trip planning*

3. Enter the data for Speed and Fuel Flow. You also can enter the date and time of your departure. Press **QUIT** to return to the Route Review Page.



NOTE: Fuel flow rates are measured in “units per hour.” System setting changes for units of measure (statute, nautical or metric) do not affect the fuel flow measure. You should enter fuel flow rates based on information for your vehicle/vessel (such as the operator’s manual or performance specifications), and make note of the units of measure (gallons or liters).

Manually Transitioning to the Next Waypoint

From the Route tab option menu, highlight **Set Up Routes**, and press **ENTER** to set the route leg transition (or waypoint transition). Select **Distance** to enter a radius so that when you are within the entered distance, the GPSMAP 378/478 leads you to the next point on your route.

When you select **Manual**, you can transition to the next waypoint anytime while navigating a route. While you are navigating the route, open the Active Route Page, and press **MENU**. Highlight **Next Route Waypoint**, and press **ENTER** to have the GPSMAP 378/478 start routing you to the next point in your route.

Creating and Using Waypoints

Waypoints are locations or landmarks you record and store in your GPS. They are locations you might want to return to later, such as checkpoints on a route or significant ground features. You can add waypoints to routes and even create a Go To directly to the selected waypoint.

The GPSMAP 378/478 stores up to 3,000 alphanumeric waypoints with a user-defined icon, comment, elevation, depth, and temperature available for each waypoint. You can create waypoints using three basic methods:

- **ENTER/MARK**—allows you to quickly mark your present location.
- **Graphically**—allows you to define a new waypoint location from the map display using the **ROCKER**.
- **Text Entry**—allows you to enter a new waypoint's location coordinates manually.

Marking Your Present Location

Use the **ENTER/MARK** key to capture your present location to create a new waypoint. You must have a valid position (2D or 3D) fix to mark your present location.

To mark your present location:

1. Press and hold the **ENTER/MARK** key until the New Waypoint Page opens, then release it. A default four-digit name and symbol are assigned for the new waypoint.

New Waypoint		
Name	Category	
0002	Unfiled	
Comment		
20-MAR-06 13:19		
Elevation	Depth	Temperature
1206'		
Location		Modified
N 38°51.394' W 094°47.949'		20-MAR-06 1:19:45'
Delete	Show Map	OK

New Waypoint Page

2. To accept the waypoint with the default information, highlight **OK**, and press **ENTER**.

To change any information on the New Waypoint Page, highlight the appropriate field, and press **ENTER**. After entering and confirming your changes, highlight **OK**, and press **ENTER**.

Creating Waypoints Using the Map

You can quickly create a waypoint using the Map Page. When you pan the map and move the arrow over a map item, you see a highlighted description of that item. The GPSMAP 378/478 uses the map item text shown on the map as the default name and symbol for the new waypoint.

To create a new waypoint using the Map Page:

1. Use the **ROCKER** to move the arrow to the map location or map feature you want.
2. Press and quickly release **ENTER/MARK** to capture the location of the arrow. Pressing and holding **ENTER/MARK** marks your current location, not the arrow's location.

If you have highlighted a map feature, an information page opens after you press **ENTER**. Highlight **Save**, and press **ENTER** to save the item as a waypoint. The New Map Waypoint Page opens.

3. To accept the waypoint with the default information, highlight **OK**, and press **ENTER**.

To change any information on the New Map Waypoint Page, highlight the appropriate field, and press **ENTER**. After entering your changes, highlight **OK**, and press **ENTER**.

Creating a Waypoint by Entering Coordinates

You can manually enter location coordinates to create a waypoint. This method is useful for creating a waypoint at a specific latitude/longitude position from a chart.

To create a new waypoint by entering location coordinates:

1. Press **ENTER/MARK** to create a waypoint. The new waypoint is created with the next available waypoint number and the receiver's last known location as the default location.
2. On the New Map Waypoint Page, highlight the **Location** field, and press **ENTER**.

New Waypoint		
Name	Category	
0001	Unfiled	
Comment		
08-MAR-06 10:56		
Elevation	Depth	Temperature
f	f	f
Location		Modified
N 32°23.148' W 117°14.693'		20-MAR-06 1:19:45
Delete	Show Map	OK

3. Use the **ROCKER** to enter location coordinates, and press **ENTER** when finished.

To change any of the other information on the New Map Waypoint Page, highlight the appropriate field, and press **ENTER**. After entering your changes, highlight **OK**, and press **ENTER**.

Reviewing a Waypoint

After you create and store a waypoint, you can modify, review, rename, move, or delete it at any time using the Waypoint Review and Waypoint Edit Pages.

To access the Waypoint Review Page:

Highlight a waypoint on the Map Page, and then press **ENTER** to open the Waypoint Review Page. If the waypoint is located on a map feature or MapSource or BlueChart g2 feature, the Waypoint Review Page might include additional tabs containing information about other features at that location.

Waypoint	Land, Non-Urban	Chart
	GMGJ32	
Name	Category	
0001	Unfiled	
Comment		
15-MAR-06 14:29		
Elevation	Depth	Temperature
994f	31.1f	59.8f
Location		Modified
N 38°10.575' W 076°01.434'		15-MAR-06 2:29:35
Delete	Show Map	Go To

Waypoint Review Page

To access the Waypoint Edit Page:

1. Highlight the **Points** tab on the Main Menu, and then select a waypoint from the list.

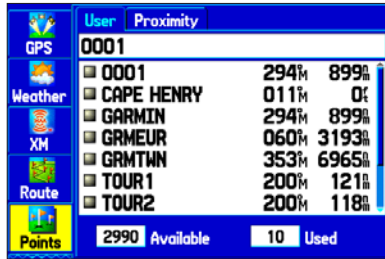

Points Tab

2. Press **ENTER** to open the Waypoint Edit Page.



NOTE: If the waypoint is located on a map feature or MapSource or BlueChart g2 feature, the Waypoint Edit Page will not show the details of the other map features.

Adding a Waypoint to a Route

Use the **Append to Route** option to add the selected waypoint to the end of a route. This option is available only when you are not navigating. When you are navigating to a destination, **Add to Current Route** opens. The selected waypoint is added to the current route before the route destination.

To add a waypoint to the end of the route:

1. Open the Waypoint Edit Page, and press **MENU**.

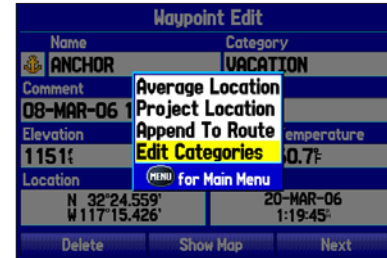

Waypoint Options Menu

2. Select **Append To Route**, and press **ENTER**. The Select Route window opens.

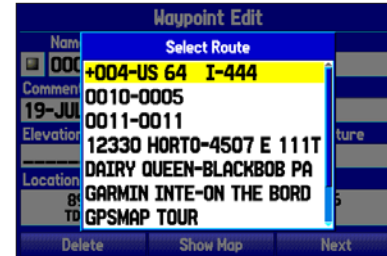

3. Highlight a route or select **New Route**, and press **ENTER**.
4. Highlight **OK**, and press **ENTER** to save the waypoint.

Averaging the Waypoint's Location

Average Location makes the unit take several sample location measurements for the waypoint and recalculate for a more accurate location reading.



NOTE: You must have a GPS satellite fix before you can average a waypoint's location.

To calculate the average location:

1. Open the Waypoint Page, and press **MENU**.
2. Select **Average Location**, and press **ENTER**. The Average Location window opens. The fields change as the unit calculates the average location of the waypoint.

Average Location	
Name	Location
ANC	N 38°51.336'
Commen	W 094°47.933'
08-MAR-0	Estimated Accuracy
Elevation	16.4
1151'	Elevation
Location	Depth
N	1119'
W	Measurement Count
De	18
	Save

Average Location Page

3. Press **ENTER** to save the location.

Projecting a Waypoint

You can create a new waypoint by projecting the distance and bearing from a specific location to a new location.

To create a new waypoint by projecting its location:

1. Create a waypoint. The new waypoint uses the next available waypoint number and the receiver's last known location as the default location.
2. Use the **ROCKER** to highlight **Points** from the vertical list of tabs and select a waypoint. Press **ENTER**.
3. Press **MENU** to open the New Waypoint Page options menu.
4. Highlight **Project Location**, and press **ENTER**.

Waypoint Edit	
Name	Project Location
ANCHOR	From
Comment	Current Location
08-MAR-0	Distance
Elevation	10.27
1151'	Bearing
Location	124
N 32'	Save
W 117'	
Delete	Show Map
	Next

Project Location Menu

5. To change the location from which you are projecting the new waypoint, highlight the **From** field, and press **ENTER**.

- Select the point that you will project your new waypoint from, just as you would select a waypoint or point of interest. For more information see the “[Finding an Item](#)” section on [page 17](#).
- To adjust the distance that the new waypoint will be projected beyond the original waypoint, highlight the **Distance** field, and press **ENTER**. Enter the projection distance, and press **ENTER**.

To adjust the bearing that the new waypoint will be projected from the original waypoint, highlight the **Bearing** field, and press **ENTER**. Enter the bearing, and press **ENTER**.

- When you have adjusted all elements of the projected location, highlight **Save**, and press **ENTER**.
- Make any other changes to the new waypoint data (such as the name or symbol); highlight **OK**, and press **ENTER**.

Editing a Waypoint

The User sub tab shows a master list of all waypoints stored in memory. From the User list, you can review, edit, rename, or delete individual waypoints or delete all user waypoints.

The number of stored and available waypoints is shown at the bottom of the User sub tab. Stored waypoints are arranged in alphanumeric order.

User	Proximity		
0001			
0001	294M	899M	
CAPE HENRY	011M	0M	
GARMIN	294M	899M	
GRMEUR	060M	3193M	
GRMTWN	353M	6965M	
TOUR1	200M	121M	
TOUR2	200M	118M	

2990 Available 10 Used

User Points Tab

To navigate (Go To) a waypoint from the Points tab:

- Select the **Points** tab on the Main Menu, and then highlight the **User** sub tab.
- Highlight the waypoint you want in the list.
- Press **NAV** to open the Navigate Menu. Highlight **Go To <Point Name>**, and press **ENTER**.

To edit the waypoint:

- Open the Waypoint Review Page or Waypoint Edit Page.
- Highlight the waypoint name, symbol, or field you want to change, and press **ENTER**.
- Use the **ROCKER** to select a symbol or enter data, and press **ENTER** when finished.

Waypoint Edit		
Name	Category	
ANCHOR	VACATION	
Comment		
08-MAR-06 10:41		
Elevation	Depth	Temperature
1151'	43.4'	60.7°
Location		Modified
N 32°24.559'		20-MAR-06
W 117°15.426'		1:19:45
Delete	Show Map	Next

Waypoint Page

To edit the next waypoint in the list:

1. Highlight **Next**, and press **ENTER**. The Waypoint list appears with the next waypoint highlighted.
2. Press **ENTER** to edit that waypoint.

Organizing Waypoints into Categories

You can organize your waypoints into categories, to help manage your waypoints. For example, you can create a Vacation category that stores all of the waypoints you will use for your vacation.

When the vacation is over, you can delete all the waypoints in that category. You can create up to 15 categories.

To create a waypoint category:

1. From any of the waypoint pages or the **Points** tab, press **MENU** to open the options menu.
2. Select **Edit Categories**, and press **ENTER**.
3. Highlight **Add**, and press **ENTER**.

Entering a new category

4. Use the **ROCKER** to enter a name for the category.
5. Highlight **Save**, and press **ENTER**.

To assign a category to a waypoint:

1. Open the Waypoint Edit Page. (You can also change the category on the New Waypoint Page.)
2. Select the **Category** field, and press **ENTER**.
3. Select the category to which you want to assign the waypoint, and press **ENTER**.



Select the category to which you want to assign this waypoint.

Waypoint Page

To delete a category:

1. With the Waypoint Categories window open, highlight the category you want to delete, and press **MENU**.

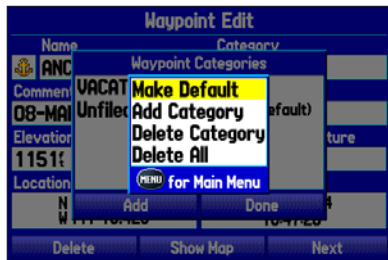

Waypoint Categories Options Menu

2. Select **Delete Category**, and press **ENTER**.
3. Press **ENTER** again to finish deleting the category.

Deleting Waypoints

You can delete waypoints from the waypoint list on the Points tab or from the Waypoint Page. To delete a waypoint from the Waypoint Page, use the **ROCKER** to highlight the on-screen **Delete** button, and press **ENTER**.



NOTE: When a waypoint is deleted from the list, it cannot be recovered from the unit. Backup important waypoints to a computer using the optional PC cable and interface software, such as MapSource, or write them down by hand.

To delete a waypoint from the User Points tab:

1. From the **Points** tab, highlight the waypoint you want to delete.
2. Press **MENU**, highlight **Delete Waypoint**, and press **ENTER**. A confirmation message appears.



3. Press **ENTER** to confirm.

To delete waypoints by symbol or category:

1. On the User sub tab, highlight the waypoint to delete, and press **MENU**.
2. Highlight **Delete by Symbol** or **Delete by Category**, and press **ENTER**.
3. When deleting by symbol, highlight the symbol of the waypoint you want to delete, and press **ENTER**. When deleting by category, select the category you want to delete from the list, and press **ENTER**.
4. Highlight **OK**, and press **ENTER** to confirm. Choose **Cancel** or press **QUIT** to exit without deleting the waypoint.

To delete waypoints by distance:

1. On the User sub tab, highlight the waypoint to be deleted, and press **MENU**.
2. Highlight **Delete By Distance**, and press **ENTER**.
3. Select **Less Than** or **More Than** and enter the distance using the **ROCKER**.
4. You can select a waypoint or point of interest as the **From** location. Highlight the **From** field and press **ENTER**. From the Find Menu, select a location and press **ENTER**. When **OK** is highlighted, press **ENTER**.
5. Highlight **Delete** and press **ENTER** to delete all waypoints within the set location. Choose **Cancel** or press **QUIT** to exit without deleting the waypoints.

Proximity Points

Use the Proximity Points tab to define an alarm circle around a stored waypoint location. The alarm circle can help you avoid reefs, rocks, or restricted waters. Up to 100 waypoints can be listed with a maximum alarm radius of 99.99 nautical miles, statute miles, or kilometers.

If a proximity alarm circle overlaps an existing alarm circle, a “Proximity Overlaps Another Proximity Waypoint” message appears. Because the unit only alerts for one of the overlap points, use caution when navigating in these areas. If you enter an alarm circle overlap, you are only alerted to the closest proximity waypoint.

To turn proximity alarms on or off:

1. Highlight the **Points** tab on the Main Menu, and then select the **Proximity** sub tab.

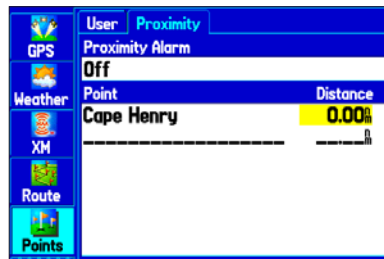

2. Highlight the field below **Proximity Alarm**, and press **ENTER**.
3. Select the **On** or **Off** setting, and press **ENTER**.

To add a proximity waypoint:

1. From the Proximity Points tab, use the **ROCKER** to highlight an empty line on the Proximity list, and press **ENTER**. The Find Menu opens.
2. Select a waypoint or point of interest from the Find Menu.
3. With **OK** highlighted, press **ENTER** to select the point.
4. Use the **ROCKER** to enter a distance value (up to 99.99 units), and press **ENTER**.

To clear one or all proximity waypoints from the list:

1. Highlight the **Points** tab on the Main Menu, and then select the **Proximity** sub tab.
2. Highlight the proximity waypoint to clear, and press **MENU**.

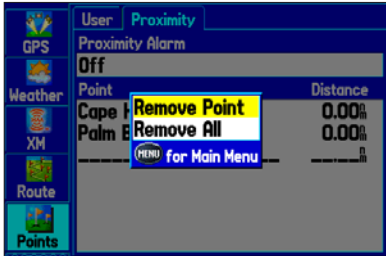

Proximity Points Tab Options Menu

3. To clear a single alarm, highlight **Remove Point**, and press **ENTER**. To clear all proximity waypoints, select **Remove All**, and press **ENTER**.
4. Highlight **OK**, and press **ENTER** to confirm.

Managing Your Tracks

The GPSMAP 378/478 draws an electronic breadcrumb trail or track log on the Map Page as you travel. The track log contains points along its path, including time, and location for each point.

The track log starts recording as soon as the GPSMAP 378/478 gets a location fix. For the best results, clear the track log before you start traveling because when the track log is full, new track points overwrite the oldest track points.

The percentage of memory used by the current track log appears at the top of the Active tab. After the track log is cleared, it shows zero percent. When the track log reaches 100%, the most recent track points start to overwrite the oldest track points (if **Wrap** is selected for **Record Mode**). To avoid losing track points, save the track log when it approaches the 99% mark.

Setting Up and Saving Your Tracks

You must save the track log before you can use the **Navigate Track** feature. The **Save** feature allows you to store up to 15 track logs from certain times and dates.

To access the Track tab:

1. Press **MENU** twice to open the Main Menu.
2. Highlight the **Track** tab.

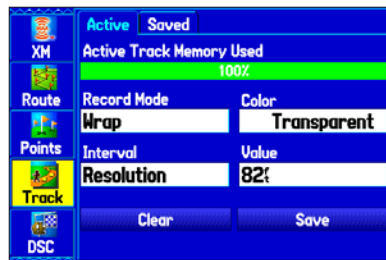

Active Track Tab

Record Mode—**Wrap** records over the oldest tracks when the track log reaches 100%. **Fill** records a track log until the track log is full (100%). When **Off** is selected, the unit does not record tracks.

Interval—**Distance** records track points after a specified distance is traveled. **Time** creates track points after a specified time has elapsed. **Resolution** records track points based on the resolution. The higher the resolution entered, the more points the unit creates to make the track.

Color—select a color for the track when it appears on the map.

Value—records a track according to the **Interval** and **Value**. Enter a specific distance, time, or resolution.

To clear the track log:

1. Highlight the **Track** tab on the Main Menu, then highlight the **Active** sub tab.
2. Highlight the **Clear** button, and press **ENTER**. A confirmation message appears.

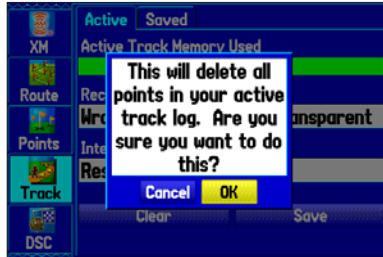

Clearing the Track Log

3. Highlight **OK**, and press **ENTER**.

To save the entire track log:

1. Highlight the **Track** tab on the Main Menu, and then highlight the **Active** sub tab.
2. Select **Save**, and press **ENTER**. A message appears asking if you want to save the entire track.
3. Highlight **Yes**, and press **ENTER**.

To save a portion of the track log:

1. Highlight the **Track** tab on the Main Menu, and then highlight the **Active** sub tab.
2. Select **Save**, and press **ENTER**.
3. Highlight **No**, and press **ENTER** when a message appears.
4. Select a beginning point, and press **ENTER**.

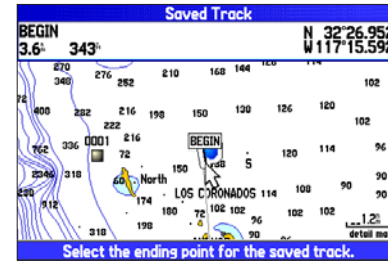

Saving a Portion of the Track Log

5. Select an ending point, and press **ENTER**.
6. Highlight **OK**, and press **ENTER** to save the track.

Saved Tracks

The Saved sub tab lists all of the saved tracks in your unit. Press **MENU** to open the Saved tab options menu.

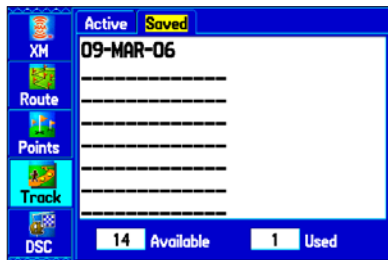

Saved Tab

- **Review on Map**—shows the highlighted track on the Map Page.
- **TracBack**—navigates the track. You can either navigate the track as it is saved, or you can navigate the track in reverse.
- **Delete Track**—erases the highlighted track from the unit's memory.
- **Delete All**—erases all tracks from the unit's memory.

To edit a track:

1. Highlight the **Track** tab on the Main Menu, and then select the **Saved** sub tab.
2. Select a track to edit, and press **ENTER**.

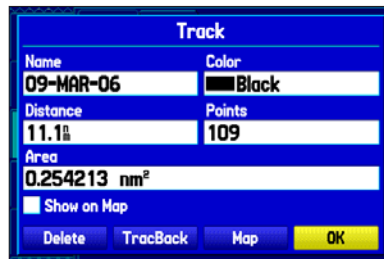

3. Highlight the **Name** field, and press **ENTER**. Use the **ROCKER** to change the name, and press **ENTER**.
4. Select a different display color to show the track on the map.
5. Highlight the box next to **Show on Map**, and press **ENTER**.
6. To begin a TracBack, highlight **TracBack**, and press **ENTER**.
7. To view the track on the map, highlight **Map**, and press **ENTER**. Press **QUIT** to return to the Track tab.
8. Highlight **OK**, and press **ENTER** to save your changes.

Navigating a Saved Track

You can save your track log to use later as a TracBack, which reduces your track log into a route with up to 300 turns. When initiated, a TracBack route leads you back to the oldest stored track log point. It is a good idea to clear the existing track log before you start your current trip. Also, you must save an active track log before you can navigate it as a TracBack.

To start a TracBack using the NAV key:

1. Press **NAV**, highlight **Navigate Track**, and press **ENTER**.
2. Highlight the track you want to navigate, and press **ENTER**.

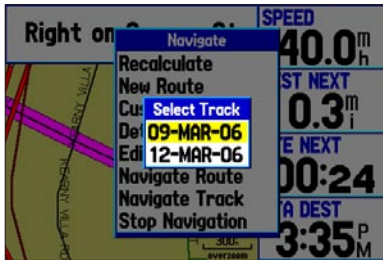

Selecting a Saved Track

3. Select the point you want to navigate to (TracBack to), and press **ENTER**.

TracBack Tips

When a TracBack is initiated, the GPSMAP 378/478 divides the track into segments called legs. Up to 300 temporary turns are created to mark the most significant features of the track in order to duplicate your exact path as closely as possible. To get the most out of the TracBack feature, remember these tips:

- Always clear the track log at the point that which you want to go back (such as a dock or campsite).
- The **Record Mode** option on the Active Track tab must be set to **Fill** or **Wrap**.
- If the track log **Interval** option on the Active tab is set to the **Time** option, the route might not navigate your exact path (keep the interval set to Resolution for best performance).
- If the receiver is turned off or satellite coverage is lost during your trip, TracBack draws a straight line between any point where coverage was lost and where it resumed.
- If the changes in distance and direction of your track are too complex, 300 waypoints might not mark your path accurately. The receiver then uses the most significant points of your track so there will be fewer changes in direction.

MARINE MODE PAGES

Five pages are available in Marine Mode—Map, Compass, Highway, Active Route, and Position Data. An optional XM Audio Page can be enabled. A Sonar Page is available when a GSD 21 Sounder Module is connected.

Map Page

When you turn on the GPSMAP 378/478, the Map Pages appears after the unit acquires a satellite signal. The position marker (▲) shows your current location on the map.

The Map Page shows map information (digital cartography) that includes nav aids, lakes, rivers, coastlines, cities, and highways. Use the dedicated zoom keys (**IN** and **OUT**) to adjust the Map Page scale.

Two map operating modes, Position Mode and Pan Mode, determine what cartography is shown on the map display. Position Mode pans the map to keep your present location in the display area. The position marker (▲) shows your travel on the Map Page. The GPSMAP 378/478 always turns on in Position Mode, with the last known location centered on the map. When you press the **ROCKER**, the GPSMAP 378/478 enters Pan Mode, which moves the map to keep the white arrow (map pointer) within the display area.

The system has built-in BlueChart g2 charts. Optional Garmin data cards and MapSource CD-ROMs enhance the versatility of your GPSMAP 378/478. With optional MapSource information and BlueChart g2 you can view information for outside the US that is not already preloaded.

In Marine Mode, by default, five user-selectable data fields appear on the right side of the screen that can be configured to show any one of the possible data options. You can also add additional data fields to the page or select a full screen map without data fields.

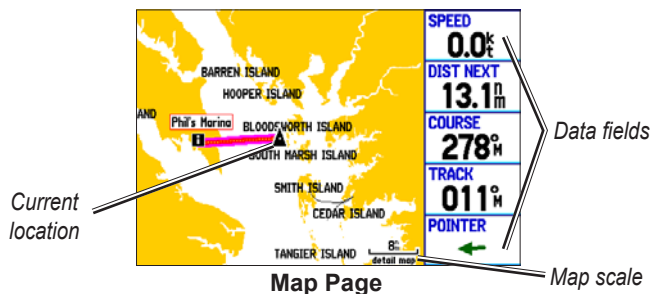

Changing the Page Layout and Data Fields

You can adjust how the following pages appear: Map, Compass, Highway, Position Data, Trip Computer, and optional Sonar Pages. You can also adjust the data fields on each page.

To change the map page layout:

1. Press **MENU** to open the options menu.
2. Highlight **Set Up Page Layout**, and press **ENTER**.

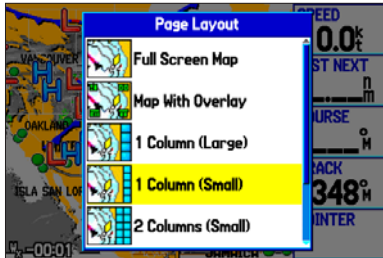

Selecting the Page Layout

3. Select a page layout option, and press **ENTER**.

To change a data field display:

1. Press **MENU** to open the options menu.
2. Highlight **Change Data Fields**, and press **ENTER**.
3. Highlight the data field to change, and press **ENTER**.
4. Highlight the type of data you want to show, and press **ENTER**.

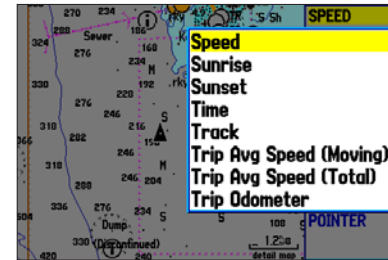

Changing a Data Field

5. Press **QUIT** to exit.

Setting Up the Map Page

Use the Set Up Map option to adjust how items appear on the Map Page.

To change a map setup option:

1. On the Map Page, press **MENU** to open the options menu.
2. Highlight **Set Up Map**, and press **ENTER**.

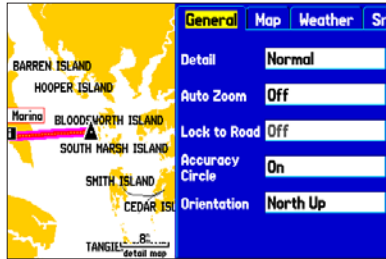

Setting up the Map Page

3. Press left or right on the **ROCKER** to highlight a tab; press up or down on the **ROCKER** to highlight the field you want to change, and press **ENTER**.
4. Highlight a setting, and press **ENTER**.
5. Press **PAGE** or **QUIT** to exit.

Viewing Additional Map Data

Use the Map Information Page to view the data currently loaded on your GPSMAP 378/478 unit and data card.

To review/change map information:

1. On the Map Page, press **MENU**.
2. Highlight **Map Information**, and press **ENTER**. The first page shows the map families stored on the data card and unit and whether they are shown on the Map Page.

Map Family highlighted. Press **ENTER** to view the individual maps in the family.

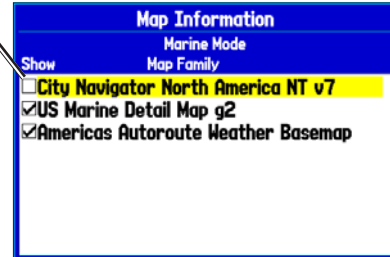

3. To change the setting for a map family, highlight the box next to the map family name, and press **ENTER** to select (check mark) or deselect (no check mark) the **Show** setting.



NOTE: The outline of a check mark will appear if one or more maps have been deselected within that map family.

4. To view the list of maps within a map family, highlight the name of the map family, and press **ENTER**.

5. When using a map loaded to a data card, you can view detailed information about an individual map, highlight the Map Name, and press **ENTER**. Highlight **OK**, and press **ENTER** to exit the Map Information Page.



6. To select/deselect individual maps (data card maps only) to be shown on the Map Page, highlight the box next to the map you want, and press **ENTER** to check/uncheck the **Show** box.
OR
Press **MENU**, select one of the options (**Show All**, **Hide All**, or **Show Defaults**), and press **ENTER**.
7. Press **QUIT** to exit the Map Information Page.

Map Orientation

There are three map orientation options: North Up orients the map like a paper map. Track Up orients the map in the direction of travel. Course Up orients the map so the direction of navigation is always up. When using Track Up or Course Up, the north arrow indicates the orientation. To change the map orientation, press **MENU** to open the Map Page. Press **MENU** again. Select **Set Up Map**, and press **ENTER**.

Zooming In and Out of the Map

The map has 28 available map zoom ranges ranging from 20 ft to 800 nm (20 ft to 800 mi or 5 m to 1200 km). The map zoom range is controlled by the **IN** and **OUT** keys, with the current range shown at the bottom right of the data window.



NOTE: The range value represents the distance from one end of the range bar () to the other.

To select a map zoom range (zoom in and out):

Press the **OUT** key to zoom out; press the **IN** key to zoom in.

Both the GPSMAP 378 and GPSMAP 478 have a built-in worldwide land database. The GPSMAP 378 contains detailed maps of the US inland lakes and the GPSMAP 478 contains built-in BlueChart g2 charts. The GPSMAP 378/478 shows cartography as long as chart information is available for the map zoom range you selected.

Map coverage conforms to the following conditions:

- Cartography is shown when the selected zoom range is covered by either the internal basemap or other MapSource data loaded onto a data card.
- When the selected zoom range is covered by both the internal database and data card map information, the cartography with the best resolution appears.
- When the selected zoom range exceeds the resolution of the data in use, “overzoom” appears below the map scale.





No additional data is available

- When external data (such as MapSource data) is used, “detail map” appears below the map zoom range.



Using external detailed maps

Panning the Map

Use the panning arrow  to pan the map to view other map areas. As you pan past the edge of the current map display, the screen moves to provide continuous map coverage. The position icon  stays in your present location and might not be visible on the screen when you pan the map.

To pan the map:

Press up, down, right, or left on the **ROCKER**. The panning arrow moves the map so you can view different parts of the map.

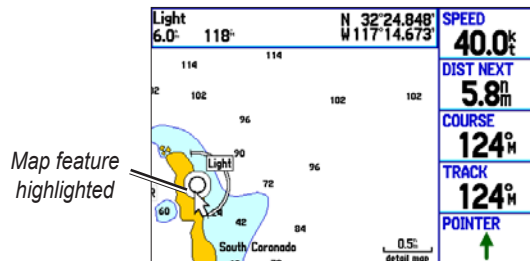

As you move the arrow, the distance and bearing from your present location to the arrow appears in the data window, along with the arrow's position coordinates. When you zoom in Pan Mode, the arrow stays centered on the screen. When the arrow is stationary, fixed coordinates appear in the position field, and the distance and bearing from your present location update as you move.

To re-center your position on the screen:

Press **QUIT**. The map automatically moves to show your present location, and the unit returns to Position Mode.

You can also use the arrow to select on-screen map items, which allows you to review a selected item directly from the map.

To view details about an on-screen point:

1. Use the **ROCKER** to move the arrow to a waypoint or map item. If several items are grouped closely together, zoom in closer for a better view.

When a waypoint or map item is selected, it is highlighted on-screen with the name and location shown at the top of the screen, along with the distance and bearing from your current location.

2. Press **ENTER** to view more information about the point. The information and on-screen buttons shown vary depending on the type of item selected. In some cases, additional information tabs appear at the top of the information page or Waypoint Page.

3. Use the **ROCKER** to highlight the extra tabs and view the information.
4. Select an on-screen button and press **ENTER**. Press **QUIT** to exit the information page.

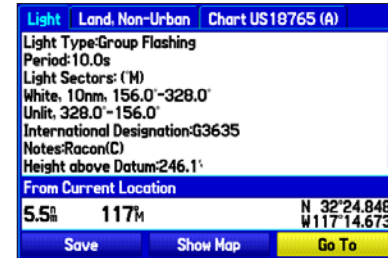

Map Feature Information Page

Clearing Unwanted Details from the Map

You can remove items from the Map Page (declutter the screen) to remove unwanted items:

To declutter the Map Page:

1. On the Map Page, press **MENU** to open the options menu.
2. Highlight **Declutter**, and press **ENTER**.
3. Press **ENTER** again to restore the detail to the map.

Measuring Distance

You can measure the distance and bearing between two map items.

To measure the bearing/distance between two points:

1. On the Map Page, press **MENU** to open the options menu.
2. Highlight **Measure Distance**, and press **ENTER**. An on-screen arrow appears on the map at your present location with **ENT REF** below it.

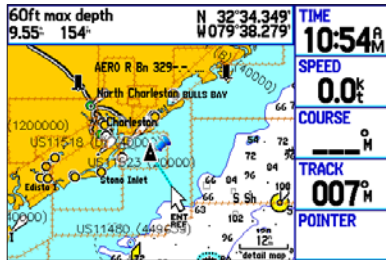

3. Move the arrow to the reference point (the starting point that you want to measure from), and press **ENTER**. A push pin icon marks the starting point.

4. Move the arrow to the point want to measure to. The bearing and distance from the reference point and arrow coordinates appear in the data window at the top of the display.

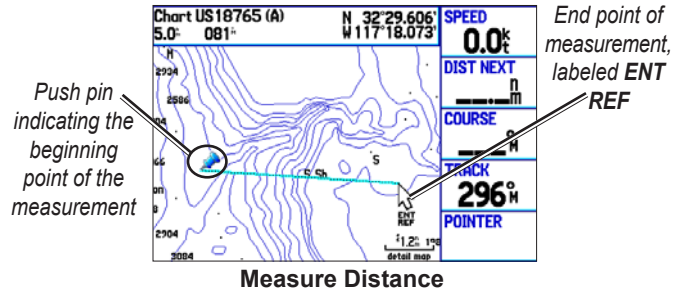

Compass Page

During active navigation, the Compass Page guides you to your destination with a graphic compass and a bearing pointer. When the pointer is pointing straight up, you are heading directly to your destination.

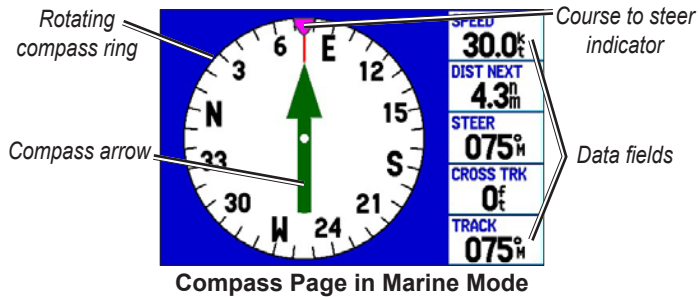

The middle of the page features a rotating compass ring that shows your course over ground (track) while you are moving. Your present course over ground is indicated at the top of the compass ring. The direction of the destination (bearing) relative to the course over ground is indicated by an arrow in the middle of the compass ring, and a course to steer indicator on the outside of the compass ring. The course to steer represents the direction to steer to get back to the course line.

If the arrow points up, you are going directly to the waypoint. If the arrow points any direction other than up, turn toward the arrow until it points up, and then continue in that direction.



NOTE: You must be moving for the compass to accurately update and show your heading.

Turning On the Compass Page

The Compass Page is on by default in Marine Mode but off by default in Automotive Mode.

To show the Compass Page in Automotive Mode:

1. Highlight the **Display** tab on the Main Menu.
2. Highlight the **Compass Page** field, and press **ENTER**.
3. Select **On**, and press **ENTER**.

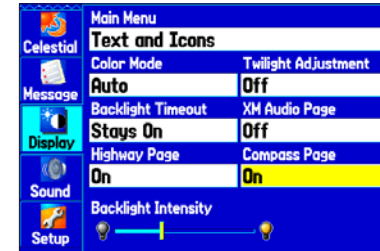

Turning on the Compass Page

Compass Page Options

Use the options menu on the Compass Page to customize the Compass Page. For definitions of data field options, see to [page 132](#).

Press **MENU** to open the Compass Page options menu.

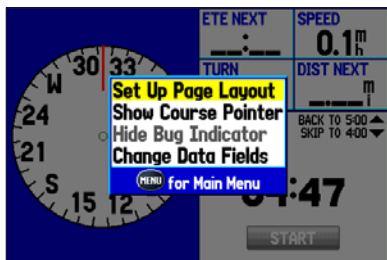

Set Up Page Layout—select the page layout.

Show Course Pointer/Show Compass—toggles between showing the course pointer, which shows how far off you are from your course and how to get back on course, or shows the compass arrow. The course pointer is also referred to as a CDI or course deviation indicator.

Show (Hide) Bug Indicator—shows the course to steer bug indicator (the purple tick mark on the compass ring).

Change Data Fields—changes on-screen data fields.

Using the Marine Timer

The Marine Timer, specifically designed for sail boat racing, allows you to easily count up or down by specified time increments. As is common in sail boat racing, there is often a 5-minute warning countdown, followed by a 4-minute preparation countdown, and finally a 1-minute final countdown. Then during the race, mariners might want to count up to keep track of their time.

You can use your GPSMAP 378/478 to perform each of these different countdowns.

To open the Marine Timer:

1. Press **MENU** on the Compass Page.
2. Highlight **Set Up Page Layout**, and press **ENTER**.
3. Highlight **2 Columns With Timer**, and press **ENTER**. The Marine Timer appears in the lower-right corner.

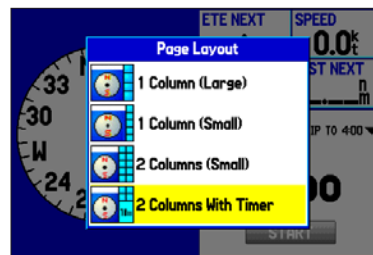

To use the Marine Timer:

1. Press the **ROCKER** up or down to select the time you want to count. Five (5) minutes is the default.
2. Press **ENTER** to start the timer. Use the **ROCKER** during the timing to quickly select a different length of time.
3. Press **ENTER** to stop timing.



Marine Timer on the Compass Page

As discussed previously, the timer is set to count down five minutes. If you want to change the length of time and the behavior of the timer, open the **Timers Setup** tab on the Main Menu.



NOTE: You can set the timer countdown for up to 60 minutes.

To set the Marine Timer:

1. Highlight the **Setup** tab on Main Menu, and then select the **Timers** sub tab.
2. Highlight **Stop** next to **Marine** to change the timer's behavior.

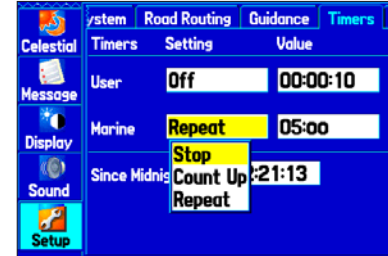

3. Highlight the time field, press **ENTER**, and then use the **ROCKER** to enter a new time.



Highway Page

The Highway Page is available in both Marine Mode and Automotive Mode.

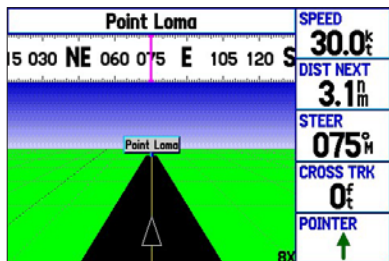

Highway Page

When you are navigating, the Highway Page provides digital and graphic steering guidance to the destination. The right side of the Highway Page features user-selectable data fields showing useful navigation information. A compass ribbon appears at the top of the page to show your current heading, represented by the violet bar. The red vertical bar represents the bearing to your course. To stay on course, steer toward the red vertical indicator (or arrows) until it lines up with the violet bar in the middle. The bottom of the screen provides visual guidance to the waypoint on a graphic highway display. The line down the center of the highway represents your desired track line.

To hide/show the Highway Page:

1. Highlight the **Display** tab on the Main Menu.
2. Highlight the **Highway Page** field, and press **ENTER**.
3. Select **Off** to hide or **On** to show, and press **ENTER**.

Using the Highway Page

To stay on course, steer toward the violet bar (or arrows) until it lines up with the red bar in the middle. The bottom section of the screen provides visual guidance to the waypoint on a graphic highway display. The line down the center of the highway represents your desired track line.

As you head toward your destination, the highway perspective moves to indicate your progress to the waypoint and which direction you should steer to stay on course. If you are navigating a route, the Highway Page shows each route waypoint in sequence connected by a black “road” with a white line down the middle, which is your desired track line. Nearby waypoints not in the active route can also be shown. You can zoom in or out to show a larger or smaller view of the highway.

To change the highway perspective scale:

Press **IN** to zoom in; press **OUT** to zoom out.

Highway Page Options

Use the Highway Page options menu to define the data fields and select which waypoints and tracks appear on the screen. The data fields, located along the right side of the page, provide various types of useful data.

To show and select the Highway Page options:

1. Press **PAGE** repeatedly until the Highway Page appears.
2. Press **MENU**.
3. Highlight an option, and press **ENTER**.

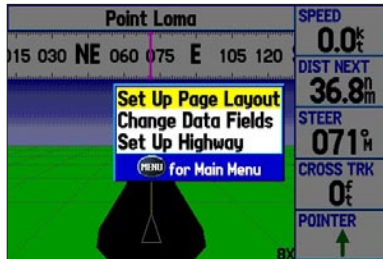

Highway Page Options Menu

The following options are available from the Highway Page options menu:

Set Up Page Layout—select the page layout.

Change Data Fields—change on-screen data fields.

Set Up Highway—shows an options menu with two sub tabs: **Line** and **Waypoint**. Each tab has on/off settings for options, including enabling the line for the Active Leg and Track Log.



Set Up Highway

Active Route Page

When you are navigating a route using your GPSMAP 378/478, the Active Route Page shows each point (waypoint or map item) of the active route, with the point name, course, distance, and several other fields of information. The current destination point, the active point, is marked with an arrow icon. As you navigate a route, the list automatically updates to indicate the next active point. The Active Route and Route Review Pages share many of the same features and options.

Active Route			
Anchorage B-Waverider			
Waypoint	Course	Distance	ETA
Anchor	SW	---	---
0001	S	19.4	10:13A
0002	W	31.9	10:32A
Waverider	---	---	---
Total	SW	31.9	10:32A

Active Route Page

Active Route Page Options

Press MENU to open the Active Route Page options menu.

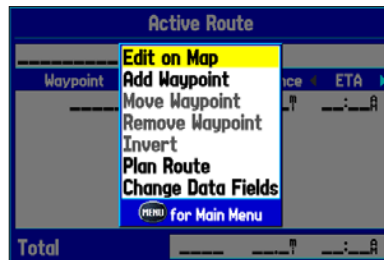

Deactivate—stop route navigation.

Edit on Map—edit the route on the map.

Add Waypoint—insert a point before the highlighted waypoint or add a point to the end of the route.

Remove Waypoint—delete the selected waypoint from the route.

Invert—reverse the order of the route.

Plan Route—enter information about your route to more accurately provide you with arrival times.

Change Data Fields—customize the data fields shown on the Active Route Page.

Position Data Page

The Position Data Page shows important navigation data while navigating a route in Marine Mode. By default, the Position Data Page shows a compass ribbon, your current latitude and longitude, date and time, your location in relation to a prominent nearby landmark such as a waypoint or city, and eight user-selectable data fields. The compass ribbon appears at the top of the page to show your current heading with a red, vertical bar. To stay on course, steer toward the violet bar (or arrows) until it is aligned with the red bar.

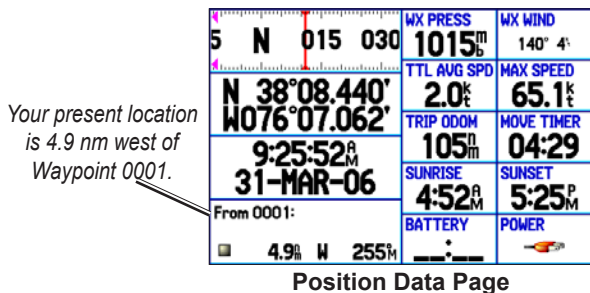

Position Data Page Options

Press **MENU** to open the Position Data Page options menu.



Change Nearest Type—specify the type of item used as the nearest item (shown in the lower-left data field). The choices vary based on the current usage mode.

Reset Trip—clear trip information, except the maximum speed and the odometer.

Reset Max Speed—clear the maximum speed.

Reset Odometer—clear the running total of the distance traveled since the odometer was last reset.

Reset All—clear all trip information including the maximum speed and odometer.

XM Audio Page

Use the XM Audio Page to view and select XM Radio channels. Add or remove channels within the Favorites category, and turn audio on or off.



NOTE: You **MUST** have a GXM 30 antenna connected to your GPSMAP 378/478 and a subscription to XM Radio to use XM Radio features. Additionally, you must use the external speaker with 12/24-Volt adapter, third-party FM modulator, speakers, or have headphones plugged in to hear the audio.

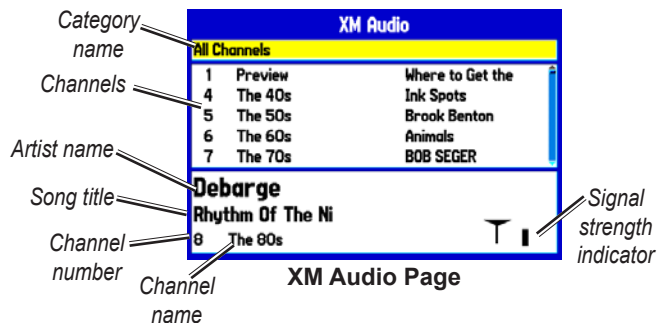

The XM Audio page is available in both Marine Mode and Automotive Mode. The XM tab appears on the Main Menu, even if the XM Audio Page is turned off.

The XM Audio Page is divided into three panes. The first pane contains a list of XM Radio categories into which XM Radio channels are grouped (Classical, Decades, Traffic, and so on). For a complete list of available categories and channels, visit the XM Radio web site at www.xmradio.com. Select All Channels to view a list of all channels in numerical order. You can also view a list of your favorite channels.

The second pane shows a list of channels in the selected category. Each channel has a description and the artist currently playing. You can adjust this setting to show the song title instead of the artist.

The third pane shows the song and artist or program name, the channel number and name, and the strength of the XM Radio signal.

Turning on the XM Audio Page

The XM Audio Page is off by default.

To show the XM Audio Page:

1. Highlight the **Display** tab on the Main Menu.
2. Highlight the **XM Audio Page** field, and press **ENTER**.
3. Select **On**, and press **ENTER**.

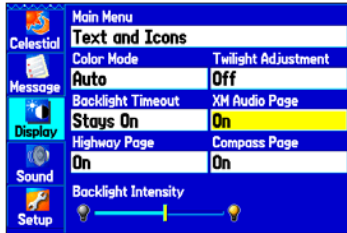

XM Audio Page Field on the Display Tab

To select an XM Radio channel:

1. Press up or down on the **ROCKER** to scroll through the list of channels.
2. Highlight the channel you want, and then press **ENTER**. A triangle (▶) appears to the left of the channel currently playing.

XM Audio Page Options

With the XM Audio Page open, press **MENU** to open the options menu.



XM Audio Page Options Menu

The following options are available on the XM Audio Page options menu:

Add to Favorites—allows you to add channels to the Favorites category.

Scan—enables you to scan all channels, scan by category, or scan favorites. Each channel plays for five seconds before advancing to the next channel in the list.

Display Artist (Display Song) In List—enables you to select whether to show the artist or the song title in the channel list.

Mute (Enable) Audio Output—enables you to turn audio output on or off.

Using Favorites

You can create a customized list of up to 30 of your favorite XM Radio channels.

To add a channel to Favorites:

1. Highlight the Category list, and press **ENTER**.
2. Select a category, and press **ENTER**, or use the **IN** and **OUT** keys.
3. Select a channel.
4. Press **MENU**.
5. Highlight **Add To Favorites**, and press **ENTER**. Repeat steps 1 through 4 to add another channel.



Adding a Channel to Favorites

To view and select Favorites:

1. Highlight the Category list, and press **ENTER**.
2. Select the **Favorites** category, and press **ENTER**.

3. Highlight the channel you want to select from your list of favorites, and press **ENTER**. A triangle appears to the left of the newly selected channel.



Favorites List

To delete a channel from Favorites:

1. In the Favorites category, highlight the channel you want to delete, and press **MENU**.
2. Highlight **Delete Favorite** to delete the selected channel from your favorites list, or highlight **Delete All Favorites** to delete all channels from your Favorites list.
3. Press **ENTER**. A confirmation message appears.
4. Highlight **OK**, and press **ENTER** again to confirm.

Scanning XM Radio Channels

From the XM Audio Page, you can scan all channels, scan channels in a specific category, or scan channels in your Favorites.

To scan XM Radio channels:

1. On the XM Audio Page, press **MENU**.
2. Select **Scan** on the options menu, and press **ENTER**.
3. Select **All Channels** to scan all channels.
OR
Select **Category** to scan only channels in the selected category.
OR
Select **Favorites** to scan only channels in your Favorites list.
4. Press **ENTER**. Each channel is played for five seconds and then advances to the next channel.
5. Press any key to stop scanning and select the current channel.

Turning Audio On or Off

To turn audio on or off:

1. On the **Audio** sub tab, press **MENU**.
2. Highlight **Mute Audio Output** on the options menu to turn the audio off. A music note with a red slash appears in the song pane. Highlight **Enable Audio Output** to resume audio output.

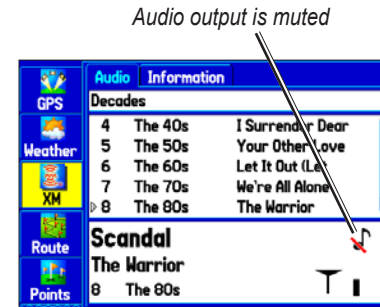

AUTOMOTIVE MODE

This section discusses some of the more common Automotive operations you will perform with your GPSMAP 378/478 in Automotive Mode. Please note that many common operations, such as marking a waypoint and creating a route, are performed the same way as in Marine Mode. See the Marine Mode sections for operations and information not found in this section.

Automotive Mode Pages

Automotive Mode has two main pages (Map and Trip Computer) that are always available. Optional Highway, Compass, and XM Audio Pages can be turned on in Automotive Mode. When you are actively navigating, the Current Route Page is available if you are navigating a turn-by-turn route. The Active Route Page is available if you are navigating off road.

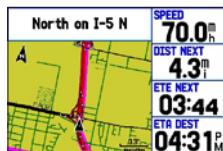

Map Page

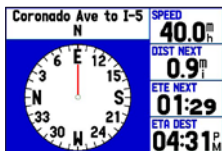

Optional Compass Page (see [page 45](#))



Optional Highway Page (see [page 48](#))

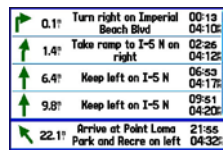

Current Route Page

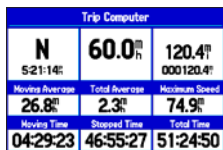

Trip Computer Page

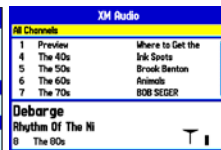

Optional XM Audio Page (see [page 52](#))

Navigating in Automotive Mode

You can navigate to your destination in Automotive Mode using the Map Page. As you travel, your GPSMAP 378/478 guides you to your destination with voice prompts, arrows, and directions along the top of the screen. When you are actively navigating, you see a magenta line that always runs from your current location to the destination or to the next turn on the Map Page. You can use the Map Page, Compass Page or Highway Page to help navigate.

You can navigate to a destination using one of the following methods:

- Select a point on the map, and press the **NAV** key.
- Press the **NAV** key to navigate a new route using the Find Menu, or start a saved route or track.
- Press the **FIND** key to search for a particular item and create a route to it.

Navigate Options Menu

Press **NAV** to open the Navigate Menu.

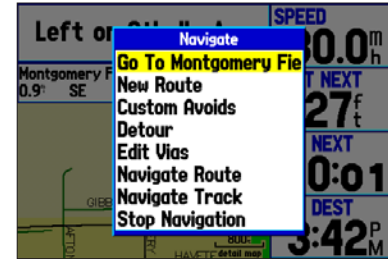

Navigate Menu

Go To Point—select a waypoint or another point from the Find Menu to which to navigate.

New Route—create a new route.

Custom Avoids—set up roads to avoid when navigating.

Detour—create a detour route while navigating.

Edit Vias—add points through which you want to travel when navigating.

Navigate Route—select a route to navigate.

Navigate Track (TracBack)—select a saved track to navigate.

Stop (Resume) Navigation—start or stop navigating.

To navigate (Go To) a point on the map:

1. Highlight a point to navigate to, and press **NAV**.
2. Highlight **Go To <point name>**, and press **ENTER**.
3. Follow the magenta line created on the Map Page.



Stopping and Resuming Navigation

When navigating to a point, you can stop navigation. For example, if you are on a long car trip, but you want to stop for dinner, you can stop navigation and resume after dinner.

To stop navigation:

1. While navigating to a point, press **NAV**.

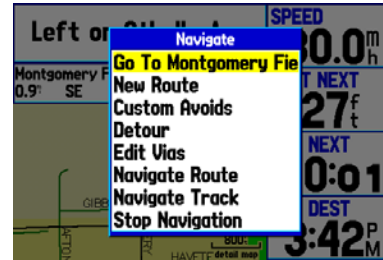

Navigate Menu

2. Highlight **Stop Navigation**, and press **ENTER**.
3. Highlight **Resume Navigation**, and press **ENTER**.

To create a new route:

1. Press **NAV** to open the Navigate Menu.
2. Highlight **New Route**, and press **ENTER**.
3. From the Find Menu, highlight **Waypoints**, and press **ENTER**. (You can also choose to go to other points, such as **Cities** or **Exits** from this list. The steps vary only slightly from those listed for waypoints.)
4. Select a waypoint from the list, and press **ENTER** to open the Waypoint Review Page.

Waypoint Review		
Name	Category	
 STADIUM	Unfiled	
Comment		
13-MAR-06 09:37		
Elevation	Depth	Temperature
1207'		60.0°F
Location		Modified
N 38.85657° W 094.79915°		20-MAR-06 1:19:45
Delete	Show Map	Go To

Waypoint Review Page

Activating a Go To using the Find Menu

5. Highlight the **Go To** button, and press **ENTER** to begin navigation.

To go to a destination using the Find Menu:

1. Press **FIND** to open the Find Menu.
2. Highlight a category, and press **ENTER**.
3. Press **ENTER**, and use the **ROCKER** to begin entering the letters contained in the item name. The list begins to sort by the items which contain the letters you are entering. Press **ENTER** when finished.

Food & Drink - From Current Location		
Containing	A	
 El Embarcadero Restaura	016M	6.1M
 A J's American Grill	016M	6.1M
 Blue Wave Bar & Grill	017M	6.5M
 Bay Club Hotel	018M	6.6M
 Humphrey's By the Bay	018M	6.7M
 La Scala Italian Restaurant	014M	6.7M
 Old Venice Italian Restaura	014M	6.7M
 Grandstand Pizza	013M	6.8M
 Con Pane Rustic Breads & C	013M	6.8M

4. Highlight the item you want from the list, and press **ENTER**.
5. Highlight the **Go To** button, and press **ENTER**.

For complete information about finding an item, see the “[Finding an Item](#)” section on [page 17](#).

Following a Saved Route

Use the Navigate Menu to follow a saved track or route. If you want to follow roads on your route, press **MENU** and select **Follow Roads** on the Active Route Page.

To follow a saved route:

1. Press **NAV** to open the Navigate Menu.
2. Highlight **Navigate Route**, and press **ENTER**.
3. Highlight the route you want to navigate, and press **ENTER**.
4. Press **MENU** to open the options menu.
5. Highlight **Follow Roads**, and press **ENTER** to create a turn-by-turn route (auto-route), which appears on the Current Route Page.

You can also initiate a saved route from the Route tab on the Main Menu.

Editing Your Route

When you are navigating a route, you can edit that route. You can add areas and roads to avoid as well as temporary detours to your current route. You can also add stops along your trip, called Via Points.

While navigating, press **NAV** to open the Navigate Menu.

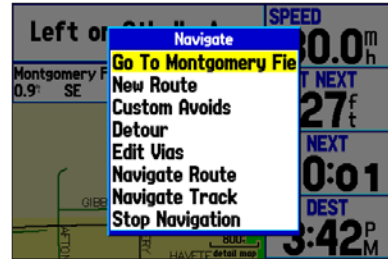

Navigate Menu in Automotive Mode

While navigating a course

Entering Custom Avoids

The Custom Avoids feature allows you to enter specific areas and roads to avoid when navigating. Custom Avoids apply to all routes, but detours apply to only the active route. You can add Custom Avoids while you are navigating a route or before you navigate.

To enter a custom avoid:

1. Press **NAV** while navigating to a destination.
OR
Open the Map Page, and press **MENU**.
2. Select **Custom Avoids**, and press **ENTER**.
3. Press **ENTER** when the **Add Avoid** button is highlighted.
4. Select **Avoid Road** or **Avoid Area**, and press **ENTER**.
5. Use the **ROCKER** to move the arrow to the first point in the avoidance area. Press **ENTER** to select the first point.
6. Move the arrow to the end point, and press **ENTER**. During route calculation and navigation, the GPSMAP 378/478 will avoid the area within the box or the selected area of the road.
7. When finished, highlight the **OK** button, and press **ENTER**.

Creating a Detour

If there is road construction or some other form of a detour while navigating a route, you can have your GPSMAP 378/478 create a detour route for you.

To create a detour:

1. While navigating a course, press **NAV**.
2. Select **Detour** from the Navigate Menu.



3. Select a distance, and press **ENTER**. The GPSMAP 378/478 recalculates your course based on your detour distance.
4. To end the detour manually, press **NAV** again, and select **Cancel Detour**.

Adding and Editing Stops (Via Points)

You can add Via Points—points through which you would like to travel—to your route using the **Edit Vias** option.

To add Via Points to your route:

1. While navigating your route, press **NAV** to open the Navigate Menu.
2. Select **Edit Vias**, and press **ENTER**. The Add/Edit Vias window opens.
3. Highlight **Add Via Point**, and press **ENTER**.



Add/Edit Vias Page

Showing the original route without Via Points

4. From the pop-up window, highlight either **Use Map** or **Use Find Menu**, and press **ENTER**.
5. If you selected **Use Map**, use the **ROCKER** to select an item on the map, and press **ENTER**.
If you selected **Use Find Menu**, select an item from the Find Menu as discussed in the “[Finding an Item](#)” beginning on [page 17](#). Remember you can press **MENU** while the Find Menu is open to find an item near another location, such as the destination. The new point is added to the route as shown on the Add/Edit Vias Page.
6. Repeat steps 3 through 5 until you have added all of the Via Points that you want. Highlight **Done**, and press **ENTER** to apply the new Via Points to the route.

Following an Automotive Route

The GPSMAP 378/478 guides you to your destination using many tools, such as the Map Page and Current Route Page.

Track Your Progress with the Map Page

You can track the progress of your route on the Map Page. Your route is shown with a magenta line. The next turn is shown in the top bar on the Map Page.

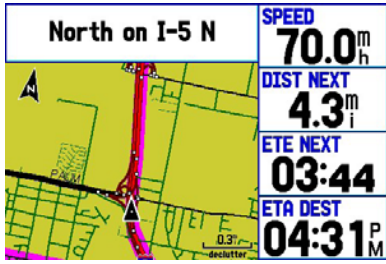

Map Page Displaying Your Route

Watch Your Trip Data

Use the Trip Computer Page to view your trip data. You can track your speed here, as well as other information related to your trip.

See Your Next Turn With the Current Route Page

Whenever you have initiated a turn-by-turn route in the GPSMAP 378/478 set in Automotive Mode, the Current Route Page shows each turn of the active route. For more information see [page 65](#).

0.1 ^m	Turn right on Imperial Beach Blvd	00:13 04:10 ^R
1.4 ^m	Take ramp to I-5 N on right	02:26 04:12 ^R
6.4 ^m	Keep left on I-5 N	06:53 04:17 ^R
9.8 ^m	Keep left on I-5 N	09:51 04:20 ^R
22.1 ^m	Arrive at Point Loma Park and Recre on left	21:55 04:32 ^R

Current Route Page

AUTOMOTIVE MODE PAGES

Automotive Mode has two main pages, Map and Trip Computer, that are always available. Optional Highway and Compass Pages can be turned on in Automotive Mode. When you are actively navigating, the Current Route Page is available if you are navigating a turn-by-turn route. The Active Route page is available if you are navigating off road. For information about pages not discussed here, see the “[Marine Mode Pages](#)” section.

Map Page

In Automotive Mode, by default, four user-selectable data fields appear on the right side of the screen that can be configured to show any one of the possible data options. The top of the screen shows the GPS status or the route leg. You can also add data fields to the page or select a full-screen map without data fields.







Press the zoom keys (**IN** and **OUT**) to change the map zoom range. Some items on the map appear only if the map is zoomed in to a certain level.

- Press **ENTER** to quickly declutter (remove unwanted items) from the Map Page.
- Press **MENU** to open the options menu for the Map Page.
- Show and hide the heading line from the options menu.
- Use the **ROCKER** to measure the distance between two objects on the map.
- Change the page layout and data fields to customize the Map Page.

Current Route Page

Whenever you start a route in the GPSMAP 378/478 in Automotive Mode, the Active Route Page shows each turn of the active route, with the distance to the turn, the street name, and estimated time to arrival and time of arrival. As you navigate a route, the turn list automatically updates to indicate the next turn at the top of the list.

	0.1 ^m	Turn right on Imperial Beach Blvd	00:13 04:10 ^R
	1.4 ^m	Take ramp to I-5 N on right	02:26 04:12 ^R
	6.4 ^m	Keep left on I-5 N	06:53 04:17 ^R
	9.8 ^m	Keep left on I-5 N	09:51 04:20 ^R
	22.1 ^m	Arrive at Point Loma Park and Recre on left	21:55 04:32 ^R

Current Route Page

You can scroll through the entire list by moving the scroll bar up or down. Highlight any of the turns on the list, and press **ENTER** to view the Next Turn Page for that turn. The Current Route and Next Turn Pages show similar information using a different layout. The Next Turn Page shows your next turn on a map.

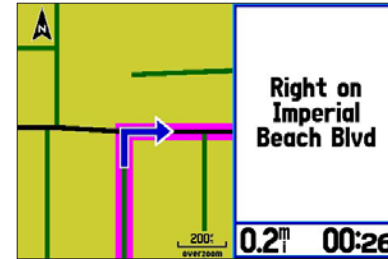

Next Turn Page

Saving the Current Route

You can save the current route from the Current Route Page. Press **MENU** to save the route. Press **ENTER** when **Save Route** is highlighted. Your route is automatically saved, using the starting point and destination as the route name. Press **ENTER** when **OK** is highlighted to finish saving the route.

Trip Computer Page

The Trip Computer Page shows important data while navigating a route in Automotive Mode. It indicates your current speed and other data about your trip, such as average speed and moving time.

Trip Computer		
NW 09:31:35 ^h	70.0^m_h 000000.8 ^h	35.5^m 000035.5 ^h
Moving Average	Total Average	Maximum Speed
35.8^m_h	13.5^m_h	78.5^m_h
Moving Time	Stopped Time	Total Time
00:59:22	01:38:36	02:37:57

Trip Computer Page

Reset the Trip Computer before beginning a trip. If you make frequent stops, leave the GPSMAP 378/478 turned on in order to receive satellites. This allows the unit to accurately measure elapsed time during the trip.

Trip Computer Page Options Menu

Press **MENU** to open the options menu. Highlight an option, and press **ENTER**.

Trip Computer		
NW 09:31:35 ^h	70.0^m_h 000000.8 ^h	35.5^m 000035.5 ^h
Moving Average	Total Average	Maximum Speed
35.8^m_h	13.5^m_h	78.5^m_h
Moving Time	Stopped Time	Total Time
00:59:22	01:38:36	02:37:57

Trip Computer Page Options Menu

Set Up Page Layout—choose the layout and number of data fields.

Change Nearest Type—allows you to specify the type of item to be used as the nearest item [shown in the lower-left data field of the Position Data (**2 Columns**) layout]. The choices change based on the current Usage Mode.

Reset (Trip, Max Speed, Odometer, All)—options to reset the maximum speed, the odometer, everything but the max speed and odometer, or reset everything in the trip computer.

MAIN MENU

The Main Menu provides access to various waypoint, system, navigation and interface management, and setup menus.



Main Menu

To select a tab from the Main Menu:

1. From any page, press **MENU** twice to open the Main Menu.
2. Highlight the tab you want. The information for the highlighted tab automatically appears on the right. To highlight a sub tab, press left or right on the **ROCKER**, and then press up or down to select individual fields.

Main Menu Tabs

- **GPS**—view satellite information.
- **Weather**—view individual weather features.
- **XM**—view and select XM Radio channels.
- **Route**—create and store routes.
- **Points**—view stored waypoints.
- **Track**—record and save tracks.
- **DCS**—set up digital select calling features.
- **Sonar**—configure sonar options.
- **Alarms**—define alarm settings.
- **Calendar**—view sun/moon and hunting/fishing information for a specific day.
- **Celestial**—view tide, hunting & fishing, and sun & moon information.
- **Message**—view system-generated messages.
- **Display**—adjust backlighting and page display.
- **Sound**—customize GPSMAP 378/478 sounds.
- **Setup**—adjust system settings.

GPS Tab

The GPS tab provides a visual reference of satellite acquisition, receiver status, and accuracy. The sky view and signal strength bars give an indication of what satellites are visible to the receiver and whether they are being tracked. For more information about GPS, see [pages 4-6](#).

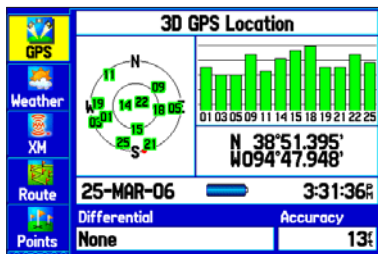

Main Menu—GPS Tab

Weather Tab

Use the Weather tab on the Main Menu to view individual weather features without turning all other weather features on or off. For example, you can select **Storm Cells** to view only storm cells on the Map window that appears on the Weather tab. When you close the Main Menu and return to the Map Page, all of your previously selected weather features still appear on the Map Page.



NOTE: You must have a subscription to XM WX Weather, and the GXM 30 antenna must be plugged into the USB port on the back of the unit to use features described in this section.



Main Menu—Weather Tab

For more information about XM Weather, see the “[Using XM WX Weather](#)” section beginning on [page 95](#).

XM Tab

The XM tab is where you can view and select XM Radio channels, add or delete favorites, and obtain radio ID and XM WX Weather service level information. The XM tab is divided into two sub tabs: **Audio** and **Information**.



NOTE: The XM tab always appears on the Main Menu, regardless of whether the XM Audio Page is turned on or off. For more information about the XM Audio Page, see [page 52](#).

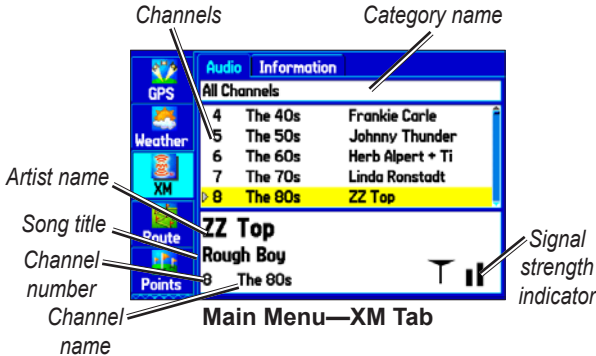

Audio Sub Tab

The Audio sub tab shows XM Radio channel categories, a list of available channels, information about the selected channel, and the strength of the XM signal.

Information Sub Tab

Use the Information sub tab to view the radio identification number, XM WX Weather subscription information, and a list of weather features available to you based on your subscription plan. The Information sub tab also shows the age of each weather report in minutes.

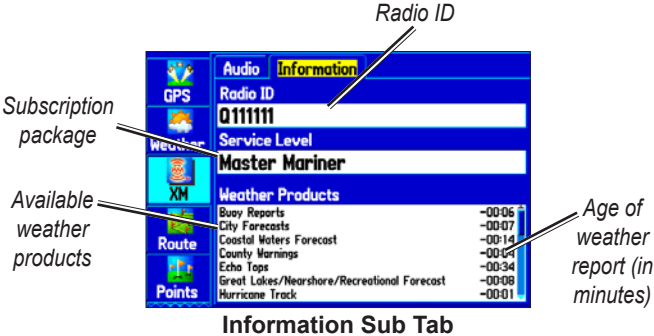

For more information about XM Weather, see the “[Using XM WX Weather](#)” section beginning on [page 94](#).

Route Tab

The Route tab shows all the routes currently stored in memory, along with a descriptive name for each route.

Use the Route tab create and store up to 50 reversible routes, with up to 300 points each. See the “[Creating and Using Routes](#)” section beginning on [page 20](#) for more information about routes.

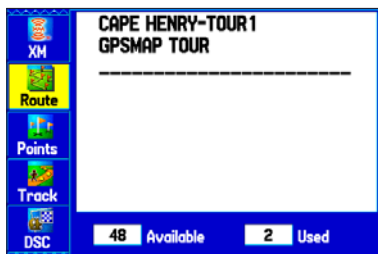

Main Menu—Route Tab

Points Tab

The Points tab contains two sub tabs, User and Proximity, which allow you to manage a large number of waypoints quickly and efficiently. For more information about waypoints, see the “[Creating and Using Waypoints](#)” section beginning on [page 24](#).

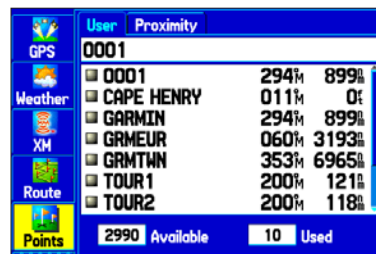

Main Menu—Points Tab

User Sub Tab

The User sub tab shows a master list of all waypoints currently stored in memory. The total number of stored and available waypoints appear at the bottom of the User sub tab.

Proximity Sub Tab

Use the Proximity sub tab to define an alarm circle around a stored waypoint location.

Track Tab

Use the Track tab to specify whether or not to record a track log, define how it is recorded, or save the track log data for future use. The Track tab is divided into two sub tabs: Active and Saved. For more information about tracks, see the “[Managing Your Tracks](#)” section beginning on [page 34](#).



Main Menu—Track Tab

Active Sub Tab

The Active sub tab is for the active log (the log currently being recorded). It shows the amount of track memory used and current settings.

Saved Sub Tab

The Saved sub tab shows a list of all saved tracks in your GPSMAP 378/478.

DSC Tab

Use the DSC tab (Marine Mode only) to control and set up the Digital Selective Calling (DSC) features. DSC uses marine VHF radio and GPS to transmit and receive location information. DSC is used by mariners for distress calls and position reporting.

For more information about DSC and Maritime Mobile Service Identity (MMSI) numbers, see [pages 128-129](#) in the “[Appendix](#).”

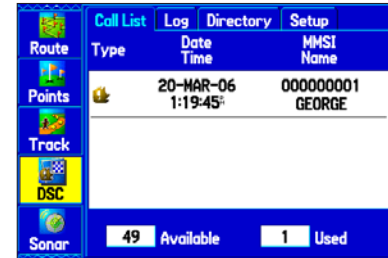

DSC Page

Understanding Distress Calls

With your GPSMAP 378/478 properly connected to a VHF radio with DSC output, you can receive any DSC distress call within range. An alert message appears and a tone sounds when a distress call is received. The alarm only sounds on a distress call; position reports do not sound the alarm. Distress calls are broadcast to all DSC users in radio range and appear with a blue and white checkered icon on the DSC Call List and Log tabs.

You can enter a caller's name, if it is known. The caller's name replaces the MMSI number as a reference once entered.

Understanding Position Reports

The Position Report operates similarly to the distress call. This type of contact is like a phone call; no emergency alarms are set off. Position reports are not broadcast to all DSC users and appear with a gold boat icon.

Receiving DSC Calls

Each time you receive a distress call or position report, a review page opens—either a DSC Position Report Page or a Distress Call Page. Both pages contain identical fields to the DSC Entry Review Page.

Each entry in the Call List and Log has a corresponding DSC Entry Review Page. This page operates similarly to the Distress Page and Position Report Page. From the DSC Entry Review, you can **Delete** the entry, **Save** it as a waypoint, or show the location on the map.

To review a call or log entry:

1. Open the Call List or Log from the **DSC** tab.
2. Highlight the call you want to review.
3. Press **ENTER** to open the DSC Entry Review Page.

DSC Entry Review		
MMSI	00000001	
Name	GEORGE	
Receiving Time	26-MAR-06 10:44:39	
From Current Location		
0°	011°	N 36°55.997 W076°00.040
Delete	Show Map	Save

DSC Entry Review Page

DSC Call List

The Call List sub tab shows the 50 most recent calls, even if the unit is left unattended. The Call List only shows the most recent call from a vessel. If a second call is received, it replaces the first call in the Call List. Press **MENU** to sort the list and delete entries.

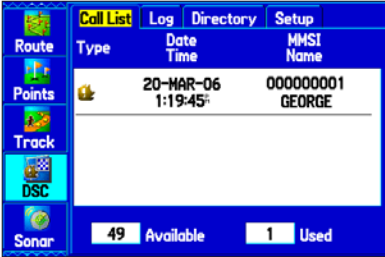

DSC Call List

DSC Log

When DSC calls are received, they are automatically stored in the Log, with the latest call at the top. The unit can store up to 100 calls; after 100 calls are received, the oldest log file is removed when a new call is received.

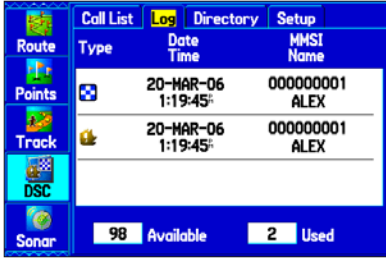

DSC Log

Receiving a Position Report or Distress Call

After you receive a Position Report or a Distress Call, you can quickly navigate to the location. Highlight a call from the **Call List** or **Log** and press **Direct To**. The top selection in the Navigate Menu is highlighted. Press **ENTER** to go to the location.

DSC Directory

The DSC Directory is like a phone book and can hold up to 50 entries.

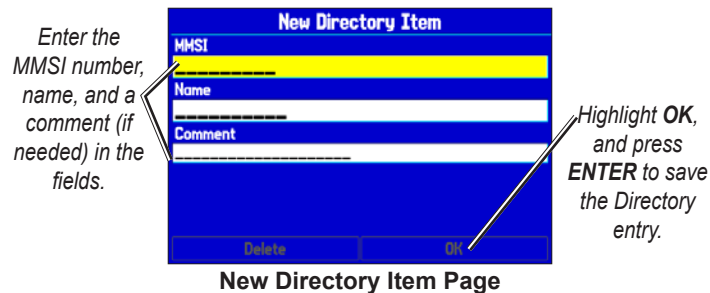
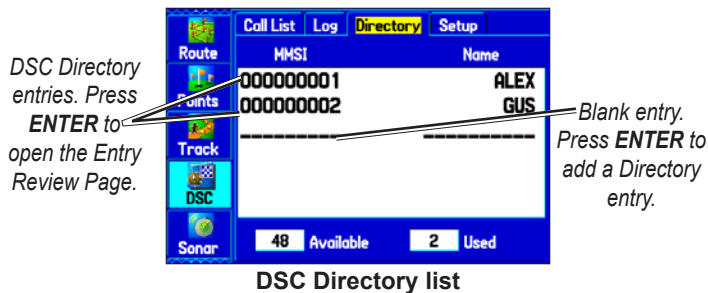

To add a new Directory entry:

1. Open the DSC Directory on the Main Menu.
2. Highlight the first blank space in the directory list, and press **ENTER**.
OR
Press **MENU**, highlight **New Item**, and press **ENTER**.
3. Enter the MMSI number, the name, and any comments.
4. When finished, highlight **OK**, and press **ENTER**.

After creating a New Directory Item, the name created is attached to that particular MMSI number. If you return to the Log, the new name appears under the corresponding MMSI number.

Another way to input a name is from the Entry Review Page or the DSC Distress Call Page or DSC Position Report Pages. The Name and MMSI are sent to other Garmin GPS units: Only the MMSI numbers are sent to other non-Garmin DSC users.

Making a Distress Call

To make a distress call, press the MayDay button on your VHF radio. The call transmits on an emergency channel with the MMSI number attached to the call, if you have DSC support. Any DSC-equipped mariner (on sea or land) within range can receive the call.

Setting Up DSC

Use the Setup sub tab to turn DSC on and off. If you have more than one chartplotter and only want DSC to show on another chartplotter, turn DSC off on this unit.

This Setup sub tab also allows you to simulate distress calls and position reports while the unit is in Simulator Mode (see [page 12](#)). Simulating calls is helpful for practice before connecting to the real system. The Distress Call simulator also helps to check if alarms are working properly.

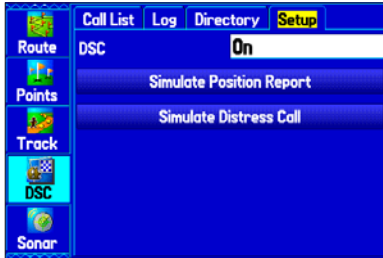

DSC Setup

Sonar Tab

Use the Sonar tab contains options for the Sonar Page. See the “[Setting Up and Using Sonar](#)” section beginning on [page 103](#) for more information about sonar setup options.



NOTE: You must have a GSD 21 Sounder Module connected to your GPSMAP 378/478 to use sonar.

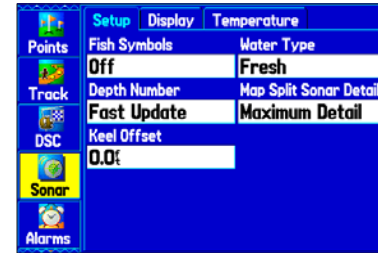

Main Menu—Sonar Tab

Alarms Tab

Use the Alarms tab to define alarm settings. When an alarm goes off, the alarm message appears on the GPSMAP 378/478 and the unit emits five (5) beeps.

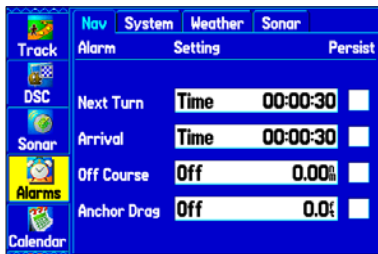

Main Menu—Alarms tab

To set an alarm:

1. Highlight the **Alarms** tab on the Main Menu.
2. Select an alarm to set, and press **ENTER**.
3. Change the setting to **On**, and press **ENTER**. If necessary, highlight the next field to the right, and press **ENTER**. Enter the settings you want.
4. Press **ENTER** to finish.

When you set an alarm to be persistent, the alarm message appears on the screen and the unit beeps until you press **ENTER** to acknowledge the alarm.

To set a persistent alarm:

1. Highlight the **Alarms** tab on the Main Menu.
2. Highlight the box next to the alarm you want to make persistent.
3. Press **ENTER** to place a check mark in the **Persist** box.

Navigation (Nav) Alarms

The Nav sub tab contains the following alarms:

Next Turn—sets an alarm to indicate the next turn in a route. Select **Dist** to specify a distance before you reach the next turn to sound the alarm. Select **Time** to specify a time before the turn for the alarm to go off. Select **Auto** for the unit to provide a Next Turn alarm at its discretion.

Arrival—sets an alarm to sound when you are a specified distance or time away from a destination waypoint. Select **Auto** for the unit to provide an Arrival alarm at its discretion.

Off Course—sets an alarm to sound when off course. Select **On**, then enter a distance.

Anchor Drag—sets an alarm to sound when you exceed a specified drift distance. Select **On**, and then enter a distance.

System Alarms

Clock—sets an alarm based on the unit's clock. Select **On**, and then enter a specific time that you want the alarm to sound. The GPSMAP 378/478 must be on for the clock alarm to work.

Ext. (External) Voltage—sets an alarm to sound when the external voltage drops below a specified amount. Select **On**, and then enter a specific voltage.

DGPS—sets an alarm to sound when the GPSMAP 378/478 loses a differential fix.

Accuracy—sets an alarm to sound when GPS accuracy falls outside of the user-set value. Select **On**, and then specify a distance.

Weather Alarms

Tornado Warnings—sets an alarm to sound when you enter an area where a tornado warning is in effect.

Thunderstorm Warnings—sets an alarm to sound when you enter an area where a severe thunderstorm warning is in effect.

Flood Warnings—sets an alarm to sound when you enter an area where a flood warning is in effect.

Flash Flood Warnings—sets an alarm to sound when you enter an area where a flash flood warning is in effect.

Marine Warnings—sets an alarm to sound when you enter an area where a marine warning is in effect.

Sonar Alarms

Shallow Water/Deep Water—sets an alarm to sound when you enter an area of water that is too shallow or deep. Select **On**, and then specify a depth. You must be receiving sonar NMEA data for this function to work.

Water Temp—sets an alarm to indicate if the water temperature has exceeded or dropped below a specific temperature, or fallen outside/inside a specific temperature range. Select **Above** or **Below** and then enter a specific temperature, or select **Inside** or **Outside** and enter a range of temperatures. You must be receiving sonar NMEA data for this function to work.

Drift—sets an alarm to sound when you exceed a specified drift distance. Select **On**, and then enter a specific distance.

Fish—sets an alarm to sound when fish are detected with sonar.

Calendar Tab

Use the Calendar tab to plan trips, view sun and moon, and hunting and fishing information for the day.

*Highlight an arrow and press **ENTER** to change the date in the view.*

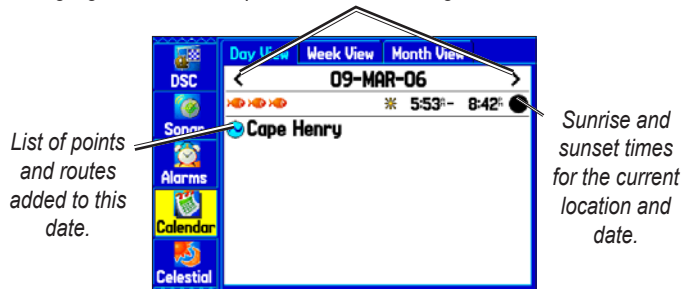

List of points and routes added to this date.

Sunrise and sunset times for the current location and date.

Calendar Tab in Day View

Calendar Options

The options menu is available in all three calendar views. Press **MENU** on any of the calendar views to open the options menu. To view the Sun & Moon Information tab or Hunt & Fish sub tab, highlight **View Sun and Moon** or **View Hunt and Fish**, and press **ENTER**.

To add a route (or point) to the calendar:

1. Highlight the **Calendar** tab on the Main Menu. The current day appears on the **Day View** sub tab.
2. Press **MENU** to open the options menu. Highlight **Add Route** (or **Add Point**), and press **ENTER**.
3. From the pop-up route list (or the Find Menu if **Add Point** was selected), select the route you want to add to the calendar, and press **ENTER**.

Day View Sub Tab

The Day View sub tab shows sunrise and sunset times for your current date and location. Points and routes for the day appear in a list.

Week View Sub Tab

The Week View sub tab provides the same elements as Day View, but the entire week is visible. Days with added points or routes are shown highlighted in green. Icons for the points and routes assigned to the date are shown along the bottom of the screen.

Month View Sub Tab

The Month View sub tab provides the same elements as Day View, but the entire month is visible. Days with added points or routes are shown highlighted in green. Icons for the points and routes assigned to the date are shown along the bottom of the screen.

Celestial Tab

The Celestial tab shows tide information, sun and moon information, and hunting and fishing information. You can view data for your current location, a location from the map, or a waypoint location. Also, you can select a different date and time, or use the current data.

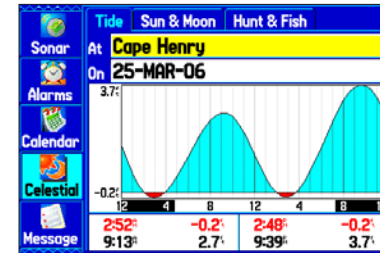

Main Menu—Celestial Tab

To access the Celestial tab:

1. Highlight the **Celestial** tab on the Main Menu.
2. Use the **ROCKER** to select the sub tab you want, such as **Sun & Moon**.

Tide Sub Tab

The Tide sub tab contains a graphical chart that shows tide station information in a 24-hour span starting at midnight station time. You can choose from different dates and more than 3,000 tide stations.

Enter the date for which you want to view the tide information.

Select the tide station for which you want to view the information.

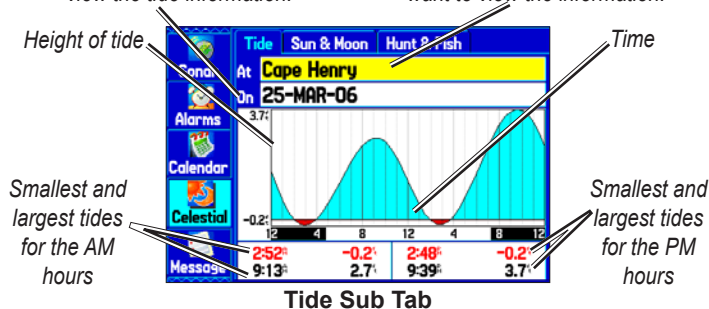

The top of the page shows the tide station and date being referenced. The chart shows a 24-hour block of time, with the time progressing from left to right. The solid vertical lines represent 4-hour increments; the dotted vertical lines represent 1-hour increments.

The tide curve appears as a shaded area; higher tides are taller and lower tides are shorter. The bottom of the page indicates the times with the highest and lowest tides.

To view a tide chart for a different tide station:

1. From the **Tide** sub tab, highlight the **At** field, and press **ENTER**. The Find Menu opens showing the tide stations.
2. Press **MENU**, and select **Near Current Location**, **Near Current Route**, **Near Other** (select another location using the map), or **Near Destination**. The list is updated with your search requirements.
3. Select a tide station from the list, and press **ENTER**. The Tide Station Information Page appears.
4. Highlight **OK**, and press **ENTER**. The **Tide** tab appears again showing the tide chart for the selected tide station.

To view the tide chart for another date:

1. From the **Tide** sub tab with a chart open, highlight the **On** field, and press **ENTER**.
2. **ENTER** the date with the **ROCKER**, and press **ENTER**. You can also use the zoom **IN** and **OUT** keys to view information for another date. Press and hold **IN** or **OUT** to scroll quickly through dates.
3. Press **ENTER** when finished. The unit shows the chart for the date you entered or selected.

To use the current date again, highlight the **Date** field. Press **MENU**, highlight **Use Current Date**, and press **ENTER**.

To view a chart's details for another time during the day (other than current time):

1. From the **Tide** sub tab with the chart you want to view, press **MENU**, and then select **Move Cursor**.
2. Press the **ROCKER** right or left to view the chart at another time.
3. To return to the current time, press **MENU**, and select **Stop Moving Cursor**.

To automatically start Pointer Mode to scroll the chart:

1. Highlight the **Date** field. Then press down to start the Pointer (Pan) Mode.
2. Scroll the chart right to view the next day or left to view the previous day.

Sun & Moon Sub Tab

The Sun & Moon sub tab provides you with sunrise/sunset and moon rise/set times. A graphic of the moon phase also appears. You can view Sun & Moon information for any date or location. You can also use the play, fast forward, and stop buttons to view an animation of the Sun & Moon sub tab.

To view sun and moon information for a different date:

1. Highlight the **Date** field, and press **ENTER**.
2. Use the **ROCKER** to change the digits of the date to the date you want. You can also use the zoom **IN** and **OUT** keys to view information for another date. Press and hold **IN** or **OUT** to scroll quickly through dates.
3. Press **ENTER** when finished. The unit shows the sun and moon information for the date you entered or selected.
4. To use the current date again, highlight the **Date** field. Press **MENU**, highlight **Use Current Date**, and press **ENTER**.

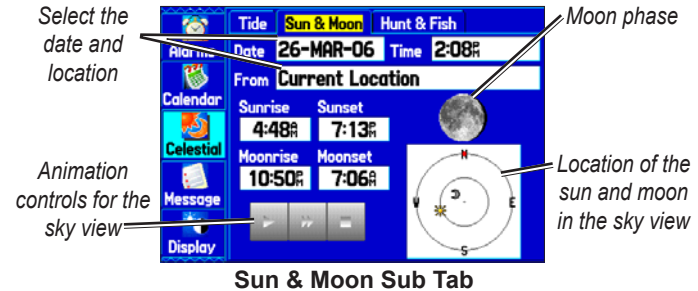

To view sun and moon information for a different location:

1. Highlight the **From** field, and press **ENTER**.
2. Highlight **Use Find Menu**, and press **ENTER**. The Find Menu automatically opens.
3. Select a waypoint or point of interest, and press **ENTER**.
4. On the Waypoint Information Page, press **ENTER**. The unit shows the sun and moon information for the location you selected.

To use the current location, highlight the **From** field. Press **ENTER**, highlight **Current Location**, and press **ENTER** again.

Hunt & Fish Sub Tab

The Hunt & Fish sub tab provides you with predictions of the best times to hunt and fish in a selected location on a specific date.

To show the Hunt & Fish information:

1. Highlight the **Celestial** tab on the Main Menu.
2. Select the **Hunt & Fish** sub tab.

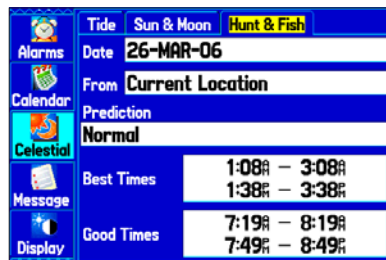

Hunt & Fish Sub Tab

To view hunt and fish information for a different date:

1. Highlight the **Date** field, and press **ENTER**.
2. Use the **ROCKER** to change the digits of the date. You can also use the zoom **IN** and **OUT** keys to view information for another date. Press and hold **IN** or **OUT** to scroll quickly through dates.
3. Press **ENTER** when finished. The unit shows the information for the date you entered.

To use the current date again, highlight the **Date** field. Press **MENU**, highlight **Use Current Date**, and press **ENTER**.

To view hunt and fish information for a different location:

1. Highlight the **From** field, and press **ENTER**.
2. Highlight **Use Find Menu**, and press **ENTER**. The Find Menu opens.
3. Select a point, and press **ENTER**.
4. On the information page, press **ENTER**. The unit shows Hunt & Fish information for the selected location.

To use the current location:

1. Highlight the **From** field, and press **ENTER**.
2. Highlight **Current Location**, and press **ENTER**.

Message Tab

The Message tab shows a list of messages generated by the GPSMAP 378/478. Use the **ROCKER** to scroll through the entire list of messages on the Log sub tab. Use the Log Filter sub tab to show only the message types that you want to view.

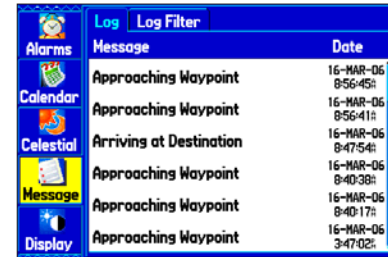

Log	Log Filter	Message	Date
		Approaching Waypoint	16-MAR-06 8:56:45H
		Approaching Waypoint	16-MAR-06 8:56:41H
		Arriving at Destination	16-MAR-06 8:47:54H
		Approaching Waypoint	16-MAR-06 8:40:39H
		Approaching Waypoint	16-MAR-06 8:40:17H
		Approaching Waypoint	16-MAR-06 3:47:02H

Main Menu—Message Tab

To view messages:

1. Highlight the **Message** tab on the Main Menu.
2. Highlight a message.
3. Press **ENTER** to view detailed information about the message.

To show or hide messages using the log filter:

1. Highlight the **Message** tab on the Main Menu.
2. Highlight the **Log Filter** sub tab. All messages appear by default.



Message Log Filter Tab

3. Highlight the message type you want to hide, and press **ENTER**. The message name appears in the **Hide** window.
4. Highlight the message, and press **ENTER** to show it again.

Display Tab

Use the Display tab to set display features, such as pages to show in the main page sequence and how long the backlight stays on.



Main Menu—Display Tab

Main Menu—indicates whether the Main Menu tabs are to contain text and icons (default), or text tabs only.

Color Mode—sets the display to **Day**, **Night**, or **Auto** Color Mode. Select **Auto** to automatically switch from day to night at sunset and change back at sunrise.

Backlight Timeout—sets the backlight to stay on when it is turned on, or to time out after a selected period of time has elapsed when using the battery. The backlight stays on regardless of this setting when external power is used.

Twilight Adjustment—allows the unit to adjust the backlight for optimum viewing during twilight times.

Highway Page—indicates whether the Highway Page appears in the main page sequence.

XM Audio Page—indicates whether the XM Audio Page appears in the main page sequence.

Compass Page—indicates whether the Compass Page appears in the main page sequence.

Backlight Intensity—turns the backlight up or down. Press right on the **ROCKER** to increase the intensity or left to decrease.

Sound Tab

Use the Sound tab to customize the sounds made by your GPSMAP 378/478.



Main Menu—Sound Tab

Beeper—sets the beeper to chime during keypresses and alarms (**Key and Alarm**) or on **Alarms Only**.

Audio Jack—sets the audio jack output for **Headphones** or **Line Out**.

Attention Tone—turns on and off the attention tone that sounds before the vocal prompts.

Voice Prompt—sets the vocal prompt to operate for **Guidance and Status**, **Route Guidance Only**, or **No Voice Prompts**.

Voice Language—sets the language for vocal prompts.

Speaker Volume—sets the external speaker or headphone volume.

Setup Tab

To customize how your GPSMAP 378/478 looks, use the System tab to adjust certain system settings.

System Sub Tab

Use the System sub tab to control settings for System Mode, Speed Filter, Text Language, WAAS, and External Power.

To access the System sub tab:

1. Highlight the **Setup** tab on the Main Menu.
2. Select the **System** sub tab.

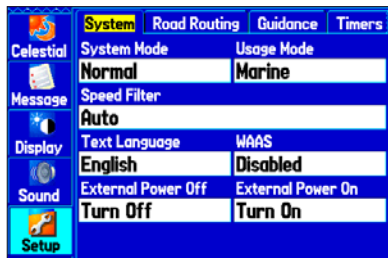

Main Menu—System Setup Tab

System Mode—sets the unit to operate in **Normal Mode**, **Battery Saver Mode**, or **Simulator Mode** (for practice ONLY).

Usage Mode—sets the unit to operate in **Marine** (default) or **Automotive Mode**.

Speed Filter—allows the unit to average speed readings. Choose from **Off**, **Auto** (automatically controls filtering), or **On** (allows you to enter a value in seconds).

Text Language—sets the unit's on-screen language.

WAAS—allows you to enable or disable WAAS.

External Power Off—indicates whether the GPSMAP 378/478 remains on (**Stay On**) or the unit turns off (**Turn Off**) when external power is removed from the unit.

External Power On—indicates whether to turn on the GPSMAP 378/478 (**Turn On**) or charge the battery (**Charge Battery**) when external power is applied to the unit.

Road Routing Sub Tab

Use the Road Routing sub tab to select road routing settings.

To access the Road Routing sub tab

1. Highlight the **Setup** tab on the Main Menu.
2. Select the **Road Routing** sub tab.

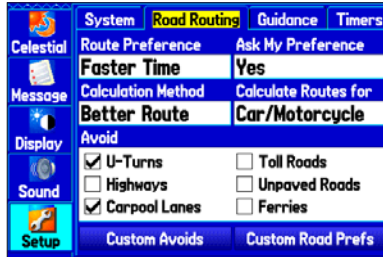

Road Routing Sub Tab

Route Preference—allows the unit to calculate routes based on:

- **Faster Time**—routes calculated are faster to drive but might be longer in distance.
- **Shorter Distance**—routes calculated are shorter in distance but might take more time to drive.
- **Off Road**—creates a direct line from your current location to your destination. This is useful when traveling outside of the detailed map coverage area or where no roads exist.

Ask My Preference—determines whether you are asked to select a Route Preference before route calculations.

Calculation Method—sets how the unit searches for the route.

- **Quickest Calculation**—calculates the route the quickest, but it might not produce the best route.
- **Quick Calculation**—takes a bit more time to calculate but generates a better quality route.
- **Better Route**—generates an even better quality route but uses a longer calculation time.
- **Best Route**—generates the optimal route but takes the longest time to calculate.

Calculate Routes for—sets route calculation for the particular vehicle you are operating to optimize the route for your vehicle type.

Avoid—allows you to avoid certain road types and maneuvers on your route. The unit uses these road types only if alternative routes take you too far out of your way or if no other road is available.

Custom Avoids—allows you to enter specific areas and roads that you would like to avoid in your navigation.

Custom Road Prefs—allows you to avoid or use **Major**, **Medium**, and **Minor** roads using a slider scale. This is useful if you want to avoid major highways, for example. Select **Auto Set** to use preset values.

Guidance Sub Tab

Use the Guidance sub tab to set guidance information.

To access the Guidance sub tab

1. Highlight the **Setup** tab from the Main Menu.
2. Select the **Guidance** sub tab.

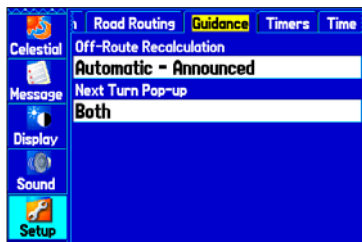

Guidance Sub Tab

Off-Route Recalculation—allows you to set whether the unit prompts you when it is recalculating your route (**Prompted**), or recalculates automatically. Set whether the unit announces the recalculation (**Automatic - Announced**) or recalculates silently (**Automatic - Silent**). You can turn the off-route recalculation **Off**.

Next Turn Pop-up—turns the Next Turn pop-up window **Off**, or opens the window when you press NAV (**Held NAV Key Only**), opens automatically (**Automatically Only**), or **Both**.

Timers Sub Tab

Use the Timers sub tab to set timers and view information about how long the unit has been on.

To access the Timers sub tab

1. Highlight the **Setup** tab from the Main Menu.
2. Select the **Timers** sub tab.



Timers Sub Tab

User—allows you to set the timer to **Count Up** or **Count Down**. You can also **Reset** the timer and turn it **Off**. Enter a time to use when counting up or down.

Marine—appears on the Compass Page in Marine Mode.

Since Midnight—shows the time the unit was turned on since midnight. To reset, select **All Unit Defaults** on the System sub tab.

Time Sub Tab

Use the Time sub tab to set the time format and zone, and set the unit to conform to Daylight Saving Time. The current time and date appear in the Current Time and Date field.

To access the Time sub tab

1. Highlight the **Setup** tab on the Main Menu.
2. Select the **Time** sub tab.

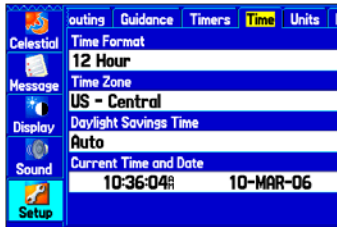

Time Sub Tab

Time Zone—choose the time zone for your city so the GPSMAP 378/478 will show the correct local time. Select **Other** to enter a UTC Offset.

If the wrong date appears, press **MENU**, highlight **Set Date**, and press **ENTER**. You are prompted to enter the current year. The GPSMAP 378/478 uses this information when gathering satellite data to show the correct date.

Units Sub Tab

Use the Units sub tab to customize measurement units.

To access the Units sub tab

1. Highlight the **Setup** tab on the Main Menu.
2. Select the **Units** sub tab.

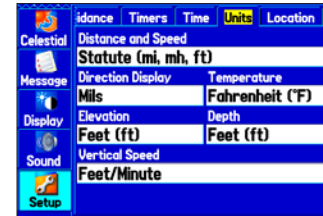

Distance and Speed—selects the unit of measure to show your speed and distance traveled.

Direction Display—selects the unit of measure to show your direction. Mils is a unit of angle measurement used in military settings, in which 17.78 mils equal one degree.

Temperature—selects the unit of measure to show the temperature.

Elevation—selects the unit of measure to show your altitude.

Depth—selects the unit of measure to show the depth.

Vertical Speed—selects the unit of measure to show the vertical speed.

Location Sub Tab

Use the Location sub tab to change location setting information.

To access the Location sub tab:

1. Highlight the **Setup** tab on the Main Menu.
2. Select the **Location** sub tab.

See the “Appendix” for more information about location formats and map datums. Also visit the National Imagery and Mapping Agency at www.nima.mil for more information on grids and datums.

Changing the Location Format

When you change the **Location Format**, you change the coordinate system in which a given location reading appears. The default format is latitude and longitude in degrees, minutes, and thousandths of a minute (hddd°mm.mmm). Only change the location format if you are using a map or chart that specifies a different location format or want to use a format you are familiar with.

Selecting a Different Map Datum

Datums are used to describe geographic positions for surveying, mapping, and navigation and are not actual maps built in the unit. Only change the datum if you are using a map or chart that specifies a different datum.

The default setting is WGS 84. The unit automatically selects the best datum depending on your chosen location format.



WARNING: Selecting the wrong map datum can result in substantial position errors. When in doubt, use the default WGS 84 datum for best overall performance.

Selecting a Different Heading Reference

You can select from **Auto Mag Var**, **True**, **Grid**, and **User Mag Var**. **Auto Mag Var** provides magnetic north heading references that are automatically determined from your current location. **True** provides headings based on a true north reference. **Grid** provides headings based on a grid north reference (and is used in conjunction with the grid position formats). **User Mag Var** allows you to specify the magnetic variation at your current location and provides magnetic north heading references based on the variation you enter. Enter the magnetic variation of your current location in the **Magnetic Variation** field if you selected **User Mag Var** for the heading.



WARNING: If **User Mag Var** is selected, the unit does not automatically calculate and update the magnetic variation at your present location. You must update the magnetic variation as your location changes. Failure to update this setting can result in substantial differences between the information shown on your unit and external references, such as a magnetic compass.

Welcome Sub Tab

Use the Welcome sub tab to enter information, such as your name and address, or a welcome message that appears when you turn on your GPSMAP 378/478.

To access the Welcome sub tab:

1. Highlight the **Setup** tab on the Main Menu.
2. Select the **Welcome** sub tab.

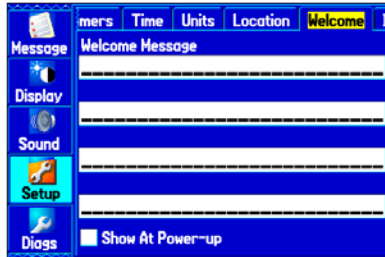

Welcome Sub Tab

To add a welcome message:

1. Highlight one of the Welcome Message fields, and press **ENTER**.
2. Use the **ROCKER** to enter information in the fields. You do not need to enter information in every field. When finished, press **ENTER** again.

3. To show the welcome message when you turn on your GPSMAP 378/478, highlight the **Show at Power-up** check box, and press **ENTER** to select it. To hide the welcome information at start-up, clear the check mark.

Interface Sub Tab

Use the Interface sub tab to change the data format and control the input/output format used when connecting your unit to external devices.

To access the Interface sub tab:

1. Select the **Setup** tab on the Main Menu.
2. Select the **Interface** sub tab.

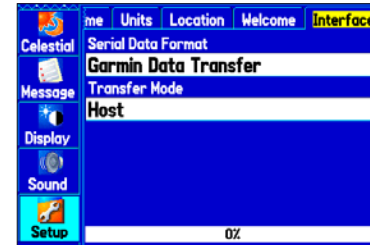

Interface Sub Tab

Serial Data Format—sets the data format to one of the following:

- **Garmin Data Transfer**—provides the proprietary format used to exchange data with a computer or another Garmin GPSMAP 378/478. Garmin Data Transfer is disabled when the USB is connected, and the unit automatically switches to USB format. When the USB is disconnected, the USB field changes to Transfer Mode.
- **GARMIN DGPS**—connects the GPSMAP 378/478 with a Garmin DGPS beacon receiver.
- **Garmin Remote Sonar**—connects the GPSMAP 378/478 with a GSD 21 or GSD 20 Sounder Module and transducer.
- **NMEA In/NMEA Out**—supports the input/output of standard NMEA 0183 version 3.01 data and sonar NMEA input support for the DBT, DSE, DPT, MTW, and VHW sentences.
- **RTCM In**—allows DGPS input using a standard RTCM format.
- **RTCM In/NMEA Out**—allows DGPS input using a standard RTCM format and also provides NMEA 0183 version 3.01 output.
- **RTCM In/Text Out**—allows Differential GPS (DGPS) input using a standard RTCM format and also outputs simple text data that includes data, time, location, and velocity.

- **Text Out**—allows the unit to output simple text data that includes data, time, location, and velocity. The Baud can be set to 1200, 2400, 4800, or 9600.
- **None**—provides no interfacing capabilities.

If you select GARMIN DGPS or RTCM In/NMEA Out format, you can control a differential beacon receiver directly from your GPSMAP 378/478 using the Interface sub tab. You can have the unit automatically scan for the DGPS beacon signal, or you can enter the beacon frequency and bit rate on the unit, and the information will be used to tune the beacon receiver. If you use a DGPS receiver, WAAS capability is automatically turned off.

To have the unit automatically scan for a frequency:

1. Set the unit to **GARMIN DGPS** or **RTCM In/NMEA Out**.
2. Highlight the **Beacon** field, and press **ENTER**.
3. Highlight **Scan**, and press **ENTER**. The numbers in the **Frequency** field change as the unit scans from 284 kHz to 325 kHz, 200 bit rate, then 100, at 6-second intervals.

Highlight **Scan**
and press
ENTER.



Shows the
status of the
scan

Interface Sub Tab with Garmin DGPS Selected

The Status field shows one of the following:

- **Tuning**—the unit is attempting to tune to the specified frequency and bit rate.
- **Scanning**—the unit is automatically scanning through the frequencies and bit rates.
- **Receiving**—the unit is receiving DGPS signal and ready for operation.
- **Check Wiring**—the unit is not making connection with DGPS receiver.

To restart the scan:

1. Press **MENU**.
2. Highlight **Restart Scan**, and press **ENTER**.

To manually enter a frequency and bit rate:

1. With the unit set to **Garmin DGPS** or **RTCM In/NMEA Out**, highlight the **Beacon** field, and press **ENTER**.
2. Highlight **User**, and press **ENTER**.
3. Highlight the **Frequency** or **Bit Rate** field, and press **ENTER**.
4. Enter a frequency or bit rate. Press **ENTER** when finished

When the unit is receiving a DGPS signal, the Signal to Noise Ratio (SNR) and Distance fields show data. The SNR range is 0 dB to 30 dB, with 30 being the best. The Distance field might or might not show data, depending on the signal being broadcast from the DGPS site.

The DGPS beacon transmitters are operated by the United States Coast Guard (or similar government agency in other countries), which is responsible for their accuracy and maintenance. For DGPS transmitter problems or to find the most updated list of frequencies and coverage areas, contact your local USCG or see their Web site at www.navcen.uscg.mil/.

Advanced NMEA Output Setup

If you are going to interface the GPSMAP 378/478 with another piece of equipment (such as a radar or autopilot), the unit needs to be set to output NMEA data. The NMEA data transmission can be customized to keep the output rate at two seconds. If too many NMEA sentences are activated, the unit might take longer than two seconds to update.

You can also set the Output Rate to Fast to output a minimum number of NMEA sentences at one-second intervals.

To access the Advanced NMEA Output Setup:

1. Highlight the **Setup** tab on the Main Menu.
2. Select the **Interface** sub tab.
3. Highlight the **Serial Data Format** field, and press **ENTER**.
4. Select **NMEA In/NMEA Out**, and press **ENTER**.
5. Press **MENU** to open the options menu. Select **Advanced NMEA Setup**, and press **ENTER**.

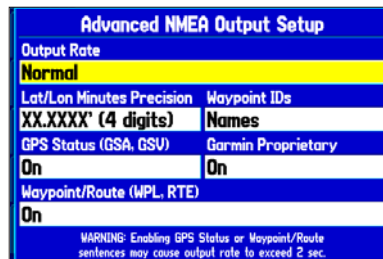

Advanced NMEA Output Setup

Use the Advanced NMEA Output Setup Page to set the output rate, change the precision of the Lat/Lon minutes, set Waypoint IDs to names or numbers, and turn on and off the GPS status, the Garmin Proprietary sentences, and Waypoint/Route (WPL, RTE).

GPSMAP 378/478 NMEA Sentence Output (NMEA version 3.01 compliant):

- Always transmitted: GPRMC, GPGGA, GPGLL, GPBWC, GPVTG, GPXTE, GPRMB
- Switchable sentences: GPGSA, GPGSV, GPWPL, GPRTE
- Garmin proprietary: PGRME, PGRMZ, PGRMM

USING XM WX WEATHER

This section describes how to use XM WX Satellite Weather with your GPSMAP 378/478. You must have a subscription to XM WX Weather, and you must plug your GXM 30 antenna into the USB port on the back of the unit to receive the XM signal. If you do not have a subscription to XM WX Weather, the features described in this section work only when the GPSMAP 378/478 is in Simulator Mode and the GXM 30 antenna is unplugged.

You can view XM WX Weather on your GPSMAP 378/478 in one of three ways:

- To view all weather information on the map, use the Map Page.
- To view a specific weather feature such as NEXRAD Radar or Storm Cells, for example, you can use the Weather tab on the Main Menu. For more information, see [page 98](#).
- To view current weather conditions and forecast information for your current location or a specific location, use the Weather Data option on the Find Menu. For more information, see [page 101](#).

Viewing XM WX Weather

From the Map Page, you can turn weather information on or off.

To turn XM WX Weather on or off on the Map Page:

Press and hold the **MENU/Wx** key to toggle XM Weather on or off.

OR

Press **MENU**, select **Hide (Show) Weather**, and then press **ENTER**.

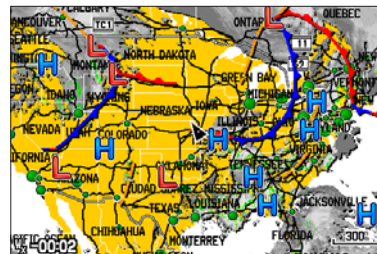

Map Page with XM WX Weather

Setting XM WX Weather Options

Use the Map Page options menu to adjust the way weather items appear on the Map Page. Three tabs—Weather, Srfc Wx, and Mrn Wx—allow you to adjust what weather items appear on the Map Page, and the scale at which they appear. For detailed information about specific weather features, see the *GXM 30 Owner's Manual*.

To set up weather options on the Map Page:

1. From the Map Page, press **MENU** to open the options menu.
2. Highlight **Set Up Map**, and press **ENTER**.

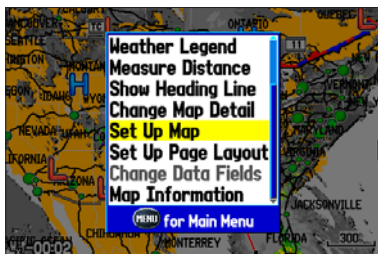

Map Page Options Menu

3. Highlight the **Weather**, **Srfc Wx**, or **Mrn Wx** tab.
4. Highlight the field you want to change, and press **ENTER**.
5. Press **PAGE** or **QUIT** to exit.

Weather Tab

Use the Weather tab to turn XM WX Weather data on or off on the Map Page, and set the map zoom range at which weather information first appears on the Map Page.

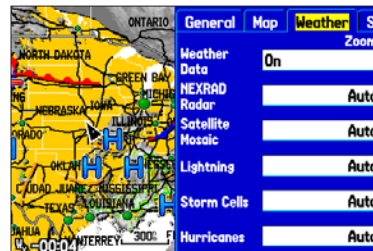

Weather Tab

Weather Data—allows you to turn XM WX Weather data on or off from the Map Page.

NEXRAD Radar, **Satellite Mosaic**, **Lightning**, **Storm Cells**, **Hurricanes**—sets the map scale at which the feature first appears on the Map Page. Select **Auto**, **Off**, or from **20 ft** to **800 nm**.

Srfc Wx Tab

Use the Srfc Wx tab to set the map scale at which surface weather information first appears on the Map Page.

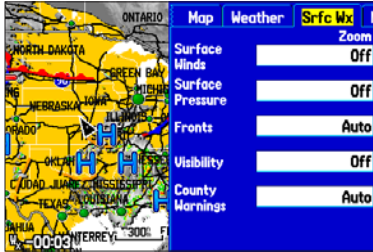

Srfc Wx Tab

Surface Winds, Surface Pressure, Fronts, Visibility, County Warnings—sets the map scale at which each feature first appears on the Map Page. Select **Auto**, **Off**, or from **20 ft** to **800 nm**.

Mrn Wx Tab

Use the Mrn Wx tab on the Map Page Options to set up marine weather options.

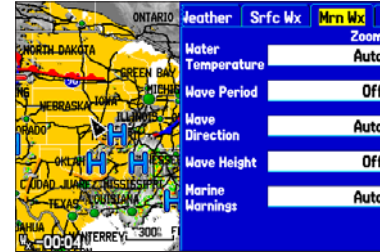

Mrn Wx Tab

Water Temperature, Wave Period, Wave Direction, Wave Height, Marine Warnings—sets the map zoom range at which each feature first appears on the Map Page. Select **Auto**, **Off**, or from **20 ft** to **800 nm**.

Using the Weather Tab

Use the Weather tab on the Main Menu to quickly view individual weather settings without turning all other weather features on or off. For example, you can select **Storm Cells** to view only storm cells on the Weather tab. When you close the Main Menu and return to the Map Page, all of your previously selected weather features still appear on the Map Page.

Depending on which mode you are in, different options appear. Use the zoom **IN** and **OUT** keys to zoom in or out on the map.

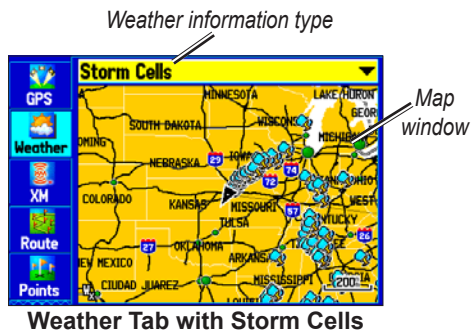

To view a specific XM WX Weather Information Type:

1. Highlight the **Weather** tab on the Main Menu.
2. Select the **Weather Information Type** field.

3. Select (scroll through) the weather information type you want to view. The map refreshes to show only the selected information type.

From the Weather tab, you can view the current conditions or forecast on the map for the next 12, 24, 36, or 48 hours.

To view the forecast map:

1. In the **Weather Information Type** field, highlight **Forecast**. The Map window shows the current forecast in the Map window.

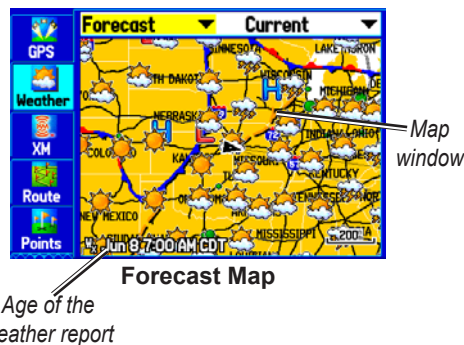

2. Highlight the field to the right of **Forecast**, and press **ENTER** to show a list of forecast options.

- Highlight the forecast you want to view—**Current, 12 Hour, 24 Hour, 36 Hour, or 48 Hour**, and press **ENTER**. The Map window on the Weather tab is updated with forecast information for the time you selected.

The age of the weather report appears in the bottom-left corner of the Map window on the Weather tab.

To pan the map:

Press and hold the **MENU/Wx** key, or press **MENU**, highlight **Show Map Pointer**, and press **ENTER**. The panning arrow  appears so you can pan the map to view other map areas.

Weather Options

Use the options menu on the Weather tab to select weather options for the Map window on the Weather tab.

To select weather options:

- Highlight the **Weather** tab on the Main Menu.
- Press **MENU**.

Declutter On (Off)—allows you to toggle unwanted weather items on or off on the Map window.

Animate Weather (Stop Animation)—animates NEXRAD Radar and Satellite Mosaic weather. When selected, a series of frames appear, each showing a different time in the lower-left corner of the map. Up to six frames appear, beginning with the oldest to the most current weather data.

Show Map Pointer—allows you to switch from Pan Mode to Pointer Mode and show the map pointer in the map area so you can pan the map.

Weather Legend—shows the color legend for Radar, Fronts, County Warnings, and Other features. Press right or left on the **ROCKER** to view each weather legend.

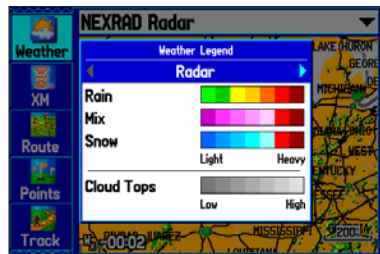

Weather Legend

Viewing Additional XM Weather Information

Use the Information sub tab to view the radio identification number, service level information, and list of weather products.

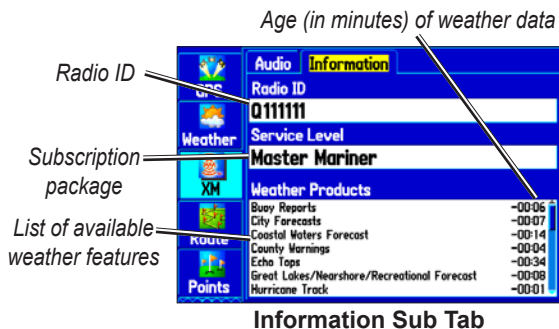

The Information sub tab contains the following information:

Radio ID—contains the eight-digit identification number of the radio built into your GXM 30 antenna. You must provide this ID to XM to start your XM Radio and XM WX Weather subscriptions.

Service Level—shows the name of the XM WX Weather subscription plan you purchased.

Weather Products—shows a list of all weather features you can access based on your subscription plan. Shows age of weather data in minutes.

Accessing GXM 30 Antenna Information

Use the Information sub tab to obtain version information about your GXM 30 antenna.

To view information about your GXM 30 antenna:

1. Highlight the **XM** tab on the Main Menu.
2. Select the **Information** sub tab.
3. Press **MENU**.
4. With **Antenna Information** highlighted, press **ENTER**. A window appears showing the software version loaded to your GXM 30 antenna.



5. Press **ENTER** to close the window.

Finding Weather Information

You can use the Find Menu to access weather information for your current location or from another location on the map. By selecting the Weather Data option on the Find Menu, you can view the current conditions, forecast information, sea surface conditions, and weather bulletins. For more information about the Find Menu, see “Finding an Item” beginning on page 17.

To find weather information for your current location:

1. From any page, press **FIND**.
2. Select **Weather Data**, and press **ENTER**. The Weather From Current Location Page opens.

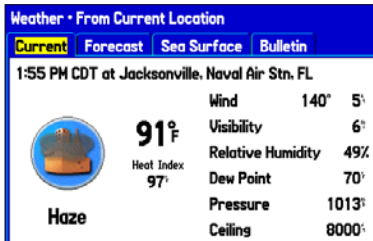

Weather From Current Location

3. Highlight the **Forecast** tab to view the weather forecast for your current location.

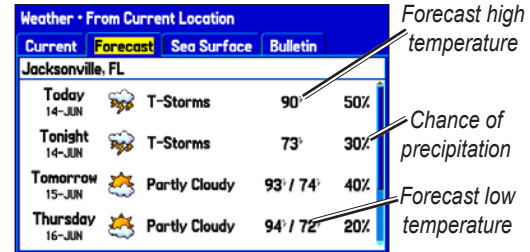

Weather Forecast

4. Highlight the **Sea Surface** tab to view sea surface information.

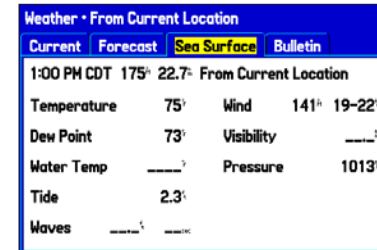

Sea Surface Information

- Highlight the **Bulletin** tab to view marine weather bulletins.

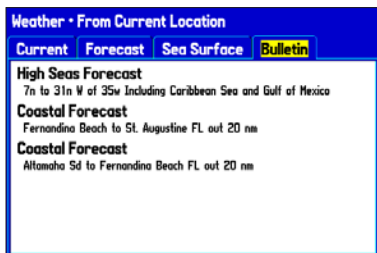

Marine Weather Bulletins

You can highlight a weather bulletin, and press **ENTER** to view the full text of the marine weather bulletin.

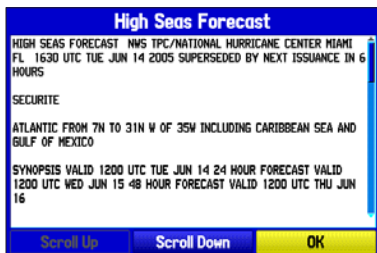

Marine Weather Bulletin

To find weather data for a different location:

- Press **MENU** on the Weather From Current Location Page.
- With **Near Other** highlighted, press **ENTER**.

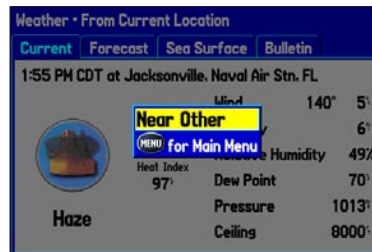

- Move the map pointer to a different location, and press **ENTER**. The Weather From (New Location) Page opens with weather information for the selected location.
- Press **MENU**, highlight **Near Current Location**, and then press **ENTER** to return to the forecast for your current location.

SETTING UP AND USING SONAR

This section covers the additional sonar options for the GPSMAP 378/478 when used in conjunction with a GSD 21 Sounder Module. Read the *GSD 21 Sounder Module Installation Instructions* to properly install the sounder module. When you turn on your GPSMAP 378/478, the sounder module automatically turns on.



NOTE: You **MUST** have a GSD 21 installed and connected to your GPSMAP 378/478 to use the sonar features.

The Sonar Page is added to the end of the page sequence when you are in Marine Mode. To view the Sonar Page, press **PAGE** or **QUIT** repeatedly until it appears.

Showing Sonar on the Map Page

You can change the layout of the Map Page to view a split screen to show the sonar on the Map Page. You must be in Marine Mode to use sonar.

To show the Sonar Page on the Map Page:

1. Press and hold **PAGE/MODE**.
2. Highlight **Marine**, and press **ENTER**.
3. Press **PAGE** or **QUIT** to open the Map Page.

4. Press **MENU**. Highlight **Set Up Page Layout**, and press **ENTER**.
5. Highlight **Map with Sonar**, and press **ENTER**.

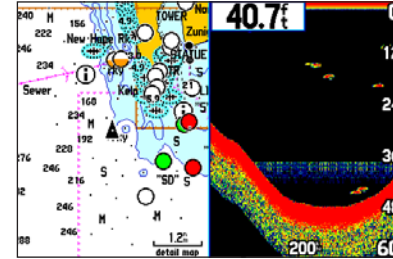

Map Page with Split Screen

To resize the Map Page sonar split screen:

1. After showing the Sonar and Map Pages together in the split screen as described in the previous steps, press **MENU**.
2. Highlight **Size Split**, and press **ENTER**.
3. Use the **ROCKER** to move the vertical double-arrow right or left.
4. Press **ENTER**.
5. To stop resizing the screen, press **QUIT**. You can also press **MENU**, highlight **Stop Resizing**, and press **ENTER** to stop resizing the screen and retain the previous split setting.

Using the Sonar Page

When combined with a GSD 21 Sounder Module, your GPSMAP 378/478 becomes a powerful fishfinder/flasher with the Sonar Page. If a GSD 21 is attached, but the unit does not detect a transducer, a “Sonar Turned Off” message appears across the Sonar Page. The Sonar Page appears only if a GSD 21 has ever been attached or when the unit is in Simulator Mode.

The middle of the page contains a right-to-left moving sonar image of the water beneath your boat. Items appear as they pass under your transducer. Those items on the right side of the screen are closer to you than those on the left. Along the right side of the screen is an adjustable scale that reflects the depth of the area being shown. The top left corner shows the adjustment option, the depth, and the water temperature.

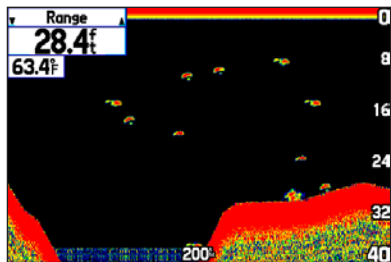

Sonar Page

The sonar returns show as red (strongest), then orange (strong), yellow (medium), green (weaker), and blue (weakest). The **Fish Symbols** option allows you to view the actual sonar data, a fish symbol or a combination of both. When the unit is set to **Dual**, the appearance of the fish symbols changes. Fish symbols from the center of the beam (200 kHz) are solid (or narrow arches), but the returns from the edges of the beam (50 kHz) are hollow (or wide arches).

The sonar display can also be set to show a split screen view of a zoomed portion of the sonar, bottom lock (display scaled from the bottom up), or a combination of these options. For example, you can choose to show dual frequency at a 2X zoom (Dual 2X) on one half and normal range dual frequency (Dual) on the other half. The current display mode appears at the bottom of each sonar display.

Read the “[Understanding Sonar](#)” section beginning on [page 112](#) for more on information about sonar.

Adjusting the Sonar Page

Use the Adjustment Menu to access the settings and features most commonly used on the Sonar Page. Ten main adjustment options are available: Range, Zoom, View, Gain, Target Level, Whiteline, Frequency, Depth Line, Noise Reject, and Scroll. The currently selected option appears in the upper-left corner.

To select an adjustment option:

Use one of the following methods to select an adjustment option:

- Press the **ROCKER** right or left to scroll through the adjustment options. When the adjustment option you want appears, press **ENTER**.
- Press **MENU**, highlight **Adjustments**, and press **ENTER**. Use the **ROCKER** to highlight the adjustment and press **ENTER**.

After you select an adjustment option, press the **ROCKER** up or down to change the setting.

You can also press **MENU** and highlight a shortcut setting to quickly change to commonly used settings and values.

Press **ENTER** to accept the new setting (or press **QUIT** to cancel) and return to the Sonar Page.

Sonar Adjustment Options

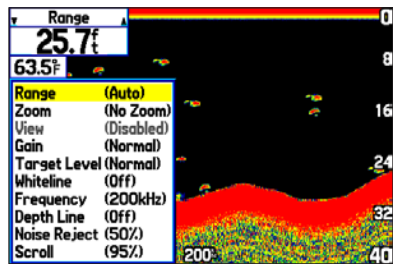

Scroll—adjusts the rate that the sonar display scrolls from right to left. If you are sitting still or the sonar display is moving too fast, slow the scroll rate or pause the scrolling.

Range—sets the display depth range used for viewing. The unit can be set to automatically track the bottom or set to a user-specified depth range.

Zoom—allows you to quickly select a display zoom scale or to split the display. When a scale other than **No Zoom** is selected, the Adjustment Menu shows a new selection labeled **View** or **Span**. The Zoom function is divided into six levels:

- **2X Split**—shows two reduced-size sonar pictures at the same time. The right half of the screen shows the complete sonar picture at its original scale. The left half shows a portion of the original picture at 1/2 depth scale.

- **2X Zoom**—shows the 2X zoomed picture on the full screen.
- **4X Split**—shows two reduced pictures, the right at the original depth scale and the left at 1/4 the original depth scale.
- **4X Zoom**—shows the 4X zoomed picture on the full screen.
- **Btm (Bottom) Split**—shows two reduced pictures, the right at the original depth scale and the left showing sonar returns from the bottom up. All target depths read as a distance from the bottom.
- **Btm (Bottom) Lock**—shows returns from the bottom up on the full screen.



TIP: Quickly zoom in and out of the Sonar display by pressing the **In** and **Out** keys. Turn off the zoom function by pressing the **Out** key until the **No Zoom** setting appears.

View/Span—changes the viewing range of a zoomed display. If the display is 2X or 4X split, only the zoomed portion on the left side of the display is affected by the change. If the display is Bottom Split or Bottom Lock, **Span** adjusts how far off the bottom the unit shows data. This option is available when a **Zoom** scale other than **No Zoom** is selected.

Gain—allows you to control the sensitivity of the unit’s receiver. To see more detail, increase the receiver sensitivity by selecting a higher gain. If there is too much detail select a lower gain.

Target Level—adjusts colors used to show sonar information. A **Color Bar** appears on the right side of the screen as you adjust this setting. A higher percentage results in more strong-signaled colors shown on the sonar display. A lower percentage results in more weaker-signaled colors shown on the sonar display. This setting does not increase or decrease the unit gain.

Whiteline—controls how the unit shows information about the bottom type (hard or soft). With Whiteline Off, the bottom return shows as red. Set Whiteline at **Normal** or **1–100%** to determine bottom hardness. See [page 114](#) for more information.

Frequency—allows you to choose a transducer frequency. Frequency refers to the “pitch” of the sound that the transducer sends and receives.

Depth Line—adds a horizontal depth line across the display that is used to measure the depth of underwater objects. The depth of the line appears in a box on the right side of the line. Press up or down on the **ROCKER** to move the line on the sonar display.

Noise Reject—helps filter unwanted noise from the sonar display. The Noise Reject can be turned **Off**, set to **Normal** (automatically adjusts for optimum viewing), or to a fixed **1–100%** setting. When setting the Noise Reject, remember that a higher noise rejection setting is less likely to show fish or structures.

Resizing the Split Screen

You can adjust the way the split screen appears. This option is only available when a zoom scale other than **No Zoom** is selected.

To resize the Sonar Page split screen:

1. From the Sonar Page split screen, press **MENU**.
2. Highlight **Size Split**, and press **ENTER**.
3. Move the horizontal double-arrow left or right using the **ROCKER** until the vertical width line shows, then press **ENTER**.
4. If you want to cancel this operation, press **QUIT** or press **MENU**, highlight **Stop Resizing**, and press **ENTER**.

Using the Pointer on the Sonar Page

You can show the pointer (arrow)  to reference sonar items and mark underwater waypoints. This makes it easier to find and use an object such as a stump for a future fishing location. When using this feature, the Sonar Page pauses. The depth continues to update while the display is paused, but the unit does not show any new sonar data until the Sonar Page resumes scrolling. You might see a discontinuity from where the sonar information stops and where it starts again.

To mark an underwater waypoint:

1. From the Sonar Page, press **MENU**, highlight **Show Pointer**, and press **ENTER**.
2. Use the **ROCKER** to move the pointer to the location you want to mark. Press **ENTER**. The New Map Waypoint Page opens.
3. To change the name, symbol or depth, highlight the appropriate field, and press **ENTER**. Make your changes, and press **ENTER**.
4. When you are done making changes, highlight **OK**, and press **ENTER**.
5. To return to the standard Sonar Page, press **QUIT**; or press **MENU**, highlight **Hide Pointer**, and press **ENTER**.

Setting Up Sonar

Use the Sonar tab on the Main Menu to set up the Sonar Page.

To access the Sonar Tab:

Highlight the **Sonar** tab on the Main Menu.

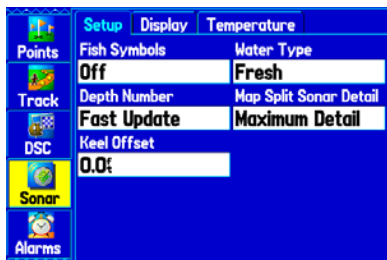

Main Menu—Sonar Tab

Fish Symbols—select how the Sonar Page shows underwater targets and background information. Select **Off** to show all of the available information about the underwater environment. Select a fish symbol to show only the information related to that symbol.

Water Type—select the proper water type you are boating in. Because sound waves travel through fresh and salt water at different rates, it is necessary to select the water type to ensure accurate readings on the unit.

Depth Number—select the efficiency of the digital depth update rate. **Fast Update** updates quicker and is recommended for low-noise water deeper than 50 feet. **Auto** is best for shallow water or high-noise areas, has a slower screen update, and is best used if you travel a wide variety of depths.

If the unit is unable to track the bottom for any reason, the digits in the depth window flash on and off to alert you that the unit is not tracking the bottom.

Map Split Sonar Detail—select how much detail appears on the Map Page with the sonar shown. **Full Range** shows data using the **Range** setting of the Sonar Page, regardless of **Zoom** or **Bottom Lock**. **Maximum Detail** shows any **Zoom** or **Bottom Lock** data from the Sonar Page.

Keel Offset—enter the surface reading for the depth of a keel. This makes it possible to measure depth from the bottom of your keel instead of from the transducer's location. Enter a positive number to offset for a keel. It is also possible to enter a negative number to compensate for a large vessel that can draw several feet of water. The **Keel Offset** is reflected in the depth reading.

Transducer—select the type of transducer that you are using. If you are using a speed-capable transducer/sensor, select **Temp, Spd**.

Calibrating the Water Speed

If you select **Temp, Spd** for the **Transducer** option on the Setup sub tab, you must calibrate the water speed to ensure the **Water Speed** shown on your unit is accurate. The calibration should take place in water having little or no current.

The unit automatically uses the GPS ground speed, if it is available, for comparison on the calibration. If a GPS ground speed is not available, use either your boat's speedometer reading (not always accurate) or a stopwatch to determine your speed over a certain distance. To find out your speed, divide the distance by the time.

To calibrate the water speed:

1. On the Setup sub tab of the Sonar tab, highlight the **Calibrate Water Speed** button, and press **ENTER**.
2. Bring the boat to a cruising speed. Both the top ground and uncalibrated water speeds are shown at the bottom of the calibration window. Note your top speed, then stop the boat, and press **ENTER**.

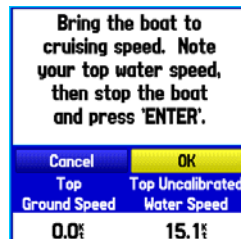

Calibrating the Water Speed

3. By default, the top ground speed is automatically shown. If a ground speed is not available, the top uncalibrated water speed is used instead. If the new speed is correct, highlight **OK**, and press **ENTER**.

If you want to manually enter a calibration, press **ENTER** while the speed is highlighted, enter a new speed, and press **ENTER** again.

If the boat is not moving fast enough or the speed sensor is not outputting a speed, "Boat Is Not Moving Fast Enough To Calibrate" appears at the bottom of the screen. Check that the speed sensor wheel is moving or safely increase boat speed. If there is a problem with the speed sensor or if a speed sensor is not installed, "Water Speed Sensor Is Not Working" appears at the bottom of the screen. Check connections of speed sensor cables.

Setting Up the Sonar Display

You can set up how the sonar information appears on-screen using the **Display** sub tab.

To access the Display sub tab:

1. Highlight the **Sonar** tab on the Main Menu.
2. Highlight the **Display** sub tab.

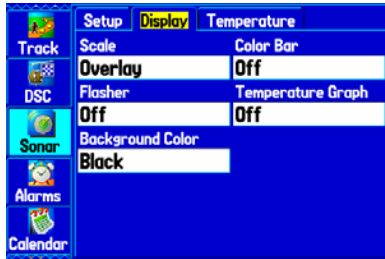

Display Sub Tab

Scale—select how and where you want the depth scale to appear.

Color Bar—select **On** to show a gradient scale of the current Target Level setting on the Sonar Page.

Flasher—select **On** to show a graphic flasher representation on the far right side of the sonar display. This graphic flasher shows structure and bottom returns much the same as a true flasher. You might find this feature useful when using fish symbols.

Temperature Graph—select **On** to show a temperature graph along the bottom of the Sonar Page.

Background Color—select the color for the Sonar Page and the sonar on the Map Split Page.

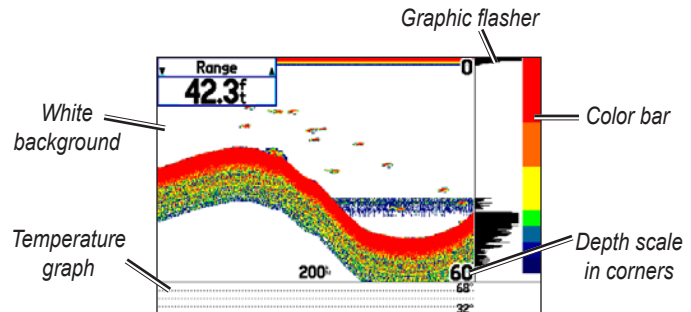

Sonar Page with the Sonar Display Settings Changed

Viewing the Temperature

Use the Temperature sub tab to view a graph of water temperature changes over a period of time. The graph reads from right to left so that the most recent temperature measured appears on the far right side of the graph. The dotted lines within the graph indicate intervals in the temperature scale and the duration of time. To view temperature information, you must select **Temp or Temp, Spd** as the transducer type on the Setup sub tab.



NOTE: You must be receiving proper sonar data from another device, such as Garmin GSD 21 Sounder Module, to view temperature information.

To access the Temperature sub tab:

1. Highlight the **Sonar** tab on the Main Menu.
2. Select the **Temperature** sub tab.

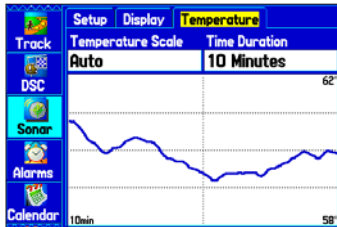

Temperature Sub Tab

Changing the Temperature Display

The graph will adjust and show the temperature changes according to the **Temperature Scale** and **Time Duration** settings.

Temperature Scale—select a degree span from the list. Select **Auto** to have the unit automatically determine the best range, or select a span of 2, 4, 6, 8, or 10 degrees.

Time Duration—set how fast or slow the temperature log scrolls; a shorter time duration means a faster temperature log scroll. Select a duration from 1 minute to 2.5 hours.

Resetting the Temperature Graph

To reset the scale range for the temperature graph, press **MENU**, highlight **Reset Auto Scale**, and press **ENTER**. This is useful when the scale spans a large range due to extreme temperature changes. You can reset the scale only when you select **Auto** for the **Temperature Scale**.

To restore the temperature graph to defaults, press **MENU**, highlight **Restore Default**, and press **ENTER**.

Understanding Sonar

The transducer mounted on your vessel transmits sound waves toward the bottom of the water in a cone-shaped pattern. When a transmitted sound wave strikes an underwater object—such as the bottom, a structure, or a fish—sound is reflected back to the transducer. The transducer collects the reflected sound waves and sends the data to the GSD 21 Sounder Module and then to the GPSMAP 378/478 to be processed and shown. The underwater data is shown on the Sonar display in the order that it is returned; first returned is the first on the display.

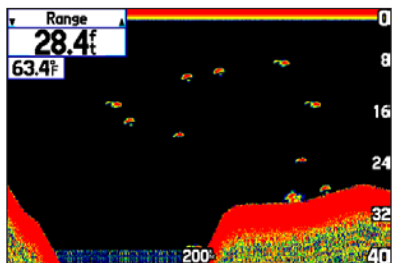

Sonar Page

Generally speaking, if the only thing between the transducer and the bottom is water, the first strong return comes from the bottom directly below the transducer and sets the bottom level. Weaker secondary returns provide the detailed data. Stronger returns appear in darker colors, with red being the strongest return.

Understanding the Sonar Display

One of the first things to understand about sonar is that the transducer sends a beam down to the bottom of the water, much like the beam of a flashlight. The beam starts small near your vessel and expands as it gets to the bottom. See “[Transducer Coverage](#)” for more detailed information.

The Sonar Page does not show a three-dimensional representation of the underwater environment; the display is in two-dimensions, much like if you took a picture of an aquarium. Only the depth of the item in the water appears. The Sonar display does not show you where an item is located horizontally in the water, as shown in the drawings below. The fish is not directly above the tree in reality, but it might look like it is on the Sonar Page.

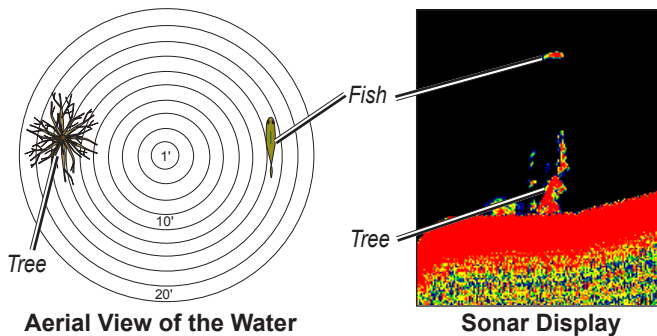

Aerial View of the Water

Sonar Display

Transducer Coverage

The area covered by the transmitted sound waves is determined by the cone angle of the transducer and the water depth. The wide cone angles (40°) associated with low frequencies (50 kHz) provide a large coverage area for finding fish within a coverage width that is approximately $2/3$ of the water depth. However, this also means that wide cone angles produce less bottom detail and resolution. As shown in the drawing on the near right, the 40° cone angle produces a coverage area of approximately a 20-foot diameter circle at a 30-foot depth.

The narrow cone angles (10°) associated with high frequencies (200 kHz) provide better bottom resolution and crisper detail, but cannot show a large coverage area for finding fish. The 10° cone angle provides a coverage width that is approximately $2/10$ of the water depth. As shown in the drawing on the far right, the 10° cone angle produces a coverage area of approximately a 6-foot diameter circle at a 30-foot depth.

Dual frequency mode combines both frequencies to get the best coverage area and contour/depth readings.

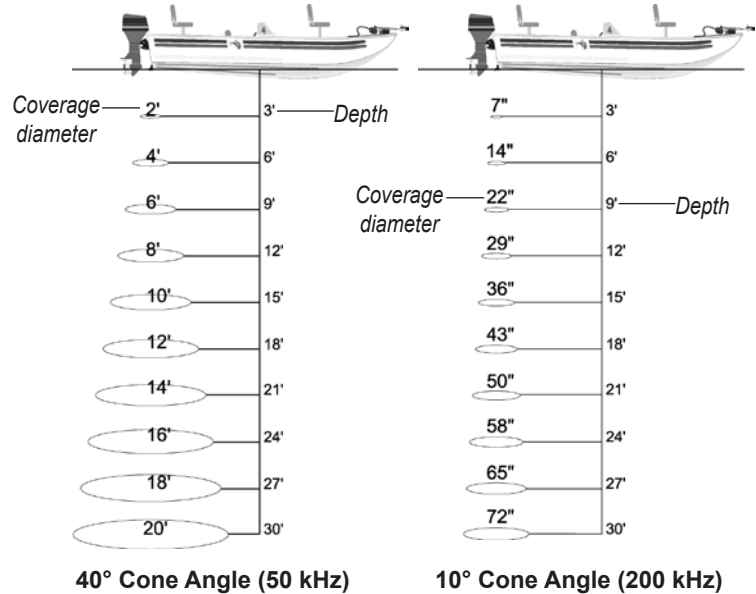

Whiteline

The GSD 21 Sounder Module can help you determine whether the bottom is hard or soft. When the sonar sound waves are reflected back by the bottom, a hard bottom returns a stronger signal than a soft bottom. A thin whiteline indicates a softer bottom, while a thick whiteline indicates a harder bottom. Normally, a red line is used to show the point where water meets the bottom. This line follows the bottom contour, along with any significant objects lying on the bottom. The unit uses the whiteline function to make the bottom layer information easier to distinguish.

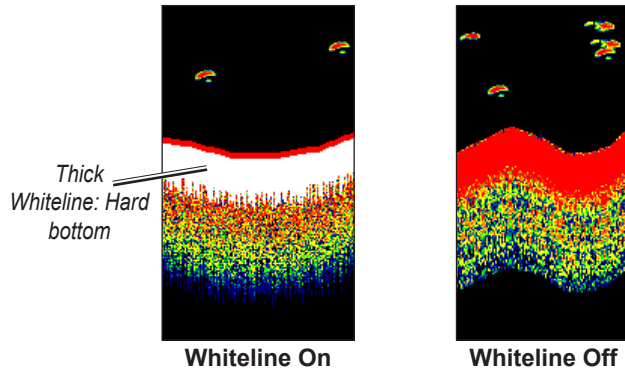

Thermoclines

A rough definition of a thermocline is a break in water where the water temperature changes faster than the water above it. Thermoclines are shown as the weakest colors.

One of the unique features offered by Garmin is See-Thru[®] technology, which allows the GPSMAP 378/478 to hear both weak and strong signals simultaneously so it can identify fish returns under the toughest conditions, such as suspended in thermoclines or even hiding near structures. See-Thru[®] technology allows the GSD 21 to “see” through thermoclines and helps locate fish where they live.

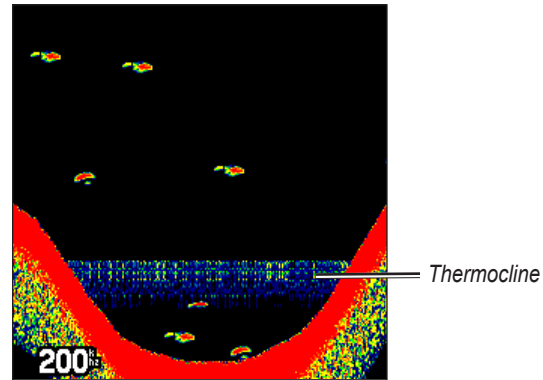

APPENDIX

Specifications

Physical Specifications

Size:	5.7" W x 3.2" H x 1.9" D (14.5 x 8.1 x 4.8 cm)
Weight:	14.0 oz (0.40 kg)
Display:	3.75" diagonal (9.5 cm) Transflective, 256-color display with backlighting (480 x 320 pixels)
Case:	Fully gasketed, high-impact plastic alloy, waterproof to IEC 60529 IPX7
Temp. Range:	5°F to 140°F (-15°C to 60°C)
Power	
Battery:	Rechargeable lithium-ion
Battery Life:	4 to 15 hours depending on the backlight setting and if you are using XM WX Weather or XM Radio the entire time.
Source:	11–35 VDC
Fuse:	3AG - 1.5 Amp

Performance

Receiver:	Differential-ready 12 parallel channel receiver
Acquisition Times:	Approximately 15 seconds (warm start) Approximately 45 seconds (cold start) Approximately 5 minutes (First Time/AutoLocate™)
Update Rate:	1/second, continuous
Accuracy	
GPS:	15 meters (49 feet) RMS 95% typical
DGPS (USCG):	3–5 meters (10–16 ft), 95% typical
DGPS (WAAS):	< 3 meters (10 ft) 95% typical with DGPS corrections
Velocity:	0.1 knot RMS steady state
Dynamics:	6 g's

Optional Accessories

In addition to the standard accessories included with your GPSMAP 378/478, several optional accessories are available to enhance the operation of the GPSMAP 378/478.

To obtain replacement parts and optional accessories, contact your Garmin Dealer, Garmin Product Support in the U.S.A. at 800/800.1020, or Garmin Europe at 44/0870.8501241.



WARNING: Garmin accessories have been designed and specifically tested for use with Garmin products. Accessories offered by other manufacturers have not been tested or approved for use with Garmin products. Use of such accessories could cause damage to the GPSMAP 378/478 and void the warranty.

GA 29, GA 29F, and GA 26C Antennas: Garmin remote antennas.

GXM 30: The XM antenna. See [page 137](#) for subscription information.

Non-Skid Friction Mount: Portable vehicle mount, no installation required.

Permanent and Temporary Adhesive Disks: Adhesive disks for using the unit in a vehicle.

PC Interface Cable: Connects the unit to a serial port on your computer.

Power/Data Cable: Allows you to connect the unit to the electrical system using bare wires.

Programmable Data Cards: Blank data cards available in 16 MB, 32 MB, 64 MB, 128 MB, 256 MB, and 512 MB sizes. Download detailed map data from MapSource CD-ROMs to a data card, either directly through your GPSMAP 378/478 using the PC USB cable, the optional PC Interface cable, or with the optional USB Data Card Programmer.

USB Data Card Programmer: Programs blank data cards at high speed through a computer.

Carrying Case: Protects the GPSMAP 378/478 when not in use; has storage space for data cards.

Protective Cover: Snaps on the front of the unit to protect the screen from damage.

MapSource Software CD-ROMs: Enhances the basemap and creates waypoints and routes from your computer. MapSource offers several detailed mapping options that are compatible with the GPSMAP 378/478. See www.garmin.com for more information

Pre-Programmed Data Cards: Data cards preprogrammed with BlueChart g2 or US Inland Lakes map data.

Installation Information

This section of the Appendix provides information on connecting the GPSMAP 378/478 to auxiliary devices and removing the antenna.

Connecting the Power/Data Cable

The power/data cable connects the GPSMAP 378/478 to an 11–35 VDC system and provides interface capabilities for connecting external devices. The color code in the diagram below and to the right indicates the appropriate harness connections. Replacement fuse is a 3AG - 1.5 Amp fuse.

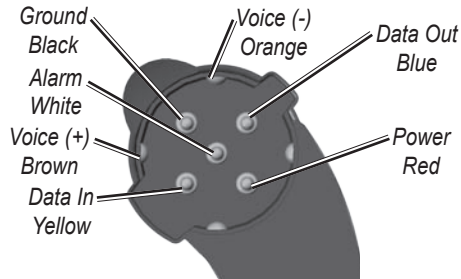

Power/Data Connector on the GPSMAP 378/478 Unit

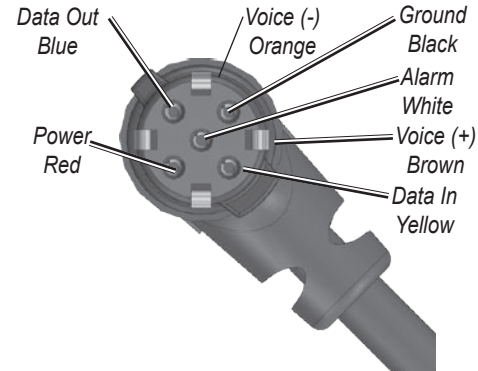

Power/Data Connector on the Cable

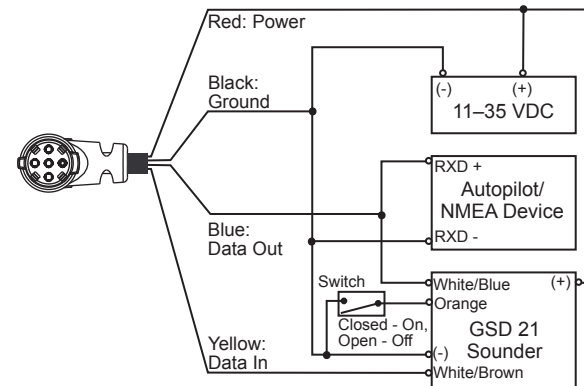

Connecting the Optional GXM 30 Antenna

Connect the optional GXM 30 antenna to the GPSMAP 378/478 to access XM WX satellite weather and XM Radio. For more information about the GXM 30 antenna, see the *GXM 30 Owner's Manual*.



NOTE: You must subscribe to XM Radio and/or XM WX Satellite Weather to use the XM Radio and/or XM Weather features on your GPSMAP 378/478.

To connect the GXM 30 antenna:

1. Position the antenna where it has a clear view of the sky. This can be on the outside of the vehicle or behind the windshield.
2. Plug the GXM 30 cable into the USB port on the back of the unit, as shown in the following illustrations.



GXM 30 Antenna Plugged In

Connecting Your GPSMAP 378/478 to a Computer

You can connect your GPSMAP 378/478 to your computer using the supplied USB cable to connect to a USB data port or the PC Interface cable to connect to a DB-9 serial communications port.



NOTE: Fully install the supplied MapSource program, Trip & Waypoint Manager, on your computer before connecting the USB cable to the computer.



USB connector/
GXM 30
Antenna
connector under
weather cap

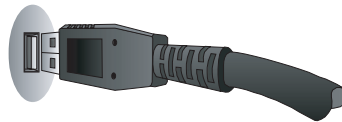

USB Data Port on Your PC



Serial Communications Port

To connect your GPS to your computer:

1. Connect the small end of your cable to the lower connector on the back of the GPSMAP 378/478, shown in the illustration to the left.
2. When using the supplied USB Data Cable, connect the larger end of the cable to an available USB data port (see the illustration on the left).

When using a PC Interface Cable, connect the larger end of the cable to a serial communications port on your computer (see illustration on the bottom left).

Information About USB Drivers

The USB drivers should have been automatically installed when you installed the MapSource program that came with your GPSMAP 378/478. When you initially connect the GPSMAP 378/478 to a USB port, your computer might prompt you to locate the destination of the drivers for the device. You only need to install the drivers once. After the drivers are installed, your computer will always detect your GPSMAP 378/478 when it is connected. USB drivers might be updated periodically. You can find these updates at www.garmin.com.

Using xImage for Customized Waypoint Icons

Use xImage to exchange images between your computer and your GPSMAP 378/478. You can download and save screenshots of any screen shown on your unit. xImage also allows you to download customizable splash screens and waypoint symbols from compatible GPS units, customize them (if you have an image editing program on your computer), and send them back to your GPS unit.

You can download xImage from the Garmin Web site at www.garmin.com/ximage/. See the Help file for complete instructions about using xImage.

Installing and Removing Data Cards

The GPSMAP 378/478 uses an optional Garmin data card to show digital charts and maps. Install the data card in the card slot located on the bottom of the unit. Install or remove the data card at any time, whether the unit is on or off.

You can load a variety of information on your data card, such as MapSource detailed maps. You can also buy preprogrammed cards to use with your GPSMAP 378/478.

Data cards are not waterproof, should not be exposed to moisture or excessive static charges, and should be stored in the case supplied with the card.

To install a data card:

1. Insert the card into the slot on the bottom of the unit. Be sure the label is facing the front of the unit.
2. Firmly push the card into the unit. It is not necessary to force the card. The handle is still exposed when it is properly inserted.
3. If the unit is on, a confirmation tone sounds. The first time you insert a programmed data card, the unit takes a few seconds to read the card. Once the data card has been properly installed and accepted, a summary screen noting the card details appears. Press **ENTER** to acknowledge.

If you insert a data card and get a card format not recognized message, try removing the card and reinserting it. If the card is still not recognized, contact Garmin or your Garmin dealer.

To remove a data card:

1. Grasp the card handle. The handle expands for easy removal.
2. Pull the card out of the card slot on the bottom of the unit.
3. If the unit is on, a confirmation tone sounds when the data card has been removed.

Interfacing

The following formats are supported for connection of external devices: GARMIN proprietary Differential GPS (DGPS), NMEA 0180, 0182, 0183 (versions 1.5, 2.0, 2.3, 3.01), ASCII Text Output, and RTCM SC-104 input (version 2.0).

The following are the Approved Sentences for NMEA 0183, version 3.01 output: GPRMC, GPGGA, GPGSA, GPGSV, GPGLL, GPBOD, GPRTE, and GPWPL. The following are the Proprietary Sentences for NMEA 0183, version 3.01 output: PGRME, PGRMZ, and PGRMM.

The GPSMAP 378/478 also includes NMEA input with support for the BWC, DBT, DPT, DSC, DSE, MTW, VHW, VTG, and XTE sentences.

Garmin's proprietary communication protocol is available from the Web site (www.garmin.com).

Removing the GPS Antenna

You can remove the GPS antenna to use an external antenna. After the antenna is removed, the BNC connector is exposed and ready for use with an external antenna. For information on connecting an external antenna to the GPSMAP 378/478, refer to the installation instructions that came with the antenna.

To remove the GPS antenna:

1. Remove the external power cable from the connector on the back of the GPSMAP 378/478.
2. Rotate the antenna to approximately a seven o'clock position. The alignment notches in the casing must line up with the notches on the antenna.
3. Pull the antenna away from the GPSMAP 378/478 unit.

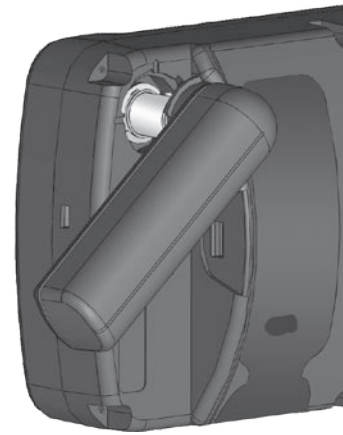

Removing the GPS Antenna

Satellite Information

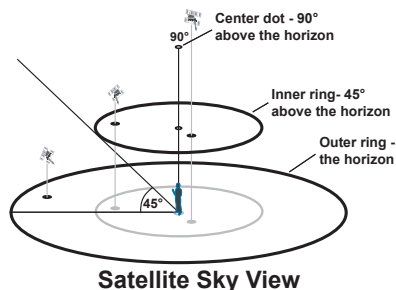

Satellite Location

The location of each available satellite is shown over two location rings on the Satellite Information Page. The outer ring represents the horizon, the inner ring represents 45° above the horizon, and the center represents directly overhead. When the unit is using a satellite for navigation, the satellite number is highlighted on the location rings. The unit can show satellite location with North or your current track at the top of the display.

Satellite Strength Indicator Bars

The Satellite Strength Indicator Bars show the strength of the signal being received and the status of the signal. The bars are either shaded or filled. A hollow gray bar means the unit is in the process of storing orbital data it is receiving from the satellite signal. When the bar turns solid green, the unit is using the satellite signal for navigation. A “D” in or above the bar means differential corrections (WAAS or DGPS) are being applied to that satellite.

Date, Time, and Current Location

The unit gets date and time information from the satellite’s on-board atomic clock. When the unit has achieved a 2-D or 3-D GPS location, the current location is shown in the location format you have selected.

What is Differential GPS (DGPS)?

The United States and Canadian governments (among others) have set up Differential GPS (DGPS) stations to transmit correction signals. They are operational in coastal areas and on many navigable river systems.

The DGPS system is available for use without a fee, but you do need additional equipment to receive DGPS signals; a beacon receiver compatible with the RTCM format sentences supported by your Garmin GPS is needed to use DGPS.

Refer to the United States Coast Guard’s Web site (www.navcen.uscg.gov/) for locations and status of the differential stations.

Differential Field

Differential receiver status is indicated in the bottom left field of the GPS tab and will show one of the following conditions:

- **None**—no optional beacon receiver is attached or enabled in the Interface sub tab on the Main Menu—Setup tab or WAAS is disabled.
- **Searching for WAAS**—WAAS is enabled and the receiver is searching for WAAS signal.

- **Using WAAS**—WAAS capability is enabled and the unit is receiving WAAS corrections.
- **Check Beacon Wiring**—the DGPS setting is enabled in the Interface sub tab on the Main Menu—Setup tab but no DGPS device is detected.
- **No Beacon Signal**—DGPS receiver is attached, but not transmitting RTCM data to GPS.
- **Tuning Beacon**—the receiver is tuning manually to a DGPS frequency.
- **Using Differential**—the unit is receiving DGPS corrections.
- **Scanning for Beacon**—the DGPS receiver is scanning for an available frequency.

What is WAAS/EGNOS?

The Wide Area Augmentation System (WAAS) is an FAA-funded service to improve the overall integrity of the GPS signal and increase position accuracy for users in North America. In Europe, WAAS is referred to as EGNOS.

The system is made up of satellites and approximately 25 ground reference stations positioned across the United States that monitor GPS satellite data. Two master stations, located on either coast, collect data from the reference stations and create a GPS data correction message.

According to the FAA's Web site, testing in September 2002, WAAS confirmed an accuracy performance of 1–2 meters horizontal and 2–3 meters vertical throughout the majority of the continental United States and portions of Alaska.

WAAS is just one service provider that adheres to the Minimum Operational Performance Standard (MOPS) for global Satellite Based Augmentation Systems (SBAS). Eventually, there will be several services of worldwide geostationary communication satellites and ground reference stations.

All SBAS systems use the same receiver frequency; therefore any operational SBAS system should be capable of providing your GPS unit with increased accuracy at any location in the world.

Currently, enabling WAAS on your Garmin GPSMAP 378/478 in regions that are not supported by ground stations might not improve accuracy, even when receiving signals from an SBAS satellite. In fact, it can degrade the accuracy to less than that provided by GPS satellites alone. For this reason, when you enable WAAS on your Garmin GPS receiver, the receiver automatically uses the method that achieves the best accuracy. To enable WAAS, see page 6.

For more information, go to <http://gps.faa.gov>.

LORAN TD Setup

LORAN C is a radio navigation aid operated and maintained in the United States by the United States Coast Guard. LORAN (LONg RANge Navigation) system covers the entire United States and the U.S. Coastal Confluence Zone. From the perspective of a mariner, the system is used for ocean and coastal navigation. It can be used as a supplemental system for harbor and harbor approach navigation, and it is used for inland navigation by recreational vehicles.

LORAN TD Feature

The LORAN TD (Time Delay) feature eases the transition from using LORAN to using GPS. The GPSMAP unit automatically converts GPS coordinates to LORAN TDs for those who have a collection of LORAN fixes for favorite fishing spots and other waypoints recorded as TDs. You can show your location as a TD or enter waypoints as TDs. The accuracy to be expected from this conversion is approximately 30 meters. When the unit is placed in the LORAN TD format mode, it simulates the operation of a LORAN receiver. Position coordinates might be shown as TDs, and all navigation functions can be used as if the unit was actually receiving LORAN signals.

Using the LORAN TD Format

When creating new waypoints using LORAN TD coordinates, you must set the correct LORAN chain number and secondary stations in the **Setup TD** field before storing the waypoint. After the waypoint is stored in the unit's memory, it will always reference the LORAN chain number and secondary stations currently selected in the **Setup TD** field. If you enter a different LORAN chain number or change the secondary stations or offsets in the Setup TD field, the active waypoint information will reflect those changes. Because the GPSMAP 378/478 does not rely on the LORAN signal for navigation, it can reference a different GRI chain and/or secondary stations and still navigate to the location stored in memory.

The LORAN Location Format field is located on the Location sub tab of the Setup tab on the Main Menu. The LORAN TD Setup window contains the fields to select the Loran GRI-Chain Number, Primary and Secondary Stations, and TD Offsets.

To set up Loran TD from the Main Menu:

1. Highlight the **Setup** tab on the Main Menu, and then highlight the **Location** sub tab.
2. Highlight the **Location Format** field and press **ENTER**.

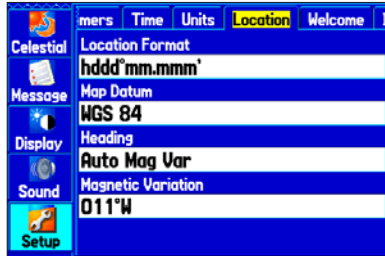

Location Sub Tab

3. Highlight **Loran TD**, and press **ENTER**.
4. Highlight the **Setup** button located on the right side of the **Location Format** field and press **ENTER**. The Loran TD Setup window appears.
5. To change the settings of any of the five fields, highlight the field, press **ENTER**, select a setting, and press **ENTER** again.

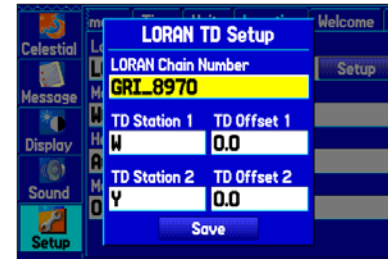

LORAN TD Setup

6. When finished, highlight the **Save** button, and press **ENTER**.
If the active GRI Chain, secondary stations, or offsets were changed since the waypoint was created, the waypoint now references the active GRI chain and secondary stations and adjusts the TD coordinates accordingly. Remember that the GPS is not relying on the LORAN signal for navigation and actually converts the TD coordinate to a useful latitude and longitude coordinate before storing the waypoint to memory or using it for navigation. Because of this, the unit can navigate to a TD coordinate anywhere in the world.

For more information on LORAN TDs, you can download the *LORAN TD Position Format Handbook* from the Garmin Web site.

Map Datums and Location Formats

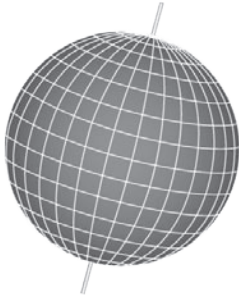

Map Datums are based on a mathematical model of the Earth.

What Are a Map Datums?

A datum is a mathematical model of the Earth that approximates the shape of the Earth and enables calculations to be carried out in a consistent and accurate manner. The datum is physically represented by a framework of ground monuments whose positions have been accurately measured and calculated on this reference surface. Lines of latitude and longitude on a map or chart are referenced to a specific map datum. Every chart has a map datum reference, and you can set the GPSMAP 378/478 to match most of those commonly used.

If you are navigating and comparing the GPS coordinates to a map, chart, or other reference, set the map datum in the GPS unit to the same datum as the map to ensure the most accurate navigation.

What is a Location Format?

Your current location can be viewed on the GPS in the form of coordinates. Because different maps and charts use different location formats, Garmin GPS units allow you to choose the correct coordinate system for the type of map you are using. The most common format is latitude and longitude, which is used by all Garmin units.

You can choose to change the location format to use with other coordinate systems in the Location field of the Setup tab—Location sub tab. UTM/UPS (Universal Transverse Mercator/Universal Polar Stereographic) are easy-to-use metric grids that are found on most USGS topographic quadrangle maps. You can also select one of several other grids, including a user-definable grid (for the advanced user).

For more information about using paper maps with your Garmin unit, refer to *Using a Garmin GPS with Paper Land Maps*, available for download at www.garmin.com/manuals/UsingGarminGPSwithPaperLandMaps_Manual.pdf.

Digital Selective Calling (DSC)

DSC uses marine VHF radio GPS technologies to transmit and receive location information. DSC is used by mariners to assist them in two major areas: distress calls and position reporting.

A non-emergency DSC position report allows mariners to exchange and show the positions of one another. When you receive a DSC position, you can create a waypoint or to show the received position on an electronic map.

An emergency DSC Distress Call allows a vessel in trouble to transmit a substantial amount of information in a single transmission, or “call,” without the need for voice communication. When any nearby rescuer receives the DSC signal, an alarm sounds, and they immediately receive the position of the caller.

The rescuer can then choose to navigate (Go To) the caller’s position to assist or forward the call on to the Coast Guard. When the Coast Guard receives the call, they can immediately access the caller’s information (such as who they are and the type of vessel) in their database while they are in transit to the caller’s location.

Any time a vessel receives a DSC call, the vessel can store that location and quickly navigate to that position using a Go To. This makes DSC a time-saver, especially in an emergency situation. To use DSC, users must first register their VHF radio with the FCC and receive a Maritime Mobile Service Identity (MMSI) number.

What is a Maritime Mobile Service Identity (MMSI) Number?

MMSI basically allows a VHF radio to act like a phone. The 9-digit MMSI number acts like a phone number when used in a position report and as a unique identifier to the Coast Guard when used in an emergency distress call. To obtain a MMSI number, users must register their VHF radio with the FCC (Form 605). **Garmin does not supply this number!**

For more information regarding MMSI numbers, visit www.navcen.uscg.gov/marcomms/gmdss/mmsi.htm.

How Are MMSI Assignments Obtained?

Non-commercial users, such as recreational users, who remain in United States waters and only carry VHF, EPIRB (Emergency Position Indicating Radio Beacons), and Radar are not required to have a FCC ship station license. The FCC and Coast Guard have authorized some second and third-party vendors to assign MMSI numbers. This service is limited to registering recreational vessels only. To receive information on how to obtain a recreational MMSI number, contact <http://www.uscg.mil/rescue21/links/mmsi.htm> or <http://wireless.fcc.gov/marine/>.

Non-Federal Users in the United States

Commercial users, or those who travel outside the United States or Canada, must apply for a ship station license or an amendment to a ship station license. To find out if you require a Ship Station license, visit <http://wireless.fcc.gov/marine/fectsht14.html>. If your vessel requires licensing by the FCC, you can obtain a MMSI during the application/licensing process when you file FCC Forms 159 and 605.

Federal Users in the United States

Federal users can obtain MMSI assignments from their agency radio spectrum management office. These procedures are currently under review by the National Telecommunications and Information Administration (NTIA).

Users Outside the United States

Users can obtain an MMSI assignment from their telecommunications authority or ship registry, often by obtaining or amending their ship station license.

Users In Canada

Industry Canada is responsible for assigning MMSI numbers to commercial and recreational vessels. Information is available at the following Web site: <http://apollo.ic.gc.ca/english/mmsi.html>.

How Can Garmin Help You with DSC?

To receive distress calls or position reports, you must have a DSC-equipped chartplotter as well as a VHF radio with DSC support. During normal, non-emergency position report communication, Channel 70 (156.525 MHz) has been set aside as the VHF/DSC digital call channel.

For a distress call, press the MayDay button on the VHF radio. The call transmits on an emergency channel with the MMSI number attached to the call, if the receiver has DSC support. Any DSC-equipped mariner (on sea or land) within range can receive the call.

When the GPSMAP 378/478 is connected to a VHF with DSC support, the GPS unit shows a call list, log, and a directory. Basic wiring is required for the Garmin unit and VHF radio to send and receive NMEA data from each other.

Messages

Accuracy Alarm—the GPS accuracy has fallen outside of user-set value.

Alarm Clock—the alarm clock has sounded.

Antenna Shorted to Ground—the external GPS antenna has an electrical connection problem. Contact Garmin Product Support.

Approaching Turn—you are nearing a turn in a route.

Arriving at Destination—you are nearing your destination.

Batteries Low—the battery needs to be recharged.

Basemap Failed Unit Needs Repair—there is an internal problem with your unit. Contact Garmin Product Support to have the unit serviced.

Boat Is Not Moving Fast Enough to Calibrate—the boat is not moving fast enough for the speed wheel to provide a valid speed.

Can't Unlock Maps—no applicable unlock code for one or more maps was found. All MapSource maps are not accessible.

Check XM Antenna—internal problem with your GXM 30 antenna. Contact Garmin Product Support.

Database Error—internal problem with the unit. Contact your dealer or Garmin Product Support to have the unit repaired.

Deep Water—the water is deeper than the amount set in the Deep Water Alarm.

Detail Maps Don't Support Routing—maps that are loaded on the data card do not support automatic route calculation.

Distress Call—a DSC distress call was received. Take appropriate action.

Dragging Anchor—the distance set in the Anchor Drag Alarm was exceeded.

Drift Alarm—the water depth has changed by the amount entered in the Drift Alarm setup.

Fish Alarm—a fish was detected. The unit shows an icon and beeps (if enabled). This alarm does not show a message banner.

Flash Flood Warning—a flash flood warning was issued for the area by the National Weather Service.

Flood Warning—a flood warning was issued for the area by the National Weather Service.

Lost Satellite Reception—the unit is unable to receive satellite signals.

Marine Warning—a marine warning was issued by the National Weather Service.

Memory Full—unit memory is full, no further data can be saved.

Memory (RAM) Failed Unit Needs Repair—there is an internal problem with your unit. Contact Garmin Product Support to have the unit serviced.

Memory (ROM) Failed Unit Needs Repair—there is an internal problem with your unit. Contact Garmin Product Support to have the unit serviced.

Near Proximity Point—you have reached the distance set for a proximity waypoint.

NMEA Depth is Below Transducer—no keel offset value has been received from the external sonar device.

No Diff GPS Location—RTCM is selected but the unit is not receiving DGPS data.

No Roads Near Destination—the destination for the road route you tried to calculate is not near any roads. Select a different destination.

No Roads Near Starting Point—the start location for the road route you tried to calculate is not near any roads. Select a different start location.

No DGPS Position—no differential connection data is available, or not enough data is available to calculate a DGPS position.

No Tide Stations for that Area—no tide stations within 100 miles of the area.

No XM Signal—the GXM 30 antenna is not receiving an XM signal.

None Found—no data matched the search criteria.

Off Course—you are off course by the distance set in the Off Course Alarm.

Proximity Memory Full—no additional proximity waypoints can be saved.

Proximity Radius Overlaps—the radius of two proximity waypoints overlap.

Route Already Exists—you have entered a route name that already exists.

Route Calculation Error—no route can be calculated.

Route Memory Full—no additional routes can be saved.

Route Truncated—uploaded route from another device has more than 300 waypoints.

Route Waypoint Memory Full—no additional route waypoints can be saved.

Saving XM Program Information—an XM Radio channel lineup change has occurred and the unit is saving the channel lineup to memory.

Shallow Water—the water is shallower than the amount set in the Shallow Water Alarm.

Sonar Failed Unit Needs Repair—there is an internal problem with the unit. Contact Garmin Product Support to have the unit serviced.

Sunrise, Switching to Day Mode—the unit is switching to Day Mode.

Sunset, Switching to Night Mode—the unit is switching to Night Mode.

Thunderstorm Warning—a severe thunderstorm warning was issued for the area by the National Weather Service.

Tornado Warning—a tornado warning was issued for the area by the National Weather Service.

Track Already Exists—a saved track with the same name already exists.

Track Log Full—the track log is full and track recording was turned off. To record more track points, you need to clear the track log and turn track recording on.

Track Memory Full—no more track data can be stored. Delete the old track data to store the new data.

Track Truncated—a complete uploaded track will not fit in memory. The oldest track log points have been deleted.

Transducer Disconnected, Sonar Turned Off—the unit has no transducer attached, has a bad cable/transducer, or has a disconnected transducer cable.

Transfer Complete—data transfer was completed.

USB Connected—the USB cable was recently plugged in.

User Timer Expired—the Timer Alarm value has counted down to zero.

Water Speed Sensor is Not Working—the speed sensor is not detected. Check the connections.

Water Temperature Alarm—sonar has reported a temperature above, below, inside, or outside the specified value(s).

Waypoint Already Exists—a waypoint with the same name already exists.

Waypoint Memory Full—the unit has stored the maximum number of waypoints.

XM Connected—the GXM 30 antenna was recently plugged in.

Data Field Options

The following list provides a brief description of each data field option. Some of these options are supported only by devices interfaced to your GPSMAP 378/478.

Accuracy—the current accuracy of your GPS-determined location.

Battery Timer—the time remaining on the battery before it is fully discharged.

Bearing—the compass direction from your current location to a destination.

Course—the desired path of travel from your starting location to a destination.

Course to Steer—the recommended direction to steer in order to reduce cross-track error and return to the course line. Shown as **Steer**.

Cross Track—the distance you are off a desired course in either direction, left or right.

Depth (Marine Only)—the depth of water from sonar NMEA input.

Dest Wpt—see **Waypoint (Destination)**.

Distance (Destination)—the entire distance of a route, from beginning to end.

Distance (Next)—the distance to the next point on a route.

ETA (Destination)—Estimated Time of Arrival. The estimated time you will reach your destination.

ETA (Next)—Estimated Time of Arrival. The estimated time you will reach the next point on your route.

ETE (Destination)—Estimated Time Enroute. The estimated time required to reach your destination.

ETE (Next)—Estimated Time Enroute. The estimated time required to reach the next point on your route.

Elevation—the altitude (height) above or below mean sea level (MSL).

GPS Status—the current status of the GPS receiver, such as “3D GPS.”

Location (Lat/Lon)—your current location as latitude/longitude coordinates.

Location (Selected)—your current location described in the selected units of measure (other than lat/lon).

Max Speed—the maximum speed the unit has moved since last reset.

Mov Avg Spd—see **Trip Avg. Speed (Moving)**.

Move Timer—see **Trip Timer (Moving)**.

Next Course—the course your route will take you on after you reach the next waypoint.

Next Turn—the direction of the next turn on an active route.

Next Wpt—see **Waypoint (Next)**.

Odometer—the total distance traveled since the odometer was reset.

Pointer—the arrow indicating the direction to travel to the next point on a route.

Power—the power indicator icon: Battery, External Power, or Charging.

Speed—your current vehicle speed can be measured in miles per hour, kilometers per hour, or knots.

Steer—see **Course to Steer**.

Sunrise—the time at which the sun rises on this day.

Sunset—the time at which the sun sets on this day.

Time—the current time and date. It can be shown in 12-hour or 24-hour format in local time or universal (UTC) time.

Track—the direction of movement relative to a ground position. Also referred to as ground track.

Trip Avg. Speed (Moving)—the average speed while moving since the last reset of the trip computer. Appears as **Mov Avg Spd**.

Trip Avg. Speed (Total)—the total average speed traveled since the last reset of the trip computer. Appears as **Ttl Avg Spd**.

Trip Odometer—the total distance traveled since the trip computer was reset.

Trip Timer (Moving)—the length of time your vehicle has been in motion, since the trip computer was reset. Appears as **Move Timer**.

Trip Timer (Total)—the total time the unit has been tracking since the trip computer was reset.

Ttl Avg Spd—see **Trip Avg. Speed (Total)**.

Turn—the distance between Bearing (BRG) and Track (TRG). L indicates you should turn left. R indicates you should turn right. The degrees indicates the difference angle and the number of degrees you should turn.

User Timer—the timer you set on the Main Menu.

Velocity Made Good—the rate of closure on a destination based on your current speed and course of travel. Appears as **VMG**.

Vertical Speed—the rate of climb or descent.

Voltage—the direct current voltage level of an external power source.

Water Speed (Marine Only)—the data acquired from measurement devices interfaced to the unit is used to calculate your current speed over water.

Water Temperature (Marine Only)—the temperature of water at a measured depth using measurement devices interfaced to the unit.

Waypoint (Destination)—the last point on a route, your destination. Appears as **Dest Wpt**.

Waypoint (Next)—the next waypoint in your route. Appears as **Next Wpt**.

Weather–Dew Point—the dewpoint at the nearest weather reporting station.

Weather–Pressure—the surface pressure at the nearest weather reporting station.

Weather–Relative Humidity—the relative humidity at the nearest weather reporting station.

Weather–Temperature—the temperature at the nearest weather reporting station.

Weather–Wind—the wind speed and direction at the nearest weather reporting station.

XM Audio—the artist and song title of the XM audio channel currently playing.

XM Signal—the strength of the XM signal.

Software License Agreement

BY USING THE GPSMAP 378/478, YOU AGREE TO BE BOUND BY THE TERMS AND CONDITIONS OF THE FOLLOWING SOFTWARE LICENSE AGREEMENT. PLEASE READ THIS AGREEMENT CAREFULLY.

Garmin grants you a limited license to use the software embedded in this device (the “Software”) in binary executable form in the normal operation of the product. Title, ownership rights, and intellectual property rights in and to the Software remain in Garmin.

You acknowledge that the Software is the property of Garmin and is protected under the United States of America copyright laws and international copyright treaties. You further acknowledge that the structure, organization, and code of the Software are valuable trade secrets of Garmin and that the Software in source code form remains a valuable trade secret of Garmin. You agree not to decompile, disassemble, modify, reverse assemble, reverse engineer, or reduce to human readable form the Software or any part thereof or create any derivative works based on the Software. You agree not to export or re-export the Software to any country in violation of the export control laws of the United States of America.

Product Registration

Help us better support you by completing our online registration today. Go to <http://my.garmin.com>. Keep the original sales receipt, or a photocopy, in a safe place.

Serial Number: ____ _

Contact Garmin

Contact Garmin Product Support if you have any questions while using your GPSMAP 378/478. In the USA, go to www.garmin.com/support, or contact Garmin USA by phone at (913) 397.8200 or (800) 800.1020.

In the UK, contact Garmin (Europe) Ltd. by phone at 0808 2380000.

In Europe, go to www.garmin.com/support and click **Contact Support** for in-country support information, or contact Garmin (Europe) Ltd. by phone at +44 (0) 870.8501241.

Limited Warranty

This Garmin product is warranted to be free from defects in materials or workmanship for one year from the date of purchase. Within this period, Garmin will, at its sole option, repair or replace any components that fail in normal use. Such repairs or replacement will be made at no charge to the customer for parts or labor, provided that the customer shall be responsible for any transportation cost. This warranty does not cover failures due to abuse, misuse, accident, or unauthorized alteration or repairs.

THE WARRANTIES AND REMEDIES CONTAINED HEREIN ARE EXCLUSIVE AND IN LIEU OF ALL OTHER WARRANTIES EXPRESS, IMPLIED, OR STATUTORY, INCLUDING ANY LIABILITY ARISING UNDER ANY WARRANTY OF MERCHANTABILITY OR FITNESS FOR A PARTICULAR PURPOSE, STATUTORY OR OTHERWISE. THIS WARRANTY GIVES YOU SPECIFIC LEGAL RIGHTS, WHICH MAY VARY FROM STATE TO STATE.

IN NO EVENT SHALL GARMIN BE LIABLE FOR ANY INCIDENTAL, SPECIAL, INDIRECT, OR CONSEQUENTIAL DAMAGES, WHETHER RESULTING FROM THE USE, MISUSE, OR INABILITY TO USE THIS PRODUCT OR FROM DEFECTS IN THE PRODUCT. Some states do not allow the exclusion of incidental or consequential damages, so the above limitations may not apply to you. Garmin retains the exclusive right to repair or replace the unit or software or offer a full refund of the purchase price at its sole discretion. SUCH REMEDY SHALL BE YOUR SOLE AND EXCLUSIVE REMEDY FOR ANY BREACH OF WARRANTY.

To obtain warranty service, contact your local Garmin authorized dealer or call Garmin Product Support for shipping instructions and an RMA tracking number. Securely pack the unit and a copy of the original sales receipt, which is required as the proof of purchase for warranty repairs. Write the tracking

number clearly on the outside of the package. Send the unit, freight charges prepaid, to any Garmin warranty service station.

Online Auction Purchases: Products sold through online auctions are not eligible for rebates or other special offers from Garmin. Online auction confirmations are not accepted for warranty verification. To obtain warranty service, an original or copy of the sales receipt from the original retailer is required. Garmin will not replace missing components from any package purchased through an online auction.

International Purchases: A separate warranty is provided by international distributors for units purchased outside the United States. This warranty is provided by the local in-country distributor and this distributor provides local service for your unit. Distributor warranties are only valid in the area of intended distribution. Units purchased in the United States or Canada must be returned to the Garmin service center in the United Kingdom, the United States, Canada, or Taiwan for service.

Garmin International, Inc.
1200 East 151st Street,
Olathe, Kansas 66062, USA
Tel. (913) 397-8200 or
(800) 800-1020
Fax (913) 397-8282

Garmin (Europe) Ltd.
Liberty House,
Hounslow Business Park,
Southampton, Hampshire, SO40 9RB UK
Tel. +44 (0) 870.8501241 (outside the UK)
0808.2380000 (within the UK)
Fax +44 (0) 870.8501251

Garmin Corporation
No. 68, Jangshu 2nd Road,
Shijr, Taipei County, Taiwan
Tel. 886/2.2642.9199
Fax 886/2.2642.9099

Weather Data Warranty

THE WEATHER DATA SOFTWARE PRODUCT IS PROVIDED “AS IS.” ALL OTHER WARRANTIES, EXPRESSED OR IMPLIED, INCLUDING ANY WARRANTY OF MERCHANTABILITY OR FITNESS FOR A PARTICULAR PURPOSE OR OF NON-INFRINGEMENT ARE HEREBY EXCLUDED.

USER SAFETY

If you use XM Services it is your responsibility to exercise prudent discretion and observe all safety measures required by law and your own common sense. You assume the entire risk related to your use of the Services. XM and Garmin assume no responsibility for accidents resulting from or associated with use of the Services. Your Radio Service includes traffic and weather information, and you acknowledge that such information is not for “safety for life”, but is merely supplemental and advisory in nature, and therefore cannot be relied upon as safety-critical in connection with any aircraft, sea craft or automobile usage. This information is provided “as is” and XM and Garmin disclaim any and all warranties, express and implied, with respect thereto or the transmission or reception thereof. XM and Garmin further do not warrant the accuracy, reliability, completeness or timeliness of the traffic and weather information disclosed on the Radio Service. In no event will XM and Garmin, their data suppliers, service providers, marketing/distribution, software or Internet partners or hardware manufacturers be liable to you or to any third party for any direct, indirect, incidental, consequential, special, exemplary or punitive damages or lost profits resulting from use of or interruptions in the transmission or reception of the Services.

LIMITS ON OUR RESPONSIBILITY

a) DISCLAIMERS.

EXCEPT AS EXPRESSLY PROVIDED HEREIN, WE MAKE NO WARRANTY OR REPRESENTATION, EITHER EXPRESS OR IMPLIED, REGARDING THE RADIO SERVICE. YOUR USE OF THE SERVICE IS AT YOUR SOLE RISK. THE CONTENT AND FUNCTIONALITY OF THE SERVICE IS PROVIDED “AS IS” WITHOUT ANY WARRANTY OF ANY KIND, EXPRESS OR IMPLIED. ALL SUCH WARRANTIES OR REPRESENTATIONS (INCLUDING, WITHOUT LIMITATION, THE IMPLIED WARRANTIES OF MERCHANTABILITY, FITNESS FOR A PARTICULAR PURPOSE, TITLE AND NON-INFRINGEMENT) ARE HEREBY DISCLAIMED.

b) LIMITATIONS OF LIABILITY.

WE ARE NOT RESPONSIBLE FOR ANY SPECIAL, INCIDENTAL, OR CONSEQUENTIAL DAMAGES OR LOSSES RELATING TO THE USE OF THE RADIO SERVICE, WHETHER BASED ON NEGLIGENCE OR OTHERWISE. OUR TOTAL LIABILITY TO YOU AND ANY OTHER PERSONS RECEIVING OUR SERVICES, REGARDLESS OF THE CAUSE, WILL IN NO EVENT EXCEED THE AMOUNTS THAT YOU HAVE PAID TO US FOR THE SERVICE THAT YOU RECEIVED DURING THE SIX (6) MONTH PERIOD IMMEDIATELY PRIOR TO THE SPECIFIC EVENT THAT GAVE RISE TO THE APPLICABLE DAMAGE OR LOSS. THIS ALLOCATION OF RISK IS REFLECTED IN OUR PRICES. YOU MAY HAVE GREATER RIGHTS THAN DESCRIBED ABOVE UNDER YOUR STATE’S LAWS.

This product was developed using DAFIF™, a product of the National Geospatial-Intelligence Agency.

This product has not been endorsed or otherwise approved by the National Geospatial-Intelligence Agency, or the United States Department of Defense (10 U.S.C. 425)

a. Under 10 U.S.C. 456, no civil action may be brought against the United States on the basis of the content of a navigational aid prepared or disseminated by either the former Defense Mapping Agency (DMA), National Imagery and Mapping Agency (NIMA), or the National Geospatial-Intelligence Agency (NGA).

b. The DAFIF™ product is provided “as is,” and no warranty, express or implied, including, but not limited to the implied warranties of merchantability and fitness for particular purpose or arising by statute or otherwise in law or from a course of dealing or usage in trade, is made by NGA as to the accuracy and functioning of the product.

c. Neither NGA nor its personnel will be liable for any claims, losses, or damages arising from or connected with the use of this product. The user agrees to hold harmless the United States National Geospatial-Intelligence Agency. The user’s sole and exclusive remedy is to stop using the DAFIF product.

XM Satellite Radio Service Agreement

XM Satellite Radio Inc.

Hardware and required monthly subscription sold separately. Subscription fee is consumer only. Other fees and taxes, including a one-time activation fee may apply. All programming fees and weather data subject to change. XM WX weather data is shown and individual product availability vary by hardware equipment. Reception of the XM signal may vary depending on location. Subscriptions subject to Customer Agreement included with the XM Welcome Kit and available at xmradio.com. Available only in the 48 contiguous United States. XM WX is a trademark of XM Satellite Radio Inc.

FCC Compliance

This device complies with part 15 of the FCC Rules. Operation is subject to the following two conditions: (1) this device may not cause harmful interference, and (2) this device must accept any interference received, including interference that may cause undesired operation.

This equipment has been tested and found to comply with the limits for a Class B digital device, pursuant to part 15 of the FCC rules. These limits are designed to provide reasonable protection against harmful interference in a residential installation. This equipment generates, uses, and can radiate radio frequency energy and may cause harmful interference to radio communications if not installed and used in accordance with the instructions. However, there is no guarantee that interference will not occur in a particular installation. If this

equipment does cause harmful interference to radio or television reception, which can be determined by turning the equipment off and on, the user is encouraged to try to correct the interference by one of the following measures:

- Reorient or relocate the receiving antenna.
- Increase the separation between the equipment and the receiver.
- Connect the equipment into an outlet that is on a different circuit from the GPS unit.
- Consult the dealer or an experienced radio/TV technician for help.

This product does not contain any user-serviceable parts. Repairs should only be made by an authorized Garmin service center. Unauthorized repairs or modifications could result in permanent damage to the equipment, and void your warranty and your authority to operate this device under Part 15 regulations

INDEX

A

accessories 116
 accuracy alarm 77
 acquiring satellites 5
 active route page 50, 56
 options menu 50
 active track tab 34, 37
 AC outlet 2
 add to route 22, 24, 27, 62
 advanced NMEA output setup 94
 alarms 85
 anchor drag 76
 arrival 76
 DSC 72, 75
 navigation 76
 next turn 76
 off course 76
 persistent 76
 sonar 78
 system 77
 weather 77
 alarms tab 76
 alerts. *See* alarms
 anchor drag 76
 antenna 1, 121

append to route 27
 arrival alarm 76
 ask my preference 87
 assign category 30
 attention tone 85
 AutoLocate 3, 5
 automotive mode 56
 following a saved route 60
 navigating 57
 pages 64–66
 page sequence 56
 auto arrange 19
 average location 28
 avoidance button 87
 avoids 61, 87

B

backlight 3, 85
 basic operation 13
 battery
 level 2
 pack 1, 2
 saver mode 86
 beeper 85
 bug indicator 46

C

cable 117
 calculation method 87

calendar tab 78
 calibrate water speed 109
 cards, data 120
 carpool lanes 87
 categories
 find menu 17
 waypoint 30, 31
 CDI. *See* Course Deviation Indicator
 celestial tab 79
 hunt & fish sub tab 82
 sun & moon sub tab 81
 chain number 125
 charging 2
 check beacon wiring 124
 cigarette lighter adapter 2
 cities 17
 cleaning iv
 clear
 track log 35
 clock alarm 77
 color mode 84
 compass page 45, 85
 marine timer 46
 options menu 46
 showing/hiding 45
 connecting the GXM 30 antenna 118
 connecting the power cable 2, 117

county warnings 97
 count down 88
 course pointer 46
 create
 category 30
 route 20
 waypoints 24, 25
 current route page 63
 custom avoids 61, 87

D

data card 120
 information 19, 40
 slot 1
 data fields
 changing 39
 options 132
 date 89
 date/time 123
 daylight saving time 89
 day view 79
 DB-9 119
 deactivate 50
 declutter 43
 deep water 78
 defaults 8, 10

- delete
 - category 31
 - DSC Call 72
 - track log 35
 - waypoint 32
- depth 89
- detour 61
- DGPS 92, 93, 123
 - alarm 77
- differential 123, 124
- digital selective calling. *See* DSC
- direction display 89
- display tab 84
- distance and speed 89
- distress calls 71, 72, 73, 74, 75, 128, 129
- drift 78
- DSC 71, 128–129
- DSC Tab 71
- E**
- edit
 - route 21, 22, 23, 60
 - waypoints 29
- editing a waypoint 29
- emergency 128
- entering data 9
- erase track log 35
- exits 17
- external power source 2
- external voltage
 - alarm 77
- F**
- faster time 87
- FCC 128, 129, 138
- field 8
- find 17
 - from 17
 - from a different location 17, 18
 - menu 15, 19
- finding an item 17–19
- find current location 3
- Find Menu 17
- fishing 82
- fish symbols 108
- flasher 110
- following an automotive route 63
- forecast map 98
- fronts 97
- fuel flow 23
- G**
- getting started 1
- going to a destination 14
- go to
 - distress call 73
 - point 14
 - position report 73
- GPS
 - off/on 5
 - options 6
 - page 6
 - tips 6
- GPS Tab 68
- GRI Chain 126
- GSD 20 103
- GSD 20 Sounder Module 103
- GXM 30 Antenna 95, 100
 - connecting 118
- H**
- heading 90
- highways
 - avoid 87
- highway page 48, 85
 - hiding/showing 48
 - options menu 49
 - page layout 49
 - setup 49
- hunt & fish sub tab 82
- hurricanes 96
- I**
- icons 84
- identifier 128
- information page 19, 43
- installation 117
- interval 37
- invert 50
- item details 19
- K**
- keypad 7
- L**
- language 85, 86
- legs, track 37
- lightning 96
- limited warranty 135
- lithium-ion battery 2
- local time 89
- location 6, 26
- location format 90, 127
- log filter 84
- longitude 132
- LORAN TD Setup 125
- lost satellite reception 5

M

magnetic variation 90
 main menu 67–94
 alarms tab 76
 calendar tab 78
 celestial tab 79
 display tab 84
 DSC tab 71
 GPS tab 68
 message tab 83
 points tab 70
 route tab 70
 setup tab 86
 sonar tab 75
 track tab 71
 weather tab 68, 98–100
 XM tab 69
 Man OverBoard. *See* MOB
 map datum 127
 map orientation 41
 map page 38, 64
 declutter 43
 setup 40
 marine mode
 pages 38–42
 marine pages 38–55
 active route 50
 compass 45

 highway 48
 map 38
 position data 51
 XM Audio 52
 marine timer 46
 marine warnings 97
 maritime mobile service identity.
 See MMSI
 marking a waypoint 9, 25, 26, 28
 underwater 107
 MayDay 74, 129
 measuring distance 44
 messages 130, 132
 message tab 83
 mils 89
 MMSI 71, 128, 129
 MOB 14, 16
 modes 13, 56
 month view 79
 moon information 81
 Mrn Wx Tab 97

N

NAV/MOB 16
 navigate
 route 14, 21
 track 14, 16
 navigation alarms 76

near

 current route 18, 19
 destination 18, 19
 next 18, 19
 other 18, 19

new

 altitude 6
 location 6, 12
 waypoint 26, 28

NEXRAD Radar 96**next turn 88**

 alarm 76

NMEA 92, 93, 94, 121**north up 6, 41****no beacon signal 124****O**

“Off Route Recalculating” Announcement 88
 off course 76
 off road 87
 on-screen button 8
 options menu
 opening 9
 using 9
 overzoom 42

P

page layout 39
 highway 49
 trip computer 66
 page sequence 13
 panning the map 38, 42
 PC interface cable 119
 persistent alarm 76
 plan route 23, 50
 plan trips 78
 point 79
 points of interest 17
 points tab 70
 position data page 51
 options menu 51
 position mode 38
 position report 72–75, 128–129
 power 117
 connector 1, 2
 outlet 2
 practice mode. *See* simulator mode
 project waypoint location 28
 proximity
 points tab 32
 waypoint 33

- R**
- Radio ID 100
 - recalculating 88
 - receiver not usable 5
 - receiver status 5
 - receive satellite signals 3
 - receiving a DSC call 73
 - record tracks 34, 37
 - reference position 18
 - reset timer 88
 - reset trip data 51
 - review route 21
 - road routing tab 87
 - route 22, 79
 - add points 22, 27
 - create 20–24
 - edit 21–24
 - leg transition 24
 - preference 87
 - route tab 70
 - RTCM 92, 93
- S**
- sail boat racing timer 46
 - satellite acquisition 5
 - satellite location 123
 - satellite mosaic 96
 - satellite signals 4
 - satellite sky view 123
 - save present location 25
 - save this route 65
 - saving the current route 65
 - saving tracks 35, 36, 37
 - scanning for beacon 124
 - scan for a frequency 92
 - scroll bar 8
 - searching for WAAS 123
 - searching the sky 5
 - search history 18
 - selecting options 9
 - serial communications port 119
 - serial data format 92
 - serial number 1
 - setup tab 86
 - guidance sub tab 88
 - interface sub tab 91
 - location sub tab 90
 - road routing sub tab 87
 - system sub tab 86
 - timers sub tab 88
 - time sub tab 89
 - units sub tab 89
 - welcome sub tab 91
 - set an alarm 76
 - set date 89
 - set fuel flow 23
 - set speed 23
 - shallow water 78
 - shorter distance 87
 - signal strength 5
 - simulate 6, 86
 - GPS 5
 - simulator mode 11
 - new location 12
 - starting 12
 - software license agreement 134
 - sonar 103, 104–107
 - adjusting 105–107
 - alarms 78
 - on the map page 103
 - setting up 108, 110
 - understanding 112
 - sonar tab 75
 - sound tab 85
 - speaker 85
 - specifications 115
 - speed filter 86
 - split screen, sonar 107
 - srfc wx tab 97
 - stop navigation 50
 - storm cells 96
 - sun & moon sub tab 81
 - surface pressure 97
 - surface winds 97
 - switch modes 13
 - system alarms 77
- T**
- temperature 89, 111
 - text language 86
 - thermoclines 114
 - tide
 - chart 80
 - information 80
 - station 17, 80
 - sub tab 80
 - time
 - delay 125
 - format 89
 - offsets 127
 - zone 89
 - timer 46
 - toll roads 87
 - TracBack 14, 37
 - track
 - legs 37
 - log 34, 35, 37
 - tab 34
 - TracBack 36, 37
 - track tab 71
 - track up 6, 41
 - transducer 108, 113
 - trip computer page 51, 66
 - options menu 66
 - page layout 66

trip planning 23, 78
tuning beacon 124
turn-by-turn route 60, 63
turn off recalculation announcement
88
turn unit on and off 3

U

u-turns 87
underwater waypoints 107
unit overview 1
unpaved roads 87
usage mode 86
USB 92
 connector 1, 119
 data cable 119
 drivers 119
user points tab 29
UTC 89
UTM/UPS 127

V

VHF 71, 128
via points 62
view details 43
visibility 97
voice language 85
volume 3, 85

W

WAAS 6, 86, 117, 123, 124
warning page 3
water immersion iv
water speed 109
 calibrating 109
water temp 78
water temperature 97
wave
 direction 97
 height 97
 period 97
waypoint 17, 24
 categories 30
 create 24
 edit 29
 information page 19
 name 29
 projecting 28
 proximity 33
 reviewing 26
 symbol 29
 transition to next 24
weather alarms 77
weather data warranty 135
weather information
 finding 101

weather tab 68, 96
 options menu 99
 using 98
week view 79
welcome message 91
whiteline 106, 114
wide area augmentation system.
 See WAAS

X

xImage 120
XM Audio Page 52
 audio on/off 55
 favorites 54
 hiding/showing 53
 options menu 53
 scanning channels 55
XM Tab 69
XM WX Weather 95
 finding weather information 101
 Mrn Wx tab 97
 options menu 95
 Srfc Wx tab 97
 viewing 95
 weather tab 96

Z

zoom 41

**For the latest free software updates (excluding map data) throughout the life of your
Garmin products, visit the Garmin Web site at www.garmin.com.**



© 2009 Garmin Ltd. or its subsidiaries

Garmin International, Inc.
1200 East 151st Street, Olathe, Kansas 66062, USA

Garmin (Europe) Ltd.
Liberty House, Hounslow Business Park, Southampton, Hampshire, SO40 9RB UK

Garmin Corporation
No. 68, Jangshu 2nd Road, Shijr, Taipei County, Taiwan

www.garmin.com