

GPS 126/128

MARINE NAVIGATOR

GPS 126 shown



OWNER'S MANUAL
&
REFERENCE



Software Version 2.0 or above

© 1997 GARMIN International, Inc
1200 E. 151st Street, Olathe, KS USA 66062
Tel: 913-397-8200 or 800-800-1020
Fax: 913-397-8282
Web Site Address: www.garmin.com

GARMIN (Europe) Ltd.
Unit 5,
The Quadrangle, Abbey Park Industrial Estate,
Romsey, SO51 9AQ, U.K.
Tel: 011-44-1794-519944
Fax: 011-44-1794-519222

GARMIN (Asia) Corp.
4th Fl., No. 1., Lane 45,
Pao-Hsing Road,
Hsin Tein,
Taiwan R.O.C.
Phone: 886.02.917.3773
Fax: 886.02.917.1758

All rights reserved. No part of this manual may be reproduced or transmitted in any form or by any means, electronic or manual, including photocopying and recording, for any purpose without the express written permission of GARMIN.

Information in this document is subject to change without notice. GARMIN reserves the right to change or improve its products and to make changes in the content without obligation to notify any person or organization of such changes or improvements.

GARMIN, AutoLocate, TracBack, and are all trademarks of GARMIN International and may not be used without the expressed permission of GARMIN.

January 1998 - Part #190-00151-00 Rev. A - Printed in Taiwan.



GPS 126/128 OWNER'S MANUAL

Packing List

Welcome to the easiest-to-use fixed-mount GPS on the water! The GPS 126 and GPS 128 represent GARMIN's continuing commitment to provide mariners with quality navigation information in a versatile, accurate, and user-friendly design which will be useful for years to come. Due to the similarity between the GPS 126 and GPS 128, we have addressed both units in one manual. This manual is organized into four sections for your convenience:

Introduction gives a quick overview of the manual and contains the table of contents and glossary of navigation terms.

Getting Started introduces you to the basic features of the unit with a quick-start orientation to the GPS 126/128. This section has been designed to acquaint you with the unit and provide a basic working knowledge necessary to use the unit in typical conditions.

Reference provides detailed explanations of advanced features and operations in a topical format. This allows you to concentrate on a specific topic quickly, without reading through sections of text that you may not need.

The **Appendix** section contains step by step instructions on how to initialize the unit for first time use, installation instructions and items with multiple listings, such as: map datums, time offsets, and the index.

Packing List

Before getting started with your GPS receiver, check to see that your GARMIN GPS 126/128 package contains the following items. If you are missing any parts, please contact your dealer immediately.

Standard Package:

- GPS 126/128 Unit
- Power/Data Cable
- Quick Reference Guide
- Mounting Bracket with knobs
- Owner's Manual

* The GPS 128 also comes with an external antenna with 30' cable.

See your GARMIN dealer for accessories, including our PC kit.

Thanks for choosing the GARMIN GPS 126/128. We hope it will meet all of your navigation needs.



Caution

The GPS system is operated by the government of the United States, which is solely responsible for its accuracy and maintenance. The system is subject to changes which could affect the accuracy and performance of all GPS equipment. Although the GPS 126/128 is a precision electronic NAVigation AID (NAVAID), any NAVAID can be misused or misinterpreted and, therefore, become unsafe.

Use the GPS 126/128 at your own risk. To reduce the risk of unsafe operation, carefully review and understand all aspects of this Operator's Manual and thoroughly practice operation using the simulator mode prior to actual use. When in actual use, carefully compare indications from the GPS 126/128 to all available navigation sources including the information from other NAVAIDS, visual sightings, maps, etc. For safety, always resolve any discrepancies before continuing navigation.

NOTE: This device meets requirements for Part 15 of the FCC limits for Class B digital devices for home or office use. It has been tested for compliance with all necessary FCC standards. This equipment generates, uses, and can radiate radio frequency energy and, if not installed and used in accordance with the instructions, may cause harmful interference to radio communications. However, there is no guarantee that interference will not occur in a particular installation. If this equipment does cause harmful interference to other equipment, which can be determined by turning the equipment off and on, the user is encouraged to try and correct the interference by relocating the equipment or connecting the equipment to a different circuit than the affected equipment. Consult an authorized dealer or other qualified service technician for additional help if these remedies do not correct the problem. Operation is subject to the following conditions: (1) This device cannot cause harmful interference, and (2) this device must accept any interference received, including interference that may cause undesired operation. The GPS 126/128 does not contain any user-serviceable parts. Repairs should only be made by an authorized service center. Unauthorized repairs or modifications could void your warranty and your authority to operate this device under Part 15 regulations.

Table of Contents

SECTION ONE Introduction

Glossary	1
Navigation Basics	4

SECTION TWO Getting Started

Keypad Usage & Data Entry	5
Primary Pages	6
Power On & Marking a Position	8
Position Page and Map Pages	9
Going to a Waypoint	11
Compass Page & Cancelling A GOTO	12
Clearing the Map Display, Adjusting Contrast, & Power Off	13

SECTION THREE Reference

Satellite Page	14
Backlighting	15
Position Page & User Selectable Fields	16
Marking a Position & Position Averaging Function	18, 19
Waypoint Pages & Managing Waypoints	19
TracBack Navigation	26
Creating and Using Routes	30
Using the Compass & Highway Pages	33
Map Page, Zooming, & Panning	37, 38
Map Page & Track Log Setup	39, 40
Menu Page & Distance/Sun Calculation	43
System Setup	46
Navigation Setup	47
Interface Setup & DGPS Interface	44, 45
Navigation Simulator	51
Appendix A—Initialization	52
Appendix B—Installation	54
Appendix C—Specifications & Wiring	58
Appendix D—Messages and Time Offsets	60
Appendix E—Map Datums	62
Appendix F—Index	64

Glossary

The GPS 126/128 is a powerful navigation tool that can guide you anywhere in the world. To better understand its operation and capabilities, it may be helpful to review the basic terms and concepts briefly explained below.

Other navigation and GPS definitions used in the manual are defined in the appropriate reference sections of the manual.

Almanac Data

Satellite constellation information (including location and health of satellites) that is transmitted to your receiver from every GPS satellite. Almanac data must be acquired before GPS navigation can begin.

Bearing

The compass direction from your position to a destination.

Course Made Good (CMG)

The bearing from the “active from” position (your starting point) to your present position.

Crosstrack Error (XTK)

The distance you are off a desired course in either direction.

Desired Track (DTK)

The compass course between the “from” and “to” waypoints.

Differential GPS (DGPS)

An extension of the GPS system that uses land-based radio beacons to transmit position corrections to GPS receivers.

Estimated Time of Arrival (ETA)

The time of day of your arrival at a destination.

Estimated Time Enroute (ETE)

The time left to your destination at your present speed.

Grid

Coordinate system that projects the earth on a flat surface, using square zones for position measurements. UTM/UPS and Maidenhead formats are grid systems.

Ground Speed

The velocity you are traveling relative to a ground position.

Latitude

The north/south measurement of position perpendicular to the earth's polar axis.

Longitude

An east/west measurement of position in relation to the Prime Meridian, an imaginary circle that passes through the north and south poles.

Navigation

The process of traveling from one place to another and knowing where you are in relation to your desired course.

Position

An exact, unique location based on a geographic coordinate system.

Track (TRK)

The direction of movement relative to a ground position.

Universal Transverse Mercator (UTM)

A grid coordinate system that projects global sections onto a flat surface to measure position in specific zones.

Velocity Made Good (VMG)

The speed you are traveling in the direction of the destination.

Waypoint







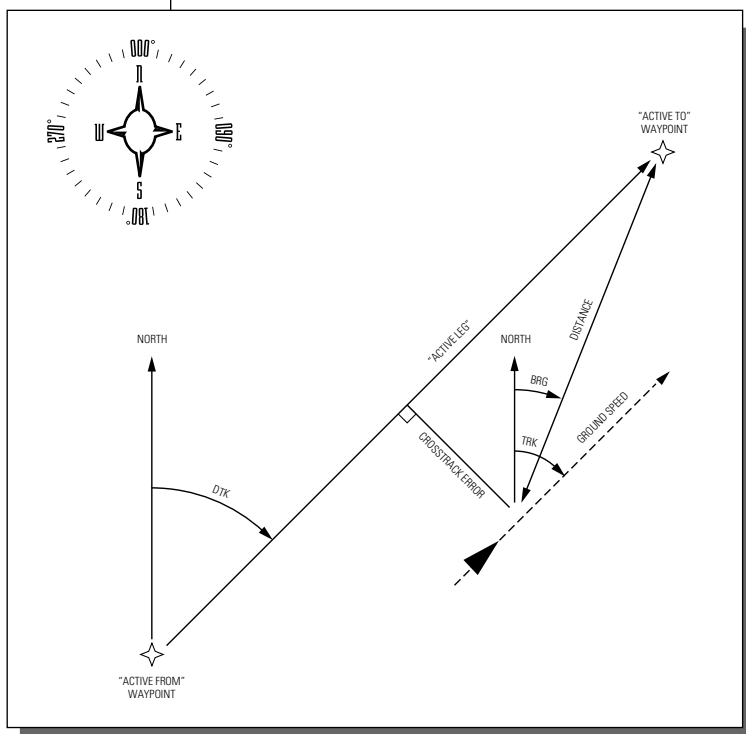



A specific location saved in the receiver's memory.

Navigation Basics

The GPS 126/128 provides steering guidance and navigation information using degrees, a measurement measured in a clockwise direction from a north reference. North is described as 000°, east as 090°, south as 180°, and west as 270°. The diagram and compass rose below provide a graphic illustration of the navigation terms used by the GPS 126/128. More information on basic navigation and GPS are available at your local library or bookstore.



Keypad Usage and Data Entry

	Turns the unit on and off and activates screen backlighting.
	Scrolls through the main data pages in sequence and returns display from a submenu page to the main page.
	Captures a position and displays the mark position page.
	Displays the GOTO page with the waypoint highlighted for GOTO operation.
	Confirms data entry and activates highlighted fields to allow data entry.
	Returns the display to a previous page, or restores a data field's previous value.
	Marks your present GPS position and instantly sets a return course while providing steering guidance.
	Decreases the scale of the moving map.
	Increases the scale of the moving map.
	Selects alphanumerical characters and menu choices and moves the field highlight from field to field.
	Moves the selected character field and moves the field highlight from field to field.

DATA ENTRY

The arrow keypad is used for all data entry. Use the ▲ and ▼ keys to select letters, numbers, and menu options; use the ◀ and ▶ keys to move the cursor forward or backward along the line. Press  to confirm your entry.

Primary Pages

Primary Pages

Before we start the tour, let's briefly look at the five primary information pages used for the GPS 126/128. To switch between pages press either the **QUIT** or **PAGE** keys (see below).

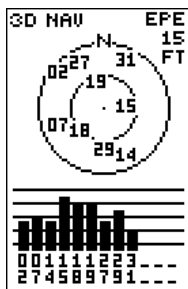
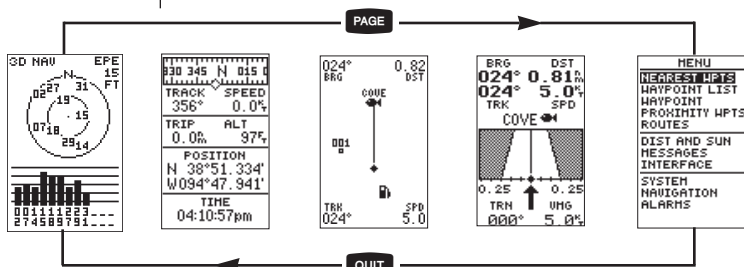

Satellite Page

The Satellite Page will allow you to monitor satellite signal reception and strength.

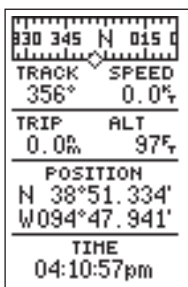

Position Page

Satellite Page

The **Satellite Page** shows satellite positions and signal strength. Satellite positions are displayed using two circles and a center point. The outer circle shows satellites on level with the horizon; the inner circle is 45° above the horizon; and the center point represents satellites directly overhead. Knowing satellite positions will show you the direction of any blocked signals.

The bottom of the page contains a row of signal strength bars corresponding to each satellite being used.

Position Page

The **Position Page** shows you where you are, what direction you're heading, and how fast you're going.

The top of the page contains a compass tape which is a graphic representation of your heading.



The graphic compass tape reflects your heading only while you are moving.

Your track and speed are indicated immediately below. Underneath are two user-selectable fields for a variety of data. The current position is displayed in latitude and longitude or a user selectable grid format. A 12/24 hour clock is also provided.

Primary Pages

Map Page

The **Map Page** acts as a window. It allows you to view your position, the “path” you have traveled over, and nearby waypoints.

A diamond icon in the center of the screen represents your current position. As you move, you will see a thin line called a *track log* appear along the path you have just covered. Names of stored waypoints and waypoint symbols can also be shown on the map.

The bottom corners of the screen always display your current track and speed. When going to a waypoint, highlighting an on-screen waypoint, or using the panning target crosshair, the corresponding distance and bearing are shown at the top corners of the screen.

Navigation Page

A navigation page gives you steering guidance when going to a waypoint. The GPS 126/128 has two navigation page choices: the Highway Page and the Compass Page. The Highway Page is the default and will be briefly explained here. The Compass Page is covered on page 36.

The **Highway Page** uses a graphic highway to show your movement in relation to your desired course. The upper section shows bearing and distance to the waypoint and your current track and speed. The middle portion contains the actual highway. The highway indicates the crosstrack error, or distance and direction, you are off-course from your waypoint. Always turn in the direction the highway is pointing. For example, if the highway points straight up, no turn is needed. If the highway points right, you need to turn right until the highway points straight up. The pointer just below the CDI scale always points to your selected waypoint, relative to the direction you are moving. The remainder of the page contains two user-selectable fields.

Menu Page

The last primary page is the **Menu Page**. The Menu Page gives you access to the GPS 126/128's waypoint management, route, and setup features through a list of submenus. The Menu Page is covered on page 43.

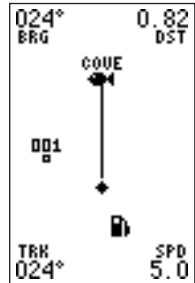
**Map Page**

The *Map Page* shows your progress on a moving track plotter and gives you a bird's-eye-view of surrounding waypoints.

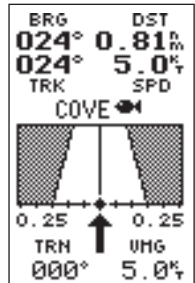
**Highway Page**

With the *Highway Page*, you will get graphic steering guidance when navigating a route or going to a single waypoint.

**Power On &
Marking a
Position**

The Welcome Page will be shown while the unit conducts a self test.

GPS POSITION	
Waypoint:	
001	■
N 38°51.334'	
W094°47.941'	

Add to route	
number: __	
AVERAGE? FOM	
SAVE? ____F ₇	

Press the UP arrow to move forward through the alphabet or numbers and the DOWN arrow to move backward.

Getting Started Tour

Now that you are familiar with the primary pages, it's time to take a tour. This is a live tour and is to be conducted with your unit installed and with the boat in the water. The tour will take you through the receiver's basic features and functions as you move about on the water and assumes that the GPS 126/128 is turned on and initialized, (see page 52 for initialization procedure) and that you have not changed any of the factory settings (units of measure, selectable fields, etc.). If these settings have been changed, the pictures and descriptions in this manual may not match what you see on your screen.

Navigation Simulator

If you are not able to take the Getting Started Tour with your boat in the water, you may use the built-in navigation simulator to practice using the GPS 126/128. To use the simulator, see page 51.

Marking a Position

To begin the tour, let's take the position you have acquired (either by just initializing the unit or by having turned the unit on) and mark it as a waypoint for future reference.

1. Press the **MARK** key to capture and hold your position.



To mark a position, you must have obtained a 2D or 3D fix, or have the receiver in simulator mode. If you try to mark a position without a position fix, you will be alerted with a 'No GPS Position' message.

The mark position page will appear, showing the captured position and a default 3-digit waypoint name. Let's change the default name to something a little more meaningful, like 'DOCK'.

2. Press the down arrow once to move the field highlight from the 'SAVE?' field to the name field.

Position and Map Pages

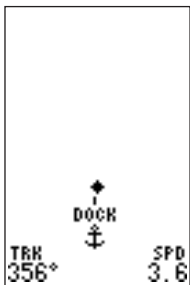

The Map Page displays your present position as a diamond icon and provides a real-time graphic “breadcrumb” display of your track right on the screen.

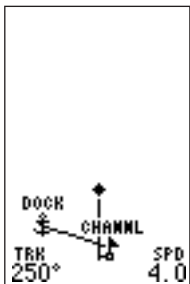

The moving map's default screen orientation is track-up. “Track up” means that your current direction of travel is always up (or towards the top of) the screen. It can also be set for north up, or desired track-up orientation through the map setup page.

Using the Position and Map Pages (cont.)

As you head out, the Position Page will help you monitor your movement.

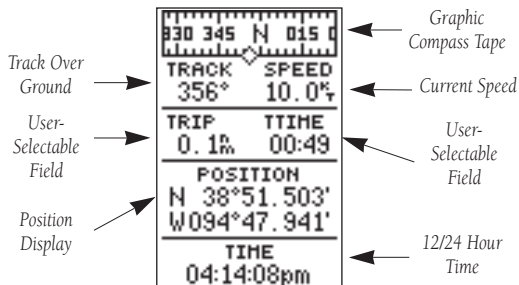

The direction you are moving (your track) and your speed are displayed on the upper part of the page, just below the graphic compass tape. The latitude and longitude, along with two user-selectable displays, are continuously displayed in the middle of the page, and the time of day is displayed below.

Now let's change the display to the Map Page and watch the track log of our tour:

1. Press the **PAGE** key to change from the Position Page to the Map Page.

To view a larger area on the Map Page, let's change the zoom scale from .2 (default) to 1.0 nautical mile.

To select a larger zoom scale on the Map Page:

1. Press the **OUT** key until '1.0 n.m. zoom scale' appears.

Your current position is shown as the diamond in the middle of the screen. The dark circle below the diamond represents the position you created, with the line between the two showing your track.

1. Once you have reached an area that allows for general changes in direction without interfering in the passage of other boats, mark your current position again and name this waypoint “CHANNL”. (See ‘Marking a Position’ on page 18.)
2. Next, make a moderate turn in any direction that's safe for navigation and proceed for another 3 minutes.

Going To a Waypoint

Going To a Waypoint

Once you've stored the "CHANNL" waypoint in memory, you can use the GPS 126/128 to guide you to it by performing a simple GOTO. A GOTO is nothing more than a straight-line course from your present position to the destination you've selected.



Use caution when navigating. A "straight-line" course reflects the shortest distance to a waypoint, and does not navigate around obstructions, such as land or buoys, etc.

Now that you have moved away from 'CHANNL' for three minutes, let's try navigating back to it.

To select a GOTO destination:

1. Press the **GOTO** key.
2. The GOTO waypoint page will appear, displaying all the waypoints in memory in alphabetical order.
3. Use **▲** or **▼** to highlight the 'CHANNL' waypoint.
4. Press the **ENTER** key to confirm that you want to navigate to the displayed waypoint.
5. Press the **PAGE** key to view the Graphic Highway Page.

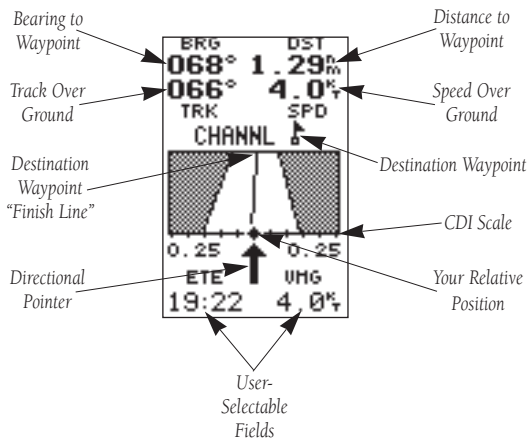

The GOTO waypoint page allows you to select your destination from a list of all available waypoints in the GPS 126/128's memory.



Once a GOTO is activated, the GPS 126/128 will provide steering guidance until the GOTO is cancelled. To cancel a GOTO, highlight the cancel prompt at the bottom of the page and press ENTER.

GOTO Waypoint & Cancelling GOTO

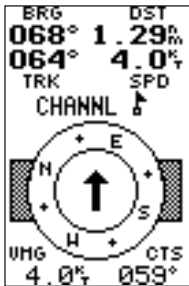

The 126/128 will also provide steering guidance with a graphic Compass Page.

To change the display from the Highway Page, press ENTER twice.

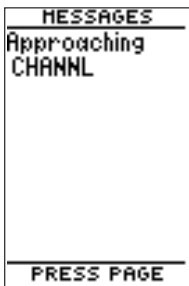

Once you reach the selected distance from the destination (based on your present speed and course), an arrival message will appear on the message page.

Going To a Waypoint (continued)

The GPS 126/128's Highway Page provides graphic steering guidance to a destination, with an emphasis on a straight-line course to the desired waypoint and the distance and direction you are off course. The bearing and distance to a waypoint—along with your current track and speed, are displayed at the top of the screen, with two user-selectable fields shown at the bottom.

As you head toward your destination, the middle section of the screen provides visual guidance to your waypoint on a moving graphic “highway”. The pointer just below the CDI scale always points to your selected waypoint relative to the direction you are moving.

Your present position is represented by the diamond in the center of the course deviation scale. The line down the middle of the highway represents your desired track. As you navigate toward a waypoint, the highway will actually move, indicating the direction you're off course, relative to the position diamond on the CDI scale. To stay on course, simply steer toward the center of the highway.

While navigating, you may decide to use the Compass Page (see picture above left) instead of the Highway Page.

To select the Compass Page:

1. While viewing the Highway Page, press **ENTER** twice.

The Compass Page will now become the displayed navigation page. This page provides a directional pointer to your destination by using a rotating compass display to show direction of travel. It provides better steering guidance at slower speeds for travel with many directional changes.

To switch back to the Highway Page, press ENTER twice.

Cancelling a GOTO

If you decide to stop navigating to the active waypoint, all you have to do is cancel the GOTO.

To cancel an active GOTO:

1. Press the **GOTO** key.

- Use the arrow keypad to move the field highlight to the 'CANCEL GOTO?' prompt at the bottom of the page and press **ENTER**.

Clearing a Cluttered Map Display

After you've used the GPS 126/128 for a few trips, you may find that your map display has become a bit messy from keeping track of your every move. For practice, let's clean up the screen by clearing the track log (the plot points left on the Map Page) we've just created during the Getting Started Tour.

- Press **PAGE** or **QUIT** until the Map Page appears and press **ENTER**.
- Use the **▼** key to move the field highlight to the 'TRACK SETUP' option.
- Press **ENTER** to access the track setup page.
- Highlight the 'CLEAR LOG?' option. The clear log confirmation page will appear.
- Use the **◀** key to highlight the 'Yes' prompt.
- Press **ENTER** to finish.

Adjusting the Contrast

You can adjust the screen contrast from the Satellite Page and also from the Menu Page (see page 47)

To adjust the contrast from the Satellite Page:

- Press the **PAGE** or **QUIT** key until the Satellite Page appears.
- Press the arrow keypad left or right until the desired level is reached, and press **ENTER**.

Turning the Receiver Off

You've now gone through the basic operation of your new GPS receiver. We encourage you to experiment with the GPS 126/128. If you encounter any problems using the unit or want to take advantage of the GPS 126/128's more advanced features, refer to the reference section of this manual.

To turn the GPS 126/128 off:

- Press and hold the **⏻** key for 3 seconds.

REFERENCE

Clearing the Map, Adjusting Contrast, & Power Off



Highlight the 'CLEAR LOG?' prompt and press **ENTER** to clear the track log. Once all 1024 points are used, the oldest point will be continuously deleted to make room for the latest track log point.

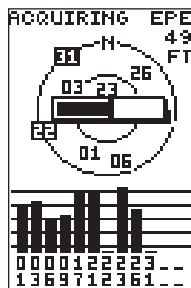

Instantly change the screen contrast by pressing the arrow keypad while viewing the Satellite Page.

Satellite Page

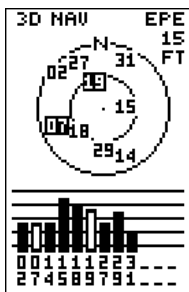

The GPS 126/128's Satellite Page will help you determine which satellites are in view, and whether or not any satellites are being "shaded" or blocked. (See satellites 07 and 19 above).

By periodically monitoring the signal strength bars at the bottom of the page and the north up sky view, you will be able to see how moving to another area with a clearer view of the sky will improve satellite reception and speed up signal acquisition.

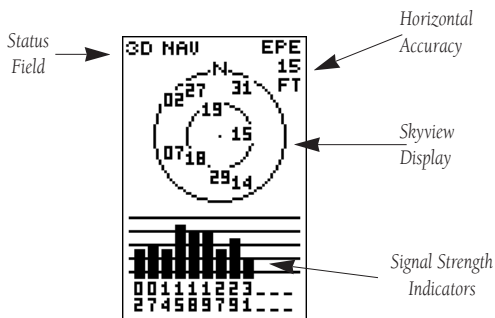
Satellite Page

The GPS 126/128's Satellite Page displays the status of various receiver functions. The status information will help you understand what the GPS 126/128 is doing at any given time, and will tell you whether or not the receiver has calculated a position fix.

Sky View and Signal Strength Bars

The sky view and signal strength bars give you an indication of what satellites are visible to the receiver, whether or not they are being used to calculate a position fix, and the signal quality. The satellite sky view shows a bird's-eye view of the position of each available satellite relative to the unit's last known position. The outer circle represents the horizon (north or track up); the inner circle 45° above the horizon; and the center point directly overhead. You can use the sky view to help determine if any satellites are being blocked, and whether you have a current position fix (indicated by a '2D NAV' or '3D NAV' in the status field). You can also set the sky view to a track-up configuration by changing the "orientation" option on the Map Page. (See pg. 41 for Map Setup instructions.)

When the receiver is looking for a particular satellite, the corresponding signal strength bar will be blank and the sky view indicator will be highlighted. Once the receiver has found the satellite, a hollow signal strength bar will appear, indicating that the satellite has been found and the receiver is collecting data from it. The satellite number in the sky view will no longer appear highlighted. As soon as the GPS 126/128 has collected the necessary data to calculate a fix, the status field will indicate a 2D or 3D status.

Receiver Status & Screen Backlighting

Receiver Status and EPE

Receiver status is indicated at the top left of the page, with the current horizontal accuracy (EPE, estimated position error, in feet or meters) at the top right. The status will be shown as one of the following conditions:

Searching— the GPS 126/128 is looking for any available satellites in view.

AutoLocate— the GPS 126/128 is initializing and collecting new almanac data. This process can take 5 minutes, depending on the satellites currently in view.

Acquiring— the receiver is collecting data from available satellites, but has not collected enough data to calculate a 2D fix.

2D Navigation— at least three satellites with good geometry have been locked onto and a 2-dimensional position fix (latitude and longitude) is being calculated. '2D Diff' will appear when you are receiving DGPS corrections in 2D mode.

3D Navigation— at least four satellites with good geometry have been locked onto, and your position is now being calculated in latitude, longitude and altitude. '3D Diff' will appear when you are receiving DGPS corrections in 3D mode.

Poor GPS Coverage— the receiver isn't tracking enough satellites for a 2D or 3D fix.

Not Usable— the receiver is unusable, possibly due to abnormal satellite conditions. Turn the unit off and back on to reset, and reinitialize the receiver if necessary.

Simulator— the receiver is in simulator mode.

Screen Backlighting

The GPS 126/128 feature illuminates the screen display for a user-defined interval (the default is 15 seconds). There are three stages of backlighting. When backlighting is on, a bulb icon will appear at the bottom left of the sky view. To adjust the duration of screen backlighting, refer to the system setup section (see page 47).

Note: A bulb icon will appear on the Satellite Page when backlighting is on.

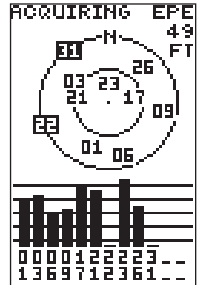

The signal strength bars at the bottom of the page will not appear until the GPS 126/128 has found the satellites indicated at the bottom of the screen.

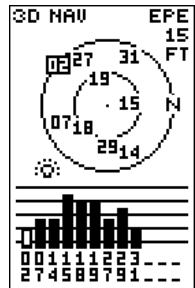

When backlighting is on, a bulb icon will appear at the bottom left of the Satellite Page.

Use the icon to determine if backlighting is turned on during daylight hours.

EZinit Prompt and Memory Erase

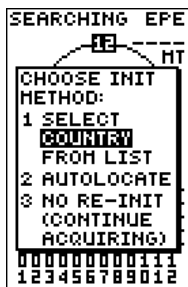

If you travel more than 500 miles with the receiver off, reinitialize the unit to your new position by using the EZinit feature. To access EZinit, press ENTER from the Satellite Page before any satellites are acquired.



Upon activating the Memory Erase Function, you will be asked to confirm your decision.

EZinit Option Prompt

The Satellite Page also provides access to the EZinit prompt whenever a position fix has not been calculated. (The unit must be in searching, AutoLocate, acquiring, simulator, or poor coverage mode.) This allows you to reinitialize the unit (see Appendix A), and is useful if you have traveled over 500 miles with the receiver off and must initialize your new position. (The EZinit prompt will automatically appear if the receiver needs to be initialized. The prompt may also appear during normal use if the antenna is blocked from receiving satellite signals.

Note: The GPS 126/128 features an internal lithium battery that will maintain the unit's memory when the receiver is not running.

Memory Erase Function

You may erase the GPS 126/128's memory in four quick steps. This will cause all stored data to be deleted, including routes, waypoints, and the track log.

To erase all stored data:

1. Ensure that the GPS 126/128 is turned off.
2. While holding down the **MARK** key, press the **GPS** key to turn the unit on. After the unit turns on, release the keys. A warning message will appear with "Yes?" highlighted, and ask you to confirm your selection.
3. If you **do not** wish to erase all stored data, press **▶** and **ENTER** to cancel the emergency erase.
4. If you **do** wish to complete the emergency erase, press **ENTER** to confirm.

Position Page

The second page in the GPS 126/128's main page sequence is the Position Page. This page shows you where you are, what direction you're heading, and how fast you're going. The Position Page is most useful when you are traveling without an active destination waypoint. The graphic compass tape across the top of the page indicates the direction you're heading (only while you're moving).

Position Page

Position Page (continued)

Directly below the graphic compass tape are the track and speed fields. Track is the compass direction representing your actual course over the ground, and Speed is how fast you're moving. Below track and speed are two user-selectable fields. Both user-selectable fields can display a variety of information that will aid in navigation. The left field offers options for TRIP (default), AVSPD, MXSPD, TTIME, and ELPSD. The right field offers options for ALT (default), TTIME, ELPSD, and TRIP.

The following user-selectable options are available on the Position Page:

Trip Odometer (TRIP)— total distance traveled since last reset.

Trip Timer (TTIME)— total (cumulative) time in which a ground speed has been maintained since last reset.

Elapsed Time (ELPSD)— hours and minutes since last reset.

Average Speed (AVSPD)— average speed traveled.

Maximum Speed (MXSPD)— maximum speed traveled since last reset.

Altitude (ALT)— vertical distance above sea level.

To change the user-selectable fields

1. Highlight the left or right user-selectable field and press **ENTER**.
2. Use the **▲** or **▼** key to scroll through the available options.
3. Press **ENTER** to confirm your selection.

The trip odometer, trip timer, and average speed fields are linked. Resetting one of these options in a user-selectable field will automatically reset the corresponding data in the other. This ensures that information shown in these fields reflects your current trip.

50 165 S 195 23
TRACK SPEED
180° 2.3%
TRIP TIME
8.6m 12:22
POSITION
N 38°53.017'
W094°47.824'
TIME
04:32:40pm

The speed and track displayed on the position page may fluctuate at slow speeds (or when you're not moving) because of position errors caused by Selective Availability.

50 165 S 195 23
TRACK SPEED
180° 3.7%
ELPSD TIME
02:29 12:40
POSITION
N 38°52.992'
W094°47.826'
TIME
04:32:58pm

The user-selectable fields on the Position Page give you a variety of information to choose from.

Altitude Field & Marking a Position

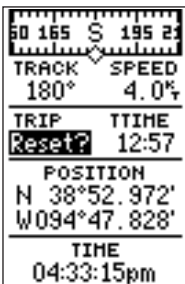

Resetting the trip odometer will erase the previous mileage and set the odometer to 0.

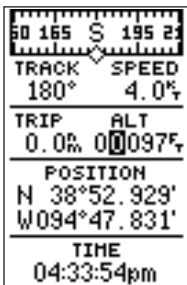

You may enter a known altitude to assist the GPS 126/128 in establishing a 3D fix.

Altitude Field

When the GPS 126/128 is acquiring satellites or navigating in the 2D mode, the last known altitude is used to compute your position. In cases where the GPS 126/128 has 2D coverage, entering your approximate altitude will enable the receiver to determine a 3D fix.

Note: The altitude can not be changed when the GPS 126/128 has a 3D position fix.

To enter an altitude:

1. Ensure that 'ALT' is displayed in the user-selectable field.
2. Highlight the 'ALT' value field, and press **ENTER**.
3. Enter a value, and press **ENTER**.

Directly below the user-selectable fields is the Position field. The position field shows the current GPS position in latitude and longitude (default) or a user selectable position format (see navigation setup page 47). Directly below the position field is the time. Time can be displayed as a 12- or- 24 hour clock (see system setup page 46).

Marking A Position

The GPS 126/128 allows you to mark and store up to 500 positions as waypoints. A waypoint can be entered by taking an instant electronic fix, by manually entering coordinates (pg. 21), or using the bearing and distance to a known position (pg. 22).

To mark your present position:

1. Press **MARK**. The mark position page will appear, showing the captured position and a default three-digit name.
2. To save a default name and symbol, press **ENTER** to confirm the 'Save?' prompt.

To enter a different waypoint name:

1. Highlight the waypoint name field, and press **ENTER**.
2. Make the appropriate changes, and press **ENTER**.
3. Highlight 'SAVE?', and press **ENTER**.

Note: To enter a different waypoint symbol or comment, see pg. 23.

Position Averaging & Waypoint Pages

To add this waypoint to a route:

1. Highlight the 'Add to route number' field, and press **ENTER**.
2. Enter a route number, press **ENTER** to confirm and press **ENTER** again to save the waypoint.

Position Averaging Function

The GPS 126/128 positioning averaging function will help reduce the effects of selective availability when marking a waypoint.

Note: As the GPS 126/128 calculates the FOM, it will rapidly change before it stabilizes on one number.

1. After you have pressed the **MARK** key, highlight the 'AVERAGE?' field and press **ENTER**. The Figure of Merit (FOM) field will display the value reflecting estimated accuracy of the averaged position.
2. The unit will continue averaging until you have highlighted 'SAVE?' and pressed **ENTER**.

Waypoint Pages

The GPS 126/128 has three waypoint pages that let you quickly manage up to 500 waypoints. These pages—nearest waypoints, waypoint list, and waypoint definition—can be accessed through the Menu Page.

To select a waypoint page:

1. Access the Menu Page, and highlight a waypoint page option.
2. Press **ENTER**.

Nearest Waypoints Page

The nearest waypoints page shows the nine nearest waypoints within 100 miles of your present position, with the bearing and distance noted for each waypoint. This page will let you retrieve a waypoint definition page or GOTO a selected waypoint right from the list.

To review the waypoint definition page of a selected waypoint:

1. Highlight the desired waypoint.
2. Press **ENTER**.

MARK POSITION	
Waypoint:	
001	▣
N 38°51.334'	
W094°47.941'	
Add to route	
number:	▣
FOM	____.F
AVERAGE?	
SAVE?	

The GPS 126/128 will save new waypoints with a default three-digit name. To add the waypoint to a route, enter the desired route number, highlight 'SAVE?', and press ENTER.

GPS POSITION	
Waypoint:	
001	▣
N 38°51'20.0"	
W094°47'56.4"	

Add to route	
number:	--
AVERAGE? FOM	
SAVE? 34.2F	

After initiating the position averaging function, a Figure of Merit value will be displayed, and the 'SAVE?' field will automatically be highlighted.

Nearest Waypoints & Waypoint List

HMENU
NEAREST WPTS
WAYPOINT LIST
PROXIMITY WPTS
ROUTES

DIST AND SUN
MESSAGES
INTERFACE

SYSTEM
NAVIGATION
ALARMS

To select a waypoint sub-menu, highlight the desired option and press ENTER.

NEAREST WPTS		
WAYPNT	BRG	DST
POINT	145'	0.00
FUEL	086'	0.15
FISH-5	034'	0.24
CHANNL	358'	0.51
COVE	176'	1.00
004	359'	1.25
DOCK	359'	1.25
002	359'	1.25
001	359'	1.26

Nearest Waypoints Page

The compass heading (BRG) and distance (DST) to the nine nearest waypoints are updated continuously.

To return to the nearest waypoint page:

1. Highlight 'DONE?'
2. Press **ENTER**.

To go to a highlighted list waypoint:

1. Highlight the desired waypoint, and press **GOTO**.
2. Press **ENTER**.

Waypoint List Page

The waypoint list page provides a complete list of all waypoints currently stored in the GPS 126/128 and their respective waypoint symbols. The total number of empty and used waypoints is also indicated. From the waypoint list page, you can retrieve a waypoint definition page, delete all user-defined waypoints, delete waypoints by symbol, review a waypoint, or GOTO to a selected waypoint.

WAYPOINT LIST	
493 EMPTY	7 USED
▣	002
☛	COVE
☛	DOCK
☛	FISH-7
☛	FUEL
☛	POINT
⚓	ROCK
DELETE WPTS?	

To delete all user-defined waypoints:

1. Highlight 'DELETE WPTS?', and press **ENTER**.

An options page will appear, asking if you want to delete all user-defined waypoints or if you want to delete waypoints by symbol type.

1. Highlight either 'ALL' or 'SYMBOL', and press **ENTER**.

If you select 'ALL,' highlight 'YES?' and press **ENTER** to confirm.

Waypoint List & Proximity Waypoints

Waypoint List Page (continued)

If you highlight 'SYMBOL,' you'll be asked to select a symbol.

1. select the symbol to be deleted and press **ENTER**.
2. Press **ENTER** to confirm the 'DONE' prompt, highlight the 'YES?' prompt, and press **ENTER**.

Note: This feature is handy for deleting temporary waypoints created by the TracBack function.

Proximity Waypoints

The GPS 126/128's proximity waypoint function warns you when you are getting too close to hazardous waypoints. This function allows you to create up to nine proximity waypoints and designate an alarm circle for each waypoint. If you enter this circle, a warning message will alert you.

To enter a proximity waypoint from the main menu:

1. Highlight 'PROXIMITY WPTS' and press **ENTER**.
2. Highlight the first empty waypoint field and press **ENTER**.
3. Use the arrow keypad to scan through stored waypoints until desired waypoint appears (see page 24).
4. Press **ENTER**. The distance (DST) field will be automatically highlighted.
5. Press **ENTER**. Enter the desired distance.
6. Press the **ENTER** key.

To review or remove a proximity waypoint:

1. Select a proximity waypoint and press **ENTER**.
2. Highlight 'REVIEW?' or 'REMOVE?' and press **ENTER**.

If 'REVIEW?' is chosen, the waypoint definition page will appear, and you may make any changes to the selected waypoint (see pgs. 22-24). If 'REMOVE?' is chosen, the proximity waypoint page will reappear with the waypoint removed. Press **QUIT** or **PAGE** to return to the Menu Page.

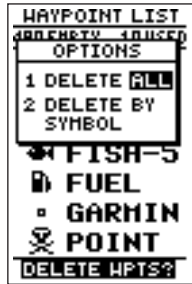

Deleting waypoints by symbol enables you to delete a specific group of waypoints without losing all other waypoints.



Quickly edit proximity waypoints by highlighting the waypoint name and pressing **ENTER**.

Waypoint Definition & Reference Waypoints

WAYPOINT	
DOCK	↔
N 38°52.582'	
W094°47.861'	
11-M00-97 22:39	
REF: -----	
BRG	DST
359°	00.0%
RENAME?	NEW?
DELETE?	DONE?

The GPS 126/128's advanced waypoint planning features allow you to create new waypoints and practice navigation without ever setting foot outside.

If you create a new waypoint by entering coordinates from a map, you may want to re-mark the waypoint's exact position once you get there.

To re-define an existing waypoint's position coordinates from the waypoint definition page, simply highlight the DST field and press ENTER. Use the LEFT arrow key to set the distance to 0.00, and press ENTER to confirm.

The old coordinates will be replaced by your present position if you have a valid 2D or 3D position fix.

Waypoint Definition Page

WAYPOINT			
Waypoint Name	DOCK	Waypoint Symbol	↔
	N 38°52.582'	Position Coordinates	W094°47.861'
	11-M00-97 22:39	Waypoint Comment	
Reference Waypoint	REF: -----		
	BRG	DST	
Bearing from Reference Waypoint	359°	Distance from Reference Waypoint	00.0%
	RENAME?	NEW?	
	DELETE?	DONE?	
	Function Prompts		

The waypoint definition page lets you create new waypoints manually or review and edit an existing waypoint's coordinates, symbols, and comments. It is also used to delete an individual waypoint from memory (see pg. 24). To create a new waypoint manually, you'll need to know its position coordinates or its approximate distance and bearing from an existing waypoint.

To create a waypoint by entering coordinates:

1. From the waypoint definition page, highlight 'NEW?', and press **ENTER**.
2. Enter a waypoint name, and press **ENTER**.
3. Press **ENTER** to select a waypoint symbol, make your selection, and press **ENTER**.
4. Highlight the 'DONE?' prompt, and press **ENTER** to return to the waypoint page.
5. Highlight the 'position' field, and press **ENTER**.
6. Enter your position, and press **ENTER**.
7. Highlight the 'DONE?' prompt and press **ENTER** to confirm.

Reference Waypoints

To create a new waypoint manually without knowing its position coordinates, you'll need to enter its bearing and distance from an existing waypoint or your present position.

To create a new waypoint by referencing a stored waypoint:

1. From the waypoint definition page, highlight 'NEW?', and press **ENTER**.

Waypoint Symbols & Comments

Reference Waypoints (cont.)

2. Enter a waypoint name, and press **ENTER**.
3. Highlight the 'reference' field, and press **ENTER**.
4. Enter a reference waypoint name (or leave the field blank to use your present position), and press **ENTER**.
5. Enter the bearing and distance of your new waypoint from the reference waypoint.
6. Press **ENTER** to confirm the 'DONE?' prompt.

Waypoint Symbols

The GPS 126/128 allows you to select one of 16 symbols for each waypoint for easy recognition on the map display. From the symbol page, you may also select how the waypoint appears on the map.

To select a waypoint symbol:

1. Highlight the symbol field, and press **ENTER**.
2. Use the arrow keypad to select the desired symbol, and press **ENTER**.
3. The cursor will move to the display field, where you can select how the waypoint information will be displayed on the map.
4. Press **ENTER**, and select one of the following display options: 'name with symbol,' 'symbol only,' or 'comment with symbol'.
5. Press **ENTER** to confirm your selection, and **ENTER** again to confirm the 'Done?' prompt.

Waypoint Comments

Each waypoint stored in the GPS 126/128 has a user-defined 16-character comment field. The default comment is the UTC (or Greenwich mean time) date and time of the waypoint's creation.

To change or add a comment:

1. Highlight the 'comment' field.
2. Press **ENTER**.

Note: You can clear the 'comment' field by pressing the left side of the rocker keypad.

3. Enter the desired comment.
4. Press **ENTER**.



Waypoint symbols enable you to instantly get more information about a waypoint than just its name.

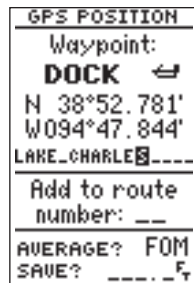

The waypoint comment field will automatically assign the date and time of creation to the waypoint comments field. You may enter a 16-character user comment at any time.

Rename, Delete & Scan Waypoints

```

RENAME WAYPT
-----
From
004
To:
COVE__
Are you sure
Yes? or No?
  
```

You may wish to quickly save waypoints by pressing MARK and then ENTER, thus assigning a default name. You may then rename the waypoint at a later date. Any waypoint may be renamed at any time.

```

WAYPOINT
-----
GARMIN °
N 38°52.581'
W094°47.861'
11-NOV-97 22:39
REF: -----
BRG   DST
359°  1.25%
RENAME?  NEW?
DELETE?  DONE?
  
```

Scanning waypoints from the waypoint definition page is quick and easy. Simply highlight the name, press ENTER, and use the arrow keypad to scroll through the names.

Renaming and Deleting Waypoints

The rename and delete function fields are located along the bottom of the waypoint definition page.

To rename a stored waypoint:

1. Highlight 'RENAME?', and press **ENTER**.
2. Enter the new waypoint name , and press **ENTER**.
3. Press **ENTER** to confirm the 'Yes?' prompt.

To delete a stored waypoint:

1. Highlight 'DELETE?', and press **ENTER**.
2. Highlight the 'Yes' prompt, and press **ENTER**.

Note: To delete a waypoint that's part of a route, first remove the waypoint from the route (see pg. 34), and then delete it. If you attempt to delete a waypoint that's part of a route, you'll be given a "Route Waypoint Can't be Deleted" message.

Scanning Waypoints

As you manually enter a waypoint's name, the GPS 126/128's waypoint scanning feature will automatically display the first numerical or alphabetical match of the character you have entered. If you have more than one waypoint that begins with the same letter or number, move to the next character position and continue entering the waypoint name. This helps eliminate the need to always enter a waypoint's complete name.

To scan waypoints from a waypoint field:

1. Highlight the waypoint name field, and press **ENTER**.
2. Press the left side of the keypad to clear the name field.
3. Scroll through the waypoints.
4. When you find the desired waypoint, press **ENTER**.

Select a GOTO & MOB Function

Selecting a GOTO Destination

The GPS 126/128 provides four ways to navigate to a destination: GOTO, MOB, TracBack, and route navigation. The most basic method of selecting a destination is the GOTO function, which lets you choose any stored waypoint as the destination and quickly sets a direct course from your present position.

To activate the GOTO function:

1. Press **GOTO**.
2. Select the waypoint you want to navigate to, and press **ENTER**.

Once a GOTO waypoint has been activated, the Compass Page or Highway Page will provide steering guidance to the destination until either the GOTO is cancelled or the unit has resumed navigating the active route (see pg 30).

To cancel an active GOTO:

1. Press the **GOTO** key.
2. Highlight 'CANCEL GOTO?', and press **ENTER**.

Man Overboard Function

The GPS 126/128's man overboard function (MOB) lets you simultaneously mark and set a course to a position for quick response to passing positions.

To activate the MOB mode:

1. Press the **MOB** key.
2. Press **ENTER** to begin MOB navigation.

The GPS126/128 will now guide you to the MOB waypoint until the MOB GOTO is cancelled. If you want to save the MOB waypoint be sure to rename it. The MOB function will overwrite any previous MOB waypoint when it is activated.

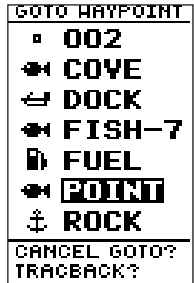

Select a destination waypoint from the GOTO waypoint list.

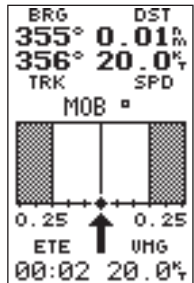

Once the MOB mode has been activated, steering guidance will be provided by the Compass or Highway Page. Activating another MOB will overwrite the previous MOB waypoint.

TracBack

```

TRACK SETUP
RECORD: OFF
METHOD:
AUTO

HEM USED 0%
3/1024 PTS
CLEAR LOG?

```

```

TRK SPD
000° 0.0

```

WARNING:

Setting the track recording to OFF will disable the TracBack function.

```

GOTO WAYPOINT
☛ COVE
☛ DOCK
☛ FISH-5
☛ FUEL
☛ GARMIN
☛ HOB
☛ POINT
CANCEL GOTO?
TRACBACK?

```

Highlight the 'TracBack?' prompt and press ENTER to begin TracBack navigation.

TracBack Navigation

GARMIN's patented TracBack feature allows you to quickly retrace your path using the track log automatically stored in the receiver. This feature eliminates the need to mark waypoints along the way and manually create and activate a route back to where you began your trip. Once a TracBack route is activated, it will lead you back to the oldest track log point stored in memory, so it's usually a good idea to clear the existing track log at the start of each trip.

To clear the track log and define a starting point for a TracBack route:

1. From the Map Page, press **ENTER**.
2. Highlight the 'TRACK SETUP' option, and press **ENTER**.
3. Highlight 'CLEAR LOG?', press **ENTER**.
4. Highlight 'Yes?', and press **ENTER**.

To activate a TracBack route:

1. Press **GOTO**, highlight 'TRACBACK?', and press **ENTER**.

Once the TracBack function has been activated, the GPS 126/128 will take the track log currently stored in memory and divide it into segments called legs. Up to 30 temporary waypoints will be created to mark the most significant features of the track log in order to duplicate your exact path as closely as possible. These points will be indicated by waypoint numbers beginning with 'T' on the waypoint list, and by a "T" symbol on the Map Page.

The active route page will appear, showing a route from your present position to the oldest track log point in memory. Steering guidance to each waypoint will be provided back to the starting point of your track log.

Note: You may delete a TracBack waypoint from a route, but only if the route is not active.

Tips On the TracBack Feature

- Always clear your track log at the exact point that you want to go back to (dock, boat ramp, etc.).
- The 'Record' option on the track log setup page can be set to either the 'wrap' or 'fill' position.
- There must be at least two track log points stored in memory to create a TracBack route.

TracBack

- If there are not enough available waypoints in memory to create a TracBack route, you will be alerted with a 'waypoint memory full' message, and the receiver will use any available waypoints to create a TracBack route with an emphasis on the track log closest to the destination (the oldest track log point in memory).
- If the 'Method' option on the track log setup page is set to a time interval, the TracBack route may not follow your exact path. (Keeping the criteria set to automatic will always provide the most detailed TracBack route.)
- If the receiver is turned off or you lose satellite coverage during your trip, the TracBack route will simply draw a straight line between any point where coverage was lost and where it resumed.
- If the changes in direction and distance of your track log are complex, 30 waypoints may not be enough to accurately mark your exact path. The receiver will then assign the 30 waypoints to the most significant points of your track, and simplify segments with fewer changes in direction.
- To save a TracBack route, copy route 0 to an open storage route before activating another TracBack. Activating another TracBack or storage route will overwrite the existing TracBack route.
- Whenever a TracBack route is activated, the receiver will automatically erase any temporary waypoints that are not contained in routes 1-19. If there are temporary waypoints stored in routes 1-19, the receiver will create any new temporary waypoints using the first three-digit number available. (You can also quickly delete all temporary TracBack waypoints in memory by using the 'delete by symbol' method described on pg. 21.)

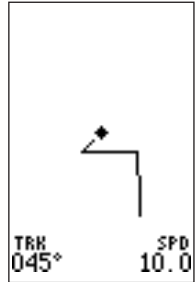

The TracBack feature will navigate your track log back to the oldest point in the receiver's memory.

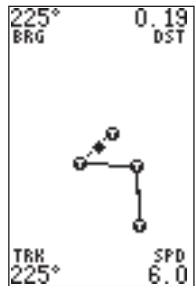

The track log will be divided into segments with temporary waypoints to create a route back to the beginning of the track log.

Route Navigation

The last form of navigating to a destination with the GPS 126/128 is to create a user-defined route. The GPS126/128 lets you create and store up to 20 routes of 30 waypoints each. The route navigation feature lets you plan and navigate a course from one place to another using a set of pre-defined waypoints. Routes are often used when it's not practical, safe, or possible to navigate a direct course to a particular destination (e.g., through a body of water).

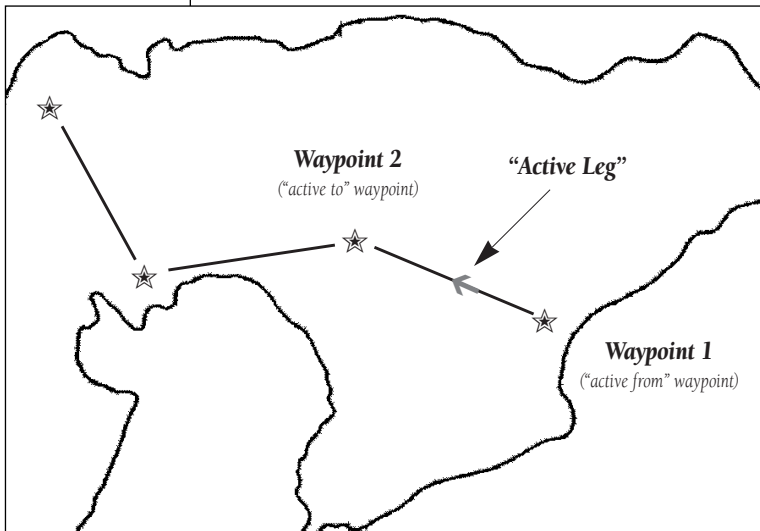

Routes are broken down and navigated in smaller segments called “legs”. The waypoint you are going to in a leg is called the “active to” waypoint and the waypoint immediately behind you is called the “active from” waypoint. The line between the “active to” and the “active from” waypoint is called the “active leg.”

Whenever you activate a route, the GPS 126/128 will automatically select the route leg closest to your position as the active leg. As you pass each waypoint in the route, the receiver will automatically sequence and select the next waypoint as the “active to” waypoint.

Route Definition Page

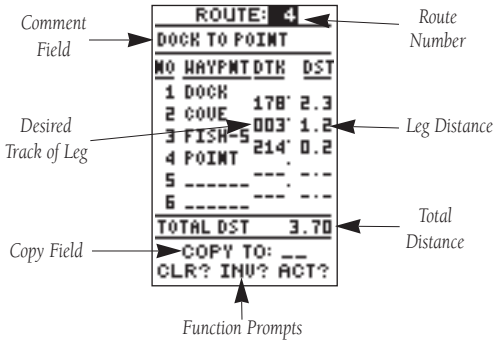

The bottom of the route definition page features 'function' fields which let you copy, clear, invert, or activate the displayed route. Routes 1-19 are used as storage routes, with route 0 always serving as the active route you are navigating. If you want to save a route that's currently in route 0, be sure to copy it to another open route or it will be overwritten by the next route activation.

Routes can be copied, cleared, inverted, and activated through the route definition page.

To select the route definition page:

1. Highlight 'ROUTES' from the Menu Page, and press

ENTER

The 'route number' field is displayed at the top of the page, with a 16-character 'user comment' field to the right. If no user comment is entered, the field displays the first and last waypoint in the route. The waypoint list on the left side of the page accepts up to 30 waypoints for each route, with fields for desired track and distance between legs. The total route distance is indicated below the waypoint list.

REFERENCE

Route Definition Page

MENU
NEAREST WPTS
WAYPOINT LIST
WAYPOINT
PROXIMITY WPTS
ROUTES
DIST AND SUN
MESSAGES
INTERFACE
SYSTEM
NAVIGATION
ALARMS

Routes enable you to store and use groups of frequently used waypoints together.

ROUTE: 4
DOCK TO POINT
NO WAYPT DTK DST
1 DOCK
2 COVE 178' 2.3
3 FISH-5 003' 1.2
4 POINT 214' 0.2
5 -----
6 -----
TOTAL DST 3.70
COPY TO: --
CLR? INV? ACT?

Enter each waypoint in the order you would like to navigate the list. If you enter a waypoint not stored in memory, you'll need to define the position on the waypoint definition page.

Using Routes

ROUTE: 4			
_HILLMAN_LAK3_			
NO	WAYPNT	DTK	DST
1	DOCK	178'	2.3
2	COVE	003'	1.2
3	FISH-5	214'	0.2
4	POINT	---	---
5	---	---	---
6	---	---	---
TOTAL DST			3.70
COPY TO: --			
CLR? INV? ACT?			

You may use up to 16 characters to custom name a route. The default name will be the first and last waypoint in the route.

ROUTE: 4			
HILLMAN LAKE			
NO	WAYPNT	DTK	DST
1	DOCK	178'	2.3
2	COVE	003'	1.2
3	FISH-5	214'	0.2
4	POINT	---	---
5	---	---	---
6	---	---	---
TOTAL DST			3.70
COPY TO: --			
CLR? INV? ACT?			

To activate a route, highlight the 'ACT?' prompt and press ENTER.

Creating and Navigating Routes

To create a route from the route definition page:

1. Highlight the 'route number' field, and press **ENTER**.
2. Using the ▲ or ▼ key select an empty route number and press **ENTER**.
3. Press **ENTER** to begin entry of a route comment.
4. Enter your comment, and press the **ENTER** key.
5. Press **ENTER** to begin entering the first waypoint of your route.
6. Press **ENTER** again to move to the next waypoint field. As you continue entering waypoints, the list will automatically scroll down.

Whenever you activate a route, it will automatically select the route leg closest to your position as the active leg. As you pass each waypoint in the route, the receiver will automatically sequence and select the next waypoint as the "active to" waypoint.

Activating and Inverting Routes

After a route has been entered, it can be either activated in sequence or inverted from the route definition page. The process of activating or inverting a stored route takes a storage route (routes 1-19) and copies it into the active route (route 0) for navigation. The storage route is then no longer needed and will be retained in its original format under its existing route number.

This system allows you to have an active route that you may edit during navigation and save as an entirely new route from the original. You will have to copy the active route to an unused storage route to save it, since new route or TracBack activation overwrites route 0.

To activate a route:

1. From the route definition page, highlight the 'route number' field and press **ENTER**.
2. Enter the route number to be activated, and press **ENTER**.
3. Highlight 'ACT?', and press **ENTER**.

To activate a route in inverted order:

1. Follow the steps above, but select 'INV?', and press **ENTER**.

Active Route, Copying, & Clearing

Active Route Page

Once a route has been activated, the active route page will display the waypoint sequence of your route with the estimated time enroute (ETE) at your present speed and the distance to each waypoint. As long as you are navigating an active route, the active route page will become part of the main page sequence of the unit. The active route page will also allow you to change the 'ete' field to display desired track (DTK) or estimated time of arrival (ETA) for each leg. You can also clear or invert the active route.

To display DTK or ETA for each leg:

1. Highlight 'ETE' or 'DTK', and press **ENTER**.
2. Select 'DTK' or 'ETA', and press **ENTER**.

The active route page also allows you to clear (stop navigating) or invert the active route without using the route definition page.

To invert a route from the active route page:

1. Highlight 'INVERT?', and press **ENTER**.

To stop route navigation:

1. Select 'CLEAR?', and press **ENTER**.

Copying and Clearing Routes

The route definition page is also used to copy a route to another route number. This feature is useful when you make changes to the active (or TracBack) route and want to save the route in its modified form for future use.

To copy a route:

1. Highlight the 'route number' field, and press **ENTER**.
2. Select the route number to be copied, and press **ENTER**.
3. Highlight the 'copy to' field, and press **ENTER**.
4. Scroll through the available routes and select a destination route number. (Only open routes will be available.) Press **ENTER** to copy the route.

To clear a route from memory:

1. Highlight the 'route number' field, and press **ENTER**.
2. Enter the route number, and press **ENTER**.
3. Select 'CLR?', and press **ENTER**.
4. Highlight 'Yes?', and press **ENTER**.

ACTIVE ROUTE			
HILLMAN LAKE			
WAYPNT	ETE	DST	
DOCK	---	---	---
COVE	08:03	1.32	
FISH-5	15:23	2.53	
POINT	16:52	2.77	
---	---	---	---
---	---	---	---
---	---	---	---
---	---	---	---
---	---	---	---
CLEAR? INVERT?			

Active Route Page

Whenever you have an active route, the active route page will appear in the main page sequence after the Compass or Highway Page.

ROUTE: 4			
HILLMAN LAKE			
NO	WAYPNT	DTK	DST
1	DOCK	178'	2.3
2	COVE	003'	1.2
3	FISH-5	214'	0.2
4	POINT	---	---
5	---	---	---
6	---	---	---
TOTAL DST			3.70
COPY TO: 12?			
CLR? INV? ACT?			

To copy a route, select an open storage route and press the ENTER key. If you select a route that is already used, you'll be alerted with a 'Route Full' message.

Editing Routes & On-Route GOTO's

ROUTE: 4			
HILLMAN LAKE			
NO	WAYPNT	DTK	DST
1	DOCK		
2	COU		
3	FISH-5		
4	POINT		
5	-----		
6	-----		
TOTAL DST			3.70
COPY TO: --			
CLR? INU? ACT?			

Use the on-screen menu to select the desired editing function.

ROUTE: 4			
DOCK TO POINT			
NO	WAYPNT	DTK	DST
1	DOCK	178'	2.3
2	COU	003'	1.2
3	FISH-5	214'	0.2
4	POINT		
5	-----		
6	-----		
TOTAL DST			3.70
COPY TO: --			
CLR? INU? ACT?			

To edit or review a route waypoint from the active route page, highlight the desired waypoint and press ENTER.

Editing Routes

A route can be edited anytime after its creation.

To edit a route from the active route page or the route definition page:

1. Select the waypoint you want to edit, and press **ENTER**.

An on-screen menu of editing choices will appear, with options for reviewing, inserting, deleting, or changing the waypoint field highlighted. This field contains the following options:

- **Review?**— reviews the waypoint's definition page
- **Insert?**— adds a new waypoint that precedes the selected waypoint
- **Remove?**— deletes a selected waypoint
- **Change?**— replaces the selected waypoint with a new waypoint

You may delete a waypoint from a route, but only if the route is not active. Note: Editing the original storage route will not affect route 0. If you want to save an edited version of route 0, save it to an open storage route.

On-Route GOTO

At the beginning of this section, we mentioned that the GPS 126/128 will automatically select the route leg closest to your position as the active leg. This may mean that you are not navigating to the first waypoint in the active route. If you want to select a route waypoint with which to begin navigation or you prefer to navigate a route out of sequence, you can perform an 'on-route GOTO' from the active route page.

To perform an 'on-route GOTO' from the active route page:

1. Highlight the desired route waypoint, and press **GOTO**.
2. Once the GOTO waypoint page appears with the waypoint highlighted, press **ENTER**.

Note that after you reach the on-route GOTO waypoint, the GPS 126/128 will automatically resume navigating the rest of the route in sequence.

Navigation Pages

Using the Navigation Pages

Once you've selected a GOTO destination or activated a TracBack, MOB, or Route, the GPS 126/128 will provide graphic steering guidance to the destination with one of two navigation pages:

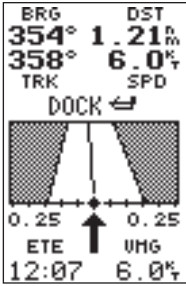

Highway Page

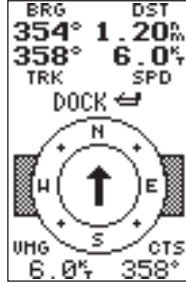

Compass Page

- The **Highway Page** (default) provides a graphic highway that shows your movement relative to the desired course, with an emphasis on your crosstrack error (the distance and direction you are off course). This page also features a course deviation indicator (CDI) (see pg. 35). The Highway Page is well-suited for water or off-road recreation where straight-line navigation is possible.
- The **Compass Page** provides a directional pointer to the destination, with a rotating compass display to show your direction of travel. The Compass Page provides better steering guidance at slow speeds with many changes in direction, where straight-line navigation is not possible.

Both pages provide a digital display of the bearing and distance to the destination, and your current speed and track over the ground. You can switch to either Navigation Page at any time.

To select either Navigation Page:

1. Press **ENTER** from the existing Navigation Page, and **ENTER** again to change the page.

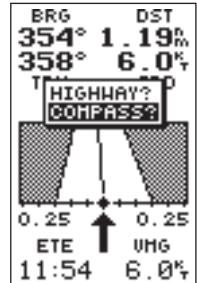

To switch the navigation page to the Highway Page, press ENTER twice.

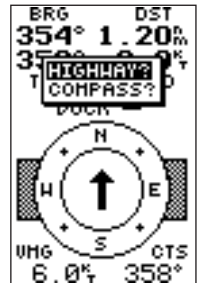

To switch the navigation page to the Compass Page, press ENTER twice.

Navigation Pages

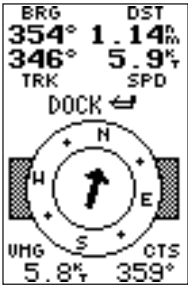

Use the user-selectable fields to customize the navigation pages.

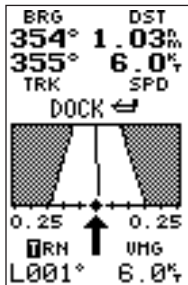

The turn option will show you the number of degrees you need to turn to head directly to your destination.

Selecting a User-Defined Navigation Page (cont.)

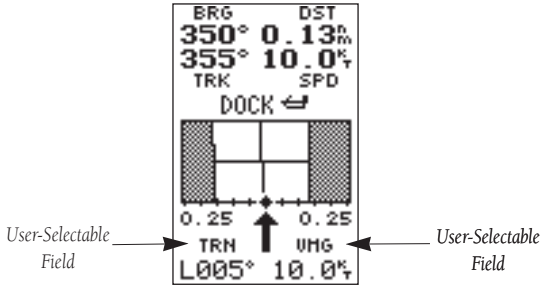

The fields located in the lower corners of both pages are user-selectable fields that allow you to display a variety of navigation values for your trip.

To access the user-selectable fields:

1. Highlight either field, and press **ENTER**.
2. Use the keypad to scroll through the possible options.

The following data options are available from the Navigation Pages:

Estimated Time Enroute (ETE)— the time left to your destination based on your present speed and track.

Estimated Time of Arrival (ETA)— the time of day of your arrival at a destination, based on current ground speed and track.

Course to Steer (CTS)— the bearing which will give you the most efficient way to stay on course to your destination.

Crosstrack Error (XTK)— the distance you are off the desired course in either direction. This field will give you a digital representation of the CDI scale.

Velocity Made Good (VMG)— the speed you are traveling toward the destination.

Turn (TRN)— the amount of correction in degrees needed to travel directly to the destination.

Using the Highway Page

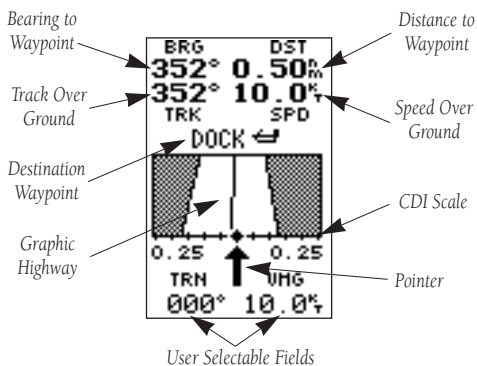

The GPS 126/128's Highway Page provides graphic steering guidance to a destination waypoint, with a greater emphasis on the straight-line desired course and the distance and direction you are off course. The bearing and distance to a waypoint—along with your current track and speed—are displayed at the top of the screen.

The middle of the screen provides visual guidance to your waypoint on a moving graphic "highway." Your present position is represented by the diamond in the center of the CDI scale. The line down the middle of the highway represents your desired track. As you navigate toward a waypoint, the highway will actually move—indicating the direction you're off course—relative to the position diamond on the CDI scale. When the highway is pointing straight up the screen, the waypoint is directly ahead. If the destination waypoint is to the left, the top of the highway will lead to the left, and vice versa. To stay on course, simply steer in the direction the highway leads (left or right) until the highway leads straight up the page.

Below the graphic highway is the "pointer." The pointer shows the direction of the waypoint relative to the direction you are moving.

Below the pointer are two user-selectable fields.

If you do get off the desired course by more than 1/5th of the selected CDI range, the exact distance you are off course will be displayed where the CDI scale setting normally appears. If you get too far off course (the highway has disappeared), a message box will appear to indicate what course to steer to get back on course. (For information on setting this scale, see pg. 48.) When the distance reading reaches 0, you've reached your destination.

REFERENCE

Highway Page

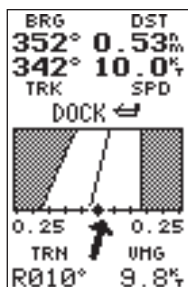

In this example, the Highway Page indicates that you are off course to the left. Steer right to get back on course. Notice the highway always shows the direction to turn. If the highway leads straight up the page, you should continue in your current direction.

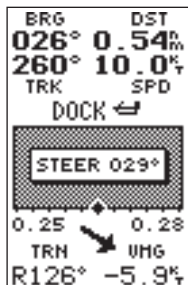

If you get too far off course, a message box will appear to indicate what course to steer to get back on course most efficiently.

Compass Pages

Using the Compass Page

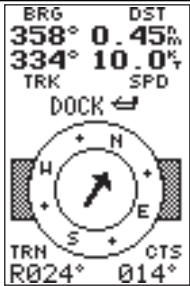

In this example, the compass page indicates that you are traveling in a northerly (334 degrees) direction and the destination waypoint is north (358 degrees) of your current direction of travel.

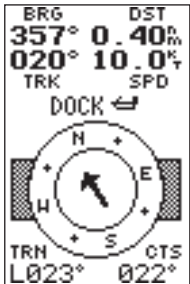

In this example, the compass page indicates that you are traveling in a northerly (020 degrees) direction and the destination waypoint is west (357 degrees) of your current direction of travel.

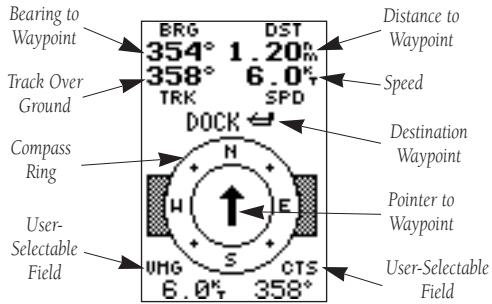

The Compass Page provides better steering guidance for travel at slow speeds (e.g., walking) and for travel with many directional changes.

At the top of the page, the bearing (BRG) and distance (DST) to the waypoint are displayed. The distance displayed is the straight-line distance from your present position to the destination waypoint. The bearing indicates the exact compass heading from you to the destination. Below the bearing and distance, track (TRK) and speed (SPD) are displayed. The track is your course over ground and the speed is your speed over ground.

The middle of the page features a rotating “compass ring” that shows your course over ground while you are moving, with a pointer arrow to the destination displayed in the center. The arrow shows the direction of your destination waypoint, relative to the direction you are moving. For instance, if the arrow points up, you are going directly to the waypoint. If the arrow points any direction (left, right, down, etc.), turn toward the arrow until it points up and then continue in that direction.

The bottom of the page shows two user-selectable fields for ETE, ETA, CTS, XTK, VMG, or TRN.

When you are one minute away from your destination (based on your current speed and track over ground), the GPS 126/128 will alert you with a flashing on-screen message box.

Map Page

The GPS 126/128 features a powerful real-time moving map that does much more than just plot your course and route. The Map Page also provides you with a target cursor that will let you pan ahead to nearby waypoints, determine the distance and bearing to any map position, and mark new waypoints while you navigate.

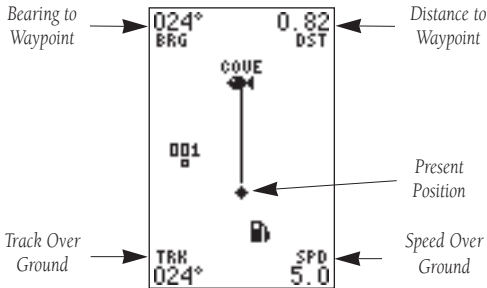

The map contains 12 selectable range scales from 0.2 to 320 miles (0.5 to 600 km). The scale represents the distance shown from the top of the screen to the bottom. Move from scale to scale by using the dedicated zoom keys (IN and OUT). Pressing IN decreases the scale and pressing OUT increases the scale.

A diamond icon in the center of the page represents your present position, with your track and/or route displayed as a solid line. Nearby waypoints are shown with the corresponding name listed. You may select which items are shown through the map setup sub-menu page (see pages 40-41 for more information).

The four corners of the Map Page are used to display various navigation data, including the bearing and distance to a destination waypoint and your current track and speed over the ground. The two fields at the top corners of the map show your bearing and distance to one of three selectable destinations: an active destination waypoint; a highlighted on-screen waypoint; or the panning target crosshair. If you are not navigating to a waypoint or using the panning function, the top data fields will not be displayed. The bottom corners of the display always show your current track and speed.

REFERENCE

Map Page

The image shows a zoomed-in view of the top portion of the Map Page. A black box highlights the fuel gauge, which displays 'FUEL 2.0MH' and 'ZOOM OUT 2.0MH'.

TRK 000° SPD 0.0

Note: A map scale represents the distance shown from the bottom to the top of the Map Page. For example, when viewing the 2 mile scale, the distance represented between the top and bottom of the screen is 2 miles.

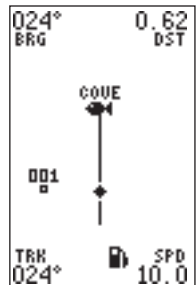

The four corners of the Map Page are used to show your course and speed and the distance to either a cursor or a destination waypoint.

Zooming, Panning, & Pointing

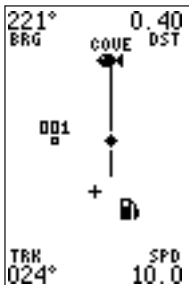

A crosshair will appear when you activate the pan function. The distance and direction of the crosshair from your current position will be shown in the upper corners of the Map Page.

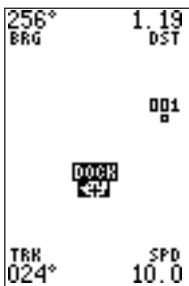

On-Screen Pointing

The crosshair will “snap” to displayed waypoints, which allows you to quickly review or GOTO the selected waypoint right from the Map Page.

Zooming, Panning, and Pointing

There are three main functions you can perform from the Map Page: zooming, panning, and pointing. Zooming is increasing or decreasing the display scale of the map. Panning is using a target crosshair and the arrow keypad to “slide” the map window in any direction, including diagonally, to view the surrounding area. Pointing is the act of highlighting a map position or waypoint on the map in order to create a new waypoint, review waypoint information, or GOTO a selected waypoint or map position.

From the Map Page, you can also access the Map and Track Setup menus (see page 40).

To select a zoom scale (even while panning):

1. Press **IN** or **OUT** once for each level of increase or decrease desired.
2. Press and hold down either key to increase or decrease by more than one scale.

To activate the pan function:

1. Press the arrow keypad in any direction.

As you begin to move the map, a crosshair will appear. This crosshair will now serve as a target marker for the moving map. The distance and bearing from your present position to the target crosshair will appear in the upper corners of the map. If you are conducting a GOTO at the time you activate the panning function, the crosshair bearing and distance will replace the bearing and distance of the GOTO waypoint.

As you pan around the map, you’ll notice that the target crosshair will point to on-screen waypoints and highlight the waypoint name. Once a waypoint name is highlighted, you can review its waypoint definition page or execute a GOTO function right from the Map Page.

To review the definition page for a waypoint highlighted on the map:

1. Press **ENTER**. The waypoint definition page will appear. Review and make any desired changes to the highlighted waypoint.
2. When finished, highlight the ‘DONE?’ field and press **ENTER**.

Using the Cursor

Zooming, Panning, & Pointing (continued)

To go to a waypoint highlighted on the map:

1. Press the **GOTO** key. The GOTO waypoint page will appear with the waypoint's name highlighted.
2. Press the **ENTER** key to confirm.

To stop panning and display present position:

1. Press the **QUIT** key.

Using the Cursor to Mark and GOTO Waypoints



During panning, the crosshair represents a target position right on the moving map, with the range and bearing to the target at the top corners of the screen.

To mark the target crosshair as a waypoint:

1. Press the **ENTER** key to capture the position. The option menu will appear.
2. Select 'MAP POSITION' and press **ENTER**.
3. Enter a new name, symbol, etc., and press **ENTER**.

You can also use the target crosshair as an instant GOTO destination. This function will mark and instantly set a course for a new waypoint called 'MAP'.

To GOTO the target crosshair:

1. Press the **GOTO** key to capture the position.
2. Press the **ENTER** key to confirm the MAP GOTO.

To save the MAP waypoint, rename it, as it will be overwritten the next time a map GOTO is executed.



You may custom tailor the Map Page to show waypoints by any of three options.

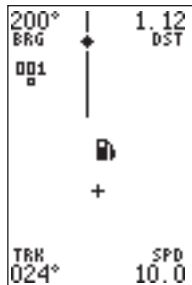

Marking a Cursor Position

To mark a new waypoint with the crosshair, simply pan to the desired position and press the **ENTER** key. Select the appropriate menu option and press **ENTER** again.

Using Cursor & Map/Track Setup



The map setup window gives access to the map setup and track setup pages right from the Map Page.



The Map Page's default screen orientation is track up. "Track Up" means that your current direction of travel is always up (or toward the top of) the screen. It can also be set for north up or desired track up orientation.

Zooming, Panning, and Configuring (cont.)

From the waypoint definition page, you can also define how each individual waypoint is displayed on the map. The GPS 126/128 displays waypoints as a name with a corresponding symbol (e.g., "nearest fuel" and a gas pump symbol), a symbol only (e.g., a fish symbol), or a 16-character comment and corresponding symbol (e.g., "great view" and the camp site symbol). The waypoint name has a six character limit while the 'comment' field has a 16-character limit, and there are 16 individual waypoint symbols available.

To select a waypoint display option:

1. Highlight the symbol field (to the right of the name field), and press **ENTER**.
2. Move the cursor to the 'display' field, and press **ENTER**.
3. Select one of the following display options: 'name with symbol,' 'symbol only,' or 'comment with symbol and press **ENTER**.'
4. Press **ENTER** to confirm the 'DONE?' prompt.
5. Press **ENTER** again (on the waypoint definition page) to return to the Map Page.

The last function you can perform with a waypoint highlighted on the Map Page is to perform a GOTO directly to the waypoint.

To go to a waypoint highlighted on the Map Page:

1. Press **GOTO**.
2. Press **ENTER** to confirm the GOTO waypoint page.

Accessing Map Setup/Track Setup Windows

You can access two additional pages—the map setup page and the track setup page—from the Map Page. Make sure that no waypoints are highlighted on the map and press **ENTER**. The Map Page option menu will appear.

To select map setup or track setup:

1. Highlight the desired choice, and press **ENTER**.

Map & Track Setup

Map Setup Page and Orientation

The map setup page lets you select Map Page and satellite sky view (see pg. 14) orientation, as well as specify what items are displayed. The Map and Satellite Pages may be oriented to 'NORTH UP', 'TRACK UP' (the direction of current travel), or 'DTK UP' (desired track up, or the direction of travel to stay on course). The default setting is track up.

To change the map orientation:

1. Highlight the 'map' field, and press **ENTER**.
2. Select the desired orientation, and press **ENTER**.

Note: Selecting the 'DTK UP' option will set the satellite sky view to track up orientation.

The rest of the map setup page lets you specify what items are displayed or plotted on the Map Page by selecting 'YES' or 'NO' in the appropriate field.

- 'Rings'—displays the three present position range rings on the map.
- 'Route'—plots the straight leg lines between waypoints of an active route and displays all route waypoint names.
- 'Nearest'—shows the nine nearest waypoints to your position (black diamond) on the map.
- 'Names'—displays the waypoint name for the nine nearest waypoints.
- 'Track Log'—displays and plots track points on the map.

To turn a map item on or off:

1. Highlight 'YES' or 'NO' for the specific map item, and press **ENTER**. Select 'YES' or 'NO' and press **ENTER**.

Track Setup Page

The track setup page manages the GPS 126/128's track log data. From this page, you can select whether to record a track log and define how it is recorded.

To turn the track log on or off:

1. Highlight the 'record' field, and press **ENTER**.
2. Select 'OFF, FILL, or WRAP', and press **ENTER**. (Note: Turning the track recording off will prevent using TracBack.



Use the track setup page to control the GPS 126/128 manages your track log.



Entering a time interval into the track recording method will help to increase the distance you can travel without using up your track log. Using a time interval will reduce the effectiveness of TracBack.

Track Log Management



The track setup menu lets you instantly change track features directly from the Map Page.



Clear the track log any time your screen gets cluttered or when starting a new TracBack.

Track Method

The stored track method determines how often positions are stored in the track log. The default setting is automatic, which will store a track based on resolution. This setting gives the most efficient use of track memory and provides the best TracBack route.

To change the method to record points based on a specific time interval:

1. Highlight the 'METHOD' field, and press **ENTER**.
2. Select 'TIME INTERVAL', and press **ENTER** twice.
3. Enter hours, minutes, and seconds, and press **ENTER**.
4. Press **QUIT** to exit the menu.

Track Log Display

The track log option gives you a choice of displaying or not displaying the track log. This only effects the display on the Map Page and not the recording in memory. The track log will still be stored in memory as long as the "record" setting is 'WRAP' or 'FILL'. When set to "on", the display uses 1024 points.

Managing and Clearing the Track Log

The rest of the track setup window displays the percentage of available memory currently used to store track log data, as well as function fields to clear the track log memory and activate the TracBack feature.

To clear the track log:

1. Highlight 'CLEAR LOG?', and press **ENTER**.
2. Highlight 'Yes?', and press **ENTER**.

Note: It's a good idea to clear the track log at the end of the trail head, etc., in order to make the best use of the TracBack feature.

Menu Page & Distance/Sun Calculation

Menu Page

The GPS 126/128's Menu Page provides access to additional pages (submenus) that are used to select and customize operation and navigation setup. These eight pages are divided into categories by function. We've already gone over the waypoint and route management pages in their respective sections. Let's review the rest of these pages as they appear on the Menu Page.

To select a submenu page from the Menu Page:

1. Highlight the page, and press **ENTER**.
2. To return to the Menu Page, press **QUIT**.

Distance and Sun Calculations

The distance and sun calculation page will give you the distance and bearing between any two waypoints or between your present position and a waypoint. It will also calculate the sunrise and sunset (in local time) for a particular date at either your present position or any stored waypoint.

To perform a distance and sun calculation:

1. Highlight the 'from' field and press **ENTER**. Enter the desired waypoint, and press **ENTER**.
2. Highlight the 'to' field and press **ENTER**. Enter the destination waypoint, and press **ENTER**.
3. The 'date' field will become highlighted. Press **ENTER** to enter the date you'll arrive at your destination, and press **ENTER**.

If you haven't marked your present position as a waypoint or you leave the 'to' field blank, the sunrise and sunset at your present position will be shown.

Message Page

The message page is used to display all messages in the GPS 126/128. There are two types of messages: temporary alerts (e.g., approaching a waypoint) and condition alerts (e.g., WPT memory is full). All messages are indicated by a flashing on-screen box. After a temporary alert has been viewed, it is cleared. Condition alerts are displayed on the message page until the condition has been resolved.

To view the message page:

1. Highlight the 'MESSAGES' field and press **ENTER**.

See Appendix C for a complete list of messages.

HENU
NEAREST WPTS
WAYPOINT LIST
WAYPOINT
PROXIMITY WPTS
ROUTES
DIST AND SUN
MESSAGES
INTERFACE
SYSTEM
NAVIGATION
ALARMS

The Menu Page allows you access to a variety of waypoint, route, system and setup features.

DIST AND SUN
FROM: HOME
TO: COVE
BRG DST
282° 12.2%
DATE: 12 NOV 97
SUNRISE
06:57:37am
SUNSET
05:08:55pm
AT DESTINATION

The GPS 126/128 will calculate the sunrise and sunset times of any stored waypoint or your present position. To calculate, enter the date and year and press ENTER.

Interface Setup & DGPS

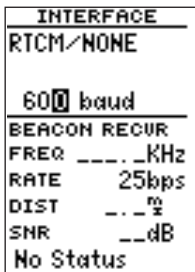

The selectable baud rate is available for all RTCM interface options.

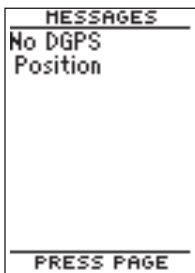

Alert messages will signal any problems with DGPS operation.

Interface Setup

The GPS 126/128's interface page lets you specify the formats for connecting external devices. There are six options: GRMN/GRMN, None/None, RTCM/None, RTCM/NMEA, NMEA/NMEA, and None/NMEA. Each option lists the input format first, followed by the output format.

To select I/O format:

1. Highlight the I/O field, and press **ENTER**.
2. Select the desired setting, and press **ENTER**.

The GRMN/GRMN setting is a proprietary format that lets you exchange information such as waypoints, routes, and track logs between two GARMIN GPS units or a GARMIN GPS and a PC. There are ten data transfer options: send alm, send wpt, send trk, send rte, send prx, request alm, request wpt, request trk, request rte, request prx.

To select a transfer option:

1. Highlight 'HOST', and press **ENTER**.
2. Select a desired setting, and press **ENTER**.

To disable all interfacing capabilities, select the None/None setting. If you want to output NMEA data without any differential input capability, select 'None/NMEA.'

DGPS Interface

The last two format settings allow the differential-ready GPS 126/128 to accept RTCM DGPS corrections in RTCM 104 version 2.0 format. Using DGPS corrections will improve receiver accuracy to 1-5 meters, regardless of errors induced by the government's Selective Availability (SA) program. Two RTCM options are available: RTCM/NONE, which allows connection to a beacon receiver with no output capability; and RTCM/NMEA, which allows DGPS input and NMEA output.

Once a RTCM setting has been selected, the GPS 126/128 will either automatically try to tune the last frequency and bit rate you selected or will switch to the default frequency of 304.0 kHz with a bit rate of 100 bps if no previous beacon has been tuned. You may also enter your own frequency and bit rate if desired.

DGPS Interface

To enter a DGPS beacon frequency:

1. Highlight the 'freq' field, and press **ENTER**.
2. Enter the desired frequency, and press **ENTER**.
3. Highlight the 'rate' field, and press **ENTER**.
4. Select the desired transmission rate, and press **ENTER**.

Note: The 'freq' and 'rate' fields are active only when the interface is set to RTCM/NMEA.

When the GPS 126/128 is receiving DGPS corrections from the GBR 21, the 'beacon receiver' section of the I/O setup page will display the beacon frequency and signal strength, as well as the distance from the transmitter to the beacon receiver. At the bottom of the beacon receiver field, a status message will keep you informed of DGPS activity:

- A 'Tuning' message will be displayed while a beacon signal is being tuned.
- Once the beacon signal has been tuned, a 'Receiving' message will be displayed.
- If a beacon signal is tuned and no corrections are being received, a 'No Data' message will be displayed.
- If a beacon signal cannot be tuned, a 'No Status' message will be displayed.

The message page will alert you to any problems relating to DGPS operation. You may also monitor the DGPS status from the status field on the interface page. The GPS 126/128 will display one of three alert messages concerning DGPS operation:

No DGPS Position— there is not enough data available to compute a DGPS position.

No RTCM Input— the beacon receiver is not properly connected or the baud rates do not match.

RTCM Input Failed— DGPS data was being received but has been lost.

```

INTERFACE
RTCM/NONE?
HOST
WAITING...

---- of ----
PACKETS
  
```

Choose an interface option based upon what equipment you are using to transfer information.

```

INTERFACE
RTCM/NMEA
NMEA 0183 2.0
4800 baud
BEACON RECUR
FREQ: ---- KHz
RATE: 100bps
DIST  --m
SNR   --dB
No Status
  
```

Once the RTCM/NMEA option is selected, you can manually tune the beacon receiver from the frequency field.

System Setup, Date/Time & Time Format

SYSTEM SETUP	
MODE:	Simulator
DATE	12 NOV 97
TIME	11:29:45am
OFFSET:	-06:00
HOURS:	12
CONTRAST:	
LIGHT:	15 SEC
TOUR:	MSG, KEY

The GPS 126/128's two operating modes are accessed through the system setup submenu.

SYSTEM SETUP	
MODE:	Simulator
DATE	12 NOV 97
TIME	11:29:57am
OFFSET:	-06:00
HOURS:	12
CONTRAST:	
LIGHT:	15 SEC
TOUR:	MSG, KEY

To display the correct local time, you must enter the appropriate offset from the chart at the end of Appendix C.

System Setup

The system setup page is used to select the operating mode, time offset, and screen preferences. The GPS 126/128 has two operating modes:

- **Normal Mode** operates the unit using satellite tracking information.
- **Simulator Mode** allows you to operate the unit without acquiring satellites, and is ideal for practicing or entering waypoints and routes while at home.

To select an operating mode:

1. Highlight the 'mode' field, and press **ENTER**.
2. Select a mode, and press **ENTER**.

Date and Time Setup

The date and time is located directly below the mode field.

Note: Date and time information is derived from the GPS satellites and cannot be changed by the user.

Because the time shown is UTC time (Greenwich mean time), you will need to enter a time offset to display the correct local time for your area. To determine the time offset for your area, note your position and refer to the chart in Appendix D.

To enter the time offset:

1. Highlight the 'offset' field, and press **ENTER**.
2. Enter the time offset, and press **ENTER**.

Note: Move the cursor to the left to change the plus or minus sign.

Time Format

The time display shown on the system setup and Position Pages may be set to display the time in a 12- or 24-hour format.

To select the time format:

1. Highlight the 'hours' field, and press **ENTER**.
2. Select 12- or 24-hour display, and press **ENTER**.

Screen Contrast & Backlighting

Screen Contrast

The GPS 126/128 has adjustable screen contrast controlled by an on-screen bar scale.

To set the screen contrast from the Menu Page:

1. Highlight the 'contrast' field, and press **ENTER**.
2. Adjust the bar scale to the desired contrast, and press **ENTER**.

Note: The screen contrast can also be adjusted by pressing the rocker keypad while viewing the Satellite Page (see pg. 13).

Screen Backlighting Timer

The screen backlight timer is adjustable for 15, 30, 60, 120, or 240 seconds. The timer also may be set to the "Stay On" setting for continuous use. Whenever backlighting is on, a bulb icon will appear on the Satellite Page.

To set the backlight timer:

1. Highlight the 'light' field, and press **ENTER**.
2. Select the desired setting, and press **ENTER**.
3. To turn lighting on and off, press the **☰** briefly.

Navigation Setup

The navigation setup submenu page is used to select units of measurement for position formats, map datums, CDI scale, units, and heading information.

Position Formats

The default position format for the GPS 126/128 is latitude and longitude in degrees and minutes (hddd°mm.mmm'). You may also select degrees, minutes and seconds (hddd°mm'ss.s"); degrees only (hddd.ddddd°); UTM/UPS coordinates; or British, German, Irish, Maidenhead, Swedish, Swiss, or Taiwan, or User grid formats.

To select a position format:

1. Highlight the 'position format' field, and press **ENTER**.
Select the desired setting, and press **ENTER**.

SYSTEM SETUP	
MODE:	Simulator
DATE	12 NOV 97
TIME	11:30:42am
OFFSET:	-06:00
HOURS:	12
CONTRAST:	██████████
LIGHT:	<input checked="" type="checkbox"/> STAY ON
TOUR:	MSG, KEY

The "Stay On" setting will keep your backlighting on continuously.

NAV SETUP	
POSITION FRMT:	hddd°mm'ss.s"
MAP DATUM:	WGS 84
CDI:	±0.25
UNITS:	Nautical
SPEED FILTER:	Auto
HEADING:	Auto Mag E004

The position format may be set to display your choice of many formats. Note: degree and minutes is the default setting.

Datums, CDI Settings, & Measurement

NAV SETUP	
POSITION FRMT:	hddd°mm'ss.s"
MAP DATUM:	WGS 84
CDI:	±0.25
UNITS:	Nautical
SPEED FILTER:	Auto
HEADING:	Auto Mag E004

The default map datum will cover worldwide navigation. However, if you are using a paper map or chart which uses a different map datum than WGS 84, then you may wish to switch to that datum.

NAV SETUP	
POSITION FRMT:	hddd°mm'ss.s"
MAP DATUM:	User
CDI:	±0.25
UNITS:	Nautical
SPEED FILTER:	Auto
HEADING:	Auto Mag E004

The user datum feature allows you to define the earth model used to calculate position coordinates.

WARNING: Incorrect entries may result in substantial position errors.

User Grid Option

The user grid option lets you create a user-defined position format by establishing factors such as longitude of origin, scale, and false Easting or Northing.

To define a user grid:

1. Select 'User Grid', and press **ENTER**. Enter values for longitude origin, scale, false Easting and Northing, then press **ENTER**. Highlight 'SAVE?', and press **ENTER**.

Map Datums

The 'datum' field is located just below the 'position' field and comes with a WGS 84 default setting. Although 106 total map datums are available for use (see Appendix D for map datums), you should only change the datum if you are using maps or charts that specify a different datum than WGS 84.

To select a map datum:

1. Highlight the 'datum' field, and press **ENTER**.
2. Select the desired setting, and press **ENTER**.

To define a user datum:

1. Highlight the 'datum' field, and press **ENTER**.
2. Scroll through the map datum options until 'User' appears, and press **ENTER**.
3. Enter values for 'DX', 'DY', 'DZ', 'DA', and 'DF' using the rocker keypad, and press **ENTER**.
4. Highlight 'SAVE?', and press **ENTER**. The setup menu will reappear.

CDI Scale Settings

The course deviation indicator (CDI) field lets you select the +/- range of the CDI bar scale on the Highway Page. Three scales are available: +/- 0.25 (default), 1.25, and 5.0 miles or kilometers. Note: This CDI value represents the full deflection of scale to either side.

To enter a CDI scale setting:

1. Highlight the 'cdi scale' field, and press **ENTER**.
2. Select the desired setting, and press **ENTER**.

Units of Measure

The GPS 126/128 lets you select statute (default), nautical, or metric units of measure for all 'speed' and 'distance' fields.

Speed Filter and Magnetic Heading

To change the unit of measure:

1. Highlight the 'units' field, and press **ENTER**.
2. Select the desired unit of measure, and press **ENTER**.

Speed Filter

The speed filter allows you to determine how the GPS 126/128 responds to changes in track or ground speed. Three settings are available: automatic, on, or off. The 'Auto' setting is the default and will monitor changes in your current track and speed and adjust the receiver's response time automatically. The 'On' setting allows you to manually enter a response time up to 300 seconds. Selecting a higher setting may be desirable in slow-speed applications with frequent changes in track.

To enter a value for the speed filter:

1. Highlight the 'SPEED FILTER' field and press **ENTER**.
2. Select the 'ON' option and press **ENTER**.
3. Highlight the "speed value" field and press the **ENTER** key.
4. Use **▲** and **▼** to select the desired number of seconds.
5. Press the **ENTER** key to confirm the selection.

Magnetic Heading Reference

The GPS 126/128's heading information can be displayed referencing magnetic north (automatic or user-defined), true north, or calculated grid headings. The default setting is automatic magnetic north, which is suitable for most applications.

To select a heading reference:

1. Highlight the 'heading' field, and press **ENTER**.
2. Select the desired heading preference, and press **ENTER**.

To enter a user-defined magnetic heading:

1. Select 'User Mag' and press **ENTER**.
2. Press **ENTER**, enter the degrees and direction of magnetic variation, then press **ENTER**.

NAV SETUP
POSITION FRMT: hddd°mm'ss.s"
MAP DATUM: WGS 84
CDI: ±0.25
UNITS: Nautical
SPEED FILTER: On 012 SEC
HEADING: Auto Mag E004

The number entered represents a window of time the GPS 126/128 considers in adjusting to changes in speed and track. For example, if 12 seconds is entered, the speed displayed will constantly represent the speed averaged over the last 12 seconds.

NAV SETUP
POSITION FRMT: hddd°mm'ss.s"
MAP DATUM: WGS 84
CDI: ±0.25
UNITS: Nautical
SPEED FILTER: Auto
HEADING: User Mag: E000

To enter a user-defined magnetic variation, select the 'User Mag' option and enter the desired direction and value.

Alarms Setup

ALARMS SETUP	
Anchor Drag:	0.00% Off
Arrival:	1.2% On
CDI Alarm:	0.0% Off

When activated, the arrival alarm will sound when you reach the specified distance from your destination waypoint.

ALARMS SETUP	
Anchor Drag:	0.00% Off
Arrival:	1.2% On
CDI Alarm:	0.2% On

Use the CDI alarm to ensure you maintain a straight-line course to the destination waypoint.

Alarms Setup

The alarms setup page is used to set the three alarms available on the GPS 126/128: the anchor drag alarm, arrival alarm, and CDI alarm.

The anchor drag alarm will sound if your boat has moved outside a range measured from a central point (your position). The arrival alarm sounds when you are approaching a waypoint and have reached the user defined distance. The CDI alarm will alert you when your track varies from the shortest distance to a waypoint by the defined range.

The arrival and CDI alarms may be set from 0.0 to 9.9 units. The anchor drag alarm may be set up to 9.99 distance units.

To set the alarms:

1. Move the highlight to 'ALARMS SETUP' and press **ENTER**.
2. Select the desired alarm distance field and press **ENTER**.
3. Enter the distance for the alarm and press **ENTER**.
4. If you would like to change the 'On/Off' setting, press the **ENTER** key and use the **▲** and **▼** keys to turn the alarm on or off.
5. Enter a setting and press the **ENTER** key.



When setting the anchor drag alarm, remember that Selective Availability can degrade your GPS position as much as 100 meters and may cause false anchor drag alerts.

Navigation Simulator

Navigation Simulator

The GPS 126/128's simulator mode lets you practice all aspects of its operation without active satellite acquisition. You can plan and practice trips, enter new waypoints and routes, and save them for use during normal operation.

To activate the simulator:

1. From the Menu Page, highlight 'SYSTEM SETUP', and press **ENTER**.
2. Highlight the 'mode' field, and press **ENTER**.
3. Select 'Simulator?', and press **ENTER**.

Once the simulator mode has been activated, use the Position, Compass, or Highway Page to set your speed and track by highlighting the appropriate field, entering the desired value, and pressing **ENTER**. You may also enter a new position if you desire (from the Position Page).



The GPS 126/128 does not track satellites in simulator mode. Although you can create and save waypoints and routes while using the simulator mode, never attempt to use the simulator mode for actual navigation.

SYSTEM SETUP
MODE: Simulator
DATE 12 NOV 97
TIME 11:32:51am
OFFSET: -06:00
HOURS: 12
CONTRAST: ██████
LIGHT: 15 SEC
STONE: MSG, KEY

Select the simulator mode from the operation mode choices and press **ENTER**. You may return to normal operation by changing the operation mode or by turning the unit off.

Initialization



Welcome Page

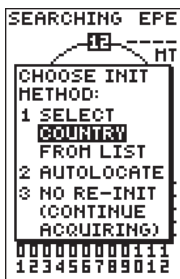

The EZinit prompt will automatically appear if the receiver needs to be initialized. The prompt may also appear during normal use if the antenna is shaded.

Initializing for First-Time Use

The GPS 126/128 typically acquires a position so fast that initialization is automatic. However, initialization will be necessary for the following:

- After memory loss
- When the receiver has been moved more than 500 miles with the power off

Additionally, it may be necessary to initialize the unit the first time you use it, if it does not acquire a fix in a few minutes.

The receiver is shipped from the factory in AutoLocate™ mode, which enables the GPS 126/128 to determine its location anywhere in the world. To speed up the initialization process, we recommend using the graphic initialization described below.

To turn the GPS 126/128 on:

1. Press and hold **POWER** until the receiver turns on.

The welcome page will be displayed while the unit conducts a self test.

Once testing is complete, the welcome page will be replaced by the Satellite Page, with the EZinit prompt ready for you to select one of two initialization methods:

- **Select Country**—allows you to initialize the receiver by selecting your present position from a list of countries in the GPS 126/128's internal database. This may speed up the initialization process.
- **Autolocate™**—allows the GPS 126/128 to initialize itself and calculate a position fix without knowing your present position. This usually provides a position fix in 3-5 minutes.

If the EZinit prompt has not automatically appeared on the Satellite Page:

1. Press the **ENTER** key.

Note: If the EZinit prompt ever appears after you have initialized the receiver (due to the antennas view of satellites being obstructed by trees, etc.), highlight the 'no re-init' selection with the arrow keypad and press **ENTER**.

Initialization

To initialize the receiver:

1. If the 'country' option is not highlighted, press the ▼ key repeatedly to move the field highlight to the 'COUNTRY' option.
2. Press the **ENTER** key.
3. Use the ▼ key to scroll through the list options until the country of your present position appears.
4. Use the ▲ key to highlight the country/state/region you're in. If the country you're in is not listed, select another country within 500 miles of your present position.
5. Press **ENTER** to finish.

The GPS 126/128 will now begin searching for the appropriate satellites for your location and should acquire a position within 3-5 minutes. You can verify that you have acquired a position by watching the Satellite Page transition to the Position Page (provided you haven't pressed any other buttons) or by looking for a '2D NAV' or '3D NAV' status at the top-left corner of the Satellite Page.

Initialization Troubleshooting

If you have trouble initializing the receiver or acquiring a position, check the following:

- **Does the unit have a clear view of the sky?**

If there are large buildings or mountains nearby, or if there is heavy tree cover, the receiver may not be receiving enough satellite signals to calculate a position.

- **Have you selected the right country/state/region from the EZinit list?**

Check for the correct approximate lat/lon on the Position Page, or reselect the appropriate country from the list to restart the initialization.

- **Have you moved more than 500 miles from the last calculated position with the receiver off?**

Reinitialize the receiver, selecting the country/state/region of your new location from the EZinit list.

COUNTRY LIST

Turks Caicos Isl
Tuvalu
Uganda
Ukraine
U A Emirates
UK-England
UK-Ireland
UK-Scotland
UK-Wales
USA-AK

Use the arrow keypad to highlight the country, region, or state of your present position from the list and press ENTER. If the country is not listed, select the closest country instead.

Mounting the GPS 126

The GARMIN GPS 126 should be mounted in an exposed location with an unobstructed view of the sky. The unit comes with a gimbal bracket that can be used to surface mount the unit. When choosing a location for the display unit, make sure you consider the following conditions:

- There should be at least 2" (5 cm) clearance behind the case to allow connection of the power/data cable.
- The mounting surface should be rigid enough to support the unit and protect it from excessive vibration and shock.
- The built in antenna has an unobstructed view of the sky.

To surface mount the GPS 126:

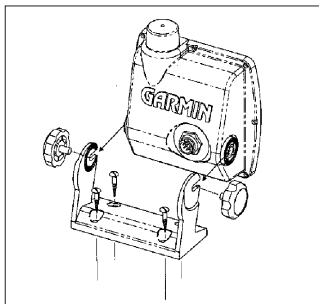

1. Place the mounting bracket in the desired location.
2. Mark and drill the four mounting holes for the fasteners you are using (not included).
3. Fasten the bracket to the surface using the appropriate fasteners.
4. Insert the GPS 126 into the mounting bracket.
5. Screw the two mounting knobs through the bracket and into the GPS 126.
6. Connect the power/data cable to the back of the unit, making sure the locking ring is engaged.

Mounting the GPS 128

The GPS128's compact case is suitable for mounting in exposed locations or at the nav station. The unit comes with a gimbal mount that can be used for surface, overhead, or flush mounting the unit. When choosing a location for the display unit, make sure you consider the following conditions:

- There should be at least 2" (5 cm) clearance behind the case to allow connection of the power/data cable.
- The mounting surface should be rigid enough to support the unit and protect it from excessive vibration and shock.

To surface mount the GPS 128:

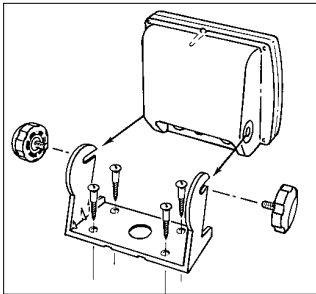

1. Place the mounting bracket in the desired location.
2. Mark and drill the four mounting holes for the fasteners you are using (not included).
3. Fasten the bracket to the surface using the appropriate fasteners.
4. Insert the GPS 128 into the mounting bracket.
5. Screw the two mounting knobs through the bracket and into the GPS 128.
6. Connect the power/data cable and antenna to the back of the unit, making sure the locking rings are engaged.

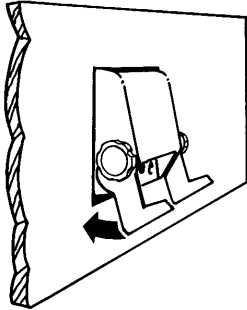
To flush mount the GPS 128:

The GPS 126/128 can be mounted flush with a flat panel of .08-.52" thickness using the cam lobe feature on its mounting bracket.

1. Cut a 4.15" W x 4.67" H hole in panel.
2. Place GPS 128 into hole from the front until its flange rests against the mounting surface.
3. From the back side of the panel, loosely attach the bracket such that the slot in the ratchet area points away from the mounting panel.
4. Rotate the bracket downward until the panel is pinched tightly between the units flange and bracket lobe.
5. Tighten knobs and connect the power/data and antenna cables. Note: If the panel is too thick to allow use of the supplied knobs, use two M6 screws to secure the bracket.

Mounting the GPS 128 antenna

The antenna should be mounted in a location that has a clear, unobstructed view of the sky in all directions to ensure the best reception. Avoid mounting the antenna where it will be shaded by the boat's superstructure, a radome antenna, or mast. Sailboat users should avoid mounting the antenna high on the mast to prevent inaccurate speed readings caused by excessive heeling. Most marine VHF and Ioran antennas will not seriously degrade the GPS antenna's reception. Never paint the antenna or clean it with harsh solvents.

The GARMIN antenna screws directly onto any standard 1" x 14-thread antenna mount. If you need to raise the antenna to avoid shading, try using a 1" x 14-thread extension mast available at most marine dealers.

To install the GPS antenna:

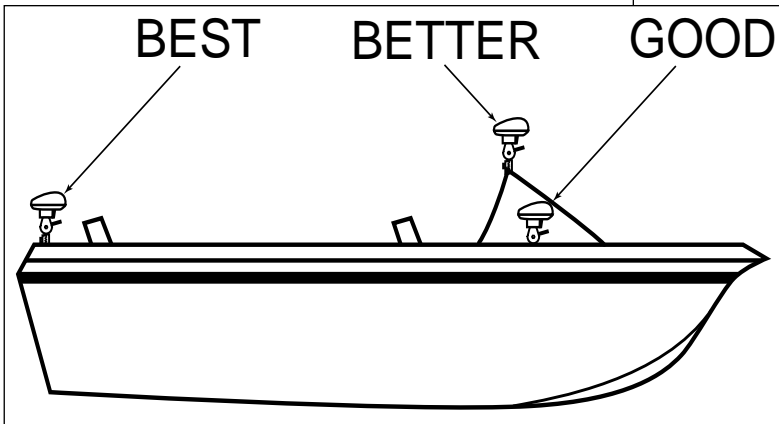

1. Screw the antenna directly onto the 1" x 14-thread mount.
2. Route the cable to the mounting location of the display unit. Use the appropriate tie-wraps, escutcheon plates and sealant to secure the cable along the route and through any bulkhead or deck.
3. Once the GPS 128 has been installed, connect the cable to the antenna connector on the back of the display unit. Make sure that you turn the antenna cable connector 1/4 turn clockwise to lock the cable into place.

Specifications & Wiring

The GPS 126/128 is constructed of high quality materials and should not require user maintenance. Should your unit ever need repair, please take it to an authorized GARMIN service center or contact the GARMIN customer service department. The GPS 126/128 has no user serviceable parts. Never attempt any repairs yourself.

To protect your GPS, never allow gasoline or other solvents to come in contact with the case or screen. Clean the case and screen with a soft cloth and a household window cleaner.

PHYSICAL

Case:	Waterproof*
Size:	4.9"H x 5.3"W x 2.4"D (15.6 x 5.1 x 1.23 cm)
Weight:	Less than 1 lb. (454g)
Temperature Range:	5° to 158°F (-15° to 70°C)

PERFORMANCE

Receiver:	12 Parallel-Channel
Acquisition Time:	Approx. 15 seconds (warm) Approx. 45 seconds (cold) Approx. 5 minutes (AutoLocate)
Update Rate:	1/second, continuous
Position Accuracy:	1-5 meters (3-17 ft.) with DGPS corrections** 15 meters (49 ft.) RMS***
Velocity Accuracy:	0.1 knot RMS steady state
Dynamics:	Performs specification to 6g's

POWER

Input:	10-40v DC
Usage:	2 watts

Specifications subject to change without notice

* Meets IEC (European Community Specification) 529 IPX7 for protection against immersion for 30 minutes at a depth of 1 meter.

** With optional GARMIN GBR 21 Beacon Receiver Input.

***Subject to accuracy degradation to 100m 2DRMS under the U.S. DOD-imposed Selective Availability Program.

Connecting the power/data cable

The power/data cable connects the GPS 126/128 system to a 10-40 volt DC power source and provides interface capabilities for connecting NMEA devices and an external alarm. The diagram below indicates the appropriate harness connections.

To connect the GPS 126/128 to a power source:

1. Connect the RED harness lead to the positive side of a 10-40 volt DC power source. Make sure the power lead has an in-line 1-amp fuse installed.
2. Connect the BLACK harness lead to a ground strip or the negative side of a 10-40 volt DC power source.

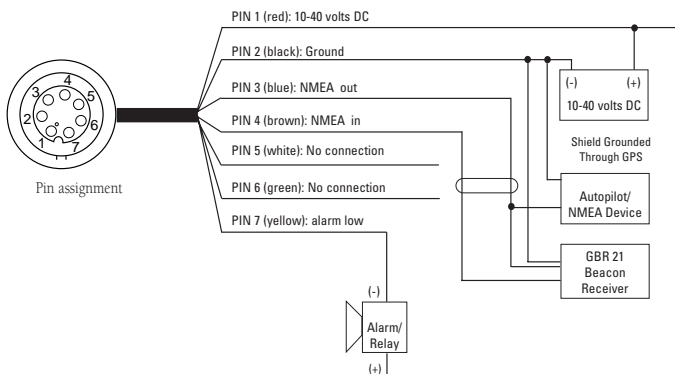

To connect an external alarm, connect the ground side of the alarm device to the YELLOW harness lead. (100 mA DC load max.) The following interface formats are supported by the GPS 126/128 for driving three NMEA devices:

NMEA 0180, NMEA 0182,

NMEA 0183 version 1.5:

Approved sentences:

GPBWC, GPGLL, GPRMB, GPRMC, GPXTE,
GPVTG, GPWPL, GPBOD

Proprietary sentences:

PGRMM (map datum), PGRMZ
(altitude), PSLIB (beacon rec. control)

NMEA 0183 version 2.0:

Approved sentences:

GPGGA, GPGLL, GPGSA, GPGSV,
GPRMB, GPRMC, GPRTE, GPWPL, GPBOD

Proprietary sentences:

PGRME (estimated error), PGRMM (map
datum), PGRMZ (altitude), PSLIB (beacon
receiver control)

Messages & Time Offsets

The GPS 126/128 uses a flashing on-screen message indicator to alert you to important information. Whenever the message indicator appears, press PAGE to view the message page. There are two types of messages: temporary alerts and condition alerts. Temporary alerts are cleared from the message page after viewing, while condition alerts remain until the condition has been resolved. Pay careful attention to all messages for your own safety.

Active WPT Can't be Deleted—You have attempted to change the “active to” or “active from” waypoint. Clear the active route or GOTO before making your changes.

Accuracy has been Degraded—The accuracy of the GPS 126/128 has been degraded beyond 500 meters due to poor satellite geometry or data quality. You should check other navigational sources to verify the position indicated.

Already Exists—The name you are entering already exists in the GPS 126/128's memory.

Approaching—You are one minute away from reaching a destination waypoint.

No DGPS Position—Not enough data is available to compute a DGPS position.

No RTCM Input—Beacon receiver is improperly connected or baud rates do not match.

Poor GPS Coverage—The GPS 126/128 cannot acquire the necessary number of satellites to compute a position. Try another location with a clearer view of the sky.

Power Down and Re-init—The GPS 126/128 is not able to calculate a position due to abnormal satellite conditions. Turn the unit off and verify the last position shown by other means. Try the unit again later, possibly in a different location.

Read Only Mem has Failed—The permanent memory has failed and the unit is not operable.

Received an Invalid WPT—A waypoint was received during upload transfer that has an invalid identifier.

Receiver has Failed—A failure in receiver hardware has been detected. If this message persists, do not use the unit and take it to an authorized dealer for repair.

Route is Full—You have attempted to add more than 30 waypoints to a route.

Route is not Empty—You have attempted to copy into a route already in use.

Route Waypoint Can't be Deleted—The waypoint you are trying to delete is part of a route. Delete the waypoint from the route before removing it from memory.

Route Waypoint was Deleted—A route waypoint entered does not exist in the database and has been deleted from the route.

RTCM Input has Failed—DGPS data being received has been lost. You are no longer receiving the beacon signal.

Searching the Sky—The GPS 126/128 is in searching the sky for almanac data or the unit is in AutoLocate™ mode.

Messages & Time Offsets

Stored Data was Lost—All waypoints, routes, time and almanac data has been lost due to internal battery failure or clearing the receiver's memory.

Transfer has been Completed—The receiver is finished uploading or downloading information to the connected device.

WPT Memory is Full—You have used all 500 waypoints in the GPS 126/128. Delete unwanted waypoints to make room for new entries.

Time Offset Chart

The table below gives approximate UTC time offset for various longitudinal zones. If you are in daylight savings time, add one hour to the offset.

Longitudinal Zone	Offset	Longitudinal Zone	Offset
W180.0° to W172.5°	-12	E007.5° to E022.5°	1
W172.5° to W157.5°	-11	E022.5° to E037.5°	2
W157.5° to W142.5°	-10	E037.5° to E052.5°	3
W142.5° to W127.5°	-9	E052.5° to E067.5°	4
W127.5° to W112.5°	-8	E067.5° to E082.5°	5
W112.5° to W097.5°	-7	E082.5° to E097.5°	6
W097.5° to W082.5°	-6	E097.5° to E112.5°	7
W082.5° to W067.5°	-5	E112.5° to E127.5°	8
W067.5° to W052.5°	-4	E127.5° to E142.5°	9
W052.5° to W037.5°	-3	E142.5° to E157.5°	10
W037.5° to W022.5°	-2	E157.5° to E172.5°	11
W022.5° to W007.5°	-1	E172.5° to E180.0°	12
W007.5° to E007.5°	0		

Map Datums

The following list shows the map datums available for the GPS 126/128 Menu page abbreviations are listed first, followed by the corresponding map datum name and area. The default map datum for the GPS 126/128 is WGS 84.

Adindan	Adindan- Ethiopia, Mali, Senegal, Sudan	Easter Isld 67	(New Georgia Islands) Easter Island 1967
Afgooye	Afgooye- Somalia	European 1950	European 1950- Austria, Belgium, Denmark, Finland, France, Germany, Gibraltar, Greece, Italy, Luxembourg, Netherlands, Norway, Portugal, Spain, Sweden, Switzerland
AIN EL ABD '70	AIN EL ANBD 1970- Bahrain Island, Saudi Arabia	European 1979	European 1979- Austria, Finland, Netherlands, Norway, Spain, Sweden, Switzerland
Anna 1 Ast '65	Anna 1 Astro '65- Cocos Isl.	Finland Hayfrd	Finland Hayford- Finland
ARC 1950	ARC 1950- Botswana, Lesotho, Malawi, Swaziland, Zaire, Zambia, Zimbabwe	Gandajika Base	Gandajika Base- Republic of Maldives
ARC 1960	ARC 1960- Kenya, Tanzania	Geod Datm '49	Geodetic Datum '49- New Zealand
Ascnsn Isld '58	Ascension Island '58- Ascension Island	Guam 1963	Guam 1963- Guam Island
Astro B4 Sorol	Astro B4 Sorol Atoll- Tern Island	Gux 1 Astro	Gux 1 Astro- Guadalcanal Island
Astro Bcn "E"	Astro Beacon "E"- Iwo Jima	Hjorsej 1955	Hjorsej 1955- Iceland
Astro Dos 71/4	Astro Dos 71/4- St. Helena	Hong Kong '63	Hong Kong '63- Hong Kong
Astr Stn '52	Astronomic Stn '52- Marcus Island	Hu-Tzu-Shan	Hu-Tzu-Shan Taiwan
Astrln Geod '66	Australian Geod '66- Australia, Tasmania Island	Indian Bngldsh	Indian- Bangladesh, India, Nepal
Astrln Geod '84	Australian Geod '84- Australia, Tasmania Island	Indian Thailand	Indian- Thailand, Vietnam
Austria	Austria	Indonesia '74	Indonesia 1974- Indonesia
Bellevue (IGN)	Efate and Erromango Islands	Ireland 1965	Ireland 1965- Ireland
Bermuda 1957	Bermuda 1957- Bermuda Islands	ISTS 073 Astro	ISTS 073 ASTRO '69- Diego Garcia
Bogata Observ	Bogata Observatry- Colombia	Johnston Island	Johnston Island Kandawala Kandawala- Sri Lanka
Campo Inchspe	Campo Inchauspe- Argentina	Kerguelen Isld	Kerguelen Island, Kandawala, Sri Lanka
Canton Ast '66	Canton Astro 1966- Phoenix Islands	Kertau 1948	Kertau 1948- West Malaysia, Singapore
Cape	Cape- South Africa	L. C. 5 Astro	Cayman Brac Island
Cape Canavrl	Cape Canaveral- Florida, Bahama Islands	Liberia 1964	Liberia 1964- Liberia
Carthage	Carthage- Tunisia	Luzon Mindanao	Luzon- Mindanao Island
CH-1903	CH 1903- Switzerland	Luzon Philippine	Luzon- Philippines (excluding Mindanao Island)
Chatham 1971	Chatham 1971- Chatham Island (New Zealand)		
Chua Astro	Chua Astro- Paraguay		
Corrego Alegre	Corrego Alegre- Brazil		
Djakarta	Djakarta (Batavia)- Sumatra Island (Indonesia)		
Dos 1968	Dos 1968- Gizo Island		

Map Datums

Mahe 1971	Mahe 1971- Mahe Island		
Marco Astro	Marco Astro- Salvage Island		
Massawa	Massawa- Eritrea (Ethiopia)		
Merchich	Merchich- Morocco		
Midway Ast '61	Midway Astro '61- Midway		
Minna	Minna- Nigeria		
NAD27 Alaska	North American 1927- Alaska		
NAD27 Bahamas	North American 1927- Bahamas (excluding San Salvador Island)		
NAD27 Canada	North American 1927- Canada and Newfoundland		
NAD27 Canal Zone	North Am. 1927- Canal Zone		
NAD27 Caribbn	North American 1927- Caribbean (Barbados, Caicos Islands, Cuba, Dom. Rep., Grand Cayman, Jamaica, Leeward and Turks Islands)		
NAD27 Central	North American 1927- Central America (Belize, Costa Rica, El Salvador, Guatemala, Honduras, Nicaragua)		
NAD27 CONUS	North Am. 1927- Mean Value		
NAD27 Cuba	North American 1927- Cuba		
NAD27 Grnland	North American 1927- Greenland (Hayes Peninsula)		
NAD27 Mexico	N. American 1927- Mexico		
NAD27 San Sal	North American 1927- San Salvador Island		
NAD83	North American 1983- Alaska, Canada, Central America, CONUS, Mexico		
Nhrwn Masirah	Nahrwn- Masirah Island (Oman)		
Nhrwn Saudi A	Nahrwn- Saudi Arabia		
Nhrwn United A	Nahrwn- United Arab Emirates		
Naparima BWI	Naparima BWI- Trinidad and Tobago		
Obsrvtorio '66	Observatorio 1966- Corvo and Flores Islands (Azores)		
Old Egyptian	Old Egyptian- Egypt		
Old Hawaiian	Old Hawaiian- Mean Value		
Oman	Oman- Oman		
Ord Srvy GB	Old Survey Grt Britn- England, Isle of Man, Scotland, Shetland Isl., Wales		
Pico De Las Nv	Canary Islands		
Potsdam	Potsdam-Germany		
Ptcairn Ast '67	Pitcairn Astro '67- Pitcairn Is		
		Prov S Am '56	Prov So Amrcn '56- Bolivia, Chile, Colombia, Ecuador, Guyana, Peru, Venezuela
		Prov S Chln '63	Prov So Chilean '63- S. Chile
		Puerto Rico	Puerto Rico & Virgin Islands
		Qatar National	Qatar National- Qatar
		Qornoq	Qornoq- South Greenland
		Reunion	Reunion- Mascarene Island
		Rome 1940	Rome 1940- Sardinia Island
		RT 90	Sweden
		Santo (Dos)	Santo (Dos)- Espirito Santo Island
		Sao Braz	Sao Braz- Sao Miguel, Santa Maria Islands (Azores)
		Sapper Hill '43	Sapper Hill 1943- East Falkland Island
		Schwarzeck	Schwarzeck- Namibia
		Sth Amrcn '69	South American '69- Argentina, Bolivia, Brazil, Chile, Colombia, Ecuador, Guyana, Paraguay, Peru, Venezuela, Trinidad and Tobago
		South Asia	South Asia- Singapore
		SE Base	Southeast Base- Porto Santo and Madiera Islands
		SW Base	Southwest Base- Faial, Graciosa, Pico, Sao Jorge and Terceira Islands (Azores)
		Timbalai 1948	Timbalai 1948- Brunei and E. Malaysia (Sarawak and Sabah)
		Tokyo	Tokyo- Japan, Korea, Okinawa
		Tristan Ast '68	Tristan Astro 1968- Tristan da Cunha
		Viti Levu 1916	Viti Levu 1916- Viti Levu/ Fiji Islands
		Wake-Eniwetok	Wake-Eniwetok- Marshall Isl.
		WGS 72	World Geodetic System 1972
		WGS 84	World Geodetic System 1984
		Zanderij	Zanderij- Surinam

*Index***A**

- Activating a Route30
- Active Route Page31
- Altitude (ALT)18
- Antenna Installation57
- AutoLocate™ Mode52
- Average Speed (AVSPD) . .17

B

- Backlighting 15, 47
- Beacon Receiver Setup 44, 45
- Bearing2, 4

C

- CDI35
- Cancelling a GOTO25
- Cautionsiii
- Clearing Routes30
- Clearing the Track Log 13, 42
- Clock46
- Compass Page 12, 33, 34, 36
- Configuring the Map Page 40
- Contrast13, 47
- Copying Routes31
- Course deviation indicator 35
- Course to Steer (CTS) . . .34
- Creating Routes30
- Crosstrack Error (XTK) . .34

D

- DGPS Interface45
- Date and Time46

- Deleting Waypoints24
- Distance/Sun Calculations 43

E

- EPE15
- EZinit16, 52
- Editing Routes32
- Elapsed Time (ELPSD) . . .17
- Emergency Erase16
- Est. Time Enroute (ETE) .34
- Est. Time of Arrival (ETA) 34
- European Community Spec58

G

- GOTO25
- Getting Started Tour11
- Going To a Waypoint11
- Graphic steering33

H

- Highway Page11, 33, 34, 35
- Heading49

I

- I/O format44
- Initializing52
- Interface Setup44
- Inverting a Route30

*Index***M**

Magnetic Heading	49
Man Overboard	25
Map Cursor	37
Map Datums	48, 62
Map Orientation	40, 41
Map Page	10, 37
Map Setup	40
Marking a Position	8, 18
Maximum Speed (MXSPD)	17
Menu Page	7, 43
Memory Erase	16
Messages	60, 61

N

NMEA	59
Navigating Routes	28
Navigation Basics	4
Navigation Pages	7, 33
Navigation Setup	47
Nearest Waypoints	20

O

On-Route GOTO	32
Operating modes	46

P

Panning	38
Position Accuracy	50
Position Averaging	19
Position Formats	47
Position Page	6, 16
Primary Pages	6
Proximity Waypoints	21

R

Receiver Status	15
Reference Waypoints	22
Renaming Waypoints	24
Repairs	58
Route Definition Page	29
Route Navigation	28

S

Satellite Page	6, 14
Scanning Waypoints	24
Screen Backlighting	15, 47
Screen Contrast	13, 47
Signal Strength Bars	14
Simulator	51
Sky View	14
Specifications	58
Symbols	23, 39
System Setup	46

T

Time Format	46
Time Offset	46
TracBack Navigation	26
TracBack Tips	26, 27
Track Log Display	42
Track Method	42
Track Setup Page	40
Trip Timer (TTIME)	17
Troubleshooting	53
Turn (TRN)	34
Trip odometer	17

*Index***U**

- Units of Measure 48
- User-defined route 30
- User Grid 48
- Using the Keypad 5
- Using the Position Page . . . 9

V

- Velocity Made Good (VMG) 3

W

- Warranty 67
- Waypoint Comments . . . 23
- Waypoint Definition 22
- Waypoint List 20
- Waypoint Pages 19
- Waypoint Symbols . . . 23, 39
- Web Site Address i

Z

- Zooming 40

LIMITED WARRANTY

GARMIN International warrants this product to be free from defects in materials and workmanship for one year from the date of purchase. GARMIN will at its sole option, repair or replace any components which fail in normal use. Such repairs or replacement will be made at no charge to the customer for parts or labor. The customer is, however, responsible for any transportation costs. This warranty does not cover failures due to abuse, misuse, accident or unauthorized alteration or repairs. GARMIN assumes no responsibility for special, incidental, punitive or consequential damages, or loss of use.

The warranties and remedies contained herein are exclusive and in lieu of all other warranties expressed or implied, including any liability arising under warranty of merchantability or fitness for a particular purpose, statutory or otherwise. This warranty gives you specific legal rights, which may vary from state to state.

To obtain warranty service, call the GARMIN Customer Service department (913-397-8200) for a returned merchandise tracking number. The unit should be securely packaged with the tracking number clearly marked on the outside of the package, and sent freight prepaid and insured to a GARMIN warranty service station. A copy of the original sales receipt is required as the proof of purchase for warranty repairs. GARMIN retains the exclusive right to repair or replace the unit or software at its sole discretion.

NOTES



© 1997 GARMIN International

1200 E. 151st Street, Olathe, KS USA 66062

GARMIN (Europe) Ltd. - Unit 5, The Quadrangle,
Abbey Park, Romsey, UK SO51 9AQ

GARMIN (Asia) Corp., 4th Fl., No. 1, Lane 45,
Pao-Hsing Road, Hsin Tein, Taiwan R.O.C.

Part Number 190-00151-00 Rev. A Printed in Taiwan