

Owner's
Manual
&
Reference



GPS 38 Personal Navigator

 **GARMIN®**

Software Version 3.0 or above

© 1997 GARMIN Corporation
1200 E. 151st Street, Olathe, KS USA 66062
Tel: 913-397-8200 or 800-800-1020
Fax: 913-397-8282
Web Site Address: www.garmin.com

GARMIN (Europe) Ltd.
Unit 5, The Quadrangle, Abbey Park, Romsey, U.K. SO51 9AQ
Tel: 011-44-1794-519944
Fax: 011-44-1794-519222

All rights reserved. No part of this manual may be reproduced or transmitted in any form or by any means, electronic or manual, including photocopying and recording, for any purpose without the express written permission of GARMIN.

Information in this document is subject to change without notice. GARMIN reserves the right to change or improve their products and to make changes in the content without obligation to notify any person or organization of such changes or improvements.

GARMIN, GPS 38, Personal Navigator, AutoLocate and MultiTrac8 are all trademarks of GARMIN Corporation, and may not be used without the expressed permission of GARMIN.

GPS 38 Personal Navigator™

OWNER'S MANUAL

Preface

Welcome to the smallest, easiest-to-use GPS navigator for recreational use! The GPS 38 represents GARMIN's continuing commitment to provide outdoors sports enthusiasts with quality navigation information in a versatile, accurate and user-friendly design you'll enjoy for years to come. To get the most of your new GPS unit, it is important that you take the time to read through this owner's manual to understand the operating features of the GPS 38. The manual is organized into three sections for your convenience:

Section One takes provides step by step instructions to initialize the receiver for first time use.

Section Two introduces you to the basic features of the unit and provides a quick-start orientation to the GPS 38. It has been designed to acquaint you with the unit and provide a basic working knowledge necessary to use the unit in typical conditions.

Section Three provides a detailed reference to the advanced features and operations of the GPS 38 in a topical format. This allows you to concentrate on a specific topic quickly, without reading through entire sections of text that you may not need.

Packing List

Before getting started with your GPS, check to see that your GARMIN GPS 38 package includes the following items. If you are missing any parts, please contact your dealer immediately.

Standard Package:

- GPS 38 Receiver
- Wrist Strap
- GPS 38 Owner's Manual
- Quick Reference Card

Thanks for choosing the GARMIN GPS 38. We hope it will help you get the most out of your outdoor recreation adventures.



*Caution***CAUTION**

The GPS system is operated by the government of the United States, which is solely responsible for its accuracy and maintenance. The system is subject to changes which could affect the accuracy and performance of all GPS equipment. Although the GPS 38 is a precision electronic NAVigation AID (NAVAID), any NAVAID can be misused or misinterpreted, and therefore become unsafe.

Use the GPS 38 at your own risk. To reduce the risk of unsafe operation, carefully review and understand all aspects of this Owner's Manual and thoroughly practice operation using the simulator mode prior to actual use. When in actual use, carefully compare indications from the GPS 38 to all available navigation sources including the information from other NAVAIDs, visual sightings, charts, etc. For safety, always resolve any discrepancies before continuing navigation.

NOTE: This device complies with Part 15 of the FCC limits for Class B digital devices for home or office use. This equipment generates, uses, and can radiate radio frequency energy, and if not installed and used in accordance with the instructions, may cause harmful interference to radio communications. However, there is no guarantee that interference will not occur in a particular installation. If this equipment does cause harmful interference to other equipment, which can be determined by turning the equipment off and on, the user is encouraged to try and correct the interference by relocating the equipment or connecting the equipment to a different circuit than the affected equipment. Consult an authorized dealer or other qualified service technician for additional help if these remedies do not correct the problem. Operation is subject to the following conditions: (1) This device may not cause harmful interference, and (2) this device must accept any interference received, including interference that may cause undesired operation. The GPS 38 does not contain any user-serviceable parts. Repairs should only be made by an authorized GARMIN service center. Unauthorized repairs or modifications could void your warranty and your authority to operate this device under Part 15 regulations.



Table of Contents

SECTION ONE Introduction

GPS Overview/Navigation Basics	2-3
Battery Installation	4
Initializing the Receiver	5-8

SECTION TWO Getting Started

Power On/Satellite Page	9
Sky View/Position Page	10
Marking a Position	11
Position and Map Basics	12
GOTO and Steering Guidance	13-14
Page Sequence and Menu Page	15
Clearing the Track Log/Power Off	16

SECTION THREE Reference

Satellite Page	15-19
Position Page	20
Creating and Using Waypoints	21-27
GOTO and MOB Mode	28
TracBack Navigation	29-30
Creating and Using Routes	31-36
Compass and Highway Page Steering Guidance	37-39
Map Plotting	40-43
Menu Page and Auxiliary Functions	44-52
Simulator Mode	53
Appendix A—Messages/Time Offsets	54-55
Appendix B—Map Datums	56-57
Appendix C—Specifications and Wiring	58-59
Appendix D—Accessories	60
Appendix E—Index	61-62

The GPS 38 is a powerful navigation tool that can guide you anywhere in the world. To better understand its operation and capabilities, it may be helpful to review the basic terms and concepts briefly explained below.

Other navigation and GPS definitions used in the manual are defined in the appropriate sections of the reference section of the manual.

Almanac Data—Satellite constellation information (including location and health of satellites) that is transmitted to your receiver from every GPS satellite. Almanac data must be acquired before GPS navigation can begin.

Bearing—The compass direction from your position to a destination.

Course Made Good (CMG)—The bearing from the “active from” position (your starting point) to your present position.

Crosstrack Error (XTE)—The distance you are off a desired course in either direction.

Desired Track (DTK)—The compass course between the “from” and “to” waypoints.

Differential GPS (DGPS)—An extension of the GPS system that uses land-based radio beacons to transmit position corrections to GPS receivers.

Estimated Time of Arrival (ETA)—The time of day of your arrival at a destination.

Estimated Time Enroute (ETE)—The time left to your destination at your present speed.

Grid—A coordinate system that projects the earth on a flat surface, using square zones for position measurements. UTM/UPS and Maidenhead formats are grid systems.

Ground Speed—The velocity you are traveling relative to a ground position.

Latitude—A north/south measurement of position perpendicular to the earth’s polar axis.

Longitude—An east/west measurement of position in relation to the Prime Meridian, an imaginary circle that passes through the north and south poles.

Navigation—the process of traveling from one place to another and knowing where you are in relation to your desired course.

Position—An exact, unique location based on a geographic coordinate system.









Track (TRK)—The direction of movement relative to a ground position.

Universal Transverse Mercator (UTM)—A grid coordinate system that projects global sections onto a flat surface to measure position in specific zones.

Velocity Made Good (VMG)—The speed you are traveling in the direction of the destination.

Waypoint—A specific location saved in the receiver’s memory.

Keypad Usage & Data Entry

	Turns the unit on and off and activates screen backlighting.
	Scrolls through the main data pages in sequence and returns display from a submenu page to a primary page.
	Captures a position and displays the mark position page.
	Displays GOTO page with the waypoint highlighted for GOTO operation. Pressing GOTO twice activates MOB.
	Confirms data entry and activates highlighted fields to allow data entry.
	Returns display to a previous page, or restores a data field's previous value.
	Selects alphanumerical characters and menu choices and moves the field highlight from field to field.
	Moves the selected character field and moves the field highlight from field to field.

DATA ENTRY

The arrow keypad is used for all data entry. Use the ▲ and ▼ keys to select letters, numbers, and menu options; use the ◀ and ▶ keys to move the cursor forward or backward along the line. Press  to confirm your entry.

Battery
Installation

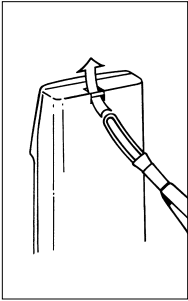

Wrist Strap Attachment

To attach the GPS 38's wrist strap, slide the small loop end of the strap through the slot at the top of the GPS.

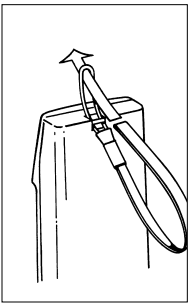

Thread the strap through the small loop eye and draw the strap tight.

Getting Started with your GPS

Welcome to the exciting world of GARMINGPS! The GPS 38 represents GARMIN's continuing commitment to provide outdoor enthusiasts with quality navigation information in a versatile, user-friendly design you'll enjoy for years to come. To get the most out of your GPS, be sure to read through the initialization and getting started sections of this manual and refer to the reference section for complete details on the GPS 38's advanced features.

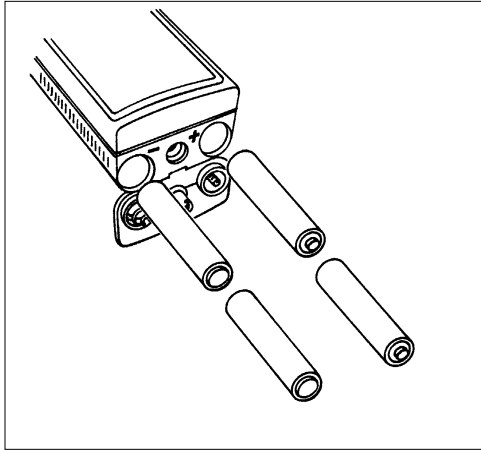

Battery Installation

The GPS 38 uses 4 AA batteries to provide up to 12 hours of operation in normal mode and up to 20 hours of operation in battery saver mode using alkaline batteries. Rechargeable Ni-Cad or lithium batteries may also be used. Note that the battery level indicator is calibrated for alkaline batteries, and Ni-Cad or lithium batteries will only show battery life at partial scale.

To install batteries:

1. Remove the battery cover by turning the thumb loop at the bottom of the unit 1/4 turn counter-clockwise.
2. Insert batteries into position. The battery pole you can still see should match the symbol marked on the case.
3. Replace and secure the battery cover by turning the thumb loop 1/4 turn clockwise.

SATELLITES IN VIEW



The GPS 38 calculates your position and movement by tracking signals sent from GPS satellites. Each of the 24 GPS satellites circle the earth twice a day in a very precise orbit, and transmit information back to earth. In order to determine a position fix, your GPS receiver needs to continuously “see” at least three satellites.

Because a GPS receiver can only see satellites above the horizon, it needs to know what satellites to look for at any given time. By using an almanac (a timetable of satellite numbers and their orbits) stored in the receiver’s memory, the GPS 38 can determine the distance and position of any GPS satellite.

To use this almanac data, your GPS needs to know where you are, or be given the opportunity to “find itself”. Once you initialize the unit to this position, the GPS 38 will usually compute a fix within a few minutes.

Remember, this process is only necessary under the following conditions:

- First time use from the factory.
- The receiver has been moved over 500 miles from the last calculated position with power off.
- The receiver’s memory has been cleared and all stored data has been lost.

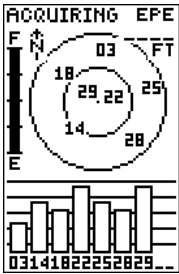
Acquiring
Satellites

The GPS 38's Satellite Page will help you determine what satellites are in view, and whether or not any satellites are being "shaded", or blocked from the receiver's antenna.

By monitoring the signal strength bars at the bottom of the page and the north up sky view, you'll be able to see how moving to another area with a clearer view of the sky will improve satellite reception and speed up signal acquisition.

Acquiring Satellite Signals

Because the GPS 38 relies on satellite signals to provide you with navigation guidance, the receiver needs to have an unobstructed, clear view of the sky for best performance. What exactly does this mean? In a nutshell, the GPS receiver's view of the sky will generally determine how fast you get a position fix, or if you get a fix at all. GPS signals are relatively weak, and do not travel through rocks, buildings, people, mountains and other significant structures, so you need to make sure that you're not standing next to a tall building or a wall of cliffs when acquiring satellites.



Obstructed View of the Sky

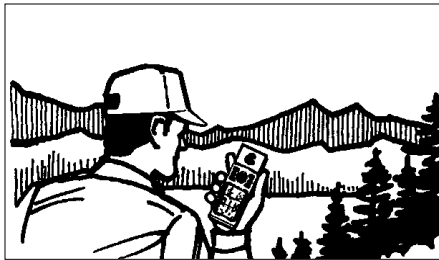

Clear View of the Sky

Once the GPS has calculated a position fix, you'll usually have anywhere from four to eight satellites in view. The GPS 38 will now continuously select the best satellites in view to update your position. If some of the satellites in view get blocked or "shaded", the receiver can simply use an alternate satellite to maintain the position fix. Although a GPS receiver needs four satellites to provide a 3D fix, the GPS 38 can maintain a 2D fix with only three satellites.

Before You Initialize

Take the GPS 38 outside and find a large, open area (try a nearby park) that has a clear view of the sky from horizon to horizon. Hold the receiver at a comfortable height, at arm's length from your body with the built-in antenna (the top part above the display) parallel to the ground.



Do your best to stay away from buildings or other structures that could block the path of signals to the receiver. GPS signals do not travel through rocks, mountains, buildings, metal surfaces or other significant structures.

To turn the GPS 38 on:

1. Hold the unit so the built-in antenna (the flat area above the display) is parallel to the ground.
2. Press and hold  until the receiver turns on.

The welcome page will be displayed while the unit conducts a self test. Once testing is complete, the welcome page will be replaced by the Satellite Page, with the EZinit prompt ready for you to select one of two initialization methods:

- Select Country— allows you to initialize the receiver by selecting your present position from a list of countries in the GPS 38's internal database. Usually provides a position fix in a few minutes.
- AutoLocate™— allows the GPS 38 to initialize itself and calculate a position fix without knowing your present position. Usually provides a position fix in 7.5-15 minutes.

If the EZinit prompt has not automatically appeared on the Satellite Page:

1. Press the  key.

If you've already initialized the GPS 38 and the EZinit prompt appears, highlight the 'NO RE-INIT' selection with the arrow keypad and press . The EZinit prompt may appear if you've had the unit on in normal mode while indoors, or if the antenna is shaded while acquiring satellites in normal or battery saver mode.

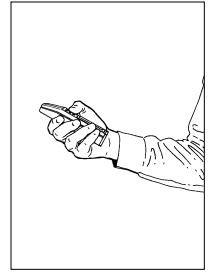

Hold the receiver so the built-in antenna is parallel to the ground.



Welcome Page

GETTING STARTED

EZinit

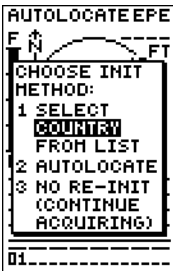

The EZinit prompt will automatically appear if the receiver needs to be initialized. The prompt may also appear during normal use if the antenna is shaded or the unit is indoors.



Use the arrow keypad to highlight the country and region or state (if necessary) of your present position from the list and press ENTER. If the country is not listed, select the closest country instead.

To initialize the receiver:

1. If the 'country' option is not highlighted, press the ▼ key repeatedly to move the field highlight to the 'country' option.
2. Press the **ENTER** key.
3. Use the ▼ key to scroll through the list pages until the country of your present position appears.
4. Use the ▲ key to highlight the country/state/region you're in. If the country you're in is not listed, select another country within 500 miles of your present position.
5. Press **ENTER** to finish.

The GPS 38 will now begin searching for the appropriate satellites for your position and should acquire a fix within a few minutes. You can verify that you have acquired a fix by watching the Satellite Page transition to the Position Page (provided you haven't pressed any other buttons) or looking for a 2D or 3D NAV status at the top left corner of the Satellite Page. To prevent accidental battery power loss, the GPS 38 will automatically shut off 10 minutes after the last keystroke if the unit is not tracking at least one satellite and has never acquired a position fix.

Initialization Troubleshooting

If you have trouble initializing the receiver or getting a position fix, check the following:

- **Does the receiver have a clear view of the sky?**

If there are large buildings, rocks, mountains, or heavy tree cover, the receiver may not be receiving enough satellite signals to calculate a fix.

- **Have you selected the right country/state from the EZinit list?**

Check for the correct approximate lat/lon on the Position Page or reselect the appropriate country from the list to restart the initialization.

- **Have you moved more than 500 miles from the last calculated position with the receiver off?**

Reinitialize the receiver, selecting the country/state of your new location from the EZinit list.

Getting Started Tour

Now that your GPS has been initialized, it's time to take a tour through the GPS 38's basic features and functions. The tour assumes that you have initialized the receiver and have not changed any of the factory settings (units of measure, selectable fields, etc). If you have changed any of the default settings, the pictures and descriptions may not match your unit's configuration.

Powering Up and Taking a Fix

Take the GPS 38 outside and find an open area where the receiver will have a clear view of the sky. Hold the receiver at a comfortable height, at arm's length from your body, with the internal antenna parallel to the ground.

To turn the unit on:

1. Press and hold  until the receiver turns on.

A welcome page will be displayed while the unit conducts a self test. Once testing is complete, the welcome page will be replaced by the Satellite Page and the GPS 38 will begin acquiring satellites.

Satellite Page

The GPS 38's Satellite Page provides a visual reference of satellite acquisition and position. As the receiver locks onto satellites, a signal strength bar will appear for each satellite in view, with the appropriate satellite number (1-32) underneath each bar. The progress of satellite acquisition is shown in three stages:

- No signal strength bars— the GPS 38 is looking for the satellites indicated.
- Hollow signal strength bars— the GPS 38 has found the satellite(s) and is collecting data.
- Solid signal strength bars— the GPS 38 has collected the necessary data and the satellite(s) is ready for use.

Note that each satellite has a 30 second data transmission that must be collected (hollow bar status) before the satellite may be used for navigation (solid bar status). Once a fix has been calculated, the GPS can take on the easier task of updating your position, track and speed by selecting and using the best satellites in view.



Welcome Page

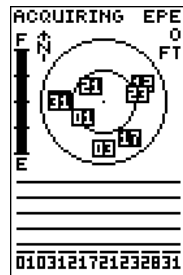

Satellite Page

The signal strength bars at the bottom of the page will not appear until the GPS 38 has found the satellites indicated at the bottom of the screen.

GETTING STARTED

Sky View & Position Page

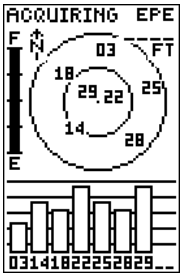

Once satellites have been found, hollow signal strength bars will be displayed while data is being collected. The hollow bars can be used to help determine if satellites are being shaded.

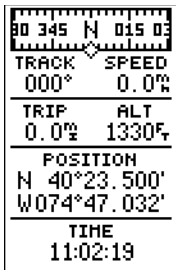

Position Page

In addition to displaying your position coordinates, the Position Page shows your track and speed over the ground. Speed and altitude data may fluctuate due to Selective Availability.

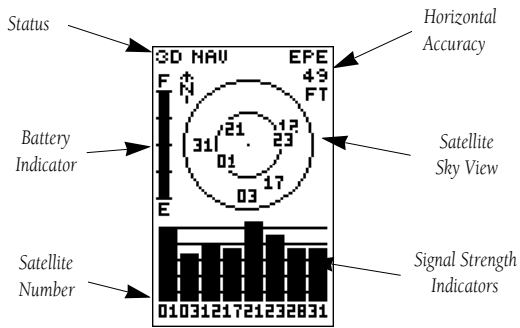

The **Satellite Page** shows a bird's eye view of the position of each satellite relative to the unit's last known position. The outer circle represents the horizon (north up); the inner circle is 45° above the horizon; and the center point is directly overhead. You can use the sky view to help determine if any satellites are being blocked, and whether you have a current position fix (indicated by a '2D NAV' or '3D NAV' in the status field).

Once sufficient signals have been acquired, the Satellite Page will be replaced with the Position Page, provided you have not pressed any other buttons.

Position Page

The second page in the GPS 38's primary page sequence is the **Position Page**. The Position Page shows you where you are, what direction you're heading and how fast you are going, and is particularly helpful when you do not have an active destination selected. The graphic display at the top of the page indicates your heading (only while you're moving) with the track and speed indicated below.



The graphic compass tape reflects your heading only while you are moving.

The rest of the page shows your current position in three dimensions: latitude, longitude and altitude. The GPS 38 uses this basic information to mark exact positions as waypoints, which help guide you from one place to another. A trip odometer and 12/24 hour clock are also provided.

Marking a
Position**Marking a Position**

Now that you've acquired a position, let's mark it as a waypoint for future reference.

1. Press the **MARK** key to capture and hold your position.



To mark a position, you must have obtained a 2D or 3D fix, or have the receiver in simulator mode. If you try to mark a position without a position fix, you will be alerted with a 'No GPS Position' message.

The mark position page will appear, showing the captured position and a default 3-digit waypoint name. Let's change the default name to something that's a little more meaningful, like 'HOME'.

1. Press the **▲** key twice to move the field highlight from the 'SAVE?' field to the name field.
2. Press **ENTER** and **◀** to clear the default waypoint name.
3. Press and hold the **▲** key to scroll through the alphabet until the letter 'H' appears.
4. Press the **▶** key once to move the character highlight to the next character space.
5. Repeat steps 3 and 4 until the word 'HOME' is displayed.
6. Press **ENTER** to complete entry of the name.
7. Press the **▼** key once to return the field highlight to the 'SAVE?' field.
8. Press the **ENTER** key to confirm that you want to save the position as a waypoint named 'HOME'.

The mark position page will now be replaced by the Position Page (or the page displayed prior to pressing the **MARK** key). The 'HOME' waypoint is now stored in the GPS 38's memory, and will remain there until you manually remove it or clear the receiver's memory. For more on waypoint management, see pages 21-27.

MARK POSITION
Waypoint:
001
N 40°23.029'
W074°47.032'
Add to route
number: __
SAVE?

To save a waypoint with the default three digit name, simply press the ENTER key. The GPS 38 will return to the page previously displayed.

MARK POSITION
Waypoint:
HOME __
N 40°23.756'
W078°46.114'
Add to route
number: __
SAVE?

The arrow keypad is used for all data entry. Use the UP and DOWN keys to select letters, numbers or menu options; use the LEFT and RIGHT keys to move the cursor forward or backward along the line.

Position Page &
Map Page

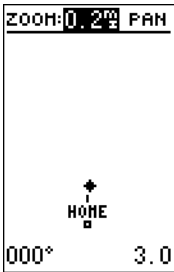

Map Page

The Map Page displays your present position as a diamond icon and provides a real time graphic "breadcrumb" display of your track right on screen.

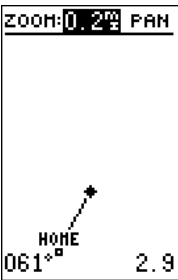

The moving map's default setting is track up orientation. It can also be set for north up, or desired track up orientation through the map setup page.

Using the Position and Map Pages

Now that you've marked a position, it's time to take off on a brisk walk, using the position and Map Pages to watch your every move. To get the most out of this tutorial, be sure to walk for at least the time noted for each step. This way, you'll reduce the chances of staying within the margin of error of the GPS system (usually around 15 meters). You'll also get a much better indication of how the GPS38's steering guidance and mapping features work to guide you wherever you go.

1. Walk in a straight line for 3-4 minutes at a fast pace and watch the Position Page. You can time your distance with the on-screen clock.

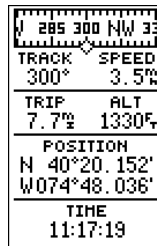

The direction you are moving (your track) and your speed are displayed on the upper part of the screen, just below the graphic compass tape. The latitude, longitude and approximate altitude of your position; along with a resettable trip odometer, are continuously displayed in the middle of the page, with the time of day displayed below.

Now let's change the display to the Map Page and watch the track log of our walk:

1. Press the **PAGE** key to change from the Position Page to the Map Page.

Your current position is shown as the diamond in the middle of the screen. The dark circle below the diamond represents the position you created, with the line between the two showing your track.

1. Now turn 90° to your right and continue walking at a fast pace for another 2-3 minutes. Notice how the display changes, always keeping the direction you are moving at the top of the map.

Going To A
WaypointGoing To a Waypoint

Once you've stored a waypoint in memory, you can use the GPS 38 to guide you to it by performing a simple GOTO. A GOTO is really nothing more than the receiver drawing a straight line course from your present position to the destination you've selected. To see how it works, let's try navigating back to our starting position, the HOME waypoint.

To select a GOTO destination:

1. Press the **GOTO** key.
2. The go to waypoint page will appear, displaying all the waypoints in memory in alphabetical order.
3. Use **▲** or **▼** to highlight the 'HOME' waypoint.
4. Press the **ENTER** key to confirm that you want to navigate to the displayed waypoint.

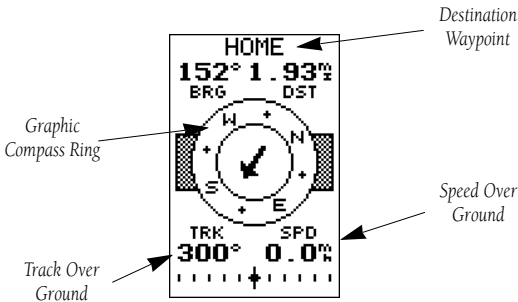
Compass Page

Whenever you select a destination waypoint, the GPS 38 will provide graphic steering guidance with the Compass Page. As you begin walking again, the Compass Page will display nav data and graphic steering guidance to the destination. The bearing (BRG) and distance (DST) to the waypoint are displayed at the top of the page, right below the destination waypoint field. The distance displayed is always the straight line distance from your present position to the destination waypoint. The bearing indicates the exact compass heading from you to the destination.

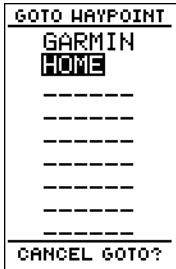

The GOTO waypoint page allows you to select your destination from a list of all available waypoints in the GPS 38's memory.

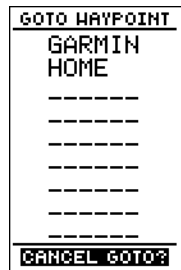

Once a GOTO is activated, the GPS 38 will provide steering guidance to the destination until the GOTO is cancelled. To cancel a GOTO, highlight the cancel prompt at the bottom of the page and press ENTER.

GETTING STARTED

Using the Compass Page

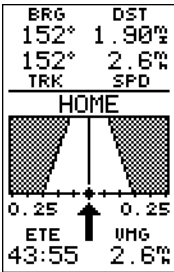

Highway Page

The GPS 38 will also provide steering guidance with a graphic Highway Page. To change the display from the compass to the Highway Page, press ENTER twice.



Message Page

Once you are one minute from the destination (based on your present speed and course), an arrival message will appear on the message page.

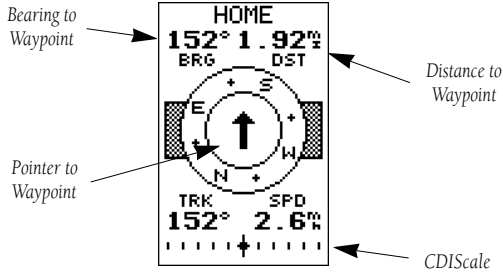

The middle of the Compass Page features a rotating “compass” that shows your current heading while you’re moving, with a pointer arrow to the destination displayed in the center. The arrow shows the direction of your destination from the direction you are moving. If the arrow points up, you are going directly to the waypoint. If the arrow points any other direction than up (left, right, down, etc.), turn toward the arrow until it points up and then continue in that direction.

The bottom of the Compass Page displays your current track (TRK) and speed (SPD) over the ground, while the CDI (course deviation indicator) scale shows how far you are off course. The diamond in the center of the CDI scale represents your present position, while the d-bar (the moving vertical line on the scale) indicates the direction and distance you are off the desired straight line course.

The default setting of the CDI scale is +/- 0.25 miles, with each mark representing 0.05 miles of course deviation. If you do get off course by more than the selected scale, an arrow prompt will appear at the end of the scale to indicate the direction you are off course. For more information on setting the CDI scale, see page 47.

When you are one minute away from the destination (based on your current speed and track over the ground), the GPS 38 will alert you with a flashing on-screen message box.

To view a message:

1. Press the **PAGE** key when the message box appears.
2. Press **PAGE** again to return to the previous page.

When the DST field displays a distance of 0.00 miles, you’ve reached your destination!

Scrolling Through the Primary Pages

Now that you've arrived 'HOME', let's take a minute to see how the GPS 38's primary pages work together. The GPS 38 features five primary pages, which are linked together in a chain. You can quickly scroll through the pages in either direction using the **PAGE** and **QUIT** keys.

Primary Pages

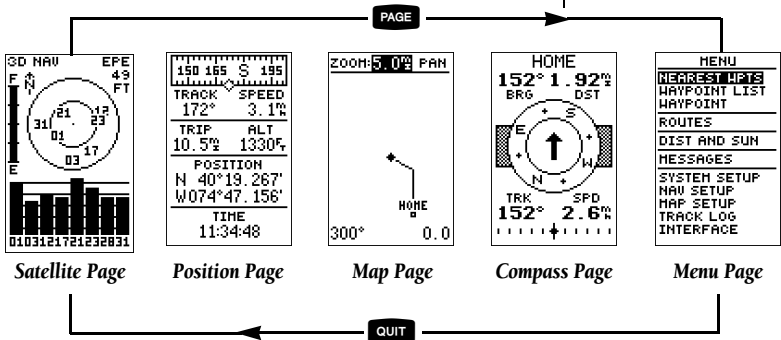

1. Press the **PAGE** key to scroll through the five primary pages in sequence.
2. Press the **QUIT** key to scroll through pages in the opposite direction.

Menu Page

You've already seen the first four pages in action by acquiring satellites, marking a position and navigating to a destination. The last page available from the primary page sequence is the Menu Page, which provides access to the GPS 38's waypoint management, route, track log and setup features. The 11 submenus are divided into categories by function.

To select a submenu from the Menu Page:

1. Press **PAGE** or **QUIT** until the Menu Page appears.
2. Use the **▲** or **▼** keys to highlight the submenu you want to view.
3. Press **ENTER** to access the submenu.



Menu Page

Use the UP and DOWN keys to select a submenu from the Menu Page. Press ENTER to access the selected submenu.

Clearing The Map & Power Off

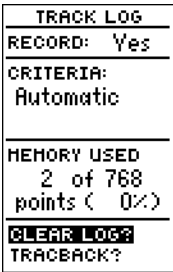

Highlight the CLEARLOG? prompt and press ENTER to clear the track log. Once all 768 points are used, the oldest point will be continuously deleted to make room for the latest track log point.



Confirm the track log warning page to clear the log.

Clearing A Cluttered Map

After you've used the GPS38 for a few trips, you may find that your map display has become a bit messy from keeping track of your every move. To get a feel for how the Menu Page works, let's clear the track log (the plot points left on the Map Page) we've just created during the Getting Started Tour.

1. Press **PAGE** or **QUIT** until the Menu Page appears.
2. Use the **▼** key to move the field highlight to the 'TRACKLOG' option.
3. Press **ENTER** to access the track log page.
4. Press the **▲** key twice to highlight the 'CLEARLOG?' option. The clear log confirmation page will appear.
5. Use the **◀** key to highlight the 'Yes?' prompt.
6. Press **ENTER** to finish.

Turning the Receiver Off

You've now gone through the basic operation of your new GPS and probably know a little more than you think about how it works. We encourage you to experiment with the GPS 38 until it becomes an extension of your own navigation skills. If you encounter any problems using the unit or want to take advantage of the GPS 38's more advanced features, refer to the reference section.

To turn the GPS 38 off:

1. Press and hold the **OFF** key for 3 seconds.

Thank you for choosing the GPS 38. We hope it will be a valuable tool for you wherever you travel.

Satellite Page

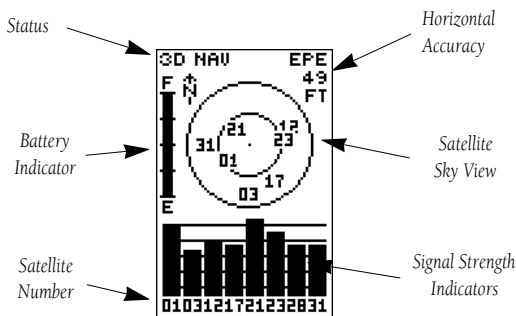

The GPS 38 Satellite Page displays the status of various receiver functions. The status information will help you understand what the GPS is doing at any given time, and tell you whether or not the receiver has calculated a position fix.

Sky View & Signal Strength Bars

The sky view and signal strength bars give you an indication of what satellites are visible to the receiver, whether or not they are being used to calculate a position fix, and the signal quality. The sky view in the center of the page shows a bird's eye view of the position of each satellite relative to the receiver's last known position. The outer circle represents the horizon; the inner circle is 45° above the horizon; and the center point is a position directly over your head.

When the receiver is looking for a particular satellite, the corresponding signal strength bar will be blank and the sky view indicator will remain highlighted in reverse video. Once the receiver has found the satellite, a hollow signal strength bar will appear, indicating that the satellite has been found and the receiver is collecting data from it. The satellite number in the sky view will also change from reverse video to normal presentation. As soon as the GPS 38 has collected the necessary data to use the satellite for positioning, the hollow bar will become solid.

Satellite Page Overview

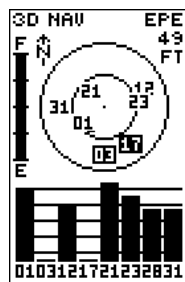

Satellites in view but not currently in use (03 & 17) will be displayed in reverse video, with the corresponding signal strength bar "hollow".

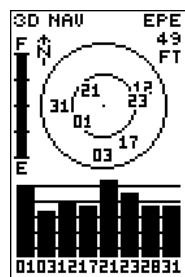

Once a satellite in view is usable for positioning, the satellite number will change from reverse video and the signal strength bar will become solid.

Receiver Status & EZinit

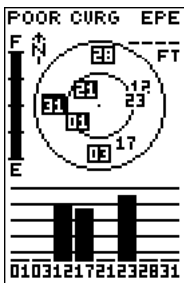

A 'Poor Coverage' status will appear if the receiver has lost the satellites required to compute a fix. Make sure the internal antenna is not covered and has a clear view of the sky.

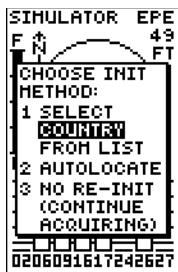

If you travel more than 300 miles with the receiver off, you may have to reinitialize the receiver to your new location. To access the EZinit prompt, press ENTER from the Satellite Page before the receiver has acquired any satellites.

Receiver Status & EPE

Receiver status is indicated at the top left of the screen, with the current horizontal accuracy (estimated position error, in feet or meters) at the top right. The status will show one of the following conditions:

Searching— the GPS 38 is looking for any available satellites in view.

AutoLocate™— the GPS 38 is initializing and collecting new almanac data. This process can take 7.5 to 15 minutes.

Acquiring— the receiver is collecting data from available satellites, but has not collected enough data to calculate a 2D fix.

2D Nav (2D Navigation)— at least three satellites with good geometry have been locked onto and a 2 dimensional position fix (latitude and longitude) is being calculated. '2D Diff' will appear when you are receiving DGPS corrections in 2D mode.

3D Nav (3D Navigation)— at least four satellites with good geometry have been locked onto and your position is now being calculated in latitude, longitude and altitude. '3D Diff' will appear when you are receiving DGPS corrections in 3D mode.

Poor CVG (Poor GPS Coverage)— the receiver is no longer tracking enough satellites for a 2D or 3D fix.

Not Usable— the receiver is unusable, possibly due to incorrect initialization or abnormal satellite conditions. Turn the unit off and back on to reset.

Simulator (Simulating Navigation)— the receiver is in simulator mode.

EZinit Option Prompt

The Satellite Page also provides access to the EZinit prompt whenever a position fix has not been calculated (the unit must be in searching, AutoLocate, acquiring, simulator or poor coverage mode). This allows you to manually reinitialize the unit (see page 5-8 for instructions), and is useful if you have traveled over 500 miles with the receiver off and you know it must be initialized to your new position (the GPS 38 will automatically offer the EZinit prompt after 10 minutes of unsuccessful satellite acquisition).

Battery Level Indicator

The Satellite Page also features a battery level indicator, located below the status field to the left of the sky view, which provides a graphic display of the condition of the internal batteries.



The battery level indicator is calibrated for alkaline batteries. Ni-Cad and lithium batteries will not accurately display the battery level due to voltage differences. No other receiver functions are affected by using Ni-Cad or lithium batteries.



It's always best to store your GPS with the batteries installed to preserve the internal memory and data. The GPS 38 features a self-charging lithium battery that continually maintains a full charge while batteries are installed. The lithium battery will maintain the internal memory for 3 months in the event that the batteries are removed or totally discharged.

Screen Backlighting

The GPS 38's automatic backlight feature illuminates the screen display for a user-defined interval (the default is 15 seconds) after every keystroke. When backlighting is on, a bulb icon will appear at the bottom left of the sky view. To turn the screen backlighting on or off:

1. Press the  key.
2. To adjust the duration of screen backlighting, refer to the operation setup section (page 46).



Using the screen backlighting can greatly affect battery life. If you're using your GPS primarily in daylight hours, you should keep the backlight time-out at the default 15 second setting.

Battery Level & Backlighting

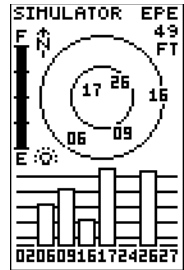

A bulb icon will appear on the Satellite Page whenever the screen backlighting is on. The backlight will turn on for the time selected after every keystroke.

Position Page

N 285 300 NW 33	
TRACK	SPEED
300°	2.0%
TRIP	ALT
7.7%	1330ft
POSITION	
N 40°19.900'	
W074°47.697'	
TIME	
13:09:53	

The speed displayed on the Position Page may fluctuate at slow speeds (or when you're standing still) because of position errors caused by Selective Availability.

N 285 300 NW 33	
TRACK	SPEED
300°	2.0%
TRIP	ALT
00.0%	1330ft
POSITION	
N 40°19.884'	
W074°47.688'	
TIME	
13:10:28	

To reset the trip odometer, highlight the trip field and press ENTER. Use the LEFT arrow key to clear the distance field and press ENTER to confirm.

Position Page

The GPS 38's Position Page shows you where you are, what direction you're heading and how fast you are going (up to 99.9 mph), and is most useful when you are traveling without an active destination waypoint. A graphic compass tape at the top of the page displays your cardinal heading (while you're moving), with your current track and speed over the ground indicated below. The rest of the page shows your present position in three dimensions (latitude, longitude and altitude). The units of measure for speed, distance, position and altitude are all user-selectable through the navigation setup menu (see page 48). The 12/24 hour clock and time offset options are available from the system setup menu (see page 46).

Trip Odometer

The Position Page also features a resettable trip odometer to measure the total distance traveled while navigating.

To reset the trip odometer:

1. Highlight the 'TRIP' field.
2. Press **ENTER**, followed by **◀**.
3. Press **ENTER** to finish.

Altitude Display

When the GPS 38 is acquiring satellites or navigating in the 2D mode, the last known altitude will be used to compute your position. If the altitude shown is off by several hundred feet, you can manually enter your altitude for greater accuracy. Note that GPS altitudes can fluctuate due to errors.

1. Highlight the 'ALT' field.
2. Press **ENTER** to begin entry of your altitude.
3. Enter a value in each character field.
4. Press the **ENTER** key to confirm the altitude.

Marking & Saving Waypoints

Marking And Saving Waypoints

Knowing your present position is only part of any navigation equation. You also need to keep track of where you've been and where you are going. Waypoints serve as electronic markers that let you keep track of starting points, destinations, nav aids and any other important position.

The GPS 38 allows you to mark, store and use up to 250 waypoints. A waypoint position can be entered by taking an instant electronic fix or by manually entering a coordinate or range and bearing in reference to an existing waypoint. If you try to mark a waypoint without having a position fix, you'll be notified with a 'No GPS Position' message.

To mark your present position:

1. Press the **MARK** key to capture your position.

The mark Position Page will appear, showing the captured position and a default 3-digit waypoint name.

To change the default position name :

1. Highlight the 'Waypoint' field.
2. Press **ENTER** key to begin entry of the name. Pressing the **◀** key will clear any existing data.
3. Use the arrow keypad to enter a waypoint name.
4. Press **ENTER** to confirm the waypoint name. The field highlight will move to the route field.

If you'd like to add this waypoint to a route:

1. Press the **ENTER** key.
2. Enter a route number.
3. Press the **ENTER** key to confirm the route number.
4. Press the **ENTER** key again to save the waypoint.

If you do not want to add this waypoint to a route:

1. Highlight the 'SAVE?' field and press the **ENTER** key.

MARK POSITION
Waypoint:
001
N 40°23.029'
W074°47.032'
Add to route
number: --
SAVE?

The GPS 38 will save new waypoints with a default three-digit name.

MARK POSITION
Waypoint:
RIDGE
N 39°00.265'
W095°00.000'
Add to route
number: 1
SAVE?

You may add a new waypoint to the end of any storage route by entering the desired route number in the route field before saving the waypoint.

Nearest Waypoints Page

MENU
NEAREST WPTS
WAYPOINT LIST
WAYPOINT
ROUTES
DIST AND SUN
MESSAGES
SYSTEM SETUP
NAV SETUP
MAP SETUP
TRACK LOG
INTERFACE

To select a waypoint sub-menu, highlight the desired option and press ENTER.

NEAREST WPTS		
WAYPNT	BRG	DST
HONE	157°	1.45
CAR	008°	4.25
STREAM	011°	5.17
BRIDGE	003°	5.89
CAMP	014°	6.27
----	----	----
----	----	----
----	----	----
----	----	----

Nearest Waypoints Page

The compass heading (BRG) and distance (DST) to the nine nearest waypoints are updated continuously.

Waypoint Submenus

The GPS 38 has three waypoint submenu Pages that let you manage a large number of waypoints quickly and efficiently. The nearest waypoints, waypoint list and waypoint definition pages are accessed through the Menu Page.

To select a waypoint submenu page:

1. Press **PAGE** or **QUIT** until the Menu Page appears.
2. Highlight the waypoint submenu page you want to use.
3. Press **ENTER** to display the submenu page.
4. To return to the Menu Page, press the **PAGE** key.

Nearest Waypoints Page

The nearest waypoints page shows the nine nearest waypoints that are within 100 miles of your present position, with the bearing and range noted for each waypoint. During an emergency, the nearest waypoints page can give you the closest points of safety in your area at a glance.

The nearest waypoints page will also let you retrieve a waypoint definition page or GOTO a selected waypoint right from the list.

To review the waypoint definition page of a highlighted waypoint from the list:

1. Press the **ENTER** key.

To return to the nearest waypoint page (when the "Done?" field is highlighted):

1. Press the **ENTER** key.

To go to a highlighted list waypoint:

1. Highlight a listed waypoint.
2. To select a highlighted nearest waypoint as a destination, press the **GOTO** key.
3. Once the GOTO waypoint page appears, press the **ENTER** key to confirm the selected waypoint as your destination.

Waypoint List Page

Waypoint List Page

The waypoint list page provides you with a complete list of all waypoints currently stored in the GPS 38. The total number of used and free waypoints is indicated above the waypoint list. From the waypoint list page, you can retrieve a waypoint definition page or delete all user-defined waypoints, or go to a selected waypoint. If a waypoint is currently used in a route, the lowest route number will be indicated to the left of the waypoint name.

To review the waypoint definition page of a highlighted list waypoint:

1. Press the **ENTER** key.

To return to the waypoint list page (with the 'Done?' field highlighted):

1. Press the **ENTER** key.

To go to a list waypoint:

1. Scroll through the list and select a waypoint.
2. To select a highlighted waypoint as a destination, press the **GOTO** key.
3. Once the GOTO waypoint page appears, press the **ENTER** key to confirm the selected waypoint as your destination.

To delete all user defined waypoints:

1. Move the cursor highlight to 'DEL ALL WPTS'.
2. Press the **ENTER** key.

A warning page will appear, asking if you are sure you want to delete all user-defined waypoints and routes. If you want to continue and delete:

1. Highlight the 'Yes?' field.
2. Press the **ENTER** key.
3. Press the **QUIT** key to return to the Menu Page.

If you do not want to delete all waypoints:

1. Highlight the 'No?' field and press **ENTER**.

WAYPOINT LIST	
245	EMPTY USED
R02	BRIDGE
R02	CAMP
R02	CAR
	HOME
R02	STREAM

DEL ALL WPTS?	

Waypoint List Page

The total number of used and available waypoints is indicated at the top of the page. Waypoints that are part of a route are indicated by, a 'R_'. Above, 'R02' means route 2.

DEL ALL WPTS
WARNING!
all user defined waypoints and routes will be deleted
Are you sure
Yes? or No?

Deleting all user waypoints will also delete all routes stored in memory.

Waypoint Definition Page

WAYPOINT	
NAME: HOME	
N 40°18.680'	
W074°47.032'	
21-DEC-95 11:12	
REF: -----	
BRG	DST
157°	1.45%
RENAME?	NEW?
DELETE?	DONE?

Waypoint Definition Page

Use the waypoint definition page to review, rename or delete stored waypoints and to create new waypoints manually.

WAYPOINT	
NAME: BRIDGE	
N 40°24.856'	
W074°47.391'	
21-DEC-95 10:40	
REF: -----	
BRG	DST
319°	1.69%
RENAME?	NEW?
DELETE?	DONE?

To create a new waypoint by manually entering coordinates or by referencing an existing waypoint, highlight the NEW? prompt and press the ENTER key.

Waypoint Definition Page

The last of the three waypoint management pages is the waypoint definition page. This page lets you create new waypoints manually, as well as review and edit existing waypoints.

The diagram shows the Waypoint Definition Page with the following labels and arrows pointing to specific fields:

- Waypoint Name:** Points to the NAME field.
- Position Coordinates:** Points to the latitude and longitude fields.
- Reference Waypoint:** Points to the REF: field.
- Bearing from Reference Waypoint:** Points to the BRG field.
- Distance from Reference Waypoint:** Points to the DST field.
- Function Prompts:** Points to the RENAME?, NEW?, DELETE?, and DONE? fields.

To create a new waypoint manually, you'll need to know its position coordinates or its distance and bearing from an existing waypoint.

To create a waypoint by entering coordinates:

1. Highlight the 'NEW?' field.
2. Press **ENTER**.
3. Enter your waypoint name and press **ENTER** to confirm. The position field will now become highlighted, with the receiver's last known position shown.
4. Press **ENTER** to begin entry of the position.
5. When finished, press **ENTER** to confirm and save your coordinates. The default waypoint comment (UTC date and time of creation) will appear and the highlight will move to the 'DONE?' field.
6. Press the **ENTER** key to return to the Menu Page.

Reference Waypoints

Reference Waypoints

To create a new waypoint manually without knowing its position coordinates, you'll need to enter its bearing and distance from an existing waypoint. The GPS 38 will then calculate the position coordinates for you.

WAYPOINT	
NAME: ROCK	
N 40°19.844'	
W074°47.666'	
21-DEC-95 13:25	
REF:	AMP__
BRG	DST
000°	0.00%
RENAME?	NEW?
DELETE?	DONE?

To create a new waypoint by referencing a stored waypoint:

1. Highlight the 'NEW?' field.
2. Press **ENTER**.
3. Enter the name of your new waypoint.
4. Press the **ENTER** key to confirm the waypoint name.
The position field will now become highlighted, with the receiver's last known position shown.
5. Move the cursor to the reference field.
6. Press **ENTER** to begin entry of reference waypoint.
7. Use the arrow keypad to enter the waypoint name.
8. Press the **ENTER** key to confirm your entry.
9. Enter the bearing and distance of your new waypoint from the reference waypoint. Remember to use the **ENTER** key to begin entry and confirm each field. The coordinates will be calculated and saved for your new waypoint.
10. Highlight the 'DONE?' field and press **ENTER** to return to the Menu Page.

WAYPOINT	
NAME: ROCK	
N 38°58.050'	
W095°00.001'	
02-JAN-96 10:43	
REF:	-----
BRG	DST
356°	12.0%
RENAME?	NEW?
DELETE?	DONE?

The GPS 38's advanced waypoint and planning features allow you to create new waypoints and practice navigation without ever stepping foot outside.

If you create a new waypoint by entering coordinates from a map, you may want to remark the waypoint's exact position once you get there.

To redefine an existing waypoint's position coordinates from the waypoint definition page, simply highlight the DST field and press **ENTER**. Use the **LEFT** arrow key to set the distance to 0.00, and press **ENTER** to confirm.

The old coordinates will be replaced by the coordinates of your present position (you must have a valid 2D or 3D position fix).

Editing, Deleting & Renaming Waypoints

WAYPOINT	
NAME: STREAM	
N 40°24.244'	
W074°46.529'	
SHALLOW AREA	
REF: -----	
BRG	DST
011°	5.17%
RENAME?	NEW?
DELETE?	DONE?

The waypoint comments field will automatically assign the date and time of creation to the waypoint comments field. You may enter a 16-character user comment at any time.

WAYPOINT	
NAME: STREAM	
N 40°24.244'	
W074°46.529'	
SHALLOW AREA	
REF: -----	
BRG	DST
011°	5.17%
RENAME?	NEW?
DELETE?	DONE?

To access the rename function from the waypoint definition page, highlight the 'RENAME?' prompt and press ENTER.

Editing Existing Waypoints

The waypoint definition page also allows you to review and change a stored waypoint's name, coordinates, comment or reference waypoint at any time.

To edit waypoint coordinates or a reference waypoint:

1. Highlight the field you want to edit.
2. Press **ENTER** to begin entry in the selected field.
3. Enter your new data.
4. Press the **ENTER** key to confirm your changes.

Waypoint Comments

Each waypoint stored in the GPS 38 has a user-defined 16 character comment field. The default comment is the UTC date and time of the waypoint's creation.

To change or add a comment:

1. Highlight the comment field.
2. Press **ENTER** to begin entry of your comment.
3. Enter the comment and press the **ENTER** key to confirm.

Renaming & Deleting Waypoints

RENAME WAYPOINT
From
STREAM
To:
BROOK
Are you sure
Yes? or No?

The rename and delete function fields are located at the bottom left of the waypoint definition page (you'll need to use the **◀** key to move the highlightout of its main scrolling sequence).

Editing & Scanning Waypoints

To rename a stored waypoint:

1. Highlight the 'RENAME?' field and press **ENTER**.
2. Enter the new waypoint name and press **ENTER**.
3. Press the **ENTER** key to confirm your changes.

To delete a stored waypoint:

1. Highlight the 'DELETE?' field and press **ENTER**.
2. Select the 'Yes?' prompt.
3. Press **ENTER** to delete the waypoint.

Scanning Waypoints

As you manually enter a waypoint's name, the GPS38's waypoint scanning feature will automatically display the first numerical or alphabetical match of the character you have entered to that point. This helps eliminate the need to always enter a waypoint's complete name.

To scan waypoints from a waypoint field:

1. Highlight the waypoint name field and press **ENTER**.
2. Press the **◀** key to clear the name field.
3. Use the arrow keypad to scroll through the waypoints.
4. If you have more than one waypoint that begins with the same letter or number, you must use the **▶** key to move to the next character positions as needed. Only the first character match is listed for each character set.
5. Once you've found the desired waypoint, press **ENTER**.



To delete a waypoint, confirm the 'Yes?' prompt. Route or active waypoints may not be deleted until they are removed from the route or the GOTO has been cancelled.

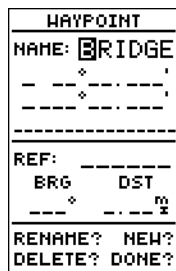

The waypoint scanning feature will offer the first waypoint that matches the character or characters you have entered to that point.

Starting/Stopping a GOTO & MOB



Select a destination waypoint from the GOTO waypoint list.

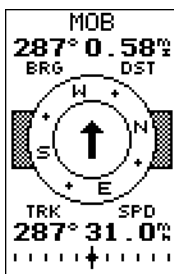

Once the MOB mode has been activated, steering guidance will be provided by the Compass or Highway Page. Activating another MOB will overwrite the previous MOB waypoint.

Selecting a GOTO Destination

The GPS 38 provides four ways to navigate to a destination: GOTO, MOB, TracBack and route navigation. The most basic method of selecting a destination is the GOTO function, which lets you choose any stored waypoint as the destination and quickly sets a direct course from your present position.

To activate the GOTO function:

1. Press the **GOTO** key. The GOTO waypoint list, an alphabetical list of all available waypoints, will appear.
2. Select the waypoint you want to navigate to (it may already be highlighted).
3. Press the **ENTER** key to confirm, or **QUIT** to stop selection of a GOTO destination and return to the previous page.

Once a GOTO waypoint has been activated, the Compass Page or Highway Page will provide steering guidance to the destination until the GOTO is cancelled, or the unit has resumed navigating the active route (see page 36).

To cancel an active GOTO:

1. Press the **GOTO** key.
2. Move the field highlight to the 'CANCELGOTO?' prompt at the bottom of the page.
3. Press **ENTER**.

Man Overboard Function

The GPS 38's man overboard function (MOB) lets you simultaneously mark and set a course to a position for quick response to passing positions (like the spot where your hat blew overboard).

To activate the MOB mode:

1. Press the **GOTO** key twice. The GOTO waypoint page will appear with 'MOB' selected as the default destination.
2. Press the **ENTER** key to begin MOB navigation.

The GPS 38 will now guide you to the MOB waypoint until the MOB GOTO is cancelled (see page 28). If you want to save the MOB waypoint, be sure to rename it, as it will be overwritten the next time a MOB is executed.

TracBack Navigation

TracBack Navigation

The third method of navigating to a destination is by using the GPS 38's TracBack feature. The TracBack function allows you to quickly and easily retrace your path using the track log automatically stored in the receiver's memory. The advantage of the TracBack feature is to eliminate the need to mark waypoints along the way and manually create and activate a route back to where you began your trip.

The TracBack route is created by reducing your current track log into a route of up to 30 waypoints, and activating an inverted route along those points. Once activated, a TracBack route will lead you back to the oldest track log point stored in memory, so it's usually a good idea to clear the existing track log at the starting point of your current trip (e. g. the trail head or your car) **before** you get started.

To clear the track log and define a starting point for a TracBack route:

1. From the Menu Page, highlight the 'TRACKLOG' option.
2. Press **ENTER** to access the track log page.
3. Highlight the 'CLEARLOG?' option.
4. Press **ENTER**. The clear log confirmation page will appear.
5. Highlight the 'Yes?' prompt and press **ENTER**.

To activate a TracBack route:

1. From the Menu Page, highlight the 'TRACKLOG' option.
2. Press **ENTER** to access the track log page.
3. Highlight the 'TRACBACK?' option and press **ENTER**.

Once the TracBack function has been activated, the GPS 38 will take the track log currently stored in memory and divide it into segments called legs. Up to 30 temporary waypoints (e.g., 'T001') will be created to mark the most significant features of the track log to duplicate your exact path as closely as possible. A TracBack route from your present position to the oldest track log point will be created as the active route (the active route page will appear), and provide steering guidance to each waypoint back to the starting point of your track log.

TRACK LOG	
RECORD:	Yes
CRITERIA:	
Automatic	
MEMORY USED	
2 of 768	
points (0%)	
CLEAR LOG?	
TRACBACK?	

Clearing the log before you get started will define the position the TracBack function will return you to.

TRACK LOG	
RECORD:	Yes
CRITERIA:	
Automatic	
MEMORY USED	
2 of 768	
points (0%)	
CLEAR LOG?	
TRACBACK?	

Highlight the 'TracBack' prompt and press ENTER to begin TracBack navigation. An on-screen status box will monitor the progress of the TracBack calculation.

TracBack Navigation

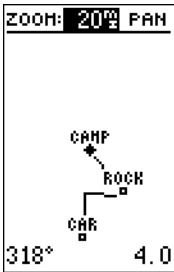

The TracBack feature will navigate your track log back to the oldest point in the receiver's memory.

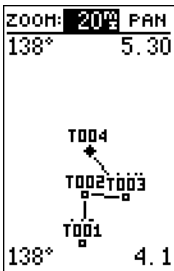

The track log will be divided into segments with temporary waypoints to create a route back to the beginning of the track log.

Tips on Creating and Using the TracBack Feature

The GPS 38's TracBack feature is designed to help you quickly create and activate a route that follows your path back to a user-defined starting point. To get the most out of the TracBack feature, remember the following tips:

- Always clear your track log at the exact point that you want to go back to (trail head, truck dock, etc.).
- The 'RECORD' option on the track log setup page must be set to the 'Yes' position.
- There must be at least two track log points stored in memory to create a TracBack route.
- If there are not enough available waypoints in memory to create a TracBack route, you will be alerted with a 'waypoint memory full' message, and the receiver will use any available waypoints to create a TracBack route with an emphasis on the track log closest to the destination (the oldest track log point in memory).
- If the 'CRITERIA' option on the track log setup page is set to a time interval, the TracBack route may not follow your exact path (keeping the criteria set to automatic will always provide the best TracBack route).
- If the receiver is turned off or you lose satellite coverage during your trip, the TracBack route will simply draw a straight line between any point where coverage was lost and where it resumed.
- If the changes of direction and distance of your track log are very complex, 30 waypoints may not be enough to accurately mark your exact path. The receiver will then assign the 30 waypoints to the most significant points of your track, and simplify segments with fewer changes in direction.
- If you want to save a TracBack route, copy route 0 to an open storage route before activating another TracBack. Activating another TracBack or storage route will overwrite the existing TracBack route.
- Whenever a TracBack route is activated, the receiver will automatically erase any temporary waypoints (e.g., 'T001') that are not contained in routes 1-19. If there are temporary waypoints stored in routes 1-19, the receiver will create any new temporary waypoints using the first three digit number available.

Creating and Navigating Routes

The last form of navigating to a destination with the GPS 38 is by creating a user-defined route. The route navigation feature lets you plan and navigate a course from one place to another using a set of pre-defined waypoints. Routes are often used when it's not practical, safe or possible to navigate a direct course to a particular destination (e.g., through a body of water or impassable terrain).

Routes are broken down and navigated in smaller segments called "legs". The waypoint you are going to in a leg is called the "active to" waypoint, and the waypoint immediately behind you is called the "active from" waypoint. The line between the "active to" and the "active from" waypoint is called the "active leg".

Route Navigation

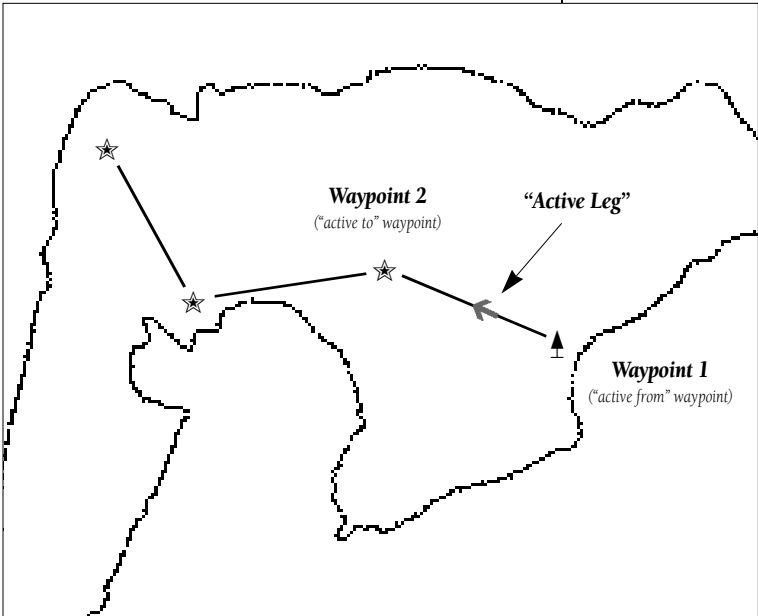

Whenever you activate a route with the GPS 38, it will automatically select the route leg closest to your position as the active leg. As you pass each waypoint in the route, the receiver will automatically sequence and select the next waypoint as the "active to" waypoint.

Creating A Route

MARK POSITION

Waypoint:

FALLS

N 40°23.754'

W074°46.123'

Add to route

number: **1**

SAVE?

If you're heading out without a planned route, the mark function can be used to quickly create a route back to your starting point.

Create a series of waypoints along the way with the MARK key and save them to an open route from the mark position page. When you're ready to head back, simply activate the route you created in inverted order (see page 34).

Route Definition Page

The GPS 38 lets you create and store up to 20 routes of 30 waypoints each. Routes are created, copied, and edited through the route definition page, which is accessed through the Menu Page.

To select the route definition page:

1. Press **PAGE** until the Menu Page appears.
2. Highlight the 'ROUTES' option.
3. Press the **ENTER** key to display the route definition page.
4. To return to the Menu Page, press **PAGE**.

NO	WAYPT	DTK	DST
1	----	----	----
2	----	----	----
3	----	----	----
4	----	----	----
5	----	----	----
6	----	----	----
TOTAL DST			0.00
COPY TO: --			
CLR? INV? ACT?			

Annotations:

- Comment Field: Points to the text area above the table.
- Route Number: Points to 'ROUTE: 0'.
- Desired Track of Leg: Points to the 'DTK' column.
- Copy Field: Points to the 'COPY TO: --' field.
- Leg Distance: Points to the 'DST' column.
- Total Distance: Points to 'TOTAL DST 0.00'.
- Function Prompts: Points to 'CLR? INV? ACT?'.

The route number field is displayed at the top of the page, with a 16-character user comment below. If no user comment is entered, the field will display the first and last waypoint in the route. The waypoint list in the middle of the page accepts up to 30 waypoints for each route, with fields for desired track and distance between waypoints. The total distance of the route is indicated below the waypoint list.

The bottom of the route definition page features several function fields which let you copy, clear, invert, or activate the displayed route. Routes 1-19 are used as storage routes, with route 0 always serving as the active route you are navigating. If you want to save a route currently in route 0, be sure to copy it to another open route, as it will be overwritten by the next route activation.

Creating, Copying & Clearing Routes

To create a route from the route definition page:

1. Highlight the route number field and press **ENTER**.
2. Enter a route number and press the **ENTER** key to confirm.
3. Press **ENTER** to begin entry of a route comment. (Note that the default (first and last waypoint) comment will only appear if the comment field is blank).
4. Enter your comment and press the **ENTER** key.
5. Highlight the No. 1 waypoint field and press **ENTER**.
6. Enter the first waypoint of your route and press **ENTER**.
7. Continue entering the rest of your waypoints in order, using the **ENTER** key to start and confirm each field entry. The list will automatically scroll down as needed.
8. After you have entered all your waypoints, press **PAGE**.

Copying and Clearing Routes

The route definition page is also used to copy a route to another route number. This feature is useful when you make changes to the active (or TracBack) route and want to save the route for future use.

To copy a route:

1. Highlight the route number field and press **ENTER**.
2. Enter the route number to be copied and press **ENTER**.
3. Highlight the 'COPYTO' field and press **ENTER**.
4. Scroll through the available routes and select a destination route number. Only open routes will be available as choices. Press the **ENTER** key to copy the route.
5. Press the **PAGE** key to return to the Menu Page.

To clear a route from memory:

1. Highlight the route number field and press **ENTER**.
2. Enter the route number and press **ENTER**.
3. Select the 'CLR?' prompt and press **ENTER**.

ROUTE: 4			
RIDGE TRAIL			
NO	WAYPNT	DTX	DST
1	STREAM	---	---
2	-----	---	---
3	-----	---	---
4	-----	---	---
5	-----	---	---
6	-----	---	---
TOTAL DST			0.00
COPY TO: --			
CLR? INV? ACT?			

Enter each waypoint in the order you would like to navigate them. If you enter a waypoint not stored in memory, you'll need to define the position on the waypoint definition page.

ROUTE: 2			
CAR TO CAMP			
NO	WAYPNT	DTX	DST
1	CAR	027'	1.0
2	STREAM	320'	1.1
3	BRIDGE	082'	1.3
4	CAMP	---	---
5	-----	---	---
6	-----	---	---
TOTAL DST			3.31
COPY TO: 3?			
CLR? INV? ACT?			

To copy a route, select an open storage route and press the ENTER key. If you select a route that is already used, you'll be alerted with an 'Route Full' message.

Clearing, Activating & Inverting Routes

CLEAR ROUTE

WARNING!

all waypoints
will be removed
from this route

Are you sure
Yes? or No?

Clearing a route only removes the waypoints from the route selected. The waypoints used will remain in the receiver's memory.

ROUTE: 2			
CAR TO CAMP			
NO	WAYPNT	DTK	DST
1	CAR	027'	1.0
2	BROOK	320'	1.1
3	BRIDGE	082'	1.3
4	CAMP	---	---
5	---	---	---
6	---	---	---
TOTAL DST			3.31
COPY TO: --			
CLR? INV? ACT?			

To activate a route, highlight the 'ACT?' prompt and press ENTER.

Clearing a Route (continued)

The clear route warning will appear, asking you to confirm that you want to remove all waypoints from the route.

1. Highlight the 'Yes?' selection.
2. Press **ENTER** to confirm your action.
3. Press **PAGE** to return to the Menu Page.

Activating and Inverting Routes

After a route has been entered, it can be activated in its defined sequence or inverted from the route definition page. The process of activating or inverting a stored route takes a storage route (routes 1-19) and copies it into the active route (route 0) for navigation. The storage route is now no longer needed and will be retained in its original format under its existing route number.

This system allows you to have an active route that you may edit during navigation and save as an entirely new route from the original. You will have to copy the active route to an unused storage route to save it, since new route or TracBack activation overwrites route 0.

To activate a route:

1. Select the route definition page and press the **ENTER** key to activate the route number field.
2. Enter the route number to be activated and press **ENTER**.
3. Move the field highlight to the 'ACT?' prompt and press the **ENTER** key.

Inverting a route allows you to navigate route legs in reverse order, without editing the original route.

To activate a route in inverted order:

1. Follow the steps above, but select the 'INV?' prompt and press **ENTER**.

Active Route Page

Once a route has been activated, the active route page will appear, displaying the waypoint sequence of your route with the estimated time enroute (ETE) at your present speed and distance to each waypoint. As long as you are navigating an active route, the active route page will become part of the main page sequence of the unit.

The active route page will also allow you to change the ETE field to display desired track (DTK) or estimated time of arrival (ETA) for each leg. You can also clear or invert the active route.

To display DTK or ETA for each leg:

1. Highlight the estimated time enroute (ETE) field and press the **ENTER** key.
2. Select 'DTK' or 'ETA' and press the **ENTER** key.

The active route page also allows you to clear (stop navigating) or invert the active route without using the route definition page.

To invert a route from the active route page:

1. Move the field highlight to the 'INVERT?' prompt.
2. Press the **ENTER** key to invert the route.

To clear the active route from the active route page and stop route navigation:

1. Select the 'CLEAR?' prompt.
2. Press the **ENTER** key to clear the active route.

Editing Routes

Once a route has been created and stored, it can be edited at any time, even if it is the active route.

To edit a route from the active route page or the route definition page:

1. Select the waypoint you want to edit and press **ENTER**.

Active Route Page

ACTIVE ROUTE		
CAR TO CAMP		
WAYPNT	ETE	DST
CAR	--:--	----
STREAM	14:01	0.95
BRIDGE	29:42	2.02
CAMP	48:25	3.30
----	----	----
----	----	----
----	----	----
----	----	----
CLEAR? INVERT?		

Active Route Page

Whenever you have an active route, the active route page will appear in the main page sequence after the Compass/Highway Page.

ACTIVE ROUTE		
CAR TO CAMP		
WAYPNT	ETE	DST
CAR	--:--	----
STREAM	13:50	0.94
BRIDGE	29:31	2.01
CAMP	48:15	3.28
----	----	----
----	----	----
----	----	----
----	----	----
CLEAR? INVERT?		

To edit or review a route waypoint from the active route page, highlight the desired waypoint and press **ENTER**.

Editing Routes & On-Route GOTOs

ROUTE: 2	
CAR TO CAMP	
NO	HAUENT DTU DST
1	CF REVIEW?
2	8 INSERT?
3	BF REMOVE?
4	Chm CHANGE?
5	-----
6	-----
TOTAL DST 3.34	
COPY TO: --	
CLR? INV? ACT?	

Use the on-screen menu to select the desired editing function.

GOTO WAYPOINT
BRIDGE
CAMP
CAR
MAP
STREAM

CANCEL GOTO?

You can skip ahead to any route waypoint by highlighting the desired waypoint and pressing the GOTO key.

Editing Routes (continued)

An on-screen menu of editing choices will appear, with options for reviewing, inserting, deleting or changing the waypoint field highlighted. Use the ▲ and ▼ arrow keys to select among the editing choices.

Once you've selected a waypoint from the route list, choose a menu function:

1. To review the definition page for the waypoint, highlight the 'REVIEW?' prompt and press **ENTER**.
2. To add a new waypoint that precedes the selected waypoint, highlight the 'INSERT?' prompt and press **ENTER**.
3. To remove the selected waypoint, highlight the 'REMOVE?' prompt and press the **ENTER** key.
4. To replace the selected waypoint with a new waypoint, highlight the 'CHANGE?' prompt and press the **ENTER** key.

Use the route waypoint editing instructions described earlier for creating a route to complete your changes. If you are editing the active route (route 0), copy your new route version to an empty route to save it, as the active route will be overwritten by a new route activation.

If you add, delete or change the first or last waypoint of a route, the default comment (first and last waypoint) will automatically be updated after your changes.

On-Route GOTOs

At the beginning of this section, we mentioned that the GPS 38 will automatically select the route leg closest to your position as the active leg. This will give you steering guidance to the desired track of the active leg. If you would prefer to steer directly to a route waypoint, you can perform an 'on-route GOTO' from the active route page.

1. Highlight the desired route waypoint and press the **GOTO** key.
2. Once the GOTO waypoint page appears, press **ENTER** to confirm the on-route GOTO waypoint.

Note that after you reach the on-route GOTO waypoint, the GPS 38 will automatically resume navigating the rest of the route in sequence.

User-defined Navigation Pages

Once you've selected a GOTO destination or activate a MOB or route, the GPS 38 will provide graphic steering guidance to the destination with one of two navigation pages:

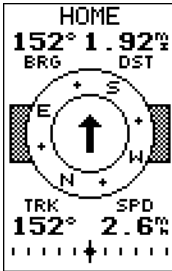

Compass Page

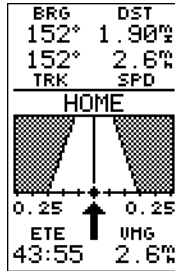

Highway Page

- The Compass Page (the default navigation page) provides a directional pointer to the destination, with a rotating compass graphic to display your direction of travel. The Compass Page is ideal for activities like hunting and hiking, and provides better steering guidance for slow-speed (e.g., walking) travel with many directional changes.
- The Highway Page provides a graphic highway that shows your movement relative to the desired course, with an emphasis on your crosstrack error, the distance and direction you are off course. The Highway Page is well suited for boating and other activities with higher speeds and straight-line courses to a destination.

Both pages provide a digital display of the bearing and distance to the destination, along with your current speed and track over the ground, as well as a course deviation indicator (CDI). You can select the desired navigation page at any time.

To select the Compass or Highway Page:

1. Press **PAGE** until the current navigation page appears.
2. Press **ENTER**. An on-screen box will appear, with the navigation page not currently in use highlighted as the default.
3. Press **ENTER** to switch the navigation screen.

Compass and Highway Pages

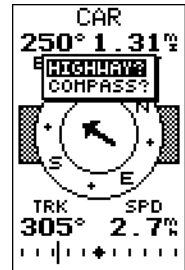

To switch the navigation page to the Highway Page, press **ENTER** twice.

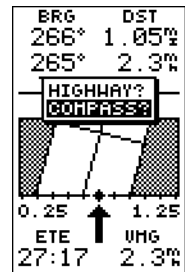

To switch the navigation page to the Compass Page, press **ENTER** twice.

Compass Page

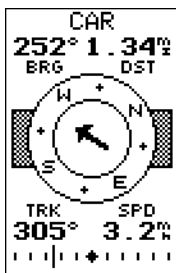

In this example, the Compass Page indicates that you are traveling in a northwest (305°) direction and the destination waypoint is southwest (252°) of your current direction of travel.

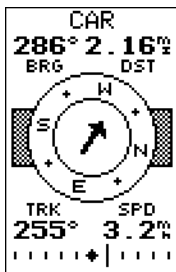

In this example, the Compass Page indicates that you are traveling in a westerly (255°) direction and the destination waypoint is slightly northwest (286°) of your current direction of travel.

Using the Compass Page

The GPS 38's Compass Page provides graphic steering guidance to a destination waypoint. The bearing (BRG) and distance (DST) to the waypoint are displayed at the top of the page, right below the destination waypoint field. The distance displayed is always the straight line distance from your present position to the destination waypoint. The bearing indicates the exact compass heading from you to the destination.

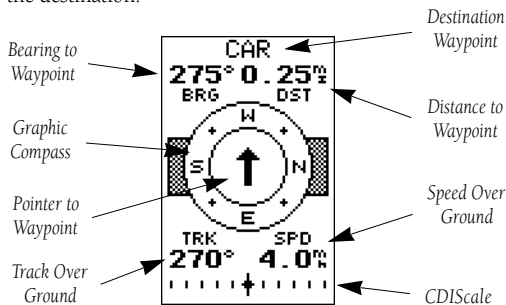

The middle of the page features a rotating “compass” that shows your current heading while you’re moving (desired track up), with a pointer arrow in the center. The arrow shows the direction of your destination from the direction you are moving. If the arrow points any direction other than up (left, right, down, etc.), turn toward the arrow until it points up and then continue in that direction.

The bottom of the Compass Page displays your current track (TRK) and speed (SPD) over the ground, while the CDI (course deviation indicator) scale shows how far you are off course. The diamond in the center of the CDI scale represents your present position, while the d-bar (the moving vertical line on the scale) indicates the direction and distance you are off the desired straight line course.

To stay on course, steer toward the d-bar until it is centered on the position diamond. The default setting of the CDI scale is +/- 0.25 miles, with each mark representing 0.05 miles of course deviation. If you do get off course by more than the selected scale, an arrow prompt will appear at the end of the scale to indicate the direction you are off course. When you are one minute away from the destination (based on your current speed and track over the ground), the GPS 38 will alert you with a flashing on-screen message box.

Using the Highway Page

The GPS 38's Highway Page also provides graphic steering guidance to a destination, with a greater emphasis on the straight line desired course and the distance and direction you are off course. The bearing and distance to waypoint, along with your current track and speed are displayed at the top of the screen, with your estimated time enroute (ETE) and velocity made good (VMG, or the rate you are closing in on your destination) at the bottom.

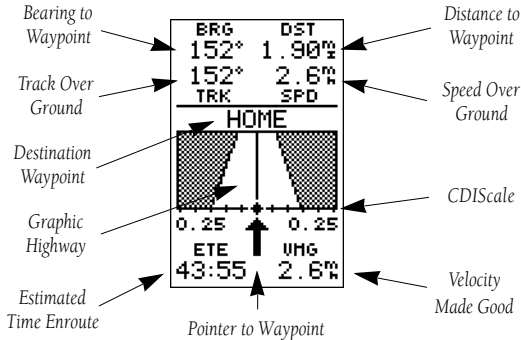

As you head towards your destination, the middle section of the screen provides visual guidance to your waypoint on a moving graphic "highway". The moving arrow just below the course deviation scale always points to your selected waypoint relative to the direction you are moving.

Your present position is represented by the diamond in the center of the course deviation scale. The line down the middle of the highway represents your desired track. As you navigate toward a waypoint, the highway will actually move, indicating the direction you're off course, relative to the position diamond on the CDI scale. To stay on course, simply steer toward the center of the highway.

If you do get off the desired course by more than 1/5th of the selected CDI range, the exact distance you are off course will be displayed where the CDI scale setting normally appears (see the example at right). If you get too far off course (the highway has disappeared), a message box will appear to indicate what course to steer to get back on course most efficiently. As you approach a waypoint, a horizontal "finish line" will move toward the bottom of the highway. When the finish line reaches the CDI scale, you've arrived at your destination.

Highway Page

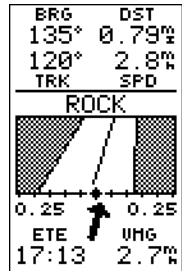

In this example, the Highway Page indicates that you are off course to the left. Steer right to get back on course. Notice the emphasis of the Highway Page is on the desired course.

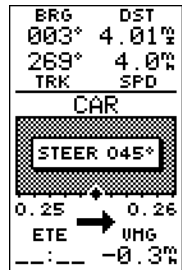

If you get too far off course, a message box will appear to indicate what course to steer to get back on course most efficiently.

Map Page

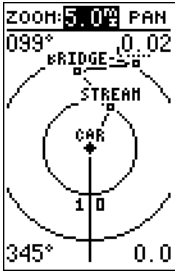

Range Rings

The GPS 38 has on-screen range rings to help you estimate distances relative to your present position. The value of each ring is determined by the current zoom scale, and is equal to 1/5 of the selected scale.

To turn the range rings display on or off (the default setting is off), see the map setup section instructions on page 49.

Map Page

The GPS 38 features a powerful real-time moving map that can do much more than just plot your course and route. The Map Page also provides you with a target cursor that will let you pan ahead to nearby waypoints, determine the distance and bearing to any map position and mark new waypoints while you navigate.

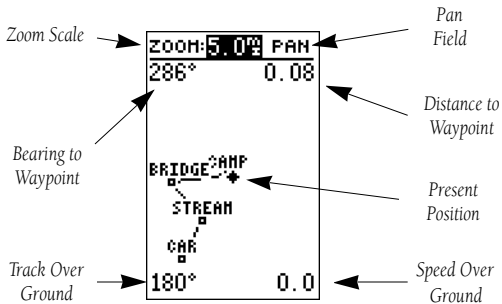

The Map Page can be broken down into two sections:

The zoom function and panning control fields are located at the top of the screen. There are 12 selectable zoom ranges from 0.2 to 320 miles or 0.5 to 600 km, measured vertically.

The map portion of the page displays your present position as a diamond icon, with your track and/or route displayed as a solid line. Nearby waypoints are represented as squares, with the waypoint name also listed. You may select which of these features are shown through the map setup submenu page (see page 49 for more information).

The four corners of the Map Page are used to display various navigation data, including the bearing and distance to a destination waypoint and your current track and speed over the ground. The two fields at the top corners of the map show your bearing and distance to one of three selectable destinations: an active destination waypoint; a highlighted on-screen waypoint; or to the panning target crosshair. If you are not navigating to a waypoint or using the panning function, the top data fields will not be displayed. Your current track and speed are shown at the bottom corners of the display.

Zooming & Panning

Zooming and Panning

There are three main functions you can perform from the Map Page— zooming, pointing and panning. Each of these functions has its own “field”, which may be selected and activated for use. Whenever the Map Page first appears, the zoom field (at the top left) is always highlighted. The moving map has 12 map scales which are selected through the zoom function field.

To select a zoom scale:

1. Use the arrow keypad to highlight the zoom field.
2. Press the **ENTER** key to begin range selection.
3. Select a range scale.
4. Press **ENTER** to confirm your selection.

The second function field on the Map Page is the pan field, located at the top right of the screen. The pan function allows you to move the map with the four arrow keys to view areas outside the current map.

To activate the pan function:

1. From the zoom field, highlight the pan field.
2. Press the **ENTER** key to activate the pan function.
3. Use the arrow keys to move the map in any direction.

As you begin to move the map, a crosshair will appear. This crosshair will now serve as a target marker for the moving map. The distance and bearing to destination will now be replaced by the distance and bearing from your present position to the target crosshair.

As you pan around the map, you'll notice that the target crosshair will “snap” to on-screen waypoints and highlight the waypoint name. Once a waypoint name is highlighted, you can review its waypoint definition page or execute a GOTO function right from the Map Page.

To review the definition page for a waypoint highlighted in the map field:

1. Press **ENTER**. To return to the map page, press **ENTER**.

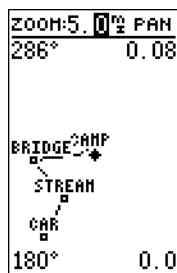

Selecting Map Scales

To change the map scale, highlight the zoom field and press **ENTER**. Use the Up and DOWN keys to select the scale.

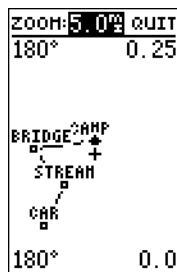

Panning Function

During panning mode, an on-screen crosshair will appear. Your present position will remain as a diamond icon, with the range and bearing to the crosshair displayed in the top corners of the map.

Using The Cursor On The Map

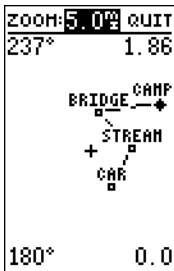

To stop panning, press the QUIT key.



On-Screen Pointing

The crosshair will “snap” to waypoints displayed on the map, which allows you to quickly review or go to the selected waypoint right from the Map Page.

To go to a waypoint highlighted in the map field:

1. Press the **GOTO** key.
2. Press the **ENTER** key to confirm the GOTO waypoint page.

To stop the panning function and display the present position diamond:

1. Press the **QUIT** key.

Pointing at On-Screen Waypoints

The last field on the Map Page is the map itself. From the zoom or pan fields, the cursor highlight may be moved into the map display by pressing the down arrow key. The arrow keys will now move the field highlight through the map and “point” at on-screen waypoints.

To point at a displayed waypoint:

1. Use the arrow keys to move the cursor highlight from the zoom field into the map field.
2. Once you are in the map field, use the four arrow keys to scroll through on-screen waypoints. The arrow key you use will determine the direction of your scroll. Once you have scrolled through all the waypoints, the cursor will move back to the zoom or pan function field.

Once a waypoint has been selected in the map field, its distance and bearing from your present position will be displayed at the top corners of the Map Page. You can also review its waypoint definition page or select it as a GOTO destination by following the same steps outlined above for waypoints highlighted on the map field. To get the most out of panning, you’ll need to be able to zoom in and out while you’re panning. This lets you move the map at a faster speed and zoom in for waypoint details. Once the pan function is activated, the cursor highlight moves back to the zoom field.

To adjust the zoom range while panning:

1. Press the **ENTER** key to begin range selection.
2. Select the desired range.
3. Press **ENTER** to return to normal panning mode.

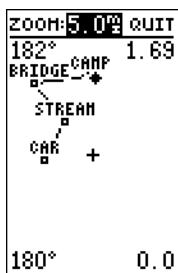

Using the Cursor to Mark and GOTO Waypoints

During panning, the crosshair represents a target position right on the moving map, with the range and bearing to the target displayed at the top corners of the screen. You can also use the target crosshair to mark a new waypoint position or as a GOTO destination right from the map field.

To mark the target crosshair position as a new waypoint:

1. Press the **MARK** key to capture the position.
2. Enter a new name and route number if you wish.
3. Press the **ENTER** key to save the waypoint and return to the map page.

You can also use the target crosshair as an instant GOTO destination. Similar to the MOB mode, this function will mark and instantly set a course for a new waypoint called 'MAP'.

To go to the target crosshair:

1. Press the **GOTO** key to capture the position.
2. Press the **ENTER** key to confirm the MAP GOTO.

If you want to save the MAP waypoint, be sure to rename it, as it will be overwritten the next time a map GOTO is executed.

REFERENCE

Using The Cursor On The Map

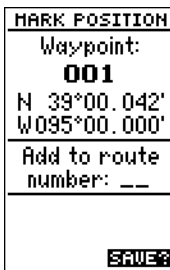

Marking a Waypoint

To mark a new waypoint with the crosshair, simply pan to the desired position and press the MARK key.

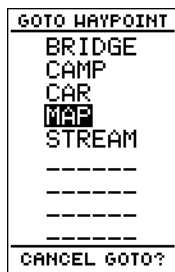

MAPGOTO

The crosshair may also be used to define a GOTO destination by panning to the desired position and pressing the GOTO key. If you want to save the MAP waypoint, be sure to rename it.

Menu Page & Distance/Sun Calculation

MENU
NEAREST WPTS
WAYPOINT LIST
WAYPOINT
ROUTES
DIST AND SUN
MESSAGES
SYSTEM SETUP
NAV SETUP
MAP SETUP
TRACK LOG
INTERFACE

Menu Page

To select a submenu, use the UP and Down keys to highlight a menu option and press ENTER.

DIST AND SUN
FROM: CAR
TO: CAMP
BRG DST
029° 2.11%
DATE: 24 APR 98
SUNRISE
---:---
SUNSET
---:---
AT DESTINATION

Distance/Sun Calculation

The GPS 38 will calculate the sunrise and sunset times of any stored waypoint or your present position. To calculate, enter the date and year and press ENTER.

Menu Page

The GPS 38 Menu Page provides access to submenu pages that are used to select and customize operation and navigation setup. The 11 submenus are divided into categories by function. The waypoint and route management submenus are discussed in their own respective sections. We'll now address the rest of the submenus in the order they appear on the Menu Page.

To select a submenu page from the Menu Page:

1. Highlight the submenu page you want to view.
2. Press the **ENTER** key to display the submenu page.
3. To return to the Menu Page, press the **PAGE** key.

Distance and Sun Calculation

The distance and sun calculation page will give you the distance and bearing between any two waypoints and calculate the sunrise and sunset (in local time) at a destination waypoint for a particular date.

To perform a distance and sun calculation:

1. Highlight the 'FROM' field and enter the desired waypoint. Press **ENTER** to move to the next field.
2. Highlight the 'TO' field and enter the destination waypoint. Press the **ENTER** key to calculate the range and bearing to the destination waypoint.
3. Highlight the 'DATE' field and enter the date for your destination. Press the **ENTER** key to display the sun information.

Message Page

The message page displays all current messages in the GPS 38. There are two types of messages: temporary alerts (eg. approaching a waypoint) and condition alerts (eg. battery power is low). All messages are initially indicated by a flashing on-screen box. After a temporary alert has been viewed, it is cleared. Condition alerts are displayed on the message page until the condition has been resolved.

To view the message page:

1. Highlight to the 'MESSAGES' field and press **ENTER**.

See appendix A for a complete list of messages.



System Setup

System Setup

The first setup page is the system setup page, which is used to select the operating mode, time offset and screen preferences. The GPS 38 has three operating modes:

- **Normal Mode** operates the unit at maximum performance, and provides a battery life up to 12 hours on alkaline batteries.
- **Battery Saver Mode** is suitable for most applications, and extends battery life to up to 20 hours on alkaline batteries by reducing the receiver's update rate when navigational conditions permit (e.g., you're traveling a steady course without speed or heading variations). Since battery saver mode changes the update rate based solely on navigational conditions, the battery life will vary accordingly.
- **Simulator Mode** allows you to operate the unit without acquiring satellites, and is ideal for practicing or entering waypoints and routes while at home.



To select an operating mode:

1. Highlight the 'MODE' field and press .
2. Use the arrow keypad to select a mode and press .

Date and Time Setup

The date and time field is located directly below the mode field. Because the time shown is UTC time, you will need to enter a time offset to display the correct local time for your area. To determine the time offset for your area, note your position and refer to the chart in appendix A.

To enter the time offset:

1. Highlight the 'OFFSET' field and press the  key.
2. Enter the time offset and press . Remember to select a positive or negative indicator for your offset.

SYSTEM SETUP	
MODE:	BatterySave?
DATE	22 DEC 95
TIME	01:27:21
OFFSET:	+10:00
HOURS:	12
CONTRAST:	██████
LIGHT:	15 sec

System Setup Page

Select battery saver mode to get the best possible battery life. Note that screen back-lighting will always have the biggest effect on battery life, regardless of operating mode.

SYSTEM SETUP	
MODE:	Simulator
DATE	22 DEC 95
TIME	01:27:48
OFFSET:	-00:00
HOURS:	12
CONTRAST:	██████
LIGHT:	15 sec

Time Offset

To display the correct local time, you must enter the appropriate offset from the chart at the end of Appendix A.

Setting Time, Screen Contrast & Tone

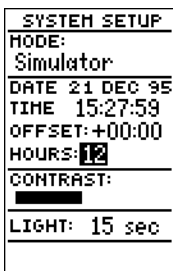

12/24 Hour Clock

To display the time in AM/PM format, select the 12 hour option from the 'HOURS' field.

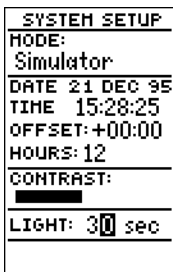

Screen Backlighting

To get the longest battery life, keep the screen backlighting at the default 15 second option.

Time Format

The time display shown on the system setup and Position Pages may be set to display the time in a 12 or 24 hour format.

To select the time format:

1. Highlight the 'HOURS' field and press the **ENTER** key.
2. Use the arrow keypad to select the 12 or 24 hour option.
3. Press **ENTER** to confirm.

Screen Contrast

The GPS 38 features adjustable screen contrast for optimum viewing in any condition. The screen contrast is set by using an on-screen bar scale.

To set the screen contrast:

1. Move the field highlight to the 'CONTRAST' field and press the **ENTER** key.
2. Use the **◀** and **▶** keys to adjust the bar scale for the desired contrast and press the **ENTER** key.

Screen Backlighting

The screen backlight timer is adjustable for 0, 15, 30, 60, 120 and 240 seconds. The '0' setting will keep the screen backlighting on as long as the unit is on (NOTE: the default 15 second backlighting setting will provide the longest battery life). Whenever backlighting is on, a bulb icon will appear on the Satellite Page.

To set the backlight timer:

1. Highlight the 'LIGHT' field and press the **ENTER** key.
2. Select the desired setting. Confirm the setting by pressing **ENTER**.
3. To turn lighting on and off, press **☹** briefly.

We've now gone through the operation setup submenu and its various settings. To return to the Menu Page:

1. Press the **PAGE** key.

Navigation Setup

Navigation Setup

The navigation setup page is used to select units of measurement for position format, map datum, CDI scale, and distance, speed, and heading information.

Position Formats

The default position setting for the GPS 38 is latitude and longitude in degrees and minutes (hddd°mm.mmm'). You may also select degrees, minutes and seconds (hddd°mm'ss.s"); degrees only (hddd.dddd°); UTM/UPS coordinates; or British, German, Irish, Maidenhead, Swedish, Swiss, or Taiwan grid formats.



To select a position format:

1. Highlight the 'POSITIONFRMT' field and press .
2. Use the  and  keys to select the desired setting. Confirm the setting by pressing .

Map Datums

The map datum field is located just below the position format field, and comes with a WGS 84 default setting. Although 104 total map datums are available for use (see the map datum listing in appendix B), you should only change the datum if you are using maps or charts that specify a different datum than WGS 84.



To select a map datum:

1. Highlight the 'MAPDATUM' field and press .
2. Select the desired setting. Confirm the setting by pressing .

CDI Scale Settings

The course deviation indicator (CDI) scale definition field lets you select the +/- range of the CDI bar scale. Three scales are available: +/- 0.25, 1.25 and 5.0 miles or kilometers, with 0.25 being the default setting.

To enter a CDI scale setting:

1. Highlight the 'CDISCALE' field and press .
2. Select the desired setting.
3. Press the  key to confirm the selection.

NAV SETUP	
POSITION FRMT:	 UTM/UPS
MAP DATUM:	WGS 84
CDI SCALE:	±0.25
UNITS:	Statute
HEADING:	User Mag:E000

NAV Setup Page

The position format may be set to display your position in various lat/lon or grid formats.

NAV SETUP	
POSITION FRMT:	hddd°mm.mmm'
MAP DATUM:	 WGS 84
CDI SCALE:	±1.25
UNITS:	Statute
HEADING:	User Mag:E000

Map Datum

The GPS 38's default map datum is WGS 84.

WARNING: Using the wrong map datum can seriously affect the accuracy of your GPS.

Navigation Setup

NAV SETUP	
POSITION FRMT:	UTM/UPS
MAP DATUM:	WGS 84
CDI SCALE:	±0.25
UNITS:	Statute
HEADING:	User Mag:E000

Magnetic Heading

To enter a user-defined magnetic variation, select the 'User Mag' option and enter the desired direction and value.

MAP SETUP	
ORIENTATION:	North Up
PLOTTED ITEMS	
RINGS:	No
ROUTE:	Yes
NEAREST:	Yes
NAMES:	Yes
TRACK LOG:	250

Map Setup Page

The map orientation can be set to track up, north up, or desired track up. The plotted items options let you define what appears on the map display.

Units of Measure

The GPS 38 lets you select statute (default), nautical or metric units of measure for all speed and distance fields.

To change the unit of measure:

1. Highlight the 'UNITS' field and press the **ENTER** key.
2. Select the desired unit of measure.
3. Press the **ENTER** key to confirm the selection.

Magnetic Heading Reference

The GPS 38's heading information can be displayed referencing magnetic north (auto or user-defined), true north or calculated grid headings. The default setting is automatic magnetic north, which is suitable for most applications.

To select a heading reference:

1. Highlight the 'HEADING' field and press **ENTER**.
2. Select the desired heading preference.
3. Press the **ENTER** key to confirm the selection.

To enter a custom magnetic heading:

1. Select the 'USER MAG' option and press **ENTER**.
2. Enter the degrees and direction of magnetic variation.
3. Press the **ENTER** key to confirm the magnetic variation value.

Map Setup and Orientation

The map setup page lets you select map orientation and specify what items are displayed. The map may be oriented to north up, the direction of current travel (track up) or the direction of an active route leg (desired track up). The default setting is track up.

To change the map orientation:

1. Highlight the 'ORIENTATION' field and press **ENTER**.
2. Select the desired setting and press **ENTER**.

Map Page & Track Log Setup

Selecting Displayed Items on the Map Page

The rest of the map setup page lets you specify what items are displayed or plotted on the Map Page. The first 4 plot items may be turned on or off by selecting 'Yes' or 'No' in the appropriate field:

- The 'RINGS' selection will display the 3 present position range rings on the map.
- The 'ROUTE' selection will plot the straight leg lines between waypoints of an active route and display all route waypoint names.
- The 'NEAREST' selection will display the nine nearest waypoints to your present position (not to the target cursor on the map).
- The 'NAMES' selection will display the waypoint name for the nine nearest waypoints.

To turn a plotted item on or off:

1. Highlight the confirmation (Yes or No) field for the plotted item and press **ENTER**.
2. Select 'Yes' or 'No' and press **ENTER**.

Track Log Display

The track log option sets the number of points the unit will attempt to display on the Map Page. The default setting of 250 points provides good resolution with minimal screen clutter. The maximum setting is 768 points. Once you've reached the maximum number of track points, the older points will be lost as new points are added. Note that adjusting the track points displayed will not affect whether or not the receiver records a track log or the ability to create a TracBack route.

To enter a log setting:

1. Highlight to the 'TRACK LOG' field and press **ENTER**.
2. Enter a value in the 3-digit field and press **ENTER**. If you do not want to display a track, enter '000'.

Track Log Setup Page

The track log setup page lets you manage the GPS 38's tracking data. From this page, you can select whether or not to record a track and define how it is recorded.

MAP SETUP	
ORIENTATION:	North Up
PLOTTED ITEMS	
RINGS:	No
ROUTE:	Yes
NEAREST:	Yes
NAMES:	Yes
TRACK LOG:	250

Range Rings

On screen range rings will appear on the map when the 'Rings' option is set to the 'Yes' position.

MAP SETUP	
ORIENTATION:	North Up
PLOTTED ITEMS	
RINGS:	No
ROUTE:	Yes
NEAREST:	Yes
NAMES:	Yes
TRACK LOG:	250

Track Log

The track log option only defines how many points are displayed on the map. Setting the value at 000 will not prevent a track log from being recorded.

Navigation Page Setup

TRACK LOG	
RECORD:	Yes
CRITERIA: Automatic	
MEMORY USED 2 of 768 points (0%)	
CLEAR LOG? TRACBACK?	

Track Log Page

Turning off the track recording option will prevent you from using the TracBack feature.

CLEAR LOG	
WARNING!	
all track log points will be deleted	
Are you sure Yes? or No?	

To clear the track log, confirm the 'Yes?' prompt.

Track Log Setup (continued)

To turn the track log on or off:

1. Highlight the 'RECORD' field and press **ENTER**.
2. Select 'Yes' or 'No' and press **ENTER**. NOTE: Turning the track recording off will disable the TracBack feature.

Track Criteria

The stored track criteria determines how often positions are stored in the track log. The default setting is automatic, which stores track based on resolution. This setting gives you the most efficient use of track memory and provides the most accurate TracBack route.

To change the criteria to record points based upon a specific time interval:

1. Highlight the 'CRITERIA' field and press **ENTER**.
2. Select 'Time Interval' and press **ENTER**.
3. Press **ENTER** to begin entry of the interval.
4. Enter a value in hours, minutes and seconds and press the **ENTER** key.

Managing and Clearing the Track Log

The rest of the track log setup page displays the percentage of available memory currently used to store track log data and function fields to clear the track log memory and activate the TracBack feature.

To clear the track log:

1. Highlight 'CLEARLOG?' and press **ENTER**.
2. A warning page will appear, asking you to confirm your actions. Move the field highlight to the 'Yes?' field and press **ENTER**.

TracBack Function

The TracBack option lets you activate a TracBack route using the track log (see page 29-30 for more information).



To activate a TracBack route:

1. Highlight the 'TRACBACK?' option and press **ENTER**.

Interface Setup



The GPS 38's interface setup page lets you specify the interfacing formats for connecting external devices. There are five interface options: GRMN/GRMN, None/None, None/NMEA, RTCM/None, and RTCM/NMEA. Each option lists the input format first, followed by the output format.

To select I/O format:

1. Highlight the I/O field and press .
2. Select the desired setting and press .



The GRMN/GRMN setting is a proprietary format that lets you exchange information such as waypoints, routes and track logs between two GARMIN GPS devices or a PC. During data transfer, the number of packets being exchanged will be displayed on screen.

To select a transfer option:

1. Highlight the 'Host' field and press .
2. Select a setting and press .

To disable all interfacing capabilities, select the None/None setting. If you want to output NMEA data to compatible external devices without any differential input capability, select the None/NMEA setting. Once a NMEA output setting has been selected (with or without RTCM input), the NMEA field will become highlighted. NMEA formats 0180, 0182 or 0183 (1.5 or 2.0) are available.

To select a NMEA format:

1. Press  to begin a NMEA selection.
2. Select a format and press .

DGPS Interface

The last two format settings allow the differential-ready GPS 38 to accept RTCM DGPS corrections in RTCM 104 version 2.0 format. Using DGPS corrections will improve receiver accuracy to 5-10 meters, regardless of errors induced by the government's Selective Availability (SA) program. The RTCM/NONE format will allow connection to any manually tuned beacon receiver with the proper output interface, with the baud rate selectable from the GPS 38.

Interface Setup & DGPS Setup

INTERFACE	
<input checked="" type="checkbox"/>	NONE/NMEA?
	NMEA 0180
	300 baud
BEACON RECUR	
FREQ	___KHz
RATE	25bps
DIST	___%
SNR	___dB
No Status	

Interface Setup Page

The default interface setting is the GARMIN/GARMIN option, which can be used for unit-to-unit data transfer or interfacing with a GARMINPCKit.

INTERFACE	
	NMEA/NMEA
	NMEA 0183 2.0
	4800 baud

NMEAInterface

Once a NMEA format is selected, the baud rate will automatically be set to the proper speed. See Appendix C for a list of NMEA sentences.

DGPS Interface

```

INTERFACE
-----
RTCM/NMEA
NMEA 0183 2.0
4800 baud
-----
BEACON RECVR
FREQ: 000.0KHz
RATE : 250bps
DIST  --_m
SNR   --dB
No Status
  
```

DGPSInterface

Once a RTCM option is selected, you must manually tune the beacon receiver from the frequency field.

```

MESSAGES
-----
No DGPS
Position
-----
PRESS PAGE
  
```

The message page will alert you to any problems relating to DGPS operation. You may also monitor the DGPS status from the status field on the interface setup page.

DGPS Interface (continued)

The RTCM/NMEA selection controls the GARMIN GBR-21 differential beacon receiver. Once a RTCM setting has been selected, the GPS 38 will automatically try to tune the last frequency and bit rate you selected or will switch to the default frequency of 304.0 kHz with a bit rate of 100 bps if no previous beacon has been tuned. You may also enter your own frequency and bit rate if desired.

To enter a DGPS beacon frequency:

1. Highlight the 'FREQ' field and press **ENTER**.
2. Enter the desired frequency and press **ENTER**.
3. Highlight the 'RATE' field and press **ENTER**.
4. Select the desired transmission rate.
5. Press the **ENTER** key to confirm your entry.

When the GPS 38 is receiving DGPS corrections from the GBR-21, the 'BEACON RECVR' section of the I/O setup page will display the beacon frequency and signal strength, as well as the distance from the transmitter to the beacon receiver. At the bottom of the beacon receiver field, a status message will keep you informed of DGPS activity:

- A 'Tuning' message will be displayed while a beacon signal is being tuned.
- Once the beacon signal has been tuned, a 'Receiving' message will be displayed.
- If a beacon signal is tuned and no corrections are being received, a 'No Data' message will be displayed.
- If a beacon signal cannot be tuned, a 'No Status' message will be displayed.

The GPS 38 will also display one of three alert messages concerning DGPS operation through the message page:

No DGPS Position— not enough data is available to compute DGPS position.

No RTCM Input— the beacon receiver is not properly connected or the baud rates do not match.

RTCM Input Failed— DGPS data was being received but has been lost.

Navigation Simulator

Navigation Simulator

The GPS 38's simulator mode lets you practice all aspects of its operation without active satellite acquisition. You can also plan and practice trips, enter new waypoints and routes and save them for use during normal operation. The simulator is activated from the system setup page, with speed and heading controlled from the Position, Compass, or Highway pages.

To activate the simulator:

1. Highlight 'SYSTEMSETUP' and press **ENTER**.
2. Highlight the 'MODE' field and press **ENTER**.
3. Select the simulator mode.
4. Press the **ENTER** key to confirm.
5. Press **PAGE** to return to the Menu Page.

Once the simulator mode has been activated, use the Position, Compass or Highway Page to set your speed and track. You may also enter a new position if you desire (only from the Position Page).

To enter track, speed and position:

1. Highlight the 'TRACK' field and press the **ENTER** key.
2. Enter a track heading and press **ENTER**.
3. Highlight the 'SPEED' field and press **ENTER**.
4. Enter a speed and press **ENTER**.
5. Highlight the 'POSITION' field (Position Page only) and press **ENTER**.
6. Enter a position and press the **ENTER** key.



The GPS 38 does not track satellites in simulator mode. Although you can create and save waypoints and routes while using the simulator mode, never attempt to use the simulator mode for actual navigation. The GPS 38 will always power up in the Normal mode.

SYSTEM SETUP	
MODE:	Simulator
DATE	21 DEC 95
TIME	15:36:37
OFFSET:	+00:00
HOURS:	12
CONTRAST:	████████
LIGHT:	15 sec

Select the simulator mode from the operation mode options and press ENTER. You may return to normal operation by changing the operation mode or turning the unit off.

50 165 S 195 23	
TRACK	SPEED
180°	00.0%
TRIP	ALT
0.2%	1330ft
POSITION	
18 T 0519926	
UTM 4474025	
TIME	
15:37:01	

Speed, Track & Position

Once simulator mode is selected, speed and track values may be entered on the position or navigation pages. A simulated position may also be entered on the Position Page.

Messages & Time Offsets

The GPS 38 uses a flashing on-screen message indicator to alert you to important information. Whenever the message indicator appears, press  to view the message page. There are two types of messages: temporary alerts and condition alerts. Temporary alerts are cleared from the message page after viewing, while condition alerts remain until the condition has been resolved. Pay careful attention to all messages for your own safety.

Active WPT Can't be Deleted—You have attempted to change the “active to” or “active from” waypoint. Clear the active route or GOTO before making your changes.

Accuracy has been Degraded—The accuracy of the GPS 38 has been degraded beyond 500 meters due to poor satellite geometry or data quality. You should check other navigational sources to verify the position indicated.

Already Exists—The name you are entering already exists in the GPS 38's memory.

Approaching—You are one minute away from reaching a destination waypoint.

Battery Power is Low—The batteries are low and should be replaced.

No DGPS Position—Not enough data is available to compute a DGPS position.

No RTCM Input—Beacon receiver is improperly connected or baud rates do not match.

Poor GPS Coverage—The GPS 38 cannot acquire the necessary number of satellites to compute a position. Try another location with a clearer view of the sky.

Power Down and Re-init—The GPS38 is not able to calculate a position due to abnormal satellite conditions. Turn the unit off and verify the last position shown by other means. Try the unit again later, possibly in a different location.

Read Only Mem has Failed—The permanent memory has failed and the unit is not operable. Take your unit to an authorized GARMIN dealer for repairs.

Received an Invalid WPT—A waypoint was received during upload transfer that has an invalid identifier.

Receiver has Failed—A failure in receiver hardware has been detected. If this message persists, do not use the unit and take it to an authorized dealer for repair.

Route is Full—You have attempted to add more than 30 waypoints to a route.

Route is not Empty—You have attempted to copy into a route already in use.

Route Waypoint Can't be Deleted—The waypoint you are trying to delete is part of a route. Delete the waypoint from the route before removing it from memory.

Messages & Time Offsets

Route Waypoint was Deleted—A route waypoint entered does not exist in the database and has been deleted from the route.

RTCM Input has Failed—DGPS data being received has been lost. You are no longer receiving the beacon signal.

Searching the Sky—The GPS 38 is in searching the sky for almanac data or the unit is in AutoLocate™ mode.

Stored Data was Lost—All waypoints, routes, time and almanac data has been lost due to battery failure or clearing the receiver's memory.

Transfer has been Completed—The receiver is finished uploading or downloading information to the connected device.

WPT Memory is Full—You have used all 250 waypoints in the GPS 38. Delete unwanted waypoints to make room for new entries.

Time Offset Chart

The table below gives approximate UTC time offset for various longitudinal zones. If you are in daylight savings time, add one hour to the offset.

Longitudinal Zone	Offset	Longitudinal Zone	Offset
W180.0° to W172.5°	-12	E007.5° to E022.5°	1
W172.5° to W157.5°	-11	E022.5° to E037.5°	2
W157.5° to W142.5°	-10	E037.5° to E052.5°	3
W142.5° to W127.5°	-9	E052.5° to E067.5°	4
W127.5° to W112.5°	-8	E067.5° to E082.5°	5
W112.5° to W097.5°	-7	E082.5° to E097.5°	6
W097.5° to W082.5°	-6	E097.5° to E112.5°	7
W082.5° to W067.5°	-5	E112.5° to E127.5°	8
W067.5° to W052.5°	-4	E127.5° to E142.5°	9
W052.5° to W037.5°	-3	E142.5° to E157.5°	10
W037.5° to W022.5°	-2	E157.5° to E172.5°	11
W022.5° to W007.5°	-1	E172.5° to E180.0°	12
W007.5° to E007.5°	0		

Map Datums

The following list shows the map datums available for the GPS 38. Menu Page abbreviations are listed first, followed by the corresponding map datum name and area. The default map datum for the GPS 38 is WGS 84.

Adindan	Adindan- Ethiopia, Mali, Senegal, Sudan	Easter Isld 67	Easter Island 1967
Afgooye	Afgooye- Somalia	European 1950	European 1950- Austria, Belgium, Denmark, Finland, France, Germany, Gibraltar, Greece, Italy, Luxembourg, Netherlands, Norway, Portugal, Spain, Sweden, Switzerland
AINELABD '70	AIN ELANBD 1970- Bahrain Island, Saudi Arabia	European 1979	European 1979- Austria, Finland, Netherlands, Norway, Spain, Sweden, Switzerland
Anna 1 Ast '65	Anna 1 Astro '65- Cocos Isl.	Finland Hayfrd	Finland Hayford- Finland
ARC 1950	ARC 1950- Botswana, Lesotho, Malawi, Swaziland, Zaire, Zambia, Zimbabwe	Gandajika Base	Gandajika Base- Republic of Maldives
ARC 1960	ARC 1960- Kenya, Tanzania	Geod Datm '49	Geodetic Datum '49- New Zealand
Ascnsn Isld '58	Ascension Island '58- Ascension Island	Guam 1963	Guam 1963- Guam Island
Astro B4 Sorol	Astro B4 Sorol Atoll- Tern Island	Gux 1 Astro	Gux 1 Astro- Guadalcanal Island
Astro Bcn "E"	Astro Beacon "E"- Iwo Jima	Hjorsey 1955	Hjorsey 1955- Iceland
Astro Dos 71/4	Astro Dos 71/4- St. Helena	Hong Kong '63	Hong Kong '63- Hong Kong
Astr Stn '52	Astronomic Stn '52- Marcus Island	Hu-Tzu-Shan	Hu-Tzu-Shan- Taiwan
Astrln Geod '66	Australian Geod '66- Australia, Tasmania Island	Indian Bngldsh	Indian- Bangladesh, India, Nepal
Astrln Geod '84	Australian Geod '84- Australia, Tasmania Island	Indian Thailand	Indian- Thailand, Vietnam
Bellevue (IGN)	Efate and Erromango Islands	Indonesia '74	Indonesia 1974- Indonesia
Bermuda 1957	Bermuda 1957- Bermuda Islands	Ireland 1965	Ireland 1965- Ireland
Bogata Observ	Bogata Observatry- Colombia	ISTS 073 Astro	ISTS 073 ASTRO '69- Diego Garcia
Campo Inchspe	Campo Inchauspe- Argentina	Johnston Island	Johnston Island Kandawala Kandawala- Sri Lanka
Canton Ast '66	Canton Astro 1966- Phoenix Islands	Kerguelen Islnd	Kerguelen Island
Cape	Cape- South Africa	Kertau 1948	Kertau 1948- West Malaysia, Singapore
Cape Canavrl	Cape Canaveral- Florida, Bahama Islands	L. C. 5 Astro	Cayman Brac Island
Carthage	Carthage- Tunisia	Liberia 1964	Liberia 1964- Liberia
CH-1903	CH 1903- Switzerland	Luzon Mindanao	Luzon- Mindanao Island
Chatham 1971	Chatham 1971- Chatham Island (New Zealand)	Luzon Philippine	Luzon- Philippines (excluding Mindanao Island)
Chua Astro	Chua Astro- Paraguay	Mahe 1971	Mahe 1971- Mahe Island
Corrego Alegre	Corrego Alegre- Brazil	Marco Astro	Marco Astro- Salvage Island
Djakarta	Djakarta (Batavia)- Sumatra Island (Indonesia)		
Dos 1968	Dos 1968- Gizo Island (New Georgia Islands)		

Map Datums

Massawa	Massawa- Eritrea (Ethiopia)		
Merchich	Merchich- Morocco		
Midway Ast '61	Midway Astro '61- Midway		
Minna	Minna- Nigeria		
NAD27 Alaska	North American 1927- Alaska		
NAD27 Bahamas	North American 1927- Bahamas (excluding San Salvador Island)		
NAD27 Canada	North American 1927- Canada and Newfoundland		
NAD27 Canal Zone	North Am. 1927- Canal Zone		
NAD27 Caribbn	North American 1927- Caribbean (Barbados, Caicos Islands, Cuba, Dom. Rep., Grand Cayman, Jamaica, Leeward and Turks Islands)	Prov S Chln '63	Prov So Chilean '63- S. Chile
		Puerto Rico	Puerto Rico & Virgin Islands
		Qatar National	Qatar National- Qatar
		Qornoq	Qornoq- South Greenland
NAD27 Central	North American 1927- Central America (Belize, Costa Rica, El Salvador, Guatemala, Honduras, Nicaragua)	Reunion	Reunion- Mascarene Island
		Rome 1940	Rome 1940- Sardinia Island
NAD27 CONUS	North Am. 1927- Mean Value	RT 90	Sweden
NAD27 Cuba	North American 1927- Cuba	Santo (Dos)	Santo (Dos)- Espirito Santo Island
NAD27 Grnland	North American 1927- Greenland (Hayes Peninsula)	Sao Braz	Sao Braz- Sao Miguel, Santa Maria Islands (Azores)
NAD27 Mexico	N. American 1927- Mexico	Sapper Hill '43	Sapper Hill 1943- East Falkland Island
NAD27 San Sal	North American 1927- San Salvador Island	Schwarzeck	Schwarzeck- Namibia
NAD83	North American 1983- Alaska, Canada, Central America, CONUS, Mexico	5th Amrcn '69	South American '69- Argentina, Bolivia, Brazil, Chile, Colombia, Ecuador, Guyana, Paraguay, Peru, Venezuela, Trinidad and Tobago
Nhrwn Masirah	Nahrwn- Masirah Island (Oman)	South Asia	South Asia- Singapore
Nhrwn Saudi A	Nahrwn- Saudi Arabia	SE Base	Southeast Base- Porto Santo and Madiera Islands
Nhrwn United A	Nahrwn- United Arab Emirates	SW Base	Southwest Base- Faial, Graciosa, Pico, Sao Jorge and Terceira Islands (Azores)
Naparima BWI	Naparima BWI- Trinidad and Tobago	Timbalai 1948	Timbalai 1948- Brunei and E. Malaysia (Sarawak and Sabah)
Obsrvtorio '66	Observatorio 1966- Corvo and Flores Islands (Azores)	Tokyo	Tokyo- Japan, Korea, Okinawa
Old Egyptian	Old Egyptian- Egypt	Tristan Ast '68	Tristan Astro 1968- Tristan da Cunha
Old Hawaiian	Old Hawaiian- Mean Value	Viti Levu 1916	Viti Levu 1916- Viti Levu/ Fiji Islands
Oman	Oman- Oman	Wake-Eniwetok	Wake-Eniwetok- Marshall Isl.
Ord Srvy GB	Old Survey Grt Britn- England, Isle of Man, Scotland, Shetland Isl., Wales	WGS 72	World Geodetic System 1972
Pico De Las Nv	Canary Islands	WGS 84	World Geodetic System 1984
Pitcairn Ast '67	Pitcairn Astro '67- Pitcairn Isl.	Zanderij	Zanderij- Surinam
Prov S Am '56	Prov So Amrcn '56- Bolivia, Chile, Colombia, Ecuador, Guyana, Peru, Venezuela		

Specifications & Wiring

The GPS 38 is constructed of high quality materials and should not require user maintenance. Should your unit ever need repair, please take it to an authorized GARMIN service center. The GPS 38 has no user-serviceable parts. Never attempt any repairs yourself. To protect your GPS, keep it covered or in a carrying case (optional) when not in use, and never allow gasoline or other solvents to come into contact with the case. Clean the case and lens with a soft cloth and a household window cleaner.

PHYSICAL

Case:	waterproof*
Size:	6.15"H x 2"W x 1.23"D (15.6 x 5.1 x 1.23 cm)
Weight:	Approx 9.5 ounces (269g) w/ batteries
Temperature Range:	5° to 158°F (-15° to 70°C)

PERFORMANCE

Receiver:	Differential-ready MultiTrac8™
Acquisition Time:	Approx. 20 seconds (warm start) Approx. 2 minutes (cold start) Approx. 7.5 minutes (AutoLocate™)
Update Rate:	1/second, continuous
Position Accuracy:	5-10 meters (16-33 ft.) with DGPS corrections** 15 meters (49 ft.) RMS***
Velocity Accuracy:	0.1 knot RMS steady state (93 knots/103 mph max.)
Dynamics:	Performs to specification to 3g's

POWER

Input:	Four 1.5 volt AA batteries or 5-8 vDC
Power:	.75 watts
Battery Life:	Up to 12 hours (normal mode)
(w/ alk. batt.)	Up to 20 hours (battery saver mode)

NOTE: Alkaline batteries lose a significant amount of their capacity as temperature decreases. If you're using the GPS 38 in below freezing temperatures, use lithium batteries for longer battery life. Extensive use of screen backlighting will significantly reduce battery life.

Specifications subject to change without notice.

* Meets IEC (European Community Specification) 529 IPX7 for protection against immersion for 30 minutes at a depth of 1 meter.

** With optional GARMINGBR 21 Beacon Receiver Input.

*** Subject to accuracy degradation to 100m 2DRMS under the US DOD-imposed Selective Availability Program.

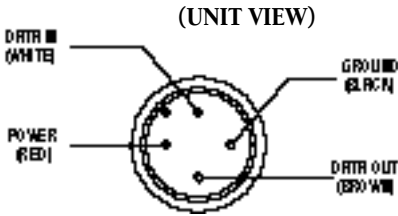

Three optional cables are available to connect the GPS 38 to an external power source or interface with another unit or PC:

- Cigarette Lighter Adapter (Part No. 010-10084-00) — Allows connection to a 12 volt DC cigarette lighter plug.
- Data Transfer Cable (Part No. 010-10142-00) — Allows data transfer between GARMIN GPS units. The GPS 38 is compatible with the following units: GPS 38/40/45/45XL, GPS II/II Plus and GPS12XL units. Information that can be transferred includes the almanac, waypoints, routes, and tracklog. Some units (ex: GPS II Plus) contain waypoint symbols. The GPS 38 does not. Waypoint symbols can only be transferred from and to units supporting waypoint symbols.
- PC Interface Cable (Part No. 010 10141-00) — PC interface cable with 9-pin 'D' serial data connector.

The following interface formats are supported by the GPS 38 for driving three NMEA devices:

NMEA 0180 NMEA 0182

NMEA 0183 version 1.5

Approved sentences:

GPBWC, GPGLL, GPRMB,
GPRMC, GPXTE, GPVTG,
GPWPL, GPBOD

Proprietary sentences:

PGRMM (map datum),
PGRMZ (altitude), PSLIB
(beacon rec. control)

NMEA 0183 version 2.0

Approved sentences:

GPGGA, GPGLL, GPGSA,
GPGSV, GPRMB, GPRMC,
GPRTE, GPWPL, GPBOD

Proprietary sentences:

PGRME (estimated error),
PGRMM (map datum),
PGRMZ (altitude), PSLIB
(beacon receiver control)

DGPS corrections are accepted on RTCM-104 v. 2.0 format. The GARMINGBR 21 is the recommended beacon receiver for use with the GPS 38. Other receivers with the correct RTCM format may be used, but may not correctly display status or allow tuning control from the GPS 38.

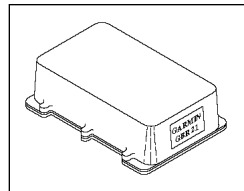

Index

2D Navigation	18
3D Navigation	18

A

Acquiring Satellites	6
Activating and Inverting Routes	34
Active Route Page	35
Almanac Data (defined)	2
Altitude Display	20
AutoLocate (defined)	2

B

Backlight	19,46
Battery Installation	4
Battery Level Indicator	19
Battery Saver Mode	45
Bearing (defined)	2

C

Cancelling A GOTO	28
CDI scale	14
CDIScale Settings	47
Caution Statement	ii
Clearing a Cluttered Map Display	16
CMG (defined)	2
Compass Page	13
Copying and Clearing Routes	33
Creating A Route	32

D

DGPS Interface	51
Date and Time Setup	45
Deleting Routes	33
Differential GPS (DGPS) (defined)	2
Displaying Items on the Map Page	49
Distance and Sun Calculation	44
DTK (defined)	2

E

EZinit	7
Editing Existing Waypoints	26
Editing Routes	35
ETA (defined)	2
ETE (defined)	2

G

Getting Started Tour	9
Glossary	2
Going To A Waypoint	28
Grid (defined)	2
Ground Speed (defined)	2

H

Highway Page	37
--------------	----

I

Index	60
Initialization	5
Initialization Troubleshooting	8
Interface Setup	51

K

Keypad Usage & Data Entry	3
---------------------------	---

L

Latitude (defined)	2
Longitude (defined)	2

M

Magnetic Heading Reference	48
Man Overboard Function	28
Managing/Clearing the Track Log	50

Index

- Map Datums47, 56
 Map Page12
 Map Setup and Orientation48
 Mark /GOTO Wyppts with Cursor . . .43
 Marking And Saving Waypoints . . .21
 Marking a Position11
 Menu Page15
 Messages54
- N**
- Navigation (defined)2
 Navigation Pages37
 Navigation Setup47
 Navigation Simulator53
 Nearest Waypoints Page22
 Normal Mode45
- O**
- On-Route GOTOs36
 Optional cables59
- P**
- Packing Listi
 Pointing at On-Screen Waypoints .42
 Position Formats47
 Position Page10
 Power/Data Cable59
 Power On9
 Power Off16
 Primary Pages15
- R**
- Range Rings40
 Reference Waypoints25
 Removing Waypoints from Routes .36
 Renaming & Deleting Waypoints . .26
 Routes
 Active Route Page35
 Activating and Inverting34
 Clearing33
 Copying33
 Creating32
 Editing35
- Routes (continutd)
 On-Route GOTOs36
 Removing Waypoints From . . .36
 Route Navigation31
- S**
- Satellite Page6
 Scanning Waypoints27
 Screen Backlighting19, 46
 Screen Contrast46
 Skyview Display16
 Specifications & Wiring58
 Starting/Stopping a GOTO28
- T**
- Table of Contents1
 Time Format46
 Time Offsets54
 TracBack Navigation29
 Track Criteria50
 Track Log Display49
 Track Log Setup49
 Trip Odometer20
 TRK (defined)2
 Types of Messages54
- U**
- Units of Measure48
 UTM (defined)2
- V**
- VMG (defined)2

*Index***W**

Warranty	63
Waypoints	
Waypoint (defined)	2
Waypoint Comments	26
Waypoint Definition Page	24
Waypoint List Page	23
Waypoint Submenus	22
Editing	26
Going To A Waypoint	28
Mark and GOTO with Cursor	43
Marking And Saving	21
Nearest Waypoints Page	22
Pointing at On-Screen	42
Reference Waypoints	25
Removing from a Route	36
Renaming & Deleting	26
Scanning	27
Wrist Strap Attachment	4

X

XTE (defined)	2
-------------------------	---

Z

Zooming and Panning	41
-------------------------------	----

WARRANTY

GARMIN warrants this product to be free from defects in materials and workmanship for one year from the date of purchase. GARMIN will at its sole option, repair or replace any components which fail in normal use. Such repairs or replacement will be made at no charge to the customer for parts or labor. The customer is, however, responsible for any transportation costs. This warranty does not cover failures due to abuse, misuse, accident, or unauthorized alteration or repairs. GARMIN assumes no responsibility for special, incidental, punitive, or consequential damages, or loss of use.

The warranties and remedies contained herein are exclusive, and in lieu of all other warranties expressed or implied, including any liability arising under warranty of merchantability or fitness for a particular purpose, statutory or otherwise. This warranty gives you specific legal rights, which may vary from state to state.

To obtain warranty service, call the GARMIN Customer Service department (913-397-8200) for a returned merchandise tracking number. The unit should be securely packaged with the tracking number clearly marked on the outside of the package, and sent freight prepaid and insured to a GARMIN warranty service station. A copy of the original sales receipt is required as the proof of purchase for warranty repairs. GARMIN retains the exclusive right to repair or replace the unit or software at its sole discretion.



© 1997 GARMIN Corporation

1200 E. 151st Street, Olathe, KS USA 66062

GARMIN (Europe) Ltd. Unit 5, The Quadrangle
Abbey Park, Romsey, UK SO51 9AQ

Part Number 190-00112-00 Rev. B Printed in Taiwan