

**GARMIN**<sup>®</sup>

# GPSMAP<sup>®</sup> 700 series owner's manual



All rights reserved. Except as expressly provided herein, no part of this manual may be reproduced, copied, transmitted, disseminated, downloaded or stored in any storage medium, for any purpose without the express prior written consent of Garmin. Garmin hereby grants permission to download a single copy of this manual onto a hard drive or other electronic storage medium to be viewed and to print one copy of this manual or of any revision hereto, provided that such electronic or printed copy of this manual must contain the complete text of this copyright notice and provided further that any unauthorized commercial distribution of this manual or any revision hereto is strictly prohibited.

Information in this document is subject to change without notice. Garmin reserves the right to change or improve its products and to make changes in the content without obligation to notify any person or organization of such changes or improvements. Visit the Garmin Web site ([www.garmin.com](http://www.garmin.com)) for current updates and supplemental information concerning the use and operation of this and other Garmin products.

Garmin®, the Garmin logo, GPSMAP®, BlueChart®, g2 Vision®, and MapSource® are trademarks of Garmin Ltd. or its subsidiaries, registered in the USA and other countries. GFS™, GHP™, GMR™, GSD™, HomePort™, and UltraScroll™ are trademarks of Garmin Ltd. or its subsidiaries. These trademarks may not be used without the express permission of Garmin. NMEA 2000® and the NMEA 2000 logo are registered trademarks of the National Maritime Electronics Association. Windows® is a registered trademark of Microsoft Corporation in the United States and other countries. XM® and XM WX Satellite Weather® are registered trademarks of XM Satellite Radio Inc.

# Introduction



## **WARNING**

See the *Important Safety and Product Information* guide in the product box for product warnings and other important information.

This manual includes information for the following products:

- GPSMAP® 720/720s
- GPSMAP 740/740s
- GPSMAP 750/750s

## Tips and Shortcuts

- Select **Home** from any screen to return to the Home screen.
- Select **Menu** from any main screen to access additional settings.
- Press and release  to adjust the Backlight and Color Mode settings.
- Press and hold  to turn the chartplotter on or off.

## Manual Conventions

In this manual, when you are instructed to select an item, use your finger to touch that item on the screen to select it. Small arrows (>) in the text indicate that you should select each item in order. For example, if you see “select **Charts** > **Navigation Chart**,” you should touch **Charts** and then touch **Navigation Chart**.

## Table of Contents

<b>Introduction</b> .....	<b>i</b>	Simulator Mode .....	44
Tips and Shortcuts.....	i	Turning the Chartplotter On Automatically.....	44
Manual Conventions.....	i	Display Configuration .....	45
<b>Getting Started</b> .....	<b>1</b>	Navigation Preferences .....	45
Front and Back Panels .....	1	Information about Your Boat.....	50
Turning On the Chartplotter.....	1	Alarms .....	51
Turning Off the Chartplotter.....	1	Chartplotter Data Management.....	52
Initial Chartplotter Settings .....	2	<b>Radar</b> .....	<b>54</b>
GPS Satellite Signal Acquisition.....	2	Transmitting Radar Signals .....	54
Adjusting the Backlight.....	2	Adjusting the Zoom Scale on the Radar Screen.....	54
Adjusting the Color Mode.....	2	Radar Display Modes .....	55
Inserting and Removing Data and Memory Cards .....	2	Waypoints and Routes on the Radar Screen ..	60
Viewing System Information.....	3	About the Radar Overlay.....	61
About the Home Screen .....	3	Optimizing the Radar Display.....	62
<b>Charts and 3D Chart Views</b> .....	<b>4</b>	Radar Display Appearance.....	66
Navigation Chart.....	4	Radar Overlay Display Appearance .....	69
Automatic Identification System .....	12	<b>Sonar</b> .....	<b>71</b>
Perspective 3D .....	15	Sonar Views .....	71
BlueChart g2 Vision.....	16	Depth Log.....	73
Mariner's Eye 3D.....	17	Transducer Temperature Log .....	73
Fish Eye 3D.....	18	Waypoints on the Sonar Screen.....	74
Fishing Chart.....	19	Sonar Display Appearance.....	74
Showing Satellite Imagery on the Navigation Chart .....	19	Sonar Alarms.....	77
Viewing Aerial Photos of Landmarks .....	20	Transducer Configuration.....	78
Animated Tide and Current Indicators.....	21	<b>Digital Selective Calling</b> .....	<b>79</b>
Detailed Road and Point of Interest Data.....	21	Chartplotter and VHF Radio Functionality.....	79
Auto Guidance.....	21	Turning On DSC.....	79
<b>Combinations</b> .....	<b>22</b>	About the DSC List.....	79
About the Combination Screen.....	22	Incoming Distress Calls.....	80
Combination Screen Configuration.....	22	Man-Overboard Distress Calls Initiated from a VHF Radio .....	80
<b>Navigation</b> .....	<b>25</b>	Man-Overboard Distress Calls Initiated from the Chartplotter .....	80
Basic Navigation Questions.....	25	Position Tracking .....	81
Navigation with a Chartplotter .....	25	Individual Routine Calls.....	83
Waypoints.....	26	Making an Individual Routine Call to an AIS Target .....	83
Routes .....	28	<b>Appendix</b> .....	<b>84</b>
Tracks.....	30	Specifications .....	84
Navigating with a Garmin Autopilot.....	32	Calibrating the Touchscreen.....	84
<b>Where To?</b> .....	<b>33</b>	Screenshots.....	85
Marine Services Destinations.....	33	Viewing GPS Satellite Locations .....	85
<b>Almanac, On-boat, and Environmental Data</b> .....	<b>36</b>	Using WAAS/EGNOS.....	85
Almanac Data.....	36	System Information.....	85
On-boat Data.....	38	NMEA 0183 and NMEA 2000 .....	86
Environmental Data.....	41	Registering Your Device .....	89
<b>Device Configuration</b> .....	<b>44</b>	Contacting Garmin Product Support.....	89
Basic Device Configuration Questions .....	44	Declaration of Conformity.....	89
		Software License Agreement.....	89
		<b>Index</b> .....	<b>90</b>

## Getting Started

### Front and Back Panels



GPSMAP 700 Series Front View

①	Power key
②	Automatic backlight sensor
③	SD card slot



GPSMAP 700 Series Back View

①	NMEA 2000 connector
②	Power/data connector
③	Radar Port
④	External GPS antenna connector

### Turning On the Chartplotter

Press and release .



### Turning Off the Chartplotter

Press and hold .

## Initial Chartplotter Settings

The first time you turn on the chartplotter, you must configure a series of initial settings. You must also configure these settings when restoring original factory settings (page 86). You can update each of these settings later. Follow the on-screen directions to configure the initial settings.

## GPS Satellite Signal Acquisition

When you turn on the chartplotter, the GPS receiver must collect satellite data and establish the current location. When the chartplotter acquires satellite signals, the signal strength bars at the top of the Home screen are green . When the chartplotter loses satellite signals, the green bars disappear  and a flashing question mark appears on the vehicle (boat) icon on the chart screen.

For more information about GPS, go to [www.garmin.com/aboutGPS](http://www.garmin.com/aboutGPS).

## Adjusting the Backlight

1. From the Home screen, select **Configure > System > Beeper/Display > Display**.

**TIP:** Press and release  from any screen to open the display screen.

2. Adjust the backlight:

- Select **Backlight > Auto** to allow the chartplotter to adjust the backlight automatically, based on ambient light.
- Use the slider bar to manually adjust the backlight.

Select **Backlight** to switch between Auto and Manual mode.

## Adjusting the Color Mode

1. From the Home screen, select **Configure > System > Beeper/Display > Display**.

**TIP:** Press and release  from any screen to open the Display screen.

2. Select **Color Mode**.

3. Select **Day Colors**, **Night Colors**, or **Auto**.

The Auto setting automatically changes the color scheme based on sunrise and sunset times.

## Inserting and Removing Data and Memory Cards

You can insert optional BlueChart® g2 Vision® data cards to view high-resolution satellite imagery and aerial reference photos of ports, harbors, marinas, and other points of interest. You can insert blank SD memory cards to transfer data such as waypoints, routes, and tracks to another compatible Garmin chartplotter or a computer (page 52). The SD card slot is located on the front of the chartplotter.

- Open the access door, insert the data card or the memory card (with the label ① facing right) into the slot, and press the card until it clicks.
- Press the data card or the memory card into the slot again and release it to eject the card.

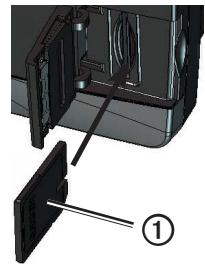

## Viewing System Information

You can view the software version, the basemap version, any supplemental map information (if applicable), the software version for an optional Garmin radar (if applicable), and the unit ID number. You may need this information to update the system software or to purchase additional map data information.

From the Home screen, select **Configure > System > System Information**.

## About the Home Screen

You can use the Home screen to access all other screens.

**NOTE:** Options on this screen vary based on the chartplotter type and optional connected devices.



- **Charts**—allows you to access the Navigation Chart, Perspective 3D, Mariner’s Eye 3D, Fish Eye 3D, the Fishing chart, and Radar Overlay.  
**NOTE:** Mariner’s Eye 3D and Fish Eye 3D chart views are available only if you use a BlueChart g2 Vision SD card ([page 16](#)). The Fishing chart is available if you use a BlueChart g2 Vision SD card or a BlueChart g2 SD card, or if your built-in map supports Fishing charts.
- **Sonar**—sets up and provides sonar information (only available with an “S” series unit, such as a GPSMAP 720s) ([page 71](#)).
- **Combinations**—sets up a split screen displaying chart/chart, chart/sonar, chart/radar, sonar/radar, or sonar/temperature log ([page 22](#)).
- **Information**—shows information including tides, currents, celestial data, user data, information about other boats, and gauges ([page 36](#)).
- **Mark**—marks, edits, or deletes your present location as a waypoint or a man overboard location ([page 27](#)).
- **Where To?**—provides navigation features ([page 33](#)).
- **Radar**—sets up and shows radar (only available if the chartplotter is connected to a Garmin marine radar) ([page 54](#)).
- **Weather**—(North America only) sets up and shows various weather parameters, including precipitation, forecast, fishing, sea conditions, and visibility (available only if the chartplotter is connected to a weather module and you have an XM® subscription). See the *GPSMAP 700 Series Weather® and XM Satellite Radio Supplement* (North America only).
- **Configure**—allows you to view and edit the settings for your chartplotter and system ([page 44](#)).
- **Man Overboard**—marks your present location as a waypoint, and sets a course back to the marked location ([page 27](#)).

## Charts and 3D Chart Views

The GPSMAP 700 series chartplotters have a basic imagery map. The charts and 3D chart views listed below are available on the chartplotter.

**NOTE:** Mariner’s Eye 3D and Fish Eye 3D chart views are available only if you use a BlueChart g2 Vision SD card (page 16). The Fishing chart is available if you use a BlueChart g2 Vision SD card or a BlueChart g2 SD card, or if your built-in map supports Fishing charts.

- **Navigation Chart**—shows navigation data available on your pre-loaded maps and from supplemental maps, if available. The data includes buoys, lights, cables, depth soundings, marinas, and tide stations in an overhead view (page 4).
- **Perspective 3D**—shows a view from above and behind your boat for a visual navigation aid (page 15).
- **Mariner’s Eye 3D**—shows a detailed, three-dimensional view from above and behind the boat for a visual navigation aid (page 17).
- **Fish Eye 3D**—provides an underwater view that visually represents the sea floor according to the chart information (page 18).
- **Fishing Chart**—removes navigational data from the chart and enhances bottom contours for depth recognition (page 19).
- **Radar Overlay**—superimposes radar information on the Navigation chart or the Fishing chart (page 61).

### Navigation Chart

Use the Navigation chart to plan your course, to view map information, and as a navigational aid.

From the Home screen, select **Charts > Navigation Chart**.

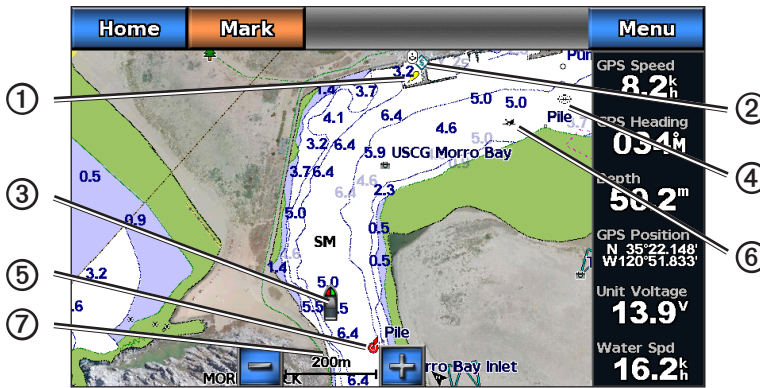

**Navigation Chart with BlueChart g2 Vision Data**

①	Light	②	Marina services
③	Your boat	④	Submerged wreck
⑤	Buoy	⑥	Exposed wreck
⑦	Zoom scale		

### Zooming In and Out on the Map

The zoom level is indicated by the scale number at the bottom of the Navigation chart (200m). The bar under the scale number represents that distance on the map.

Select  and  to zoom out and zoom in.







### Changing from One Chart to a Different Chart

1. From a chart or a 3D chart view, select **Menu > Change Chart**.
2. Select a different chart.



## Chart Symbols

BlueChart g2 and BlueChart g2 Vision charts use graphic symbols to denote map features, which follow the standards for US and international charts. Some other common symbols you might see include, but are not limited to, those shown below.

Icon	Description	Icon	Description	Icon	Description
	Current station		Marine services		Overhead photo available
	Information		Tide station		Perspective photo available

Other features common to most charts include depth contour lines (with deep water represented in white), intertidal zones, spot soundings (as depicted on the original paper chart), navigational aids and symbols, obstructions, and cable areas.

## Navigating to a Point on the Chart

### CAUTION

The Auto Guidance feature of the BlueChart g2 Vision data card is based on electronic chart information. That data does not ensure obstacle and bottom clearance. Carefully compare the course to all visual sightings and avoid any land, shallow water, or other obstacles that may be in your path.

When using Go To, a direct course and a corrected course may pass over land or shallow water. Use visual sightings and steer to avoid land, shallow water, and other dangerous objects.

**NOTE:** The Fishing chart is available if you use a BlueChart g2 Vision SD card or a BlueChart g2 SD card, or if your built-in map supports Fishing charts.

1. From the Home screen, select **Charts**.
2. Select **Navigation Chart** or **Fishing Chart**.
3. Touch the chart to select the location using the cursor .
4. Select **Navigate To**.
5. Complete an action:
  - Select **Go To** to navigate directly to the location.
  - Select **Route To** to create a route to the location, including turns ([page 28](#)).
  - Select **Guide To** to use Auto Guidance ([page 21](#)).
6. Review the course indicated by the magenta line.

**NOTE:** When using Auto Guidance, a gray segment within any part of the magenta line indicates that Auto Guidance cannot calculate part of the Auto Guidance line. This is due to the settings for minimum safe water depth and minimum safe obstacle height ([page 46](#)).

7. Follow the magenta line, steering to avoid land, shallow water, and other obstacles.

## Panning the Navigation Chart, Fishing Chart, or Radar Overlay

You can pan away from your present location and to other areas on the Navigation chart, the Fishing chart, or the Radar Overlay.

**NOTE:** The Fishing chart is available if you use a BlueChart g2 Vision SD card or a BlueChart g2 SD card, or if your built-in map supports Fishing charts. The radar overlay is available when connected to a compatible radar.

1. From the Home screen, select **Charts**.
2. Select **Navigation Chart**, **Fishing Chart**, or **Radar Overlay**.
3. Touch and drag the Navigation screen to pan the map.
 

When you pan past the edge of the map, the screen scrolls forward to provide continuous map coverage.
4. Select **Stop Panning** to stop panning and return the screen to your present location.

## Configuring the Appearance of Waypoint Symbols

1. From the Home screen, select **Charts**.
2. Select **Navigation Chart** or **Fishing Chart**.
3. Select **Menu > Waypoints & Tracks > Waypoint Display**.
4. Select a waypoint symbol.
5. Complete an action:
  - Select **Label** to display the name and symbol.
  - Select **Symbol Only** to display only the symbol.
  - Select **Comment** to display any comments you have added ([page 27](#)).
  - Select **Hide** to hide the symbol.

## Setting the Color of the Active Track

See ([page 31](#)).

## Showing or Hiding Colored Tracks

You can specify the color of tracks ([page 31](#)) and then show or hide all tracks of that color.

1. From the Home screen, select **Charts**.
2. Select **Navigation Chart** or **Fishing Chart**.
3. Select **Menu > Waypoints & Tracks > Tracks Display**.
4. Select a color to show or hide all tracks of that color.

## Viewing Location and Object Information on a Chart

You can view information about a location or an object on the Navigation chart or the Fishing chart.

1. From the Home screen, select **Charts**.
2. Select **Navigation Chart** or **Fishing Chart**.
3. Touch a location or an object.  
A list of options appears along the right side of the chart. The options that appear vary based on the location or object you selected.
4. Complete an action:
  - Select **Review** to view details of objects in the vicinity of the cursor. (**Review** does not appear if the cursor is not near an object. If the cursor is near only one object, the name of the object appears.)
  - Select **Navigate To** to navigate to the selected location ([page 5](#)).
  - Select **Create Waypoint** to mark a waypoint at the cursor location.
  - Select **Measure Distance** to view the distance and bearing of the object from your present location. The information appears in the upper-left corner of the screen. Select **Set Reference** to measure from the selected location, rather than your present location.
  - Select **Information** to view tide ([page 36](#)), current ([page 37](#)), celestial ([page 38](#)), chart notes, or local services information near the cursor.
  - Select **Stop Pointing** to remove the pointer from the screen. Select **Stop Panning** to stop panning and return the screen to your present location.

## Viewing Additional Object Information

You can view information about on-screen map items, waypoints, and charts.

**NOTE:** Mariner's Eye 3D and Fish Eye 3D chart views are available only if you use a BlueChart g2 Vision SD card ([page 16](#)). The Fishing chart is available if you use a BlueChart g2 Vision SD card or a BlueChart g2 SD card, or if your built-in map supports Fishing charts.

1. From the Home screen, select **Charts**.
2. Select a chart or a 3D chart view.

3. Touch an object ①.
4. Select the button with the name of the item ② to view the information.

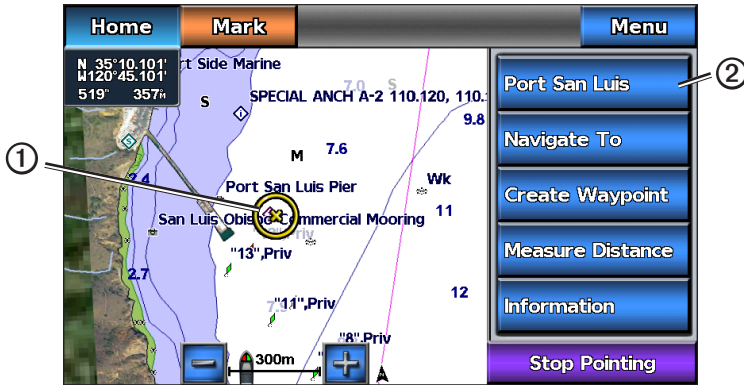

### Viewing Tide Station Information

Tide-station information appears on the chart with a tide station icon (◆). You can view a detailed graph for a tide station to help predict the tide level at different times or on different days (page 36).

**NOTE:** Tide station icons are available only if you use a BlueChart g2 Vision SD card (page 16). The Fishing chart is available if you use a BlueChart g2 Vision SD card or a BlueChart g2 SD card, or if your built-in map supports Fishing charts.

1. From the Home screen, select **Charts**.
2. Select **Navigation Chart** or **Fishing Chart**.
3. Select a tide station icon (◆).  
Tide direction ① and tide level information ② appear near the icon.
4. Complete an action:
  - Select the button with the station name ③.
  - Select **Review** if more than one item is in the vicinity, and select the button with the station name.

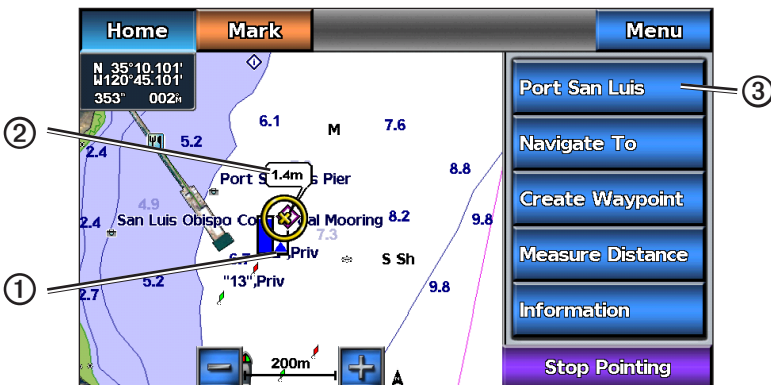

## Showing and Configuring Tides and Currents

You can show and configure tide and current information on the Navigation chart or the Fishing chart.

1. From the Home screen, select **Charts**.
2. Select **Navigation Chart** or **Fishing Chart**.
3. Select **Menu**.
4. Select **Navigation Chart Setup** or **Fishing Chart Setup**.
5. Select **Tides/Currents**.
6. Complete an action:
  - Select **On** to show current station indicators and tide station indicators on the chart, or select **Off** to hide current station indicators and tide station indicators.
  - Select **Animated** to show animated tide station indicators and animated current direction indicators on the chart ([page 21](#)).

## Viewing Details about Nav aids

From the Navigation chart, the Fishing chart, Perspective 3D, or Mariner's Eye 3D, you can view details about various types of navigation aids, including beacons, lights, and obstructions. See ([page 10](#)) to configure the appearance of navaid symbols.

**NOTE:** The Mariner's Eye 3D chart view is available only if you use a BlueChart g2 Vision SD card ([page 16](#)). The Fishing chart is available if you use a BlueChart g2 Vision SD card or a BlueChart g2 SD card, or if your built-in map supports Fishing charts.

1. From the Home screen, select **Charts**.
2. Select **Navigation Chart**, **Fishing Chart**, **Perspective 3D**, or **Mariner's Eye 3D**.
3. Select a navaid with the cursor .
 

An option describing the navaid appears, such as **Beacon** or **Light**.
4. Select the name of the navaid (or **Review** and then the name of the navaid) or to view details about the navaid.

## Navigation Chart Appearance

### Changing the Map Orientation

You can set the perspective of the map in the Navigation chart or the Fishing chart.

1. From the Home screen, select **Charts**.
2. Select **Navigation Chart** or **Fishing Chart**.
3. Select **Menu**.
4. Select **Navigation Chart Setup** or **Fishing Chart Setup**.
5. Select **Chart Appearance > Orientation**.
6. Complete an action:
  - Select **North Up** to set the top of the map to a north heading.
  - Select **Head Up** to set the top of the map according to the heading data received from a heading sensor (also known as magnetic heading) or to use GPS heading data. The heading line appears vertically on the screen.
  - Select **Course Up** to set the map so the direction of navigation is always up.

### Changing the Map Zoom Detail

You can adjust the amount of detail shown on the map, at different zoom levels, for the Navigation Chart or the Fishing chart.

1. From the Home screen, select **Charts**.
2. Select **Navigation Chart** or **Fishing Chart**.
3. Select **Menu**.
4. Select **Navigation Chart Setup** or **Fishing Chart Setup**.

5. Select **Chart Appearance > Detail**.
6. Use the slider bar to select a level of detail.

### Selecting a World Map

You can use either a basic world map or a shaded relief map on the Navigation chart or the Fishing chart. These differences are visible only when zoomed out too far to see the detailed charts.

**NOTE:** Shaded relief maps are available if you use a BlueChart g2 Vision SD card. The Fishing chart is available if you use a BlueChart g2 Vision SD card or a BlueChart g2 SD card, or if your built-in map supports Fishing charts. The basic world map is available on all GPSMAP 700 series chartplotters.

1. From the Home screen, select **Charts**.
2. Select **Navigation Chart** or **Fishing Chart**.
3. Select **Menu**.
4. Select **Navigation Chart Setup** or **Fishing Chart Setup**.
5. Select **Chart Appearance**.
6. Complete an action:
  - Select **World Map > Full** to show shaded relief on the chart.
  - Select **World Map > Basic** to show basic map data on the chart.

### Showing and Configuring the Heading Line

The heading line is an extension drawn on the map from the bow of the boat in the direction of travel. You can configure the appearance of the heading line for the Navigation chart or the Fishing chart.

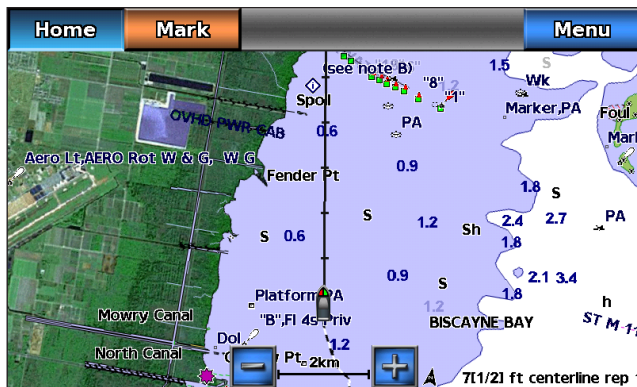

**Heading Line**

1. From the Home screen, select **Charts**.
2. Select **Navigation Chart** or **Fishing Chart**.
3. Select **Menu**.
4. Select **Navigation Chart Setup** or **Fishing Chart Setup**.
5. Select **Chart Appearance > Heading Line > Display**.
6. Complete an action:
  - Select **Distance > Change Distance**, enter the distance to the end of the heading line, and select **Done**.
  - Select **Time > Change Time**, enter the amount of time until you reach the end of the heading line, and select **Done**.

### Selecting the Heading Line Source

The source for the display of the heading line on the chartplotter is determined by the heading line source setting (**Auto** or **GPS Hdg**) and whether heading information is available from a heading sensor.

- If heading information is available from a heading sensor and the source heading is set to **Auto**, both the heading line and the vehicle icon will be aligned to the heading from the sensor.
- If heading information is available from a heading sensor and the source heading is set to **GPS Hdg**, the heading line will be aligned to the GPS heading, but the vehicle icon will be aligned to the heading from the sensor.
- If heading information is not available from a heading sensor, both the heading line and the vehicle icon will be aligned to the GPS heading.

1. From the Home screen, select **Charts**.
2. Select **Navigation Chart** or **Fishing Chart**.
3. Select **Menu**.
4. Select **Navigation Chart Setup** or **Fishing Chart Setup**.
5. Select **Chart Appearance > Heading Line > Source**.
6. Complete an action:
  - Select **GPS Hdg**.
  - Select **Auto**.

### Showing and Configuring Spot Depth Soundings

On the Navigation Chart, you can turn on spot soundings and set a dangerous depth. Spot depths that are equal to, or more shallow than, the dangerous depth will be indicated by red text.

1. From the Home screen, select **Charts > Navigation Chart > Menu > Navigation Chart Setup > Chart Appearance > Spot Depths > On**.
2. Select **Spot Depths > Dangerous**.
3. Enter the dangerous depth.
4. Select **Done**.

### Configuring Depth Shading

You can customize the appearance of depth shading on the Navigation chart.

**NOTE:** Depth shading is available with a preprogrammed BlueChart g2 Vision data card.

1. From the Home screen, select **Charts > Navigation Chart > Menu > Navigation Chart Setup > Chart Appearance > Safety Shading**.
2. Complete an action:
  - Enter the depth and select **Done**. Areas on the chart with depths shallower than the specified value are shaded in blue, while areas with depths greater than the specified value are shaded in white. The contour is always drawn at, or deeper than, the selected depth.
  - Select **Auto** to use the depth from the g2 Vision chart.

### Showing and Configuring Navaid Symbols

You can show and configure the appearance of navaid symbols on the Navigation chart or the Fishing chart.

1. From the Home screen, select **Charts**.
2. Select **Navigation Chart** or **Fishing Chart**.
3. Select **Menu**.
4. Select **Navigation Chart Setup** or **Fishing Chart Setup**.
5. Select **Chart Appearance > Symbols**.

6. Complete an action:

- Select **Navaid Size** to set the size of the navaid symbols shown on the map, and select a size.
- Select **Navaid Type > NOAA** to show the NOAA navaid symbol set on the map.
- Select **Navaid Type > IALA** to show the International Association of Lighthouse Authorities (IALA) navaid symbol set on the map.

### Showing Additional Chart Details

You can show land POIs, light sectors, and photo points on the Navigation chart.

1. From the Home screen, select **Charts > Navigation Chart > Menu > Navigation Chart Setup > Chart Appearance > Symbols**.
2. Complete an action:
  - Select **Land POIs > On** to show land-based points of interest (POIs).
  - Select **Light Sectors** to show the sector in which a navigational light is visible. Select **On** to show light sectors at all times, or select **Auto** to allow the chartplotter to automatically filter out light sectors depending on the zoom level.
  - Select **Photo Points > On** to show camera icons when using a BlueChart g2 Vision data card. This enables you to view aerial photos of landmarks (page 20).

### Changing the Vehicle Icon

You can select a large, medium, or small boat or triangle as your vehicle icon on the chart.

1. From the Home screen, select **Charts > Navigation Chart > Menu > Navigation Chart Setup > Chart Appearance > Symbols > Vehicle Icon**.
2. Select the icon you want to represent your boat on the Navigation chart and Fishing chart.

### Showing Marine Service Points

Service points indicate locations where marine maintenance and repair services may be obtained.

From the Home screen, select **Charts > Navigation Chart > Menu > Navigation Chart Setup > Service Points > On**.

### Showing and Configuring Roses

On the Navigation chart or the Fishing chart, you can show a compass rose ① around your boat, indicating compass direction oriented to the heading of the boat. True wind direction or apparent wind direction appears ② if the chartplotter is connected to a compatible marine wind sensor.

1. From the Home screen, select **Charts**.
2. Select **Navigation Chart** or **Fishing Chart**.
3. Select **Menu**.
4. Select **Navigation Chart Setup** or **Fishing Chart Setup**.
5. Select **Roses**.
6. Select a type of rose (**Compass**, **True Wind**, or **Apparent Wind**).



**Showing Other Vessels**

See “Configuring the Appearance of Other Vessels” (page 50).

**Showing and Configuring Data Overlay**

See “About Chart Overlay Numbers” (page 48).

**Using Waypoints**

See “Waypoints” (page 26).

**Using Tracks**

See “Tracks” (page 30).

**Automatic Identification System**

The Automatic Identification System (AIS) enables you to identify and track other vessels.

**About AIS**

AIS alerts you to area traffic. When connected to an external AIS device, the chartplotter can show some AIS information about other vessels that are within range, that are equipped with a transponder, and that are actively transmitting AIS information. The information reported for each vessel includes the Maritime Mobile Service Identity (MMSI), the location, the GPS speed, the GPS heading, the time that has elapsed since the last position of the vessel was reported, the nearest approach, and the time to the nearest approach.

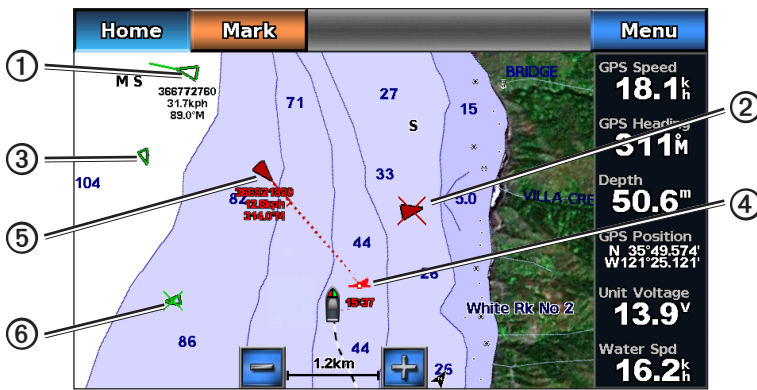

**AIS Targeting on the Navigation Chart**

**About AIS Search and Rescue Transmitters**

AIS Search and Rescue Transmitters (AIS-SART, or SART) are self-contained devices that transmit emergency position reports when activated. SART transmissions are different than standard AIS transmissions, so they look different than standard AIS symbols on the chartplotter. Instead of tracking a SART transmission for collision avoidance, you track a SART transmission to locate and assist a vessel.

**Navigating to a SART Transmission**









When you receive a SART transmission, a distress signal alarm appears.

Select **Review > Go To** to begin navigation to the SART transmission.

**AIS Targeting Symbols**

	Symbol	Description
①		AIS Target is activated. The target appears larger on the chart. A green line attached to the target indicates the heading of the target. The MMSI, speed, and direction of the vessel appear beneath the target, if the details setting is set to <b>Show</b> (page 14). If the AIS transmission from the vessel is lost, a message banner appears.
②		Dangerous target is lost. A red X indicates that the AIS transmission from the vessel is lost, and the chartplotter displays a message banner asking whether the vessel should continue to be tracked. If you discontinue vessel tracking, the lost dangerous target symbol disappears from the chart or the 3D chart view.
③		AIS vessel. The vessel is reporting AIS information. The direction in which the triangle is pointing indicates the direction in which the AIS vessel is moving.



④		The location of this symbol indicates the closest point of approach to a dangerous target, and the numbers near the symbol indicate the time to the closest point of approach to that target.
⑤		Dangerous target in range. The target flashes while an alarm sounds and a message banner appears. After the alarm is acknowledged, a solid red triangle with a red line attached to it indicates the location and the heading of the target. If the safe-zone collision alarm is set to <b>Off</b> , the target flashes, but the audible alarm does not sound and the alarm banner does not appear (page 15). If the AIS transmission from the vessel is lost, a message banner appears.
⑥		Target is lost. A green X indicates that the AIS transmission from the vessel is lost, and the chartplotter displays a message banner asking whether the vessel should continue to be tracked. If you discontinue vessel tracking, the lost target symbol disappears from the chart or the 3D chart view.
		Target is selected.
		AIS-SART transmission. You can select this symbol to see more information about the SART transmission and begin navigation.
		AIS-SART transmission lost.
		AIS-SART transmission test. This symbol appears when a vessel initiates a test of their SART device, and does not represent a true emergency. You can disable these test symbols and alerts (page 14)
		AIS-SART transmission test lost.

### Heading and Projected Course of Activated AIS Targets

When heading and course over ground information are provided by an activated AIS target, the heading of the target appears on a chart as a solid line attached to the AIS target symbol. A heading line does not appear on a 3D chart view.

The projected course of an activated AIS target appears as a dashed line on a chart or a 3D chart view. The length of the projected course line is based on the value of the projected heading setting (page 14). If an activated AIS target is not transmitting speed information, or if the vessel is not moving, a projected course line does not appear. Changes in the speed, the course over ground, or the rate-of-turn information transmitted by the vessel can impact the calculation of the projected course line.

When course over ground, heading, and rate of turn information are provided by an activated AIS target ①, the projected course ② of the target is calculated based on the course over ground and the rate of turn information. The direction in which the target is turning, which is also based on the rate of turn information, is indicated by the direction of the barb ③ at the end of the heading line ④. The length of the barb does not change.

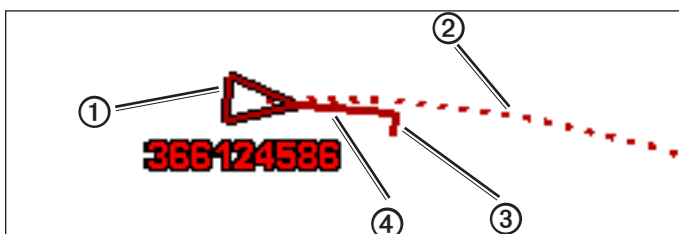

**Target with Projected Course, Heading, and Direction of Turn**

When course over ground and heading ⑤ information are provided by an activated AIS target ⑥ but rate of turn information is not provided, the projected course ⑦ of the target is calculated based on the course over ground information.

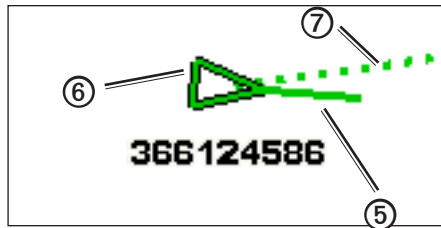

**Target with Projected Course and Heading**

### Turning Off AIS Reception

AIS signal reception is turned on by default.

From the Home screen, select **Configure** > **Other Vessels** > **AIS** > **Off**.

All AIS functionality on all charts and on all 3D chart views is disabled. This includes AIS vessel targeting and tracking, collision alarms that result from AIS vessel targeting and tracking, and information about AIS vessels.

### Enabling AIS-SART Transmission Test Alerts

In order to avoid a large number of test alerts and symbols in crowded areas such as marinas, AIS-SART test alerts ignored by default. To test an AIS SART device, you must enable the chartplotter to receive test alerts.

From the Home screen, select **Configure** > **Other Vessels** > **AIS SART Test**.

### Showing AIS Vessels on a Chart or on a 3D Chart View

AIS requires the use of an external AIS device and active transponder signals from other vessels.

You can configure how other vessels appear on a chart or on a 3D chart view. The display range configured for one chart or one 3D chart view is applied only to that chart or to that 3D chart view. The details, projected heading, and trails settings configured for one chart or one 3D chart view are applied to all charts and to all 3D chart views.

**NOTE:** The Mariner's Eye 3D chart is available if you use a BlueChart g2 Vision SD card. The Fishing chart is available if you use a BlueChart g2 Vision SD card or a BlueChart g2 SD card, or if your built-in map supports Fishing charts.

1. From the Home screen, select **Charts**.
2. Select **Navigation Chart**, **Fishing Chart**, **Perspective 3D**, or **Mariner's Eye 3D**.
3. Select **Menu** > **Other Vessels** > **AIS Display Setup**.
4. Complete an action:
  - Select **AIS Display Range** to indicate the distance from your location within which AIS vessels appear. Select a distance or select **Show All**.
  - Select **Details** > **Show** to show details about AIS-activated vessels.
  - Select **Projected Heading**, enter the projected heading time for AIS-activated vessels, and select **Done**.
  - Select **Trails** to show the tracks of AIS vessels, and select the length of the track that appears using a trail.

### Activating a Target for an AIS Vessel

1. From the Home screen, select **Charts**.
2. Select **Navigation Chart**, **Fishing Chart**, **Perspective 3D**, or **Mariner's Eye 3D**.
3. Touch an AIS vessel.
4. Select **AIS Vessel** > **Activate Target**.

### Viewing Information about a Targeted AIS Vessel

You can view the AIS signal status, MMSI, GPS speed, GPS heading, and other information that is reported about a targeted AIS vessel.

1. From the Home screen, select **Charts**.
2. Select **Navigation Chart**, **Fishing Chart**, **Perspective 3D**, or **Mariner's Eye 3D**.

3. Touch an AIS vessel.
4. Select **AIS Vessel**.

### Deactivating a Target for an AIS Vessel

1. From the Home screen, select **Charts**.
2. Select **Navigation Chart, Fishing Chart, Perspective 3D, or Mariner's Eye 3D**.
3. Touch the AIS vessel.
4. Select **AIS Vessel > Deactivate Target**.

### Setting the Safe-zone Collision Alarm

The safe-zone collision alarm is used only with AIS. The safe zone is used for collision avoidance, and can be customized. All safe-zone collision alarm settings are applied to all charts, to all 3D chart views, to all radar modes, and to the Radar Overlay.

1. From the Home screen, select **Configure > Other Vessels > AIS Alarm > On**.  
A message banner appears and an alarm sounds when an AIS-activated vessel enters the safe-zone ring around your boat. The object is also labeled as dangerous on the screen. The **Off** setting disables the message banner and the audible alarm, but the object is still labeled as dangerous on the screen.
2. Select **Range** to set the measured radius of the safe-zone ring to a specified distance from 500 ft. to 2.0 nm (or from 150 m to 3.0 km, or from 500 ft. to 2.0 mi.).
3. Select a distance.
4. Select **Time To** to sound an alarm if AIS determines that a target will intersect the safe zone within the defined time interval (ranging from 1 to 24 minutes).
5. Select a time.

### Viewing a List of AIS Targets

**NOTE:** The Mariner's Eye 3D chart is available if you use a BlueChart g2 Vision SD card. The Fishing chart is available if you use a BlueChart g2 Vision SD card or a BlueChart g2 SD card, or if your built-in map supports Fishing charts.

1. From the Home screen, select **Charts**.
2. Select **Navigation Chart, Fishing Chart, Perspective 3D, or Mariner's Eye 3D**.
3. Select **Menu > Other Vessels > AIS List**.

### Making a Call to an AIS Target

See "Making an Individual Routine Call to an AIS Target" (page 83).

## Perspective 3D

Perspective 3D provides a view from above and behind the boat (according to your course) and provides a visual navigation aid. This view is helpful when navigating tricky shoals, reefs, bridges, or channels, and is beneficial when trying to identify entry and exit routes in unfamiliar harbors or anchorages.

From the Home screen, select **Charts > Perspective 3D**.



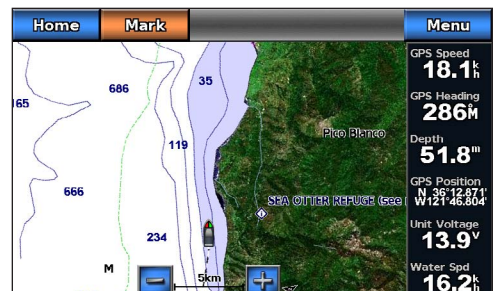

Perspective 3D



Navigation Chart

## Adjusting the View

- Select  to move the view closer to your boat and lower to the water.
- Select  to move the view away from the boat.

The scale () is momentarily indicated at the bottom of the screen.

## Panning the Perspective 3D, Mariner's Eye 3D, or Fish Eye 3D Views

You can pan around your present location on the Perspective 3D, Mariner's Eye 3D, or Fish Eye 3D Views.

**NOTE:** Mariner's Eye 3D and Fish Eye 3D chart views are available only if you use a BlueChart g2 Vision SD card ([page 16](#)).

1. From the Home screen, select **Charts**.
2. Select **Mariner's Eye 3D**, **Perspective 3D**, or **Fish Eye 3D**.
3. Touch and drag the screen to the left or right to rotate the 3D view.
4. Select **Stop Panning** to stop panning and return the screen to your present location.

## Perspective 3D and Mariner's Eye 3D Chart Appearance

### Showing Range Rings

The range rings help you to visualize distances in Perspective 3D or Mariner's Eye 3D.

**NOTE:** Mariner's Eye 3D is available with a preprogrammed BlueChart g2 Vision data card.

1. From the Home screen, select **Charts**.
2. Select **Perspective 3D** or **Mariner's Eye 3D**.
3. Select **Menu > Chart Appearance > Range Rings > On**.

### Selecting a Lane Width

The navigation lane is the magenta line in Perspective 3D or Mariner's Eye 3D view that indicates the course to your destination while you are navigating. You can specify the width of the navigation lane.

**NOTE:** Mariner's Eye 3D is available with a preprogrammed BlueChart g2 Vision data card.

1. From the Home screen, select **Charts**.
2. Select **Perspective 3D** or **Mariner's Eye 3D**.
3. Select **Menu > Chart Appearance > Lane Width**.
4. Enter the width.
5. Select **Done**.

### Showing Other Vessels

See "Configuring the Appearance of Other Vessels" ([page 50](#)).

### Showing and Configuring Data Overlay

See "Overlay Numbers" ([page 48](#)).

### Using Waypoints and Tracks

See "Waypoints" ([page 26](#)) or "Tracks" ([page 30](#)).

## BlueChart g2 Vision

An optional, preprogrammed BlueChart g2 Vision data card allows you to get the most out of your chartplotter. In addition to detailed marine charting, BlueChart g2 Vision has the following features:

- **Mariner's Eye 3D** ([page 17](#))—provides a view from above and behind the boat for a three-dimensional navigation aid. The BlueChart g2 Vision Mariner's Eye 3D is more detailed than the pre-loaded data.
- **Fish Eye 3D** ([page 18](#))—provides an underwater, three-dimensional view that visually represents the sea floor according to the information on the chart.
- **Fishing Charts** ([page 19](#))—shows the chart with enhanced bottom contours and without navigational data. This chart works well for offshore deep-sea fishing.
- **High Resolution Satellite Imagery** ([page 20](#))—provides high-resolution satellite images for a realistic view of the land and water on the Navigation chart.

- **Aerial Photos** (page 20)—shows marinas and other navigationally significant aerial photos to help you visualize your surroundings.
- **Detailed Roads and POI data** (page 21)—shows roads, restaurants, and other points of interest (POIs) along the shore.
- **Auto Guidance** (page 21)—uses specified safe depth, safe height, and chart data to determine the best course to your destination.

## BlueChart g2 Vision Data Cards

### NOTICE

BlueChart g2 Vision data cards are not waterproof. When you are not using the card, keep it in the original packaging for safekeeping and store it away from exposure to sun and rain to prevent damage to the card.

BlueChart g2 Vision data cards are susceptible to damage from static electricity. In low-humidity environments, you should ground yourself on a large metal object before handling the card to prevent damage to the card.

You cannot transfer BlueChart g2 Vision data from the data card to your computer for backup or viewing purposes. You can use the data card only on BlueChart g2 Vision-compatible Garmin GPS units or Garmin HomePort™.

You can insert or remove a BlueChart g2 Vision data card (page 2) while your chartplotter is on or off.

## Mariner's Eye 3D

A BlueChart g2 Vision data card offers Mariner's Eye 3D, which provides a detailed, three-dimensional view from above and behind the boat (according to your course) and provides a visual navigation aid. This view is helpful when navigating tricky shoals, reefs, bridges, or channels, and when trying to identify entry and exit routes in unfamiliar harbors or anchorages.

From the Home screen, select **Charts > Mariner's Eye 3D**.

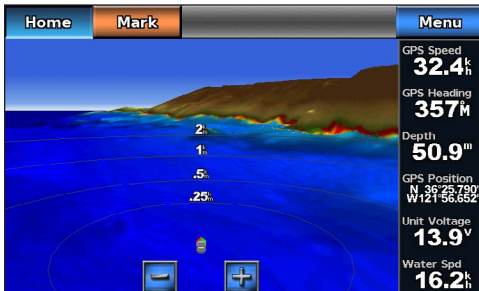

Mariner's Eye 3D with Range Rings

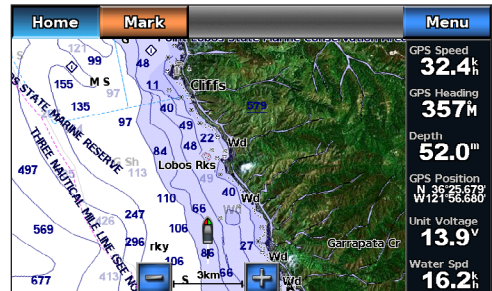

Navigation Chart

### Adjusting the View

See “Adjusting the View” (page 16).

### Viewing Details about Nav aids

See “Viewing Details about Nav aids” (page 8).

## Mariner's Eye 3D Chart Appearance

### Customizing the Appearance of 3D Terrain

You can select how chart data appears over 3D terrain.

1. From the Home screen, select **Charts > Mariner's Eye 3D > Menu > Chart Appearance > Style**.
2. Complete an action:
  - Select **Classic** to use color schemes to indicate 3D terrain.
  - Select **Charts** to provide chart information in a 3D view.
  - Select **Photos** to provide satellite imagery and chart information in a 3D view.

### Showing or Hiding Hazard Colors

- From the Home screen, select **Charts > Mariner's Eye 3D > Menu > Chart Appearance > Hazard Colors**.
- Complete an action:
  - Select **On** to view shallow water and land with a color scale. Blue indicates deep water, yellow is shallow water, and red is very shallow water.
  - Select **Off** to view the land as seen from the water.



**Mariner's Eye 3D, Hazard Colors Off**

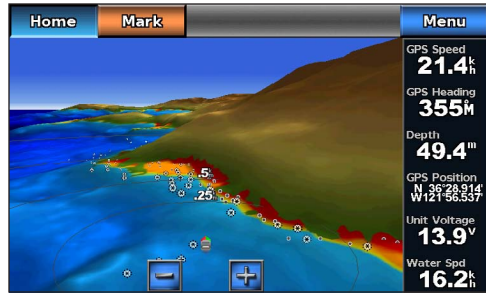

**Mariner's Eye 3D, Hazard Colors On**

### Showing Range Rings

See “Showing Range Rings” (page 16).

### Selecting a Safe Depth

You can set the appearance of a safe depth for Mariner's Eye 3D.

**NOTE:** This setting affects only the appearance of hazard colors in Mariner's Eye 3D. It does not affect the safe water depth Auto Guidance setting (page 46) or the sonar shallow water alarm setting (page 77).

- From the Home screen, select **Charts > Mariner's Eye 3D > Menu > Chart Appearance > Safe Depth**.
- Enter the depth.
- Select **Done**.

### Selecting a Lane Width

See “Selecting a Lane Width” (page 16).

### Showing Other Vessels

See “Configuring the Appearance of Other Vessels” (page 50).

### Showing and Configuring Overlay Numbers

See “Overlay Numbers” (page 48).

### Using Waypoints and Tracks

See “Waypoints” (page 26) or “Tracks” (page 30).

## Fish Eye 3D

Using the depth contour lines of the BlueChart g2 Vision cartography, Fish Eye 3D provides an underwater view of the sea floor or lake bottom.

When a sonar transducer is connected, suspended targets (such as fish) are indicated by red, green, and yellow spheres. Red indicates the largest targets and green indicates the smallest.



Fish Eye 3D with a Sonar Cone

### Adjusting the View

See “Adjusting the View” (page 16).

### Fish Eye 3D Chart Appearance

#### Indicating the Direction of the Fish Eye 3-D Chart View

1. From the Home screen, select **Charts > Fish Eye 3D > Menu > View**.
2. Select **Fore, Aft, Port, or Starboard**.

#### Showing a Sonar Cone on the Chart

You can show a cone that indicates the area covered by your transducer.

From the Home screen, select **Charts > Fish Eye 3D > Menu > Sonar Cone > On**.

#### Showing Suspended Targets

From the Home screen, select **Charts > Fish Eye 3D > Menu > Fish Symbols > On**.

#### Showing Tracks

From the Home screen, select **Charts > Fish Eye 3D > Menu > Tracks > On**.

#### Showing Overlay Numbers

See “Overlay Numbers” (page 48).

## Fishing Chart

Use the Fishing chart for a detailed view of the bottom contours and depth soundings on the chart.

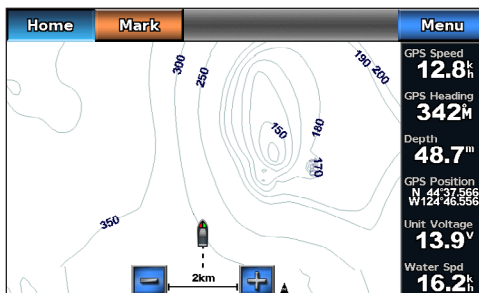

Fishing Chart

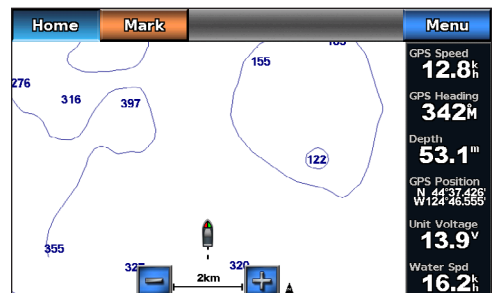

Navigation Chart

The Fishing chart uses detailed bathymetric data, and is best for offshore deep-sea fishing.

### Fishing Chart Appearance

#### Using Waypoints

See “Waypoints” (page 26).

## Using Tracks

See “Tracks” (page 30).

## Showing Other Vessels

See “Configuring the Appearance of Other Vessels” (page 50).

## Showing Nav aids

From the Home screen, select **Charts > Fishing Chart > Menu > Nav aids > On**.

## Showing Overlay Numbers

See “Overlay Numbers” (page 48).

## Showing Satellite Imagery on the Navigation Chart

You can overlay high-resolution satellite images on the land or on both land and sea portions of the Navigation chart when using a preprogrammed BlueChart g2 Vision data card.

**NOTE:** When enabled, high-resolution satellite images are present only at lower zoom levels. If you cannot see high-resolution images in your BlueChart g2 Vision region, you can zoom in further by pressing **+**. You also can set the detail level higher by changing the map zoom detail (page 8).

1. From the Home screen, select **Charts > Navigation Chart > Menu > Navigation Chart Setup > Photos**.
2. Complete an action:
  - Select **Land Only** to show standard chart information on the water, with photos overlaying the land.
  - Select **Photo Map Blend** to show photos on both the water and the land at a specified opacity. Use the slider bar to adjust the photo opacity. The higher you set the percentage, the more the satellite photos cover both land and water.

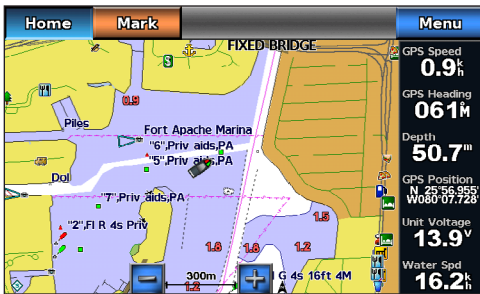

Photo Overlay Off



Land Only Photo Overlay



Photo Map at 50%





Photo Map at 100%



## Viewing Aerial Photos of Landmarks

Before you can view aerial photos on the Navigation chart, you must turn on the Photo Points setting (page 11).

Preprogrammed BlueChart g2 Vision data cards contain aerial photographs of many landmarks, marinas, and harbors. Use these photos to help orient yourself to your surroundings or to acquaint yourself with a marina or a harbor prior to arrival.



1. From Home screen, select **Charts > Navigation Chart**.
2. Select a camera icon.
  - A standard camera icon () indicates an overhead photo.
  - A camera icon with a cone () indicates a perspective photo. The photo was taken from the location of the camera, pointed in the direction of the cone.
3. Select **Review > Aerial Photo**.
 

**NOTE:** Select  and  to zoom out and zoom in while viewing the aerial photo on the full screen.

## Animated Tide and Current Indicators



You can view indicators for animated tide station and current direction on the Navigation chart or the Fishing chart. To do so, information for tide station and current direction must be available in your preloaded map or BlueChart g2 Vision region. You must also select the Animated value for the Tides/Currents setting ([page 8](#)).

An indicator for a tide station appears on the chart as a vertical bar graph with an arrow. A red arrow pointing downward indicates a falling tide, and a blue arrow pointing upward indicates a rising tide. When you move the cursor over the tide station indicator, the height of the tide at the station appears above the station indicator.



**Tide Station with Falling Tide**

Current direction indicators appear as arrows on the chart. The direction of each arrow indicates the direction of the current at a specific location on the chart. The color of the current arrow indicates the range of speed for the current at that location. When you move the cursor over the current direction indicator, the specific current speed at the location appears above the direction indicator.

Direction Indicator	Color	Current Speed Range
	Yellow	0 to 1 knot
	Orange	1 to 2 knots
	Red	2 or more knots

## Viewing Current Station Information

See “Current Information” ([page 37](#)).

## Detailed Road and Point of Interest Data

BlueChart g2 Vision contains detailed road and point of interest (POI) data, which includes highly detailed coastal roads and POIs such as restaurants, lodging, local attractions, and more.

## Searching for, and Navigating to, POIs

See “Where To?” ([page 33](#)).

## Auto Guidance

Auto Guidance automatically creates and suggests the best path to a destination, based on available BlueChart g2 Vision chart information. Auto Guidance is available when you navigate to a destination using Guide To ([page 26](#)).

## Configuring Auto Guidance Settings

See “Auto Guidance Line Configurations” ([page 45](#)).

# Combinations

## About the Combination Screen

The Combination screen shows a combination of different screens at the same time. The number of options available on the Combination screen depends on the optional devices you have connected to your chartplotter, and whether you are using an optional BlueChart g2 Vision data card.

## Combination Screen Configuration

### Selecting a Combination

1. From the Home screen, select **Combinations**.
2. Select a combination.

### Customizing the Combination Screen

1. From the Home screen, select **Combinations**.
2. Select a combination.
3. Select **Menu**.
4. Select the screen you want to customize.
5. Adjust the settings as described in “Charts and 3D Chart Views” (page 4), “Radar” (page 54), or “Sonar” (page 71).

### Combination Screen Overlay Numbers

Overlay numbers with data fields can appear on combination screens, and they provide real-time, at-a-glance information. The data overlay ① for each combination can be configured separately.

Several combination screen data overlays are available. You can select the data fields ② to be shown within each data overlay.

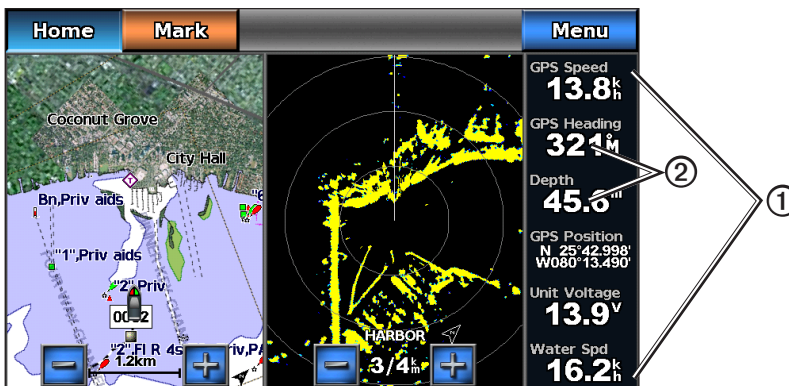

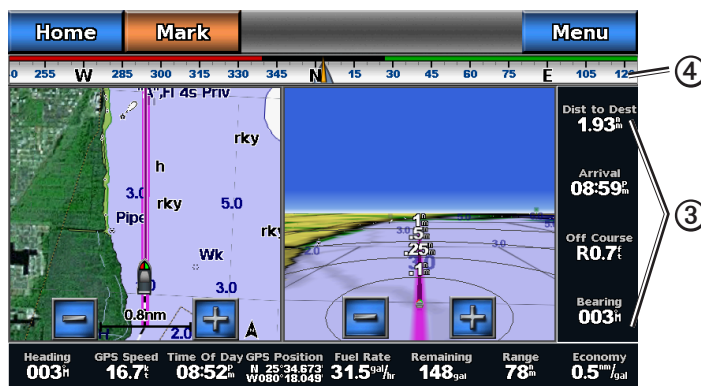

When overlay numbers are displayed on the Combination screen, the navigation inset ③ is shown during navigation. The compass tape ④ can be shown or hidden in each overlay.





Combination Screen with Data Overlay

### Selecting a Data Overlay on a Combination Screen

1. From the Home screen, select **Combinations**.
2. Select a combination.
3. Select **Menu > Overlay Numbers**.
4. Select  or  to select a data overlay.



### Configuring Data Fields on a Combination Screen

You can select the type of data shown within a data field.

1. From the Home screen, select **Combinations**.
2. Select a combination.
3. Select **Menu > Overlay Numbers**.
4. Select  or  to select a data overlay.
5. Touch a data field.
6. Select a category of data.
7. Select the data to be displayed.

### Configuring the Navigation Inset on a Combination Screen

The navigation inset is shown only when the boat is navigating to a destination.

1. From the Home screen, select **Combinations**.
2. Select a combination.
3. Select **Menu > Overlay Numbers**.
4. Select  or  to select a data overlay.
5. Select **Navigation Inset > Nav. Inset Config**.
6. Complete an action:
  - Select **Route Leg Details > On** to show waypoint velocity made good (VMG) when navigating a route with more than one leg.
  - Select **Next Turn > Distance** to show next-turn data based on distance.
  - Select **Next Turn > Time** to show next-turn data based on time.
  - Select **Destination**, and select **Distance**, **Time to Destination**, or **Arrival** to indicate how the destination data appears.

### **Showing the Compass Tape on a Combination Screen**

The compass tape appears in a row across the top of the combination screen. It shows the present heading, and an indicator that shows the bearing to the desired course appears while navigating.

1. From the Home screen, select **Combinations**.
2. Select a combination.
3. Select **Menu > Overlay Numbers > Show Compass Tape**.

### **Using Full-screen View**

You can view the content of any combination screen on the full chartplotter screen.

1. From the Home screen, select **Combinations**.
2. Select a combination.
3. Touch the screen you want to view on the full chartplotter screen.
4. Select **Stop Pointing** to remove the pointer from the screen.
5. Select **Stop Panning** to return to the Combination screen.

### **Returning to the Combination Screen from Full-screen View**

1. From the Full-screen view, select **Stop Pointing** to remove the pointer from the screen.
2. Select **Stop Panning** to return to the Combination screen.

# Navigation

## Basic Navigation Questions

Question	Answer
How do I make the chartplotter point me in the direction in which I want to go (bearing)?	Navigate using Go To. See "Setting and Following a Direct Course Using Go To" ( <a href="#">page 26</a> ).
How do I make the chartplotter guide me along a straight line (minimizing cross track) to a location using the shortest distance from the present location?	Build a single-leg route and navigate it using Route To ( <a href="#">page 28</a> ).
How do I make the chartplotter guide me to a location while avoiding obstacles?	Build a multi-leg route and navigate it using Route To. See "Creating and Navigating a Route from Your Present Location" ( <a href="#">page 28</a> ).
How do I make the chartplotter steer my automatic pilot?	Navigate using Route To ( <a href="#">page 28</a> ).
Can the chartplotter create a course for me?	If you have a BlueChart g2 Vision data card, navigate using Auto Guidance. See "Setting and Following a Course Using Auto Guidance" ( <a href="#">page 26</a> ).
How do I change the Auto Guidance settings for my boat?	See "Auto Guidance Line Configurations" ( <a href="#">page 45</a> ).

## Navigation with a Chartplotter

To navigate using a GPSMAP 700 series chartplotter, you must first choose a destination, set a course or create a route, and follow the course or route. You can follow the course or the route on the Navigation chart, the Fishing chart, Perspective 3D, or Mariner's Eye 3D.

**NOTE:** The Mariner's Eye 3D chart is available if you use a BlueChart g2 Vision SD card. The Fishing chart is available if you use a BlueChart g2 Vision SD card or a BlueChart g2 SD card, or if your built-in map supports Fishing charts.

### Destinations

You can select destinations using the navigation chart or the fishing chart, or you can select a destination using the Where To? feature.

#### Selecting a Destination Using the Navigation Chart

1. From the Home screen, select **Charts > Navigation Chart**.
2. Touch the navigation chart to select the destination.

#### Stopping Navigation while Using the Navigation Chart

From the Home screen, select **Charts > Navigation Chart > Menu > Stop Navigation**.

#### Selecting a Destination Using Where To?

1. From the Home screen, select **Where To?**
2. Complete an action:
  - Select **Waypoints** to view a list of preloaded locations and locations you marked previously ([page 26](#)).
  - Select **Routes** to view a list of routes you saved previously ([page 28](#)).
  - Select **Tracks** to view a list of recorded tracks ([page 30](#)).
  - Select **Offshore Services** to view a list of marinas and other offshore points of interest, listed by name ([page 33](#)).
  - Select **Search by Name** to search waypoints, routes, tracks, and offshore points of interest by name ([page 33](#)).
3. Select a destination.

## Courses

You can set and follow a course to a destination using one of three methods: Go To, Route To, or Guide To.

- **Go To**—takes you directly to the destination.
- **Route To**—creates a route from your location to a destination, allowing you to add turns along the way.
- **Guide To**—uses BlueChart g2 Vision chart data to suggest the best path to your destination using Auto Guidance. You must be using a BlueChart g2 Vision data card for this option to appear.

### Setting and Following a Direct Course Using Go To

#### CAUTION

When using Go To, a direct course and a corrected course may pass over land or shallow water. Use visual sightings and steer to avoid land, shallow water, and other dangerous objects.

You can set and follow a direct course from your present location to a selected destination.

1. Select a destination using a chart or Where To? (page 25).

2. Select **Navigate To > Go To**.

A magenta line appears. In the center of the magenta line is a thinner purple line that represents the corrected course from your present location to the destination. The corrected course is dynamic, and it moves with your boat when you are off course.

3. Follow the magenta line, steering to avoid land, shallow water, and other obstacles.

**NOTE:** If you are off course, follow the purple line (corrected course) to go to your destination, or steer back to the magenta line (direct course).

### Creating and Following a New Route Using Route To

See “Creating and Navigating a Route from Your Present Location” (page 28).

### Following a Saved Route Using Route To

See “Browsing for, and Navigating, a Saved Route” (page 34).

### Setting and Following a Course Using Auto Guidance

#### CAUTION

The Auto Guidance feature of the BlueChart g2 Vision data card is based on electronic chart information. That data does not ensure obstacle and bottom clearance. Carefully compare the course to all visual sightings and avoid any land, shallow water, or other obstacles that may be in your path.

1. Select a destination using a chart or Where To? (page 25).

2. Select **Navigate To > Guide To**.

3. Review the course indicated by the magenta Auto Guidance line.

**NOTE:** A gray line within any part of the magenta line indicates that Auto Guidance cannot calculate part of the Auto Guidance line. This is due to the minimum safe water depth and the minimum safe obstacle height settings (page 46).

4. Follow the magenta line, steering to avoid land, shallow water, and other obstacles.

## Waypoints

You can store up to 3,000 waypoints with a user-defined name, symbol, depth, water temperature, and comment for each waypoint.

### Marking Your Present Location as a Waypoint

From the Home screen, select **Mark**.

Mark your present position from any other screen by touching **Mark** at the top of the screen.

### Creating a Waypoint at a Different Location

1. From the Home screen, select **Charts**.

2. Select **Navigation Chart** or **Fishing Chart**.

3. Complete an action:
  - Touch a location on the chart.
  - Touch and drag the screen to pan to a new location. Touch a location on the chart.
4. Select **Create Waypoint**.
5. If necessary, you can name the waypoint and provide other information about it. Select the waypoint on the right side of the screen and select **Edit Waypoint**.
  - Select **Name**, enter the name, and select **Done**.
  - Select **Symbol** and select a symbol.
  - Select **Depth**, enter the depth, and select **Done**.
  - Select **Water Temp**, enter the water temperature, and select **Done**.
  - Select **Comment**, enter the comment, and select **Done**.

### Marking and Navigating to an MOB Location

When you mark your present location as a waypoint, you can designate it as a man overboard (MOB) location.

Complete an action:

- From any screen, select **Mark > Man Overboard**.
- From the Home screen, select **Man Overboard**.

An international MOB symbol marks the active MOB point and the chartplotter sets a course back to the marked location using the Go To feature.

### Viewing a List of all Waypoints

From the Home screen, select **Information > User Data > Waypoints List**.

### Editing a Saved Waypoint

1. From the Home screen, select **Information > User Data > Waypoints List**.
2. Select a waypoint.
3. Select **Edit Waypoint**.
4. Complete an action:
  - Select **Name**, change the name, and select **Done**.
  - Select **Symbol** and select a new symbol.
  - Select **Depth**, change the depth, and select **Done**.
  - Select **Water Temp**, change the water temperature, and select **Done**.
  - Select **Comment**, change the comment, and select **Done**.

### Creating a New Waypoint from the Waypoints List

1. From the Home screen, select **Information > User Data > Waypoints List > New Waypoint**.
2. Complete an action:
  - Select **Enter Coordinates** to create a new waypoint by entering grid coordinates.
  - Select **Use Chart** to select a new waypoint on the chart.
  - Select **Use Current Position** to create a new waypoint at your present location.

### Moving a Saved Waypoint

1. From the Home screen, select **Information > User Data > Waypoints List**.
2. Select a waypoint.
3. Select **Edit Waypoint > Position**.
4. Indicate a new location for the waypoint:
  - Select **Use Chart** to move the waypoint while viewing a chart, touch a new location on the chart, and select **Move Waypoint**.
  - Select **Enter Coordinates**, move the waypoint, and select **Done**.

### Deleting a Waypoint or an MOB

You can delete a waypoint or an MOB that has been saved.

1. From the Home screen, select **Information > User Data > Waypoints List**.
2. Select a waypoint or an MOB.
3. Select **Delete**.

### Deleting All Waypoints

From the Home screen, select **Information > User Data > Clear User Data > Waypoints > All**.

### Copying Waypoints

See “Chartplotter Data Management” (page 52).

## Routes

You can create and save up to 100 routes. Each route can contain up to 250 waypoints.

### Creating and Navigating a Route from Your Present Location

You can create and immediately navigate a route on the Navigation chart or the Fishing chart. When you have reached the destination, you can choose to save the route.

**NOTE:** The Fishing chart is available if you use a BlueChart g2 Vision SD card or a BlueChart g2 SD card, or if your built-in map supports Fishing charts.

1. From the Home screen, select **Charts**.
2. Select **Navigation Chart** or **Fishing Chart**.
3. Touch a destination ①.

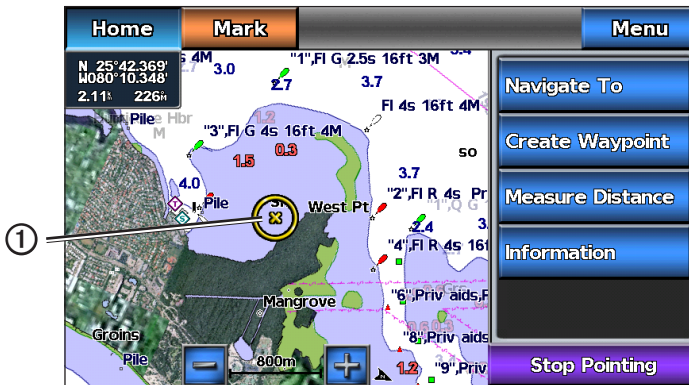

4. Select **Navigate To > Route To**.
5. Touch the location ② where you want to make the last turn toward your destination ③.
6. Select **Add Turn**.





7. If necessary, repeat steps 5 and 6 to add additional turns, working backward from the destination to the present location of your boat.
 

The last turn you add should be where you want to make the first turn from your present location. It should be the turn that is closest to your boat.
8. Select **Done** when the route is complete.
9. Review the course indicated by the magenta line.
10. Follow the magenta line, steering to avoid land, shallow water, and other obstacles.
 

When you have reached the destination, you are prompted to save the route.
11. Complete an action:
  - Select **No**
  - Select **Yes** > **Edit Route** > **Name** enter the name of the route, and select **Done**.

### Creating and Saving a Route

This procedure saves the route and all the waypoints in it. The starting point can be your present location or another location.

1. From the Home screen, select **Information** > **User Data** > **Routes** > **New Route** > **Use Chart**.
2. Select the starting point ① of the route.



3. Select **Add Turn** to mark the starting point of the route.
4. Touch a location on the chart where you want to make the next turn.
5. Select **Add Turn**. The chartplotter marks the position of the turn with a waypoint.
6. If necessary, repeat steps 4 and 5 to add additional turns.
7. Select the final destination.
8. Select **Done**.
9. If necessary, select **Edit Route** > **Name** to enter the name of the route.

### Viewing a List of Saved Routes

From the Home screen, select **Information** > **User Data** > **Routes**.

### Editing a Saved Route

You can change the name of a route, or change the turns the route contains.

1. From the Home screen, select **Information** > **User Data** > **Routes**.
2. Select the route to edit.
3. Select **Edit Route**.
4. Complete an action:
  - Select **Name**, and enter the name of the route.
  - Select **Edit Turns** > **Use Chart**, and touch a turn location on the chart.
  - Select **Edit Turns** > **Use Turn List**, and select a waypoint from the list.

5. Select **Done**.

### Deleting a Saved Route

1. From the Home screen, select **Information > User Data > Routes**.
2. Select a route.
3. Select **Delete**.

### Deleting All Saved Routes

From the Home screen, select **Information > User Data > Clear User Data > Routes > OK**.

### Bypassing a Waypoint on a Saved Route

You can begin navigating a saved route from any waypoint in the route.

1. From the Home screen, select **Where To? > Routes**.
2. Select a route.
3. Select **Navigate To**.
4. Complete an action:
  - Select **Forward** to navigate the route near the starting point that was used when the route was created.
  - Select **Backward** to navigate the route near the destination point that was used when the route was created.
  - Select **Offset** to navigate parallel to the route, offset from it by a specific distance ([page 35](#)).
5. Touch the waypoint that you want to be the next turn in the route.
6. Select **Navigate To > Route To**.
7. Review the course indicated by the magenta line.
8. Follow the magenta line, steering to avoid land, shallow water, and other obstacles.

### Copying Routes

See “Chartplotter Data Management” ([page 52](#)).

## Tracks

A track is a recording of the path of your boat. The track currently being recorded is called the active track, and it can be saved. You can show tracks in each chart or 3D chart view.

### Showing Tracks

1. From the Home screen, select **Charts**.
2. Select **Navigation Chart** or **Fishing Chart**.
3. Select **Menu > Waypoints & Tracks > Tracks > On**.

A trailing line  on the chart indicates your track.

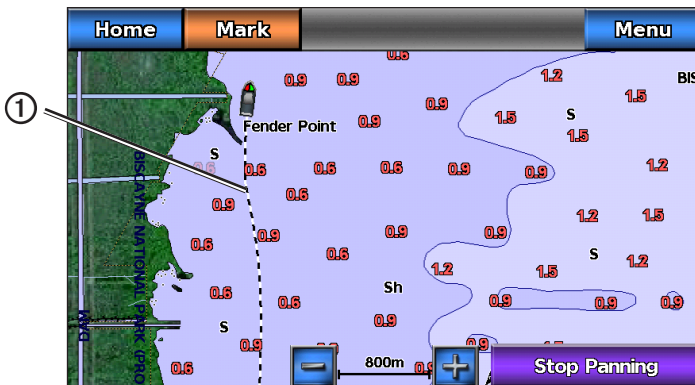

## Setting the Color of the Active Track

You can select the color of your present track when you are viewing the navigation chart or the fishing chart.

1. From the Home screen, select **Information > User Data > Tracks > Active Track Options > Track Color**.
2. Select a track color.

## Saving the Active Track

The track currently being recorded is called the active track.

1. From the Home screen, select **Information > User Data > Tracks > Save Active Track**.
2. Complete an action:
  - Select the time the active track began or **Midnight**, if shown.
  - Select **Entire Log**.
3. Select **Save**.

## Viewing a List of Saved Tracks

From the Home screen, select **Information > User Data > Tracks > Saved Tracks**.

## Editing a Saved Track

1. From the Home screen, select **Information > User Data > Tracks > Saved Tracks**.
2. Select a track.
3. Select **Edit Track**.
4. Complete an action:
  - Select **Name**, enter the new name, and select **Done**.
  - Select **Track Color**, and select a color.

## Saving a Track as a Route

1. From the Home screen, select **Information > User Data > Tracks > Saved Tracks**.
2. Select a track.
3. Select **Edit Track > Save Route**.

## Deleting a Saved Track

1. From the Home screen, select **Information > User Data > Tracks > Saved Tracks**.
2. Select a track.
3. Select **Delete**.

## Deleting All Saved Tracks

From the Home screen, select **Information > User Data > Clear User Data > Saved Tracks**.

## Retracing the Active Track

1. From the Home screen, select **Information > User Data > Tracks > Follow Active Track**.
2. Complete an action:
  - Select the time the active track began or **Midnight**, if shown.
  - Select **Entire Log**.
3. Review the course indicated by the colored line.
4. Follow the colored line, steering to avoid land, shallow water, and other obstacles.

## Clearing the Active Track

From the Home screen, select **Information > User Data > Tracks > Clear Active Track**.

The track memory is cleared, and the active track continues to be recorded.

### Managing the Track Log Memory During Recording

1. From the Home screen, select **Information > User Data > Tracks > Active Track Options > Record Mode**.
2. Complete an action:
  - Select **Fill** to record a track log until the track memory is full.
  - Select **Wrap** to continuously record a track log, replacing the oldest track data with new data.

### Configuring the Recording Interval of the Track Log

You can indicate the frequency at which the track plot is recorded. Recording more-frequent plots is more accurate but fills the track log faster. The **Resolution** interval is recommended for the most-efficient use of memory.

1. From the Home screen, select **Information > User Data > Tracks > Active Track Options > Interval > Interval**.
2. Complete an action:
  - Select **Distance** to record the track based on a distance between points, select **Change**, and enter the distance.
  - Select **Time** to record the track based on a time interval, select **Change**, and enter the time interval.
  - Select **Resolution** to record the track plot based on a variance from your course. Select **Change** to enter the maximum error allowed from the true course before recording a track point.
3. Select **Done**.

### Copying Tracks

See “Chartplotter Data Management” ([page 52](#)).

### Deleting All Saved Waypoints, Routes, and Tracks

From the Home screen, select **Information > User Data > Clear User Data > All > OK**.

### Navigating with a Garmin Autopilot

When you start navigation (Go To, Route To, or Guide To), if you are connected through a National Marine Electronics Association (NMEA) 2000 network to a compatible Garmin autopilot (such as the GHP™ 10), you are prompted to engage the autopilot.

## Where To?

Use the **Where To?** option on the Home screen to search for, and navigate to, nearby fuel, repairs, and other services, as well as waypoints and routes that you have created.

### Marine Services Destinations

The chartplotter contains information about thousands of destinations offering marine services.

**NOTE:** This feature may not be available in all areas.

### Navigating to a Marine Services Destination

#### ⚠ CAUTION

The Auto Guidance feature of the BlueChart g2 Vision data card is based on electronic chart information. That data does not ensure obstacle and bottom clearance. Carefully compare the course to all visual sightings and avoid any land, shallow water, or other obstacles that may be in your path.

When using Go To, a direct course and a corrected course may pass over land or shallow water. Use visual sightings and steer to avoid land, shallow water, and other dangerous objects.

**NOTE:** Auto Guidance is available with a preprogrammed BlueChart g2 Vision data card.

1. From the Home screen, select **Where To?** > **Offshore Services**.
2. Select the marine service category to which you want to navigate.

The chartplotter shows a list of the 50 nearest locations and the distance and bearing to each.

3. Select a destination.

**TIP:** Select  or  to view additional information or to show the location on a chart.

4. Complete an action:

- Select **Go To**.
- Select **Route To**.
- Select **Guide To** to use Auto Guidance.

5. Review the course indicated by the magenta line.

**NOTE:** When using Auto Guidance, a gray line within any part of the magenta line indicates that Auto Guidance cannot calculate part of the Auto Guidance line. This is due to the settings for minimum safe water depth and minimum safe obstacle height ([page 46](#)).

6. Follow the magenta line, steering to avoid land, shallow water, and other obstacles.

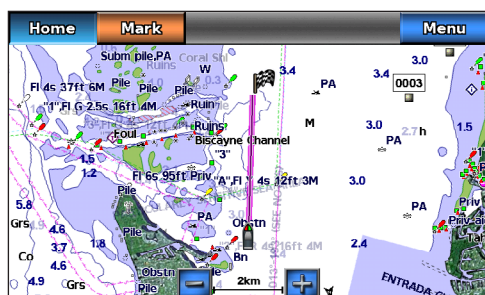

Go To Screen



Guide To Screen

### Stopping Navigation

From Home screen, select **Where To?** > **Stop Navigation**.

### Searching for, and Navigating to, a Destination

#### ⚠ CAUTION

The Auto Guidance feature of the BlueChart g2 Vision data card is based on electronic chart information. That data does not ensure obstacle and bottom clearance. Carefully compare the course to all visual sightings and avoid any land, shallow water, or other obstacles that may be in your path.

When using Go To, a direct course and a corrected course may pass over land or shallow water. Use visual sightings and steer to avoid land, shallow water, and other dangerous objects.

---

You can search for saved waypoints, saved routes, saved tracks, and marine services destinations by name.

1. From the Home screen, select **Where To?** > **Search by Name**.
2. Enter at least a portion of the name of your destination.
3. Select **Done**.

The 50 nearest destinations that contain your search criteria appear.

4. Select the location.
5. Complete an action:
  - Select **Go To**.
  - Select **Route To**.
  - Select **Guide To** to use Auto Guidance.
6. Review the course indicated by the magenta line.

**NOTE:** When using Auto Guidance, a gray line within any part of the magenta line indicates that Auto Guidance cannot calculate part of the Auto Guidance line. This is due to the settings for minimum safe water depth and minimum safe obstacle height ([page 46](#)).

7. Follow the magenta line, steering to avoid land, shallow water, and other obstacles.

### Browsing for, and Navigating to, a Saved Waypoint

#### CAUTION

The Auto Guidance feature of the BlueChart g2 Vision data card is based on electronic chart information. That data does not ensure obstacle and bottom clearance. Carefully compare the course to all visual sightings and avoid any land, shallow water, or other obstacles that may be in your path.

---

When using Go To, a direct course and a corrected course may pass over land or shallow water. Use visual sightings and steer to avoid land, shallow water, and other dangerous objects.

---

Before you can browse a list of waypoints and navigate to them, you must create and save at least one waypoint ([page 26](#)).

1. From the Home screen, select **Where To?** > **Waypoints**.
2. Select a waypoint.
3. Select **Navigate To**.
4. Complete an action:
  - Select **Go To**.
  - Select **Route To**.
  - Select **Guide To** to use Auto Guidance.

5. Review the course indicated by the magenta line.

**NOTE:** When using Auto Guidance, a gray line within any part of the magenta line indicates that Auto Guidance cannot calculate part of the Auto Guidance line. This is due to the settings for minimum safe water depth and minimum safe obstacle height ([page 46](#)).

6. Follow the magenta line, steering to avoid land, shallow water, and other obstacles.

### Browsing for, and Navigating, a Saved Route

Before you can browse a list of routes and navigate to one of them, you must create and save at least one route ([page 29](#)).

1. From the Home screen, select **Where To?** > **Routes**.
2. Select a route.
3. Select **Navigate To**.

4. Complete an action:
  - Select **Forward** to navigate the route from the starting point used when the route was created.
  - Select **Backward** to navigate the route from the destination point used when the route was created.

A magenta line appears. In the center of the magenta line is a thinner purple line that represents the corrected course from your present location to the destination. The corrected course is dynamic, and it moves with your boat when you are off course.

5. Review the course indicated by the magenta line.
6. Follow the magenta line along each leg in the route, steering to avoid land, shallow water, and other obstacles.

**NOTE:** If you are off course, follow the purple line (corrected course) to go to your destination, or steer back to the magenta line (direct course).

### Browsing for, and Navigating Parallel to, a Saved Route

Before you can browse a list of routes and navigate to one of them, you must create and save at least one route ([page 29](#)).

1. From the Home screen, select **Where To? > Routes**.
2. Select a route.
3. Select **Navigate To**.
4. Select **Offset** to navigate parallel to the route, offset from it by a specific distance.
5. Indicate how to navigate the route:
  - Select **Forward - Port** to navigate the route from the starting point used when the route was created, to the left of the original route.
  - Select **Forward - Starboard** to navigate the route from the starting point used when the route was created, to the right of the original route.
  - Select **Backward - Port** to navigate the route from the destination point used when the route was created, to the left of the original route.
  - Select **Backward - Starboard** to navigate the route from the destination point used when the route was created, to the right of the original route.

6. Enter the offset distance.
7. Select **Done**.

A magenta line appears. In the center of the magenta line is a thinner purple line that represents the corrected course from your present location to the destination. The corrected course is dynamic, and it moves with your boat when you are off course.

8. Review the course indicated by the magenta line.
9. Follow the magenta line along each leg in the route, steering to avoid land, shallow water, and other obstacles.

**NOTE:** If you are off course, follow the purple line (corrected course) to go to your destination, or steer back to the magenta line (direct course).

### Browsing for, and Navigating, a Recorded Track

Before you can browse a list of tracks and navigate to them, you must record and save at least one track ([page 31](#)).

1. From the Home screen, select **Where To? > Tracks**.
2. Select a track.
3. Select **Follow Track**.
4. Complete an action:
  - Select **Forward** to navigate the track from the starting point used when the track was created.
  - Select **Backward** to navigate the track from the destination point used when the track was created.
5. Review the course indicated by the colored line.
6. Follow the colored line, steering to avoid land, shallow water, and other obstacles.

## Almanac, On-boat, and Environmental Data

The Information screen displays information about tides, currents, celestial data, and gauges.

### Almanac Data

#### Tide Station Information

The Tides screen shows information about a tide station ① for a specific date ② and time ③, including the tide height ④, and when the next high and low tides will occur. By default, the chartplotter shows tide information for the most-recently viewed tide station and for the present date and time.

From the Home screen, select **Information > Tides**.

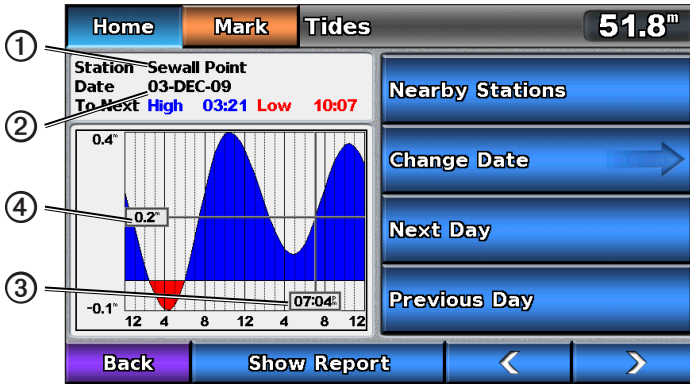

Tide Station Information

#### Viewing Information about a Nearby Tide Station

1. From the Home screen, select **Information > Tides > Nearby Stations**.
2. Select a station.

#### Viewing Tide Station Information for a Different Date

1. From the Home screen, select **Information > Tides > Nearby Stations**.
2. Select a station.
3. Complete an action:
  - Select **Change Date > Manual** to view tide information for a different date, enter the date, and select **Done**.
  - Select **Next Day** to view tide information for the day after the date shown.
  - Select **Previous Day** to view tide information for the day before the date shown.



## Current Information

**NOTE:** Current station information is available with a BlueChart g2 Vision card.

The Currents screen shows information about a current station ① for a specific date and time, including the current speed and level ②. By default, the chartplotter shows current information for the most-recently viewed current station and for the present date and time.

From the Home screen, select **Information > Currents**.

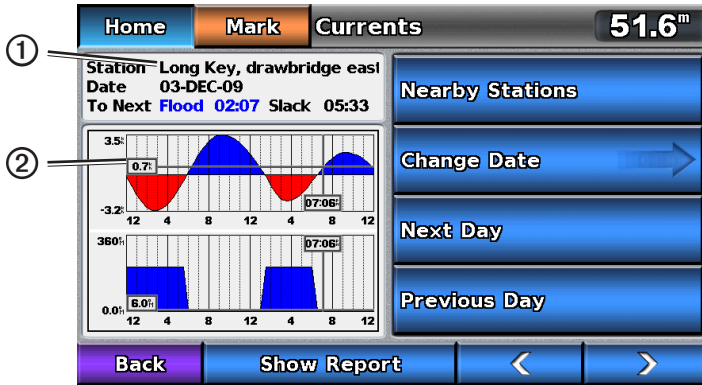

Current Station Information

### Viewing Information about a Nearby Current Station

**NOTE:** Current station information is available with a BlueChart g2 Vision card.

1. From the Home screen, select **Information > Currents > Nearby Stations**.
2. Select a station.

### Configuring Current Station Information

You can indicate the date of current station information to be viewed, and you can view the information in a chart or in a report format.

**NOTE:** Current station information is available with a BlueChart g2 Vision card.

1. From the Home screen, select **Information > Currents > Nearby Stations**.
2. Select a station.
3. Complete an action:
  - Select **Change Date > Manual** to view tide information for a different date, enter a date, and select **Done**.
  - Select **Show Report** to view the Current Report for the selected station. The report includes slack water, flood, and ebb levels.
  - Select **Next Day** to view current information for the day after the date shown.
  - Select **Previous Day** to view current information for the day before the date shown.
  - Select **<** or **>** to change the time in 4- to 5-minute intervals.

## Celestial Information

The Celestial screen shows information about sunrise, sunset, moonrise, moonset, the moon phase, and the approximate sky view location of the sun ① and moon ②. By default, the chartplotter shows celestial information for the present date and time. The center of the screen ③ represents the sky overhead, and the outermost rings ④ represent the horizon.

From the Home screen, select **Information > Celestial**.

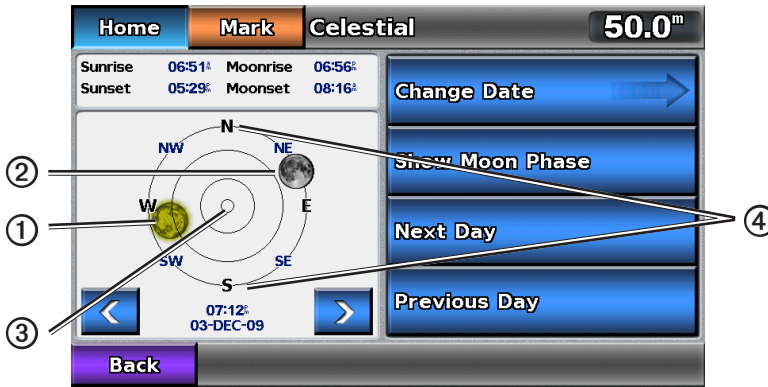

**Celestial Information**

### Viewing Celestial Information for a Different Date

You can select a date and time for which to view celestial information, and you can view the moon phase for the selected date and time.

1. From the Home screen, select **Information > Celestial**.
2. Complete an action:
  - Select **Change Date > Manual** to view information for a different date. Enter a date. Select **Done**.
  - Select **Show Moon Phase** to view the moon phase at the specified date and time.
  - Select **<** or **>** to change the time in 1-hour intervals.

### Viewing Tide, Current, and Celestial Information from the Navigation Chart.

1. From the Home screen, select **Charts > Navigation Chart**.
2. Select an area near a tide, current, or celestial information station.
3. Select **Information**.
4. Select **Tides, Currents, or Celestial**.

## On-boat Data

### Engine and Fuel Gauges

#### Viewing Engine Gauges

You must be connected to a NMEA 2000 network capable of sensing engine data to view engine gauges. See the *GPSMAP 700 Series Installation Instructions* for details.

From the Home screen, select **Information > Dashboard Gauges > Engine**.

#### Cycling Through Engine Gauge and Fuel Gauge Screens

1. From the Home screen, select **Information > Dashboard Gauges > Engine**.
2. Select the left and right arrows to move from one gauge screen to the next.
3. Repeat step 2 to cycle through all the engine gauge and fuel gauge screens.

#### Customizing Engine Gauge and Fuel Gauge Limits

To establish the upper and lower limits of a gauge, and the range of desired standard operation, you can configure up to four values for the engine gauge or the fuel gauge. When a value exceeds the range of standard operation, the gauge face or bar becomes red.

Setting	Description
Scale minimum	This value is less than the rated minimum, and it represents the lower limit of the gauge. This setting is not available on all gauges.
Scale maximum	This value is greater than the rated maximum, and it represents the upper limit of the gauge. This setting is not available on all gauges.
Rated minimum	Represents the minimum value of the standard operating range.
Rated maximum	Represents the maximum value of the standard operating range.

1. From the Home screen, select **Information > Dashboard Gauges > Engine > Menu > Gauge Setup > Set Gauge Limits**.
2. Select a gauge.
3. Select **Gauge Limits > Custom > Edit Limits**.
4. Select the gauge limit you want to set (**Scale Min, Scale Max, Rated Min, or Rated Max**).  
**NOTE:** Some of these options may not be available for all gauges.
5. Select the gauge limit.
6. Repeat steps 4 and 5 to set additional gauge limits.

### Activating Status Alarms for Engine Gauges and Fuel Gauges

If you have activated gauge status alarms, when the engine sends a warning status message over the NMEA 2000 network, a gauge status alarm message appears. The gauge face or bar may become red depending on the alarm type.

From the Home screen, select **Information > Dashboard Gauges > Engine > Menu > Gauge Setup > Status Alarms > On**.

### Customizing Engine and Fuel Gauge Status Alarms

1. From the Home screen, select **Information > Dashboard Gauges > Engine > Menu > Gauge Setup > Status Alarms > Custom**.
2. Select one or more engine gauge or fuel gauge alarms that you want to turn on or off.
3. Select **Back**.

### Selecting the Number of Engines Shown in Gauges

The engine gauges can show information for up to four engines.

1. From the Home screen, select **Information > Dashboard Gauges > Engine > Menu > Gauge Setup > Engine Selection > Number of Engines**.
2. Select the number of engines.
3. Complete an action:
  - Select **Back**.
  - Select **Edit Engines** and complete steps 2 through 5 of “Selecting the Engines Shown in Gauges” ([page 39](#)) to select the engines for which information appears in the gauges.

### Selecting the Engines Shown in Gauges

You must manually select the number of engines shown in the engine gauges ([page 39](#)) before you can select the engines for which information appears in the gauges.

1. From the Home screen, select **Information > Dashboard Gauges > Engine > Menu > Gauge Setup > Engine Selection > Edit Engines**.
2. Select **First Engine**.
3. Select the number of the engine for which you want to view information in the first gauge or bar.  
For example, if you select “3,” the first engine bar shows information for the engine identified as “Engine3” on the NMEA 2000 network.
4. Repeat step 3 for the second, third, and fourth engine bar, as needed.
5. Select **Back**.

## Viewing Fuel Gauges

To view fuel information, your chartplotter must be connected to an external fuel sensor, such as the Garmin GFS™ 10.

From the Home screen, select **Information > Dashboard Gauges > Engine**.

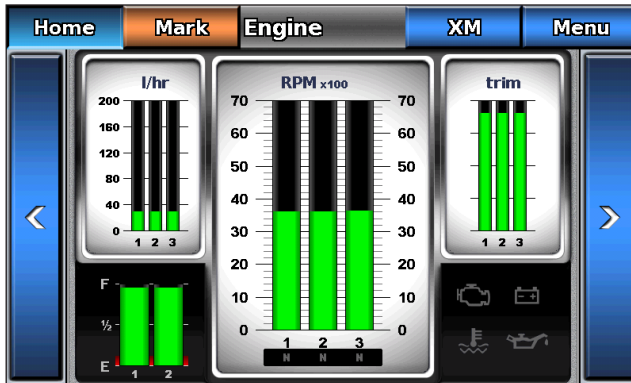

## Configuring Fuel Gauges

The amount of fuel on board can be represented by either the total fuel level (numeric) or by individual tank level (graphic).

1. From the Home screen, select **Information > Dashboard Gauges > Engine > Menu > Gauge Setup > Fuel Display**.
2. Complete an action:
  - Select **Use Total Fuel Level** to display a numeric value for the total fuel level.
  - Select **Use Fuel Tank Levels > Number of Fuel Tanks** to display a graphical representation of all the specified tanks.

## Customizing Gauge Limits

See “Customizing Engine and Fuel Gauge Limits” (page 38).

## Activating and Customizing Gauge Alarms

See “Activating Engine and Fuel Gauge Status Alarms” (page 39) and “Customizing Engine and Fuel Gauge Status Alarms” (page 39).

## Synchronizing Fuel Gauge Readings with Fuel Levels

1. From the Home screen, select **Information > Dashboard Gauges > Engine > Menu**.
2. Complete an action:
  - Select **Fill Up All Tanks** when your tanks are full. The fuel level is reset to maximum capacity. Adjust if necessary.
  - Select **Add Fuel To Boat** when you have added less than a full tank, enter the amount of fuel added, and select **Done**. An estimate of the fuel added appears. Adjust if necessary.
  - Select **Set Total Fuel Onboard** to specify the total fuel in your tanks, and select **Done**.

## Trip Gauges

### Viewing Trip Gauges

Trip gauges show information for odometer, speed, time, and fuel for your present trip.

From the Home screen, select **Information > Dashboard Gauges > Trip**.

## Resetting Trip Gauges

1. From the Home screen, select **Information > Dashboard Gauges > Trip > Menu**.
2. Complete an action:
  - Select **Reset Trip** to set all the readings for the present trip to 0.0.
  - Select **Reset Maximum Speed** to set the maximum speed reading to 0.0.
  - Select **Reset Odometer** to set the odometer reading to 0.0.
  - Select **Reset All** to set all the readings to 0.0.

## Compass

### Viewing the Compass

While you are navigating to a destination, the compass shows information about the distance you are off course, the distance to your final destination, the time to your next waypoint, and the distance to your next waypoint.

From the Home screen, select **Information > Dashboard Gauges > Compass**.

## Environmental Data

### Wind Gauges

#### Viewing Wind Gauges

From the Home screen, select **Information > Dashboard Gauges > Wind**.

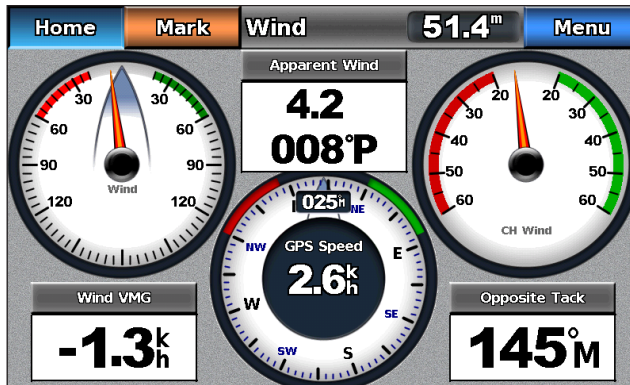

### Selecting True or Apparent Wind for the Wind Gauges

The chartplotter must be connected to the peripheral devices listed below to capture the data shown on the wind speed graph.

Wind Speed	Description	Required Sensors
Apparent Wind	Shows wind speed data based on the flow of air experienced while on a boat in motion.	A wind sensor.
True Wind	Shows wind speed data based on the flow of air experienced while on a stationary boat. For the most-accurate data, the <b>VMG Source</b> setting should be set to <b>Auto</b> (page 42).	A wind sensor and a water speed sensor; or a wind sensor and a GPS antenna.

1. From the Home screen, select **Information > Dashboard Gauges > Wind > Menu**.
2. Select **Show True Wind** or **Show Apparent Wind**.

### Configuring the VMG Source

You can specify the source of the velocity made good (VMG) data that is used to calculate true wind speed. Before you can configure the VMG source, the wind gauge must be set to **Show True Wind** (page 41). Water speed is the speed reading from a water-speed sensor, and GPS speed is calculated from your GPS position.

1. From the Home screen, select **Information > Dashboard Gauges > Wind > Menu > VMG Source**.
2. Complete an action:
  - Select **GPS Speed**.
  - Select **Water Speed**.
  - Select **Auto** to allow your chartplotter to select the source.

### Configuring the Wind Speed Source

You can specify whether the vessel speed data displayed on the compass is based on water speed or GPS speed. Water speed is the speed reading from a water-speed sensor, and GPS speed is calculated from your GPS position.

1. From the Home screen, select **Information > Dashboard Gauges > Wind > Menu**.
2. Complete an action:
  - Select **Speed Display > GPS Speed** to display the speed of the vessel based upon GPS readings.
  - Select **Speed Display > Water Spd** to display the speed of the vessel based upon the reading from a water speed sensor.

### Configuring the Heading Source of the Wind Gauge

You can specify the source of the heading displayed on the wind gauge. Magnetic heading is the heading data received from a heading sensor, and GPS heading is calculated by your chartplotter GPS (course over ground).

1. From the Home screen, select **Information > Dashboard Gauges > Environment > Menu**.
2. Complete an action:
  - Select **Heading Source > GPS Hdg**.
  - Select **Heading Source > Magnetic**.

### Selecting the Range of the Close Hauled Wind Gauge

You can specify the range of the close hauled wind gauge for both the upwind scale and the downwind scale.

1. From the Home screen, select **Information > Dashboard Gauges > Wind > Menu**.
2. Complete an action:
  - Select **Change Upwind Scale**. Set the maximum and minimum values that appear when the upwind close hauled wind gauge appears.
  - Select **Change Downwind Scale**. Set the maximum and minimum values that appear when the downwind close hauled wind gauge appears.

## Environment Gauges

### Viewing Environment Gauges

From the Home screen, select **Information > Dashboard Gauges > Environment**.

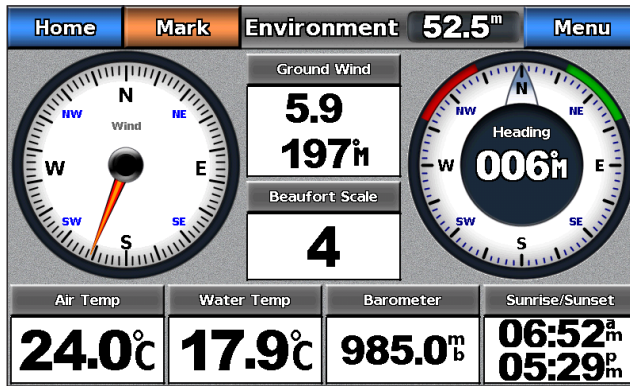

### Configuring the Alignment of the Wind Gauge

You can specify the alignment of the wind gauge on the Environment page.

1. From the Home screen, select **Information > Dashboard Gauges > Environment > Menu**.
2. Complete an action:
  - Select **Alignment > North Up** to set the top of the wind gauge to a north heading.
  - Select **Alignment > Head Up** to set the wind gauge to rotate to match the orientation of the compass display.

### Configuring the Heading Source of the Wind Gauge

See (page 42).

### Setting the Barometer Reference Time

You can specify the reference time used to calculate the barometer trend. The trend is indicated in the barometer field.

From the Home screen, select **Information > Dashboard Gauges > Environment > Menu > Pressure Ref. Time**.

# Device Configuration

## Basic Device Configuration Questions

Question	Answer
How do I adjust the amount of detail shown on the map?	See “Changing the Map Zoom Detail” (page 8).
How do I change the time zone setting?	See “Configuring the Time” (page 47).
How do I change the language setting?	See “Setting the Language” (page 45).
How do I adjust the brightness of the backlight?	See “Adjusting the Backlight” (page 2).
How do I show a compass tape at the top of the chart?	See “Showing the Compass Tape on a Chart” (page 49).
How do I change the color of the active track?	See “Setting the Color of the Active Track” (page 31).
How do I delete the track log on the map?	See “Clearing the Active Track” (page 31).
How do I transfer waypoints to a memory card?	See “Chartplotter Data Management” (page 52).
How do I erase all waypoints, route, and tracks?	See “Deleting All Saved Waypoints, Routes, and Tracks” (page 32).
How do I check the software version and the map version on the chartplotter?	See “Viewing System Information” (page 3).

## Simulator Mode

### WARNING

Do not try to navigate using simulator mode because the GPS receiver is turned off. Any satellite signal strength bars shown are simulations and do not represent the strength of actual satellite signals.

Simulator mode turns the GPS receiver off for use indoors or for practice using the chartplotter. The chartplotter does not track satellites in simulator mode.

### Turning Simulator Mode On

From the Home screen, select **Configure > System > Simulator > On**.



### Configuring Simulator Mode

- From the Home screen, select **Configure > System > Simulator > Setup**.
- Complete an action:
  - Select **Speed**, enter the speed of your boat in simulator mode, and select **Done**.
  - Select **Track Control**. Select **Auto Track** to allow the chartplotter to set the heading automatically, or select **User Track** to set the heading manually.
  - Select **Set Position**, select the simulated position of your boat, and select **Select**.
  - Select **Set Time**, enter the simulated time, and select **Done**.
  - Select **Set Date**, enter the simulated date, select **Done**.

## Turning the Chartplotter On Automatically

You can set the chartplotter to turn on when power is applied. Otherwise, the chartplotter must be turned on using .

From the Home screen, select **Configure > System > Auto Power > On**.

**NOTE:** If Auto Power is **On** and the chartplotter is turned off using , and power is removed and reapplied within less than two minutes, you may have to press  to restart the chartplotter.



## Display Configuration

### Setting the Sound

You can set when the chartplotter makes audible sounds.

1. From the Home screen, select **Configure > System > Beeper/Display > Beeper**.
2. Complete an action:
  - Select **Alarms Only** to have the chartplotter beep only when alarms are triggered (default).
  - Select **On (Touch and Alarms)** to have the chartplotter beep when the screen is touched and when alarms are triggered.

### Setting the Language

You can select the language that appears on the chartplotter.

1. From the Home screen, select **Configure > System > Language**.
2. Select a language.

## Navigation Preferences

### Route Settings

#### Selecting a Route Label Type

You can select the type of labels shown with route turns on the map.

1. From the Home screen, select **Configure > Navigation > Route Labels**.
2. Complete an action:
  - Select **Show Name** to identify route turns using waypoint names.
  - Select **Show Number** to identify route turns using numbers, such as Turn 1 and Turn 2.

#### Configuring Route Turn Transitions

You can set how much time, or how far, before a turn in a route that you transition to the next leg. Raising this value can help improve the accuracy of the autopilot when navigating a route or an Auto Guidance line with many frequent turns, or at higher speeds. For straighter routes or slower speeds, lowering this value can improve autopilot accuracy.

1. From the Home screen, select **Configure > Navigation > Turn Transition Activation**.
2. Complete an action:
  - Select **Time > Turn Transition Time**, and enter the time.
  - Select **Distance > Turn Transition Distance**, and enter the distance.
3. Select **Done**.

#### Configuring Speed Data Sources

You can specify the source of the speed data that is used to calculate true wind speed or fuel economy. Water speed is the speed reading from a water-speed sensor, and GPS speed is calculated from your GPS position.

1. From the Home screen, select **Configure > System > Speed Sources**.
2. Complete an action:
  - Select **Wind**, and indicate if the calculated wind speed data comes from a **Water Speed** sensor, if it is based on the **GPS Speed**, or whether the chartplotter selects a speed data source automatically.
  - Select **Fuel Economy**, and indicate whether the speed data that is used to calculate fuel economy comes from a **Water Speed** sensor or is based on the **GPS Speed**.

#### Auto Guidance Line Configurations

You can set the parameters the chartplotter uses when calculating an Auto Guidance line.

**NOTE:** Auto Guidance is available with a preprogrammed BlueChart g2 Vision data card.

## Safe Water Depth and Safe Obstacle Height

### CAUTION

The **Safe Depth** and **Safe Height** settings influence how the chartplotter calculates an Auto Guidance line. If an area has an unknown water depth or an unknown obstacle height, the Auto Guidance line is not calculated in that area. If an area at the beginning or the end of an Auto Guidance line is shallower than the safe water depth or lower than the safe obstacle height, the Auto Guidance line is not calculated in that area. On the chart, the course through those areas appears as a gray line. When your boat enters one of those areas, a warning message appears.

### Setting the Safe Water Depth and the Safe Obstacle Height

1. From the Home screen, select **Configure > Navigation > Auto Guidance**.
2. Select **Safe Depth** to set the minimum depth (chart depth datum) the chartplotter uses when calculating an Auto Guidance line.
3. Enter the minimum safe depth.
4. Select **Done**.
5. Select **Safe Height** to set the minimum height (chart height datum) of a bridge that your boat can safely travel under.
6. Enter the minimum safe height.
7. Select **Done**.

### Shoreline Distance Auto Guidance Setting

The Shoreline Distance setting indicates how close to the shore you want the Auto Guidance line to be placed. The Auto Guidance line may move if you change this setting while navigating.

### Setting the Distance from Shore

The available values for the Shoreline Distance setting (Nearest, Near, Normal, Far, or Farthest) are relative, not absolute. To ensure that the Auto Guidance line is placed the appropriate distance from shore, you can assess the placement of the Auto Guidance line using one or more familiar destinations that require navigation through a narrow waterway.

1. Dock your boat or drop anchor.
2. From the Home screen, select **Configure > Navigation > Auto Guidance > Shoreline Distance > Normal**.
3. From the Home screen, select **Charts > Navigation Chart**.
4. Select a destination that you have navigated to previously.
5. Select **Navigate To > Guide To**.
6. Review the placement of the Auto Guidance line. Determine whether the line safely avoids known obstacles, and whether the turns enable efficient travel.
7. Complete an action:
  - If the placement of the Auto Guidance line is satisfactory, select **Menu > Stop Navigation**. Proceed to step 11.
  - If the Auto Guidance line is too close to known obstacles, from the Home screen, select **Configure > Navigation > Auto Guidance > Shoreline Distance > Far**.
  - If the turns in the Auto Guidance line are too wide, from the Home screen, select **Configure > Navigation > Auto Guidance > Shoreline Distance > Near**.
8. If you selected **Near** or **Far** in step 7, review the placement of the Auto Guidance line. Determine whether the line safely avoids known obstacles, and whether the turns enable efficient travel.

Auto Guidance maintains a wide clearance from obstacles in open water, even if you set the Shoreline Distance setting to **Near** or **Nearest**. As a result, the chartplotter may not reposition the Auto Guidance line, unless the destination selected in step 3 requires navigation through a narrow waterway.

9. Complete an action:
  - If the placement of the Auto Guidance line is satisfactory, select **Menu > Stop Navigation**. Proceed to step 11.
  - If the Auto Guidance line is too close to known obstacles, from the Home screen, select **Configure > Navigation > Auto Guidance > Shoreline Distance > Farthest**.
  - If the turns in the Auto Guidance line are too wide, from the Home screen, select **Configure > Navigation > Auto Guidance > Shoreline Distance > Nearest**.
10. If you selected **Farthest** or **Nearest** in step 9, review the placement of the Auto Guidance line. Determine whether the line safely avoids known obstacles, and whether the turns enable efficient travel.
 

Auto Guidance maintains a wide clearance from obstacles in open water, even if you set the Shoreline Distance setting to **Near** or **Nearest**. As a result, the chartplotter may not reposition the Auto Guidance line, unless the destination selected in step 4 requires navigation through a narrow waterway.
11. Repeat steps 1–10 at least once more, using a different destination each time, until you are familiar with the functionality of the Shoreline Distance setting.

### Setting the Heading Reference

You can set the directional reference used in calculating heading information.

1. From the Home screen, select **Configure > Units > Heading**.
2. Complete an action:
  - Select **Auto Mag Var** (automatic magnetic variation) to set the magnetic declination for your location automatically.
  - Select **True** to set true north as the heading reference.
  - Select **Grid** to set grid north as the heading reference (000°).
  - Select **User Mag Var** to set the magnetic variation value manually, enter the magnetic variation, and select **Done**.

### Coordinate Systems

#### Setting the Position Format or the Map Datum Coordinate Systems

You can set the position format in which a given location reading appears, and the coordinate system on which the map is structured. The default coordinate system is WGS 84.

**NOTE:** Do not change the position format or the map datum coordinate system unless you are using a map or chart that specifies a different position format.

1. From the Home screen, select **Configure > Units**.
2. Complete an action:
  - Select **Position Format** to set the position format in which a given location reading appears, and select a position format.
  - Select **Map Datum** to set the coordinate system on which the map is structured, and select a coordinate system.

### Configuring the Time

1. From the Home screen, select **Configure > Units > Time**.
2. Complete an action:
  - Select **Time Format** to set a time-keeping standard, and select **12 Hour**, **24 Hour**, or **UTC** (universal time coordinate).
  - Select **Time Zone > Auto Time Zone** to allow the chartplotter to set the time zone automatically.
  - Select **Time Zone > Custom Time Zone** to set the time zone manually, enter the time zone hour adjustment, and select **Done**.

## Units of Measure

You can set the units of measure the chartplotter shows, using a standardized system of measurements or creating a customized system of measurements.

### Selecting a Standardized System of Measurement

1. From the Home screen, select **Configure > Units > System Units**.
2. Select **Statute (mh, ft, °F)**, **Metric (kh, m, °C)**, or **Nautical (kt, ft, °F)**.

### Creating a Customized System of Measurement

You must be receiving NMEA Sonar depth data or using an “S” series chartplotter (such as a GPSMAP 720s) with a built-in sounder to view depth and temperature information.

You can select individual units of measure to create a customized system of measurement for your chartplotter display.

1. From the Home screen, select **Configure > Units > System Units > Custom**.
2. Complete an action:
  - Select **Depth**, and select **Feet**, **Fathoms**, or **Meters**.
  - Select **Temperature**, and select **Fahrenheit (°F)** or **Celsius (°C)**.
  - Select **Distance**, and select **Miles**, **Kilometers**, **Nautical (nm, ft)** or **Nautical (nm, m)**.
  - Select **Speed > Vessel Speed**, and select **Miles Per Hour**, **Kilometers Per Hour**, or **Knots**.
  - Select **Speed > Wind Speed**, and select **Miles Per Hour**, **Meters Per Sec**, or **Knots**.
  - Select **Elevation**, and select **Feet** or **Meters**.
  - Select **Volume**, and select **Litres**, **US Gallons**, or **UK Gallons**.
  - Select **Pressure > Gauge Pressure**, and select **kPa** or **psi**.
  - Select **Pressure > Atmospheric Pressure**, and select **Millibars** or **Inches of Mercury**.

## About Chart Overlay Numbers

Overlay numbers with data fields ① can appear on specific charts, 3D charts, radar views (page 66), and combination screens (page 22). The data overlay for each chart or 3D chart view can be configured separately.

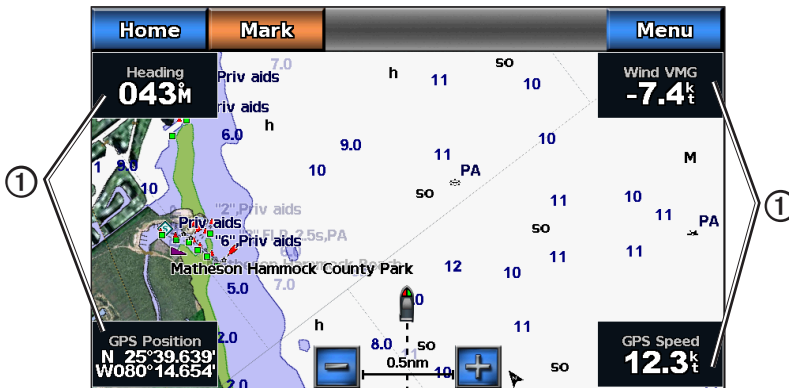



**Navigation Chart with Data Overlay**

Several data overlays are available. You can select the data fields to be shown within each data overlay.



When overlay numbers are displayed on the chart, the navigation inset is shown during navigation. The compass tape can be shown or hidden in each overlay.

### Selecting a Data Overlay

1. From the Home screen, select **Charts**.
2. Select a chart or a 3D chart view.
3. Select **Menu**.
4. Complete an action:
  - Select **Navigation Chart Setup > Overlay Numbers**.
  - Select **Fishing Chart Setup > Overlay Numbers**.
  - Select **Overlay Numbers**.
5. Select  or  to select a data overlay.



### Configuring Data Fields on a Chart

You can select the type of data shown within a data field.

1. From the Home screen, select **Charts**.
2. Select a chart or a 3D chart view.
3. Select **Menu**.
4. Complete an action:
  - Select **Navigation Chart Setup > Overlay Numbers**.
  - Select **Fishing Chart Setup > Overlay Numbers**.
  - Select **Overlay Numbers**.
5. Select  or  to select a data overlay.
6. Touch a data field.
7. Select a category of data.
8. Select the data that will be displayed.

### Configuring the Navigation Inset on a Chart

The navigation inset is shown only when the boat is navigating to a destination.

1. From the Home screen, select **Charts**.
2. Select a chart or a 3D chart view.
3. Select **Menu**.
4. Complete an action:
  - Select **Navigation Chart Setup > Overlay Numbers**.
  - Select **Fishing Chart Setup > Overlay Numbers**.
  - Select **Overlay Numbers**.
5. Select  or  to select a data overlay.
6. Select **Navigation Inset > Nav. Inset Config**.
7. Complete an action:
  - Select **Route Leg Details > On** to show waypoint velocity made good (VMG) when navigating a route with more than one leg.
  - Select **Next Turn > Distance** to show next-turn data based on distance.
  - Select **Next Turn > Time** to show next-turn data based on time.
  - Select **Destination**, and select **Distance**, **Time to Destination**, or **Arrival** to indicate how the destination data appears.

### Showing the Compass Tape on a Chart

The compass tape appears in a row across the top of a chart or a 3D chart view. It shows the present heading, and an indicator that shows the bearing to the desired course appears while navigating.

1. From the Home screen, select **Charts**.
2. Select a chart or a 3D chart view.
3. Select **Menu**.

4. Complete an action:
  - Select **Navigation Chart Setup > Overlay Numbers**.
  - Select **Fishing Chart Setup > Overlay Numbers**.
  - Select **Overlay Numbers**.
5. Select **Show Compass Tape**.

### Using the Speed Filter

The speed filter averages the speed of your boat over a short period of time for smoother speed values.

1. From the Home screen, select **Configure > System > GPS**.
2. Complete an action:
  - Select **Speed Filter > On** to keep the speed filter on continuously, enter the speed filter time duration and select **Done**.
  - Select **Speed Filter > Auto** to allow the unit to provide the optimal performance as required by your situation, such as traveling at a constant speed or frequently changing speeds.

### Other Vessels

You can show and configure information about other vessels for the Navigation chart, the Fishing chart, Perspective 3D, or Mariner's Eye 3D.

**NOTE:** To configure Automatic Identification System (AIS) information for other vessels, your chartplotter must be connected to an external AIS device.

### Viewing a List of AIS Targets

See "Viewing a List of AIS Targets" ([page 15](#)).

### Configuring the Appearance of Other Vessels

**NOTE:** The Mariner's Eye 3D chart is available if you use a BlueChart g2 Vision SD card. The Fishing chart is available if you use a BlueChart g2 Vision SD card or a BlueChart g2 SD card, or if your built-in map supports Fishing charts.

1. From the Home screen, select **Charts**.
2. Select **Navigation Chart, Fishing Chart, Perspective 3D, or Mariner's Eye 3D**.
3. Select **Menu > Other Vessels > AIS Display Setup**.
4. Complete an action:
  - Select **AIS List** to view a list of AIS targets ([page 12](#)).
  - Select **DSC List** to view a log of the most-recent DSC calls and other DSC contacts you have entered ([page 79](#)).
  - Select **AIS Display Setup** to configure how AIS vessels are shown on a chart ([page 14](#)).
  - Select **DSC Trails** to show the tracks of DSC vessels, and select the length of the track that appears using a trail ([page 82](#)).
  - Select **AIS Alarm** to set up a safe-zone collision alarm for AIS vessels ([page 15](#)).

## Information about Your Boat

### Calibrating a Water Speed Device

If you have a speed-sensing transducer, you can calibrate that speed-sensing device.

1. From the Home screen, select **Configure > My Boat > Calibrate Water Speed**.
2. Follow the on-screen instructions.

**NOTE:** If the boat is not moving fast enough or the speed sensor is not registering a speed, a "Speed too low" message appears. Select **OK**, and safely increase the boat speed. If the message appears again, stop the boat, and ensure that the speed-sensor wheel is not stuck. If the wheel turns freely, check the cable connections. If you continue to get the message, contact Garmin Product Support.

## Setting the Fuel Capacity of Your Boat

1. From the Home screen, select **Configure** > **My Boat** > **Fuel Capacity**.
2. Enter the combined fuel capacity of all the engines on your boat.
3. Select **Done**.

## Alarms

By default, all alarms are turned off, except the destination and weather alarms. The chartplotter must be on for the alarms to work.

**NOTE:** See the *GPSMAP 700 Series XM WX Satellite Weather® and XM Satellite Radio Supplement* (North America only) for information concerning weather alarms.

### Navigation Alarms

#### Setting an Arrival Alarm

You can set an alarm to sound when you are within a specified distance or time from a turn or a destination waypoint.

1. From the Home screen, select **Configure** > **Alarms** > **Navigation** > **Arrival**.
2. Complete an action:
  - Select **Type**, and indicate whether you want arrival alarms to sound only when nearing **Destinations**, or when nearing **Destinations and Turns**.
  - Select **Activation**, and indicate whether the arrival alarm triggers based on **Time** to arrival or based on **Distance** to arrival.
  - Select **Change Time** (if Activation is set to **Time**) or **Change Distance** (if Activation is set to **Distance**) to indicate how long before arrival (in minutes) or how far before arrival (in units of distance) the alarm should sound. Enter the time or distance, and select **Done**.

#### Setting the Anchor Drag Alarm

You can set an alarm to sound when you exceed a specified drift distance while anchored.

1. From the Home screen, select **Configure** > **Alarms** > **Navigation** > **Anchor Drag** > **On**.
2. Enter the drift distance that triggers the alarm.
3. Select **Done**.

#### Setting the Off Course Alarm

You can set an alarm to sound when you are off course by a specified distance.

1. From the Home screen, select **Configure** > **Alarms** > **Navigation** > **Off Course** > **On**.
2. Enter the off-course distance that triggers the alarm.
3. Select **Done**.

### System Alarms

#### Setting the Clock Alarm

You can set an alarm using the system (GPS) clock.

1. From the Home screen, select **Configure** > **Alarms** > **System** > **Clock** > **On**.
2. Enter the time that triggers the alarm.
3. Select **Done**.

#### Setting the Unit Voltage Alarm

You can set an alarm to sound when the battery reaches a specified low voltage.

1. From the Home screen, select **Configure** > **Alarms** > **System** > **Unit Voltage** > **On**.
2. Enter the voltage that triggers the alarm.
3. Select **Done**.

### Setting the GPS Accuracy Error Alarm

You can set an alarm to sound when the GPS location accuracy falls outside the user-defined value.

1. From the Home screen, select **Configure > Alarms > System > GPS Accuracy > On**.
2. Enter the GPS location accuracy that triggers the alarm.
3. Select **Done**.

### Setting the Total Fuel Onboard Alarm

The chartplotter must be connected to an external fuel sensor to capture fuel data.

You can set an alarm to sound when the total amount of remaining onboard fuel reaches the level you specify.

1. From the Home screen, select **Configure > Alarms > Fuel > Total Fuel Onboard > On**.
2. Enter the amount of fuel that triggers the alarm.
3. Select **Done**.

### Collision Alarm

See “Setting the Safe-zone Collision Alarm” ([page 15](#)).

### Setting Sonar Alarms

See “Sonar Alarms” ([page 77](#)).

### Setting Weather Alarms

See the *GPSMAP 700 Series XM WX Satellite Weather® and XM Satellite Radio Supplement* (North America only).

## Chartplotter Data Management

### Copying Waypoints, Routes, and Tracks to a Chartplotter

Before you copy MapSource® or HomePort data to a chartplotter, you must complete the following actions:

- The first time that you use a memory card to copy HomePort or MapSource® data to a chartplotter, you must prepare the memory card by inserting it into the chartplotter and allowing the chartplotter to place a file on it. This file provides information to HomePort or to MapSource to format the data.
  - Check the MapSource version on your computer by clicking **Help > About MapSource**. If the software version is older than 6.12.2, update to the current version by clicking **Help > Check for Software Updates**.
1. Complete an action:
    - Copy the data from HomePort to the prepared memory card (using an SD card reader attached to the computer) according to the process described in the HomePort Help system.
    - Copy the data from MapSource to the prepared memory card (using an SD card reader attached to the computer) according to the process described in the MapSource Help system.
  2. Copy the data from the data card to the chartplotter. See “Copying Data from a Data Card” ([page 52](#)).

### Copying Data from a Data Card

1. Insert a data card into the SD card slot on the chartplotter.
2. From the Home screen, select **Information > User Data > Data Transfer > Card**.
3. Complete an action:
  - Select **Merge From Card** to transfer data from the data card to the chartplotter and combine it with existing user data.
  - Select **Replace From Card** to transfer data from the data card to the chartplotter and overwrite existing user data on the chartplotter.
4. Select the file name from the list if multiple files are listed.



## Copying Waypoints, Routes, and Tracks to a Memory Card

1. Insert a memory card into the SD card slot on the chartplotter.
2. From the Home screen, select **Information > User Data > Data Transfer > Card > Save To Card**.
3. Select an action to indicate the name of the new file:
  - Select a file name from the list.
  - Select **Add New File** to create a new file enter the file name, and select **Done**.
4. Select **Save To Card**.

The file name is saved with a .ADM extension.

## Copying Built-in Maps to a Memory Card

You can copy maps from the chartplotter to a memory card for use with HomePort.

1. Insert a memory card into the SD card slot on the chartplotter.
2. From the Home screen, select **Information > User Data > Data Transfer > Card**.
3. Select **Copy Built-In Map** to copy the maps loaded onto your chartplotter to the memory card.

## Copying Waypoints, Routes, and Tracks to or from all Chartplotters on a NMEA 2000 Network

You can transfer information for waypoints, routes, and tracks from one chartplotter connected to a NMEA 2000 network to every other chartplotter connected to the network. The transfer may take a long time, depending on the number of waypoints being transferred.

1. From the Home screen, select **Information > User Data > Data Transfer > NMEA 2000**.
2. Complete an action:
  - Select **Clone User Data** to transfer data from the chartplotter to the other chartplotters connected to the network. Existing data is overwritten on those chartplotters.
  - Select **Merge User Data** to transfer data between all the chartplotters connected to the network. Unique data is combined with existing data on every chartplotter.

## Backing Up Data to a Computer

1. Insert a memory card into the SD card slot on the chartplotter.
2. From the Home screen, select **Information > User Data > Data Transfer > Card > Save to Card**.
3. Complete one of the following actions to indicate the name of the file to be backed up:
  - Select a file name from the list.
  - Select **Add New File** to create a new file, enter the file name, and select **Done**.
4. Select **Save To Card**.
 

The file name is saved with a .ADM extension.
5. Remove the memory card from the chartplotter and insert it into an SD card reader attached to a computer.
6. From Windows® Explorer, open the Garmin\UserData folder on the memory card.
7. Copy the backup file on the card and paste it to any location on the computer.

## Restoring Backup Data to a Chartplotter

1. Insert a memory card into an SD card reader that is attached to the computer.
2. Copy a backup file from the computer to the memory card, into a folder named Garmin\UserData.
3. Insert the memory card into the SD card slot on the chartplotter.
4. From the Home screen, select **Information > User Data > Data Transfer > Card > Replace From Card**.

## Radar

### WARNING

The marine radar transmits microwave energy that has the potential to be harmful to humans and animals. Before beginning radar transmission, verify that the area around the radar is clear. The radar transmits a beam approximately 12° above and below a line extending horizontally from the center of the radar. Avoid looking directly at the radar, because the eyes are the most-susceptible parts of the body.

When you connect your chartplotter to an optional Garmin marine radar such as a GMR™ 404/406 or a GMR 18/24, you can view more information about your surroundings.

The GMR transmits a narrow beam of microwave energy as it rotates in a 360° pattern. When the transmitted energy contacts a target, some of that energy is reflected back to the radar.

### Transmitting Radar Signals

1. With the chartplotter off, connect your radar as described in the radar installation instructions.
2. Turn on the chartplotter.

The radar warms up and a countdown is provided to alert you when the radar is ready.

**NOTE:** As a safety feature, the radar enters standby mode after it warms up. This gives you an opportunity to verify that the area around the radar is clear before beginning radar transmission.

3. From the Home screen, select **Radar**.
4. Select **Cruising**, **Harbor**, **Offshore**, or **Sentry**.  
A countdown message appears while the radar is starting up, and the “Ready to Transmit” message appears.
5. Select **Transmit**.  
A “Spinning Up” message appears for a few moments, and the radar begins painting an image.

### Stopping the Transmission of Radar Signals

From the Radar screen, select **To Standby**.

### Transmitting Radar Signals from any Screen

1. Press and release  to open the display screen.
2. Complete an action:
  - Select **Transmit Radar**.
  - Select **Radar to Standby**.

### Adjusting the Zoom Scale on the Radar Screen

The zoom scale, also called the radar range, represents the distance from your position (the center) to the outermost ring. Each ring represents an even division of the zoom scale. For example, if the zoom scale is set at three miles, each ring represents one mile from the center out.

Touch  and  to zoom out and zoom in.

## Radar Display Modes

The Radar screen has four standard operating modes. Each mode is available for use only with a compatible radar.

- **Cruising mode**—shows a full-screen image of the gathered radar information.
- **Harbor mode**—intended for use in inland waters, this mode works best with short-range radar signals (2 nm or less).
- **Offshore mode**—intended for use in open waters, this mode works best with long-range radar signals.
- **Sentry mode**—allows you to put the radar into timed-transmit mode, in which you can configure a radar transmit and standby cycle to conserve power. You can also enable a guard zone in Sentry mode, which identifies a safe zone around your boat.

Radar Mode	Compatible Radar			
	GMR 20, 21, 40, 41	GMR 18, 18 HD, 24, 24 HD	GMR 404, 406	GMR 604 xHD, 606 xHD, 1204 xHD, 1206 xHD
Cruising	X	X	X	
Harbor				X
Offshore				X
Sentry	X	X	X	X

### Cruising Mode

Cruising mode is the standard radar operation for the GMR 20, 21, 40, 41, 18, 18 HD, 24, 24 HD, 404, and 406 radar.

**NOTE:** If you switch from Sentry mode to Cruising mode, the radar switches to full-time transmission and disables all guard zones.

### Showing Cruising Mode

From the Home screen, select **Radar > Cruising**.

A full-screen image of the gathered radar information appears. Your position is in the center of the screen, and the range rings ① provide distance measurements. The distance between rings ② and the radar range ③ are shown on the bottom of the screen.

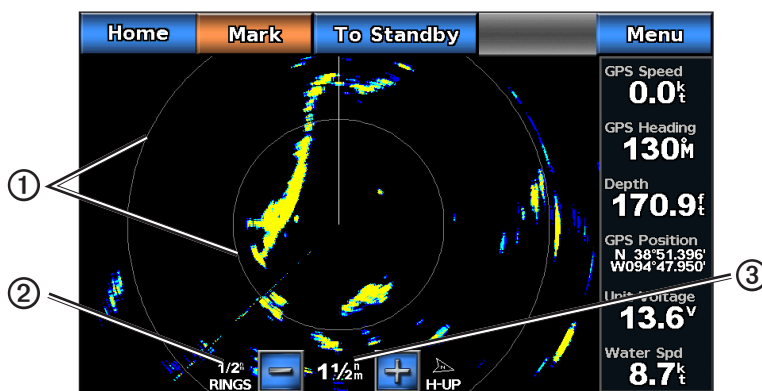

Cruising Mode

### Harbor Mode

Harbor mode is the standard radar operation for use in inland waters, with a GMR 604 xHD, 606 xHD, 1204 xHD, or 1206 xHD radar. Harbor mode works best with short-range radar signals (2 nm or less).

**NOTE:** If you switch from Sentry mode to Harbor mode, the radar switches to full-time transmission and disables all guard zones.

#### Showing Harbor Mode

From the Home screen, select **Radar > Harbor**.

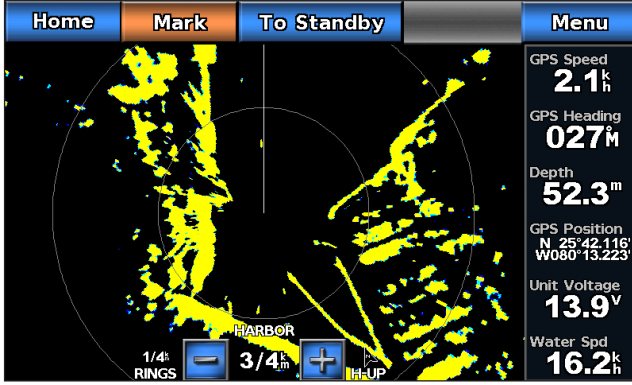

Harbor Mode

### Offshore Mode

Offshore mode is the standard radar operation for use in open waters, with a GMR 604 xHD, 606 xHD, 1204 xHD, or 1206 xHD radar.

**NOTE:** If you switch from Sentry mode to Offshore mode, the radar switches to full-time transmission and disables all guard zones.

#### Showing Offshore Mode

From the Home screen, select **Radar > Offshore**.

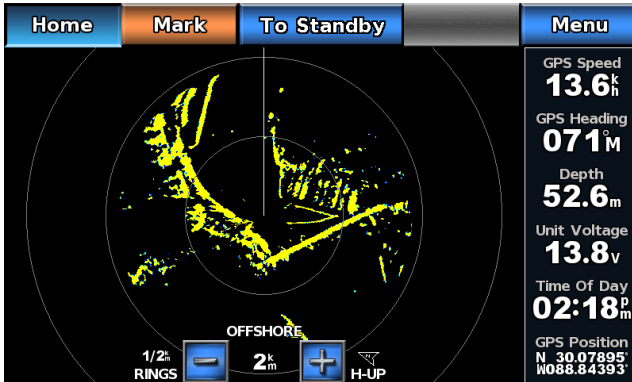

Offshore Mode

## Sentry Mode

Sentry mode allows you to put the radar into timed-transmit mode, in which you can configure a radar transmit and standby cycle to conserve power. You can also enable a guard zone in this mode, which identifies a safe zone around your boat and sounds an alarm when a radar object enters this zone. Sentry mode works with all Garmin GMR model radars.

### Showing Sentry Mode

From the Home screen, select **Radar > Sentry**.

### Enabling Timed Transmit

From the Home screen, select **Radar > Sentry > Menu > Sentry Setup > Timed Xmit > On**.

### Setting the Standby and Transmit Times

You must enable timed transmit before you can set the standby and transmit times ([page 57](#)).

To help conserve power, you can indicate the radar standby time and the transmit time to implement periodic radar signal transmissions at set intervals.

1. From the Home screen, select **Radar > Sentry > Menu > Sentry Setup**.
2. Select **Stdby Time**.
3. Enter the time interval between radar signal transmissions.
4. Select **Done**.
5. Select **Xmit Time**.
6. Enter the duration of each radar signal transmission.
7. Select **Done**.

### Enabling a Guard Zone

From the Home screen, select **Radar > Sentry > Menu > Sentry Setup > Enable Guard Zone**.

### Defining a Partial Guard Zone

You must enable a guard zone before you can define the boundaries of the zone ([page 57](#)).

You can define the boundaries of a guard zone that does not completely encompass your boat.

1. From the Home screen, select **Radar > Sentry > Menu > Sentry Setup > Adjust Guard Zone > Move Guard Zone > Corner 1**.
2. Touch and drag the location of the outer guard-zone corner (⊗).

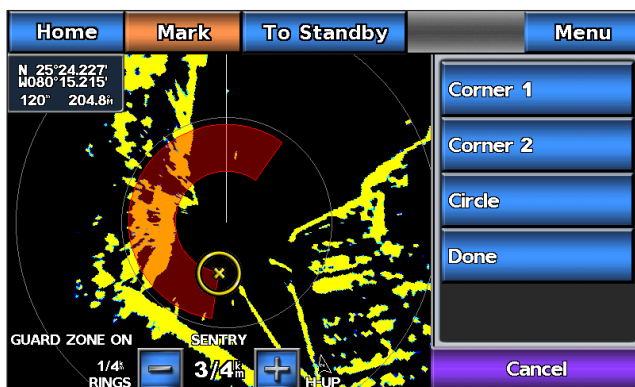

3. Select **Corner 2**.

4. Touch the location of the inner guard-zone corner.

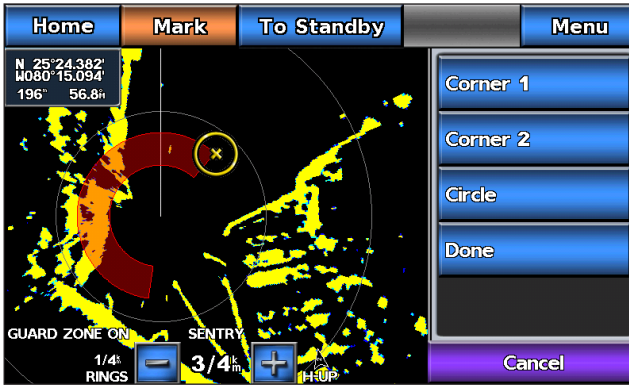

5. Select **Done**.

### Defining a Circular Guard Zone

You must enable a guard zone before you can define the boundaries of the zone ([page 57](#)).

You can define a circular guard zone that completely encompasses your boat.

1. From the Home screen, select **Radar > Sentry > Menu > Sentry Setup > Adjust Guard Zone > Move Guard Zone > Circle**.
2. Touch and drag the location of the outer guard-zone circle, (⊙).
3. Select **Corner 2**.
4. Touch and drag the location of the inner guard-zone corner.
5. Select **Circle**.

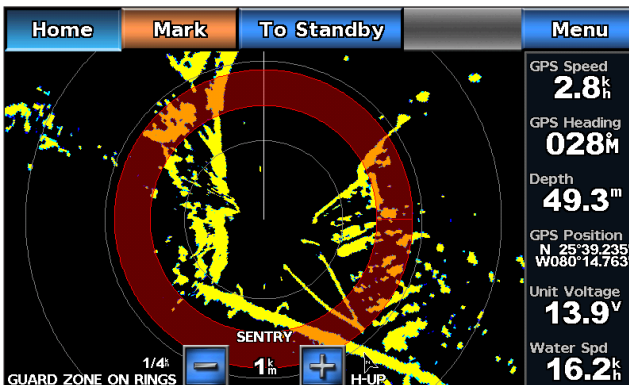

### Setting the Safe-zone Collision Alarm

See “Setting the Safe-zone Collision Alarm ([page 15](#)).

### Viewing a List of AIS Threats

From any radar view or the Radar Overlay, you can view and customize the appearance of a list of AIS threats.

1. From the Home screen, select **Radar**.
2. Select **Cruising, Harbor, Offshore, Sentry, or Radar Overlay**.
3. Select **Menu > Other Vessels > AIS List**.

### Showing AIS Vessels on the Radar Screen

AIS requires the use of an external AIS device and active transponder signals from other vessels.

You can configure how other vessels appear on the Radar screen. If any setting (except the AIS display range) is configured for one radar mode, the setting is applied to every other radar mode. The details and projected heading settings configured for one radar mode are applied to every other radar mode and to the Radar Overlay.

1. From the Home screen, select **Radar**.
2. Select **Cruising, Harbor, Offshore, or Sentry**.
3. Select **Menu > Other Vessels > AIS Display Setup**.
4. Complete an action:
  - Select **AIS Display Range** to indicate the distance from your location within which AIS vessels appear, and select a distance.
  - Select **Details > Show** to show details about AIS-activated vessels.
  - Select **Projected Heading**, enter the projected heading time for AIS-activated vessels, and select **Done**.
  - Select **Trails** to show the tracks of AIS vessels, and select the length of the track that appears using a trail.

### VRM and EBL

The variable range marker (VRM) and the electronic bearing line (EBL) measure the distance and bearing from your boat to a target object. On the Radar screen, the VRM appears as a circle that is centered on the present location of your boat, and the EBL appears as a line that begins at the present location of your boat and intersects the VRM. The point of intersection is the target of the VRM and the EBL.

#### Showing the VRM and the EBL

The VRM and the EBL configured for one mode are applied to all other radar modes.

1. From the Home screen, select **Radar**.
2. Select **Cruising, Harbor, or Offshore**.
3. Select **Menu > Show VRM/EBL**.

#### Adjusting the VRM and the EBL

You must show the VRM and the EBL before you can adjust them ([page 59](#)).

You can adjust the diameter of the VRM and the angle of the EBL, which moves the intersection point of the VRM and the EBL. The VRM and the EBL configured for one mode are applied to all other radar modes.

1. From the Home screen, select **Radar**.
2. Select **Cruising, Harbor, or Offshore**.
3. Select **Menu > Adjust VRM/EBL > Move VRM/EBL**.
4. Touch a new location for the intersection point of the VRM and the EBL.
5. Select **Done**.

#### Measuring the Range and Bearing to a Target Object

You must show the VRM and the EBL before you can adjust them ([page 59](#)).

The VRM and the EBL configured for one mode are applied to all other radar modes.

1. From the Home screen, select **Radar**.
2. Select **Cruising, Harbor, or Offshore**.
3. Select **Menu > Adjust VRM/EBL > Move VRM/EBL**.
4. Touch the target location.
 

The range and the bearing to the target location appear in the upper-left corner of the screen.
5. Select **Done**.

### Hiding the VRM and the EBL

1. From the Home screen, select **Radar**.
2. Select **Cruising, Harbor, or Offshore**.
3. Select **Menu > Adjust VRM/EBL > Hide VRM/EBL**.

### Measuring the Range and Bearing to a Target Object while VRM and EBL are Hidden

If you have hidden VRM and EBL ([page 60](#)), you can quickly display the range and bearing to a location by touching the screen.

1. From the Home screen, select **Radar**.
2. Select **Cruising, Harbor, or Offshore**.
3. Touch a location.
4. Select **Drop VRM/EBL**.

### Measuring the Distance to a Point on the Radar Screen

You can touch a point on the radar screen to display the distance and bearing of that location from your present location in the upper-left corner of the screen.

1. From the Home screen, select **Radar**.
2. Select **Cruising, Harbor, or Offshore**.
3. Touch a location on the screen.
4. Select **Measure Distance**.
5. If necessary, select **Set Reference** to measure from the selected location rather than your present location.

## Waypoints and Routes on the Radar Screen

### Marking a Waypoint on the Radar Screen

1. From the Home screen, select **Radar**.
2. Select a radar mode.
3. Touch a location.
4. Select **Create Waypoint**.

### Showing Waypoints on the Radar Screen

You can show waypoints that are within the range shown on the Radar screen. This setting does not apply to the Radar Overlay.

1. From the Home screen, select **Radar > Radar Setup > Appearance > Waypoints**.
2. Complete an action:
  - Select **Show** to show all waypoints.
  - Select **Navigation Only** to show only waypoints associated with the currently active route.

### Hiding Waypoints on the Radar Screen

You can hide waypoints that are within the range shown on the Radar screen.

From the Home screen, select **Radar > Radar Setup > Appearance > Waypoints > Select Hide**.

### Navigating a Saved Route on the Radar Screen

Before you can browse a list of routes and navigate to one of them, you must record and save at least one route ([page 28](#)). Navigation lines must be showing in order to view a route on the Radar screen ([page 68](#)).

1. From the Home screen, select **Where To? > Routes**.
2. Select a route.
3. Select **Navigate To**.
4. Complete an action:
  - Select **Forward** to navigate the route from the starting point used when the route was created.
  - Select **Backward** to navigate the route from the destination point used when the route was created.
5. From the Home screen, select **Radar**.



6. Select **Cruising, Harbor, Offshore, or Sentry**.

The route appears as a magenta line, with the starting point, the destination, and turns indicated.

7. Review the course indicated by the magenta line.
8. Follow the magenta line along each leg in the route, steering to avoid land, shallow water, and other obstacles.

### Navigating Parallel to a Saved Route on the Radar Screen

Before you can browse a list of routes and navigate to one of them, you must record and save at least one route (page 28). Navigation lines must be showing in order to view a route on the Radar screen (page 68).

1. From the Home screen, select **Where To? > Routes**.
2. Select a route.
3. Select **Navigate To > Offset**.
4. Complete an action:
  - Select **Forward - Port** to navigate the route from the starting point used when the route was created, to the left of the original route.
  - Select **Forward - Starboard** to navigate the route from the starting point used when the route was created, to the right of the original route.
  - Select **Backward - Port** to navigate the route from the destination point used when the route was created, to the left of the original route.
  - Select **Backward - Starboard** to navigate the route from the destination point used when the route was created, to the right of the original route.
5. Enter the offset distance.
6. Select **Done**.
7. From the Home screen, select **Radar**.
8. Select **Cruising, Harbor, Offshore, or Sentry**.
 

The route appears as a magenta line, with the starting point, the destination, and turns indicated.
9. Review the course indicated by the magenta line.
10. Follow the magenta line along each leg in the route, steering to avoid land, shallow water, and other obstacles.

### About the Radar Overlay

The Radar Overlay superimposes radar information on the Navigation chart or the Fishing chart. Data appears on the Radar Overlay based on the most-recently used radar mode (Cruising, Harbor, Offshore, or Sentry), and all settings configurations applied to the Radar Overlay are also applied to the last-used radar mode. For example, if you use Harbor mode and then you switch to the Radar Overlay, the Radar Overlay would show Harbor mode radar data. If you changed the gain setting using the Radar Overlay menu, the gain setting for Harbor mode would change automatically.

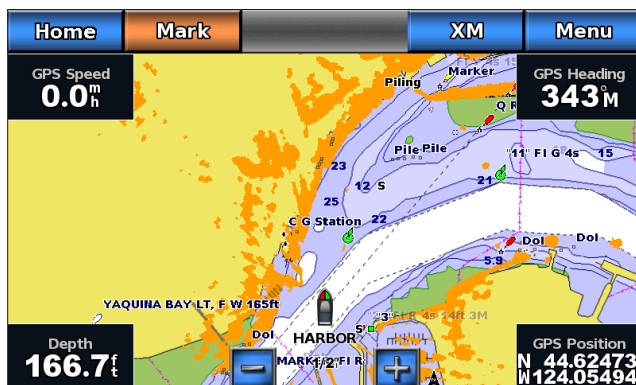

**Radar Overlay on the Navigation Chart**

## Radar Overlay and Chart Data Alignment

When using the Radar Overlay, the chartplotter aligns radar data with chart data based on the boat heading, which is based by default on data from a magnetic heading sensor connected using a NMEA 0183 or NMEA 2000 network. If a heading sensor is not available, the boat heading is based on GPS tracking data.

GPS tracking data indicates the direction in which the boat is moving, not the direction in which the boat is pointing. If the boat is drifting backward or sideways due to a current or wind, the Radar Overlay may not perfectly align with the chart data. This situation should be avoided by using boat-heading data from an electronic compass.

If the boat heading is based on data from a magnetic heading sensor or an automatic pilot, the heading data could be compromised due to incorrect setup, mechanical malfunction, magnetic interference, or other factors. If the heading data is compromised, the Radar Overlay may not align perfectly with the chart data.

## Showing the Radar Overlay

The Radar Overlay displays data based on the most-recently used radar mode.

From the Home screen, select **Radar > Radar Overlay**.

The radar picture appears in orange and overlays the Navigation chart.

## Zooming In and Out on the Radar Overlay

Zooming while panning the map only affects the zoom scale of the map. The radar range remains the same. Zooming while the map is locked on the boat (not panning) affects the zoom scale of the map and the radar range.

Touch the  and  buttons to zoom out and zoom in.

## Optimizing the Radar Display

You can optimize the radar display for each radar mode.

1. From the Home screen, select **Radar**.
2. Select **Cruising**, **Harbor**, **Offshore**, or **Sentry**.
3. Select a radar range ([page 62](#)).
4. Restore the default value of the gain setting ([page 63](#)).
5. Restore the default value of the sea clutter setting ([page 64](#)).
6. Restore the default value of the rain clutter setting ([page 65](#)).
7. Restore the default value of the FTC setting ([page 65](#)).
8. Restore the default value of the crosstalk setting ([page 66](#)).
9. Adjust the gain setting manually ([page 64](#)).
10. Adjust the sea clutter setting manually ([page 65](#)).
11. Adjust the rain clutter and FTC settings manually ([page 65](#)).

## About the Range of Radar Signals

The range of the radar signal indicates the length of the pulsed signal transmitted and received by the radar. As the range increases, the radar transmits longer pulses in order to reach distant targets. Closer targets, especially rain and waves, also reflect the longer pulses, which can add noise to the Radar screen. Viewing information about longer-range targets can also decrease the amount of space available on the Radar screen for viewing information about shorter-range targets.

### Tips for Selecting a Radar Range

- Determine what information you need to see on the radar display. For example, do you need information about nearby weather conditions or targets and traffic, or are you more concerned about distant weather conditions?
- Assess the environmental conditions in which the radar is being used. Especially in inclement weather, longer-range radar signals can increase the clutter on the Radar screen and make it more difficult to view information about shorter-range targets. In rain, shorter-range radar signals can enable you to view information about nearby objects more effectively, if the rain clutter and FTC settings are configured optimally.
- Select the shortest effective range, given your reason for using radar and the present environmental conditions.

### Selecting a Radar Range

See “Adjusting the Zoom Scale on the Radar Screen” ([page 54](#)).

### About Gain and Clutter

The gain controls the sensitivity of the radar receiver. The default setting for the gain, Auto, sets the gain automatically one time, based on average conditions, the range of the radar signal, and the selected radar mode. The chartplotter does not readjust the gain automatically in response to changing conditions. To optimize the radar appearance for specific conditions, manually adjust the gain ([page 64](#)).

Clutter is interference caused by the unwanted reflection of radar signals off of unimportant targets. Common sources of clutter include precipitation, sea waves, and nearby radar sources.

### Settings Configurations and Radar Type

When using a GMR 20, 21, 40, 41, 18, 18 HD, 24, 24 HD, 404, or 406, all gain and clutter settings configured for use in one radar mode are applied to every other radar mode and to the Radar Overlay.

When using a GMR 604 xHD, 606 xHD, 1204 xHD, or 1206 xHD radar, the gain, FTC, rain clutter, and sea clutter settings configured for use in one radar mode must be configured separately for each mode. Crosstalk settings configured for use in one mode are applied to every other radar mode. The last gain and clutter settings configured for use in any radar mode are applied to the Radar Overlay automatically. For example, if the gain for the Harbor mode is set to 50%, the gain for the Radar Overlay is set to 50% automatically. Later, if the gain for the Offshore mode is set to 40%, the gain for the Radar Overlay is set to 40% automatically.

### Default Gain and Clutter Settings

Setting	Default Value	Instructions
Gain	Auto	See “Automatically Adjusting Gain on the Radar Screen” ( <a href="#">page 63</a> ).
Sea Clutter	Calm, Medium, or Rough	See “Restoring the Default Sea Clutter Setting” ( <a href="#">page 64</a> ).
Rain Clutter	Off	See “Restoring the Default Rain Clutter Setting” ( <a href="#">page 65</a> ).
FTC	Off	See “Restoring the Default FTC Setting” ( <a href="#">page 65</a> ).
Crosstalk	On	See “Adjusting Crosstalk Clutter on the Radar Screen” ( <a href="#">page 66</a> ).

### Automatically Adjusting Gain on the Radar Screen

**Auto** is the default value for the gain setting. The automatic gain setting for each radar mode is optimized for that mode, and may differ from the automatic gain setting used for another mode.

**NOTE:** Depending upon the radar in use, the gain setting configured for use in one radar mode may or may not be applied to other radar modes or to the Radar Overlay ([page 63](#)).

1. From the Home screen, select **Radar**.
2. Select **Cruising**, **Harbor**, **Offshore**, or **Sentry** mode.
3. Select **Menu > Gain > Auto**.

The chartplotter sets the gain automatically once based on average conditions, the range of the radar signal, and the selected radar mode. The chartplotter does not readjust the gain automatically in response to changing conditions.

### Manually Adjusting Gain on the Radar Screen

For optimal radar performance that accounts for actual conditions, you can manually adjust the gain.

**NOTE:** Depending upon the radar in use, the gain setting configured for use in one radar mode may or may not be applied to other radar modes or to the Radar Overlay (page 63).

1. From the Home screen, select **Radar**.
2. Select **Cruising, Harbor, Offshore, or Sentry** mode.
3. Select **Menu > Gain**.
4. Select **Up** to raise the gain, until light speckles appear across the Radar screen.  
Data on the Radar screen is refreshed every few seconds. As a result, the effects of manually adjusting the gain may not appear instantly. Adjust the gain slowly.
5. Select **Down** to lower the gain until the speckles disappear.
6. If boats, land, or other targets are within range, select **Down** to lower the gain until the targets begin to blink.
7. Select **Up** to raise the gain until the boats, land, or other targets appear steadily lit on the Radar screen.
8. If necessary, minimize the appearance of nearby large objects (page 64).
9. If necessary, minimize the appearance of side-lobe echoes (page 64).

### Minimizing Nearby Large-object Interference

Nearby targets of significant size, such as jetty walls, can cause a very bright image of the target to appear on the Radar screen. This image can obscure smaller targets located near it.

**NOTE:** Depending upon the radar in use, the gain setting configured for use in one radar mode may or may not be applied to other radar modes or to the Radar Overlay (page 63).

1. From the Home screen, select **Radar**.
2. Select **Cruising, Harbor, Offshore, or Sentry** mode.
3. Select **Menu > Gain**.
4. Select **Down** to lower the gain until the smaller targets are clearly visible on the Radar screen.  
Reducing the gain to eliminate nearby large-object interference may cause smaller or more-distant targets to blink or disappear from the Radar screen.

### Minimizing Side-lobe Interference on the Radar Screen

Side-lobe interference may appear to streak outward from a target in a semi-circular pattern. Side-lobe effects can be avoided by reducing the gain or reducing the radar range.

**NOTE:** Depending upon the radar in use, the gain setting configured for use in one radar mode may or may not be applied to other radar modes or to the Radar Overlay (page 63).

1. From the Home screen, select **Radar**.
2. Select **Cruising, Harbor, Offshore, or Sentry** mode.
3. Select **Menu > Gain**.
4. Select **Down** to lower the gain until the semi-circular, streaked pattern disappears from the Radar screen.  
Reducing the gain to eliminate side-lobe interference may cause smaller or more-distant targets to blink or disappear from the Radar screen.

### Restoring the Default Sea Clutter Setting

**NOTE:** Depending upon the radar in use, the sea clutter setting configured for use in one radar mode may or may not be applied to other radar modes or to the Radar Overlay (page 63).

1. From the Home screen, select **Radar**.
2. Select **Cruising, Harbor, Offshore, or Sentry** mode.
3. Select **Menu > Noise Rejection > Sea Clutter > Presets**.
4. Select a setting that reflects present sea conditions: **Rough, Medium, or Calm**.

### Adjusting Sea Clutter on the Radar Screen

You can adjust the appearance of clutter caused by choppy sea conditions. The sea clutter setting affects the appearance of nearby clutter and targets more than it affects the appearance of distant clutter and targets. A higher sea clutter setting reduces the appearance of clutter caused by nearby waves, but it can also reduce or eliminate the appearance of nearby targets.

**NOTE:** Depending upon the radar in use, the sea clutter setting configured for use in one radar mode may or may not be applied to other radar modes or to the Radar Overlay ([page 63](#)).

1. From the Home screen, select **Radar**.
2. Select **Cruising, Harbor, Offshore, or Sentry** mode.
3. Select **Menu > Noise Rejection > Sea Clutter > Presets**.
4. Select a setting that reflects present sea conditions: **Rough, Medium, or Calm**.
5. Select **Menu > Noise Rejection > Sea Clutter**.
6. Select **Up** or **Down** to decrease or increase the appearance of sea clutter until other targets are clearly visible on the Radar screen.

Clutter caused by sea conditions may still be visible.

### Restoring the Default FTC Setting

**NOTE:** Depending upon the radar in use, the FTC setting configured for use in one radar mode may or may not be applied to other radar modes or to the Radar Overlay ([page 63](#)).

1. From the Home screen, select **Radar**.
2. Select **Harbor, Offshore, or Sentry** mode.
3. Select **Menu > Noise Rejection > FTC > Off**.

### Restoring the Default Rain Clutter Setting

**NOTE:** Depending upon the radar in use, the rain clutter setting configured for use in one radar mode may or may not be applied to other radar modes or to the Radar Overlay ([page 63](#)).

1. From the Home screen, select **Radar**.
2. Select **Cruising, Harbor, Offshore, or Sentry** mode.
3. Select **Menu > Noise Rejection > Rain Clutter > Off**.

### Adjusting Rain Clutter on the Radar Screen

You can adjust the appearance of clutter caused by rain. Reducing the radar range also can minimize rain clutter ([page 54](#)).

Setting	Description
FTC	This setting affects the appearance of large, hazy masses of clutter caused by rain at any distance.
Rain Clutter	This setting affects the appearance of nearby rain clutter and targets more than it affects the appearance of distant rain clutter and targets. A higher rain clutter setting reduces the appearance of clutter caused by nearby rain, but it can also reduce or eliminate the appearance of nearby targets.

**NOTE:** Depending upon the radar in use, the rain clutter and FTC settings configured for use in one radar mode may or may not be applied to other radar modes or to the Radar Overlay ([page 63](#)).

1. From the Home screen, select **Radar**.
2. Select **Cruising, Harbor, Offshore, or Sentry** mode.
3. Select **Menu > Noise Rejection > FTC**.

4. Complete an action:
    - Select **High**, **Medium**, or **Low** to decrease or increase the appearance of rain clutter, if using a GMR 20, 21, 40, 41, 18, 18 HD, 24, 24 HD, 404, or 406 radar. Other targets should remain clearly visible on the Radar screen.
    - Select **Up** or **Down** to decrease or increase the appearance of rain clutter, if using a GMR 604 xHD, 606 xHD, 1204 xHD, or 1206 xHD radar. Other targets should remain clearly visible on the Radar screen. If the FTC setting is greater than 50%, consider reducing the radar range.
  5. Select **Menu > Noise Rejection > Rain Clutter**.
  6. Select **Up** or **Down** to decrease or increase the appearance of nearby rain clutter until other targets are clearly visible on the Radar screen.
- Clutter caused by rain may still be visible.

### Adjusting Crosstalk Clutter on the Radar Screen

You can reduce the appearance of clutter caused by interference from another nearby radar source. On is the default value for the crosstalk setting.

**NOTE:** Depending upon the radar in use, the crosstalk setting configured for use in one radar mode may or may not be applied to other radar modes or to the Radar Overlay (page 63).

1. From the Home screen, select **Radar**.
2. Select **Cruising**, **Harbor**, **Offshore**, or **Sentry** mode.
3. Select **Menu > Noise Rejection > Crosstlk > On**.

## Radar Display Appearance

### Radar Overlay Numbers

Overlay numbers with data fields ① can appear on all radar modes, and they provide real-time, at-a-glance information. All data bars configured for use in one radar mode appear in every other radar mode. All data bars configured for use on the Radar Overlay appear only on the Radar Overlay, and must be configured separately.

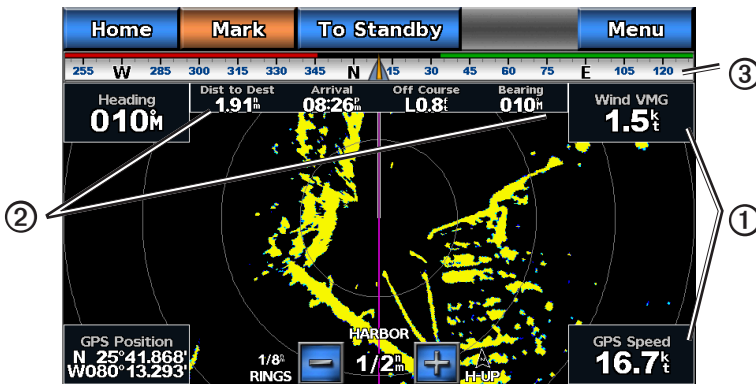

Several radar data overlays are available. You can select the data fields to be shown within each data overlay.

When overlay numbers are displayed on the radar screen, the navigation inset ② is shown during navigation. The compass tape ③ can be shown or hidden in each overlay.





Radar with Data Overlay

### Selecting a Data Overlay

1. From the Home screen, select **Radar**.
2. Select **Cruising**, **Harbor**, **Offshore**, or **Sentry** mode.
3. Select **Menu > Radar Setup > Overlay Numbers**.
4. Select  or  to select a data overlay.



### Configuring Data Fields on a Radar

You can select the type of data shown within a data field.

1. From the Home screen, select **Radar**.
2. Select **Cruising, Harbor, Offshore, or Sentry** mode.
3. Select **Menu > Radar Setup > Overlay Numbers**.
4. Select  or  to select a data overlay.
5. Touch a data field.
6. Select a category of data.
7. Select the data to be displayed.

### Configuring the Navigation Inset on the Radar Screen

The navigation inset is shown only when the boat is navigating to a destination.

1. From the Home screen, select **Radar**.
2. Select **Cruising, Harbor, Offshore, or Sentry** mode.
3. Select **Menu > Radar Setup > Overlay Numbers**.
4. Select  or  to select a data overlay.
5. Select **Navigation Inset**.
6. Select **Nav. Inset Config**.
7. Complete an action:
  - Select **Route Leg Details > On** to show waypoint velocity made good (VMG) when navigating a route with more than one leg.
  - Select **Next Turn > Distance** to show next-turn data based on distance.
  - Select **Next Turn > Time** to show next-turn data based on time.
  - Select **Destination**, and select **Distance, Time to Destination, or Arrival** to indicate how the destination data appears.

### Showing the Compass Tape on the Radar Screen

The compass tape appears in a row across the top of the radar screen. It shows the present heading, and an indicator that shows the bearing to the desired course appears while navigating.

1. From the Home screen, select **Radar**.
2. Select **Cruising, Harbor, Offshore, or Sentry** mode.
3. Select **Menu > Radar Setup > Overlay Numbers**.
4. Select **Show Compass Tape**.

### Radar Display Settings

#### Setting the Radar Color Scheme

You can set the color scheme used for all Radar screens. This setting does not apply to the Radar Overlay.

1. From the Home screen, select **Radar > Radar Setup > Appearance > Color Scheme**.
2. Select **White, Black, or Blue**.

#### Setting the Radar Display Orientation

You can set the perspective of the radar display. The orientation setting applies to every radar mode. This setting does not apply to the Radar Overlay.

1. From the Home screen, select **Radar > Radar Setup > Orientation**.
2. Complete an action:
  - Select **North Up** to set the top of the radar to a north heading.
  - Select **Head Up** to set the top of the radar according to the heading data received from a heading sensor, also known as the magnetic heading. The heading line appears vertically on the screen.
  - Select **Course Up** to set the radar so the direction of navigation is always up.

### Shifting the Field of View on the Radar Screen

You can shift your present location toward the bottom of the screen automatically as your speed increases. Enter your top speed for the best results. This setting applies to every radar mode. This setting does not apply to the Radar Overlay.

1. From the Home screen, select **Radar > Radar Setup > Appearance > Look-Ahd Spd > On**.
2. Enter the top speed at which you expect to navigate.
3. Select **Done**.

### Radar Navigation Settings

#### Showing the Heading Line on the Radar Screen

You can show an extension from the bow of the boat in the direction of travel on the Radar screen. This setting does not apply to the Radar Overlay.

From the Home screen, select **Radar > Radar Setup > Appearance > Heading Line > Show**.

#### Showing and Hiding Range Rings on the Radar Screen

The range rings help you to visualize distances on the Radar screen. This setting does not apply to the Radar Overlay.

From the Home screen, select **Radar > Radar Setup > Appearance > Rings > Show**.

#### Showing Navigation Lines on the Radar Screen

The navigation lines indicate the course you have set using Route To, Guide To, or Go To. This setting does not apply to the Radar Overlay.

From the Home screen, select **Radar > Radar Setup > Appearance > Nav Lines > Show**.

### Radar Scanner and Antenna Settings

#### Setting the Antenna Rotation Speed

**NOTE:** You can set the rotation speed for GMR 18, 18 HD, 24, 24 HD, 404, 406, 604 xHD, 606 xHD, 1204 xHD, or 1206 xHD radars only.

1. From the Home screen, select **Radar > Radar Setup > Rotation Spd**.
2. Complete an action:
  - Select **Normal Speed**.
  - Select **High Speed** to increase the speed at which the antenna rotates, which increases the speed at which the screen updates.

#### Setting the Radar Antenna Size

You can indicate the size of the radar antenna in order to optimize the radar picture. Until you specify the antenna size, the “Radar needs to be configured” message appears.

**NOTE:** You can set the antenna size for GMR 404, 406, 604 xHD, 606 xHD, 1204 xHD, or 1206 xHD radars only.

1. From the Home screen, select **Radar > Radar Setup > Antenna Size**.
2. Select **4 Foot** or **6 Foot**.

#### Turning On and Configuring a Radar No-transmit Zone

You can indicate an area within which the radar scanner does not transmit signals.

**NOTE:** You can set a radar no-transmit zone for GMR 604 xHD, 606 xHD, 1204 xHD, or 1206 xHD radars only.

1. From the Home screen, select **Radar > Radar Setup > Adjust No-Xmit Zone > Move No-Xmit Zone**.  
The no-transmit zone is indicated by a shaded area on the Radar screen.
2. Select **Angle 1**.
3. Touch and drag the cursor to adjust the starboard no-transmit angle.
4. Select **Angle 2**.
5. Touch and drag the cursor to adjust the port no-transmit angle.



## Front-of-boat Offset

The front-of-boat offset compensates for the physical location of the radar scanner on a boat, if the radar scanner does not align with the bow-stern axis.

### Measuring the Potential Front-of-boat Offset

1. Using a magnetic compass, take an optical bearing of a stationary target located within viewable range.
2. Measure the target bearing on the radar.
3. If the bearing deviation is more than +/- 1°, set the front-of-boat offset.

### Setting the Front-of-boat Offset

Before you can set the front-of-boat offset, you must measure the potential front-of-boat offset (see previous procedure).

The front-of-boat offset setting configured for use in one radar mode is applied to every other radar mode and to the Radar Overlay.

1. From the Home screen, select **Radar > Radar Setup > Front of Boat**.
2. Select and hold **Up** or **Down** to adjust the offset.

## Radar Overlay Display Appearance

### Showing Tracks on the Radar Overlay

You can set whether vessel tracks appear on the Radar Overlay.

From the Home screen, select **Charts > Radar Overlay > Menu > Waypoints & Tracks > Tracks > On**.

### Selecting a Waypoint Label Type

You can select the type of labels shown with waypoints on the Radar Overlay.

1. From the Home screen, select **Charts > Radar Overlay > Menu > Waypoints & Tracks > Waypoint Display**.
2. Select a waypoint.
3. Complete an action:
  - Select **Label** to identify waypoints using labels.
  - Select **Comment** to show comments as waypoint labels.
  - Select **Symbol** to identify waypoints using symbols.

### Showing Other Vessels on the Radar Overlay

AIS requires the use of an external AIS device and active transponder signals from other vessels.

You can configure how other vessels appear on the Radar Overlay. The display range setting configured for the Radar Overlay is applied only to the Radar Overlay. The details and projected heading settings configured for the Radar Overlay are also applied to all radar modes.

1. From the Home screen, select **Charts > Radar Overlay > Menu > Other Vessels > AIS Display Setup**.
2. Complete an action:
  - Select **AIS Display Range** to indicate the distance from your location in which AIS vessels appear, and select a distance.
  - Select **Details > Show** to show details about AIS-activated vessels.
  - Select **Proj. Heading** to set the projected heading time for AIS-activated vessels, and select **Done**.
  - Select **Trails** to show the tracks of AIS vessels, and select the length of the track that appears using a trail.

## **Radar Overlay Navigation Display Settings**

### **Changing the Map Zoom Detail**

You can adjust the amount of detail shown on the map, at different zoom levels, for the Radar Overlay.

1. From the Home screen, select **Charts > Radar Overlay > Menu > Setup > Chart Setup > Detail**.
2. Select a level of detail.

### **Showing and Configuring the Heading Line**

The heading line is an extension drawn on the map from the bow of the boat in the direction of travel. You can configure the appearance of the heading line on the Radar Overlay.

1. From the Home screen, select **Charts > Radar Overlay > Menu > Setup > Chart Setup > Heading Line**.
2. Complete an action:
  - Select **Distance > Change Distance**, and enter the distance to the end of the heading line.
  - Select **Time > Change Time**, and enter the amount of time until you reach the end of the heading line.
3. Select **Done**.

## Sonar

When connected to a transducer, the following 700 series models can be used as fishfinders:

- GPSMAP 720s
- GPSMAP 740s
- GPSMAP 750s

### Sonar Views

The chartplotter shows sonar data using three different views: a full-screen view, a split-zoom view, and a split-frequency view.

#### Full-screen Sonar View

The full-screen sonar view shows a full-view graph of sonar readings from a transducer. The range scale along the right side of the screen shows the depth of detected objects as the screen scrolls from the right to the left.

From the Home screen, select **Sonar > Full Screen**.

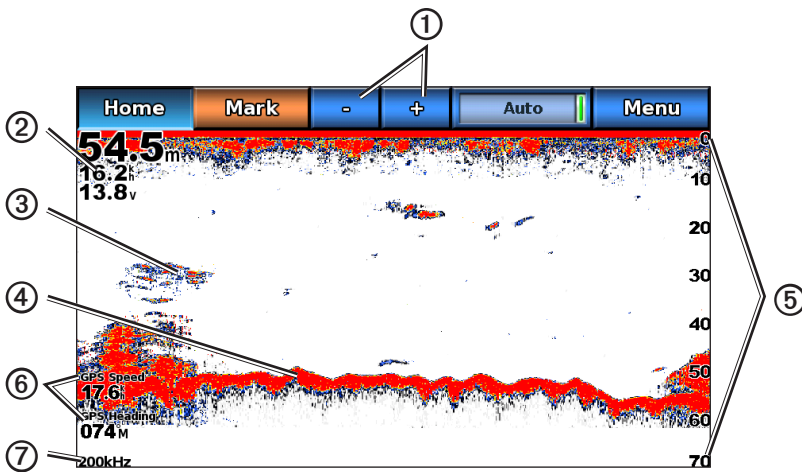

**Full-screen Sonar View**

①	Range adjustment buttons	②	Depth, water speed, and unit voltage
③	Suspended target	④	Bottom
⑤	Range	⑥	GPS speed and GPS heading
⑦	Transducer frequency		

#### Setting the Zoom Level on the Full-screen View

You can zoom in to a section of the full-screen sonar view.

1. From the Home screen, select **Sonar > Full Screen > Menu > Zoom**.
2. Complete an action:
  - Select **2x Auto Zoom** to zoom in on the sonar data at two-times magnification.
  - Select **4x Auto Zoom** to zoom in on the sonar data at four-times magnification.
  - Select **Manual Zoom** to set the depth range of the magnified area manually. Select **View Up** or **View Down** to set the depth range of the magnified area, select **Zoom In** or **Zoom Out** to increase or decrease the magnification of the magnified area, and select **Done**.
  - Select **Bottom Lock** to zoom in on sonar data from the bottom depth, select **Up** or **Down** to set the depth range of the magnified area, and select **Done**.

### Split-zoom Sonar View

The split-zoom sonar view shows a full-view graph of sonar readings, and a magnified portion of that graph, on the same screen.

From the Home screen, select **Sonar > Split Zoom**.

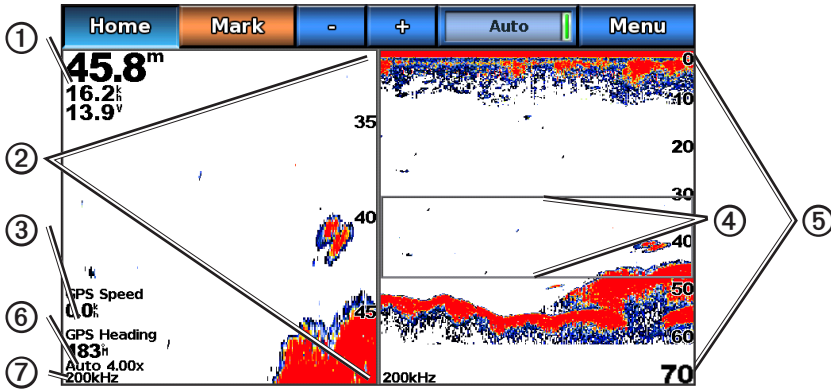

**Split-zoom Sonar View**

①	Depth, water speed, and unit voltage	②	Zoomed depth scale
③	GPS speed and GPS heading	④	Zoom window
⑤	Range	⑥	Zoom window
⑦	Transducer frequency		

### Split-frequency Sonar View

In the split-frequency sonar view, the left side of the screen shows a full-view graph of 200 kHz frequency sonar data, and the right side of the screen shows a full-view graph of 50 kHz frequency sonar data.

**NOTE:** The split-frequency sonar view requires the use of a dual-frequency transducer.

From the Home screen, select **Sonar > Split Frequency**.

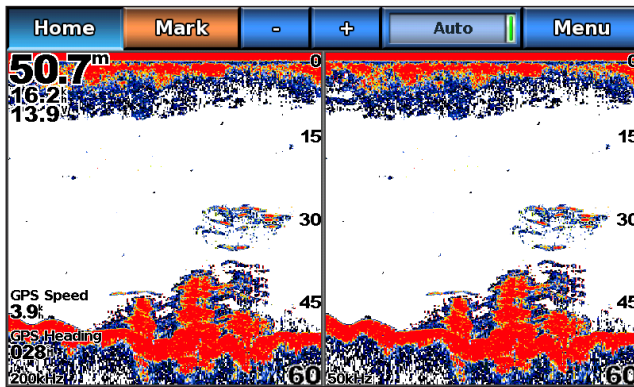

**Split-frequency Sonar View**

### Changing from One Sonar View to a Different Sonar View

1. From the Home screen, select **Sonar**.
2. Select a sonar view.
3. Select **Menu > Change Sonar**.
4. Select a different sonar view.

## Depth Log

If you are using a depth-capable transducer, or are receiving water depth information via NMEA 0183 or NMEA 2000, the Depth Log displays a graphic log of depth readings over time. The depth appears in the upper-left corner of the screen. The graph scrolls to the left as information is received.

From the Home screen, select **Sonar > Depth Log**.

### Setting the Depth Log Range and Time Scales

You can indicate the amount of time and the range of depth that appear in the depth log.

1. From the Home screen, select **Sonar > Depth Log**.
2. Select **Menu**.
3. Complete an action:
  - Select **Duration** to set the time-elapsed scale ①. The default setting is 10 minutes. Increasing the time-elapsed scale allows you to view depth variations over a longer period of time. Decreasing the time-elapsed scale allows you to view more detail over a shorter period of time.
  - Select **Scale** to set the depth-range scale ②. Increasing the depth-range scale allows you to view more variation in depth. Decreasing the depth-range scale allows you to view more detail in the variation. The present depth is shown in the top-left corner ③.
  - Select **Reset** to recalculate the automatic depth scale range. **Reset** appears only when the depth-range scale setting is set to **Auto**.

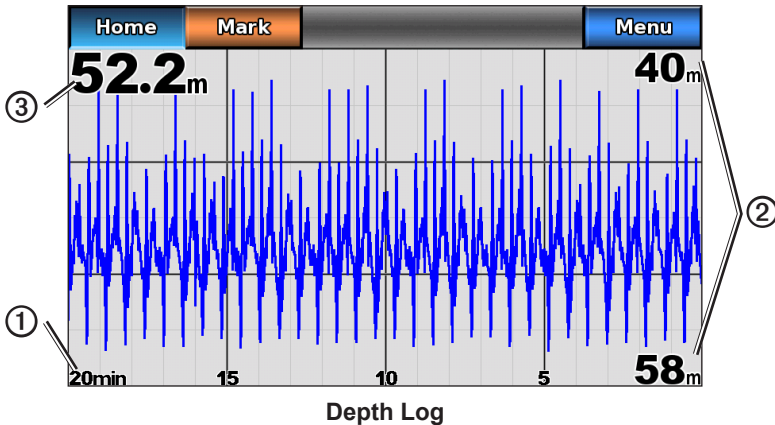

## Transducer Temperature Log

If you are using a temperature-capable transducer, or are receiving water temperature via NMEA 0183 or NMEA 2000, the Temperature Log screen keeps a graphic log of temperature readings over time. The present temperature and depth appear in the upper-left corner of the screen. The temperature appears along the right side and the time elapsed appears along the bottom. The graph scrolls to the left as information is received.

From the Home screen, select **Sonar > Temp Log**.

### Setting the Temperature Log Range and Time Scales

You can indicate the amount of time and the range of temperatures that appear in the transducer temperature log.

1. From the Home screen, select **Sonar > Temp Log**.
2. Select **Menu**.

### 3. Complete an action:

- Select **Duration** to set the time-elapsed scale ①. The default setting is 10 minutes. Increasing the time-elapsed scale allows you to view temperature variations over a longer period of time. Decreasing the time-elapsed scale allows you to view more detail over a shorter period of time.
- Select **Scale** to set the temperature-range scale ②. The default setting is 4 degrees. Increasing the temperature-range scale allows you to view more variation in temperature. Decreasing the temperature-range scale allows you to view more detail in the variation.
- Select **Reset** to recalculate the automatic depth scale range. **Reset** appears only when the scale setting is set to **Auto**.

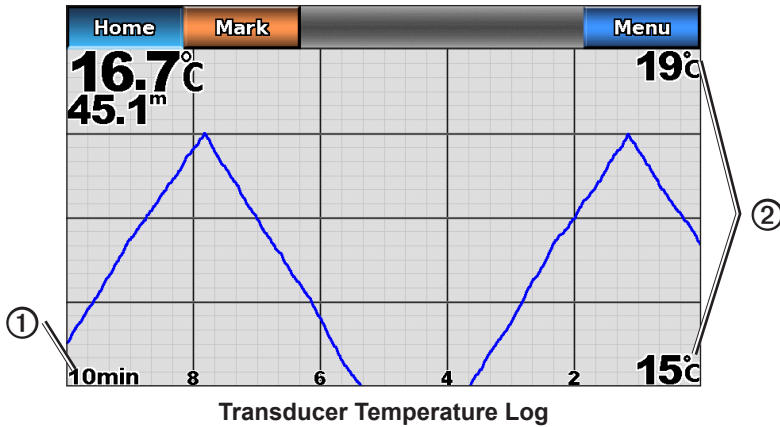

## Waypoints on the Sonar Screen

### Pausing the Sonar Display

1. From the Home screen, select **Sonar**.
2. Select a sonar view.
3. Select **Menu > Pause Sonar**.

### Creating a Waypoint on the Sonar Screen

1. From the Home screen, select **Sonar**.
2. Select a sonar view.
3. Select **Menu > Pause Sonar**.
4. Touch and drag the intersection point of the depth line and the distance line to set the location of the waypoint.
5. Select **Create Waypoint**.

## Sonar Display Appearance

You can define and adjust settings for all sonar views.

### Setting Sonar Screen Scroll Speed

You can set the rate at which the sonar scrolls from right to left.

1. From the Home screen, select **Sonar > Sonar Setup > Scroll Speed**.
2. Complete an action:
  - Select **Ultrascroll™**, **Fast**, **Medium**, or **Slow** to set the scroll speed manually.
  - Select **Auto** to have the scroll speed automatically adjust to the water speed of your boat, if you are using a water-speed sensor or a speed-capable transducer.

## Showing Surface Noise

You can set whether the sonar returns near the surface of the water appear. Hide surface noise to help reduce clutter.

From the Home screen, select **Sonar > Sonar Setup > Surface Noise > Show**.

## Showing and Configuring a Depth Line

You can set whether a quick-reference depth line appears.

1. From the Home screen, select **Sonar > Sonar Setup > Depth Line > Show**.
2. Touch and drag the reference line to set the depth of the line.

## Showing the A-Scope

The A-Scope is a vertical flasher along the right side of the screen that shows instantaneously the range to targets along a scale.

From the Home screen, select **Sonar > Sonar Setup > A-Scope > On**.

## Setting Pic Advance

The picture advance setting allows the sonar picture to advance faster by drawing more than one column of data on the screen for each column of sounder data received. This is especially helpful when you are using the sounder in deep water, because the sonar signal takes longer to travel to the water bottom and back to the transducer.

The **1/1** setting draws one column of information on the screen per sounder return. The **2/1** setting draws two columns of information on the screen per sounder return, and so on for the **4/1** and **8/1** settings.

1. From the Home screen, select **Sonar > Sonar Setup > Pic. Advance**.
2. Select a picture advance setting.

## Showing Overlay Numbers

You must have a water-speed sensor or a speed-capable transducer to show water-speed information, and you must have a water-temperature sensor or a temperature-capable transducer to show water-temperature information.





You can set water temperature, unit voltage, water speed (if your transducer is capable), and navigation information to appear automatically on the Sonar screens. The navigation information always includes GPS speed and GPS heading, and includes bearing and off-course information while navigating.

1. From the Home screen, select **Sonar > Sonar Setup > Overlay Numbers**.
2. Complete an action:
  - Select **Depth > Show**.
  - Select **Water Temp > Auto**.
  - Select **Water Speed > Auto**.
  - Select **Unit Voltage > Show**.
  - Select **Navigation > Auto**.

If you select **Auto**, and if the information is available, the data appears on the Sonar screen.

## Configuring the Appearance of Suspended Targets

You can set how the sonar interprets suspended targets.

1. From the Home screen, select **Sonar > Sonar Setup > Appearance > Fish Symbols**.
2. Complete an action:
  - Select  to show suspended targets as symbols with background sonar information.
  - Select  to show suspended targets as symbols with background sonar information and target depth information.
  - Select  to show suspended targets as symbols.
  - Select  to show suspended targets as symbols with target depth information.

## Showing and Configuring the Whiteline

You can highlight the strongest signal from the bottom to help define the hardness or softness of the signal.

1. From the Home screen, select **Sonar > Sonar Setup > Whiteline**.
2. Complete an action:
  - Select **High** to turn on the whiteline with the most-sensitive setting. Almost all strong returns are highlighted in white.
  - Select **Medium** to turn on the whiteline with many strong returns highlighted in white.
  - Select **Low** to turn on the whiteline with the least-sensitive setting. Only the strongest returns are highlighted in white.

## Setting the Color Scheme

1. From the Home screen, select **Sonar > Sonar Setup**.
2. Complete an action:
  - Select **Color Scheme > Blue**.
  - Select **Color Scheme > White**.

## Adjusting the Gain on the Sonar Screen

You can control the sensitivity of the sonar receiver. To see more detail, increase the gain. If the screen is cluttered, decrease the gain.

1. From the Home screen, select **Sonar**.
2. Select a sonar view.
3. Select **Menu > Gain**.
4. Complete an action:
  - Select **Auto** to allow the chartplotter to adjust the gain automatically.
  - Select **Up** or **Down** to increase or decrease the gain manually.
5. Select **Done**.

## Adjusting the Noise Rejection on the Sonar Screen

The Noise Rejection setting appears only when you have manually increased or decreased the gain setting ([page 76](#)).

You can minimize the appearance of weak sonar returns by increasing the noise rejection.

1. From the Home screen, select **Sonar**.
2. Select a sonar view.
3. Select **Menu > Noise Reject**.
4. Select **Up** or **Down**.

## Selecting Frequencies

You can indicate which frequencies appear on the sonar screen when using a dual frequency transducer. You can show data from a 200 kHz sonar signal, data from a 50 kHz sonar signal, or data from both signals simultaneously.

1. From the Home screen, select **Sonar**.
2. Select a sonar view.
3. Select **Menu > Frequency**.
4. Complete an action:
  - Select **200 kHz** to show data from a 200 kHz sonar signal. This is useful mainly for more-shallow, inland waters.
  - Select **50 kHz** to show data from a 50 kHz sonar signal. This is useful mainly for deeper waters.
  - Select **Dual** to show both 200 kHz and 50 kHz data on a split screen.



## Adjusting the Range of the Depth Scale

You can adjust the range of the depth scale that appears on the right side of the screen.

1. From the Home screen, select **Sonar**.
2. Select a sonar view.
3. Select **Menu > Range**.
4. Complete an action:
  - Select **Auto** to allow the chartplotter to adjust the depth scale automatically.
  - Select **Up** or **Down** to increase or decrease the range of the depth scale manually.
5. Select **Done**.

**NOTE:** From the sonar screen, you can press  or  to manually adjust the range of the depth scale.

## Sonar Alarms

### Setting the Shallow Water and Deep Water Alarms

1. From the Home screen, select **Configure > Alarms > Sonar**.
2. Select **Shallow Water > On** to set an alarm to sound when the depth is less than the specified value.
3. Enter the depth that triggers the shallow water alarm.
4. Select **Done**.
5. Select **Deep Water > On** to set an alarm to sound when the depth is greater than the specified value.
6. Enter the depth that triggers the deep water alarm.
7. Select **Done**.



### Setting the Water Temperature Alarm

You can set an alarm to sound when the transducer reports a temperature that is 2°F (1.1°C) above or below the specified temperature.

1. From the Home screen, select **Configure > Alarms > Sonar > Water Temp > On**.
2. Enter a water temperature.
3. Select **Done**.

### Setting the Fish Alarm

You can set an alarm to sound when the chartplotter detects a suspended target of the specified symbols.

1. From the Home screen, select **Configure > Alarms > Sonar > Fish**.
2. Complete an action:
  - Select  to sound an alarm for all fish sizes.
  - Select  to sound an alarm for medium and large fish only.
  - Select  to sound an alarm for large fish only.

## Transducer Configuration

### Setting the Keel Offset

The keel offset compensates for the surface reading for the depth of a keel, making it possible to measure depth from the bottom of the keel instead of from the transducer location. Enter a positive number to offset for a keel. You can enter a negative number to compensate for a large vessel that may draw several feet of water.

- Complete an action, based on the location of the transducer:
  - If the transducer is installed at the water line ①, measure the distance from the transducer location to the keel of the boat. Enter this value in step 3 as a positive number.
  - If the transducer is installed at the bottom of the keel ②, measure the distance from the transducer to the water line. Enter this value in step 3 as a negative number.

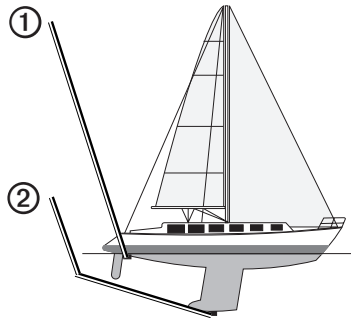

Keel Offset

- From the Home screen, select **Configure > My Boat > Keel Offset**.
- Enter the distance measured in step 1. Ensure that you enter a positive or a negative number based on the location of the transducer.
- Select **Done**.

### Setting the Water Temperature Offset

You must have a NMEA 0183 water-temperature sensor or a temperature-capable transducer to measure water temperature.

The temperature offset compensates for the temperature reading from a temperature sensor.

- Measure the water temperature using the temperature sensor or temperature-capable transducer that is connected to the chartplotter.
- Measure the water temperature using a different temperature sensor or a thermometer that is known to be accurate.
- Subtract the water temperature measured in step 1 from the water temperature measured in step 2.  
This is the temperature offset. Enter this value in step 5 as a positive number if the sensor connected to the chartplotter measures the water temperature as being colder than it actually is. Enter this value in step 5 as a negative number if the sensor connected to the chartplotter measures the water temperature as being warmer than it actually is.
- From the Home screen, select **Configure > My Boat > Temp Offset**.
- Enter the temperature offset calculated in step 3.
- Select **Done**.

## Digital Selective Calling

### Chartplotter and VHF Radio Functionality

The following table indicates the features that are available when you connect your chartplotter to a VHF radio over a NMEA 0183 network or a NMEA 2000 network.

Functionality	NMEA 0183 VHF Radio	NMEA 2000 VHF Radio	Garmin NMEA 0183 VHF Radio	Garmin NMEA 2000 VHF Radio
The chartplotter can transfer your GPS position to your radio. If your radio is capable, GPS position information is transmitted with DSC calls.	X	X	X	X
The chartplotter can receive DSC distress and position information from the radio ( <a href="#">page 80</a> )	X	X	X	X
The chartplotter can track the positions of vessels sending position reports ( <a href="#">page 81</a> ).	X	X	X	X
The chartplotter allows you to quickly set up and send individual routine call details to your Garmin VHF radio ( <a href="#">page 83</a> ).				X
When you initiate a man-overboard distress call from your radio, the chartplotter shows the man-overboard screen and prompts you to navigate to the man-overboard point ( <a href="#">page 80</a> ).				X
When you initiate a man-overboard distress call from your chartplotter, the radio shows the Distress Call page to initiate a man-overboard distress call ( <a href="#">page 80</a> ).				X

### Turning On DSC

From the Home screen, select **Configure > Other Vessels > DSC > On**.

### About the DSC List

The DSC list is a log of the most-recent DSC calls and other DSC contacts you have entered. The DSC list can contain up to 100 entries. The DSC list shows the most-recent call from a boat. If a second call is received from the same boat, it replaces the first call in the call list.

### Viewing the DSC List

Your chartplotter must be connected to a VHF radio that supports DSC in order to view the DSC list.

From the Home screen, select **Information > Other Vessels > DSC List**.

## Adding a DSC Contact

You can add a vessel to your DSC list. You can make calls to a DSC contact from the chartplotter ([page 83](#)).

1. From the Home screen, select **Information > Other Vessels > DSC List > Add Contact**.
2. Enter the Maritime Mobile Service Identity (MMSI) of the vessel.
3. Select **Done**.
4. Enter the name of the vessel.
5. Select **Done**.

## Incoming Distress Calls

If your Garmin chartplotter and VHF radio are connected using NMEA 0183 or NMEA 2000, your chartplotter alerts you when your VHF radio receives a DSC distress call. If position information was sent with the distress call, that information is also available and recorded with the call.

The  symbol designates a distress call in the DSC list and marks the position of the vessel on the Navigation chart at the time when the DSC distress call was sent.

## Viewing the DSC Distress Call Report

See “Viewing a Position Report” ([page 81](#)).

## Calling a Vessel in Distress

See “Making an Individual Routine Call” ([page 83](#)).

## Navigating to a Vessel in Distress

The  symbol designates a distress call in the DSC list and marks the position of a vessel on the Navigation chart at the time a DSC distress call is sent.

See “Navigating to a Tracked Vessel” ([page 81](#)).

## Creating a Waypoint at the Position of a Vessel in Distress

See “Creating a Waypoint at the Position of a Tracked Vessel” ([page 81](#)).

## Editing Information in a DSC Call Report

See “Editing Information in a Position Report” ([page 81](#)).

## Deleting a DSC Call Report

See “Deleting a Position Report” ([page 81](#)).

## Man-Overboard Distress Calls Initiated from a VHF Radio

When your Garmin chartplotter is connected to a Garmin NMEA 2000-compatible radio, and you initiate a man-overboard DSC distress call from your radio, your Garmin chartplotter shows the man-overboard screen and prompts you to navigate to the man-overboard point. If you have a Garmin autopilot system connected to the network, your chartplotter prompts you to start a Williamson’s turn to the man-overboard point.

If you cancel the man-overboard distress call on the radio, the chartplotter screen prompting you to activate navigation to the man-overboard location disappears.

## Man-Overboard Distress Calls Initiated from the Chartplotter

When your Garmin chartplotter is connected to a Garmin NMEA 2000-compatible radio and you activate navigation to a man-overboard location, the radio shows the Distress Call page so you can quickly initiate a man-overboard distress call.

On the radio, press the **DISTRESS** key for at least three seconds to send the distress call.



For information on placing distress calls from your radio, see your Garmin VHF Radio Owner’s Manual. You can mark an MOB and navigate to it ([page 27](#)).

## Position Tracking

When you connect your Garmin chartplotter to a VHF radio using NMEA 0183, you can track vessels that send position reports. This feature is also available with NMEA 2000, provided that the vessel sends the correct PGN data (PGN 129808; DSC Call Information).

Every position-report call received is logged in the DSC list ([page 79](#)).

### Viewing a Position Report

1. From the Home screen, select **Information > Other Vessels > DSC List**.
2. Select a position-report call.
3. Select  or  to switch between details of the position report and a Navigation chart marking the location.

### Calling a Tracked Vessel

See “Making an Individual Routine Call” ([page 83](#)).

### Navigating to a Tracked Vessel

1. From the Home screen, select **Information > Other Vessels > DSC List**.
2. Select a position-report call.
3. Select **Navigate To**.
4. Select **Go To** or **Route To** ([page 25](#)).

### Creating a Waypoint at the Position of a Tracked Vessel

1. From the Home screen, select **Information > Other Vessels > DSC List**.
2. Select a position-report call.
3. Select **Create Waypoint**.

### Editing Information in a Position Report

1. From the Home screen, select **Information > Other Vessels > DSC List**.
2. Select a position-report call.
3. Select **Edit**.
4. Complete an action:
  - Select **Name**. Enter the name of the vessel. Select **Done**.
  - Select **Symbol**. Select a new symbol. Select **Done**.
  - Select **Comment**. Enter the comment. Select **Done**.
  - Select **Trail > Show** to show a trail line for the vessel, if your radio is tracking the position of the vessel.
  - Select **Trail Line**. Select a color for the trail line.

### Deleting a Position-Report Call

1. From the Home screen, select **Information > Other Vessels > DSC List**.
2. Select a position-report call.
3. Select **Clear Report**.

## Vessel Trails on the Navigation Chart

You can view trails for all tracked vessels on the Navigation chart, the Fishing chart, and the Mariner's Eye 3D chart view. By default, a black dot ① appears for each previously reported position of a tracked vessel, and a Blue Flag symbol ② indicates the last reported position of the vessel. A black line ③ indicating the path of the vessel also appears.

You must enable the DSC Trails setting in order to view trails for tracked vessels (page 82).

**NOTE:** The Mariner's Eye 3D chart is available if you use a BlueChart g2 Vision SD card. The Fishing chart is available if you use a BlueChart g2 Vision SD card or a BlueChart g2 SD card, or if your built-in map supports Fishing charts.

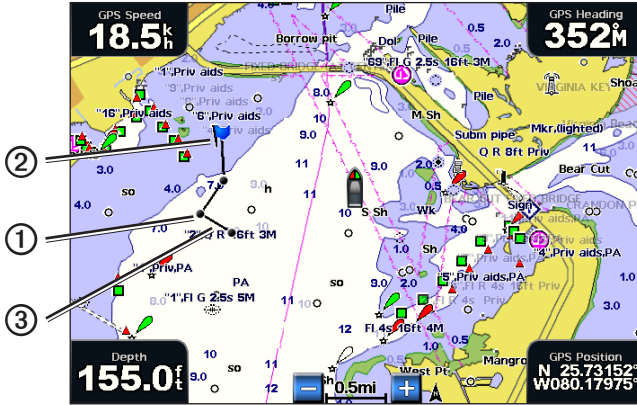

Vessel Trail on the Navigation Chart

### Showing and Setting the Duration of Trails for All Tracked Vessels

**NOTE:** The Mariner's Eye 3D chart is available if you use a BlueChart g2 Vision SD card. The Fishing chart is available if you use a BlueChart g2 Vision SD card or a BlueChart g2 SD card, or if your built-in map supports Fishing charts.

1. From the Home screen, select **Charts**.
2. Select **Navigation Chart, Fishing Chart, Perspective 3D, or Mariner's Eye 3D**.
3. Select **Menu > Other Vessels > DSC Trails**.
4. Select the number of hours to show tracked vessels on the chart or 3D chart view.

For example, if you select **4 Hours**, all trail points that are less than four hours old appear for all tracked vessels.

### Showing the Trail Line for a Tracked Vessel

You can show the trail line for a specific tracked vessel.

**NOTE:** The Mariner's Eye 3D chart is available if you use a BlueChart g2 Vision SD card. The Fishing chart is available if you use a BlueChart g2 Vision SD card or a BlueChart g2 SD card, or if your built-in map supports Fishing charts.

1. From the Home screen, select **Charts**.
2. Select **Navigation Chart, Fishing Chart, Perspective 3D, or Mariner's Eye 3D**.
3. Select **Menu > Other Vessels > DSC List**.
4. Select a vessel.
5. Select **Edit > Trail > Show**.

## Changing the Appearance of a Trail Line

You can change the appearance of a trail line for a specific tracked vessel.

**NOTE:** The Mariner's Eye 3D chart is available if you use a BlueChart g2 Vision SD card. The Fishing chart is available if you use a BlueChart g2 Vision SD card or a BlueChart g2 SD card, or if your built-in map supports Fishing charts.

1. From the Home screen, select **Charts**.
2. Select **Navigation Chart, Fishing Chart, Perspective 3D, or Mariner's Eye 3D**.
3. Select **Menu > Other Vessels > DSC List**.
4. Select a vessel.
5. Select **Review > Edit > Trail Line**.
6. Select a color for the trail line.

## Individual Routine Calls

When you connect your Garmin chartplotter to a Garmin VHF NMEA 2000-compatible radio, you can use the chartplotter interface to set up an individual routine call. When setting up an individual routine call from your chartplotter, you can select the DSC channel on which you want to communicate ([page 83](#)). The radio transmits this request with your call.

### Selecting a DSC Channel

**NOTE:** The selection of a DSC channel is limited to those channels that are available in all frequency bands: 6, 8, 9, 10, 13, 15, 16, 17, 67, 68, 69, 71, 72, 73, or 77. The default channel is 72. If you select a different channel, the chartplotter uses that channel for subsequent calls until you call using another channel.

1. From the Home screen, select **Information > Other Vessels > DSC List**.
2. Select a vessel or a station to call.
3. Select **Call with Radio > Channel**.
4. Select a channel.

### Making an Individual Routine Call

**NOTE:** When initiating a call from the chartplotter, if the radio does not have an MMSI number programmed, the radio will not receive call information.

1. From the Home screen, select **Information > Other Vessels > DSC List**.
2. Select a vessel or a station to call.
3. Select **Call with Radio > Send**.  
The chartplotter sends information about the call to the radio.
4. On your Garmin VHF radio, select **Call**.

### Making an Individual Routine Call to an AIS Target

When you connect your Garmin chartplotter to a Garmin VHF NMEA 2000-compatible radio, you can use the chartplotter interface to set up an individual routine call to an AIS target. Before you start the call, you can select a DSC channel other than the default channel, channel 72 ([page 83](#)).

1. From the Home screen, select **Charts**.
2. Select a chart or a 3D chart view.
3. Touch an AIS target .
4. Select **AIS Vessel > Call with Radio > Send**.  
The chartplotter sends information about the call to the radio.
5. On your Garmin VHF radio, select **Call**.

# Appendix

## Specifications

### Physical Specifications

Specification	Measurement
Size	W × H × D: 8 <sup>29</sup> / <sub>32</sub> × 5 <sup>19</sup> / <sub>32</sub> × 3 <sup>1</sup> / <sub>8</sub> in. (226 × 142 × 80 mm)
Weight	2.48 lb. (1.125 kg)
Display	W × H: 6 × 3 <sup>19</sup> / <sub>32</sub> in. (152 × 91 mm)
Case	Fully gasketed, high-impact plastic and aluminum alloy, waterproof to IEC 60529 IPX-7
Temp. Range	From 5°F to 131°F (from -15°C to 55°C)
Compass Safe Distance	32.0 in. (813 mm)

### GPS Performance

Specification	Parameter	Measurement
Receiver		High-sensitivity 12 parallel channel, WAAS-capable receiver
Acquisition Time	Warm	Approximately 1 sec. (The device is at or near the last location at which you recently acquired satellites.)
	Cold	Approximately 38 sec. (The device has moved more than about 500 mi. [800 km] since it was turned off.)
	Reacquisition	< 1 sec.
Update Rate		1/sec., continuous
Accuracy	GPS	<33 ft. (10 m) 95% typical
	DGPS	10-16 ft. (3-5 m) 95% typical (WAAS/EGNOS accuracy)
Velocity		0.05 m/sec. steady state

### Power

Specification	Measurement
Source	10–32 Vdc
Usage	8.56 W max. at 13.8 Vdc
Fuse	3 A
NMEA 2000 Load Equivalency Number (LEN)	2
NMEA 2000 Draw	100 mA maximum

## Calibrating the Touchscreen

The GPSMAP 700 series chartplotter touchscreen does not normally require calibration. However, if the buttons do not seem to be responding properly, use the following process to calibrate the screen.

1. While the chartplotter is turned off, press .  
The Warning screen appears.
2. Touch anywhere on the black portion of the screen for approximately 15 seconds until the calibration screen appears.
3. Follow the instructions on the screen until “Calibration is complete” appears.
4. Touch **OK**.



## Screenshots

You can capture as a bitmap (.BMP) file a screenshot of any screen shown on your chartplotter, and transfer the file to your computer.

### Capturing Screenshots

1. Insert a memory card into the SD card slot on the front of the chartplotter.
2. Select **Configure > System > Beeper/Display > Screenshot Capture > On**.
3. Go to a screen you want to capture.
4. Press **HOME** for at least six seconds.  
The Screenshot Taken window appears.
5. Select **OK**.

### Copying Screenshots to a Computer

1. Remove the memory card from the chartplotter and insert it into an SD card reader that is attached to a computer.
2. From Windows Explorer, open the Garmin\scrn folder on the memory card.
3. Copy a .BMP file from the card and paste it to any location on the computer.

## Viewing GPS Satellite Locations

You can view the relative position of GPS satellites in the sky.

From the Home screen, select **Configure > System > GPS > Skyview**.

## Using WAAS/EGNOS

WAAS (in North America) or EGNOS (in Europe) can provide more-accurate GPS position information. However, when using WAAS or EGNOS, the device takes longer to acquire satellites.

From the Home screen, select **Configure > System > WAAS/EGNOS > ON**.

## System Information

### Viewing System Information

See “Viewing System Information” ([page 3](#)).

### Viewing the Event Log

The event log shows a list of system events.

From the Home screen, select **Configure > System > System Information > Event Log**.

### Saving System Information to a Memory Card

You can save system information to a memory card as a troubleshooting tool. A Garmin Product Support representative may ask you to use this information to retrieve data about the network.

1. Insert a memory card into the SD card slot on the chartplotter.
2. Select **Configure > System > System Information > Garmin Devices > Save to Card**.
3. Remove the memory card.

## Restoring the Original Chartplotter Factory Settings

**NOTE:** This procedure deletes all settings information you have entered.

1. From the Home screen, select **Configure > System > System Information > Factory Settings**.
2. Select **Yes**.

## NMEA 0183 and NMEA 2000

A GPSMAP 700 series chartplotter can accept data from both NMEA 0183-compliant devices and certain NMEA 2000 devices connected to an existing NMEA 2000 network on your boat.

### NMEA 0183

The NMEA 0183 data cable included with each GPSMAP 700 series chartplotter supports the NMEA 0183 standard, which is used to wire various NMEA 0183-compliant devices, such as VHF radios, NMEA instruments, autopilots, wind sensors, and heading sensors.

To wire the GPSMAP 700 series chartplotter to optional NMEA 0183-compliant devices, see the *GPSMAP 700 Series Installation Instructions*.

### Approved NMEA 0183 Sentences

GPAPB, GPBOD, GPBWC, GPGGA, GPGLL, GPGSA, GPGSV, GPRMB, GPRMC, GPRTE, GPVTG, GPWPL, GPXTE, and Garmin proprietary sentences PGRME, PGRMM, and PGRMZ.

This chartplotter also includes support for the WPL sentence, DSC, and sonar NMEA 0183 input with support for the DPT (depth) or DBT, MTW (water temp), and VHW (water temp, speed, and heading) sentences.

### Configuring NMEA 0183 Output Sentences

You can configure how the chartplotter sees NMEA 0183 output sentences.

1. From the Home screen, select **Configure > Communications > NMEA 0183 Setup**.
2. Select a setting: **Route, System, Garmin, or Sounder**.
3. Select one or more NMEA 0183 output sentences.
4. Repeat steps 2 and 3 to configure additional settings.

### Setting the Communication Format for Each NMEA 0183 Port

You can configure the input/output format for each port to use when connecting your chartplotter to external NMEA devices, a computer, or other Garmin devices.

1. From the Home screen, select **Configure > Communications > NMEA 0183 Setup**.
2. Complete an action:
  - Select **Serial Port 1**.
  - Select **Serial Port 2**.
3. Select an input/output format:
  - Select **Garmin Data Transfer** to support the input or output of Garmin-proprietary data for interfacing with Garmin software.
  - Select **NMEA Std.** to support the input or output of standard NMEA 0183 data, DSC, and sonar NMEA input support for the DPT, MTW, and VHW sentences.
  - Select **NMEA High Speed** to support the input or output of standard 0183 data for most AIS receivers.

### Setting Decimal Precision for NMEA 0183 Output

You can adjust the number of digits to the right of the decimal point for transmission of NMEA output.

1. From the Home screen, select **Configure > Communications > NMEA 0183 Setup > Posn. Precision**.
2. Select **Two Digits, Three Digits, or Four Digits**.

### Configuring Waypoint Identification

1. From the Home screen, select **Configure > Communications > NMEA 0183 Setup > Waypoint IDs**.
2. Complete an action:
  - Select **Names** to transmit waypoint names via NMEA 0183 while navigating.
  - Select **Numbers** to transmit waypoint numbers while navigating. This option may resolve compatibility with older NMEA 0183 autopilots.

### Viewing NMEA 0183 Diagnostic Information

The NMEA 0183 Diagnostics screen is a troubleshooting tool used by installers to verify that NMEA 0183 data is being sent across the system.

From the Home screen, select **Configure > Communications > NMEA 0183 Setup > Diagnostics**.

### NMEA 2000

GPSMAP 700 series chartplotters are NMEA 2000 certified and can receive data from a NMEA 2000 network installed on the boat to show specific information, such as depth, speed, water temperature, wind speed and direction, and engine data.

You can also name your engines and tanks so that you can better identify their location on the boat.

To connect a GPSMAP 700 series chartplotter to an existing NMEA 2000 network and to see a list of supported NMEA 2000 PGN numbers, see the *GPSMAP 700 Series Installation Instructions*.

### Viewing a List of NMEA 2000 Network Devices

You can view the devices connected to the NMEA 2000 network.

1. From the Home screen, select **Configure > Communications > NMEA 2000 Setup > Device List**.
2. Select a device for a list of options.

### Labeling Engines as Numbers

From the Home screen, select **Configure > Communications > NMEA 2000 Setup > Label Devices > Change Engine Labels > Use Numbers**.

### Labeling Engines as Names

1. From the Home screen, select **Configure > Communications > NMEA 2000 Setup > Label Devices > Change Engine Labels > Choose Names**.
2. Select the engine you want to name.
3. Select the location of the engine: **Port (P)**, **Center (C)**, **Starboard (S)**, **Fore (F)**, or **Aft (A)**.
4. Select the label you want to use for the engine.

### Labeling Tanks as Numbers

1. From the Home screen, select **Configure > Communications > NMEA 2000 Setup > Label Devices > Change Tank Labels**.
2. Select the type of tank you want to label.
3. Select **Use Numbers**.

### Labeling Tanks as Names

1. From the Home screen, select **Configure > Communications > NMEA 2000 Setup > Label Devices > Change Tank Labels**.
2. Select the type of tank you want to label.
3. Select **Choose Names**.
4. Select a tank.
5. Select the location of the tank: **Port (P)**, **Center (C)**, **Starboard (S)**, **Fore (F)**, or **Aft (A)**.
6. Select the label you want to use for the tank.

### Selecting a Preferred Data Source

If more than one data source is available, you can select the data source you want to use.

1. From the Home screen, select **Configure > Communications > Preferred Sources**.
2. Select a type of data.
3. Select a data source.

### Transmitting NMEA 0183 Data over a NMEA 2000 Network

You can turn on, configure, or turn off output bridging. Output bridging occurs when a chartplotter takes NMEA 0183 data it receives from any source, formats it into NMEA 2000 data, and sends it over the NMEA 2000 bus.

1. From the Home screen, select **Configure > Communications > Output Bridging**.
2. Complete an action:
  - Select **On** to enable output bridging from the chartplotter.
  - Select **Auto** to allow the chartplotters on the NMEA 2000 network to negotiate with each other to determine which chartplotter will perform this function. Only one chartplotter on the NMEA 2000 network can bridge NMEA 0183 data over the NMEA 2000 bus at a time.



All GPSMAP 700 series units are NMEA 2000 certified.

## Registering Your Device

Help us better support you by completing our online registration today:

- Go to <http://my.garmin.com>.
- Keep the original sales receipt, or a photocopy, in a safe place.

## Contacting Garmin Product Support

Contact Garmin Product Support if you have any questions about this product:

- In the USA, go to [www.garmin.com/support](http://www.garmin.com/support), or contact Garmin USA by phone at (913) 397.8200 or (800) 800.1020.
- In the UK, contact Garmin (Europe) Ltd. by phone at 0808 2380000.
- In Europe, go to [www.garmin.com/support](http://www.garmin.com/support) and click **Contact Support** for in-country support

## Declaration of Conformity

Hereby, Garmin, declares that this product is in compliance with the essential requirements and other relevant provisions of Directive 1999/5/EC. To view the full Declaration of Conformity, go to [www.garmin.com/compliance](http://www.garmin.com/compliance).

## Software License Agreement

BY USING THE CHARTPLOTTER, YOU AGREE TO BE BOUND BY THE TERMS AND CONDITIONS OF THE FOLLOWING SOFTWARE LICENSE AGREEMENT. PLEASE READ THIS AGREEMENT CAREFULLY.

Garmin Ltd. and its subsidiaries (“Garmin”) grant you a limited license to use the software embedded in this device (the “Software”) in binary executable form in the normal operation of the product. Title, ownership rights, and intellectual property rights in and to the Software remain in Garmin and/or its third-party providers.

You acknowledge that the Software is the property of Garmin and/or its third-party providers and is protected under the United States of America copyright laws and international copyright treaties. You further acknowledge that the structure, organization, and code of the Software, for which source code is not provided, are valuable trade secrets of Garmin and/or its third-party providers and that the Software in source code form remains a valuable trade secret of Garmin and/or its third-party providers. You agree not to decompile, disassemble, modify, reverse assemble, reverse engineer, or reduce to human readable form the Software or any part thereof or create any derivative works based on the Software. You agree not to export or re-export the Software to any country in violation of the export control laws of the United States of America or the export control laws of any other applicable country.

# Index

## A

- active tracks
  - clearing 31
  - retracing 31
  - saving 31
- add turn 28
- aerial photos 17, 20
- AIS
  - radar 59
  - targeting 12, 83
  - threats 15, 58
- alarms
  - anchor drag 51
  - arrival 51
  - clock 51
  - collision 12, 15, 58
  - deep water 77
  - fish 77
  - GPS accuracy 52
  - navigation 51
  - off course 51
  - shallow water 77
  - sonar 77
  - system 51
  - total fuel onboard 52
  - unit voltage 51
  - water temperature 77
- alignment 43
- anchor drag alarm 51
- animated currents, tides 8, 21
- antenna
  - connector 1
  - rotation speed 68
  - size 68
- apparent wind 41
- arrival alarm 51
- Auto Guidance
  - BlueChart g2 Vision 21
  - line 46
  - navigation 5
  - shoreline distance 46
- auto mag var 47
- autopilot 32

## B

- backing up data 53
- backlight 2
- backlight sensor 1
- back panel 1
- barometer 43
- basemap version 3
- blend, photo map 20

- BlueChart g2 Vision
  - aerial photos 11
  - chart symbols 5
  - data cards 17
  - Fish Eye 3D 18
  - Mariner's Eye 3D 17
  - POIs 21

- bridging, output 88
- brightness, display 2

## C

- celestial information 38
- changing charts 4
- chart data alignment 62
- charts
  - details 11
  - fishing 16
  - navigation 4
  - symbols 5, 10
- chart symbols 5
- classic, 3D terrain style 17
- clear user data 28, 30, 31, 32
- clock alarm 51
- close hauled wind gauge 42
- clutter
  - cross talk 63
  - default settings 63
  - FTC 63, 65
  - radar type 63
  - rain 63, 65
  - sea 63, 64, 65
- collision alarm 12, 15, 58
- color mode 2
- color of tracks 6, 31
- color scheme
  - radar 67
  - sonar 76
- combinations
  - customizing 22
  - selecting 22
- compass 41
- compass roses 11
- compass tape data bar 24, 49, 67
- configuration, chartplotter 44
- configure, button 3
- contact information 89
- coordinate systems 47
- courses 26, 28
- create waypoint 6, 27, 60, 74, 81
- cross talk 63, 66
- cruising mode 55
- current station indicators, configuring
  - 8
- current stations
  - indicators 8, 21
  - nearby 37
  - reports 37

## D

- dangerous depth 10
- data
  - backup 53
  - copying 52
- data cards 2
  - BlueChart g2 Vision 17
- data fields
  - chart 49
  - combination screen 23
  - radar 67
- data management 52
- data transfer 52, 53, 86
- day colors 2
- deep water alarm 77
- depth log 73
- depth shading 10
- destinations 25
  - navigating to 33
  - navigation chart 25
  - selecting 25
  - Where To? 25
- digital selective calling
  - channels 83
  - contacts 80
  - turning on 79
- distress calls 80
- DSC 79

## E

- EBL
  - measuring 59
  - showing 59
- EGNOS 85
- engine gauges 38
  - configuring 38
  - cycling screens 38
  - status alarms 39
- engines
  - labeling 87
- event log 68

## F

- factory settings 2, 86
- fish alarm 77
- Fish Eye 3D
  - data bars 48
  - object information 6
  - sonar cone 19
  - suspended targets 19
  - tracks 19

- fishing chart
      - AIS 15
      - currents 8
      - data bars 48
      - heading line 9
      - map orientation 8
      - navaids 10, 20
      - navigation 5
      - object information 6
      - panning 5
      - roses 11
      - satellite imagery 9, 20
      - tide stations 7
      - world map 9
      - zoom detail 8
    - fish symbols 19, 75
    - front-of-boat offset 69
    - front panel 1
    - FTC 63, 65
    - fuel capacity 51
    - fuel gauges
      - configuring 38, 40
      - status alarms 39
      - synchronizing with fuel 40
      - viewing 40
    - fuel onboard 52
    - full-screen view 71
  - G**
  - gain
    - default setting 63
    - large objects 64
    - radar 63
    - radar type 63
    - side lobes 64
    - sonar 76
  - Garmin Product Support 89
  - gauges
    - analog 39
    - digital 39
    - engine 38
    - limits 39
    - maximums 39
    - status alarms 39
    - trip 40
    - type 39
  - Go To 26, 33
  - GPS
    - accuracy alarm 52
    - performance 84
    - signals 2
  - GPS performance 84
  - grid north 47
  - guard zone 57
  - Guide To 26, 33
- H**
  - harbor mode 56
  - hazard colors 17
  - heading 42, 43, 67
  - heading line 9, 68
  - heading reference 47
  - home screen 3
- I**
  - IALA symbols 11
  - ID number 3
  - information, button 3
  - initial settings 2
- K**
  - keel offset 78
  - keys
    - power i
    - range 16
- L**
  - labeling engines and tanks 87
  - land-based POIs 11
  - lane width 16
  - language 2, 45
  - large-object interference 64
  - light sectors 11
- M**
  - magnetic heading 8, 43, 67
  - magnetic variation 47
  - man overboard
    - creating from a navigation screen 27
    - creating from main menu 3
    - deleting 28
    - from VHF radio 80
  - Mariner's Eye 3D
    - AIS 15
    - data bars 48
    - hazard colors 17
    - lane width 16
    - object information 6
    - range rings 16
    - safe depth 18
    - satellite imagery 17
  - marine services 11, 25, 33
  - measure distance 6
  - memory card 2, 53
  - MOB 27, 80
    - deleting 28
- N**
  - naming engines and tanks 87
  - navaids
    - configuring 10
    - selecting 8
  - Navigate To 6
  - navigation alarms 51
  - navigation chart
    - aerial photos 20
    - AIS 15
    - dangerous depth 10
    - data bars 48
    - depth shading 10
    - heading line 9
    - land-based POIs 11
    - light sectors 11
    - marine service points 11
    - navaid symbols 10
    - object information 6
    - orientation 8
    - panning 5
    - photo points 11
    - roses 11
    - satellite imagery 9
    - vessel trails 82
    - world map 9
    - zoom 4
    - zoom detail 8
  - navigation inset
    - chart 49
    - combination screen 23
    - radar 67
  - navigation lane 16
  - navigation lines 68
  - night colors 2
  - NMEA 0183 86
  - NMEA 2000 87
  - NMEA 2000 connector 1
  - no-transmit zone 68
  - NOAA symbols 11
  - noise rejection, radar 63
  - noise rejection, sonar 76
  - north heading 8, 43, 67
- O**
  - object information 6
  - off course alarm 51
  - offset
    - front of boat 69
    - keel 78
    - water temperature 78
  - offshore mode 56
  - orientation
    - compass display 43
    - map 8
    - radar display 67
  - other vessels
    - AIS 50, 58
    - projected heading 59
    - trails 50, 59, 82

- output bridging 88
- overlay, radar 61
- overlay numbers 48
- P**
- panning
  - 3D views 16
  - charts 5
- Perspective 3D
  - AIS 15
  - data bars 48
  - lane width 16
  - object information 6
  - range rings 16
- photo points 11
- photos 20
- POI data 11, 17, 21
- position format 47
- position report 81
- position tracking 81
- posn precision 86
- power/data connector 1
- power key i, 1
- preferred data source 88
- product registration 89
- product support 89
- projected course 13
- projected heading 14
- R**
- radar
  - AIS 59
  - antenna rotation speed 68
  - antenna size 68
  - clutter 63
  - color scheme 67
  - cruising mode 55
  - display modes 55
  - fast time constant 65
  - field of view 68
  - front-of-boat offset 69
  - gain 63
  - harbor mode 56
  - heading line 68
  - navigation lines 68
  - no-transmit zone 68
  - noise rejection 63
  - offshore mode 56
  - optimizing display 62
  - orientation 67
  - range 54, 62
  - range rings 68
  - sentry mode 57
  - timed transmit 57
  - transmitting 54
  - types 55, 63
  - zoom scale 54
- radar overlay 61
  - tracks 69
  - zooming in and out 62
- rain clutter 62, 63, 65
- range rings 16, 68
- rated maximum 38
- rated minimum 38
- rear panel 1
- registration 89
- reset 86
- Review 6
- roses 11
- rotating, 3D view 16
- routes
  - bypassing waypoint 30
  - copying 53
  - creating 28, 29
  - deleting 30
  - editing 29
  - label type 45
  - navigating 28, 34, 60
  - navigating backward 35, 61
  - navigating forward 35, 61
  - navigating parallel to 35, 61
  - present location 28
  - radar 60
  - turns 28, 29, 45
  - viewing list of 29
  - waypoints 29
  - Where To? 25
- Route To 26, 28, 33
- S**
- safe depth 18, 46
- safe height 46
- safe zone collision alarm 15, 58
- SART 12
- satellite imagery 16, 17, 20
- satellite signals 2
- scale maximum 38
- scale minimum 38
- scroll speed, sonar 74
- SD card slot 1, 2
- sea clutter 63, 65
- secure digital card 2
- sentry mode
  - guard zone 57
  - timed transmit 57
- settings
  - a-scope 75
  - AIS 14
  - anchor drag 51
  - antenna size 68
  - arrival 51
  - Auto Guidance 46
  - auto power up 44
  - backlight 2
  - beeper 45
  - calibrate water speed 50
  - chart borders 11
  - clock 51
  - collision alarm 15, 58
  - color mode 2
  - color scheme 67, 76
  - compass tape data bar 24, 49, 67
  - crosstalk 66
  - data bars 48
  - daylight saving time 47
  - deep water 77
  - depth line 75
  - depth units 48
  - detail 8
  - details 14, 59
  - display range 14, 59
  - distance units 48
  - DSC 79
  - elevation units 48
  - fish alarm 77
  - fish symbols 19, 75
  - frequency 76
  - front of boat 69
  - fuel capacity 51
  - gain 63, 76
  - GPS 85
  - GPS accuracy 52
  - hazard colors 18
  - heading 47
  - heading line 9, 68
  - interval 32
  - keel offset 78
  - land POIs 11
  - lane width 16
  - light sectors 11
  - look-ahd spd 68
  - map datum 47
  - navaid size 10
  - navaid type 10
  - nav lines 68
  - NMEA 0183 setup 86
  - NMEA 2000 device list 87
  - NMEA 2000 setup 87
  - no-transmit zone 68
  - off course 51
  - orientation 8, 67
  - output bridging 88
  - output sentences 86
  - overlay numbers 75
  - photo points 11
  - photos 20
  - port types 86
  - position format 47
  - posn. precision 86
  - preferred sources 88
  - pressure units 48
  - proj. heading 14, 59
  - rain clutter 65
  - range 77
  - range rings 16, 68



- record mode 32
- rings 68
- roses 11
- rotation spd 68
- route labels 45
- safe depth 18, 46
- safe height 46
- safety shading 10
- screenshot capture 85
- scroll speed 74
- sea clutter 64
- service points 11
- shallow water 77
- shoreline distance 46
- show VRM/EBL 59
- simulator 44
- sonar cone 19
- speed sources 45
- speed units 48
- spot depths 10
- stdby time 57
- style 17
- surface noise 75
- symbols 10
- system information 85
- system units 48
- temperature units 48
- temp offset 78
- tides/currents 20
- time 47
- time format 47
- time zone 47
- total fuel onboard 52
- track color 31
- turn transition 45
- unit voltage 51
- view 19
- volume units 48
- water temp 77
- whiteline 76
- world map 9
- zoom 71
- shaded relief 9
- shallow water alarm 77
- shoreline distance 46
- side lobe interference 64
- simulator mode 44
- skyview 85
- software version 3
- sonar
  - a-scope 75
  - alarms 77
  - appearance 74
  - color scheme 76
  - cone 19
  - depth line 75
  - depth scale 77
  - frequencies 76
  - gain 76
  - overlay numbers 75
  - scroll speed 74
  - surface noise 75
  - suspended targets 75
  - views 71
  - whiteline 76
- specifications 84
- speed data 45
- speed filter 50
- speed sensor 42, 45, 50, 74
- split-frequency view 72
- split zoom view 72
- spot depth soundings 10
- suspended targets 19, 75
- symbols 5, 10
- system information 85
- T**
- tanks, labeling 87
- temperature log 73
- tide station indicators, configuring 8
- tide stations
  - indicators 8, 21
  - nearby 36
- time
  - display 47
  - format 47
  - zone 47
- timed transmit 57
- total fuel onboard alarm 52
- touchscreen 84
- track log
  - interval 32
  - memory 32
- tracks
  - active 31
  - color 6, 31
  - copying 53
  - deleting 31
  - editing 31
  - editing/deleting 19
  - list 31
  - navigating 35
  - on Radar Overlay 69
  - recording 32
  - saving 31
  - saving as route 31
  - showing 30
  - Where To? 25
- transmit radar 54
- trip gauges 40
- true north 47
- true wind 41
- U**
- unit ID number 3
- units of measure 48
- unit voltage alarm 51
- V**
- vessel trails
  - appearance 83
  - duration 82
  - showing 82
- VHF radio
  - calling an AIS target 83
  - distress calls 80
  - DSC channel 83
  - individual routine calls 83
- VMG 42
- VRM
  - adjusting 59
  - measuring 59
  - showing 59
- W**
- WAAS/EGNOS 85
- water
  - speed 50
- water temperature alarm 77
- water temperature offset 78
- waypoint display 6
- waypoint identification 87
- waypoints
  - bypassing in route 30
  - copying 53
  - creating 6, 26, 60, 74
  - deleting 28
  - editing 27
  - hiding 60
  - label type 69
  - list of 27
  - man overboard 27
  - moving 27
  - navigating to 34
  - present location 26
  - radar 60
  - radar overlay, labeling 69
  - showing 60
  - sonar 74
  - tracked vessel 81
  - Where To? 25
- Where To? 33
- wind
  - apparent 41
  - true 41
- wind speed source 42
- Z**
- zoom 4, 15, 16, 71
- zoom scale 4, 54





For the latest free software updates (excluding map data) throughout the life of your  
Garmin products, visit the Garmin Web site at [www.garmin.com](http://www.garmin.com).



© 2010–2011 Garmin Ltd. or its subsidiaries

Garmin International, Inc.  
1200 East 151<sup>st</sup> Street, Olathe, Kansas 66062, USA

Garmin (Europe) Ltd.  
Liberty House, Hounsdown Business Park, Southampton, Hampshire, SO40 9LR UK

Garmin Corporation  
No. 68, Zhangshu 2nd Road,  
Xizhi Dist., New Taipei City, 221, Taiwan (R.O.C.)

[www.garmin.com](http://www.garmin.com)