



OWNER'S MANUAL

Navigation Portable

nüvi® 360



© 2006–2007 Garmin Ltd. or its subsidiaries

Garmin International, Inc.
1200 East 151st Street,
Olathe, Kansas 66062, USA
Tel. 913/397.8200
or 800/800.1020
Fax 913/397.8282

Garmin (Europe) Ltd.
Liberty House, Hounslow Business Park,
Southampton, Hampshire, SO40 9RB UK
Tel. +44 (0) 870.8501241 (outside the UK)
0808 2380000 (within the UK)
Fax +44 (0) 870.8501251

Garmin Corporation
No. 68, Jangshu 2nd Road,
Shijr, Taipei County, Taiwan
Tel. 886/2.2642.9199
Fax 886/2.2642.9099

All rights reserved. Except as expressly provided herein, no part of this manual may be reproduced, copied, transmitted, disseminated, downloaded or stored in any storage medium, for any purpose without the express prior written consent of Garmin. Garmin hereby grants permission to download a single copy of this manual onto a hard drive or other electronic storage medium to be viewed and to print one copy of this manual or of any revision hereto, provided that such electronic or printed copy of this manual must contain the complete text of this copyright notice and provided further that any unauthorized commercial distribution of this manual or any revision hereto is strictly prohibited.

Information in this document is subject to change without notice. Garmin reserves the right to change or improve its products and to make changes in the content without obligation to notify any person or organization of such changes or improvements. Visit the Garmin Web site (www.garmin.com) for current updates and supplemental information concerning the use and operation of this and other Garmin products.

Garmin®, nüvi®, and MapSource® are registered trademarks, and myGarmin™, Garmin Travel Guide™, Garmin TourGuide™, and Garmin Lock™ are trademarks of Garmin Ltd. or its subsidiaries and may not be used without the express permission of Garmin.

The Bluetooth® word mark and logos are owned by the Bluetooth SIG, Inc., and any use of such name by Garmin is under license. Windows® is a registered trademark of Microsoft Corporation in the United States and/or other countries. Mac® and iTunes® are registered trademarks of Apple Computer, Inc. The Winamp trademark is the property of Nullsoft, Inc. and its parent company, America Online, Inc. SiRF, SiRFstar, and the SiRF logo are registered trademarks, and SiRFstarIII and SiRF Powered are trademarks of SiRF Technology, Inc. Google™ and Google Earth™ are trademarks of Google Inc. Audible.com® and AudibleReady® are registered trademarks of Audible, Inc. © Audible, Inc. 1997-2005. Multilingual Wordbank © Oxford University Press 2001. Multilingual Phrasebank © Oxford University Press 2001. Pocket Oxford-Hachette French Dictionary © Oxford University Press and Hachette Livre 2005. Pocket Oxford-Duden German Dictionary © Oxford University Press and Bibliographisches Institut & F.A. Brockhaus 2003. Pocket Oxford Spanish Dictionary © Oxford University Press 2005. Pocket Oxford Italian Dictionary © Oxford University Press 2004. Oxford Portuguese Minidictionary © Oxford University Press 2002. RDS-TMC Traffic Information Services France © ViaMichelin 2006. Other trademarks and trade names are those of their respective owners.



PREFACE

Manual Conventions

When you are instructed to “touch” something, use your finger to touch an item on the screen. Small arrows (>) appear in the text. They indicate that you should touch a series of items on the nüvi screen. For example, if you see “touch **Where to > My Locations**,” you should touch the **Where to** button, and then touch the **My Locations** button.

Contact Garmin

Contact Garmin if you have any questions while using your nüvi. In the USA, contact Garmin Product Support by phone: 913/397.8200 or 800/800.1020, Monday–Friday, 8 AM–5 PM Central Time; or go to www.garmin.com/MINI. In Europe, contact Garmin (Europe) Ltd. at +44 (0) 870.8501241 (outside the UK) or 0808 2380000 (UK within the UK).

myGarmin™

Go to <http://my.garmin.com> to access the latest services for your Garmin products. From the myGarmin Web site, you can do the following:

- Register your Garmin unit.
- Subscribe to online services.
- Unlock optional maps.





Return to myGarmin often for new Garmin product services.

TABLE OF CONTENTS

Preface	iii	Where to	10
Manual Conventions	iii	Finding Your Destination	10
Contact Garmin	iii	Finding an Address	10
myGarmin™	iii	Finding a Place by Spelling the Name ..	11
Tips and Shortcuts	vi	Finding a Place Using Coordinates	12
About Google Earth™	vi	Finding a Place Using the Map	12
Getting Started	1	Expanding Your Search	13
What Is in the Box?	1	Adding a Stop to Your Route	13
Mounting the nüvi	2	Adding a Detour to Your Route	14
Basic Operation	3	Stopping Your Route	14
Turning the nüvi On or Off	3	My Locations	15
Charging the nüvi	3	Understanding My Locations	15
Acquiring Satellites	3	Saving Places That You Search For	15
Changing the Volume, Brightness, and		Finding Saved Places	15
Screen Lock	4	Saving Your Current Location	15
Resetting Your nüvi	4	Setting a Home Location	16
Clearing User Information	4	Editing Saved Places	16
Locking Your nüvi	5	Travel Kit	17
Main Pages	6	Listening to MP3 Files	17
Understanding the Menu Page	6	Playing Audible Books	19
Understanding the Map Page	7	Viewing Pictures	22
Understanding the Trip Information		Using the World Clock	23
Page	7	Converting Currency	23
Understanding the Turns Preview Page ..	8	Converting Measurements	24
Understanding the Next Turn Page	9	Using Bluetooth® Technology	25
		Calling a Number	26
		Calling a Place	27
		Receiving a Call	27
		Using Call Waiting	28

Transferring Audio to Your Phone	28	Changing the Proximity Points Settings.....	43
Using the Phone Book	28	Appendix	44
Using Call History	28	Updating the nüvi Software.....	44
Calling Home	29	Purchasing and Loading Additional	
Using Voice Dial.....	29	MapSource Maps	44
Using Status	29	Custom POIs (Points of Interest)	46
Using Text Messaging.....	30	Optional Accessories	47
Dropping a Connection	30	About GPS Satellite Signals	51
Removing a Phone from the List	30	Caring for Your nüvi	52
Using FM Traffic.....	31	Battery Information	53
Connecting the FM Traffic Receiver	31	Troubleshooting	54
Viewing Traffic Incidents	32	Specifications.....	57
Avoiding Traffic	32	Important Safety and Product	
Purchasing an Additional Traffic		Information	58
Subscription	33	Index	61
Managing Files on Your nüvi.....	34		
Supported File Types	34		
Loading Items to Your nüvi	35		
Information about Your nüvi Drives.....	37		
Deleting Files from the nüvi	37		
Customizing the nüvi	38		
Restoring Settings	38		
Changing the Map Settings	38		
Changing the System Settings	39		
Changing the Locale Settings.....	40		
Changing the Display Settings.....	41		
Changing the Navigation Settings	42		
Changing the Bluetooth Settings	42		
Changing the Traffic Settings.....	43		

Tips and Shortcuts

- To quickly return to the Menu page, touch and hold **Back**.
- To jump from any page back to the media player when you are listening to music or an audio book, quickly press the  **Power** button twice.
- To extend the battery life, close the GPS antenna when you do not need to use the nüvi for navigation. You can also decrease the brightness.
- To access the Quick Settings page, quickly press and release the  **Power** button. You can also touch  on the Menu page.
 - To adjust the volume or brightness, move the sliders.
 - To prevent accidental screen taps, touch **Lock**. To unlock the screen, press the  **Power** button.
- To learn more about the nüvi Bluetooth® technology or Travel Kit features, touch the **Help** button on the appropriate screen.

About Google Earth™

Go to <http://earth.google.com> to download the Google Earth application. With Google Earth installed on your computer, you can view your nüvi waypoints and track log. Connect the nüvi to your computer using the USB cable. Open Google Earth. From the File menu, select **Open**, and browse for your *.GPX file (for instance, F:\Garmin\gpx\Current.gpx).

GETTING STARTED

What Is in the Box?

- **Carrying case** to protect your nüvi from scratches and accidental screen taps.
- **AC charger** to receive power from a wall outlet.
- **USB cable** to connect the nüvi to your computer.
- **Yellow sheet** that contains your unit's serial number, registration number for registering on Garmin's Web site, and unlock code for future reference.
- **Quick reference guide** and **owner's manual** for product information.

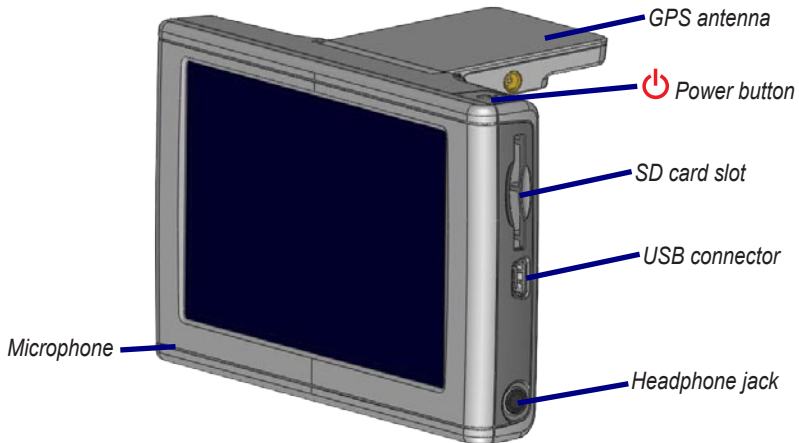

Mounting the nüvi

To mount the nüvi:

1. Flip up the GPS antenna.
2. Fit the bottom of your nüvi into the cradle.
3. Tilt the nüvi back until it snaps into place.

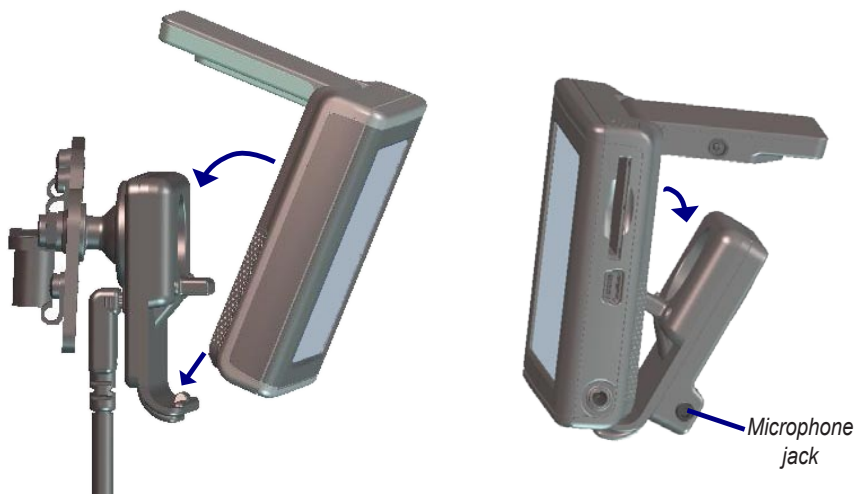

If you use an external microphone (optional), plug it into the right side of the cradle.

To remove your nüvi from the cradle, press the small tab on the bottom of the cradle up, and tilt the nüvi forward.

BASIC OPERATION

Turning the nüvi On or Off

Press and hold the  **Power** button on the top of the nüvi.

Charging the nüvi

To charge the nüvi, use one of the following methods:

- Connect the nüvi to the mount and start your vehicle.
- Connect the USB cable to the nüvi and your computer.
- Connect the AC adapter to the nüvi and a wall outlet.

Acquiring Satellites



Before the nüvi can find your current location and navigate a route, you must do the following:

1. Go outdoors to an open area, away from tall buildings and trees.
2. Flip up the GPS antenna on the back of the nüvi so that it is parallel to the ground.
3. Turn on the nüvi. Acquiring satellite signals can take a few minutes.



The  bars indicate satellite strength. When the bars are green, the nüvi has acquired satellite signals; now you can select a destination and navigate to it. To use the nüvi indoors, close the GPS antenna.

Changing the Volume, Brightness, and Screen Lock

1. Press and quickly release the  **Power** button, or on the Menu page, touch .
2. Move the sliders to adjust the volume and brightness. To prevent accidental screen taps, touch **Lock**. To unlock the screen, press the  **Power** button.

Resetting Your nüvi

If the nüvi screen stops functioning, turn the nüvi off and on again. If this does not help, do the following:

1. Disconnect the nüvi from external power.
2. Flip up the GPS antenna.
3. Press the **Reset** button.
4. Connect the nüvi to a power source. The nüvi should automatically turn back on and operate normally.

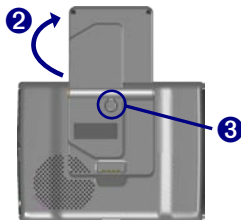

Clearing User Information



CAUTION: This procedure deletes all information that you have entered.

1. Hold your finger on the upper-right corner of the nüvi's screen while you turn on the nüvi. Keep your finger pressed until the pop-up window appears.
2. Touch **Yes**. All factory settings are restored. Your recent selections and audio bookmarks are also deleted.

Locking Your nüvi

Garmin Lock™ is an anti-theft feature. You can set a four-digit PIN (personal identification number) and a security location; then every time the nüvi is powered on you must enter the PIN or drive to your security location. Select any location, such as your home or office, for your security location. Write down your PIN, and keep it in a safe place. If you forget your PIN, you can go to your security location to unlock the nüvi.

To help prevent theft of the nüvi, apply the Garmin Lock sticker to the inside of a vehicle window, and do the following:

1. Flip up the GPS antenna.
2. On the Menu page, touch  **Settings** > **System**.
3. Touch the button next to **Garmin Lock**. Touch **OK**.
4. Enter a four-digit PIN. Touch **Yes** to accept the PIN.
5. Touch **OK**. Drive to a security location, and touch **Set**.
6. Each time you turn on the nüvi, enter the four-digit PIN or drive to the security location (with the antenna up).



NOTE: If you forget your PIN and your security location, you must send your nüvi to Garmin to get it unlocked.

MAIN PAGES

Understanding the Menu Page

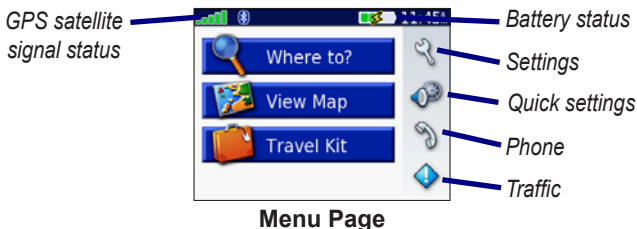

- **GPS satellite signals**—represents the satellite signals being received by your nüvi. When you see green bars, you have a strong signal.
- **Battery status**—represents the status of the battery charge. The lightning bolt symbol indicates that the nüvi is currently charging.
- **Settings**—accesses the nüvi settings.
- **Quick settings**—accesses the settings for volume, brightness, and screen lock.
- **Phone**—appears when you pair the nüvi with a phone; accesses phone features.
- **Traffic**—appears when you connect an FM traffic receiver; accesses the traffic incident list.

Understanding the Map Page

From the Menu page, touch  **View Map** to open the Map page. The  vehicle icon shows your current location.



Map Page while Navigating a Route

Understanding the Trip Information Page

The Trip Information page displays your current speed and provides helpful statistics about your trip. To view the Trip Information page, touch **Speed** or **Arrival** on the Map page.

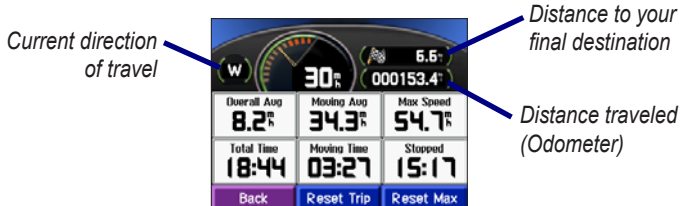

Trip Information Page

Resetting Trip Information

Touch **Reset Trip** to reset the Trip Information page before beginning a trip. If you make frequent stops, leave the nüvi turned on so it can accurately measure elapsed time during the trip. Touch **Reset Max** to reset the Maximum Speed.

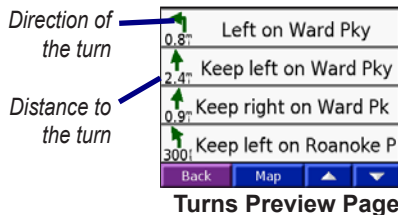

Understanding the Turns Preview Page

Touch the green text bar on the top of the Map page to open the Turns Preview page. This page displays all turns in the route and the distance between turns. Touch a turn on the list to view the Next Turn page for that turn. Touch **Map** to view the entire route on the map.



Understanding the Next Turn Page

The Next Turn page displays the upcoming turn on the map and the distance and time remaining before you reach the turn. To view an upcoming turn on the map, touch **Turn In** on the Map page, or touch any turn from the Current Route page.

Touch  or  to view other turns in the route. When you are finished viewing the Next Turn page, touch **Back**.

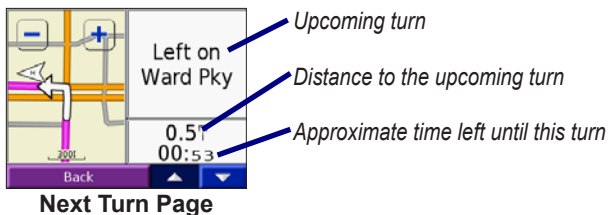



WHERE TO

Finding Your Destination

Flip up the antenna on the nüvi to get satellite signals. Use the Garmin nüvi to find your destination and navigate to it.



1. On the Menu page, touch  **Where to**.
2. Search for your destination. Touch the arrows for more choices.
3. Touch **Go**.

Following Your Route

Follow the route to your destination using the Map page. As you travel, the nüvi guides you to your destination with voice prompts, arrows on the map, and directions at the top of the Map page. If you depart from the original route, the nüvi recalculates the route and provides new route instructions.

- The vehicle icon  shows your location.
- Your route is marked with a purple line.
- Follow the arrows as you take turns.
- A checkered flag marks your destination.

Finding an Address

1. On the Menu page, touch  **Where to** >  **Address**.
2. Select a country (if necessary), state, and city. If you are not sure of the city, select **Search All**.
3. Type the address number, and touch **Done**.

4. Type the street name until a list of streets appears.
5. Select the street. If more than one matching address is found, select the one that you want.
6. Touch **Go**.







TIP: You can search for a postal code. Enter the postal code instead of the city name. (Not all map data provides postal code searching.)

NOTE: Finding an intersection is very similar to finding an address. Touch **Intersection**, and enter the two street names.

Finding a MINI Dealer

1. Touch  **Where to** > **MINI Dealer**. The nüvi finds the MINI dealer closest to your current location.
2. Select a MINI dealer, and save it to your Favorites (see [page 15](#) for more information).

Finding a Place by Spelling the Name

1. On the Menu page, touch **Where to** >  **Spell Name**.
2. Using the on-screen keyboard, enter letters contained in the name. Touch  to enter numbers. Touch  to delete the last character entered; touch and hold  to delete the entire entry.
3. Touch **Done**.
4. Select the place you want to visit.
5. Touch **Go**.



TIP: In a search results list, if you do not see the place you want to visit, or you want to narrow your search results list, touch **Spell** and enter the name or part of the name.

Finding a Place Using Coordinates



You can find a place by entering the location coordinates. This can be helpful if you enjoy geocaching.

1. On the Menu page, touch  **Where to** > **Coordinates**.
2. Enter the coordinates for your destination, and touch **Next**.
3. Touch **Go**.

Finding a Place Using the Map

Touch  **Where to** >  **Browse Map**.

Tips for Browsing the Map

- Touch the map and drag to view different parts of the map.
- Touch  and  to zoom in and out.
- Touch anywhere on the map. An arrow points to the location.
 - Touch **Go** to navigate to the selected location.
 - Touch **Save** to save this location to your **Favorites**.
 - If the GPS is turned off, touch **Set Loc.** to set the location.

Viewing Places on the Map

You can view a place you have found on the Map page.

1. Touch **Show Map**.
2. Drag the map, and zoom in or out, as necessary. Touch **Back** when you are finished.

Expanding Your Search

1. From the Menu page, touch  **Where to > Near**.
2. Select an option:

Where I Am Now—searches for places near your current location.

A Different City—searches for places near the city you enter.

My Current Route—searches for places along the route you are currently navigating.

My Destination—searches for places near your current route destination.

3. Touch **OK**.



NOTE: Your nÜvi automatically searches for places near your current location.

Adding a Stop to Your Route

You can add one stop (via point) to your route. The nÜvi gives you directions to the stop and then to your final destination.

1. When navigating a route, touch  **Where to** on the Menu page.
2. Search for a location at which you want to stop before your final destination.

3. Touch **Go**.
4. Touch **Yes** if you want to stop at this via point before your final destination, or touch **No** if you want this new location to become your new final destination.

Adding a Detour to Your Route

If you want the nÜvi to try to calculate a new route to avoid something ahead of you, use the following procedure.

1. On the Map page, select **Menu** to return to the Menu page.
2. Select **Detour**. If possible, the nÜvi creates a new route.

The nÜvi attempts to get you back on your original route, as soon as possible.

If the route you are currently taking is the only reasonable option, the nÜvi might not calculate a detour.

Stopping Your Route

If you want to stop your current route, return to the Menu page and touch **Stop**.

 **MY LOCATIONS**

Understanding My Locations

You can save your favorite places in  **My Locations**.



Saving Places That You Search For

1. After you search for a place you want to save, touch **Save**.
2. Touch **OK**. The place is saved in  **My Locations** > **Favorites**.

Finding Saved Places

1. On the Menu page, touch  **Where to** >  **My Locations** > **Favorites**.
2. Select a place.
3. Touch **Go**.

Saving Your Current Location

1. On the Menu page, touch  **Where to** >  **My Locations** > **My Current Location**.
2. Touch **Save**, enter a name, and touch **Done**. The place is saved in  **My Locations** > **Favorites**.



Setting a Home Location

You can set a home location for the place you return to most often. Your home location is saved in **Favorites**.

1. On the Menu page, touch  **Where to** >  **My Locations** > **Set Home**.
2. Select an option.



If you want to change your home location after you have already set it, follow the procedure for “Editing Saved Places.”

Going Home



After you set your home location, you can route to it at any time. Touch  **Where to** >  **My Locations** > **Go Home**.

Editing Saved Places

You can change the name, symbol, or phone number of a saved place.

1. On the Menu page, touch  **Where to** >  **My Locations** > **Favorites**.
2. Select the place you want to edit.
3. Touch **Edit**.
4. Touch the appropriate option, and make the changes.

Deleting Saved Places

1. On the Menu page, touch  **Where to** >  **My Locations** > **Favorites**.
2. Select the place you want to delete.
3. Touch **Edit** > **Delete** > **Yes**.



 **TRAVEL KIT**

The Travel Kit provides many features that are helpful when you are traveling. Touch **Help** to learn more about the nüvi Travel Kit.

1. On the Menu page, touch  **Travel Kit**.
2. Touch the item you want to open.

To purchase a Travel Kit accessory, go to www.garmin.com/MINI, and click **Accessories**. You can also contact your Garmin dealer to purchase nüvi accessories.

Listening to MP3 Files

1. On the Menu page, touch  **Travel Kit** >  **MP3 Player** > **Browse**.
2. Select a category.
3. To play the entire category from the beginning of the list, touch **Play All**. To play starting with a specific song, touch the title.
4. Touch **Back** to exit the MP3 page.

Touch  to adjust the volume.

Tap  to go to the beginning of the song; touch and hold to rewind the song.

Tap  to skip to the next song; touch and hold to fast forward the song.

Touch  to pause the song.

Touch  to repeat. Touch  to shuffle.

When you are listening to music or an audio book, quickly press the  **Power** button

twice to jump from any page back to the player page. Touch **Back** to return to the previous page you were viewing (such as the map).



NOTE: The nüvi plays MP3 files only. It does not support iTunes® M4A/M4P files.



Using a Playlist

This feature involves managing files on your nüvi (see [pages 34–37](#)).

1. Using your computer and an audio program such as Winamp™, create a playlist of MP3 files.
2. Save the playlist as an M3U file.





NOTE: You may need to edit the M3U file with a text editor, such as Notepad, to remove the path (location) to the MP3. The M3U file should only list the MP3 files in your playlist, not their location. Refer to the audio program's Help file for instructions.

3. Transfer the playlist and the associated MP3 files to the “nüvi” or “nüvi SD” drive. The M3U file must be in the same location as the MP3 files.
4. On the nüvi, touch  **Travel Kit** >  **MP3 Player** > **Browse** > **Import Playlist**. All available playlists appear.
5. Touch a playlist to start playing the MP3 files. You cannot change the order of the playlist from your nüvi.

Playing Audible Books

Your nüvi provides sample Audible books, which are only portions of the book. Purchase full books from Audible.com at www.garmin.audible.com.

1. On the Menu page, touch  **Travel Kit** >  **Audible Book Player**.
2. Touch **Browse**.
3. Touch a category, and then touch a book title.

Touch  to adjust the volume.



Tap  to jump back. Tap  to skip ahead. Touch and hold to move more quickly.

Touch  to pause the book.

Touch the book cover art to view book information.

When you are listening to music or an Audible book, quickly press the  **Power** button twice to jump from any page back to the player page. Touch **Back** to return to the previous page you were viewing (such as the Map page).

Using Bookmarks

To create a bookmark, touch  and **Bookmark**. To view your bookmarks, touch  and then touch a bookmark. Touch **Play** to listen to the book from the bookmark.

Loading Audible Books to Your nüvi

To purchase a book, go to www.garmin.audible.com, and create an Audible.com account. After you create an account, download AudibleManager to your personal computer. Then you can purchase a book and download it to your nüvi.

Step 1: Activate Your nüvi with AudibleManager

Before you can listen to a book you have downloaded from Audible.com, you must activate your nüvi. This is a one-time process.

1. Disconnect your nüvi from your computer: double-click the **Unplug or Eject**  icon in your system tray. Select **USB Mass Storage Device**, and click **Stop**. Select the nüvi drives, and click **OK**. Unplug the USB cable from your nüvi.
2. From your computer's desktop, double-click the **AudibleManager** icon to open AudibleManager.
3. In the Choose your device window, check the box next to "Garmin - nüvi". Click **Next**.
4. Enter your Audible user name and password. Click **Next**.
5. Connect your nüvi to your computer using the USB cable. Wait a few moments for AudibleManager to detect your nüvi.
6. Select **Activate my player(s)**, and click **Next**.
7. Please wait while AudibleManager attempts to activate your nüvi. Upon completion, you will receive a message saying the process has been successful. Click **Finish**.



NOTE: If you are unable to connect to the Internet or have any other problems activating your nüvi, refer to the AudibleManager Help file. Select **Help** from the menu, and then click **Help**.



Step 2: Download the book to your computer

Refer to AudibleManager's Help file for detailed instructions about downloading books to your computer and loading them on your nüvi.

1. Connect the nüvi to your computer.
2. From your computer's desktop, double-click the **AudibleManager** icon to open AudibleManager.
3. Click the **Go to My Library Online**  button on the top center of the window. Your Audible.com library opens, displaying the books you have purchased.
4. Click **Get it Now** to download the book to your computer.
5. Select a format, and click **Download**.

Step 3: Transfer the book to your nüvi

Refer to AudibleManager's Help file for detailed instructions about downloading books to your computer and loading them on your nüvi. You must first activate your nüvi before transferring books.

1. Connect the nüvi to your computer.
2. Open **AudibleManager**.
3. Select the Internal Drive or External Drive (SD card) in the lower portion of the window. (Insert an SD card into your nüvi if loading books onto an SD card.)
4. Select the book title. Click the **Add to Garmin - nüvi**  button in the top left corner.
5. Select how much of the book you want to load. You can load small sections at a time to save memory. Click **OK**. AudibleManager transfers the book to your nüvi.
6. When you are finished, double-click the **Unplug or Eject Hardware** icon . Click **Stop**, and then click **OK**.

Viewing Pictures

You can view pictures that you have stored in your nüvi using the Picture Viewer. See [page 35](#) for more information about loading pictures onto your nüvi.

1. On the Menu page, touch  **Travel Kit** >  **Picture Viewer**.
2. Touch a picture to view a larger image of it.





TIP: Touch **Rotate** to rotate the image 90°.



Viewing a Slide Show

Touch **Slide Show** to start a slide show, which displays each image for a few moments and then displays the next image. You can zoom in or out and pan by dragging the picture with your finger. Touch anywhere on the screen to stop the slide show.

Using the World Clock



1. On the Menu page, touch  **Travel Kit** >  **World Clock**.
2. To change a city listed, touch the city.
3. Select a new time zone (or city). Touch **OK** when done.
4. Touch **World Map** to view a map.
5. Nighttime hours are shown in the shaded area. Touch **World Clock** to view the clocks again, or touch **Back** to exit.

Converting Currency

1. On the Menu page, touch  **Travel Kit** >  **Currency Converter**.
2. Touch a currency button to change the currency.
3. Select a currency, and touch **OK**.
4. Touch the blank rectangle under the currency rate you want to convert.
5. Enter the number. Touch **Done**.
6. Touch **Clear** to convert a different value.

Updating Conversion Rates

The nüvi allows you to update the currency conversion rates manually so that you are always using the most current rates.



1. On the Menu page, touch  **Travel Kit** >  **Currency Converter**.
2. Touch **Update**.
3. Touch the rate you want to update.
4. Touch  to erase the current rate. Enter a new rate, and touch **Done**.
5. Touch **Save** to finish.

TIP: Touch **Restore** to use the original conversion rate.

TIP: Touch and hold  to erase the entire entry.



Converting Measurements

1. On the Menu page, touch  **Travel Kit** >  **Measurement Converter**.
2. Select a type of measurement, and touch **OK**.
3. Touch a unit of measure that you want to change.
4. Select a unit of measure, and touch **OK**. Repeat, if necessary.
5. Touch the blank rectangle to enter a value.
6. Enter a value, and touch **Done**.
7. Touch **Clear** to enter another measurement.

USING BLUETOOTH® TECHNOLOGY

If you have a phone with Bluetooth wireless technology, and your phone is supported by the nüvi (see www.garmin.com/bluetooth), you can use your nüvi as a hands-free device. Hands-free phone features on the nüvi are only available if your phone supports that feature using Bluetooth technology (for example, phone book, voice dial, and call waiting). You can speak into the microphone on the front of the nüvi, and listen to the conversation over the nüvi speaker. To use this hands-free feature, you must pair (connect) your phone with the nüvi. You can initiate this pairing from the phone settings or from the nüvi settings. Refer to your phone's documentation for more information.

To pair using the phone settings:

1. Access the phone's Settings menu.
2. Access the phone's Bluetooth technology settings. Sometimes these are in a Bluetooth, Connections, or Hands-free menu.
3. Search for devices. The nüvi must be 10 meters or closer and turned on.
4. Select the nüvi from the list of devices.
5. Enter the nüvi PIN code (or passkey), 1234, on your phone.

To pair using the nüvi settings:

1. Confirm that your phone is supported by the nüvi.
(See www.garmin.com/bluetooth.)
2. On the Menu page, touch  **Settings** > **Bluetooth**.
3. Ensure that the Bluetooth button is set to **Enabled**.

4. Touch **Add** (or touch **Change**, if you already added).
5. If adding, set your phone to Find Me/Discoverable mode, and touch **OK** on the nüvi. Select your phone on the list. Enter the nüvi PIN code (or passkey), 1234, on your phone.



OR

If changing, select your phone and touch **OK**, or touch **Add Device** and **OK**.

6. If the pairing is successful, the  Phone icon appears on the nüvi Menu page.



When you turn on the nüvi, it tries to pair with the last phone with which it paired. After the initial pairing, you can set some phones to automatically attempt pairing with a designated device when the phone is turned on.

To enable or disable the Bluetooth technology:

1. On the Menu page, touch  **Settings** > **Bluetooth**.
2. Set the Bluetooth field to **Enabled** to turn on the Bluetooth technology of your nüvi. Then you must pair the nüvi with your phone to use the technology. The  **Bluetooth** icon appears on the Menu page if the nüvi is enabled.

To disconnect your nüvi from your phone, or to prevent a phone from automatically pairing, touch **Disabled**.



Calling a Number

1. Ensure that your phone is paired with the nüvi.
2. On the Menu page, touch  **Phone** >  **Dial**.
3. Enter the number, and touch **Dial**.
4. To end the call, touch , and then touch **End Call**.

If you are calling a number that requires that you enter information using a keypad during the call (for example, entering a password for your voicemail), do the following:

1. During the call, touch  > **Call Options** > **Touch Tones**.
2. Enter the information. Touch **Back** twice when finished.
3. To end the call, touch **End Call**.

Calling a Place

1. Ensure that your phone is paired with the nÜvi.
2. On the Menu page, touch  **Phone** >  **POI Dial**.
3. Search for the place that you want to call.
4. Touch **Dial**.
5. To end the call, touch , and then touch **End Call**.



NOTE: You can also call a place that you find using the **Where to** menu.

Receiving a Call

1. Ensure that your phone is paired with the nÜvi.
2. When you receive a call, a message appears on the nÜvi. Touch **Answer**.
3. To end the call, touch , and then touch **End Call**.

Using Call Waiting

If you get a call waiting call, the nüvi displays the Incoming Call window. Touch **Answer**. The first call is placed on hold.

To switch between calls:

1. During the call, touch  > **Switch To**.
2. Touch **End Call** to hang up; this does not disconnect the call on hold.

Transferring Audio to Your Phone

This feature can be helpful if you are using the hands-free features of the nüvi, and you want to get out of a vehicle without disconnecting your call.

To transfer audio to your phone:

1. During the call, touch  > **Call Options** > **Transfer Audio to Phone**.
2. Continue your call using your mobile phone.

Using the Phone Book

If your phone supports phone book transfer, when your phone pairs with the nüvi, the phone book automatically loads into the nüvi. After pairing, it might take a few minutes for the phone book to be available. You can then place a call using your phone book entries. On the Menu page, touch  **Phone** > **Phone Book**.

Using Call History



Touch **Call History** to access information about the phone numbers that you last dialed, last received calls from, and those calls that you missed.

Calling Home

1. Touch **Call Home** to set up or change your home information, so that you can quickly call home. The first time that you use this function, follow the prompts to enter your home information, and then touch **Save**.
2. If you want to set your phone number, follow the prompts, and then touch **Done**. The nüvi calls your home phone number.

Changing Your Home Phone Number

If you want to change your home phone number after you have previously set it, use the following procedure:

1. On the Menu page, touch  **Where to** >  **My Locations** > **Favorites**.
2. Touch **Home**.
3. Touch **Edit**.
4. Touch **Change Phone Number**.

Using Voice Dial

To use the Voice Dial function of the nüvi, your phone must support voice dial and must be set up properly to take voice commands. On the Menu page, touch  **Phone** > **Voice Dial**.

Using Status

To access information about the phone signal, battery status, and carrier name of your phone service, on the Menu page, touch  > **Status**.

Using Text Messaging

If your phone supports text messaging, you can access text messaging functions on the nüvi. After pairing, it might take a few minutes for text messages to be available. On the Menu page, touch  **Phone** > **Text Message**.

- To view your messages, touch **Inbox**, **Outbox**, or **Drafts**; and touch a message. You can reply to or forward a text message.
- To create a new text message, touch **Compose**.



NOTE: Messages sent from your nüvi do not appear in your phone's outbox.

Dropping a Connection

1. On the Menu page, touch  **Settings** > **Bluetooth**.
2. Touch **Change**.
3. Touch the device name that you want to drop, and then touch **Drop**.
4. To confirm, touch **Yes**. If you want to use hands-free functions with this dropped phone again, you do not have to pair this phone and the nüvi again.

Removing a Phone from the List

1. On the Menu page, touch  **Settings** > **Bluetooth**.
2. Touch **Change**.
3. Touch the device name that you want to remove, and then touch **Delete**.
4. To confirm, touch **Yes**. If you want to use hands-free functions with this removed phone again, you must pair this phone and the nüvi again.

USING FM TRAFFIC

If you are using a traffic receiver, you can view traffic information on your nüvi. When a traffic message is received, your nüvi displays the incident on the map, and you can change your route to avoid the traffic incident. For traffic data coverage areas, go to www.garmin.com/fmtraffic.



NOTE: The FM traffic receiver and nüvi must be in data range of an FM station transmitting traffic data to receive traffic information.



NOTE: Garmin is not responsible for the accuracy of the traffic information. The FM traffic receiver simply receives signals from the traffic service provider and displays that information on your nüvi.



NOTE: You can only access the traffic information if the nüvi is connected to an FM traffic receiver.

Connecting the FM Traffic Receiver

1. Place your nüvi into the mount.
2. Plug the mini-USB cable from the FM traffic receiver into the USB connector on the side of the nüvi.

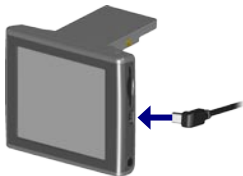





Connecting the FM Traffic Receiver

Viewing Traffic Incidents













1. On the Menu page, touch  to display a list of traffic incidents.
2. Select an item to view details.
3. Select an option.

Avoiding Traffic

The Map page displays  or  in the lower-right corner of the screen when there is a traffic incident on your current route or road.



1. From the Map page, touch  or .
2. Select an item to view details.
3. Touch **Avoid**.

Traffic Symbols

North American	Meaning	International
	Road Condition	
	Road Construction	
	Congestion	
	Accident	
	Incident	
	Information	

Severity Color Code

The bars to the left of the traffic symbols indicate the traffic incident's severity:

-  Green = Low severity; traffic is flowing normally.
-  Yellow = Medium severity; traffic is a bit congested.
-  Red = High severity; traffic is heavily congested or stopped.



Purchasing an Additional Traffic Subscription

To renew or add traffic subscriptions, go to www.garmin.com/fmtraffic.



NOTE: You do not need to activate the subscription included with your FM traffic receiver (if it came with one). The subscription activates automatically after your nüvi acquires satellite signals while receiving traffic signals from the pay service provider.

Adding a Subscription

1. On the Menu page, touch  **Settings** >  **Traffic** > **Add**.
2. Write down the FM traffic receiver's unit ID. Go to www.garmin.com/fmtraffic to purchase a subscription and get a code.
3. After you receive the 25-character code, touch **Next** on the nüvi, and enter the code.
4. Touch **Done**.

You must obtain a new code each time you renew your service. If you own multiple FM traffic receivers, you must obtain a new code for each receiver.

MANAGING FILES ON YOUR NÜVI

You can store files (such as JPEG images and MP3 music files) in the nüvi's internal memory or on an optional SD card.



NOTE: The nüvi is not compatible with Windows® 95, Windows 98, or Windows Me. This is a common limitation of most USB Mass Storage devices.

Supported File Types

- MP3 music files
- JPG image files
- AA audio book files
- GPI custom POI files from Garmin's POI Loader
- GPX waypoint files from MapSource
- Maps from MapSource



NOTE: The nüvi does not support iTunes® M4A/M4P files.

Loading Items to Your nüvi

Step 1: Insert an SD Card (Optional)

The SD card slot is located on the side of the nüvi. To insert the card, press it in until it clicks.

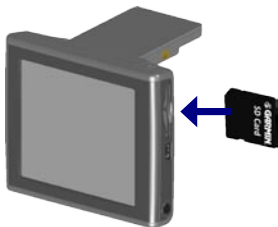

Inserting an SD Card

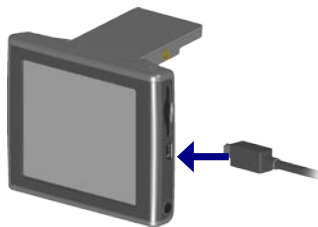

Connecting the USB Cable

Step 2: Connect the USB Cable

1. Plug the small end of the USB cable into the connector on the side of the nüvi.
2. Connect the larger end of the USB cable to an available USB port on your computer.

After you connect your nüvi to your computer, one or two additional drives appear in your computer's list of drives: "nüvi" and "nüvi sd." "nüvi" is the available storage in the nüvi's internal memory. "nüvi sd" appears if an SD card is inserted into the nüvi.



NOTE: On some operating systems, the nüvi drives may not be named automatically. See your Help file to learn how to rename the drives.

Step 3: Transfer Files to the nüvi

On a Windows PC:

1. Connect the nüvi to your computer.
2. Double-click the  **My Computer** icon on your computer's desktop.
3. Browse your computer for the file you want to copy.
4. Highlight the file and select **Edit > Copy**.
5. Open the "nüvi" or "nüvi sd" drive.
6. Select **Edit > Paste**. The file then appears in the list of files on the nüvi memory or SD card.

On a Mac:



1. Connect the nüvi to your computer as described on the previous page. Your drive should mount onto your Mac Desktop as two mounted volumes (drives): the "nüvi" and "nüvi sd" volumes.
2. To copy files to your nüvi or SD card, drag and drop any file or folder onto the volume icon. Double-click the volume to open it. To help manage the files, add folders (press the **Command + Shift + N** keys).

Step 4: Disconnect

From a Windows PC:

1. When you are finished transferring files, double-click the **Unplug or Eject**  icon in your system tray.
2. Select "USB Mass Storage Device," and click **Stop**.
3. Select the nüvi drives, and click **OK**. You can disconnect your nüvi from your computer now.

From a Mac:

1. When you are finished transferring files, drag the volume icon to the **Trash**  (it turns into an Eject  icon) to unmount the device.
2. Disconnect your nüvi from your computer now.

Information about Your nüvi Drives

For files that you manually load onto your nüvi, like your MP3 or JPEG files, you can paste them anywhere in the “nüvi” and “nüvi sd” drives. If another program, such as POI Loader, places a file in a specific folder, keep that file in that specific folder.

Deleting Files from the nüvi

You can delete files from your nüvi just as you would delete files from your computer. Select the file that you want to delete from your nüvi, and press the **Delete** key on your computer’s keyboard.



CAUTION: If you are not sure about a file’s purpose, do **NOT** delete it. Your nüvi memory contains important system files that should **NOT** be deleted. Be especially cautious of files located in folders entitled “Garmin.”

CUSTOMIZING THE NÜVI

Restoring Settings

To restore all settings you have changed, touch  **Settings** > **Restore**.

To restore settings for an individual category, touch **Restore** on that particular page.

Changing the Map Settings

To change the map settings, on the Menu page, touch  **Settings** > **Map**.

Map Detail—adjust the amount of detail shown on the map. Displaying more detail causes the map to redraw more slowly.

Map View—change the perspective of the Map page.

- **Track Up**—display the map in two dimensions (2D) with your direction of travel at the top.
- **North Up**—display the map in 2D with North at the top.
- **3D View**—display the map in three dimensions (3D), Track Up orientation. This is the default map view.

Vehicle—choose a vehicle for your map. The default is . For more vehicles, go to www.garmin.com/vehicles.

Map outlines—turn on this setting if you load supplemental maps onto your nüvi and you want to see what areas the supplemental maps cover.

Map Info—view the maps loaded on your nüvi and their versions.

Changing the System Settings

To change the system settings, touch  **Settings** > **System**.

WAAS/EGNOS—turning on the WAAS/EGNOS setting might improve GPS accuracy, but it consumes more battery power. For information about WAAS/EGNOS, go to www.garmin.com/aboutGPS/waas.html.

Safe Mode—turn on or off the Safe Mode feature. When your vehicle is moving, Safe Mode disables all unit functions that require significant operator attention and could become a distraction while driving.

Garmin Lock—turn on Garmin Lock™ to lock your nüvi. Enter a four-digit PIN and set a security location. Each time you turn on the nüvi, enter the four-digit PIN or drive to the security location.

Touch Tones—disable or enable the tone that sounds each time you touch the screen.

About—display your nüvi's software version number, unit ID number, and audio version number. You need this information to update the system software or purchase additional map data.

Changing the Locale Settings

To change the locale settings, touch  **Settings** > **Locale**.

View the location settings, such as language. Touch the setting that you want to change, or touch **Change All** to adjust the settings based on a selected country. On each screen, touch the setting you want, and then touch **OK**.

Text Language—change all on-screen text to the selected language. Changing the Text Language does not change the language of map data, such as street names and places or user-entered data.

Voice Language—change the language for all voice prompts and messages. Your nüvi might contain two different types of voice languages: text-to-speech (nüvi 360 only) and pre-recorded.

Languages noted with a person's name are text-to-speech (TTS) voices: for example, American English-Jill is a text-to-speech voice. The text-to-speech voices “read” and “speak” the same words that are displayed on the nüvi. The voices have an extensive vocabulary, and they pronounce the street names as you approach turns.

The pre-recorded voices have a limited vocabulary and do not speak names of locations or streets.

Time Format—choose a 12-hour, 24-hour, or UTC time format.

Units—Change units of measure to kilometers (**Metric**) or miles (**Statute**).

Changing the Display Settings

To change the display settings, touch  **Settings** > **Display**.

Color Mode—touch **Daytime** for a light background, **Nighttime** for a black background, or **Auto** to automatically switch between the two.

Backlight Timeout—select the length of time the backlight stays on after external power is removed. Reducing the time the backlight stays on increases the battery life.

Touch Screen—recalibrates (or realigns) the touch screen to respond properly. Touch **Recalibrate** and then follow the directions.

Screenshot—enables you to take a picture of the screen when you quickly press and release the  **Power** button. The pictures are saved in your “nüvi” drive.



NOTE: When Screenshot is **On**, the Quick Settings screen does not open when you press the  **Power** button.

Splash Screen—select an image to be shown when you turn on the nüvi. You can load JPEG images on your nüvi or SD card using USB Mass Storage Mode.

Changing the Navigation Settings

To change the navigation settings, touch  **Settings** > **Navigation**.

Route Preference—select a preference for calculating your route.

Vehicle—specify your vehicle type to optimize routes.

Avoidances—touch **Enabled** to access the road types. Select the road types you want to avoid on your routes. The nüvi uses these road types only if alternative routes take you too far out of your way or if no other roads are available. If you have an FM traffic receiver, you can also avoid traffic incidents.

Attention Tone—turn on or off the attention tone.

Voice Prompts—select when you want the nüvi to announce route navigation and system status.

Changing the Bluetooth Settings

To change the Bluetooth settings, touch  **Settings** > **Bluetooth**.

Connections—select a device to connect to. Select **Add Device** to search the area for mobile phones with Bluetooth® wireless technology. Set your mobile phone to Find Me, Discoverable, or Visible; and then touch **OK**. The nüvi searches for all Bluetooth wireless devices in the area and lists them. Select your phone, and then touch **OK**. Enter the nüvi's PIN in your phone.



NOTE: The nüvi's PIN code (or passkey) is **1234**.

Drop—disconnect the nüvi from your phone.



Delete—remove a device from the device list. Touch the device, and then touch **Remove**.

Bluetooth—enable and disable the Bluetooth component.

Friendly Name—select to enter a friendly name that identifies your nüvi on devices that are Bluetooth enabled. Touch **Done** after you have entered the name.

Restore—restore the original Bluetooth settings. Restoring the Bluetooth settings does not clear the pairing information.

Changing the Traffic Settings

To change the traffic settings, touch  **Settings** >  **Traffic**.

Changing the Proximity Points Settings

This option is visible only if you have loaded Custom POIs onto your nüvi. To change the proximity points settings, touch  **Settings** > **Proximity Points**. Only those items that you have loaded onto your nüvi can be changed with these settings.

Alerts—touch **Change** to turn on or off the alerts when you approach custom POIs. Touch **Audio** to set the type of audio notification that you want to hear, and touch **OK**.

TourGuide—set how you want the audio for Garmin TourGuide™ to be activated.

APPENDIX

Updating the nüvi Software



Use WebUpdater to update your nüvi software. Go to www.garmin.com/products/webupdater to download the WebUpdater program.

After downloading WebUpdater to your computer, connect your nüvi to your computer, run WebUpdater, and follow the screen prompts. After confirming that you want to perform an update, WebUpdater automatically downloads the update and installs it on your nüvi.

Register your nüvi to receive notification of software and map updates. To register your nüvi, go to <http://my.garmin.com>.

You can also download software updates from www.garmin.com/MINI. Click **Updates and Downloads**. Click **Download** next to the unit software. Read and agree to the terms. Click **Download**. Select **Run** (or **Save**). Your software is updated.

Purchasing and Loading Additional MapSource Maps

To find out the version of the maps that are loaded on your nüvi, open the Menu page. Touch  **Settings** >  **Map** > **Map Info**. To unlock additional maps, you need your unit ID and serial number.

Check www.garmin.com/unlock/update.jsp to see if an update for your map software is available. You can also purchase additional MapSource map data from Garmin and load the maps on your nüvi's internal memory or on an optional SD card.

To load maps or waypoints to your nüvi memory or SD card, select the name for your Garmin drive or SD card drive. Refer to the MapSource Help file for more information about using MapSource and loading maps and waypoints on your nüvi. The waypoints you create in MapSource are displayed in **My Locations > Favorites**.

Custom POIs (Points of Interest)

Your nüvi accepts custom POI databases, available from various companies on the Internet. Some custom POI databases contain alert information for points such as school zones. Your nüvi can notify you with a proximity alarm when you approach one of these points.

After downloading your POI database, use the Garmin POI Loader to install the POIs into your nüvi. The POI Loader is available at www.garmin.com/poiloader.

Using the POI Loader program, you can store the Custom POIs on your “nüvi” drive or your SD card. You can also customize the proximity alert settings for each POI using the POI Loader. Refer to the POI Loader Help file for more information; press F1 to open the Help file.

To view your Custom POIs, touch **My Locations** > **Custom POIs**.

To change the settings for your Custom POIs, touch  **Settings** > **Proximity Points**.

To delete the Custom POIs and Favorites from your nüvi, touch **Where To** from the Menu page. Touch **My Locations** > **Delete All**. Touch **Yes** to delete all of your Favorites and your Custom POIs.



CAUTION: Garmin is not responsible for the consequences of using a custom POI database or the accuracy of the safety camera or other custom POI database.

Optional Accessories

For more information about accessories, go to www.garmin.com/MINI, and click **Accessories**. You can also contact your Garmin dealer to purchase accessories.

- FM traffic receiver
- External remote antenna
- External microphone
- Travel Kit accessories

About the Garmin Travel Guide™

Much like a paper travel guide, the Garmin Travel Guide provides detailed information about places, such as restaurants and hotels. To purchase the Travel Guide accessory, go to www.garmin.com/extras.

To use the Travel Guide:

1. Insert the SD card into your nüvi.
2. On the Menu page, touch  **Travel Kit > Travel Guide**.
3. Touch the guide that you want to use.
4. Touch a category. Touch a sub-category, if necessary.
5. Touch a location in the list.
6. Do one of the following:
 - Touch **Go** to go to the location.
 - Touch **Map** to display this item on a map.

Touch **Save** to save this location in your Favorites.

Touch **More** to view more information about the location.

About SaversGuide

The SaversGuide® is an optional accessory that is available only in North America.

With the SaversGuide preprogrammed SD data card and membership card, your nüvi is a digital coupon book that notifies you of merchants near your current location where you are eligible for a discount, such as restaurants, hotels, movie theaters, and auto repair shops.

About the Garmin Language Guide



The Garmin Language Guide is an optional accessory. The Language Guide puts data from Oxford's multilingual resources and five bilingual dictionaries in the palm of your hand. A sample version of the Garmin Language Guide is provided.

Loading the Garmin Language Guide

When you receive the Garmin Language Guide SD card, you must load the data on the nüvi. Follow the directions on the package or in the nüvi Help file.

All dictionary, word, and phrase content is © Oxford University Press. Voice files are © Scansoft.

Translating Words and Phrases



1. On the Menu page, touch  **Travel Kit** >  **Language Guide**.
2. Touch **Words and Phrases** > **Language**.
3. Select the **From** and **To** languages and touch **Back**.
4. Select a category.
5. Search for a phrase, and touch it.
6. Touch  to hear the translation.

Words and Phrases Tips

- Use **Keywords in Phrases** to find all phrases that contain a specific word.
- Touch **Search** to spell the word.
- Touch an underlined word to replace the word.
- Touch **More Variations** to change words in the phrase or to get a different translation.
- If you cannot find what you are looking for in **Words and Phrases**, look in the **Bilingual Dictionaries**.

Using the Bilingual Dictionaries

The Garmin Language Guide provides five bilingual dictionaries. You can easily translate words and hear their pronunciation using the Bilingual Dictionaries.

1. On the Menu page, touch  **Travel Kit** >  **Language Guide**.
2. Touch **Bilingual Dictionaries**.
3. Touch a translation option. If necessary, touch **To English**.
4. Search for the word and touch it.
5. Touch  to hear the word spoken.

Bilingual Tips

- Touch **Search** to spell the word or the beginning of the word.
- Touch **Legend** to view the legend for the selected language. The Legend contains information on abbreviations, labels, and pronunciation symbols used in each dictionary.

About Garmin TourGuide™



The Garmin TourGuide allows your nüvi to play third-party, GPS-guided audio tours. These audio tours, for example, can take you on a route while playing interesting facts about historical sites along the way. As you travel, the audio information is triggered by GPS signals.

If you have loaded TourGuide files on your nüvi, go to the Menu page and then touch  **Where to** > **My Locations** > **Custom POIs**.

To change the settings for your Custom POIs, touch  **Settings** > **Proximity Points**.

About GPS Satellite Signals

Your nüvi must acquire GPS (Global Positioning System) satellite signals to operate. If you are indoors, near tall buildings or trees, or in a parking garage, the nüvi might not acquire satellites. Go outside to an area free from tall obstructions to use your nüvi, or close the antenna to turn off the GPS and use it indoors.

When the nüvi acquires satellite signals, the signal strength bars on the Menu page are green . When it loses satellite signals, the bars turn red or disappear . Touch the signals strength bars in the upper-left corner of the Menu page to view GPS information. Touch anywhere on the screen to return to the Menu page.

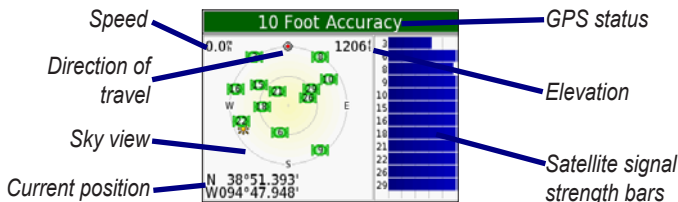

The sky view shows the satellites from which you are receiving. The satellite signal strength bars indicate the strength of each satellite you are receiving.

For more information about GPS, go to www.garmin.com/aboutGPS.

Caring for Your nüvi

Your nüvi contains sensitive electronic components that can be permanently damaged if exposed to excessive shock or vibration. To minimize the risk of damage to your nüvi, avoid dropping your nüvi or operating it in high shock/vibration environments.

Cleaning the nüvi

The nüvi is constructed of high quality materials and does not require user maintenance other than cleaning. Clean the nüvi's outer casing (not the touch screen) using a cloth dampened with a mild detergent solution and then wipe dry. Avoid chemical cleaners and solvents that can damage plastic components.

Cleaning the Touch Screen

Clean the touch screen with a soft, clean, lint-free cloth. Use water, isopropyl alcohol, or eyeglass cleaner. Apply the liquid to the cloth and then gently wipe the touch screen.

Protecting Your nüvi

- Do not store the nüvi where prolonged exposure to extreme temperatures can occur (such as in the windshield), as permanent damage may result.
- Do not expose the nüvi to water. Contact with water can cause the nüvi to malfunction.
- Though a PDA stylus can also be used to operate the touch screen, never attempt this while operating a vehicle. Never use a hard or sharp object to operate the touch screen, because it can damage the screen.
- Keep the nüvi in the leather carrying case when not in use.

Avoiding Theft

- Remove the nüvi and mount from sight when not in use.
- Use the Garmin Lock™ feature.

Battery Information

Your nüvi contains an internal (non-removable) lithium-ion battery. Contact your local waste disposal department for information on properly disposing of the nüvi.

Battery Tips

- Your nüvi's battery should last 4 to 8 hours depending on usage.
- To extend the battery life, reduce the time the backlight stays on. On the Menu page, select  **Settings > Display > Backlight Timeout** to change the setting.
- Close the antenna when you do not need to receive GPS signals.
- Do not leave your nüvi in direct sunlight, and avoid prolonged exposure to excessive heat.

Battery Gauge

The battery icon in the upper-right corner of the Menu page indicates the status of the internal battery. Periodically, you might notice that the battery gauge is not completely accurate. To increase the accuracy of the battery gauge, fully discharge the battery and then fully charge it without interrupting the charging. For best results, do not unplug the nüvi until it is totally charged.



Battery charging or connected to external power



Full battery

Troubleshooting

Problem/Question	Solution/Answer
My nüvi never gets satellite signals.	Take your nüvi outside, away from tall buildings and trees.
My battery gauge does not seem accurate.	Allow the nüvi to fully discharge and then fully charge it (without interrupting the charge cycle).
The touch screen is not responding to my taps properly.	Calibrate the screen. On the Menu page, touch Settings > Display . Touch the Recalibrate button and follow the on-screen instructions.
My phone will not connect to the nüvi.	Verify that the Bluetooth field is set to Enabled . Make sure your phone is turned on and is less than 10 meters (about 33 feet) away from your nüvi. See www.garmin.com/bluetooth for more help.
How do I know my nüvi is in USB Mass Storage Mode?	When your nüvi is in USB Mass Storage Mode, a picture of a nüvi connected to a computer is shown. Also, you should see a new Removable Disk Drive listed in My Computer.

<p>My computer never senses that the nüvi is connected.</p>	<ol style="list-style-type: none"> 1. Unplug the USB cable from your computer. 2. Turn the nüvi off and then back on again. 3. Plug the USB cable into your computer. The nüvi automatically goes into USB Mass Storage Mode. <p>The nüvi cannot communicate with Windows® 95, Windows 98, or Windows Me.</p>
<p>I cannot find any drives named “nüvi” in my list of drives.</p>	<p>Try the solution listed above.</p>
	<p>If you have several network drives mapped on your computer, Windows may have trouble assigning drive letters to your nüvi drives. Follow the steps on the following page to assign your drive letters.</p>
<p>I keep getting a message saying “Unsafe Removal of Device” when I unplug the USB cable.</p>	<p>To disconnect your nüvi from your computer, double-click the Unplug or Eject  icon in your system tray. Select “USB Mass Storage Device,” and click Stop. Select the nüvi drives, and click OK. Disconnect your nüvi from your computer.</p>
<p>How can I rename my nüvi drives?</p>	<ol style="list-style-type: none"> 1. Open My Computer. 2. Select the drive you want to rename. 3. Right-click your mouse and select Rename. 4. Type the new name. Press the Return key.

How do I map my nüvi drives in Windows?

1. Turn off your nüvi.
2. Plug the USB cable into the nüvi and your computer. Your nüvi automatically turns on.
3. On your computer, click **Start > Settings > Control Panel > Administrative Tools > Computer Management > Storage > Disk Management**.
4. Click a nüvi removable disk drive (either the internal memory or your SD Card drive). Right-click your mouse and select **Change Drive Letter and Path**.
5. Select **Change**, select a drive letter from the drop-down list, and click **OK**.

Specifications

Size: 3.87" W x 2.91" H x 0.87" D (9.8 x 7.4 x 2.2 cm)

Weight: 5.1 oz (144.6 g)

Display: 3.5" (8.9 cm) diagonal, 2.8" W x 2.1" H (7.1 x 5.3 cm); 320 x 240 pixels; QVGA TFT landscape display with white backlight and anti-glare touch screen

Case: Not waterproof or IPXO

Temperature range: 32°F to 140°F (0°C to 60°C)

Data storage: Internal memory and optional removable SD card. Data is stored indefinitely.

PC interface: USB mass storage, plug-and-play

Power input: 12 VDC

Usage: 15 W max. @ 13.8 VDC

Battery life: 4 to 8 hours depending on usage

Headphone jack: Standard 3.5 mm

GPS Performance

Receiver: WAAS enabled

Acquisition times*:

Warm: < 1 second

Cold: < 38 seconds

Factory reset: < 45 seconds

*On average for a stationary receiver with a clear view of the sky

Update rate: 1/second, continuous

GPS accuracy:

Position: < 10 meters, typical

Velocity: 0.05 meter/sec RMS

GPS (WAAS) accuracy:

Position: < 5 meters, typical

Velocity: 0.05 meter/sec RMS

For a complete list of specifications, go to www.garmin.com/MINI.

Important Safety and Product Information



Warnings

Failure to avoid the following potentially hazardous situations could result in an accident or collision resulting in death or serious injury.

- While driving, do not reach through the steering wheel to operate the unit.
- When navigating, carefully compare information displayed on the unit to all available navigation sources, including information from street signs, visual sightings, and maps. For safety, always resolve any discrepancies or questions before continuing navigation and defer to posted road signs.
- Always operate the vehicle in a safe manner. **Do not become distracted by the unit while driving, and**

always be fully aware of all driving conditions.

- Minimize the amount of time spent viewing the unit's screen while driving and use voice prompts when possible. Do not input destinations, change settings, or access any functions requiring prolonged use of the unit's controls while driving. Pull over in a safe and legal manner before attempting such operations.
- The unit is designed to provide route suggestions. It is not designed to replace the need for driver attentiveness regarding road closures or road conditions, traffic congestion, weather conditions, or other factors that may affect safety while driving.

Battery Warnings

If these guidelines are not followed, the internal lithium-ion battery may experience a shortened life span or may present a risk of damage to the GPS unit, fire, chemical burn, electrolyte leak, and/or injury.

- Contact your local waste disposal department to properly dispose of the unit/battery.
- Do not leave the unit exposed to a heat source or in a high temperature location, such as in the sun in an unattended vehicle on a hot day. To prevent damage, remove the unit from the vehicle or store it out of direct sunlight, such as in the glove box.
- Do not incinerate.
- When storing the unit for a limited length of time, store within the following temperature range: -4° to 140°F (-20° to 60°C). When storing the unit for an extended time, store within the following

temperature range: 32° to 77°F (0° to 25°C).

- Do not operate the unit outside of the following temperature range: -4° to 131°F (-20° to 55°C).

NOTE: Refer to the **Specifications** section in your product's owner's manual to determine if the lithium-ion battery in your specific Garmin product is replaceable.

If this unit contains a non-user-replaceable, rechargeable lithium-ion battery, do not remove or attempt to remove the battery.

If this unit contains a replaceable, rechargeable lithium-ion battery, the following warnings also apply:

- Do not recharge the battery out of the unit or disassemble the battery.
- Keep the used battery away from children. Do not disassemble, puncture, or damage the battery.
- Only replace with a Garmin lithium-ion battery

pack. Using another battery presents a risk of fire or explosion. To purchase a replacement battery, see your Garmin dealer or the Garmin Web site.

WARNING: This product, its packaging, and its components contain chemicals known to the State of California to cause cancer, birth defects, or reproductive harm. This notice is provided in accordance with California's Proposition 65. See www.garmin.com/prop65 for more information.

Important Information

MAP DATA INFORMATION: One of the goals of Garmin is to provide customers with the most complete and accurate cartography that is available to us at a reasonable cost. We use a combination of governmental and private data sources, which we identify in product literature and copyright messages displayed to the consumer. Virtually all data sources contain some inaccurate or incomplete data. In some countries, complete and accurate map information is either not available or is prohibitively expensive.

The **California Electronic Waste Recycling Act of 2003** requires the recycling of certain electronics. For more information on the applicability to this product, see www.erecycle.org.

Caring for the Screen

Clean the screen with water, isopropyl alcohol, or eyeglass cleaner; do not use cleaners containing ammonia, which can harm the coating on the screen.

If the unit has a touch screen, follow these guidelines as well:

- The touch screen is intended for finger operation.
- Although a PDA stylus may also be used to operate

the touch screen, never attempt this while operating a vehicle.

- Never use a hard or sharp object to operate the touch screen or damage may result.

FCC Compliance

This product has been tested and found to comply with Part 15 of the FCC interference limits for Class B digital devices FOR HOME OR OFFICE USE. These limits are designed to provide more reasonable protection against harmful interference in a residential installation, and are more stringent than "outdoor" requirements.

Operation of this device is subject to the following conditions: (1) this device may not cause harmful interference, and (2) this device must accept any interference received, including interference that may cause undesired operation.

This equipment generates, uses, and can radiate radio frequency energy and may cause harmful interference to radio communications if not installed and used in accordance with the instructions. However, there is no guarantee that interference will not occur in a particular installation. If this equipment does cause harmful interference to radio or television reception, which can be determined by turning the equipment off and on, the user is encouraged to try to correct the interference by one of the following measures:

- Reorient or relocate the receiving antenna.
- Increase the separation between the equipment and the receiver.
- Connect the equipment into an outlet that is on a different circuit from the GPS unit.
- Consult the dealer or an experienced radio/TV technician for help.

This product does not contain any user-serviceable parts. Repairs should only be made by an authorized Garmin service center. Unauthorized repairs or modifications could result in permanent damage to the equipment, and void your warranty and your authority to operate this device under Part 15 regulations.

Industry Canada Compliance

Category I radiocommunication devices comply with Industry Canada Standard RSS-210. Category II radiocommunication devices comply with Industry Canada Standard RSS-310.

MINI Limited Warranty

This MINI product is warranted to be free from defects in materials or workmanship for 36 months from the date of purchase. To obtain warranty service, contact your authorized MINI dealer. This warranty does not cover failures due to abuse, misuse, accident or unauthorized alterations or repairs.

NOTE: The nüvi has no user-serviceable parts. For product services and repairs, contact your authorized MINI dealer.

NOTE: The nüvi is fastened shut with screws. Any attempt to open the case to change or modify the unit in any way voids your warranty and may result in permanent damage to the equipment.

Software License Agreement

BY USING THE nüvi 360, YOU AGREE TO BE BOUND BY THE TERMS AND CONDITIONS OF THE FOLLOWING SOFTWARE LICENSE AGREEMENT. PLEASE READ THIS AGREEMENT CAREFULLY.

Garmin grants you a limited license to use the software embedded in this device (the “Software”) in binary executable form in the normal operation of the product. Title, ownership rights, and intellectual property rights in and to the Software remain in Garmin.

You acknowledge that the Software is the property of Garmin and is protected under the United States of America copyright laws and international copyright treaties. You further acknowledge that the structure, organization, and code of the Software are valuable trade secrets of Garmin and that the Software in source code form remains a valuable trade secret of Garmin. You agree not to decompile, disassemble, modify, reverse assemble, reverse engineer, or reduce to human readable form the Software or any part thereof or create any derivative works based on the Software. You agree not to export or re-export the Software to any country in violation of the export control laws of the United States of America.

Declaration of Conformity

Hereby, Garmin declares that this nüvi 360 product is in compliance with the essential requirements and other relevant provisions of Directive 1999/5/EC. To view the full Declaration of Conformity, see the Garmin Web site for your Garmin product: www.garmin.com/MINI. Click **Manuals**, and then click **Declaration of Conformity**.

INDEX

Symbols

- 2 dimensional 38
- 3 dimensional 38

A

- about button 39
- accessories 17, 47
- acquiring Satellites 3
- acquisition times 57
- AC charger 1
- adding a device 26
- adding a stop 13
- alerts 43
- answering a call 28
- antenna, GPS vi
- attention tone 42
- AudibleManager 20
- Audible books 19
 - transferring 22
- audio, transferring to your phone 28
- audio version 39
- avoiding
 - road types 42
 - theft 53
 - traffic 33, 42

B

- backlight timeout 41
- Back button vi
- bars, green satellite 3
- battery
 - information 53
 - life 57
 - status 6
- bilingual dictionaries 50
- bilingual tips 50
- Bluetooth 25
- bookmarks 19
- box contents 1
- brightness vi, 4
- browse the map 12
- browsing the map 12

C

- cable, USB 1
- calling
 - a number 26
 - a place 27
 - home 29
- call history 28
- call waiting 28
- Canada compliance 60
- caring for the screen 59
- caring for your nüvi 52
- carrying case 1
- charging the nüvi 3

cleaning

- the nüvi 52
- the screen 59
- clearing user information 4
- composing a text message 30
- computer connection 35
- connecting
 - the FM traffic receiver 31
 - the USB cable 35
- connections, Bluetooth 42
- content, product box 1
- converting currency 23
 - updating conversion rates 24
- Coordinates 12
- currency 23
- current location, saving 15
- customizing your nüvi 38
 - map 38
 - navigation 42
 - system setup 39
- custom POIs (points of interest) 46

D

- data storage 57
- daylight saving 40
- declaration of conformity 60
- delete
 - character 11

- custom POIs 46
- files from the nüvi 37
- saved places 16
- user data 4

deleting all information 4

destination, finding your 10

detour 14

disconnecting your nüvi 36, 55

display specifications 57

downloading a book 21

drives 35

dropping a connection 30

E

editing saved places (my locations) 16

EGNOS 39

enabling Bluetooth 26

ending a call 26

expanding your search 13

external microphone 2

F

Favorites 15

FCC compliance 59

files

- deleting 37
- managing 34
- supported types 37
- transferring 36

finding places

- by name 10
- by postal code 11
- intersection 11
- item on the map 12
- near another location 13

flag, checked 10

FM traffic receiver 16, 29, 31–33

following your route 10

G

Garmin Lock 5, 53

geocaching 12

going home 16

Google Earth iii, vi

GPS 6, 53

- accuracy 57
- antenna vi, 3
- information 51
- performance 57
- signals, about 51

green bars 6

H

hands-free 25

headphone jack 1, 57

help 17

home

- calling 29
- going 16
- location, setting a 16

I

importing a playlist 18

incoming call 28

iTunes 18, 34

K

keyboard 11

L

Language Guide 48, 49, 50

legend, bilingual dictionary 50

license agreement, software 60

listening to MP3 files 17

loading additional maps 44

loading Audible books 20

lock, screen vi, 4

locking your nüvi 5

M

M3U playlist 18

M4A/M4P 18

Macintosh 36, 37

map 13

- browse 12
- customize 38
- info button 38
- outlines 38
- page 7
- software version 38
- update maps 44
- view 38

zoom 12
MapSource 44
measurements 24
menu page 6
messaging, text 30
metric units 40
microphone 1
microphone, external 2
MP3 17, 18
myGarmin iii
my locations 15, 16, 29
 Favorites 15

N

narrow your results list
 spell the name 12
navigation settings 42
next turn page 9
north up 38
nuvi drives 35, 36

O

on-screen keyboard 11
optional accessories 47

P

pairing your nüvi 25
passkey, pairing 26
PC interface 57
phone book 28
phone icon 6
phone number, home 29

pictures 22
PIN, Garmin Lock 5
playing Audible books 19
playlist 18
POI (point of interest) 46
postal code 11
Power button vi, 3
power input 57
present location, saving 15
preview turns 8
protecting your nüvi 52
proximity points 43
purchasing a traffic subscrip-
 tion 33

Q

quick settings vi, 4

R

recalibrate touch screen 41
receiving a call 27
registering your nüvi iii, 44
removing a phone from the
 list 30
removing from the cradle 2
resetting
 maximum speed 8
 trip information 8
 your nüvi 4
restoring settings 38
routing preferences 42

S

safe mode 39
satellites, acquiring 3
satellite signals 6, 51
saved places
 delete 16
 edit 16
SaversGuide 48
saving places 15
school zone database 46
screen, cleaning the 59
screenshot 41
screen lock 4
SD card 35, 57
 disk drive 35, 36
security location 5
settings, Bluetooth 26
setting a home location 16
setting your location 12
show map 13
slide show 23
software license agreement 60
software version 39
specifications 57
spell the name of a place 11
status, phone 29
sticker, Garmin Lock 5
stop, adding a 13
stop navigation 14
stop USB 36

storing your nüvi 52
subscribe to safety camera
 information iii
supported file types 34
switching between calls 28
system setup 39

T

temperature range 57
text language 40
text messaging 30
theft prevention 53
touch screen
 cleaning 52
 recalibrating 41
touch tones 27
TourGuide 43, 50
 playing files 50
track up 38
traffic 31
 avoid 32, 42
 icon 6
 incidents 32
 receiver, connecting a 31
 settings 43
 subscription 33
 symbols 32
transferring audio to your
 phone 28
transferring files 36

translating words and phrases
 49
Travel Guide 47
travel kit 17–24
trip information page 7
troubleshooting 54
turning the nüvi on or off 3
turns preview page 8

U

units 40
unit ID 39
unlock code 1
unlock optional maps iii
update rate 57
updating software 44
USB cable 1
USB connector 1
user data, deleting 4

V

vehicle icon 7, 10
vehicle type 42
via point 13
viewing places on the map 12
voicemail 27
voice dial 29
voice language 40
voice prompts 42
voltage 57
volume vi, 4

W

WAAS 39–43
WAAS accuracy 57
warranty 60
waterproof, not 57
WebUpdater 44
Where to 10
Winamp 18
words and phrases 49, 50
world clock 23

Y

yellow sheet 1

Z

zoom 12

For the latest free software updates (excluding map data) throughout the life of your Garmin products, visit the Garmin Web site at www.garmin.com.



© 2006–2007 Garmin Ltd. or its subsidiaries

Garmin International, Inc.
1200 East 151st Street, Olathe, Kansas 66062, USA

Garmin (Europe) Ltd.
Liberty House, Hounsdown Business Park, Southampton, Hampshire, SO40 9RB UK

Garmin Corporation
No. 68, Jangshu 2nd Road, Shijr, Taipei County, Taiwan

www.garmin.com

Part Number 190-00740-00 Rev. C

GUIDE ME.