

**GARMIN** ▲

# Embraer Prodigy® Flight Deck 300 Pilot's Guide



# Embraer Phenom 300





Copyright © 2008-2010, 2012 Garmin Ltd. or its subsidiaries. All rights reserved.

This manual reflects the operation of System Software version 0734.54 or later for the Embraer Phenom 300. Some differences in operation may be observed when comparing the information in this manual to earlier or later software versions.

Garmin International, Inc., 1200 East 151st Street, Olathe, Kansas 66062, U.S.A.  
Tel: 913/397.8200 Fax: 913/397.8282

Garmin AT, Inc., 2345 Turner Road SE, Salem, OR 97302, U.S.A.  
Tel: 503/391.3411 Fax 503/364.2138

Garmin (Europe) Ltd, Liberty House, Bulls Copse Road, Hounslow Business Park, Southampton, SO40 9RB, U.K.  
Tel: 44/0870.8501241 Fax: 44/0870.8501251

Garmin Corporation, No. 68, Jangshu 2nd Road, Shijr, Taipei County, Taiwan  
Tel: 886/02.2642.9199 Fax: 886/02.2642.9099

For after-hours emergency, aircraft on ground (AOG) technical support for Garmin panel mount and integrated avionics systems, please contact Garmin's AOG Hotline at 913.397.0836.

Web Site Address: [www.garmin.com](http://www.garmin.com)

Except as expressly provided herein, no part of this manual may be reproduced, copied, transmitted, disseminated, downloaded or stored in any storage medium, for any purpose without the express written permission of Garmin. Garmin hereby grants permission to download a single copy of this manual and of any revision to this manual onto a hard drive or other electronic storage medium to be viewed for personal use, provided that such electronic or printed copy of this manual or revision must contain the complete text of this copyright notice and provided further that any unauthorized commercial distribution of this manual or any revision hereto is strictly prohibited.

Prodigy® is a registered trademark of Embraer-Empresa Brasileira de Aeronautica S.A.

Garmin® is a registered trademark of Garmin Ltd. or its subsidiaries. WATCH®, FliteCharts®, and SafeTaxi® are trademarks of Garmin Ltd. or its subsidiaries. These trademarks may not be used without the express permission of Garmin.

Bendix/King® and Honeywell® are registered trademarks of Honeywell International, Inc.; Becker® is a registered trademark of Becker Flugfunkwerk GmbH; NavData® is a registered trademark of Jeppesen, Inc.; XM® is a registered trademark of XM Satellite Radio, Inc.

SiriusXM Weather and SiriusXM Satellite Radio are provided by SiriusXM Satellite Radio, Inc.

AC-U-KWIK® is a registered trademark of Penton Business Media Inc.

AOPA Membership Publications, Inc. and its related organizations (hereinafter collectively "AOPA") expressly disclaim all warranties, with respect to the AOPA information included in this data, express or implied, including, but not limited to, the implied warranties of merchantability and fitness for a particular purpose. The information is provided "as is" and AOPA does not warrant or make any representations regarding its accuracy, reliability, or otherwise. Under no circumstances including negligence, shall AOPA be liable for any incidental, special or consequential damages that result from the use or inability to use the software or related documentation, even if AOPA or an AOPA authorized representative has been advised of the possibility of such damages. User agrees not to sue AOPA and, to the maximum extent allowed by law, to release and hold harmless AOPA from any causes of action, claims or losses related to any actual or alleged inaccuracies in the information. Some jurisdictions do not allow the limitation or exclusion of implied warranties or liability for incidental or consequential damages so the above limitations or exclusions may not apply to you.

March, 2012

190-00762-02 Rev. A

Printed in the U.S.A.

**LIMITED WARRANTY**

Within the warranty period, Garmin will, at its sole discretion, repair or replace any components that fail in normal use. Such repairs or replacement will be made at no charge to the customer for parts and/or labor incidental to the direct repair of said product. Garmin may, at its discretion with prior approval, reimburse an authorized Garmin Service Center for associated labor costs incurred for removal and replacement of the panel mount product installed in an aircraft. The customer shall be responsible for any transportation or other cost. This warranty does not apply to: (i) cosmetic damage, such as scratches, nicks and dents; (ii) consumable parts, such as batteries, unless product damage has occurred due to a defect in materials or workmanship; (iii) damage caused by accident, abuse, misuse, water, flood, fire, or other acts of nature or external causes; (iv) damage caused by service performed by anyone who is not an authorized service provider of Garmin; or (v) damage to a product that has been modified or altered without the written permission of Garmin. In addition, Garmin reserves the right to refuse warranty claims against products or services that are obtained and/or used in contravention of the laws of any country.

THE WARRANTIES AND REMEDIES CONTAINED HEREIN ARE EXCLUSIVE AND IN LIEU OF ALL OTHER WARRANTIES, WHETHER EXPRESS, IMPLIED OR STATUTORY, INCLUDING ANY LIABILITY ARISING UNDER ANY WARRANTY OF MERCHANTABILITY OR FITNESS FOR A PARTICULAR PURPOSE, STATUTORY OR OTHERWISE. THIS WARRANTY GIVES YOU SPECIFIC LEGAL RIGHTS, WHICH MAY VARY FROM STATE TO STATE.

IN NO EVENT SHALL GARMIN BE LIABLE FOR ANY INCIDENTAL, SPECIAL, INDIRECT OR CONSEQUENTIAL DAMAGES, WHETHER RESULTING FROM THE USE, MISUSE, OR INABILITY TO USE THIS PRODUCT OR FROM DEFECTS IN THE PRODUCT. Some states do not allow the exclusion of incidental or consequential damages, so the above limitations may not apply in every case.







Garmin retains the exclusive right to repair or replace (with a new or newly-overhauled replacement product) the product or offer a full refund of the purchase price at its sole discretion. SUCH REMEDY SHALL BE YOUR SOLE AND EXCLUSIVE REMEDY FOR ANY BREACH OF WARRANTY.

To obtain warranty service, contact your local Garmin Authorized Service Center. For assistance in locating the nearest Service Center, call Garmin Customer Service at one of the numbers listed below.

Products sold through online auctions are not eligible for warranty coverage or rebates or other special offers from Garmin. Online auction confirmations are not accepted for warranty verification. To obtain warranty service, an original or copy of the sales receipt from the original retailer is required. Garmin will not replace missing components from any package purchased through an online auction.

Garmin International Inc.  
1200 East 151st Street, Olathe, Kansas 66062  
Telephone: (913)397-8200  
Telephone Toll Free: (888)606-5482  
Facsimile: (913)397-8282  
Facsimile Toll Free: (800)801-4670  
E-mail: [orders@garmin.com](mailto:orders@garmin.com)  
[avionics@garmin.com](mailto:avionics@garmin.com)  
[warranty@garmin.com](mailto:warranty@garmin.com)

Garmin (Europe) Ltd.  
Liberty House, Bulls Copse Road, Southampton, SO40  
9RB, UK  
Telephone: ++44 (0) 870-8501243  
Telephone Toll Free: ++44 (0) 0808 238 0000  
(option 5)  
Facsimile: ++44 (0) 238052004  
E-mail: [avionics.europe@garmin.com](mailto:avionics.europe@garmin.com)

- 
-  **WARNING:** Navigation and terrain separation must NOT be predicated upon the use of the terrain avoidance feature. The terrain avoidance feature is NOT intended to be used as a primary reference for terrain avoidance and does not relieve the pilot from the responsibility of being aware of surroundings during flight. The terrain avoidance feature is only to be used as an aid for terrain avoidance. Terrain data is obtained from third party sources. Garmin is not able to independently verify the accuracy of the terrain data.
- 
-  **WARNING:** The displayed minimum safe altitudes (MSAs) are only advisory in nature and should not be relied upon as the sole source of obstacle and terrain avoidance information. Always refer to current aeronautical charts for appropriate minimum clearance altitudes.
- 
-  **WARNING:** The altitude calculated by the GPS receivers is geometric height above Mean Sea Level and could vary significantly from the altitude displayed by pressure altimeters, such as the GDC 74B Air Data Computer, or other altimeters in aircraft. GPS altitude should never be used for vertical navigation. Always use pressure altitude displayed by the PFD or other pressure altimeters in aircraft.
- 
-  **WARNING:** Do not use outdated database information. Databases used in the system must be updated regularly in order to ensure that the information remains current. Pilots using any outdated database do so entirely at their own risk.
- 
-  **WARNING:** Do not use basemap (land and water data) information for primary navigation. Basemap data is intended only to supplement other approved navigation data sources and should be considered as an aid to enhance situational awareness.
- 
-  **WARNING:** Traffic information shown on system displays is provided as an aid in visually acquiring traffic. Pilots must maneuver the aircraft based only upon ATC guidance or positive visual acquisition of conflicting traffic.
- 
-  **WARNING:** Do not use datalink weather products (e.g., XM WX Satellite Weather, GFDS World Wide Weather, or FIS-B) for hazardous weather penetration. Weather information provided by these products is aged by up to several minutes and may not depict actual weather conditions as they currently appear.
- 
-  **WARNING:** NEXRAD weather data is to be used for long-range planning purposes only. Due to inherent delays in data transmission and the relative age of the data, NEXRAD weather data should not be used for short-range weather avoidance.
- 
-  **WARNING:** The Prodigy® Integrated Flight Deck, as installed in the Embraer Phenom 300 aircraft, has a very high degree of functional integrity. However, the pilot must recognize that providing monitoring and/or self-test capability for all conceivable system failures is not practical. Although unlikely, it may be possible for erroneous operation to occur without a fault indication shown by the system. It is thus the responsibility of the pilot to detect such an occurrence by means of cross-checking with all redundant or correlated information available in the cockpit.
- 
-  **WARNING:** For safety reasons, system operational procedures must be learned on the ground.
-

 **WARNING:** The United States government operates the Global Positioning System and is solely responsible for its accuracy and maintenance. The GPS system is subject to changes which could affect the accuracy and performance of all GPS equipment. Portions of the system utilize GPS as a precision electronic NAVigation AID (NAVAID). Therefore, as with all NAVAIDs, information presented by the system can be misused or misinterpreted and, therefore, become unsafe.

 **WARNING:** To reduce the risk of unsafe operation, carefully review and understand all aspects of the Prodigy® Pilot's Guide documentation and the Embraer Phenom 300 Airplane Flight Manual. Thoroughly practice basic operation prior to actual use. During flight operations, carefully compare indications from the system to all available navigation sources, including the information from other NAVAIDs, visual sightings, charts, etc. For safety purposes, always resolve any discrepancies before continuing navigation.

 **WARNING:** The illustrations in this guide are only examples. Never use the system to attempt to penetrate a thunderstorm. Both the FAA Advisory Circular, Subject: Thunderstorms, and the Aeronautical Information Manual (AIM) recommend avoiding "by at least 20 miles any thunderstorm identified as severe or giving an intense radar echo."

 **WARNING:** Lamp(s) inside this product may contain mercury (HG) and must be recycled or disposed of according to local, state, or federal laws. For more information, refer to our website at [www.garmin.com/aboutGarmin/environment/disposal.jsp](http://www.garmin.com/aboutGarmin/environment/disposal.jsp).

 **WARNING:** Because of variation in the earth's magnetic field, operating the system within the following areas could result in loss of reliable attitude and heading indications. North of 72° North latitude at all longitudes. South of 70° South latitude at all longitudes. North of 65° North latitude between longitude 75° W and 120° W. (Northern Canada). North of 70° North latitude between longitude 70° W and 128° W. (Northern Canada). North of 70° North latitude between longitude 85° E and 114° E. (Northern Russia). South of 55° South latitude between longitude 120° E and 165° E. (Region south of Australia and New Zealand).

 **WARNING:** Do not use GPS to navigate to any active waypoint identified as a 'NON WGS84 WPT' by a system message. 'NON WGS84 WPT' waypoints are derived from an unknown map reference datum that may be incompatible with the map reference datum used by GPS (known as WGS84) and may be positioned in error as displayed.

 **CAUTION:** The PFD and MFD displays use a lens coated with a special anti-reflective coating that is very sensitive to skin oils, waxes, and abrasive cleaners. CLEANERS CONTAINING AMMONIA WILL HARM THE ANTI-REFLECTIVE COATING. It is very important to clean the lens using a clean, lint-free cloth and an eyeglass lens cleaner that is specified as safe for anti-reflective coatings.

 **CAUTION:** The system does not contain any user-serviceable parts. Repairs should only be made by an authorized Garmin service center. Unauthorized repairs or modifications could void both the warranty and the pilot's authority to operate this device under FAA/FCC regulations.





**NOTE:** All visual depictions contained within this document, including screen images of the panel and displays, are subject to change and may not reflect the most current system and databases. Depictions of equipment may differ slightly from the actual equipment.

---



**NOTE:** This device complies with part 15 of the FCC Rules. Operation is subject to the following two conditions: (1) this device may not cause harmful interference, and (2) this device must accept any interference received, including interference that may cause undesired operation.

---



**NOTE:** This product, its packaging, and its components contain chemicals known to the State of California to cause cancer, birth defects, or reproductive harm. This notice is being provided in accordance with California's Proposition 65. If you have any questions or would like additional information, please refer to our web site at [www.garmin.com/prop65](http://www.garmin.com/prop65).

---



**NOTE:** Interference from GPS repeaters operating inside nearby hangars can cause an intermittent loss of attitude and heading displays while the aircraft is on the ground. Moving the aircraft more than 100 yards away from the source of the interference should alleviate the condition.

---



**NOTE:** Use of polarized eyewear may cause the flight displays to appear dim or blank.

---

Record of Revisions				
Part Number	Revision	Date	Page Range	Description
190-00762-00	A	October, 2009	All	Initial release.
	B	November, 2009	55-92	Added bleed tabs to all pages in Section 2.
	C	December, 2009	All	Reformatted for new binder.
190-00762-01	A	November, 2010	All	Added METARs to active flight plan and maps Updated XM Weather product age and icon display Added SMS texting Updated database update procedures Added other GDU 11.12 parameters
190-00762-02	A	March, 2012	All	Updated CAS messages Updated SiriusXM Satellite Radio audio mute procedure Added Pilot Profiles Updated Database Update procedures Added AC-U-KWIK Airport Directory capability Updated GFDS registration procedure Added Inset Map WX LGND Softkey Removed flightplan sorting capability Added other GDU 12.11 parameters

<b>SECTION 1 SYSTEM OVERVIEW</b>	
<b>1.1 System Description</b> .....	1
<b>1.2 Line Replaceable Units (LRU)</b> .....	2
<b>1.3 Prodigy® Controls</b> .....	7
MFD/PFD Controls .....	7
Control Unit .....	9
AFCS Controls .....	10
Audio Panel Controls .....	12
Softkey Function .....	14
<b>1.4 Secure Digital Cards</b> .....	24
<b>1.5 System Power-up</b> .....	25
<b>1.6 System Operation</b> .....	26
Normal Operation .....	26
Reversionary Mode .....	27
AHRS Operation .....	28
Prodigy® System Annunciations .....	30
GPS Receiver Operation .....	31
<b>1.7 Accessing System Functionality</b> .....	36
Menus .....	36
MFD Page Groups .....	37
MFD System Pages .....	42
<b>1.8 Display Backlighting</b> .....	57
Automatic Adjustment .....	57
Manual Adjustment .....	57
<b>SECTION 2 FLIGHT INSTRUMENTS</b>	
<b>2.1 Flight Instruments</b> .....	62
Airspeed Indicator .....	62
Attitude Indicator .....	65
Altimeter .....	67
Vertical Speed Indicator (VSI) .....	71
Vertical Deviation .....	71
Horizontal Situation Indicator (HSI) .....	72
<b>2.2 Supplemental Flight Data</b> .....	85
Temperature Displays .....	85
Wind Data .....	86
<b>2.3 PFD Annunciations and Alerting Functions</b> .....	88
System Annunciations .....	88
Marker Beacon Annunciations .....	89
Traffic Annunciations .....	89
TAWS Annunciations .....	90
Altitude Alerting .....	90
Low Altitude Annunciation .....	91
Minimum Descent Altitude/Decision Height Alerting .....	92
Radar Altimeter .....	93
<b>2.4 Abnormal Operations</b> .....	95
Altitude Alerting .....	95
Abnormal GPS Conditions .....	95
Unusual Attitudes .....	96
<b>SECTION 3 ENGINE AND AIRFRAME SYSTEMS</b>	
<b>3.1 Engine Indication System (EIS)</b> .....	100
Takeoff Data Set Window .....	101
Engine Indications .....	102
Fuel and Electrical Indications .....	104
Cabin Pressurization .....	105
Spoiler and Landing Gear .....	106
Flaps and Trim .....	106
<b>3.2 Synoptics</b> .....	107
System Status .....	107
Environmental Control System (ECS) .....	108
Electrical .....	110
Fuel .....	111
Ice Protection System .....	112
Engine Maintenance .....	114
<b>3.3 Crew Alerting System (CAS)</b> .....	115
CAS Message Prioritization .....	115
<b>3.4 Abnormal Operations</b> .....	122
Engine .....	122
Cabin pressurization .....	122
Flaps .....	123
Trim .....	123
<b>SECTION 4 AUDIO PANEL AND CNS</b>	
<b>4.1 Overview</b> .....	125
Audio Panel Volume Control .....	125
MFD/PFD Controls and Frequency Display .....	126
Audio Panel Controls .....	128
Control Unit .....	130
<b>4.2 COM Operation</b> .....	132
COM Transceiver Selection and Activation .....	132
COM Transceiver Manual Tuning .....	133
Quick-tuning and Activating 121.500 MHz .....	135

Auto-tuning the COM Frequency .....	136	Map Symbols .....	194
Frequency Spacing .....	140	Airways .....	200
Automatic Squelch .....	141	Track Vector .....	202
Volume .....	141	Wind Vector .....	203
<b>4.3 NAV Operation</b> .....	142	Nav Range Ring .....	204
NAV Radio Selection and Activation .....	142	Fuel Range Ring .....	205
NAV Receiver Manual Tuning .....	143	Field of View (SVS) .....	206
Auto-tuning a NAV Frequency from the MFD .....	146	Selected Altitude Intercept Arc .....	207
Marker Beacon Receiver .....	151	<b>5.3 Waypoints</b> .....	208
ADF/DME Tuning .....	152	Airports .....	209
<b>4.4 Mode S Transponder</b> .....	156	Intersections .....	216
GTX 33 Transponder Controls .....	157	NDBs .....	218
GTX 33 Transponder Mode Selection .....	158	VORs .....	220
TCAS II Transponder Controls (optional) .....	160	User Waypoints .....	222
TCAS II Transponder Mode Selection (optional) .....	161	<b>5.4 Airspaces</b> .....	228
Entering a Transponder code .....	163	<b>5.5 Direct-to-Navigation</b> .....	232
IDENT Function .....	165	<b>5.6 Flight Planning</b> .....	238
Flight ID Reporting .....	166	Flight Plan Creation .....	239
<b>4.5 Additional Audio Panel Functions</b> .....	167	Adding Waypoints to an Existing Flight Plan .....	244
Power-Up .....	167	Adding Airways to a Flight Plan .....	246
Mono/Stereo Headsets .....	167	Adding Procedures to a Stored Flight Plan .....	249
Speaker .....	167	Flight Plan Storage .....	256
Intercom .....	168	Flight Plan Editing .....	258
Passenger Address (PA) System .....	169	Along Track Offsets .....	262
Simultaneous COM Operation .....	169	Parallel Track .....	263
Clearance Recorder and Player .....	170	Activating a Flight Plan Leg .....	266
Entertainment Inputs .....	171	Inverting a Flight Plan .....	267
<b>4.6 Audio Panels Preflight Procedure</b> .....	172	Flight Plan Views .....	268
<b>4.7 Abnormal Operation</b> .....	174	Closest Point of FPL .....	270
Stuck Microphone .....	174	<b>5.7 Vertical Navigation</b> .....	271
COM Tuning Failure .....	174	Altitude Constraints .....	273
PFD or MFD Failure, Dual System .....	175	<b>5.8 Procedures</b> .....	277
Audio Panel Fail-safe Operation .....	176	Departures .....	277
Reversionary Mode .....	176	Arrivals .....	280
		Approaches .....	282
		<b>5.9 Trip Planning</b> .....	288
		Trip Planning .....	288
		Weight Planning .....	292
		Weight Caution And Warning Conditions .....	294
		<b>5.10 RAIM Prediction</b> .....	295
		<b>5.11 Navigating a Flight Plan</b> .....	299
		<b>5.12 Abnormal Operation</b> .....	327

**SECTION 5 FLIGHT MANAGEMENT**



<b>SECTION 6 HAZARD AVOIDANCE</b>	
<b>6.1 SiriusXM Weather</b> .....	330
Using SiriusXM Weather Products .....	331
<b>6.2 Airborne Color Weather Radar</b> .....	363
System Description .....	363
Principles of Pulsed Airborne Weather Radar .....	363
NEXRAD and Airborne Weather Radar .....	364
Antenna Beam Illumination .....	364
Safe Operating Distance .....	367
Basic Antenna Tilt Setup .....	368
Weather Mapping and Interpretation .....	370
Ground Mapping and Interpretation .....	382
System Status .....	383
<b>6.3 TAWS-B</b> .....	384
Displaying TAWS-B Data .....	385
TAWS-B Page .....	388
TAWS-B Alerts .....	390
System Status .....	396
<b>6.4 TAWS-A</b> .....	398
TAWS-A Alerts .....	402
System Status .....	414
TAWS-A Abnormal operations .....	415
<b>6.5 Traffic Information Service (TIS)</b> .....	417
Displaying TRAFFIC Data .....	418
Traffic Map Page .....	420
TIS Alerts .....	421
System Status .....	423
<b>6.6 TCAS II Traffic</b> .....	425
TCAS II Symbolology .....	425
TCAS II Alerts .....	426
System Test .....	429
Operation .....	430
System Status .....	436

<b>SECTION 7 AUTOMATIC FLIGHT CONTROL SYSTEM</b>	
<b>7.1 AFCS Controls</b> .....	440
<b>7.2 Flight Director Operation</b> .....	442
Activating the Flight Director .....	442
AFCS Status Box .....	443
Flight Director Modes .....	444
Flight Director Selection .....	444
Command Bars .....	445

<b>7.3 Vertical Modes</b> .....	446
Pitch Hold Mode (PIT) .....	447
Selected Altitude Capture Mode (ALTS) .....	448
Altitude Hold Mode (ALT) .....	448
Vertical Speed Mode (VS) .....	450
Flight Level Change Mode (FLC) .....	451
Vertical Navigation Modes (VPTH, ALTV) .....	453
Glidepath Mode (GP) (SBAS Only) .....	458
Glideslope Mode (GS) .....	460
Takeoff (TO) and Go Around (GA) Modes .....	461
<b>7.4 Lateral Modes</b> .....	462
Roll Hold Mode (ROL) .....	463
Low Bank Mode .....	463
Heading Select Mode (HDG) .....	464
Navigation Modes (GPS, VOR, LOC, BC) .....	465
Approach Modes (GPS, VAPP, LOC) .....	467
<b>7.5 Autopilot and Yaw Damper Operation</b> .....	469
Flight Control .....	469
Engaging the Autopilot and Yaw Damper .....	470
Control Wheel Steering .....	470
Disengaging the Autopilot and Yaw Damper .....	471
<b>7.6 Example Flight Plan</b> .....	472
Departure .....	473
Intercepting a VOR Radial .....	475
Flying a Flight Plan/GPS Course .....	476
Descent .....	477
Approach .....	481
Go Around/Missed Approach .....	483
<b>7.7 AFCS Annunciations and Alerts</b> .....	485
AFCS CAS Messages .....	485
AFCS Voice Alerts .....	486
Overspeed Protection .....	486

<b>SECTION 8 ADDITIONAL FEATURES</b>	
<b>8.1 Synthetic Vision System (SVS)</b> .....	488
SVS Operation .....	489
SVS Features .....	491
Field of View .....	499
<b>8.2 SafeTaxi</b> .....	501
SafeTaxi Database Cycle Number and Revision .....	504
<b>8.3 ChartView</b> .....	507
ChartView Softkeys .....	507
Terminal Procedures Charts .....	508

Chart Options..... 516  
 Day/Night View ..... 522  
 ChartView Cycle Number and Expiration Date ..... 524  
**8.4 FliteCharts**..... 527  
 FliteCharts Softkeys ..... 527  
 Terminal Procedures Charts ..... 528  
 Chart Options..... 535  
 Day/Night View ..... 539  
 FliteCharts Cycle Number and Expiration Date..... 541  
 Airport Directory Database Cycle Number and Revision 545  
**8.6 Satellite Telephone and Data Link Services** ..... 547  
 Registering With Garmin Flight Data Services ..... 547  
 Disable/Enable Iridium Transceiver..... 550  
 Telephone Communication ..... 551  
 Text Messaging (SMS)..... 564  
 WI-FI Connections ..... 576  
 System Data Logging ..... 581  
**8.7 SiriusXM Satellite Radio Entertainment**..... 587  
 Activating SiriusXM Satellite Radio Services ..... 587  
 Using SiriusXM Satellite Radio ..... 589  
**8.8 Scheduler**..... 592  
**8.9 Electronic Checklists**..... 594  
**8.10 Abnormal Operation** ..... 597  
 SVS Troubleshooting ..... 597  
 Reversionary Mode ..... 597  
 Unusual Attitudes ..... 598

**Database Management**..... 629  
 Jeppesen Databases..... 629  
 Garmin Databases ..... 633  
**Glossary**..... 639  
**Frequently Asked Questions** ..... 645  
**General TIS Information** ..... 649  
 Introduction ..... 649  
 TIS vs. TAS/TCAS ..... 649  
 TIS Limitations..... 649  
**Display Symbols** ..... 651

---

**INDEX**

---

**Index** ..... I-1

---

**APPENDICES**

---

**Annunciations and Alerts** ..... 601  
 CAS Messages..... 601  
 Comparator Annunciations ..... 606  
 Reversionary Sensor Annunciations ..... 607  
 Prodigy® System Annunciations..... 608  
 Prodigy® System Message Advisories..... 610  
 TAWS-A Alerts ..... 623  
 TAWS-B Alerts ..... 625  
 TCAS II Alerts and Annunciations ..... 626  
 Other Prodigy® Aural Alerts..... 627  
 Flight Plan Import/Export Messages ..... 627  
 Pilot Profile Import/Export Messages ..... 628

## SECTION 1 SYSTEM OVERVIEW

### 1.1 SYSTEM DESCRIPTION

This section provides an overview of the Prodigy® Integrated Flight Deck as installed in the Embraer Phenom 300. The system is an integrated flight control system that presents flight instrumentation, position, navigation, communication, and identification information to the pilot through large-format displays. The system consists of the following Line Replaceable Units (LRUs):

- **GDU 1240A** Primary Flight Displays and Multi-function Display
- **GIA 63W** Integrated Avionics Unit
- **GDC 74B** Air Data Computer (ADC)
- **GEA 71** Engine/Airframe Unit
- **GRS 77** Attitude and Heading Reference System (AHRS)
- **GMU 44** Magnetometer
- **GMA 1347D** Dual Audio System with Integrated Marker Beacon Receiver
- **GTX 33/33D** Mode S Transponder (not used with TCAS II)
- **GDL 69A** Satellite Data Link Receiver
- **GDL 59** Data Link (optional)
- **GSR 56** Iridium Transceiver (optional)
- **GWX 68** Weather Radar
- **GCU 477** MFD Control Unit
- **GMC 715** AFCS Control Unit
- **GSD 41** Data Concentrator
- **GA 36** and **GA 37** GPS/SBAS Antennas
- **GSA 81** AFCS Servos
- **GSM 86** Servo Gearboxes

A top-level system block diagram is shown in Figure 1-1 (it does not include the GA 36, GA 37, GA 58, or GSM 86).



---

**NOTE:** Refer to the AFCS section for details on the GFC 700 AFCS.

---

In the Embraer Phenom 300, the GFC 700 Automated Flight Control System (AFCS) provides the flight director (FD), autopilot (AP), and yaw damper (YD) functions of the system.

## 1.2 LINE REPLACEABLE UNITS (LRU)

- **GDU 1240A** (3) – Each unit is configured as one of two PFDs or one MFD. The GDU 1240A features a 12-inch LCD with 1024 x 768 resolution. The unit installed on the left/pilot side is designated as PFD1, and the one installed on the right/copilot side is designated as PFD2. The unit installed in the center is designated the MFD. These units communicate with each other and with the on-side GIA 63W Integrated Avionics Unit through a High-Speed Data Bus (HSDB) connection.



- **GMA 1347D** (2) – Integrates NAV/COM digital audio, intercom system and marker beacon controls, and is installed in dual configuration on the outboard side of PFD1 and PFD2. This unit also enables the manual control of the display reversionary mode (red **DISPLAY BACKUP** button) and communicates with the on-side GIA 63W, using an RS-232 digital interface.



- **GCU 477** (1) – Provides the Flight Management System (FMS) controls for the MFD through an RS-232 digital interface.



- **GMC 715** (1) – Provides the controls for the GFC 700 AFCS through an RS-232 digital interface allowing communication with both PFDs.





- **GIA 63W (2)** – Functions as the main communication hub, linking all LRUs with the on-side PFD. Each GIA 63W contains a GPS SBAS receiver, VHF COM/NAV/GS receivers, a flight director (FD) and system integration microprocessors. Each GIA 63W is paired with the on-side PFD via HSDB connection. The GIA 63Ws are not paired together and do not communicate with each other directly.



- **GDC 74B (2)** – Processes data from the pitot/static system as well as the OAT probe. This unit provides pressure altitude, airspeed, vertical speed and OAT information to the system, and it communicates with the on-side GIA 63W, on-side GDU 1240A and on-side GRS 77, using an ARINC 429 digital interface. The GDC 74B is designed to operate in Reduced Vertical Separation Minimum (RVSM) airspace.



- **GEA 71 (3)** – Receives and processes signals from the engine and airframe sensors. This unit communicates with both GIA 63Ws using an RS-485 digital interface.



- **GRS 77 (2)** – Provides aircraft attitude and heading information via ARINC 429 to both the on-side GDU 1240A and the on-side GIA 63W. The GRS 77 contains advanced sensors (including accelerometers and rate sensors) and interfaces with the on-side GMU 44 to obtain magnetic field information, with the GDC 74B to obtain air data, and with both GIA 63Ws to obtain GPS information. AHRS modes of operation are discussed later in this document.



- **GMU 44** (2) – Measures local magnetic field. Data is sent to the GRS 77 for processing to determine aircraft magnetic heading. This unit receives power directly from the GRS 77 and communicates with the GRS 77, using an RS-485 digital interface.



- **GTX 33** (1) and **GTX 33D** (1) – Solid-state transponders that provide Modes A, C and S capability. The GTX 33D includes Mode S with diversity and is indicated as ‘XPDR2’. The GTX 33 is indicated as ‘XPDR1’. Both transponders can be controlled from either PFD, and only one transponder can be active at a time. Each transponder communicates with the on-side GIA 63W through an RS-232 digital interface. These transponders are not used when the TCAS II option is installed.



- **GDL 69A** (1) – A satellite radio receiver that provides weather information to the MFD (and, indirectly, to the inset map of the PFD) as well as digital audio entertainment. The GDL 69A communicates with the MFD via HSDB connection. A subscription to the SiriusXM Satellite Radio service is required to enable the GDL 69A capability.



- **GDL 59** (1) – Provides system WI-FI connectivity. GDL 59 operation is performed with the MFD through the HSDB. Connectivity with the GSR 56 is through the RS-232 bus. Computers and/or EFBs (Electronic Flight Bag) may also be connected through three Ethernet ports.



- **GSR 56** (1) – The Iridium Transceiver operation for voice communication is by means of a telephone handset. The transceiver can also send and receive data provided by the GDL 59 through the RS-232 bus.



- **GWX 68** (1) – Provides airborne weather and ground mapped radar data to the MFD, through the GSD 41, via HSDB connection.

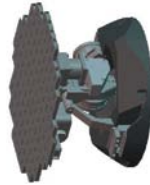

- **GSD 41** (1) – This unit is a data concentrator used to expand the input and output capabilities of the system. Communication is through the High Speed Data Bus.



- **GSA 81** (3) and **GSM 86** (3) – The GSA 81 servos are used for the automatic control of pitch, roll, and yaw. These units interface with each GIA 63W.

The GSM 86 servo gearbox is responsible for transferring the output torque of the GSA 81 servo actuator to the mechanical flight-control surface linkage.



- **GA 36** (1) and **GA 37** (1) – The GA 36 is a through-mount GPS/SBAS antenna. The GA 37 is a through-mount GPS/SBAS antenna with SiriusXM/Data Link.



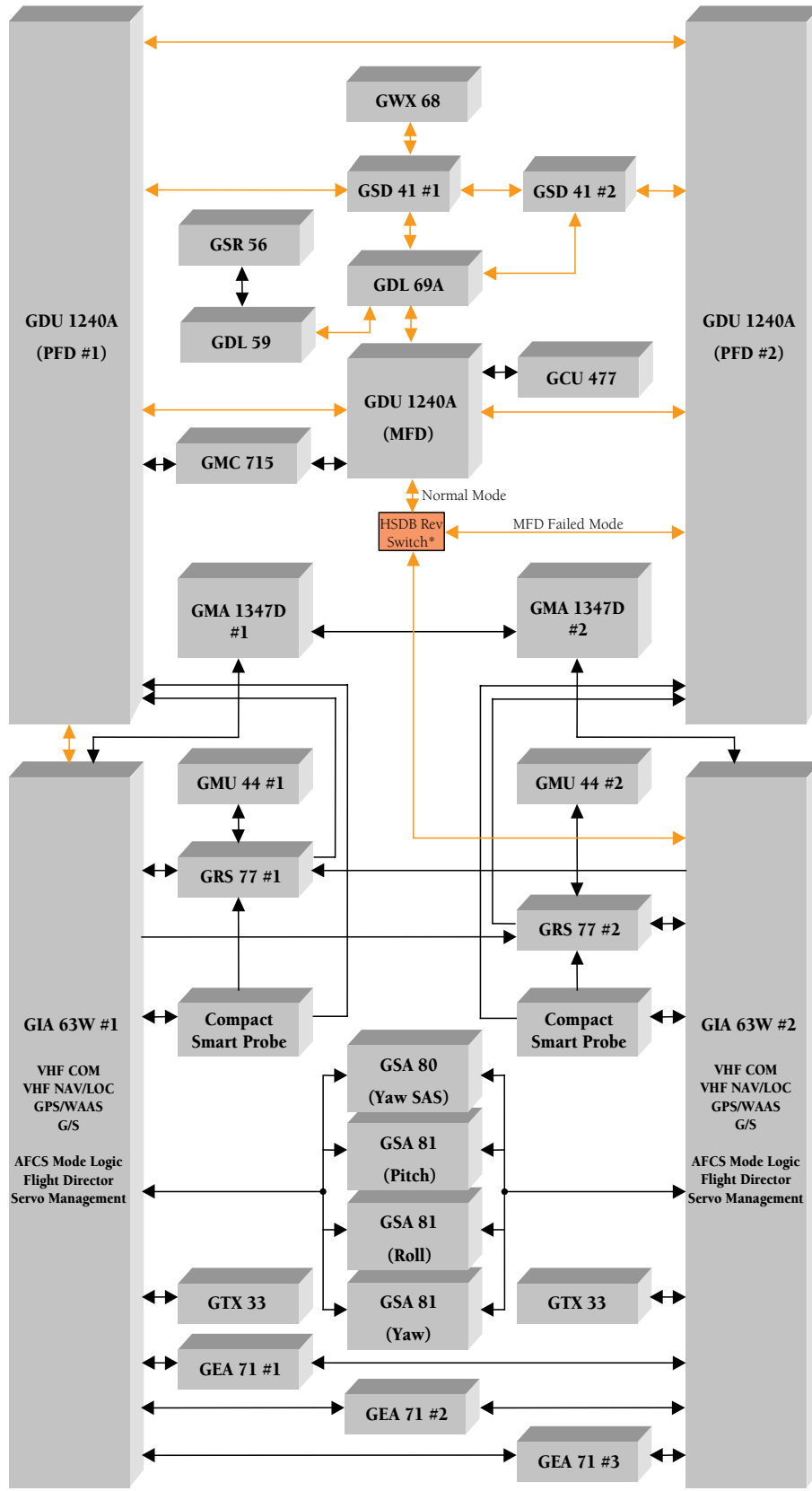

\* External to the G1000 system    ● High Speed Data Bus

Figure 1-1 System LRU Configuration



### 1.3 PRODIGY® CONTROLS

**NOTE:** The Audio Panel (GMA 1347D) and AFCS controls (GMC 715) are described in the CNS & Audio Panel and AFCS sections respectively.

The system controls are located on the PFD and MFD bezels, MFD Control Unit, AFCS Control Unit and audio panel. Some controls found on the MFD are duplicated on the MFD Control Unit. These control functions may be operated from either the MFD or the MFD Control Unit. The controls for the PFDs and MFD are discussed within the following pages of this section.

#### MFD/PFD CONTROLS

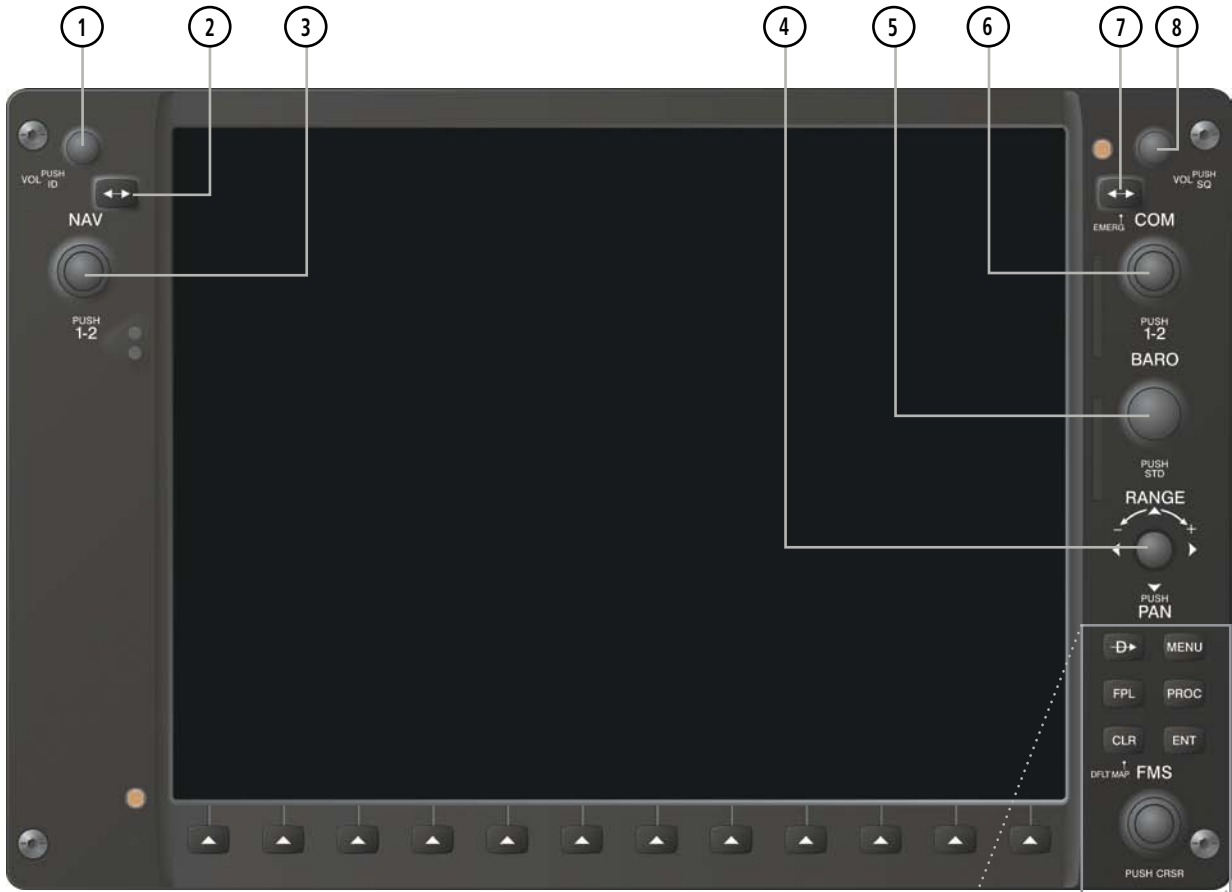
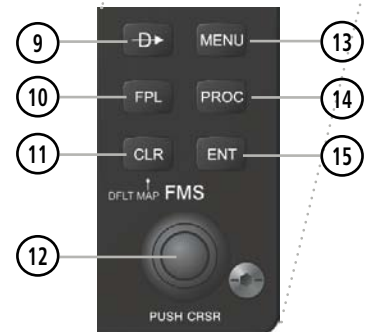

Figure 1-2 PFD Controls



The following list provides an overview of the controls located on the PFD and MFD bezels (see Figure 1-2).

- ① **NAV VOL/ID Knob** – Controls NAV audio volume level. Press to toggle the Morse code identifier audio ON and OFF. Volume level is shown in the NAV frequency field as a percentage.
- ② **NAV Frequency Transfer Key** – Switches the standby and active NAV frequencies.
- ③ **Dual NAV Knob** – Tunes the standby frequencies for the NAV receiver (large knob for MHz; small knob for kHz). Press to switch the tuning box (cyan box) between NAV1 and NAV2.
- ④ **Joystick** – Changes the map range when rotated. Activates the map pointer when pressed.
- ⑤ **BARO Knob** – Sets the altimeter barometric pressure. Press to enter standard pressure (29.92).
- ⑥ **Dual COM Knob** – Tunes the standby frequencies for the COM transceiver (large knob for MHz; small knob for kHz). Press to switch the tuning box (cyan box) between COM1 and COM2.
- ⑦ **COM Frequency Transfer Key** – Switches the standby and active COM frequencies. Press and hold this key for two seconds to tune the emergency frequency (121.5 MHz) automatically into the active frequency field.
- ⑧ **COM VOL/SQ Knob** – Controls COM audio volume level. Volume level is shown in the COM frequency field as a percentage. Press to turn the COM automatic squelch ON and OFF.
- ⑨ **Direct-to Key** – Allows the user to enter a destination waypoint and establish a direct course to the selected destination (the destination is either specified by the identifier, chosen from the active route, or taken from the map pointer position).
- ⑩ **FPL Key** – Displays the active Flight Plan Page for creating and editing the active flight plan.
- ⑪ **CLR Key** – Erases information, cancels entries, or removes page menus.
- ⑫ **Dual FMS Knob** – Flight Management System Knob. Press the **FMS** Knob to turn the selection cursor ON and OFF. When the cursor is ON, data may be entered in the applicable window by turning the small and large knobs. The large knob moves the cursor on the page, while the small knob selects individual characters for the highlighted cursor location.
- ⑬ **MENU Key** – Displays a context-sensitive list of options. This list allows the user to access additional features or make setting changes that relate to particular pages.
- ⑭ **PROC Key** – Gives access to IFR departure procedures (DPs), arrival procedures (STARs) and approach procedures (IAPs) for a flight plan. If a flight plan is used, available procedures for the departure and/or arrival airport are automatically suggested. These procedures can then be loaded into the active flight plan. If a flight plan is not used, both the desired airport and the desired procedure may be selected.
- ⑮ **ENT Key** – Validates or confirms a menu selection or data entry.

## CONTROL UNIT

Many of the controls on the Control Unit (GCU 477) have the same function as those located on the MFD. The following list provides an overview of the controls located on the Control Unit (see Figure 1-3):

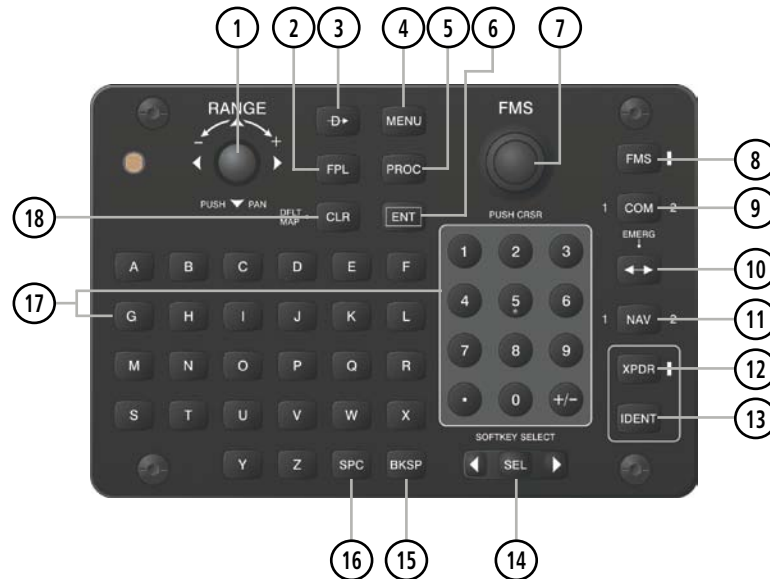

Figure 1-3 Control Unit (GCU 477)

- ① **Joystick** – Changes the map range when rotated. Activates the map pointer when pressed.
- ② **FPL Key** – Displays the active Flight Plan Page for creating and editing the active flight plan, or for accessing stored flight plans.
- ③ **Direct-to Key** – Allows the user to enter a destination waypoint and establish a direct course to the selected destination (the destination is either specified by the identifier, chosen from the active route, or taken from the map pointer position).
- ④ **MENU Key** – Displays a context-sensitive list of options. This list allows the user to access additional features or make setting changes that relate to particular pages.
- ⑤ **PROC Key** – Gives access to IFR departure procedures (DPs), arrival procedures (STARs) and approach procedures (IAPs) for a flight plan. If a flight plan is used, available procedures for the departure and/or arrival airport are automatically suggested. These procedures can then be loaded into the active flight plan. If a flight plan is not used, both the desired airport and the desired procedure may be selected.
- ⑥ **ENT Key** – Validates or confirms a menu selection or data entry.
- ⑦ **Dual FMS Knob** – Flight Management System Knob. When the **FMS Key** is pressed, this knob selects the MFD page to be viewed. The large knob selects a page group (MAP, WPT, AUX, NRST), while the small knob selects a specific page within the page group. Pressing the **FMS Knob** turns the selection cursor ON and OFF. When the cursor is ON, data may be entered in the applicable window by turning the small and large knobs. In this case, the large knob moves the cursor on the page, while the small knob selects individual characters for the highlighted cursor location.

- ⑧ **FMS Key** – Sets the **FMS** Knob to control FMS functions on the MFD. When pressed, an annunciator next to the key illuminates indicating adjustment of the **FMS** Knob will now affect FMS functions.
- ⑨ **COM Key** – Selects the COM radio to be tuned. The first press will select COM1, as indicated by an illuminated “1” to the left of the key. Press again to select COM2. This is annunciated with a “2” to the right of the key. Each subsequent press of the **COM** Key will switch between COM1 and COM2. Use Alphanumeric Keys to tune the selected COM.
- ⑩ **Frequency Transfer Key** – Switches the standby and active COM or NAV frequencies. Press and hold this key for two seconds to tune the emergency frequency (121.5 MHz) automatically into the active frequency field.
- ⑪ **NAV Key** – Selects the NAV radio to be tuned. The first press will select NAV1, as indicated by an illuminated “1” to the left of the key. Press again to select NAV2. This is annunciated with a “2” to the right of the key. Each subsequent press of the **NAV** Key will switch between NAV1 and NAV2. Use Alphanumeric Keys to tune the selected NAV.
- ⑫ **XPDR Key** – Sets the **FMS** Knob to enter transponders codes. When pressed, an annunciator next to the key illuminates indicating the **FMS** Knob can now be used for transponder code entry.
- ⑬ **IDENT Key** – Press to activate the IDENT function of the transponder.
- ⑭ **SEL Key** – The center of this key activates the selected MFD softkey, while the right and left arrows move the softkey selection box to the right and left, respectively.
- ⑮ **BKSP Key** – Moves the cursor back one character space.
- ⑯ **SPC Key** – Adds a space character.
- ⑰ **Alphanumeric Keys** – Allow the user to enter data.
- ⑱ **CLR Key** – Erases information, cancels entries, or removes page menus. Pressing and holding this key displays the Navigation Map Page automatically.

## AFCS CONTROLS

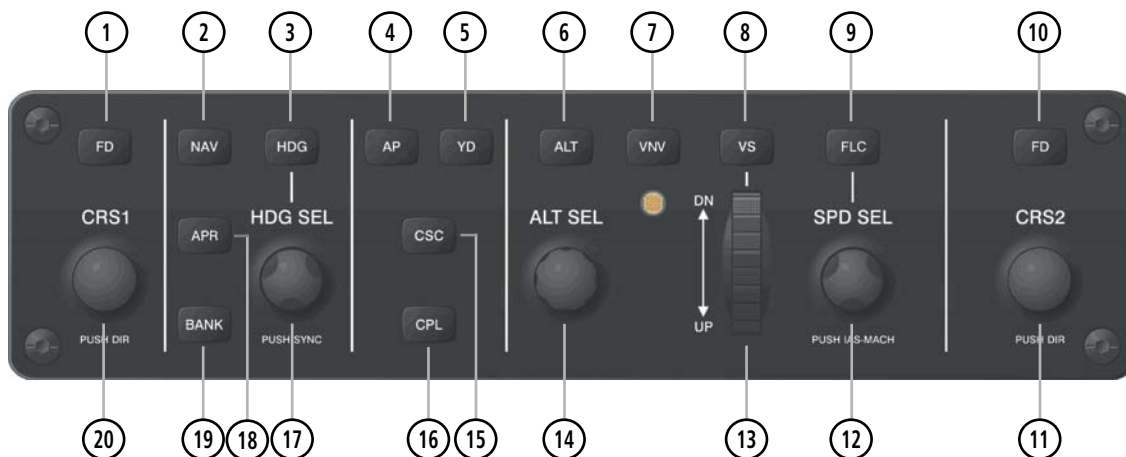

Figure 1-4 AFCS Control Unit (GMC 715)

The GFC 700 AFCS is mainly controlled through the GMC 715 AFCS Control Unit. The AFCS Control Unit consists of the following controls:

- ① ⑩ **FD Key** – Activates/deactivates the selected flight director (pilot- or copilot-side) in default vertical and lateral modes. Press the other **FD Key** to toggle the corresponding PFD's Command Bars off/on.
- ② **NAV Key** – Selects/deselects Navigation Mode.
- ③ **HDG Key** – Selects/deselects Heading Select Mode.
- ④ **AP Key** – Engages/disengages the autopilot.
- ⑤ **YD Key** – Engages/disengages the yaw damper.
- ⑥ **ALT Key** – Selects/deselects Altitude Hold Mode.
- ⑦ **VNV Key** – Selects/deselects Vertical Path Tracking Mode for Vertical Navigation flight control.
- ⑧ **VS Key** – Selects/deselects Vertical Speed Mode.
- ⑨ **FLC Key** – Selects/deselects Flight Level Change Mode.
- ⑪ ⑳ **CRS Knobs** – Adjusts the Selected Course in 1° increments on the Horizontal Situation Indicator (HSI) of the corresponding PFD. Press to re-center the Course Deviation Indicator (CDI) and return course pointer directly TO the bearing of the active waypoint/station.
- ⑫ **SPD SEL Knob** – Adjusts the Airspeed Reference and bug in 1-kt (0.01 M) increments. Press to toggle the Airspeed Reference units from IAS to Mach.
- ⑬ **UP/DN Wheel** – Adjusts the Vertical Speed Reference and bug in 100-fpm increments.
- ⑭ **ALT SEL Knob** – Adjusts the Selected Altitude and bug in 100-ft increments (a finer resolution of 10 feet is available under approach conditions).
- ⑮ **CSC Key** – Selects/deselects Current Speed Control (when Altitude Hold Mode is active)(if available).
- ⑯ **CPL Key** – Transfers selection between the active flight director and standby flight director. When the flight directors are switched, the modes revert to default. An arrow in the AFCS Status Box indicates the active FD (pilot- or copilot-side).
- ⑰ **HDG SEL Knob** – Adjusts the Selected Heading and bug in 1° increments on the HSI (both PFDs). Press to synchronize the Selected Heading to the current heading.
- ⑱ **APR Key** – Selects/deselects Approach Mode.
- ⑲ **BANK Key** – Manually selects/deselects Low Bank Mode.

## ADDITIONAL AFCS CONTROLS

The **AP DISC** (Autopilot Disconnect) Switch, **CWS** (Control Wheel Steering) Button, **GO AROUND** Switch, and **MEPT** (Manual Electric Pitch Trim) Switch are additional AFCS controls and are located in the cockpit, separately from the AFCS Control Unit. These are discussed in detail in the AFCS section.

## AUDIO PANEL CONTROLS

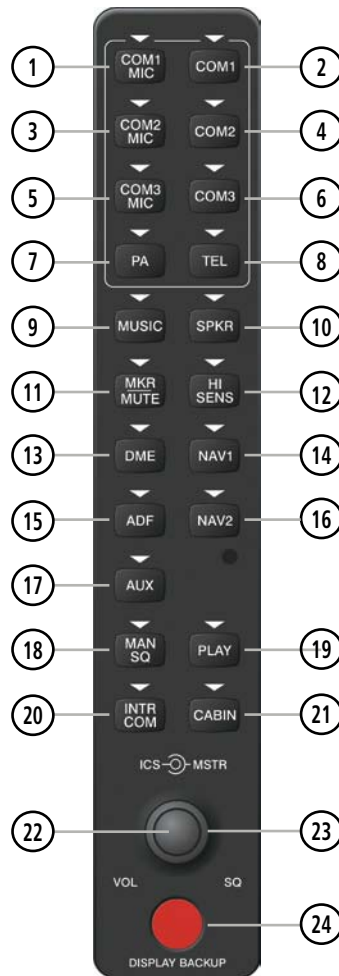

Figure 1-5 Audio Panel Controls (GMA 1347D)



**NOTE:** When a key is selected, a triangular annunciator above the key is illuminated.

- ① **COM1 MIC** – Selects the #1 transmitter for transmitting. COM1 receive is simultaneously selected when this key is pressed allowing received audio from the the #1 Com receiver to be heard. COM2 receiver audio can be added by pressing the **COM2** Key.
- ② **COM1** – When selected, audio from the #1 Com receiver can be heard.
- ③ **COM2 MIC** – Selects the #2 transmitter for transmitting. COM2 is simultaneously selected when this key is pressed allowing received audio from the the #2 Com receiver to be heard. COM2 can be deselected by pressing the **COM2** Key, or COM1 can be added by pressing the **COM1** Key.
- ④ **COM2** – When selected, audio from the #2 Com receiver can be heard.
- ⑤ **COM3 MIC** – Selects the #3 transmitter (HF) for transmitting. COM3 receive is simultaneously selected when this key is pressed allowing received audio from the #3 COM receiver to be heard.

- ⑥ **COM3** – When selected, audio from the #3 COM receiver (HF) can be heard.
- ⑦ **PA** – Selects the passenger address system. The selected Com transmitter is deselected when the **PA** Key is pressed.
- ⑧ **TEL** – When selected, activates the SATCOM transceiver.
- ⑨ **MUSIC** – Turns the Music 1 input on or off.
- ⑩ **SPKR** – Pressing this key selects and deselects the corresponding cockpit speaker. Com and Nav receiver audio will be heard on the speaker.
- ⑪ **MKR/MUTE** – Mutes the currently received Marker Beacon Receiver audio. Unmutes when new marker beacon audio is received.
- ⑫ **HI SENS** – Press to increase Marker Beacon Receiver sensitivity. Press again to return to normal.
- ⑬ **DME** – Pressing turns DME audio on or off.
- ⑭ **NAV1** – When selected, audio from the #1 Nav receiver can be heard.
- ⑮ **ADF** – Pressing turns on or off the audio from the ADF receiver, if installed.
- ⑯ **NAV2** – When selected, audio from the #2 Nav receiver can be heard.
- ⑰ **AUX** – Turns optional DME 2 audio on or off.
- ⑱ **MAN SQ** – Pressing activates/deactivates intercom manual squelch operation.
- ⑲ **PLAY** – Press once to play the last recorded audio. Press during play to play the previously recorded memory block. Each subsequent press of the **PLAY** Key will begin playing the next previously recorded block.
- ⑳ **INTR COM** – Pressing selects/deselects the pilot/copilot intercom on both audio panels.
- ㉑ **CABIN** – Pressing activates/deactivates two-way communication between pilot/copilot and passengers.
- ㉒ **ICS Knob** – Turn to adjust intercom volume or squelch. Press to switch between volume and squelch control as indicated by the ‘VOL’ or ‘SQ’ being illuminated. The **MAN SQ** Key must be selected to allow squelch adjustment.
- ㉓ **MSTR Knob** – The Master Volume Control adjusts volume for the blended NAV, COM, and intercom audio.
- ㉔ **Reversionary Mode Button** – Pressing manually selects Reversionary Mode.



## SOFTKEY FUNCTION

The softkeys are located along the bottoms of the displays. The softkeys shown depend on the softkey level or page being displayed. The bezel keys below the softkeys can be used to select the appropriate softkey. When a softkey is selected, its color changes to black text on gray background and remains this way until it is turned off, at which time it reverts to white text on black background.



Figure 1-6 Softkeys (Second-Level PFD Configuration)

Another means of selecting softkeys on the MFD is by using the MFD Control Unit:

### Selecting a softkey using the MFD Control Unit

- 1) Move the softkey selection box to the desired softkey using the arrows of the **SEL** Key.
- 2) Press the center of the **SEL** Key to select the desired softkey.

## PFD SOFTKEYS

The **CDI**, **IDENT**, **TMR/REF**, **NRST**, and **MSG** Softkeys undergo a momentary change to black text on gray background and automatically switch back to white text on black background when selected. If messages remain after acknowledgement, the **MSG** Softkey will be black on white.

The PFD softkeys provide control over flight management functions, including GPS, NAV, terrain, traffic, and lightning (optional). Each softkey sublevel has a **BACK** Softkey which can be pressed to return to the previous level. The **MSG** Softkey is visible in all softkey levels. For the top level softkeys and the transponder (XPDR) levels, the **IDENT** Softkey remains visible.

Level 1	Level 2	Level 3	Level 4	Description
<b>CAS</b>				Displays the scroll keys. Only displayed when the number of CAS messages exceeds the capacity of the display window.
	<b>CAS</b> ↑			Scroll up CAS messages (Accessible only when the <b>CAS</b> Softkey is displayed)
	<b>CAS</b> ↓			Scroll down CAS messages (Accessible only when the <b>CAS</b> Softkey is displayed)
<b>INSET or TRFC/MAP</b>				Displays Inset Map in PFD lower left corner. The <b>TRFC/MAP</b> Softkey is displayed when the TCAS II option is installed. Pressing the <b>TRFC/MAP</b> Softkey displays the Inset Map showing Traffic Map Page.
	<b>OFF</b>			Removes Inset Map

Level 1	Level 2	Level 3	Level 4	Description
	<b>DCLTR (3)</b>			Selects desired amount of map detail; cycles through declutter levels: DCLTR (No Declutter): All map features visible DCLTR-1: Declutters land data DCLTR-2: Declutters land and SUA data DCLTR-3: Removes everything except for the active flight plan
	<b>WX LGND</b>			Displays icon and age on the Inset Map for the selected weather products (optional)
	<b>TRAFFIC</b>			Cycles through traffic display options: TRFC-1: Traffic displayed on inset map TRFC-2: Traffic Map Page is displayed in the inset map window
	<b>TOPO</b>			Displays topographical data (e.g., coastlines, terrain, rivers, lakes) and elevation scale on Inset Map
	<b>TERRAIN</b>			Displays terrain information on Inset Map (not available with TAWS-A)
	<b>NEXRAD</b>			Displays NEXRAD weather and coverage information on Inset Map (optional feature)
	<b>XM LTNG</b>			Displays SiriusXM Weather lightning information on Inset Map (optional feature)
	<b>METAR</b>			Displays METAR flags on airport symbols shown on the Inset Map
<b>SENSOR</b>				Displays softkeys for selecting the #1 and #2 AHRS and Air Data Computers
	<b>ADC1</b>			Selects the #1 Air Data Computer
	<b>ADC2</b>			Selects the #2 Air Data Computer
	<b>ADCSTBY</b>			Selects the standby air data input
	<b>AHRS1</b>			Selects the #1 AHRS
	<b>AHRS2</b>			Selects the #2 AHRS
	<b>ATTSTBY</b>			Selects the standby attitude input. Heading input will come from the #1 AHRS.
<b>PFD</b>				Displays second-level softkeys for additional PFD configurations
	<b>SYN VIS</b>			Displays the softkeys for enabling or disabling Synthetic Vision features
		<b>PATHWAY</b>		Displays rectangular boxes representing the horizontal and vertical flight path of the active flight plan
		<b>SYN TERR</b>		Enables synthetic terrain depiction
		<b>HRZN HDG</b>		Displays compass heading along the Zero-Pitch line

Level 1	Level 2	Level 3	Level 4	Description
		<b>APTSIGNS</b>		Displays position markers for airports within approximately 15 nm of the current aircraft position. Airport identifiers are displayed when the airport is within approximately 9 nm.
	<b>DFLTS</b>			Resets PFD to default settings, including changing units to standard
	<b>WIND</b>			Displays softkeys to select wind data parameters
		<b>OPTN 1</b>		Headwind/tailwind and crosswind arrows with numeric speed components
		<b>OPTN 2</b>		Wind direction arrow with numeric speed
		<b>OPTN 3</b>		Wind direction arrow with headwind/tailwind and crosswind speed components
		<b>OFF</b>		Information not displayed
	<b>DME1</b>			Displays the information window for DME number 1
	<b>BRG1</b>			Cycles the Bearing 1 Information Window through NAV1, GPS/ waypoint identifier and GPS-derived distance information.
	<b>HSI FRMT</b>			Provides access to the HSI formatting softkeys
		<b>360 HSI</b>		Displays the HSI in a 360 degree view
		<b>ARC HSI</b>		Displays the HSI as an arc
	<b>BRG2</b>			Cycles the Bearing 2 Information Window through NAV2 or GPS waypoint identifier and GPS-derived distance information.
	<b>DME2</b>			Displays the information window for DME number 2
	<b>ALT UNIT</b>			Displays softkeys for setting the altimeter and BARO settings to metric units
		<b>METERS</b>		When enabled, displays altimeter in meters
		<b>IN</b>		Press to display the BARO setting as inches of mercury
		<b>HPA</b>		Press to display the BARO setting as hectopascals
	<b>STD BARO</b>			Sets barometric pressure to 29.92 in Hg (1013 hPa if metric units are selected)
<b>OBS</b>				Selects OBS mode on the CDI when navigating by GPS (only available with active leg)
<b>CDI</b>				Cycles through GPS, VOR1 (LOC1), and VOR2 (LOC2) navigation source on the CDI
<b>ADF/DME</b>				Displays the ADF/DME Tuning Window, providing ADF tuning capability and allowing selection of the NAV source for tuning each DME

Level 1	Level 2	Level 3	Level 4	Description
---------	---------	---------	---------	-------------

**Transponder Softkeys without TCAS II Option**

<b>XPDR</b>				Displays transponder mode selection softkeys
	<b>XPDR1</b>			Selects the #1 transponder as active
	<b>XPDR2</b>			Selects the #2 transponder as active
	<b>STBY</b>			Selects standby mode (transponder does not reply to any interrogations)
	<b>ON</b>			Selects Mode A (transponder replies to identification interrogations)
	<b>ALT</b>			Selects Mode C – altitude reporting mode (transponder replies to identification and altitude interrogations)
	<b>GND</b>			Manually selects Ground Mode, the transponder does not allow Mode A and Mode C replies, but it does permit acquisition squitter and replies to discretely addressed Mode S interrogations (not available with TCAS II)
	<b>VFR</b>			Automatically enters the VFR code (1200 in the U.S.A. only)(not available with TCAS II)
	<b>CODE</b>			Displays transponder code selection softkeys 0-7
		<b>0 – 7</b>		Use numbers to enter code
		<b>BKSP</b>		Removes numbers entered, one at a time
<b>IDENT</b>				Activates the Special Position Identification (SPI) pulse for 18 seconds, identifying the transponder return on the ATC screen
<b>TMR/REF</b>				Displays Timer/References Window
<b>NRST</b>				Displays Nearest Airports Window
<b>MSG</b>				Displays Messages Window

**Transponder/Traffic Softkeys with TCAS II Option**

<b>XPDR/TFC</b>				Displays the transponder and TCAS II system selection softkeys
	<b>MODE</b>			Displays transponder mode selection softkeys
		<b>STBY</b>		Selects transponder Standby Mode (transponder does not reply to any interrogations). When the transponder is set to standby, the TCAS II system is also set to standby.
		<b>ON</b>		Activates transponder (transponder replies to identification interrogations). When the transponder is set to ON, the TCAS II system is set to standby.
		<b>ALT</b>		Altitude Reporting Mode (transponder replies to identification and altitude interrogations). When the transponder is set to ALT, the TCAS II system is set to standby.

Level 1	Level 2	Level 3	Level 4	Description
		<b>TA ONLY</b>		Activates the TCAS II system in TA Only Mode and sets the transponder to ALT
		<b>TA/RA</b>		Activates the TCAS II system in TA/RA Mode and sets the transponder to ALT
		<b>BACK</b>		Returns to the previous softkey level
	<b>TCAS</b>			Displays the TCAS control softkeys
		<b>REL</b>		Displays intruder altitude as altitude relative to own aircraft altitude
		<b>ABS</b>		Displays intruder MSL altitude
		<b>ALT RNG</b>		Displays the altitude display range softkeys
			<b>ABOVE</b>	Displays non-threat traffic from 9900 feet above the aircraft to 2700 feet below the aircraft. Typically used during climb phase of flight.
			<b>NORMAL</b>	Displays non-threat traffic from 2700 feet above the aircraft to 2700 feet below the aircraft. Typically used during enroute phase of flight.
			<b>BELOW</b>	Displays non-threat traffic from 2700 feet above the aircraft to 9900 feet below the aircraft. Typically used during descent phase of flight.
			<b>UNREST</b>	All traffic is displayed
		<b>TEST</b>		Activates Test Mode and displays test intruder symbols
		<b>BACK</b>		Returns to the previous softkey level
	<b>CODE</b>			Displays transponder code selection softkeys 0-7
		<b>0 — 7</b>		Use numbers to enter code
		<b>IDENT</b>		Activates the Special Position Identification (SPI) pulse for 18 seconds, identifying the transponder return on the ATC screen
		<b>BKSP</b>		Removes numbers entered, one at a time
<b>IDENT</b>				Activates the Special Position Identification (SPI) pulse for 18 seconds, identifying the transponder return on the ATC screen
<b>TMR/REF</b>				Displays Timer/References Window
<b>NRST</b>				Displays Nearest Airports Window
<b>MSG</b>				Displays Messages Window

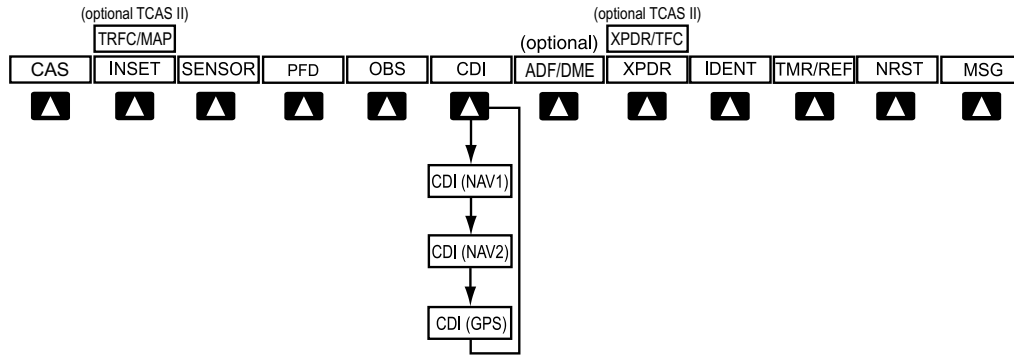

Figure 1-7 Top Level PFD Softkeys

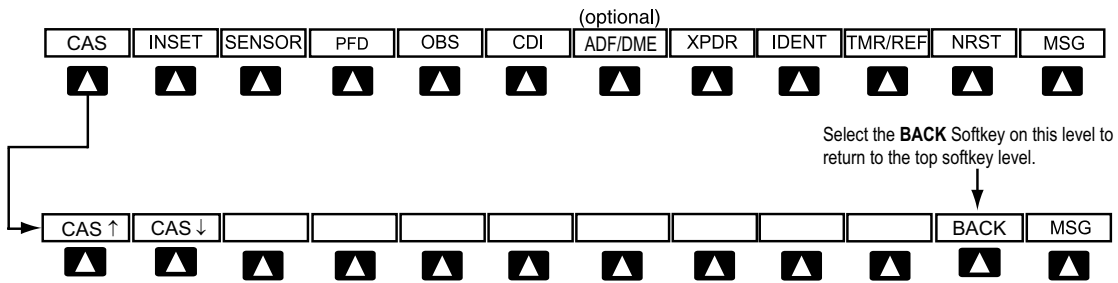

Figure 1-8 CAS Softkeys

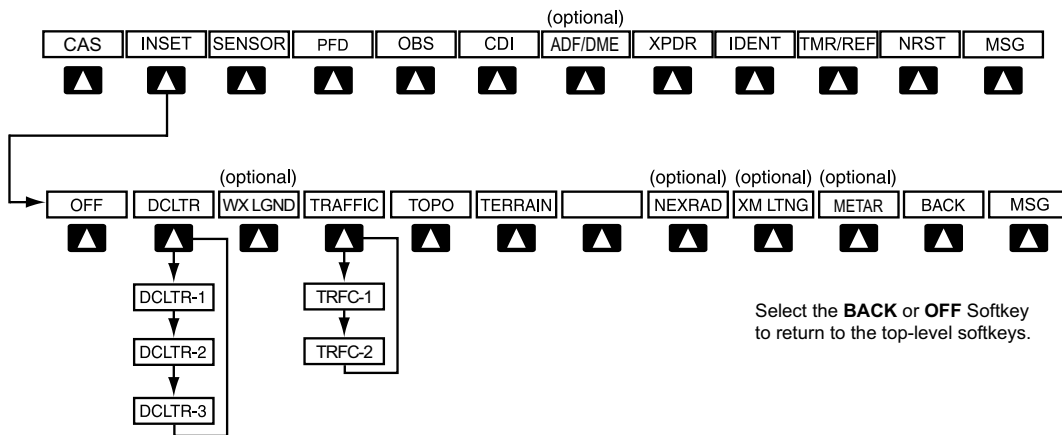

Figure 1-9 INSET Map Softkeys

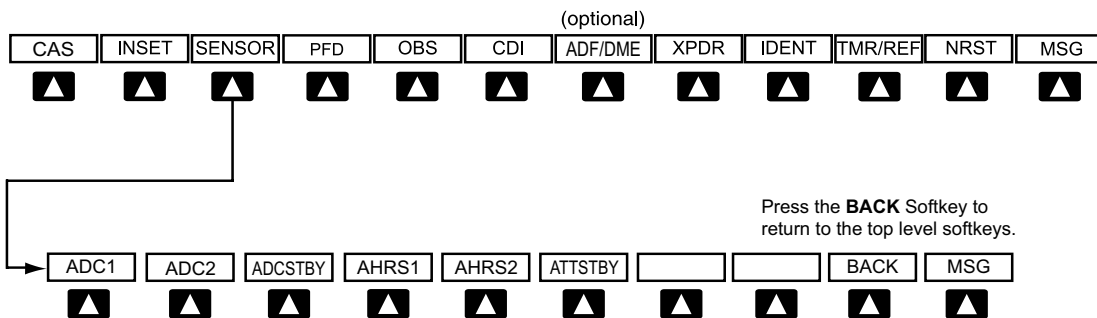

Figure 1-10 SENSOR Softkeys



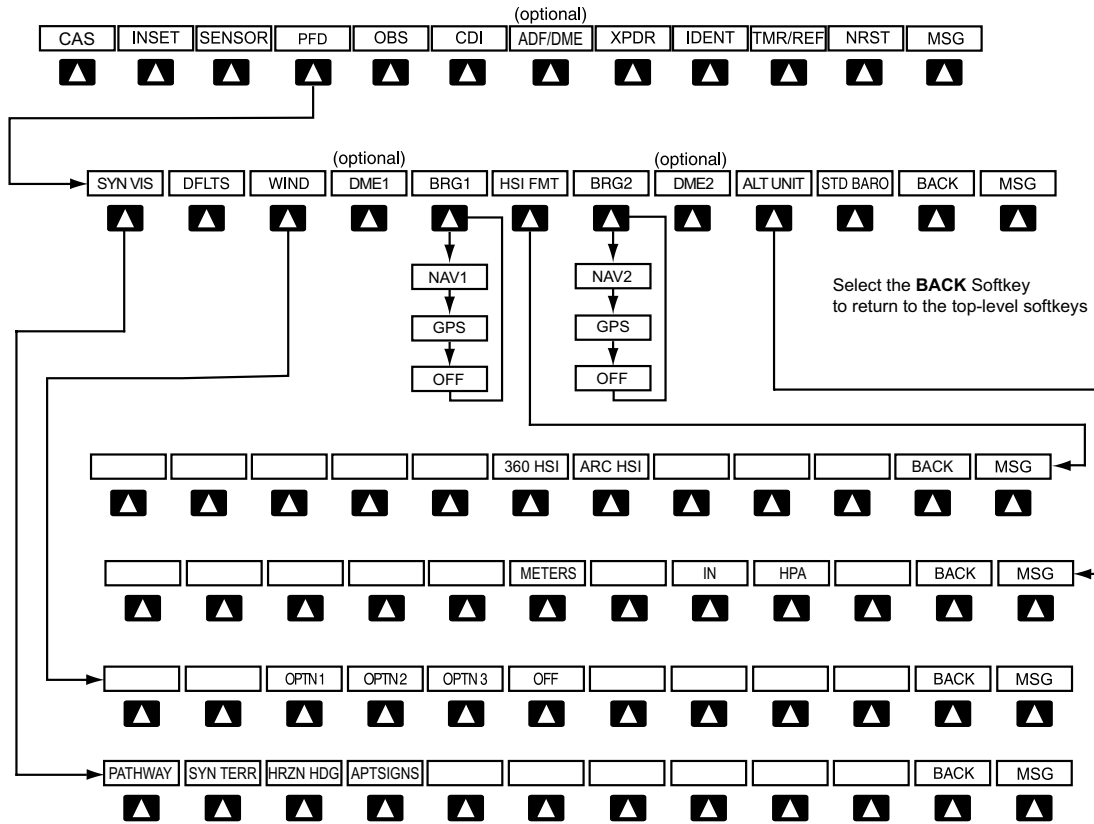

Figure 1-11 PFD Configuration Softkeys

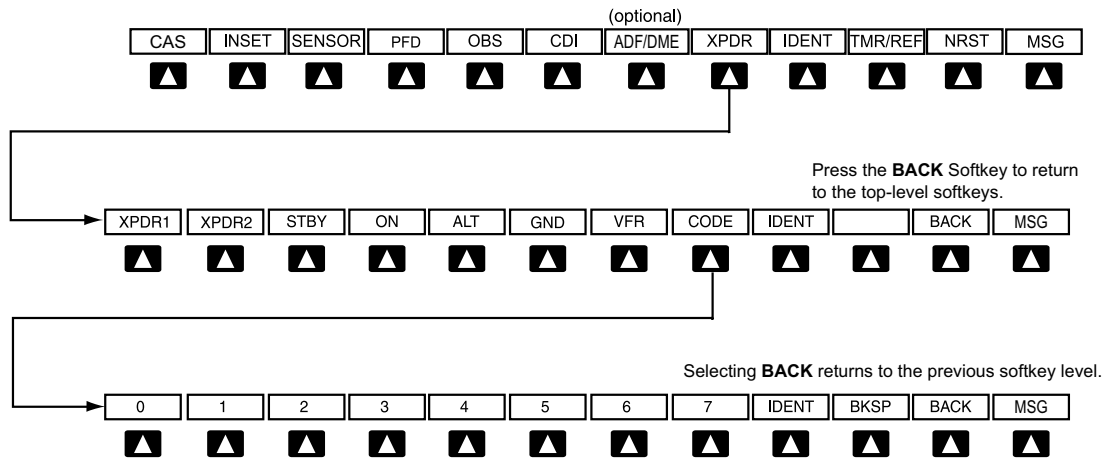

Figure 1-12 XPDR Softkeys (without TCAS II)

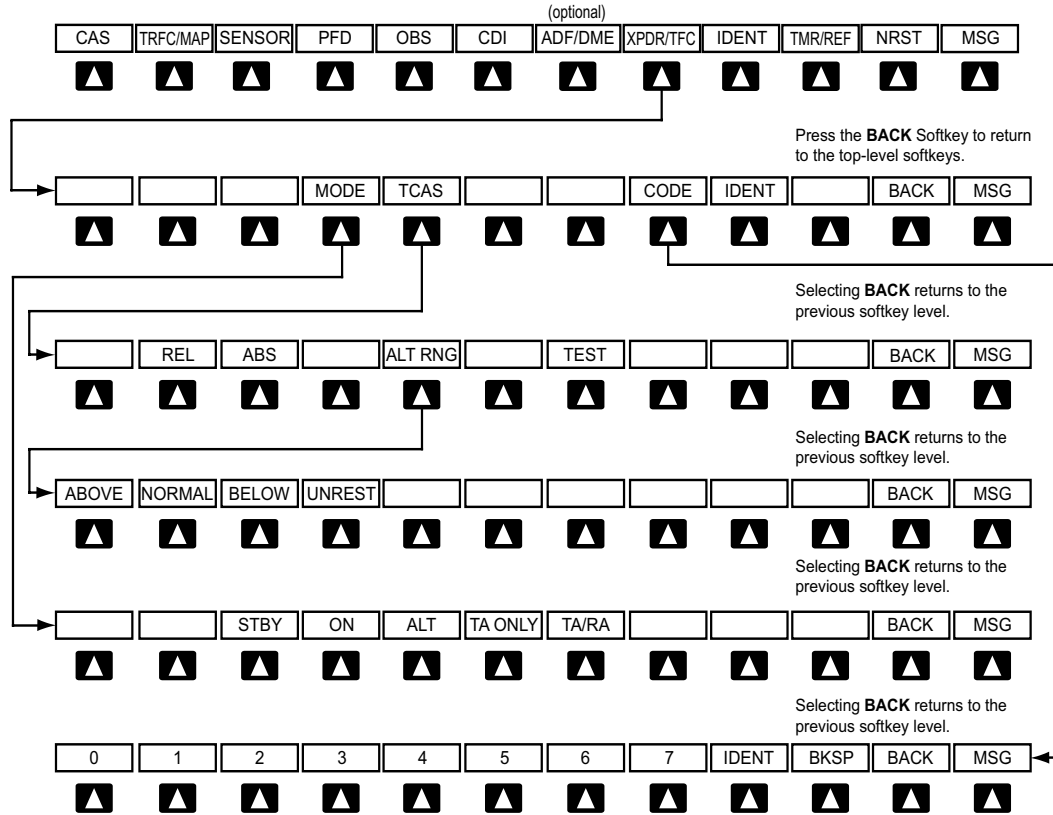

Figure 1-13 XPDR Softkeys (with TCAS II)

MFD SOFTKEYS

Level 1	Level 2	Level 3	Description
SYSTEM			Accesses EIS softkeys
	ENG SET		Accesses the FADEC settings softkeys; displays the Takeoff Data Set Window when aircraft is parked or taxiing
		CON	Selects the continuous thrust rating. Disabled when aircraft is on the ground.
		CLB	Selects the maximum climb thrust rating. Disabled when aircraft is on the ground.
		OAT ↑	Increases the takeoff outside air temperature setting in one-degree Celsius increments. Disabled when aircraft is in the air.
		OAT ↓	Decreases the takeoff outside air temperature setting in one-degree Celsius increments. Disabled when aircraft is in the air.
		ATR ON	Enables Automatic Thrust Reserve (ATR). Disabled when aircraft is in the air.
		ATR OFF	Disables Automatic Thrust Reserve (ATR). Disabled when aircraft is in the air.
		BACK	Returns display to previous softkey level
		ACCEPT	Confirms the selected takeoff settings

Level 1	Level 2	Level 3	Description
	<b>LFE</b>		Accesses softkeys for manually setting the Landing Field Elevation (LFE)
		<b>FMS LFE</b>	Sets current flight plan destination elevation as displayed LFE
		<b>+500 FT</b>	Increases currently displayed LFE value by 500 ft
		<b>-500 FT</b>	Decreases currently displayed LFE value by 500 ft
		<b>+50 FT</b>	Increases currently displayed LFE value by 50 ft
		<b>-50 FT</b>	Decreases currently displayed LFE value by 50 ft
		<b>ACCEPT</b>	Confirms the LFE setting and returns to the previous softkey level
		<b>BACK</b>	Returns display to previous softkey level
	<b>STATUS</b>		Displays the System-Status Page
	<b>ECS</b>		Displays the System-ECS (Environmental Control System) Page
	<b>ELEC</b>		Displays the System-Electrical Page
	<b>FUEL</b>		Displays the System-Fuel Page
	<b>ICEPROT</b>		Displays the System-Deice Page
	<b>ENG MNT</b>		Displays the Engine Maintenance Page. Enabled only while aircraft is on the ground and engines are off.
	<b>BACK</b>		Returns display to previous softkey level
<b>MAP</b>			Enables second-level Navigation Map softkeys
	<b>TRAFFIC</b>		Displays traffic information on Navigation Map
	<b>TOPO</b>		Displays topographical data (e.g., coastlines, terrain, rivers, lakes) and elevation scale on Navigation Map
	<b>TERRAIN</b>		Displays terrain information on Navigation Map (not available with TAWS-A)
	<b>AIRWAYS</b> (Default label is dependant on map setup option selected)		Displays airways on the map; cycles through the following: AIRWAYS: No airways are displayed AIRWY ON: All airways are displayed AIRWY LO: Only low altitude airways are displayed AIRWY HI: Only high altitude airways are displayed
	<b>NEXRAD</b>		Displays NEXRAD weather and coverage information on the Navigation Map (optional feature)
	<b>XM LTNG</b>		Displays SiriusXM Satellite Weather lightning information on the Navigation Map (optional feature)
	<b>METAR</b>		Displays METAR flags on airport symbols
	<b>BACK</b>		Returns to top-level softkeys
<b>DCLTR (3)</b>			Selects desired amount of map detail; cycles through declutter levels: DCLTR (No Declutter): All map features visible DCLTR-1: Declutters land data DCLTR-2: Declutters land and SUA data DCLTR-3: Removes everything except the active flight plan
<b>SHW CHRT</b>			When available, displays optional airport and terminal procedure charts

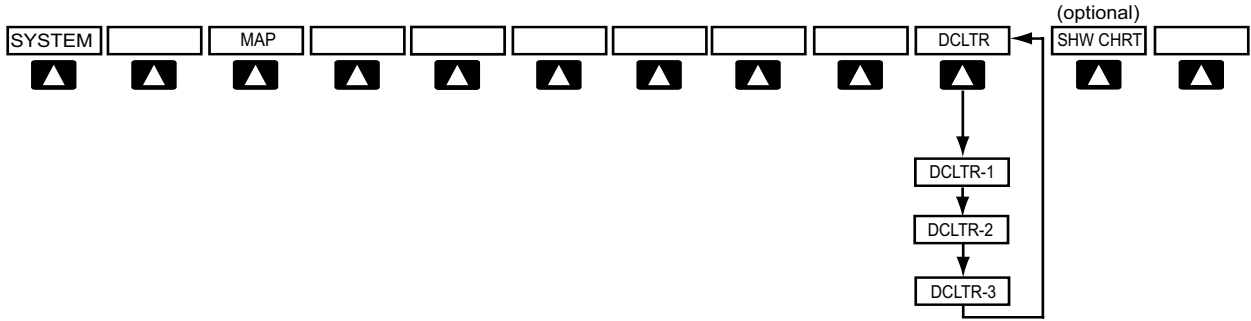

Figure 1-14 Top Level MFD Softkeys

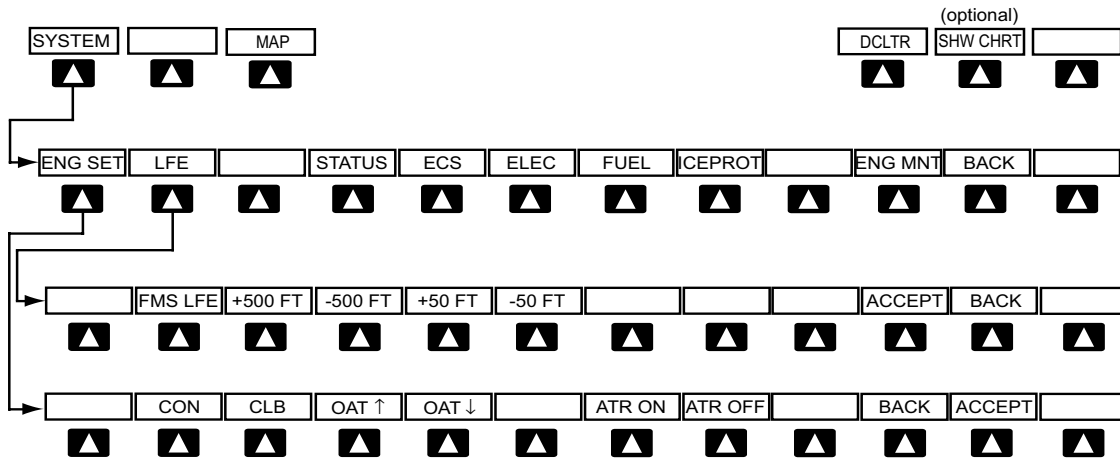

Figure 1-15 SYSTEM Softkeys

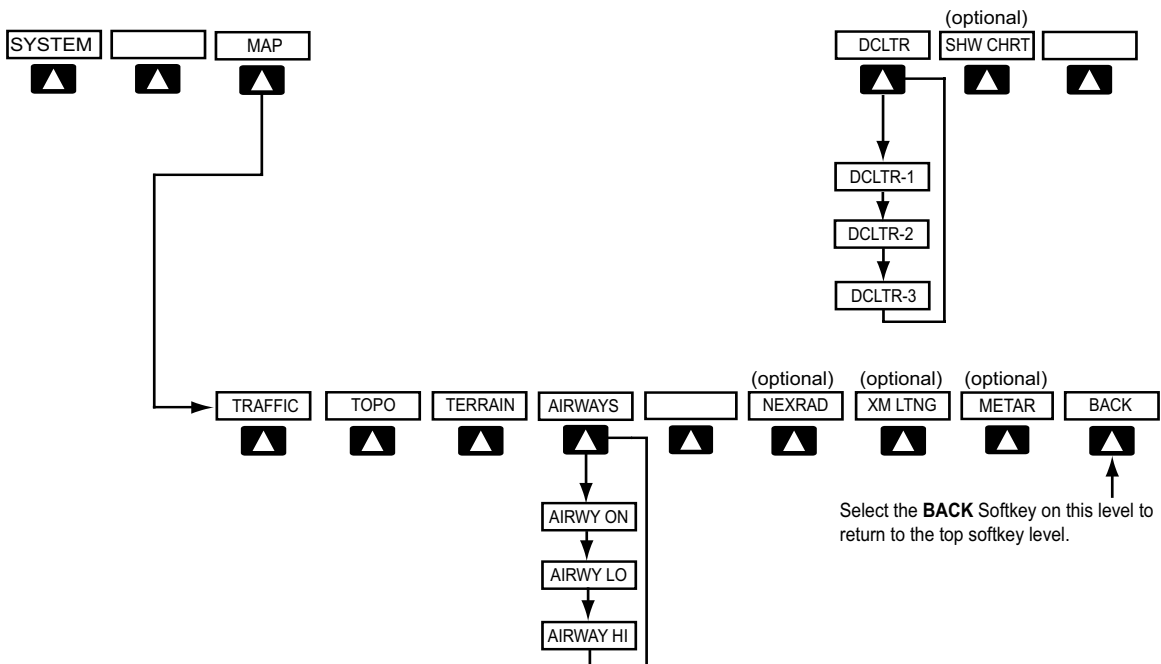

Figure 1-16 MAP Softkeys

## 1.4 SECURE DIGITAL CARDS



**NOTE:** DO NOT use the database SD cards for any purpose other than database storage.



**NOTE:** Refer to the Appendices for instructions on updating databases.



**NOTE:** Ensure that the system is powered off before inserting the SD card.

The GDU 1240A data card slots use Secure Digital (SD) cards and are located on the top right portion of the display bezels. Each display bezel is equipped with two SD card slots. SD cards are used for the various databases and system software updates as well as terrain database storage.

Not all SD cards are compatible with the Prodigy® system. Use only SD cards supplied by Garmin or the aircraft manufacturer.

### Install an SD card

Insert the SD card in the SD card slot, pushing the card in until the spring latch engages. The front of the card should remain flush with the face of the display bezel.

### Remove an SD card

Gently press on the SD card to release the spring latch and eject the card.



Figure 1-17 Display Bezel SD Card Slots

## 1.5 SYSTEM POWER-UP



**NOTE:** Refer to the Appendices for AHRS initialization bank angle limitations.



**NOTE:** See the Appendices for additional information regarding system-specific annunciations and alerts.



**NOTE:** See the Airplane Flight Manual (AFM) for specific procedures concerning avionics power application and emergency power supply operation.

The system is integrated with the aircraft electrical system and receives power directly from electrical busses. The PFDs, MFD and supporting sub-systems include both power-on and continuous built-in test features that exercise the processor, RAM, ROM, external inputs and outputs to provide safe operation.

During system initialization, test annunciations are displayed, as shown in Figure 1-18. All system annunciations should disappear typically within one minute of power-up. Upon power-up, key annunciator lights also become momentarily illuminated on the audio panels, the control units and the display bezels.

On the PFD, the AHRS begins to initialize and displays ‘AHRS ALIGN: Keep Wings Level’. The AHRS should display valid attitude and heading fields typically within one minute of power-up. The AHRS can align itself both while taxiing and during level flight.

When the MFD powers up (Figure 1-19), the MFD Power-up Page displays the following information:

- System version
- Copyright
- Land database name and version
- Safe Taxi database information
- Terrain database name and version
- Airport Terrain database name and version
- Obstacle database name and version
- Navigation database name, version, and effective dates
- Airport Directory name, version and effective dates
- FliteCharts/ChartView database information

Current database information includes the valid operating dates, cycle number and database type. When this information has been reviewed for currency (to ensure that no databases have expired), the pilot is prompted to continue. Pressing the **ENT** Key acknowledges this information and displays the System - Status Page.



Figure 1-18 PFD Initialization

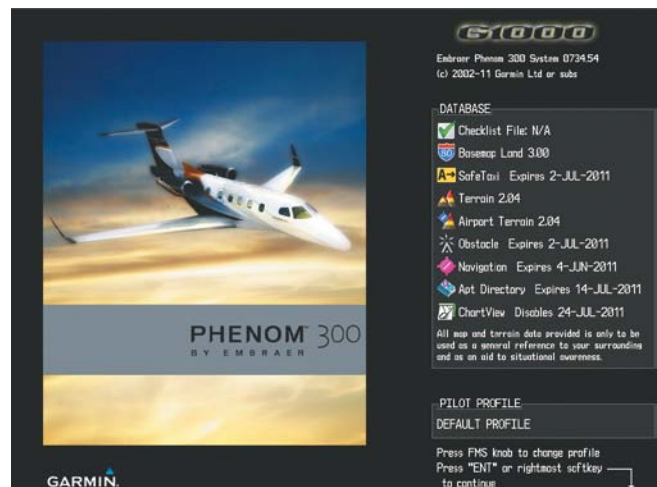

Figure 1-19 MFD Power-up Page

## 1.6 SYSTEM OPERATION

The displays are connected via a single Ethernet bus, thus allowing for high-speed communication. As shown in Figure 1-1. The GIA 63W #1 is connected to PFD1 and GIA 63W #2 is connected to the HSDB switch. This section discusses the normal and reversionary modes of operation as well as the various AHRS modes of the system.

In the event of display failure, the display modes are as follows:

- **PFD1 failure** – MFD enters reversionary mode; PFD2 remains in normal mode.
- **MFD failure** – PFD1 and PFD2 enter reversionary mode.
- **PFD2 failure** – PFD1 and the MFD remain in normal mode.

### NORMAL OPERATION

#### PFD

In normal mode, the PFD presents graphical flight instrumentation (attitude, heading, airspeed, altitude and vertical speed), thereby replacing the traditional flight instrument cluster. The PFD also offers control for COM and NAV frequency selection.

#### MFD

In normal mode, the right portion of the MFD displays a full-color moving map with navigation information, while the left portion of the MFD is dedicated to engine, fuel, electrical, cabin pressurization, oxygen, landing gear, and trim/flaps indication.

Figure 1-20 gives an example of the system displays in normal mode.



Figure 1-20 Normal Operation



**REVERSIONARY MODE**

**NOTE:** The system alerts the pilot when backup paths are utilized by the LRUs. Refer to the Appendices for further information regarding system-specific alerts.

Reversionary mode is a mode of operation in which all important flight information is presented identically on at least one of the remaining displays (see Figure 1-21). Transition to reversionary mode should be straightforward for the pilot, for flight parameters are presented in the same format as in normal mode.



**Figure 1-21 Reversionary Mode**

Reversionary mode is activated by pressing the dedicated **DISPLAY BACKUP** button at the bottom of the audio panel (see Figure 1-22 and refer to the Audio Panel section for further details). Pressing this button again deactivates reversionary mode.

Pressing the **DISPLAY BACKUP** button activates/deactivates reversionary mode for both the on-side PFD and the MFD.





**Figure 1-22 DISPLAY BACKUP Button**

Each display can be configured to operate in reversionary mode, as follows:

- **PFD1** – By pressing the **DISPLAY BACKUP** button on the left audio panel.
- **MFD** – By pressing the **DISPLAY BACKUP** button on the left or the right audio panel.
- **PFD2** – By pressing the **DISPLAY BACKUP** button on the right audio panel.

**AHRS OPERATION**

-  **NOTE:** Refer to the Appendices for specific AHRS alert information.
-  **NOTE:** Aggressive maneuvering while the AHRS is not operating normally can degrade AHRS accuracy.

In addition to using internal sensors, the GRS 77 AHRS uses GPS information, magnetic field data and air data to assist in attitude/heading calculations. In normal mode, the AHRS relies upon GPS and magnetic field measurements. If either of these external measurements is unavailable or invalid, the AHRS uses air data information for attitude determination. Four AHRS modes of operation are available (see Figure 1-23) and depend upon the combination of available sensor inputs. Loss of air data, GPS, or magnetometer sensor inputs is communicated to the pilot by message advisory alerts.

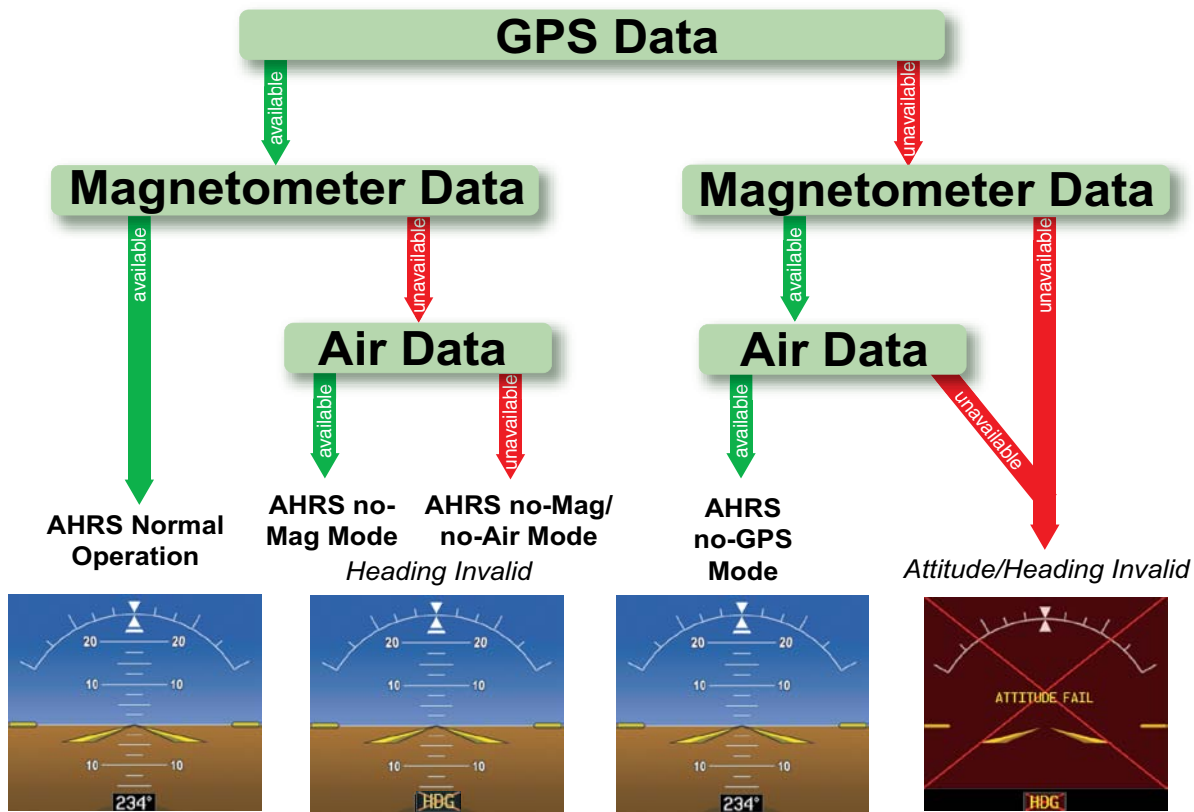

Figure 1-23 AHRS Operation

The AHRS (GRS 77) corrects for shifts and variations in the Earth’s magnetic field by applying the Magnetic Field Variation Database. The Magnetic Field Variation Database is derived from the International Geomagnetic Reference Field (IGRF). The IGRF is a mathematical model that describes the Earth’s main magnetic field and its annual rate of change. The database is updated approximately every five years. See the Appendices for information on updating the Magnetic Field Variation Database. The system will prompt the pilot on startup when an update is available. Failure to update this database could lead to erroneous heading information being displayed to the pilot.

## GPS INPUT FAILURE



**NOTE:** *In-flight initialization of AHRS, when operating without any valid source of GPS data and at true air speed values greater than approximately 200 knots, is not guaranteed. Under these rare conditions, it is possible for in-flight AHRS initialization to take an indefinite amount of time which would result in an extended period of time where valid AHRS outputs are unavailable.*

The system provides two sources of GPS information. If a single GPS receiver fails, or if the information provided from one of the GPS receivers is unreliable, the AHRS seamlessly transitions to using the other GPS receiver. An alert message informs the pilot of the use of the backup GPS path. If both GPS inputs fail, the AHRS continues to operate in reversionary No-GPS mode so long as the air data and magnetometer inputs are available and valid.

## AIR DATA INPUT FAILURE

A failure of the air data input has no effect on AHRS output while AHRS is operating in normal mode. A failure of the air data input while the AHRS is operating in reversionary No-GPS mode results in invalid attitude and heading information on the PFD (as indicated by red “X” flags).

## MAGNETOMETER FAILURE

If the magnetometer input fails, the AHRS transitions to one of the reversionary No-Magnetometer modes and continues to output valid attitude information. However, if the aircraft is airborne, the heading output on the PFD does become invalid (as indicated by a red “X”).

## PRODIGY® SYSTEM ANNUNCIATIONS

**NOTE:** For a detailed description of all annunciations and alerts, refer to Appendix A. Refer to the Airplane Flight Manual (AFM) for additional information regarding pilot responses to these annunciations.

When an LRU or an LRU function fails, a large red “X” is typically displayed on windows associated with the failed data (Figure 1-24 displays all possible flags and responsible LRUs). Upon system power-up, certain windows remain invalid as equipment begins to initialize. All windows should be operational within one minute of power-up. If any window remains flagged, the system should be serviced by a Garmin-authorized repair facility.

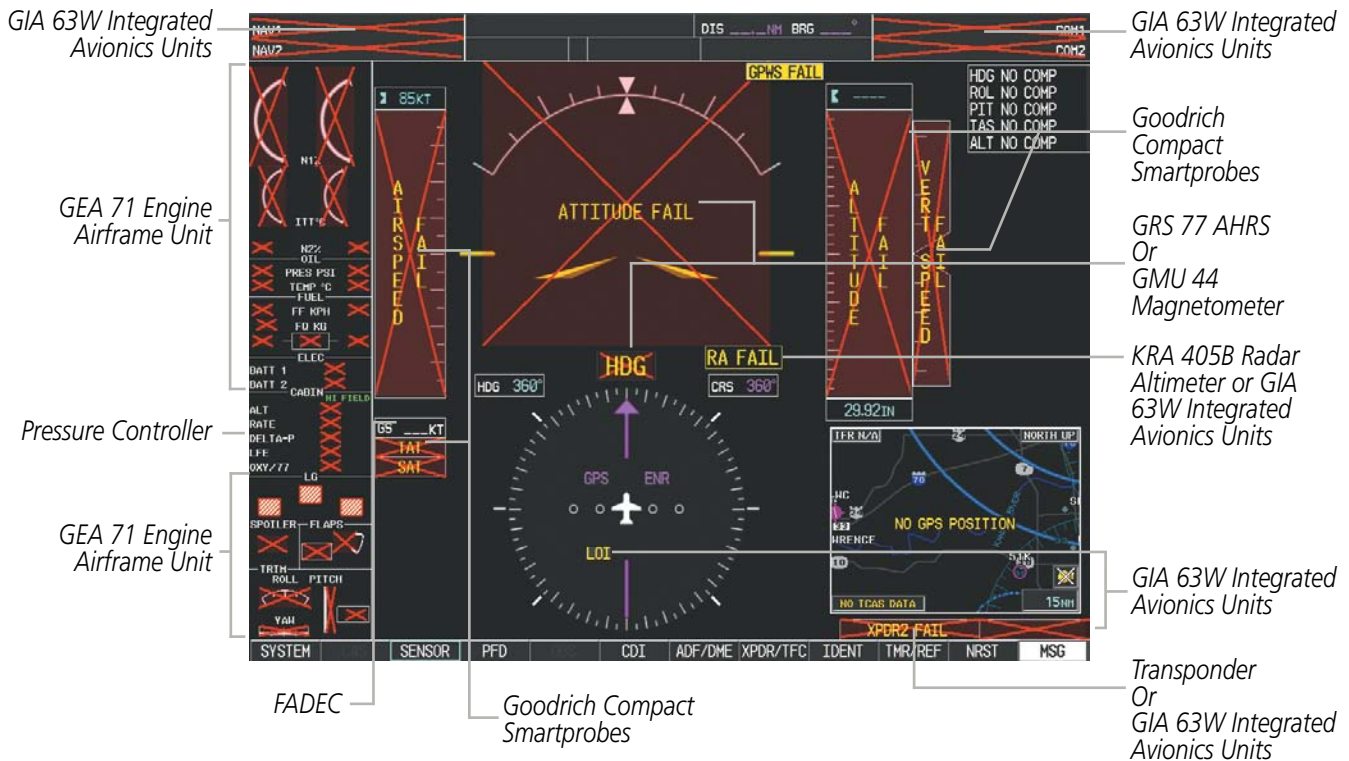

Figure 1-24 System Failure Annunciations

## GPS RECEIVER OPERATION

Each GIA 63W Integrated Avionics Unit (GIA) contains a GPS receiver. Information collected by the specified receiver (GPS1 for the #1 GIA or GPS2 for the #2 GIA) may be viewed on the AUX - GPS Status Page.

GPS1 provides information to the pilot-side PFD and GPS2 provides data to the copilot-side PFD. Internal system checking is performed to ensure both GPS receivers are providing accurate data to the PFDs. In some circumstances, both GPS receivers may be providing accurate data, but one receiver may be providing a better GPS solution than the other receiver. In this case the GPS receiver producing the better solution will be automatically coupled to both PFDs. “BOTH ON GPS 1” or “BOTH ON GPS 2” will then be displayed in the Reversionary Sensor Window (see Appendix A) indicating which GPS receiver is being used. Both GPS receivers are still functioning properly, but one receiver is performing better than the other at that particular time.

These GPS sensor annunciations are most often seen after system power-up when one GPS receiver has acquired satellites before the other, or one of the GPS receivers has not yet acquired an SBAS (Satellite Based Augmentation System) signal. While the aircraft is on the ground, the SBAS signal may be blocked by obstructions causing one GPS receiver to have difficulty acquiring a good signal. Also, while airborne, turning the aircraft may result in one of the GPS receivers temporarily losing the SBAS signal.

If the sensor annunciation persists, check for a system failure message in the Messages Window on the PFD. If no failure message exists, check the GPS Status Page and compare the information for GPS1 and GPS2. Discrepancies may indicate a problem.

### Viewing GPS receiver status information:

- 1) Use the large **FMS** Knob on the MFD to select the Auxiliary Page Group (see Section 1.7 for information on navigating MFD page groups).
- 2) Use the small **FMS** Knob to select GPS Status Page.

### Selecting the GPS receiver for which data may be reviewed:

- 1) Use the **FMS** Knob to select the AUX - GPS Status Page.
- 2) To change the selected GPS receiver:
  - a) Press the desired **GPS** Softkey.

**Or:**

  - a) Press the **MENU** Key.
  - b) Use the **FMS** Knob to highlight the receiver which is not selected and press the **ENT** Key.

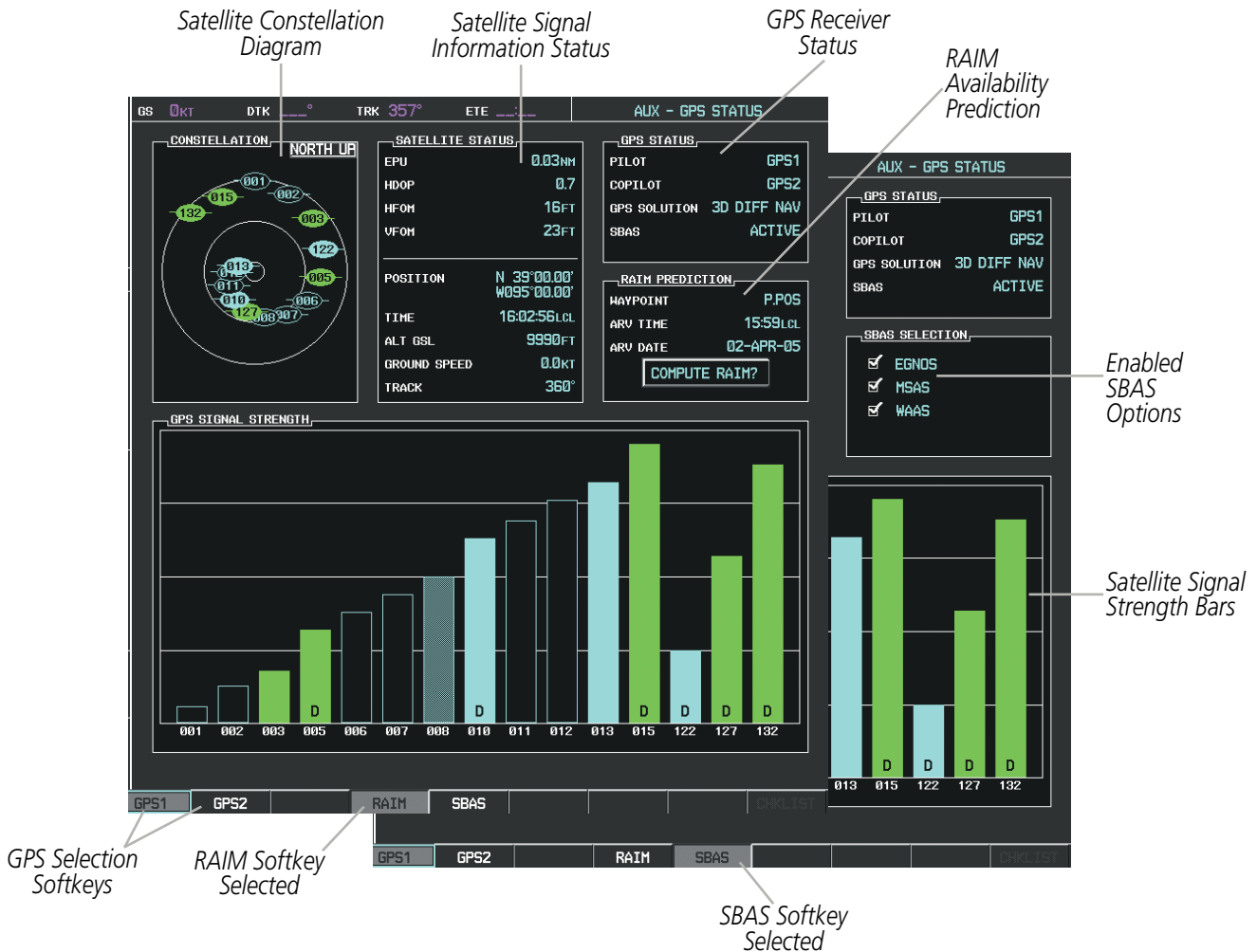

Figure 1-25 GPS Status Page (RAIM or SBAS Selected)

The GPS Status Page provides the following information:

- Satellite constellation diagram

Satellites currently in view are shown at their respective positions on a sky view diagram. The sky view is always in a north-up orientation, with the outer circle representing the horizon, the inner circle representing 45° above the horizon, and the center point showing the position directly overhead.

Each satellite is represented by an oval containing the Pseudo-random noise (PRN) number (i.e., satellite identification number). Satellites whose signals are currently being used are represented by solid ovals.

- Satellite signal information status

The accuracy of the aircraft's GPS fix is calculated using Estimated Position Uncertainty (EPU), Dilution of Precision (DOP), and horizontal and vertical figures of merit (HFOM and VFOM). EPU is the radius of a circle centered on an estimated horizontal position in which actual position has 95% probability of laying. EPU is a statistical error indication and not an actual error measurement.

DOP measures satellite geometry quality (i.e., number of satellites received and where they are relative to each other) on a range from 0.0 to 9.9, with lower numbers denoting better accuracy. HFOM and VFOM,

measures of horizontal and vertical position uncertainty, are the current 95% confidence horizontal and vertical accuracy values reported by the GPS receiver.

The current calculated GPS position, time, altitude, ground speed, and track for the aircraft are displayed below the satellite signal accuracy measurements.

- GPS receiver status

The selected GPS receiver is indicated for the pilot and copilot display.

The GPS solution type (ACQUIRING, 2D NAV, 2D DIFF NAV, 3D NAV, 3D DIFF NAV) for the active GPS receiver (GPS1 or GPS2) is shown in the upper right of the GPS Status Page. When the receiver is in the process of acquiring enough satellite signals for navigation, the receiver uses satellite orbital data (collected continuously from the satellites) and last known position to determine the satellites that should be in view. ACQUIRING is indicated as the solution until a sufficient number of satellites have been acquired for computing a solution.

When the receiver is in the process of acquiring a 3D navigational GPS solution, 3D NAV is indicated as the solution until the 3D differential fix has finished acquisition. SBAS (Satellite-Based Augmentation System) will indicate INACTIVE. When acquisition is complete, the solution status will indicate 3D DIFF NAV and SBAS will indicate ACTIVE.

- RAIM (Receiver Autonomous Integrity Monitoring) Prediction (**RAIM** Softkey is selected)

In most cases performing a RAIM prediction will not be necessary. However, in some cases, the selected approach may be outside the SBAS coverage area and it may be necessary to perform a RAIM prediction for the intended approach.

Receiver Autonomous Integrity Monitoring (RAIM) is a GPS receiver function that performs a consistency check on all tracked satellites. RAIM ensures that the available satellite geometry allows the receiver to calculate a position within a specified RAIM protection limit (2.0 nautical miles for oceanic and enroute, 1.0 nm for terminal, and 0.3 nm for non-precision approaches). During oceanic, enroute, and terminal phases of flight, RAIM is available nearly 100% of the time.

The RAIM prediction function also indicates whether RAIM is available at a specified date and time. RAIM computations predict satellite coverage within  $\pm 15$  min of the specified arrival date and time.

Because of the tighter protection limit on approaches, there may be times when RAIM is not available. The system automatically monitors RAIM and warns with an alert message when it is not available. If RAIM is not predicted to be available for the final approach course, the approach does not become active, as indicated by the messages "Approach is not active" and "RAIM not available from FAF to MAP". If RAIM is not available when crossing the FAF, the missed approach procedure must be flown.

**Predicting RAIM availability:**

- 1) Select the GPS Status Page.
- 2) If necessary, select the **RAIM** Softkey.
- 3) Press the **FMS** Knob. The 'WAYPOINT' field is highlighted.
- 4) Turn the small **FMS** Knob to display the Waypoint Information Window.
- 5) Enter the desired waypoint:
  - a) Use the **FMS** Knob to enter the desired waypoint by identifier, facility, or city name and press the **ENT** Key. Refer to Section 1.7 for instructions on entering alphanumeric data into the system.

**Or:**



- a) Use the large **FMS** Knob to scroll to the Most Recent Waypoints List.
  - b) Use the small FMS Knob to highlight the desired waypoint in the list and press the **ENT** Key. The system automatically fills in the identifier, facility, and city fields with the information for the selected waypoint.
  - c) Press the **ENT** Key to accept the waypoint entry.
- Or:**
- a) To use the present position, press the **MENU** Key.
  - b) With 'Set WPT to Present Position' highlighted, press the **ENT** Key.
  - c) Press the **ENT** Key to accept the waypoint entry.
- 6) Use the **FMS** Knob to enter an arrival time and press the **ENT** Key.
  - 7) Use the **FMS** Knob to enter an arrival date and press the **ENT** Key.
  - 8) With the cursor highlighting 'COMPUTE RAIM?', press the **ENT** Key. Once RAIM availability is computed, one of the following is displayed:
    - 'COMPUTE RAIM?'—RAIM has not been computed for the current waypoint, time, and date combination
    - 'COMPUTING AVAILABILITY'—RAIM calculation in progress
    - 'RAIM AVAILABLE'—RAIM is predicted to be available for the specified waypoint, time, and date
    - 'RAIM NOT AVAILABLE'—RAIM is predicted to be unavailable for the specified waypoint, time, and date

#### **Predicting RAIM availability at present position**

- 1) Select the GPS Status Page.
- 2) If necessary, select the **RAIM** Softkey.
- 3) Press the **FMS** Knob. The 'WAYPOINT' field is highlighted.
- 4) Press the **MENU** Key.
- 5) With 'Set WPT to Present Position' highlighted, press the **ENT** Key.
- 6) Press the **ENT** Key to accept the waypoint entry.
- 7) Use the **FMS** Knob to enter an arrival time and press the **ENT** Key.
- 8) Use the **FMS** Knob to enter an arrival date and press the **ENT** Key.
- 9) With the cursor highlighting 'COMPUTE RAIM?', press the **ENT** Key. Once RAIM availability is computed, one of the following is displayed:
  - 'COMPUTE RAIM?'—RAIM has not been computed for the current waypoint, time, and date combination
  - 'COMPUTING AVAILABILITY'—RAIM calculation in progress
  - 'RAIM AVAILABLE'—RAIM is predicted to be available for the specified waypoint, time, and date
  - 'RAIM NOT AVAILABLE'—RAIM is predicted to be unavailable for the specified waypoint, time, and date

- SBAS Selection (**SBAS** Softkey is pressed)(WAAS, EGNOS, or MSAS capable systems only)

In certain situations, such as when the aircraft is outside or on the fringe of the WAAS, EGNOS, or MSAS coverage area, it may be desirable to disable the reception of the applicable SBAS signal (although it is not recommended). When disabled, the SBAS field in the GPS Status box indicates DISABLED. There may be a small delay for the GPS Status box to be updated upon WAAS, EGNOS, and MSAS enabling/disabling.

#### Disabling WAAS, EGNOS or MSAS

- 1) Select the GPS Status Page.
  - 2) If necessary, select the **SBAS** Softkey.
  - 3) Press the **FMS** Knob, and turn the large FMS Knob to highlight the desired SBAS system.
  - 4) Press the **ENT** Key to uncheck the box.
  - 5) Press the **FMS** Knob to remove the cursor.
- GPS Satellite Signal Strengths

The GPS Status Page can be helpful in troubleshooting weak (or missing) signal levels due to poor satellite coverage or installation problems. As the GPS receiver locks onto satellites, a signal strength bar is displayed for each satellite in view, with the appropriate satellite PRN number (01-32 or 120-138 for WAAS) below each bar. The progress of satellite acquisition is shown in three stages, as indicated by signal bar appearance:

- No bar—Receiver is looking for the indicated satellite
- Hollow bar—Receiver has found the satellite and is collecting data
- Light blue bar—Receiver has collected the necessary data and the satellite signal can be used
- Green bar—Satellite is being used for the GPS solution
- Checkered bar—Receiver has excluded the satellite (Fault Detection and Exclusion)
- “D” indication—Denotes the satellite is being used as part of the differential computations

Each satellite has a 30-second data transmission that must be collected (signal strength bar is hollow) before the satellite may be used for navigation (signal strength bar becomes solid).

## 1.7 ACCESSING SYSTEM FUNCTIONALITY

### MENUS

The system has a MENU Key that, when pressed, displays a context-sensitive list of options. This options list allows the user to access additional features or make settings changes which specifically relate to the currently displayed window/page. There is no all-encompassing menu. Some menus provide access to additional submenus that are used to view, edit, select, and review options. Menus display 'NO OPTIONS' when there are no options for the window/page selected. The main controls used in association with all window/page group operations are described in section 1.3. Softkey selection does not display menus or submenus.

#### Navigating the Page Menu Window:

- 1) Press the **MENU** Key to display the Page Menu Window.
- 2) Turn the **FMS** Knob to scroll through a list of available options (a scroll bar appears to the right of the window when the option list is longer than the window).
- 3) Press the **ENT** Key to select the desired option.
- 4) The **CLR** Key may be pressed to remove the menu and cancel the operation. Pressing the **FMS** Knob also removes the displayed menu.

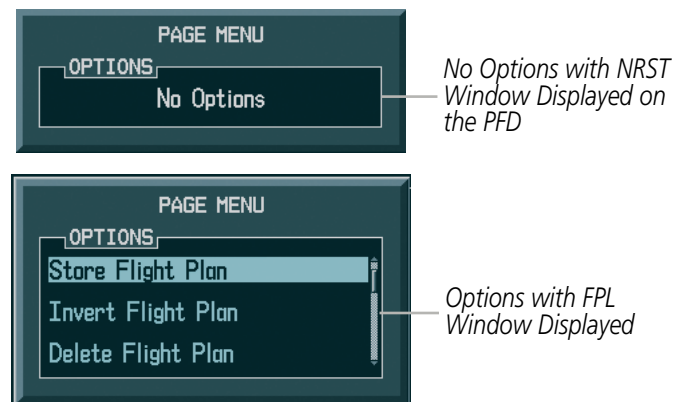

Figure 1-26 Page Menu Examples

**MFD PAGE GROUPS**



**NOTE:** Refer to other supporting sections in this Pilot’s Guide for details on specific pages.

Information on the MFD is presented on pages which are grouped according to function. The page group and active page title are displayed in the upper center of the screen, below the Navigation Status Box. In the bottom right corner of the screen, a page group window is displayed by turning either **FMS** Knob. The page group tabs are displayed along the bottom of the window. The page titles are displayed in a list above the page group tabs. The current page group and current page within the group are shown in light blue. For some of these pages (Airport/Procedures/Weather Information, XM, Procedure Loading), the active title of the page changes while the page name in the list remains the same.

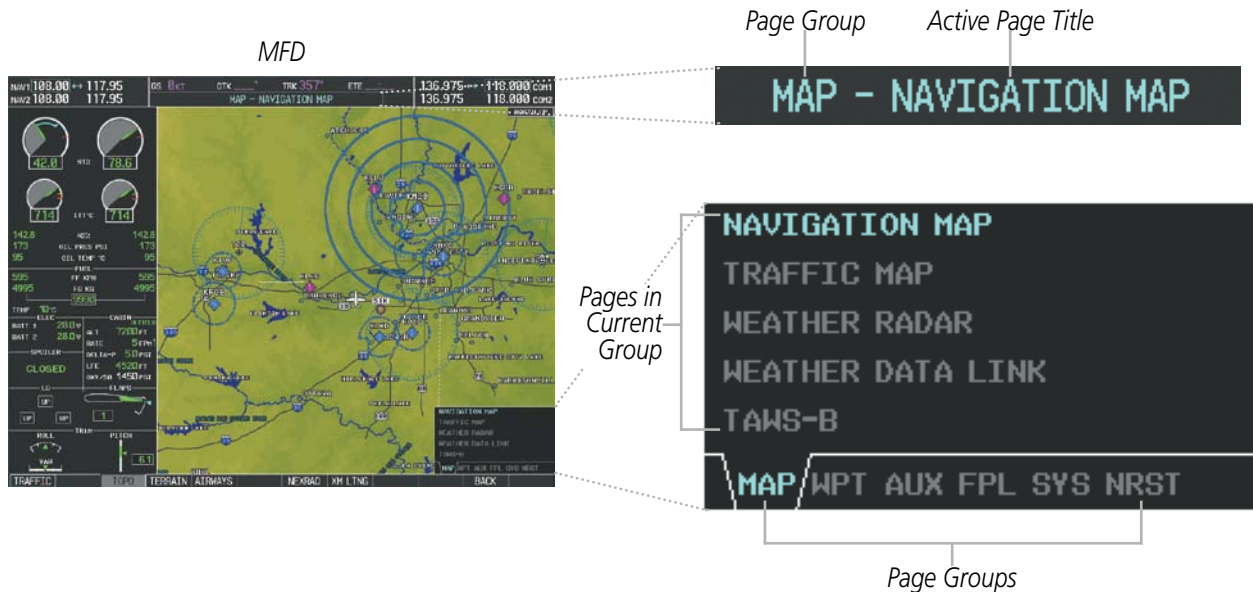

**Figure 1-27 Page Title and Page Groups**

The main page groups are navigated using the **FMS** Knob; specific pages within each group can vary depending on the configuration of optional equipment.

**Selecting a page using the FMS Knob:**

- 1) Turn the large **FMS** Knob to display the list of page groups; continue turning the large **FMS** Knob until the desired page group is selected
- 2) Turn the small **FMS** Knob to display the desired page within a specific page group.

There are also several pages (Airport/Procedures/Weather Information and XM pages) which are selected first from within a main page group with the **FMS** Knob, then with the appropriate softkey at the bottom of the page (or from the page menu). In this case, the page remains set to the selected page until a different page softkey is selected, even if a different page group is selected.

**Map Pages (MAP)**

- Navigation Map
- Traffic Map
- Weather Radar  
(optional)
- XM Weather Data Link  
(service optional)
- TAWS-B/TAWS-A  
(TAWS-A optional)

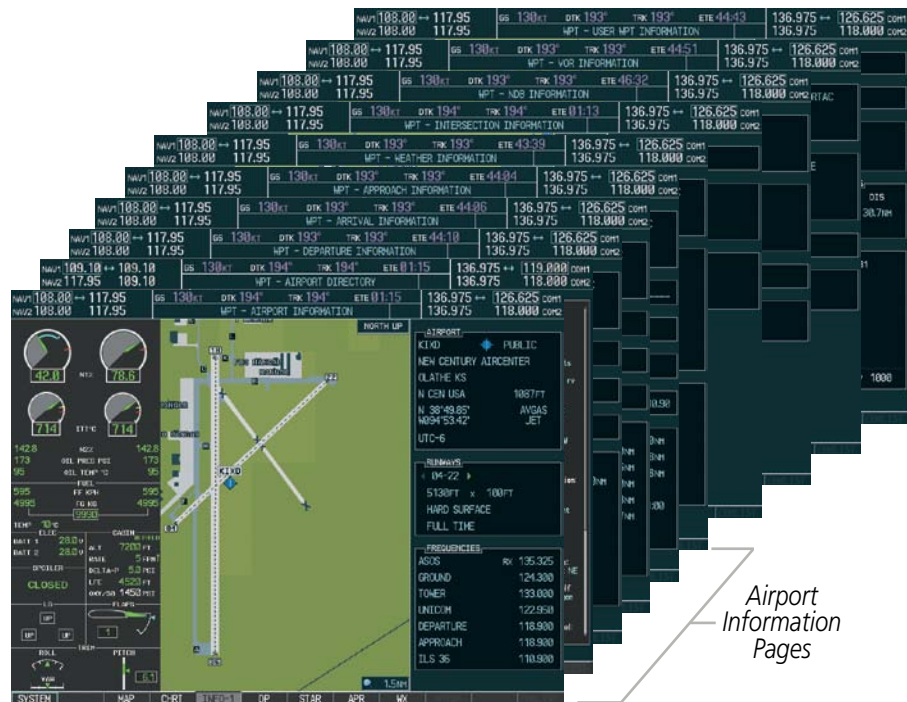

Figure 1-28 Map Pages

**Waypoint Pages (WPT)**

Airport Information pages

- Airport Information  
(**INFO-1** Softkey)
- Airport Directory  
(**INFO-2** Softkey)
- Departure Information  
(**DP** Softkey)
- Arrival Information  
(**STAR** Softkey)
- Approach Information  
(**APR** Softkey)
- Weather Information  
(**WX** Softkey)
- Intersection Information
- NDB Information
- VOR Information
- User Waypoint Information



Airport Information Pages

Figure 1-29 Waypoint Pages



**Auxiliary Pages (AUX)**

Weight Planning

Trip Planning

Utility

GPS Status

System Setup

XM Satellite pages

- XM Information  
(**INFO** Softkey)

- XM Radio  
(**RADIO** Softkey)

Satellite Phone

- Telephone  
(**TEL** Softkey)

- SMS  
(**SMS** Softkey)

Reports/Data Link

- Report Status  
(**REPORT** Softkey)

- WI-FI Setup  
(**WI-FI** Softkey)

System Status

The Flight Plan Pages may also be accessed using the **FPL** Key on the MFD.

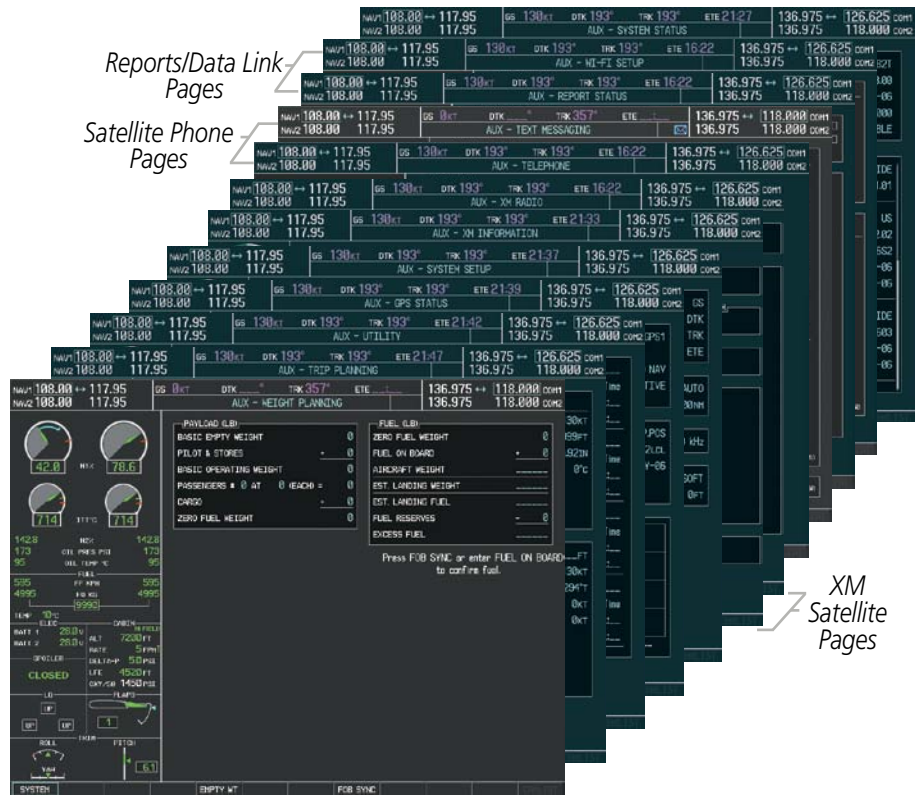

**Figure 1-30 Auxiliary Pages**

**Flight Plan Pages (FPL)**

Active Flight Plan

- Wide View, Narrow View (**VIEW** Softkey)

Flight Plan Catalog

or

Stored Flight Plan (**NEW** Softkey)



Figure 1-31 Flight Plan Pages

**System Pages (SYS)**

System Status

Environmental Control System

Electrical System

Fuel System

Ice Protection System

Engine Maintenance

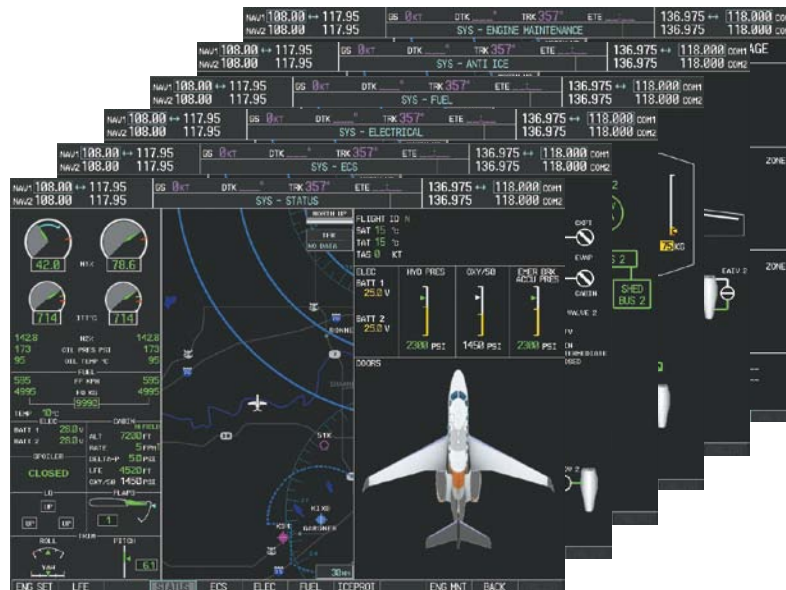

Figure 1-32 System Pages

The Checklist Page may be accessed from the page group tab or the **CHKLIST** Softkey. See the Additional Features section for a discussion on using the Checklist Page.

**Nearest Pages (NRST)**

- Nearest Airports
- Nearest Intersections
- Nearest NDB
- Nearest VOR
- Nearest User Waypoints
- Nearest Frequencies
- Nearest Airspaces



**Figure 1-33 Nearest Pages**

In addition to the page groups previously addressed, there are pages for loading procedures which are accessed by pressing the **PROC** Key on the MFD bezel. In some instances, softkeys may be used to access the Procedure Pages.

A menu is initialized, and when a departure, approach, or arrival is selected, the appropriate Procedure Loading Page is opened. Turning the **FMS** Knob does not scroll through the Procedure pages.

**Procedure Pages (PROC)**

- Departure Loading
- Arrival Loading
- Approach Loading

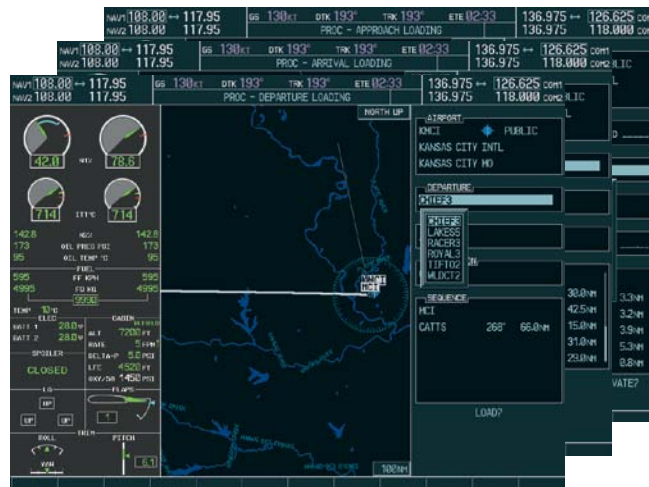

**Figure 1-34 Procedure Pages**

For some of these pages (Airport Information pages, XM Satellite pages, Procedure pages), the title of the page may change.



## MFD SYSTEM PAGES

In the Auxiliary (AUX) Page Group, there are two system pages: System Setup and System Status. The System Setup Page allows management of various system parameters, while the System Status Page displays the status of all system LRUs.

### SYSTEM SETUP PAGE

The System Setup Page allows management of the following system parameters:

- Pilot Profiles
- Date/time
- Display Units (see Flight Instruments Section)
- Baro Transition Alert (see Flight Instruments Section)
- Airspace Alerts (see Flight Management Section)
- Arrival Alerts (see Flight Management Section)
- Audio Alerts
- Flight Director
- Page Navigation
- MFD Data Bar Fields (Navigation Status Box) (see Flight Management Section)
- GPS CDI scaling for GPS navigation source (see Flight Instruments Section)
- COM Configuration (see Audio Panel and CNS Section)
- Nearest Airports display criteria (see Flight Management Section)
- Synchronization of Baro and CDI between PFDs

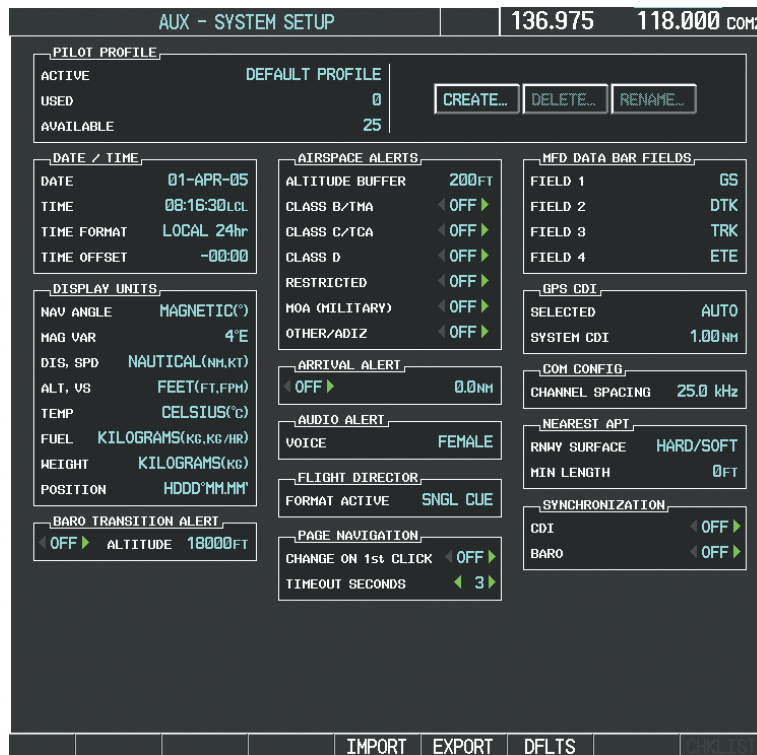
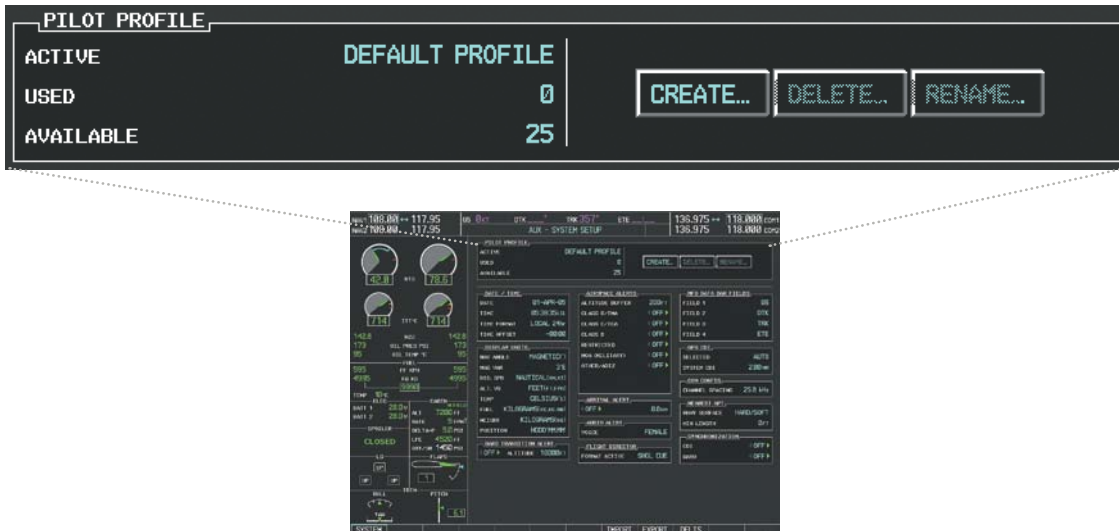

Figure 1-35 System Setup Page

**PILOT PROFILES**

Various system settings may be saved under a pilot profile. When the system is powered on, the last selected pilot profile is shown on the MFD power-up screen (Figure 1-19). The system can store up to 25 profiles; the currently active profile, the amount of memory used, and the amount of memory available are shown at the top of the System Setup Page in the box labeled ‘PILOT PROFILE’. From here, pilot profiles may be created, selected, renamed, or deleted. Pilot profiles may also be imported from an SD card, or exported to an SD card.



**Figure 1-36 Pilot Profiles (System Setup Page)**

System settings on the AUX-System Setup Page that are pilot adjustable are saved to the pilot profile, as well as, but not limited to, the following:

- Altimeter units setting
- Map settings
- SBAS settings
- Chart settings
- HSI and wind display settings
- SVS options

**Creating a profile:**

- 1) Use the **FMS** Knob to select the AUX - System Setup Page.
- 2) Press the **FMS** Knob momentarily to activate the flashing cursor.
- 3) Turn the large **FMS** Knob to highlight ‘CREATE’ in the Pilot Profile Box.
- 4) Press the **ENT** Key. A ‘Create Profile’ window is displayed.
- 5) Use the **FMS** Knob to enter a profile name up to 16 characters long and press the **ENT** Key. Pilot profile names cannot begin with a blank as the first letter.
- 6) In the next field, use the small **FMS** Knob to select the desired settings upon which to base the new profile. Profiles can be created based on Garmin factory defaults, default profile settings (initially based on Garmin factory defaults unless edited by the pilot), or current system settings.

- 7) Press the **ENT** Key.
- 8) With 'CREATE' highlighted, press the **ENT** Key to create the profile  
**Or:**  
Use the large **FMS** Knob to select 'CREATE and ACTIVATE' and press the **ENT** Key to activate the new profile.
- 9) To cancel the process, select 'CANCEL' with the large **FMS** Knob and press the **ENT** Key.
- 10) Press the **FMS** Knob to deactivate the cursor.

#### Selecting an active profile:

- 1) Use the **FMS** Knob to select the AUX - System Setup Page.
- 2) Press the **FMS** Knob momentarily to activate the flashing cursor.
- 3) Turn the large **FMS** Knob to highlight the active profile field in the Pilot Profile Box.
- 4) Turn the small **FMS** Knob to display the pilot profile list and highlight the desired profile.
- 5) Press the **ENT** Key. The system loads and displays the system settings for the selected profile.
- 6) Press the **FMS** Knob to deactivate the cursor.

#### Renaming a profile:

- 1) Use the **FMS** Knob to select the AUX - System Setup Page.
- 2) Press the **FMS** Knob momentarily to activate the flashing cursor.
- 3) Turn the large **FMS** Knob to highlight 'RENAME' in the Pilot Profile Box.
- 4) Press the **ENT** Key.
- 5) In the 'Rename Profile' window, turn the **FMS** Knob to select the profile to rename.
- 6) Press the **ENT** Key.
- 7) Use the **FMS** Knob to enter a new profile name up to 16 characters long and press the **ENT** Key.
- 8) With 'RENAME' highlighted, press the **ENT** Key.
- 9) To cancel the process, use the large **FMS** Knob to select 'CANCEL' and press the **ENT** Key.
- 10) Press the **FMS** Knob to deactivate the cursor.

#### Deleting a profile:



---

**NOTE:** The profile that is currently active cannot be deleted. If this is the desired profile to delete, select another profile, then delete the desired profile.

---

- 1) Use the **FMS** Knob to select the AUX - System Setup Page.
- 2) Press the **FMS** Knob momentarily to activate the flashing cursor.
- 3) Turn the large **FMS** Knob to highlight 'DELETE' in the Pilot Profile Box.
- 4) Press the **ENT** Key.
- 5) In the 'Delete Profile' window, turn the **FMS** Knob to select the profile to delete.

- 6) Press the **ENT** Key.
- 7) With 'DELETE' highlighted, press the **ENT** Key.
- 8) To cancel the process, use the large **FMS** Knob to select 'CANCEL' and press the **ENT** Key.
- 9) Press the **FMS** Knob to deactivate the cursor.

**Importing a profile from an SD card:**

- 1) Insert an SD card containing the pilot profile(s) into the top card slot on the MFD.
- 2) Turn the **FMS** Knob to select the AUX - System Setup Page.
- 3) Select the **IMPORT** Softkey.

Or:

- a) Press the **MENU** Key.
- b) Turn the **FMS** Knob to highlight 'Import Pilot Profile' and press the **ENT** Key.
- 4) The system displays the Pilot Profile Importing Window with 'IMPORT' highlighted. To change the selected profile to be imported from the SD card (shown as 'SELECT FILE'), turn the large FMS Knob to highlight the profile file name, then turn the small **FMS** Knob to highlight a profile from the list, and press the **ENT** Key.
- 5) If desired, the profile name to be used after profile has been imported can be changed by turning the **FMS** Knob to highlight the 'PROFILE NAME' field, then use the large and small **FMS** Knobs to enter the name, and press the **ENT** Key. Imported profile names cannot begin with a blank space or be named 'DEFAULT', 'GARMIN DEFAULTS' or 'DEFAULT SETTINGS'.
- 6) With 'IMPORT' highlighted, press the **ENT** Key.
- 7) If the imported profile name is the same as an existing profile on the system, the system displays an 'Overwrite existing file? OK or CANCEL' prompt. Press the **ENT** Key to replace profile on the system with the profile imported from the SD card, or turn the **FMS** Knob to highlight 'CANCEL' and press the **ENT** Key to return to the Pilot Profile Importing Window.
- 8) If successful, the system displays 'Pilot profile import succeeded.' in the IMPORT RESULTS window below. With 'OK' highlighted, press the **ENT** or **CLR** Keys or press the **FMS** Knob to return to the AUX - System Setup Page. The imported profile becomes the active profile.

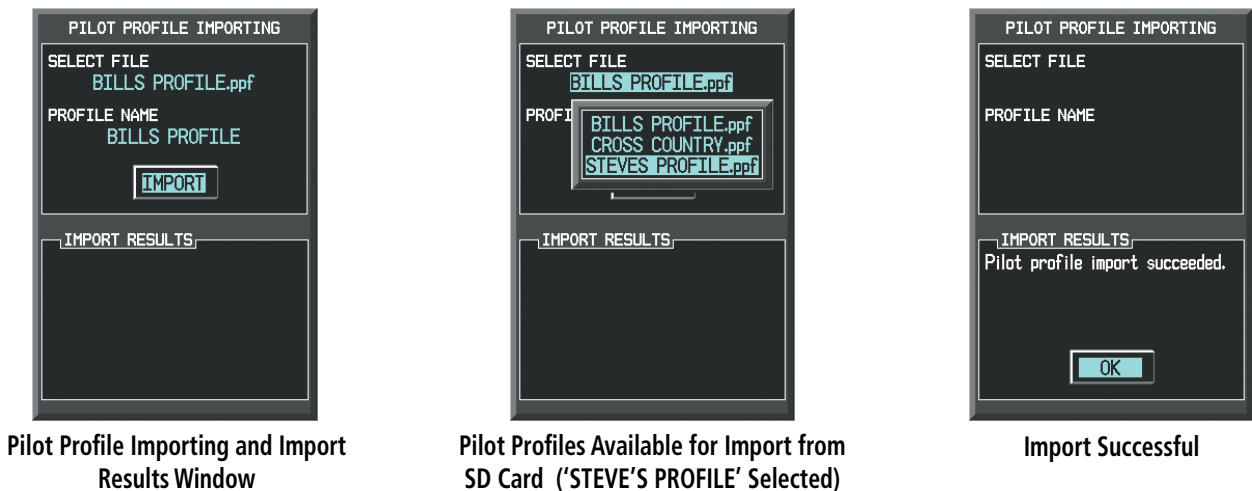

Figure 1-37 Pilot Profile Importing Window (AUX - System Setup Page)

**Exporting a profile to an SD card:**

- 1) Insert the SD card for storing the Pilot Profile into the top card slot on the MFD.
- 2) Turn the **FMS** Knob to select the AUX - System Setup Page.
- 3) If necessary, activate the desired pilot profile to export. Only the currently active Pilot Profile can be exported.
- 4) Select the **EXPORT** Softkey. The system displays the Pilot Profile Exporting Window.

**Or:**

- a) Press the **MENU** Key.
  - b) Turn the **FMS** Knob to highlight 'Export Pilot Profile' and press the **ENT** Key.
- 5) To export the pilot profile using the current supplied name, press the **ENT** Key with 'EXPORT' highlighted. To change the profile file name turn the large **FMS** Knob to highlight the 'SELECT FILE' field, then enter the new name with the large and small FMS Knobs, then press the **ENT** Key. Then press the **ENT** Key with 'EXPORT' highlighted.
  - 6) If the profile name to be exported is the same as an existing profile file name on the SD card, the system displays an 'Overwrite existing file? OK or CANCEL' prompt. Press the **ENT** Key to replace the profile on the SD card with the profile to be exported, or turn the FMS Knob to highlight 'CANCEL' and press the **ENT** Key to return to the Pilot Profile Exporting Window without exporting the profile.
  - 7) If successful, the EXPORT RESULTS window displays 'Pilot profile export succeeded.' With 'OK' highlighted, press the **ENT** or **CLR** Keys, or press the **FMS** Knob to return to the AUX - System Setup Page.

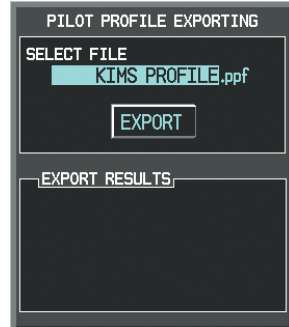

Pilot Profile Exporting Window, Enter a Name to Use for Exported Profile



Export Successful

Figure 1-38 Pilot Profile Exporting Window (AUX - System Setup Page)

**DATE/TIME**

The Date/Time Box on the System Setup Page displays the current date and time and allows the pilot to set the time format (local 12-hr, local 24-hr, or UTC) and offset. The time offset is used to define current local time. UTC (also called GMT or Zulu) date and time are calculated directly from the GPS satellites signals and cannot be changed. When using a local time format, designate the offset by adding or subtracting the desired number of hours.

**Setting the system time format:**

- 1) While on the System Setup Page, press the **FMS** Knob momentarily to activate the flashing cursor.
- 2) Turn the large **FMS** Knob to highlight the time format field in the Date/Time Box.
- 3) Turn the small **FMS** Knob to select the desired system time format (local 12hr, local 24hr, UTC) and press the **ENT** Key.

**Setting the current time offset:**

- 1) While on the System Setup Page, press the **FMS** Knob momentarily to activate the flashing cursor.
- 2) Turn the large **FMS** Knob to highlight the time offset field in the Date/Time Box.
- 3) Enter the time offset and press the **ENT** Key.

**DISPLAY UNITS**

The Display Units Box on the System Setup Page shows the configured units of measure used for each category. Only the NAV ANGLE, ALT, VS, and POSITION are pilot selectable. The following indicates the system parameters affected by changes within that category.

- Nav angle (magnetic, true)
  - When set to 'MAGNETIC', magnetic variation is figured into the displayed value. When 'TRUE' is selected, no magnetic variation is calculated and a 'T' is displayed next to the value.
  - Affects the BRG field in the PFD Navigation Status Box.
  - Affects Current Heading, Selected Heading, and Selected Course boxes on the PFD.
  - Affects the BRG, DTK, TKE, TRK, and XTK fields in the MFD Navigation Status Box.
- Altitude and vertical speed (feet, meters)
  - Affects all altitude and elevation displays on the MFD, with the exception of VNV altitudes on the Active Flight Plan Page.
- Position (HDDD°MM.MM', HDDD°MM'SS.S'")
  - Affects all position displays.

**To change a Display Units setting:**

- 1) While on the System Setup Page, press the **FMS** Knob momentarily to activate the flashing cursor.
- 2) Turn the large **FMS** Knob to highlight the desired field in the Display Units Box.
- 3) Turn the small **FMS** Knob to select from a list of measurement units and press the **ENT** Key when the desired unit is highlighted. Press the **CLR** Key to cancel the action without changing the units.

**BARO TRANSITION ALERT**

See the Flight Instruments section for a discussion on setting the Baro Transition Alert.

## AIRSPACE ALERTS

The Airspace Alerts Box allows the pilot to turn the controlled/special-use airspace message alerts on or off. This does not affect the alerts listed on the Nearest Airspaces Page or the airspace boundaries depicted on the MFD Navigation Map Page. It simply turns on/off the warning provided when the aircraft is approaching or near an airspace.

Alerts for the following airspaces can be turned on/off in the Airspace Alerts Box:

- Class B/TMA
- Class C/TCA
- Class D
- Restricted
- MOA (Military)
- Other/ADIZ

An altitude buffer is also provided which “expands” the vertical range above or below an airspace. For example, if the buffer is set at 500 feet, and the aircraft is more than 500 feet above/below an airspace, an alert message will not be generated, but if the aircraft is less than 500 feet above/below an airspace and projected to enter it, the pilot is notified with an alert message. The default setting for the altitude buffer is 200 feet.

### Changing the altitude buffer distance setting:

- 1) While on the System Setup Page, press the **FMS** Knob momentarily to activate the flashing cursor.
- 2) Turn the large **FMS** Knob to highlight the altitude buffer field in the Airspace Alerts Box.
- 3) Turn the **FMS** Knobs to enter an altitude buffer value and press the **ENT** Key.
- 4) Press the **FMS** Knob to deactivate the cursor.

### Turn an airspace alert on or off

- 1) While on the System Setup Page, press the **FMS** Knob momentarily to activate the flashing cursor.
- 2) Turn the large **FMS** Knob to highlight the desired field in the Airspace Alerts Box.
- 3) Turn the small **FMS** Knob clockwise to turn the airspace alert ON or counterclockwise to turn the alert OFF.
- 4) Press the **FMS** Knob to deactivate the cursor.

## ARRIVAL ALERTS

The Arrival Alert Box on the System Setup Page allows arrival alerts to be turned on/off and the alert trigger distance set. An arrival alert can be set to notify the pilot with a message upon reaching a user-specified distance from the final destination (the direct-to waypoint or the last waypoint in a flight plan). Once the set distance (up to 99.9 units) has been reached, an “Arriving at waypoint” message is displayed in the PFD Navigation Status Box.

### Enabling/disabling an arrival alert:

- 1) Use the **FMS** Knob to select the AUX - System Setup Page.
- 2) Press the **FMS** Knob momentarily to activate the flashing cursor.
- 3) Turn the large **FMS** Knob to select the ON/OFF field in the Arrival Alert Box.
- 4) Turn the small **FMS** Knob clockwise to turn the airspace alert ON or counterclockwise to turn the alert OFF.
- 5) Press the **FMS** Knob to deactivate the cursor.



**Changing the arrival alert trigger distance:**

- 1) Use the **FMS** Knob to select the AUX - System Setup Page.
- 2) Press the **FMS** Knob momentarily to activate the flashing cursor.
- 3) Turn the large **FMS** Knob to highlight the distance field in the Arrival Alert Box.
- 4) Use the **FMS** Knob to enter a trigger distance and press the **ENT** Key.
- 5) Press the **FMS** Knob to deactivate the cursor.

**FLIGHT DIRECTOR**

Two formats are available for the display of the flight director. Single Cue or X-Pointer may be selected.

**To change the flight director format:**

- 1) While on the System Setup Page, press the **FMS** Knob momentarily to activate the flashing cursor.
- 2) Turn the large **FMS** Knob to highlight the Format Active field in the Flight Director Box.
- 3) Turn the small **FMS** Knob to display and highlight the desired flight director format and press the **ENT** Key.
- 4) Press the **FMS** Knob to deactivate the cursor.

**PAGE NAVIGATION**

The large **FMS** Knob displays the Page Group Tabs and navigates through the tabs. The small **FMS** Knob navigates through the pages listed within a specific group. The number of clicks it takes to display the Page Group Tabs and change to the next tab can be controlled from the Page Navigation box on the AUX - System Setup Page.

OFF – Displays the Page Group Tabs with one click of either **FMS** Knob.

ON – Displays the Page Group Tabs and navigates to the next tab with one click of either **FMS** Knob.

The pilot can select, from the AUX - System Setup Page, the amount of time the Page Group Tabs are displayed (in the lower right corner of the MFD). The timeout can range from two to ten seconds.

**Selecting page navigation settings:**

- 1) Use the **FMS** Knob to select the AUX - System Setup Page.
- 2) Press the **FMS** Knob momentarily to activate the flashing cursor.
- 3) Turn the large **FMS** Knob to highlight the 'Change On 1st Click' field in the Page Navigation Box.
- 4) Turn the small **FMS** Knob to select 'OFF' or 'ON'.
- 5) Turn the large **FMS** Knob to highlight the 'Timeout Seconds' field in the Page Navigation Box.
- 6) Turn the small **FMS** Knob to select the desired number of seconds
- 7) Press the **FMS** Knob momentarily to remove the flashing cursor.

**MFD DATA BAR FIELDS**

The MFD Data Bar Fields Box on the System Setup Page displays the current configuration of the MFD Navigation Status Box. By default, the Navigation Status Bar is set to display ground speed (GS), distance to next waypoint (DIS), estimated time enroute (ETE), and enroute safe altitude (ESA).



### Changing the information shown in an MFD Navigation Status Bar field:

- 1) While on the System Setup Page, press the **FMS** Knob momentarily to activate the flashing cursor.
- 2) Turn the large **FMS** Knob to highlight the desired field number in the MFD Data Bar Fields Box.
- 3) Turn the small **FMS** Knob to display and scroll through the data options list and press the **ENT** Key when the desired data selection is highlighted.
- 4) Press the **FMS** Knob to deactivate the cursor.

The following data may be selected for display in each of the four fields of the Navigation Status Box.

- Bearing (BRG)
- Distance (DIS)
- Desired Track (DTK)
- En Route Safe Altitude (ESA)
- Endurance (END)
- Estimated Time of Arrival (ETA)
- Estimated Time En Route (ETE)
- Fuel On Board (FOB)
- Fuel Over Destination (FOD)
- Ground Speed (GS)
- Minimum Safe Altitude (MSA)
- True Air Speed (TAS)
- Track Angle Error (TKE)
- Track (TRK)
- Vertical Speed Required (VSR)
- Crosstrack Error (XTK)

### GPS CDI

The GPS CDI Box on the System Setup Page allows the pilot to define the range for the on-screen course deviation indicator (CDI). The range values represent full range deflection for the CDI to either side. The default setting is 'AUTO'. At this setting, leaving the departure airport the CDI range is set to 1.0 nm and gradually ramps up to 2 nm beyond 30 nm from the departure airport. The CDI range is set to 2.0 nautical miles during the en route phase of flight. Within 30 nm of the destination airport, the CDI range gradually ramps down to 1.0 nm (terminal area). During approach operations, the CDI range ramps down even further to 0.3 nm. This transition normally occurs within 2.0 nm of the final approach fix (FAF).

If a lower CDI range setting is selected (i.e., 1.0 or 0.3 nm), the higher range settings are not selected during any phase of flight. For example, if 1.0 nm is selected, the system uses this for en route and terminal phases and ramps down to 0.3 nm during an approach. Note that the Receiver Autonomous Integrity Monitoring (RAIM) protection limits follow the selected CDI range and corresponding flight phases.

The GPS CDI Box on the System Setup Page displays the following:

- Selected CDI range (auto, 2 nm, 1 nm, 0.3 nm)
- Current system CDI range (2 nm, 1 nm, 0.3 nm)

### Changing the CDI range:

- 1) While on the System Setup Page, press the **FMS** Knob momentarily to activate the flashing cursor.
- 2) Turn the large **FMS** Knob to highlight the selected field in the GPS CDI Box.
- 3) Turn the small **FMS** Knob to display and scroll through the range list and press the **ENT** Key when the desired selection is highlighted.
- 4) Press the **FMS** Knob to deactivate the cursor.

## COM CONFIGURATION



**NOTE:** 8.33 kHz VHF communication frequency channel spacing is not required for use in the United States. Select the 25.0 kHz channel spacing option for use in the United States.

The COM Configuration Box on the System Setup Page allows the pilot to select 8.33 kHz or 25.0 kHz COM frequency channel spacing.

### Changing COM channel spacing:

- 1) While on the System Setup Page, press the **FMS** Knob momentarily to activate the flashing cursor.
- 2) Turn the large **FMS** Knob to highlight the channel spacing field in the COM Configuration Box.
- 3) Turn the small **FMS** Knob to select the desired spacing and press the **ENT** Key.
- 4) Press the **FMS** Knob to deactivate the cursor.

## NEAREST AIRPORTS

The Nearest Airports Box on the System Setup Page defines the minimum runway length and surface type used when determining the nine nearest airports to display on the MFD Nearest Airports Page. A minimum runway length and/or surface type can be entered to prevent airports with small runways or runways that are not of appropriate surface from being displayed. Default settings are zero feet (or meters) for runway length and “HARD/SOFT” for runway surface type.

### Selecting the nearest airport surface matching criteria (any, hard only, hard/soft):

- 1) While on the System Setup Page, press the **FMS** Knob momentarily to activate the flashing cursor.
- 2) Turn the large **FMS** Knob to highlight the runway surface field in the Nearest Airports Box.
- 3) Turn the small **FMS** Knob to display and scroll through the runway options (any, hard only, hard/soft) and press the **ENT** Key when the desired selection is highlighted.
- 4) Press the **FMS** Knob to deactivate the cursor.

### Selecting the nearest airport minimum runway length matching criteria:

- 1) While on the System Setup Page, press the **FMS** Knob momentarily to activate the flashing cursor.
- 2) Turn the large **FMS** Knob to highlight the minimum length field in the Nearest Airport Box.
- 3) Turn the **FMS** Knobs to enter the minimum runway length (zero to 25,000 feet) and press the **ENT** Key.
- 4) Press the **FMS** Knob to deactivate the cursor.

## CDI/BARO SYNCHRONIZATION

See the Flight Instruments section for a discussion on synchronizing both PFD's Course Deviation Indicators and the altimeter barometric settings.

### SYSTEM STATUS PAGE

The System Status Page displays the status and software version numbers for all detected system LRUs. Pertinent information on all system databases is also displayed. Active LRUs are indicated by green check marks and failed LRUs are indicated by red “X”s. Failed LRUs should be noted and an Embraer service center or Garmin dealer informed.

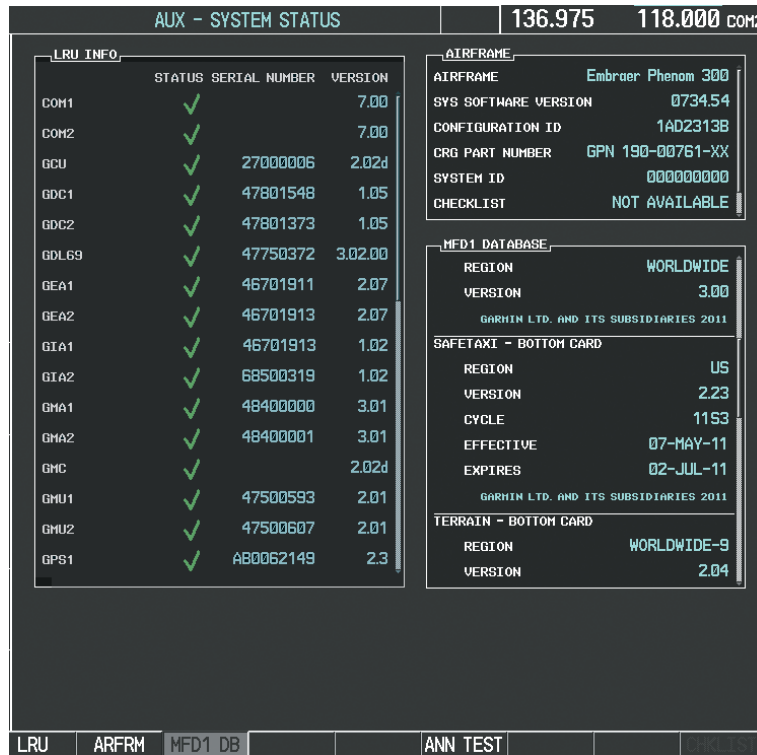

Figure 1-39 System Status Page

The **LRU** and **ARFRM**, Softkeys on the System Status Page select the applicable list (LRU INFO or AIRFRAME window) through which the **FMS** Knob can be used to scroll information within the selected window.

Selecting the **MFD1 DB** Softkey (label background changes to grey indicating the softkey is selected) places the cursor in the DATABASE window. Use the **FMS** Knob to scroll through database information for the MFD. Selecting the softkey again will change the softkey label to **PFD1 DB**. PFD 1 database information is now displayed in the DATABASE window. Selecting the softkey a third time will change the softkey label to **PFD2 DB**. PFD 2 database information is now displayed in the DATABASE window.

The **ANN TEST** Softkey, when selected, causes an annunciation test tone to be played.

Selecting the **SYNC DBS** Softkey (label background changes to grey indicating the softkey is selected) activates the Automatic Database Synchronization feature. When this feature is active, databases are updated automatically in the MFD and both PFDs from one SD card. For a detailed discussion on database synchronization, see the SD Card Use section in the Appendices.

**UTILITY PAGE**

For flight planning purposes, timers, trip statistics, and a scheduler feature are provided on the AUX - Utility Page. The timers available include a stopwatch-like generic timer, a total time in flight timer, and a record of the time of departure. Trip statistics—odometer, trip odometer, and average trip and maximum groundspeeds—are displayed from the time of the last reset. A scheduler feature is also provided so the pilot can enter reminder messages to be displayed at specified intervals in the Messages Window on the PFD (see Figure 1-40).

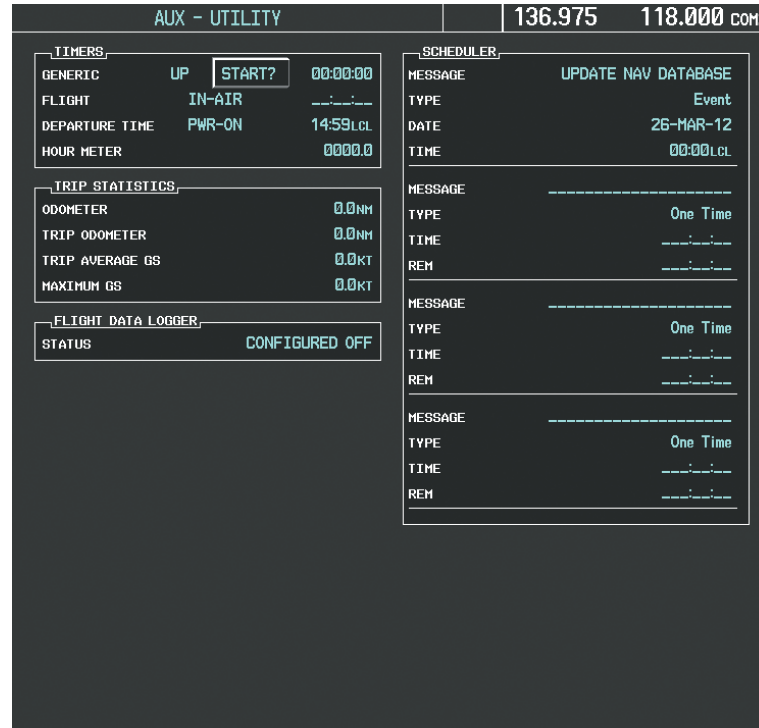

**Figure 1-40 Utility Page**

**TIMERS**

The generic timer can be set to count up or down from a specified time (HH:MM:SS). When the countdown on the timer reaches zero the digits begin to count up from zero. If the timer is reset before reaching zero on a countdown, the digits are reset to the initial value. If the timer is counting up when reset, the digits are zeroed.

**Setting the generic timer:**

- 1) Use the **FMS** Knob to select the AUX - Utility Page.
- 2) Press the **FMS** Knob momentarily to activate the flashing cursor.
- 3) Turn the small **FMS** Knob to select the timer counting direction (UP/DN) and press the **ENT** Key.
- 4) If a desired starting time is desired:
  - a) Use the large **FMS** Knob to highlight the HH:MM:SS field.
  - b) Use the **FMS** Knob to enter the desired time and press the **ENT** Key.

- 5) Turn the large **FMS** Knob to highlight 'START?' and press the **ENT** Key to start the timer. The field changes to 'STOP?'
- 6) To stop the timer, press the **ENT** Key with 'STOP?' highlighted. The field changes to 'RESET?'
- 7) To reset the timer, press the **ENT** Key with 'RESET?' highlighted. The field changes back to 'START?' and the digits are reset.

The flight timer can be set to count up from zero starting at system power-up or from the time that the aircraft lifts off; the timer can also be reset to zero at any time.

#### **Setting the flight timer starting criterion:**

- 1) Use the **FMS** Knob to select the AUX - Utility Page.
- 2) Press the **FMS** Knob momentarily to activate the flashing cursor.
- 3) Turn the large **FMS** Knob to highlight the field next to the flight timer.
- 4) Turn the small **FMS** Knob to select the starting criterion (PWR-ON or IN-AIR) and press the **ENT** Key.
- 5) Press the **FMS** Knob to deactivate the cursor.

#### **Resetting the flight timer:**

- 1) Use the **FMS** Knob to select the AUX - Utility Page.
- 2) Press the **MENU** Key.
- 3) With 'Reset Flight Timer' highlighted, press the **ENT** Key.

The system records the time at which departure occurs, depending on whether the pilot prefers the time to be recorded from system power-up or from aircraft lift off. The displayed departure time can also be reset to display the current time at the point of reset. The format in which the time is displayed is controlled from the System Setup Page.

#### **Setting the departure timer starting criterion:**

- 1) Use the **FMS** Knob to select the AUX - Utility Page.
- 2) Press the **FMS** Knob momentarily to activate the flashing cursor.
- 3) Turn the large **FMS** Knob to highlight the field next to the departure time.
- 4) Turn the small **FMS** Knob to select the starting criterion (PWR-ON or IN-AIR) and press the **ENT** Key.

#### **Resetting the departure time:**

- 1) Use the **FMS** Knob to select the AUX - Utility Page.
- 2) Press the **MENU** Key.
- 3) Use the **FMS** Knob to highlight 'Reset Departure Time' and press the **ENT** Key.

The hour meter starts counting up when either engine begins running. The hour meter stops counting when both engines have stopped running. This is a system timer and is not pilot adjustable.

## TRIP STATISTICS

The odometer and trip odometer record the total mileage traveled from the last reset; these odometers can be reset independently. Resetting the trip odometer also resets the average trip groundspeed. Maximum groundspeed for the period of time since the last reset is also displayed.

### Resetting trip statistics readouts:

- 1) Use the **FMS** Knob to select the AUX - Utility Page.
- 2) Press the **MENU** Key. The following reset options for trip statistics are displayed:
  - Reset Trip ODOM/AVG GS—Resets trip average ground speed readout and odometer
  - Reset Odometer—Resets odometer readout only
  - Reset Maximum Speed—Resets maximum speed readout only
  - Reset All—Resets flight timer, departure timer, odometers, and groundspeed readouts
- 2) Use the **FMS** Knob to highlight the desired reset option and press the **ENT** Key. The selected parameters are reset to zero and begin to display data from the point of reset.

## FLIGHT DATA LOGGER

This feature is not available on the Phenom 300.

## SCHEDULER

The scheduler feature can be used to enter and display reminder messages. Messages can be set to display based on a specific date and time (event), once the message timer reaches zero (one-time; default setting), or recurrently whenever the message timer reaches zero (periodic). Message timers set to periodic alerting automatically reset to the original timer value once the message is displayed. When power is cycled, messages are retained until deleted, and message timer countdown is restarted.

### Entering a scheduler message:

- 1) Use the **FMS** Knob to select the AUX - Utility Page.
- 2) Press the **FMS** Knob momentarily to activate the flashing cursor.
- 3) Turn the large **FMS** Knob to highlight the first empty scheduler message naming field.
- 4) Enter the message text to be displayed in the Messages Window and press the **ENT** Key.
- 5) Press the **ENT** Key again or use the large **FMS** Knob to move the cursor to the field next to 'Type'.
- 6) Turn the small **FMS** Knob to select the message alert type:
  - Event—Message issued at the specified date/time
  - One-time—Message issued when the message timer reaches zero (default setting)
  - Periodic—Message issued each time the message timer reaches zero
- 7) Press the **ENT** Key again or use the large **FMS** Knob to move the cursor to the next field.
- 8) For periodic and one-time message, enter the timer value (HHH:MM:SS) from which to countdown and press the **ENT** Key.

- 9) For event-based messages:
  - a) Enter the desired date (DD-MMM-YYY) and press the **ENT** Key.
  - b) Press the **ENT** Key again or use the large **FMS** Knob to move the cursor to the next field.
  - c) Enter the desired time (HH:MM) and press the **ENT** Key.
- 10) Press the **ENT** Key again or use the large **FMS** Knob to move the cursor to enter the next message.

#### Deleting a scheduler message:

- 1) Use the **FMS** Knob to select the AUX - Utility Page.
- 2) Press the **FMS** Knob momentarily to activate the flashing cursor.
- 3) Turn the large **FMS** Knob to highlight the name field of the scheduler message to be deleted.
- 4) Press the **CLR** Key to clear the message text. If the **CLR** Key is pressed again, the message is restored.
- 5) Press the **ENT** Key to confirm message deletion.

Scheduler messages appear in the Messages Window on the PFD. Pressing the **MSG** Softkey opens the Messages Window and acknowledges the scheduler message. When **MSG** Softkey is pressed again, the Messages Window is removed from the display and the scheduler message is deleted from the message queue.



Figure 1-41 PFD Message Window



## 1.8 DISPLAY BACKLIGHTING

The system display and control backlighting can be adjusted either automatically or manually. Backlighting intensity ranges from 0.14% to 100% on the PFDs and 0.80% to 100.00% on the MFD.

### AUTOMATIC ADJUSTMENT

The existing instrument panel dimmer bus normally controls the PFD and MFD backlighting as well as the PFD and MFD bezels, MFD Control Unit, AFCS Control Unit and audio panel key annunciator lighting. When the dimmer bus is not used by the system, photocell technology automatically controls backlighting adjustments. Photocell calibration curves are pre-configured to optimize display appearance through a broad range of cockpit lighting conditions.

### MANUAL ADJUSTMENT



**NOTE:** The avionics dimming knob may also be used to adjust backlighting. Refer to the AFM for details.



**NOTE:** In normal mode, backlighting can only be adjusted from PFD1 or PFD2. In reversionary mode, it can also be adjusted from the MFD.



**NOTE:** No other window can be displayed on the PFD while the PFD Setup Menu Window is displayed.

Backlighting may also be adjusted manually for all of the displays and the associated bezels. The audio panel key backlighting is directly tied to the on-side PFD key backlighting setting.

#### Adjust display backlighting manually:

- 1) Press the **MENU** Key on the PFD to display the PFD Setup Menu Window. 'AUTO' becomes highlighted to the right of 'PFD1 DSPL'.

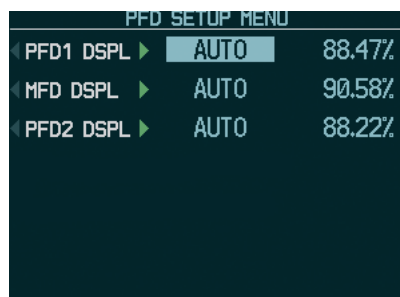

Figure 1-42 Manual Display Backlighting Adjustment

- 2) Turn the small **FMS** Knob to display the selection box. Turn the **FMS** Knob to select 'MANUAL', then press the **ENT** Key. The intensity value becomes highlighted.
- 3) Turn the small **FMS** Knob to select the desired backlighting, then press the **ENT** Key.
- 4) Turn the large **FMS** Knob to highlight 'AUTO' to the right of 'MFD DSPL' or 'PFD2 DSPL', respectively, and repeat steps 2 and 3.



- 5) Press the **CLR** or **MENU** Key to remove the PFD Setup Menu Window from the display.

#### Adjust key backlighting manually:

- 1) Press the **MENU** Key on the PFD to display the PFD Setup Menu Window. 'AUTO' becomes highlighted to the right of 'PFD1 DSPL'.

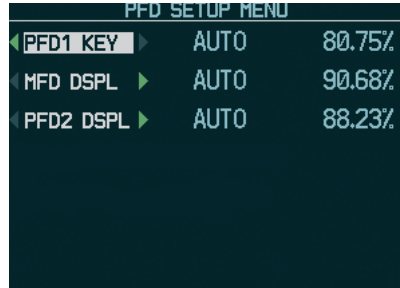

Figure 1-43 Manual Key Lighting Adjustment

- 2) Turn the large **FMS** Knob to highlight 'PFD1 DSPL'. Turn the small **FMS** Knob in the direction of the green arrowhead to display 'PFD1 KEY'.
- 3) Turn the large **FMS** Knob to highlight 'AUTO' and turn the small **FMS** Knob to display the selection box.
- 4) Turn the **FMS** Knob to select 'MANUAL', then press the **ENT** Key. The intensity value becomes highlighted.
- 5) Turn the small **FMS** Knob to select the desired backlighting, then press the **ENT** Key.
- 6) Turn the large **FMS** Knob to highlight 'MFD DSPL' or 'PFD2 DSPL' and turn the small **FMS** Knob in the direction of the green arrowhead to display 'MFD KEY' or 'PFD2 KEY', respectively.
- 7) Repeat steps 3 to 5.
- 8) Press the **CLR** or **MENU** Key to remove the PFD Setup Menu Window from the display.

## SECTION 2 FLIGHT INSTRUMENTS



**WARNING:** If the airspeed, attitude, altitude, or heading indications become unusable, refer to the backup instruments.



**NOTE:** The Automatic Flight Control System (AFCS) provides additional readouts and indicators (bug) on selected flight instruments. Refer to the AFCS Section for details on these indicators (bug) and readouts, as they appear on the display during certain AFCS flight director modes.

Increased situational awareness is provided by replacing the traditional instruments on the panel with two easy-to-scan Primary Flight Displays (PFDs) that feature large horizons, airspeed, attitude, altitude, vertical speed, and course deviation information. In addition to the flight instruments, navigation, communication, terrain, traffic, and weather information are also presented on the PFDs and explained in other sections of this Pilot's Guide.

The following flight instruments and supplemental flight data are displayed on each PFD:

- Airspeed Indicator, showing
  - Indicated airspeed
  - True airspeed
  - Airspeed awareness ranges
  - Vspeed reference flags
  - Groundspeed
  - Mach number
  - Airspeed reference and bug
- Attitude Indicator with slip/skid indication
- Altimeter, showing
  - Trend vector
  - Barometric setting
  - Selected Altitude
- Vertical Deviation, Glideslope, and Glidepath Indicators
- Vertical Speed Indicator (VSI)
- Vertical Navigation (VNV) indications
- Total Air Temperature (TAT)
- Static Air Temperature (SAT)
- Horizontal Situation Indicator, showing
  - Turn Rate Indicator
  - Bearing pointers and information windows
  - Navigation source
  - Course Deviation Indicator (CDI)
  - Bearing pointers and information windows
  - DME Information Windows
- Transponder Mode, Code, and Ident/Reply
- Course Deviation Indicator (CDI)
- Timer/References Window, showing
  - Generic timer
  - Vspeed values
  - Barometric minimum descent altitude (MDA)
- Wind data
- Radar Altimeter (RA)

The PFDs also display various alerts and annunciations.

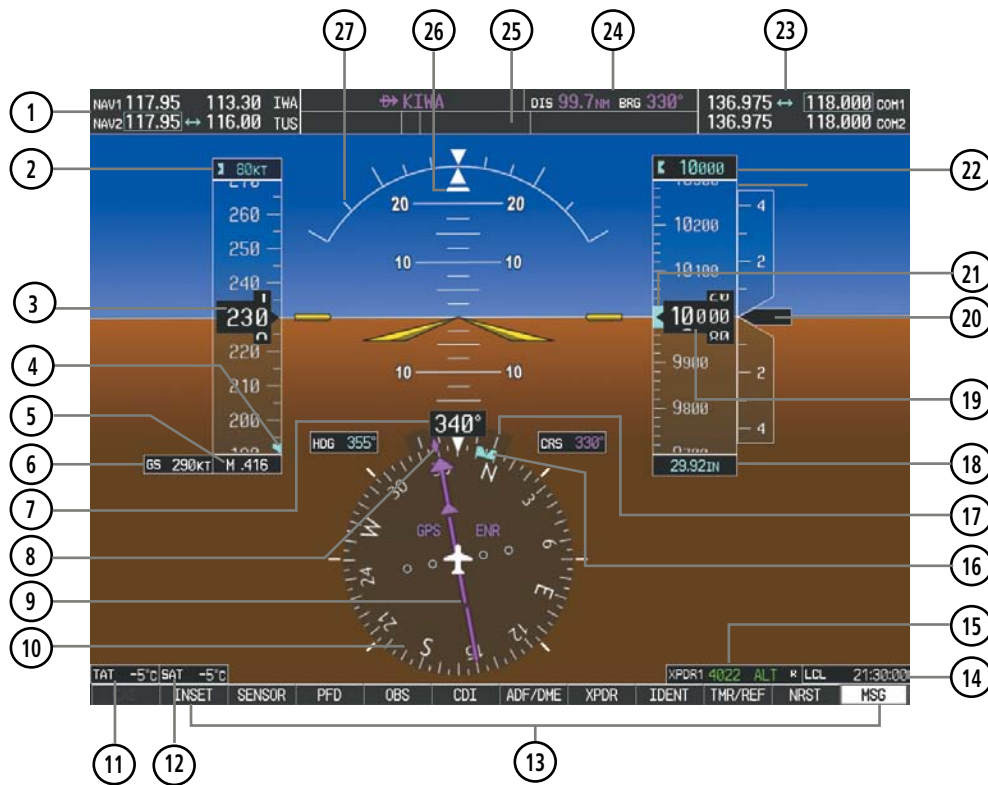

- |  |                                  |
|--|----------------------------------|
| ① NAV Frequency Box                    | ⑮ Transponder Status Box         |
| ② Airspeed Reference                   | ⑯ Heading Bug                    |
| ③ Airspeed Indicator                   | ⑰ Turn Rate Indicator            |
| ④ Airspeed Reference Bug               | ⑱ Barometric Altimeter Setting   |
| ⑤ Mach Number                          | ⑲ Altimeter                      |
| ⑥ Ground Speed                         | ⑳ Vertical Speed Indicator (VSI) |
| ⑦ Current Heading                      | ㉑ Selected Altitude Bug          |
| ⑧ Current Track Indicator              | ㉒ Selected Altitude              |
| ⑨ Course Deviation Indicator (CDI)     | ㉓ COM Frequency Box              |
| ⑩ Horizontal Situation Indicator (HSI) | ㉔ Navigation Status Box          |
| ⑪ Total Air Temperature (TAT)          | ㉕ AFCS Status Box                |
| ⑫ Static Air Temperature (SAT)         | ㉖ Slip/Skid Indicator            |
| ⑬ Softkeys                             | ㉗ Attitude Indicator             |
| ⑭ System Time                          |                                  |

Figure 2-1 Primary Flight Display (Default)



- |  |                              |
|--|------------------------------|
| ① Vspeed References                        | ⑩ Radar Altimeter            |
| ② Selected Heading                         | ⑪ Current Vertical Speed     |
| ③ Wind Data                                | ⑫ CAS Window                 |
| ④ Inset Map                                | ⑬ Reversionary Sensor Window |
| ⑤ DME Information Windows                  | ⑭ Glidepath Indicator        |
| ⑥ Bearing Information Windows              | ⑮ Comparator Window          |
| ⑦ Flight Plan Window                       | ⑯ TAWS Annunciation          |
| ⑧ Minimum Descent Altitude/Decision Height | ⑰ Traffic Annunciation       |
| ⑨ Selected Course                          |                              |

Figure 2-2 Additional PFD Information

## 2.1 FLIGHT INSTRUMENTS

### AIRSPEED INDICATOR



**NOTE:** Refer to the Airplane Flight Manual (AFM) for speed criteria and Vspeed values.

The Airspeed Indicator displays airspeed on a moving tape rolling number gauge. The numeric labels and major tick marks on the moving tape represent intervals of 10 knots. The minor tick marks on the moving tape represent intervals of five knots. Speed indication starts at 20 knots, with 80 knots of airspeed scale viewable at any time. The indicated airspeed is displayed inside the black pointer. The pointer remains black until reaching maximum operating speed ( $V_{MO}/M_{MO}$ ), at which point it turns red along with the Mach number readout.

The Mach number is displayed below the Airspeed Indicator (Figure 2-3) for airspeeds at or above Mach 0.4 or at altitudes of 26,227 feet or higher. The color of the readout is the same as the color of the airspeed pointer.

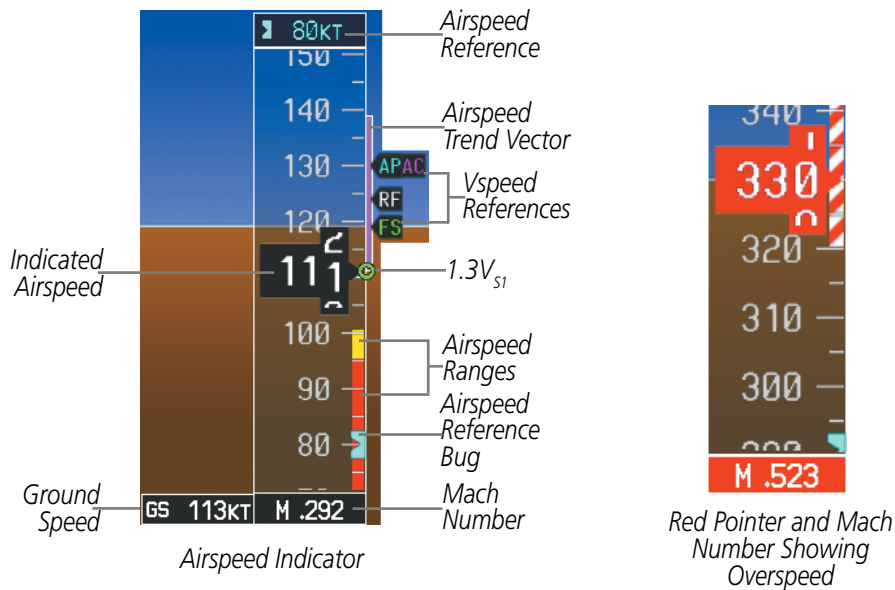

Figure 2-3 Airspeed Indicator

Speeds above the maximum operating speed,  $V_{MO}$  or  $M_{MO}$  depending on aircraft altitude, appear in the high speed awareness range, shown on the airspeed tape by a red/white barber pole. An aural overspeed warning tone is generated if the airspeed exceeds the high airspeed limit.

Yellow and red ranges are also present for low speed awareness velocity ( $V_{LSA}$ ). If the indicated airspeed is within the yellow range, the airspeed readout is displayed in yellow. If the indicated airspeed is within the red range, the airspeed pointer is displayed in red. An aural stall warning is generated if the airspeed falls below  $V_{LSA}$ . An open green circle on the airspeed tape represents  $1.3V_{S1}$ . The green circle is displayed when in the air below 18,000 feet, and it indicates the stall warning system is functioning correctly.

The Airspeed Trend Vector is a vertical magenta line that appears to the right of the color-coded speed range strip when airspeed is either accelerating or decelerating. One end of the magenta line is anchored to the tip of the airspeed pointer while the other end moves continuously up or down corresponding to the rate of acceleration or deceleration. For any constant rate of acceleration or deceleration, the moving end of the line shows approximately what the indicated airspeed value will be in six seconds. If the trend vector crosses  $V_{MO}/M_{MO}$ , the airspeed and the Mach readouts changes to yellow. If the trend vector crosses the red  $V_{LSA}$  range, the airspeed readout is displayed in yellow. The trend vector is absent if the speed remains constant or if any data needed to calculate airspeed is not available due to a system failure.

The Airspeed Reference is displayed above the Airspeed Indicator in the box indicated by a selection bug symbol. A bug corresponding to this speed is shown on the tape. If the Airspeed Reference exceeds the range shown on the tape, the bug appears at the upper or lower edge of the tape. See the AFCS Section for more information about the Airspeed Reference.

Vspeeds can be changed and their flags turned on/off from the Timer/References Window. When active (on), the Vspeeds are displayed at their respective locations to the right of the airspeed scale. By default, all Vspeed values are reset and all flags turned off during power up.

	Vspeed	Flag
Takeoff	$V_1$	1
	$V_R$	R
	$V_2$	2
	$V_{FS}$	FS
Landing	$V_{AP}$	AP
	$V_{REF}$	RF
	$V_{AC}$	AC
	$V_{FS}$	FS

**Table 2-1 Vspeed Flag Labels**

Vspeeds are categorized as either takeoff or landing. Takeoff Vspeed flags are automatically turned off when airspeed reaches 160 knots. The order in which the categories are displayed is determined by whether the aircraft is on the ground or in the air. If the aircraft is on the ground, the takeoff Vspeeds are displayed at the top of the Vspeed list. If the aircraft is in the air, the landing Vspeeds are displayed at the top.

**Changing Vspeeds and turning flags on/off:**

- 1) Select the **TMR/REF** Softkey.
- 2) Turn the large **FMS** Knob to highlight the desired Vspeed.
- 3) Use the small **FMS** Knob to change the Vspeed in 1-kt increments (when a speed has been changed from a default value, an asterisk appears next to the speed).
- 4) Press the **ENT** Key or turn the large **FMS** Knob to highlight the ON/OFF field.
- 5) Turn the small **FMS** Knob clockwise to ON or counterclockwise to OFF.
- 6) To remove the window, press the **CLR** Key or select the **TMR/REF** Softkey.

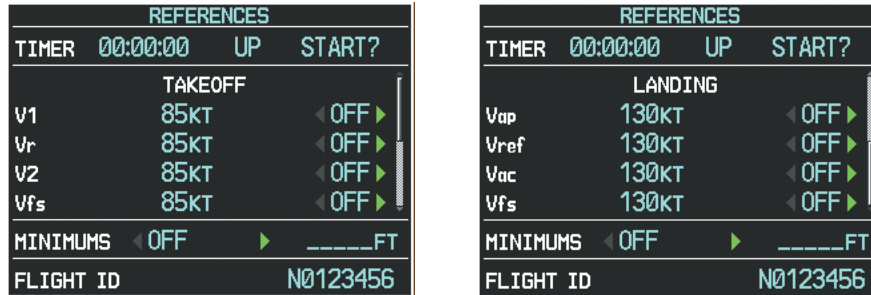

Figure 2-4 Takeoff and Landing Vspeeds (Timer/References Window)

Vspeed flags can be turned on or off all at once or by category (takeoff and landing). Default values for all or a category of Vspeeds can also be restored.

**Modifying Vspeeds (on, off, restore defaults):**

- 1) Select the **TMR/REF** Softkey.
- 2) Press the **MENU** Key.
- 3) Turn the **FMS** Knob to highlight the desired selection (Figure 2-5).
- 4) Press the **ENT** Key.
- 5) To remove the window, press the **CLR** Key or select the **TMR/REF** Softkey.

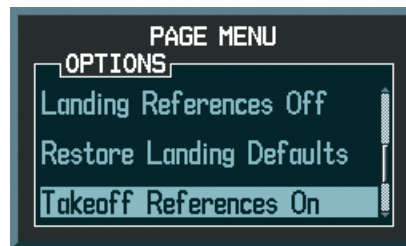
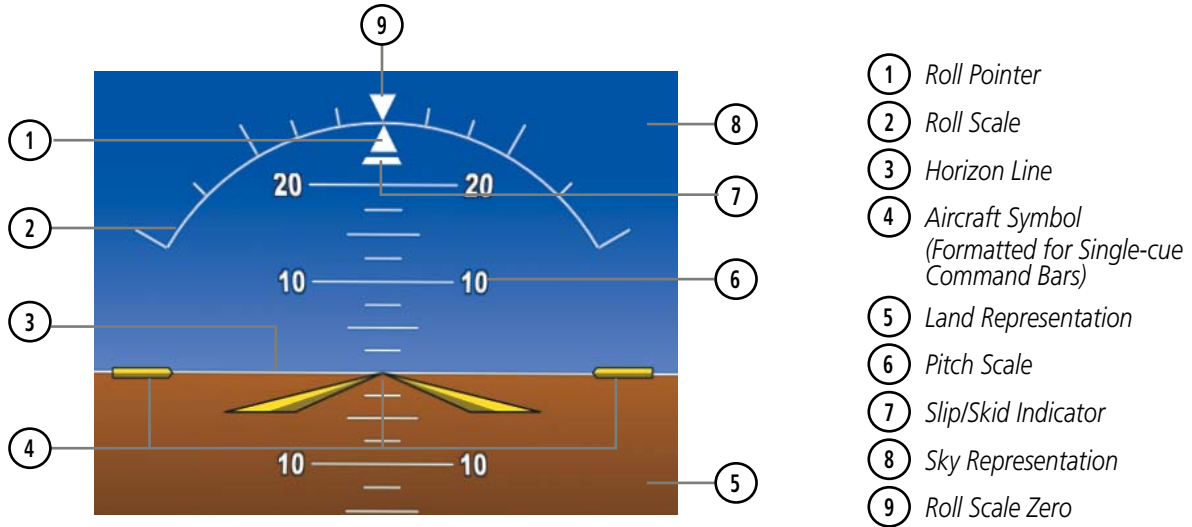

Figure 2-5 Timer/References Window Menu



**ATTITUDE INDICATOR**

Attitude information is displayed over a virtual blue sky and brown ground with a white horizon line. The Attitude Indicator displays the pitch, roll, and slip/skid information.



**Figure 2-6 Attitude Indicator**

The horizon line is part of the pitch scale. Above and below the horizon line, major pitch marks and numeric labels are shown for every 10°, up to 80°. Minor pitch marks are shown for intervening 5° increments, up to 25° below and 45° above the horizon line. Between 20° below to 20° above the horizon line, minor pitch marks occur every 2.5°. When the Synthetic Vision System is activated, the pitch scale is reduced to 10° up and 7.5° down; refer to the Additional Features section.

The inverted white triangle indicates zero on the roll scale. Major tick marks at 30° and 60° and minor tick marks at 10°, 20°, and 45° are shown to the left and right of the zero. Angle of bank is indicated by the position of the pointer on the roll scale.

The Slip/Skid Indicator is the bar beneath the roll pointer. One bar displacement is equal to one ball displacement on a traditional inclinometer. The indicator bar moves with the roll pointer and moves laterally away from the pointer to indicate uncoordinated flight. Slip (inside the turn) or skid (outside the turn) is indicated by the location of the bar relative to the pointer.

In TCAS II installations, the Attitude Indicator also provides pitch cues to comply with TCAS II Resolution Advisories; see the Hazard Avoidance Section for details.



**Figure 2-7 Slip/Skid Indication**



The yellow symbolic aircraft on the Attitude Indicator changes appearance based on selection of AFCS flight director Command Bar format (see the AFCS Section for details). Both PFDs show the same Command Bar format and Aircraft Symbol. The Command Bar format (single-cue or cross-pointer) may be selected from the AUX - System Setup Page Figure 2-8.

**Changing Command Bar and Aircraft Symbol format:**

- 1) Use the **FMS** Knob to select the AUX - System Setup Page.
- 2) Press the **FMS** Knob to activate the cursor.
- 3) Turn the large **FMS** Knob to highlight the Format Active selection in the Flight Director box.
- 4) Turn the small **FMS** Knob to highlight the desired setting and press the **ENT** Key.
- 5) Select the **SNGL CUE** option to display Command Bars as a single cue (Figure 2-8).

Or:

Select the **X POINTR** option to display Command Bars as a cross pointer (Figure 2-8).

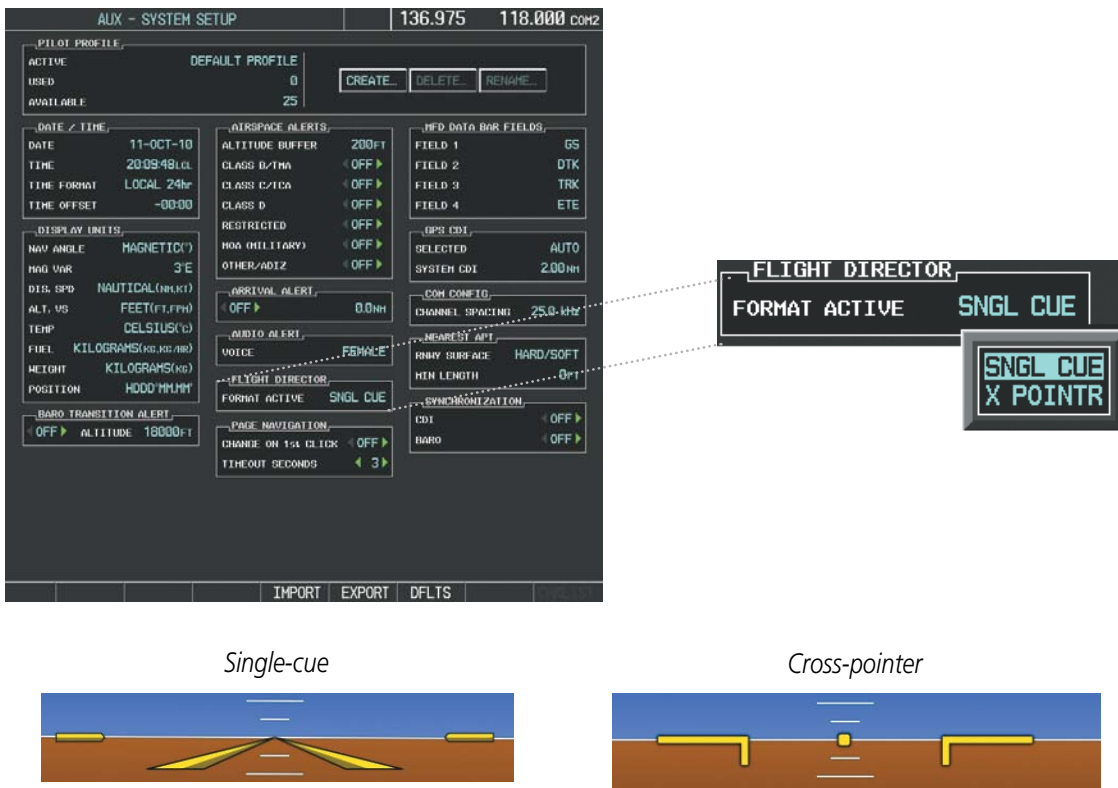

Figure 2-8 Flight Director Format (AUX - System Setup Page)

**ALTIMETER**

The altimeter displays 600 feet of barometric altitude values at a time on a moving tape rolling number gauge. Numeric labels and major tick marks are shown at intervals of 100 feet. Minor tick marks are at intervals of 20 feet. The indicated altitude is displayed inside the black pointer.

The Selected Altitude is displayed above the altimeter in the box indicated by a selection bug symbol. A bug corresponding to this altitude is shown on the tape. If the Selected Altitude exceeds the range shown on the tape, the bug appears at the upper or lower edge of the tape. When the metric value is selected it is displayed in a separate box above the Selected Altitude (Figure 2-10). See the AFCS Section for more information about Selected Altitude.

A magenta Altitude Trend Vector extends up or down the left of the altitude tape. The end extends to the approximate altitude to be reached in six seconds at the current vertical speed. The trend vector is not shown if altitude remains constant or if data needed for calculation is not available due to a system failure.

**Setting the Selected Altitude:**

Turn the **ALT SEL** Knob to set the Selected Altitude in 100-ft increments up to the aircraft’s service ceiling. If set to Metric mode, the **ALT SEL** Knob adjusts the Selected Altitude in 50-meter increments.

If a Minimum Descent Altitude/Decision Height (MDA/DH) value has been set, this value is also available as a Selected Altitude setting when turning the **ALT SEL** Knob.

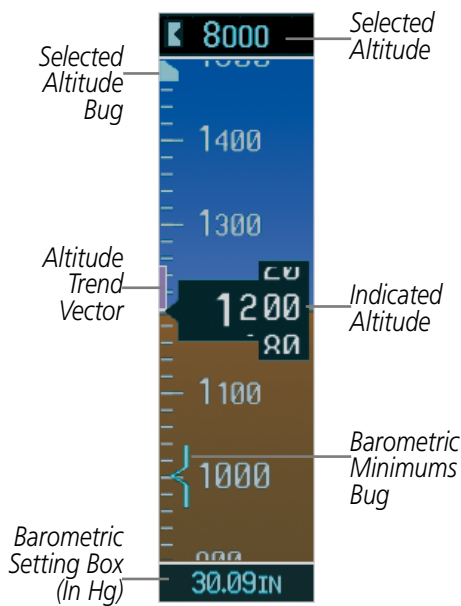

**Figure 2-9 Altimeter Settings, In Hg**

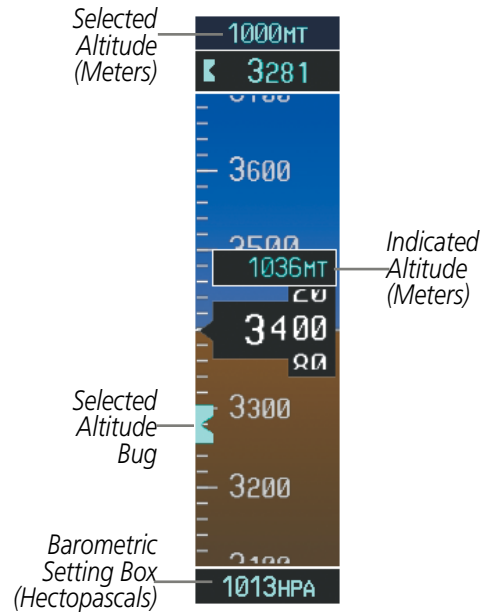

**Figure 2-10 Altimeter Setting in hPa and Altitude in Meters**

Selected and current altitudes can also be displayed in meters (readouts displayed above the normal readouts in feet; Figure 2-10). Note that the altitude tape does not change scale.

#### Displaying altitude in meters:

- 1) Select the **PFD** Softkey to display the second-level softkeys.
- 2) Select the **ALT UNIT** Softkey.
- 3) Select the **METERS** Softkey to turn on metric altitude readouts (Figure 2-10).
- 4) Select the **BACK** Softkey twice to return to the top-level softkeys.

The barometric pressure setting is displayed below the altimeter in inches of mercury (in Hg) or hectopascals (hPa). Adjusting the altimeter barometric setting creates discontinuities in VNV vertical deviation, moving the descent path. For large adjustments, it may take several minutes for the aircraft to re-establish on the descent path. If the change is made while nearing a waypoint with a VNV Target Altitude, the aircraft may not re-establish on the descent path in time to meet the vertical constraint.

#### Changing altimeter barometric pressure setting units:

- 1) Select the **PFD** Softkey to display the second-level softkeys.
- 2) Select the **ALT UNIT** Softkey.
- 3) Select the **IN** Softkey to display the barometric pressure setting in inches of mercury (in Hg) (Figure 2-9).  
Or, select the **HPA** Softkey to display the barometric pressure setting in hectopascals (hPa) (Figure 2-10).
- 4) Select the **BACK** Softkey twice to return to the top-level softkeys.

#### Selecting the altimeter barometric pressure setting:

Turn the **BARO** Knob to select the desired setting.

#### Selecting standard barometric pressure (29.92 in Hg):

Press the **BARO** Knob to select standard pressure.

Or:

- 1) Select the **PFD** Softkey to display the second-level softkeys.
- 2) Select the **STD BARO** Softkey; STD BARO is displayed in barometric setting box.

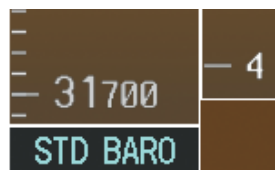
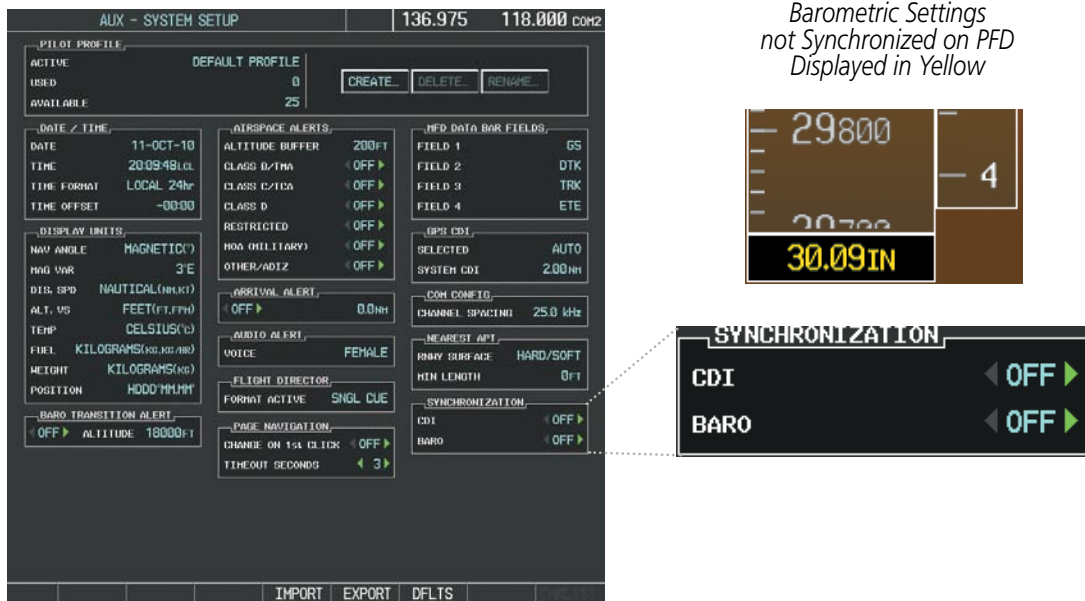

Figure 2-11 Standard Barometric Altimeter Setting

If the barometric altimeter settings differ between PFDs by more than 0.02 in Hg, the readouts turn yellow. Once the settings are synchronized (BARO turned on), they remain synchronized until the setting is turned off.

**Synchronizing the altimeter barometric pressure settings:**

- 1) Select the AUX - System Setup Page using the **FMS** Knob.
- 2) Press the **FMS** Knob to activate the cursor.
- 3) Turn the large **FMS** Knob to highlight Baro in the Synchronization box.
- 4) Turn the small **FMS** Knob clockwise to ON or counterclockwise to OFF.
- 5) Press the **FMS** Knob to remove the cursor.



**Figure 2-12 Baro Sync Setting (AUX - System Setup Page)**

A Baro Transition Alert is provided to notify the pilot to change the barometric pressure setting when crossing the baro transition altitude. If the aircraft is at least 500 feet below the transition altitude and then climbs through this altitude and the **STD BARO** Softkey or **BARO** Knob has not been pressed, the barometric pressure setting flashes in light blue until the pressure setting is changed. If the aircraft is at least 500 feet above the transition altitude and then descends through this altitude and the barometric pressure setting has not been changed from STD BARO, the setting flashes in light blue until it is changed.

**Setting the Baro Transition Alert:**

- 1) Use the **FMS** Knob to select the AUX - System Setup Page on the MFD.
- 2) Press the **FMS** Knob to activate the cursor.
- 3) Turn the large **FMS** Knob to highlight Altitude in the Baro Transition Alert box.
- 4) Turn the small **FMS** Knob to turn the alert OFF or ON and press the **ENT** Key.
- 5) Turn the small **FMS** Knob to change the desired altitude and press the **ENT** Key.
- 6) To cancel the selection, press the **FMS** Knob.



Figure 2-13 Baro Transition Alert (AUX - System Setup Page)

**VERTICAL SPEED INDICATOR (VSI)**

The Vertical Speed Indicator (VSI) displays the aircraft vertical speed on a fixed scale with labels at 2000 and 4000 fpm and minor tick marks every 1000 fpm. Digits appear in the pointer when the climb or descent rate is greater than 100 fpm. If the rate of ascent/descent exceeds 4000 fpm, the pointer appears at the edge of the tape and the rate appears inside the pointer.

A magenta chevron is displayed on the VSI to indicate the Required Vertical Speed for reaching a VNV target altitude once the “TOD [Top of Descent] within 1 minute” alert has generated. See the Flight Management and AFCS sections for details on VNV features. Refer to Section 2.2, Supplemental Flight Data, for more information about VNV indications on the PFD. In TCAS II installations, the VSI also provides vertical speed guidance during TCAS II Resolution Advisories; see the Hazard Avoidance section for details.

**VERTICAL DEVIATION**

The Vertical Deviation Indicator (VDI) is a magenta chevron indicating the baro-VNV vertical deviation when Vertical Navigation (VNV) is being used. The VDI appears in conjunction with the “TOD within 1 minute” alert. The VDI is removed from the display if vertical deviation becomes invalid. See the Flight Management Section for details on VNV features, and refer to Section 2.2, Supplemental Flight Data, for more information about VNV indications on the PFD.

The Glideslope Indicator appears to the left of the altimeter whenever an ILS frequency is tuned in the active NAV field and the aircraft heading and selected course are within 107°. A green diamond acts as the Glideslope Indicator, like a glideslope needle on a conventional indicator. If a localizer frequency is tuned and there is no glideslope, “NO GS” is displayed in place of the diamond.

The glidepath is analogous to the glideslope for GPS approaches supporting SBAS vertical guidance (LNAV+V, L/VNAV, LPV). When an approach of this type is loaded into the flight plan and GPS is the selected navigation source, the Glidepath Indicator appears as a magenta diamond during the approach. If the approach type downgrades past the final approach fix (FAF), “NO GP” is displayed in place of the diamond.

Full-scale deflection of two dots is 1000 feet.

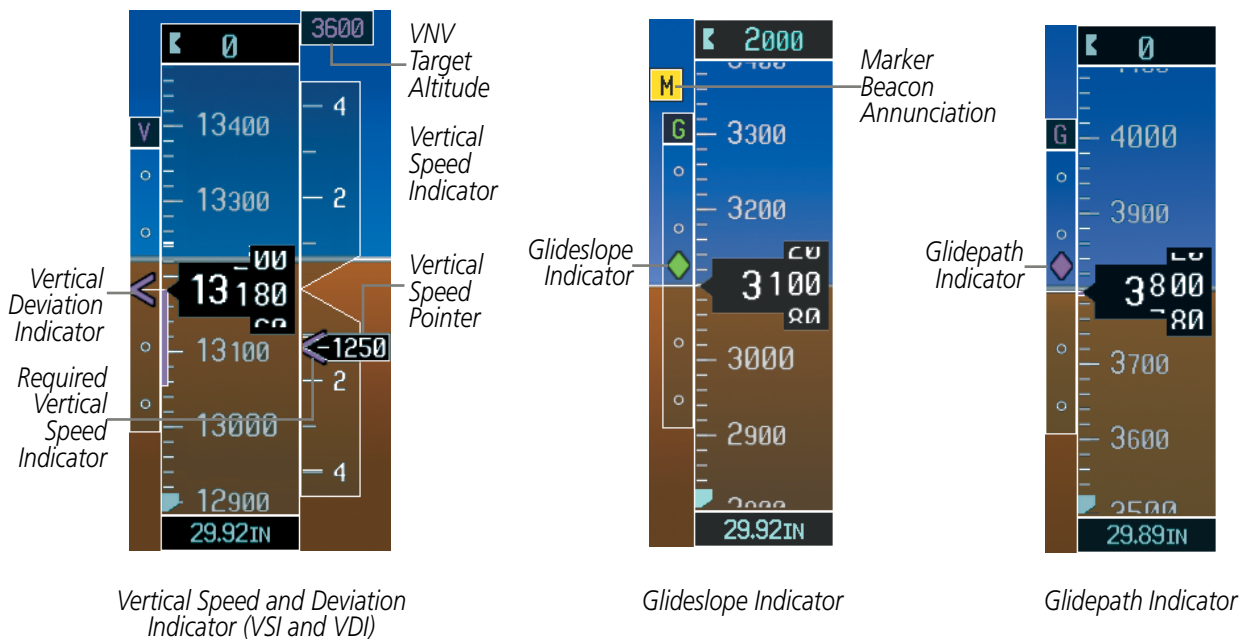

**Figure 2-14 Vertical Speed and Vertical Deviation Indications**

## HORIZONTAL SITUATION INDICATOR (HSI)

The Horizontal Situation Indicator (HSI) displays a rotating compass card in a heading-up orientation. Letters indicate the cardinal points with numeric labels every 30°. Major tick marks are at 10° intervals and minor tick marks are at 5° intervals. A digital reading of the current heading appears on top of the HSI, and the current track is represented on the HSI by a magenta diamond. The HSI also presents turn rate, course deviation, bearing, and navigation source information. The HSI is available in two formats, a 360° compass rose and a 140° arc.

### Changing the HSI display format:

- 1) Select the **PFD** Softkey.
- 2) Select the **HSI FRMT** Softkey.
- 3) Select the **360 HSI** or **ARC HSI** Softkey.

The 360° HSI contains a Course Deviation Indicator (CDI), with a Course Pointer, To/From Indicator, and a sliding deviation bar and scale. The course pointer is a single line arrow (GPS, VOR1, and LOC1) or a double line arrow (VOR2 and LOC2) which points in the direction of the set course. The To/From arrow rotates with the course pointer and is displayed when the active NAVAID is received.

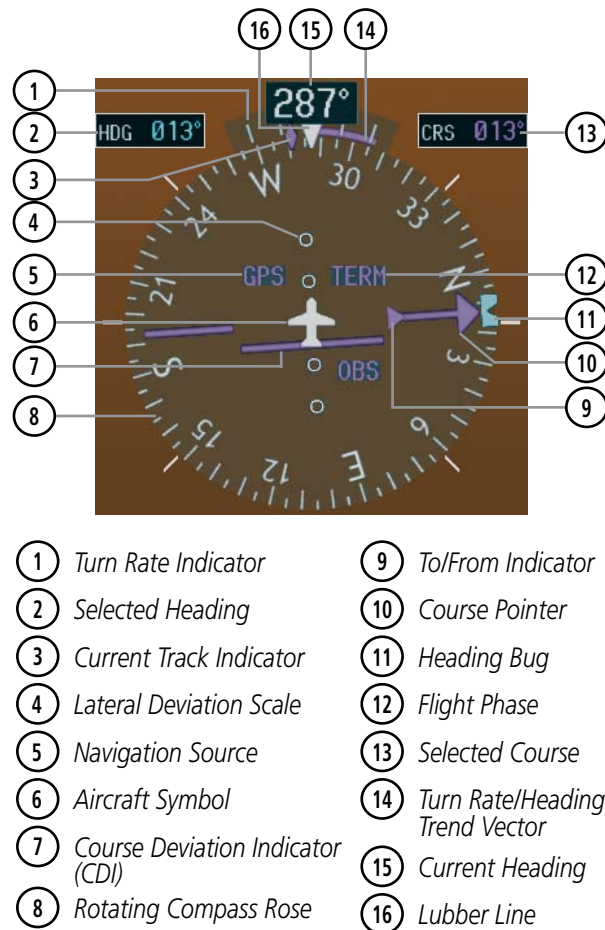

Figure 2-15 Horizontal Situation Indicator (HSI)



The Arc HSI is a 140° expanded section of the compass rose. The Arc HSI contains a Course Pointer, combined To/From Indicator and a sliding deviation indicator, and a deviation scale. Upon station passage, the To/From Indicator flips and points to the tail of the aircraft, just like a conventional To/From flag. Depending on the navigation source, the CDI on the Arc HSI can appear in two different ways, an arrowhead (GPS, VOR, OBS) or a diamond (LOC).

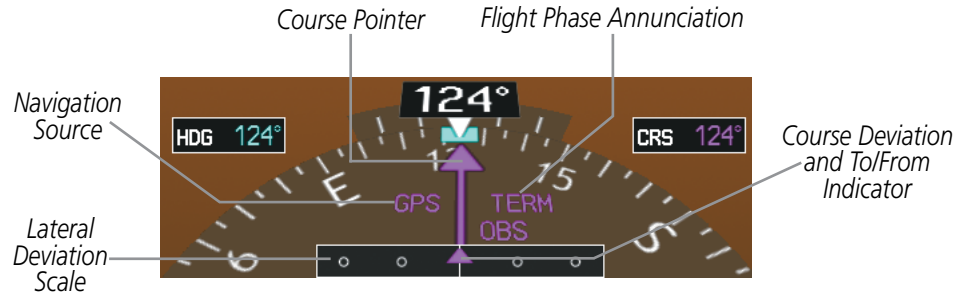

Figure 2-16 Arc HSI

A digital reading of the current heading appears on top of the HSI. The current track is represented on the HSI by a magenta diamond. To the upper left of the HSI, the Selected Heading is shown in light blue; the light blue bug on the compass rose corresponds to the Selected Heading. The Selected Course is shown to the upper right of the HSI. The color of the Selected Course corresponds to the selected navigation source (magenta for GPS and green for VOR or LOC).

**Adjusting the Selected Heading:**

Turn the **HDG** Knob to set the Selected Heading on both PFDs.

Press the **HDG** Knob to synchronize the bug to the current heading.

**Adjusting the Selected Course:**

Turn the **CRS** Knob to set the Selected Course (for each PFD).

Press the **CRS** Knob to re-center the CDI and return the course pointer to the bearing of the active waypoint or navigation station.

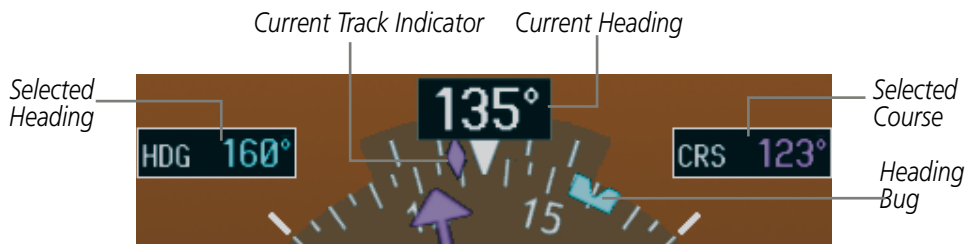

Figure 2-17 Heading and Course Indications



Navigation angles (track, heading, course, bearing) are corrected to the computed magnetic variation (Mag Var) or referenced to true north (T), set on the AUX - System Setup Page. When an approach referenced to true north has been loaded into the flight plan, the system generates a message to change the navigation angle setting to True at the appropriate time.



Figure 2-18 Heading and Course Indications (True)

**Changing the navigation angle true/magnetic setting:**

- 1) Use the **FMS** Knob to select the AUX - System Setup Page on the MFD.
- 2) Press the **FMS** Knob to activate the cursor.
- 3) Turn the large **FMS** Knob to highlight Nav Angle in the Display Units box.
- 4) Turn the small **FMS** Knob to highlight the desired setting and press the **ENT** Key.
  - TRUE - References angles to true north (T)
  - MAGNETIC - Angles corrected to the computed magnetic variation (Mag Var)

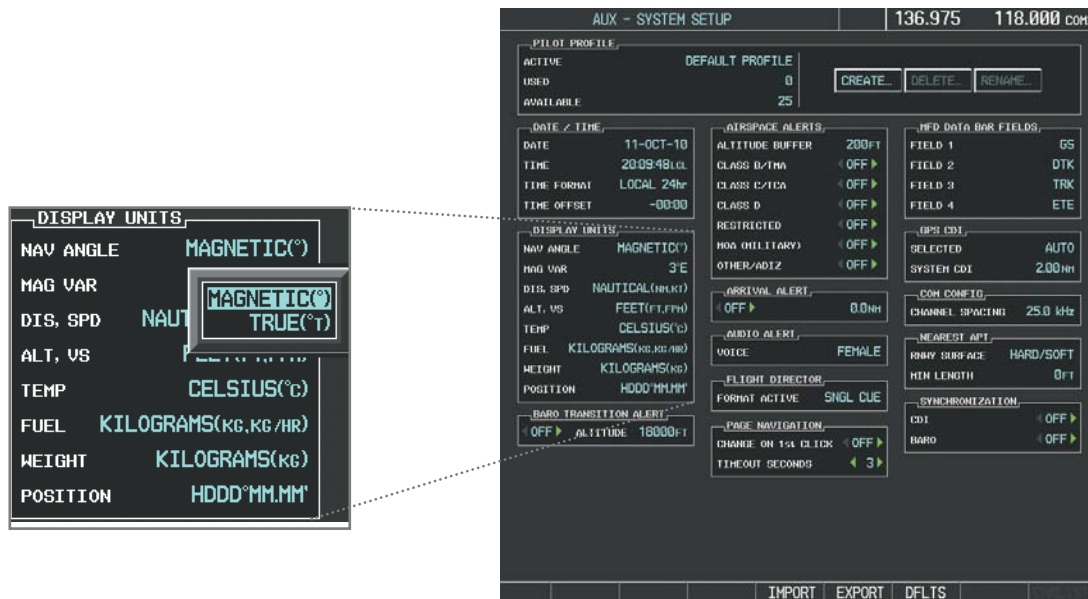

Figure 2-19 System Setup Page, Navigation Angle Settings

### TURN RATE INDICATOR

The Turn Rate Indicator is located directly above the rotating compass rose. Tick marks to the left and right of the lubber line denote half-standard and standard turn rates. A magenta Turn Rate Trend Vector shows the current turn rate. The end of the trend vector gives the heading predicted in six seconds, based on the present turn rate. A standard-rate turn is shown on the indicator by the trend vector stopping at the standard turn rate tick mark, corresponding to a predicted heading of 18° from the current heading. At rates greater than 4 deg/sec, an arrowhead appears at the end of the magenta trend vector and the prediction is no longer valid.



Figure 2-20 Turn Rate Indicator and Trend Vector

### BEARING POINTERS AND INFORMATION WINDOWS

Two bearing pointers and associated information can be displayed on the HSI for NAV, GPS, and ADF sources. The bearing pointers are light blue and are single-line (BRG1) or double-line (BRG2). A pointer symbol is shown in the information window to indicate the navigation source. The bearing pointers never override the CDI and are visually separated from the CDI by a white ring. Bearing pointers may be selected but not necessarily visible due to data unavailability.

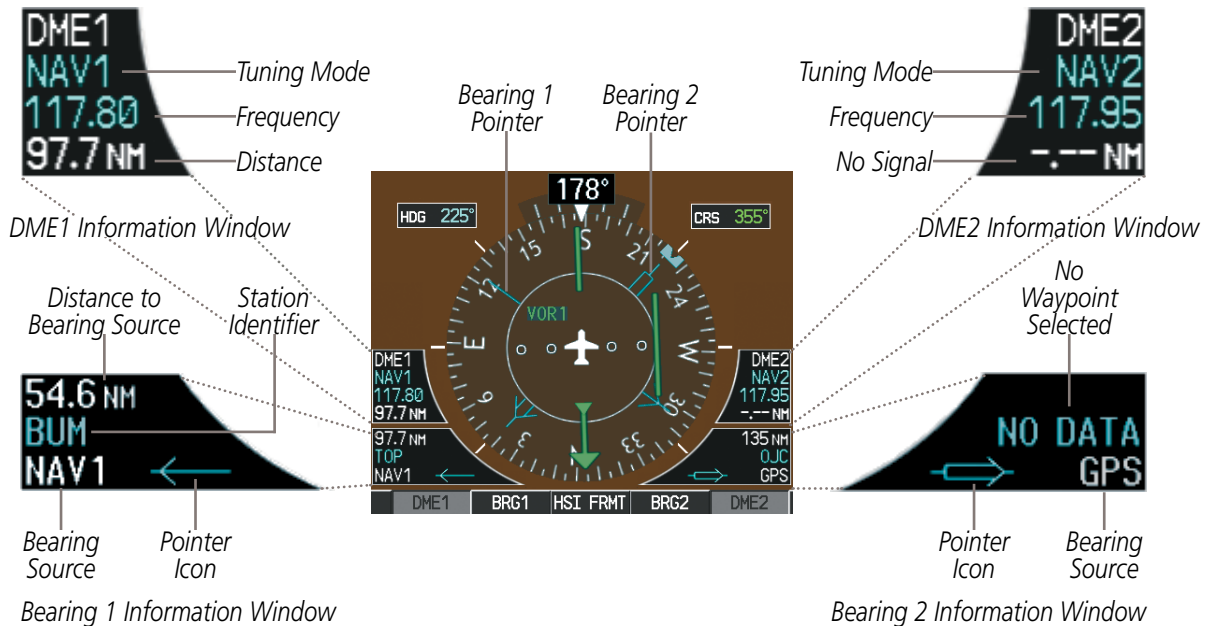

Figure 2-21 HSI with Bearing and DME Information

When a bearing pointer is displayed, the associated information window is also displayed. The Bearing Information windows are displayed at the lower sides of the HSI and give the following information:

- Bearing source (NAV, GPS, ADF)
- Pointer icon (BRG1 = single line, BRG2 = double line)
- Frequency (NAV, ADF)
- Station/waypoint identifier (NAV, GPS)
- GPS-derived great circle distance to bearing source

When the NAV radio is tuned to an ILS frequency the bearing source and the bearing pointer is removed from the HSI. When NAV1 or NAV2 is the selected bearing source, the frequency is replaced by the station identifier when the station is within range. If GPS is the bearing source, the active waypoint identifier is displayed instead of a frequency.

The bearing pointer is removed from the HSI and NO DATA is displayed in the information window if the NAV radio is not receiving a VOR station or if GPS is the bearing source and an active waypoint is not selected.

When the Arc HSI is displayed, the Bearing Information windows and pointers are disabled.

#### Selecting bearing display and changing sources:

- 1) Select the **PFD** Softkey.
- 2) Select a **BRG** Softkey to display the desired bearing pointer and information window with a NAV source.
- 3) Select the **BRG** Softkey again to change the bearing source to GPS.
- 4) Select the **BRG** Softkey a third time to change the bearing source to ADF (ADF Radio installation is optional).
- 5) To remove the bearing pointer and information window, select the **BRG** Softkey again.

## DME INFORMATION WINDOWS

The DME Information Windows are displayed above each BRG Information Window on the 360° HSI and in boxes along side and above the Arc HSI. It shows the DME label, tuning mode (NAV1, NAV2, or HOLD), frequency, and distance. When a signal is invalid, the distance is replaced by –. – NM Refer to the Audio Panel and CNS Section for information on tuning the DMEs.

#### Displaying the DME Information Window:

- 1) Select the **PFD** Softkey.
- 2) Select the **DME1** or **DME2** Softkey to display the DME Information Windows.
- 3) To remove the DME Information Windows, select the applicable **DME** Softkey again.

## COURSE DEVIATION INDICATOR (CDI)

**NOTE:** During a heading change of greater than 105° with respect to the course, the CDI on the Arc HSI switches to the opposite side of the deviation scale and displays reverse sensing.

The Course Deviation Indicator (CDI) moves left or right from the course pointer along a lateral deviation scale to display aircraft position relative to the course. If the course deviation data is not valid, the CDI is not displayed.

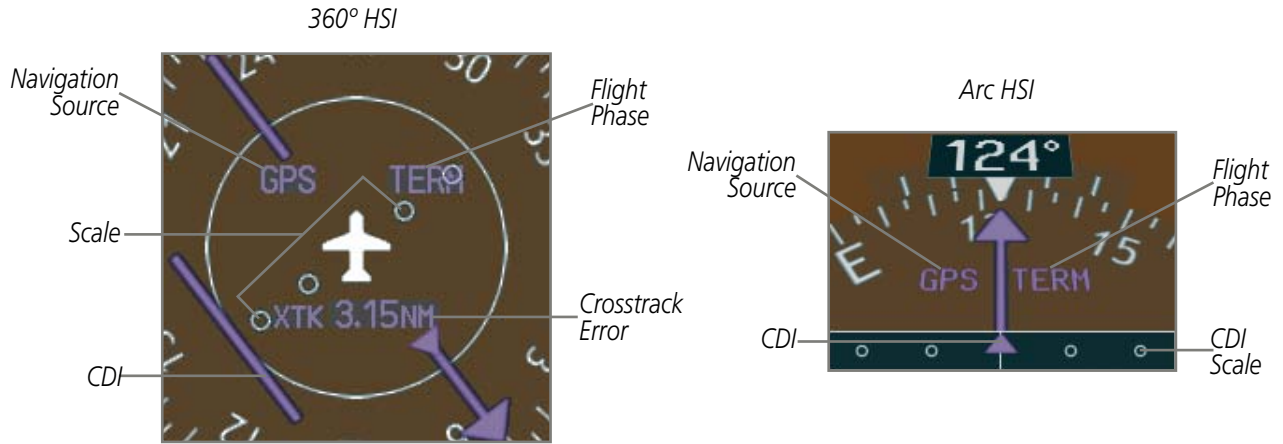

Figure 2-22 Course Deviation Indicator

The CDI can display two sources of navigation: GPS or NAV (VOR/LOC). The color indicates the current navigation source: magenta for GPS or green for VOR and LOC. The full scale limits for the CDI are defined by a GPS-derived distance when navigating GPS. When navigating using a VOR or localizer (LOC), the CDI has the same angular limits as a mechanical CDI. If the CDI exceeds the maximum deviation on the scale (two dots) while navigating with GPS, the crosstrack error (XTK) is displayed below the white aircraft symbol.



Figure 2-23 Navigation Sources

**CHANGING NAVIGATION SOURCES:**

- 1) Select the **CDI** Softkey to change from GPS to VOR1 or LOC1. This places the light blue tuning box over the NAV1 standby frequency in the upper left corner of the PFD.
- 2) Select the **CDI** Softkey again to change from VOR1 or LOC1 to VOR2 or LOC2. This places the light blue tuning box over the NAV2 standby frequency.
- 3) Select the **CDI** Softkey a third time to return to GPS.

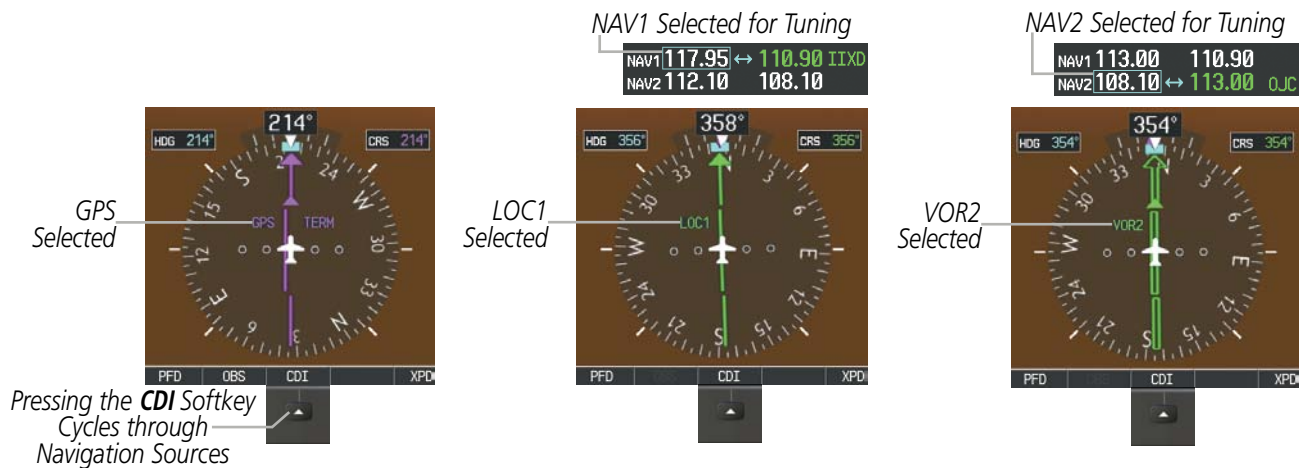

**Figure 2-24 Selecting a Navigation Source**

The system automatically switches from GPS to LOC navigation source and changes the CDI scaling accordingly when all of the following occur:

- A localizer or ILS approach has been loaded into the active flight plan
- The Final Approach Fix (FAF) is the active leg, the FAF is less than 15 nm away, and the aircraft is moving toward the FAF
- A valid localizer frequency has been tuned
- The GPS CDI deviation is less than 1.2 times full-scale deflection

GPS steering guidance is still provided after the CDI automatically switches to LOC until LOC capture, up to the Final Approach Fix (FAF) for an ILS approach, or until GPS information becomes invalid. Activating a Vector-to-Final (VTF) also causes the CDI to switch to LOC navigation source. GPS steering guidance is not provided after the switch.

If the same VOR/LOC navigation source is selected on both PFDs, the navigation source annunciation turns yellow on both displays if not synchronized. Once the CDIs are synchronized (CDI Synchronization turned on), they remain synchronized until the selection is changed. When turning on the system for use, it remembers the last CDI synchronization setting.

**Synchronizing the CDIs:**

- 1) Select the AUX - System Setup Page using the **FMS** Knob.
- 2) Press the **FMS** Knob to activate the cursor.
- 3) Turn the large **FMS** Knob to highlight CDI in the Synchronization box.
- 4) Turn the small **FMS** Knob clockwise to ON or counterclockwise to OFF.
- 5) Press the **FMS** Knob to remove the cursor.

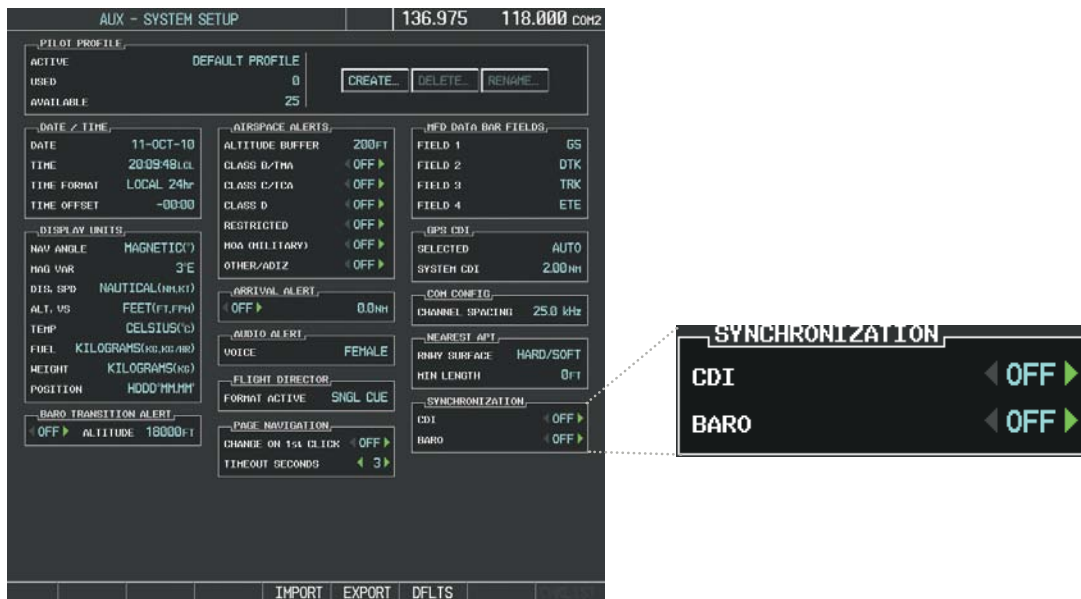

**Figure 2-25 System Setup Page, CDI Synchronization**

## GPS CDI SCALING

When GPS is the selected navigation source, the flight plan legs are sequenced automatically and annunciations appear on the HSI for the flight phase. Flight phase annunciations are normally shown in magenta, but when cautionary conditions exist the color changes to yellow. If the current leg in the flight plan is a heading leg, HDG LEG is annunciated in magenta beneath the aircraft symbol.

The current GPS CDI scale setting is displayed as System CDI on the AUX - System Setup Page and the full-scale deflection setting may also be changed (2.0 nm, 1.0 nm, 0.3 nm, or Auto) from this page. If the selected scaling is smaller than the automatic setting for enroute and terminal phases, the CDI is scaled accordingly and the selected setting is displayed rather than the flight phase annunciation.

### Changing the selected GPS CDI setting:

- 1) Use the **FMS** Knob to select the AUX - System Setup Page on the MFD.
- 2) Press the **FMS** Knob to activate the cursor.
- 3) Turn the large **FMS** Knob to highlight Selected in the GPS CDI box.
- 4) Turn the small **FMS** Knob to highlight the desired setting and press the **ENT** Key.
- 5) To cancel the selection, press the **FMS** Knob or the **CLR** Key.

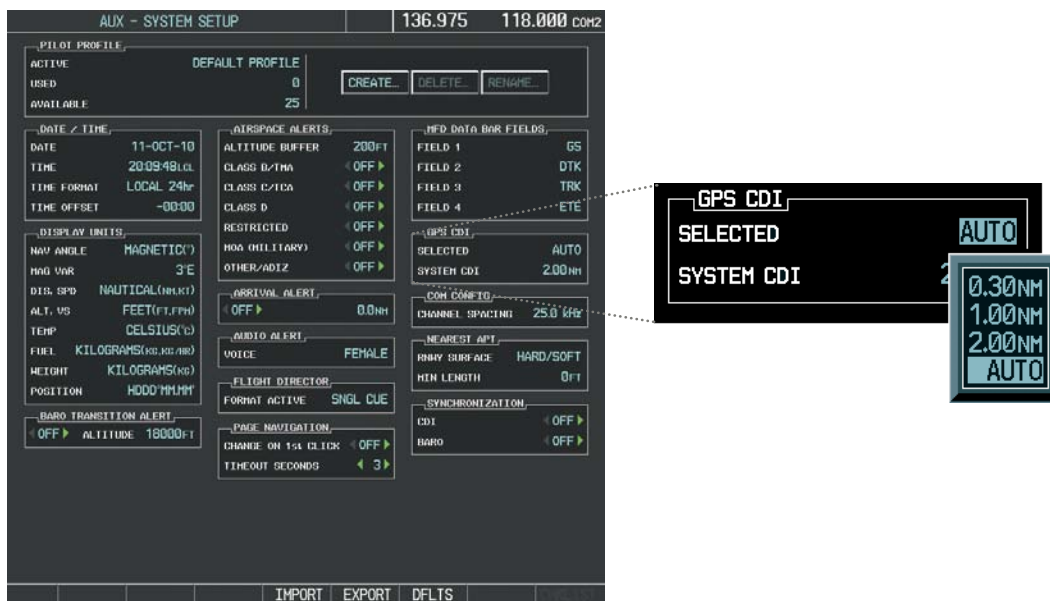

Figure 2-26 System Setup Page, GPS CDI Setting

When set to Auto (default), the GPS CDI scale automatically adjusts to the desired limits based upon the current phase of flight (Figure 2-27, Table 2-2).



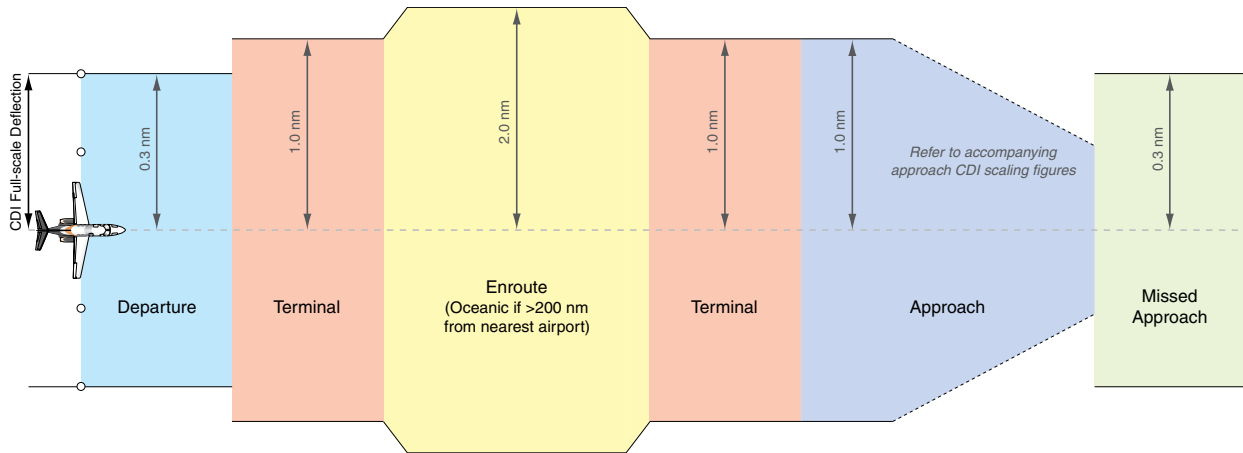

Figure 2-27 Automatic CDI Scaling

- Once a departure procedure is activated, the CDI is scaled for **departure** (0.3 nm).
- The system switches from departure to **terminal** CDI scaling (1.0 nm) under the following conditions:
  - The next leg in the departure procedure is not aligned with the departure runway
  - The next leg in the departure procedure is not a CA, CD, CF, CI, CR, DF, FA, FC, FD, FM, IF, or TF leg (see Glossary for leg type definitions)
  - After any leg in the departure procedure that is not a CA or FA leg
- At 30 nm from the departure airport the **enroute** phase of flight is automatically entered and CDI scaling changes to 2.0 nm over a distance of 1.0 nm, except under the following conditions:
  - When navigating with an active departure procedure, the flight phase and CDI scale does not change until the aircraft arrives at the last departure waypoint (if more than 30 nm from the departure airport) or the leg after the last departure waypoint has been activated or a direct-to waypoint is activated.
- If after completing the departure procedure the nearest airport is more than 200 nm away from the aircraft and the approach procedure has not yet commenced, the CDI is scaled for **oceanic** flight (2.0 nm).
- Within 31 nm of the destination airport (**terminal** area), the CDI scale gradually ramps down from 2.0 nm to 1.0 nm over a distance of 1.0 nm, except under the following conditions:
  - Upon reaching the first waypoint of an arrival route that is more than 31 nm from the destination airport, the flight phase changes to terminal and the CDI scale begins to transition down from 2.0 nm to 1.0 nm over a distance of 1.0 nm.
- During **approach**, the CDI scale ramps down even further (Figures 2-28 and 2-29). This transition normally occurs within 2.0 nm of the Final Approach Fix (FAF). The CDI switches to approach scaling automatically once the approach procedure is active or if Vectors-To-Final (VTF) are selected.
  - If the active waypoint is the FAF, the ground track and the bearing to the FAF must be within 45° of the final approach segment course.
  - If the active waypoint is part of the missed approach procedure, the active leg and the preceding missed approach legs must be aligned with the final approach segment course and the aircraft must not have passed the turn initiation point.



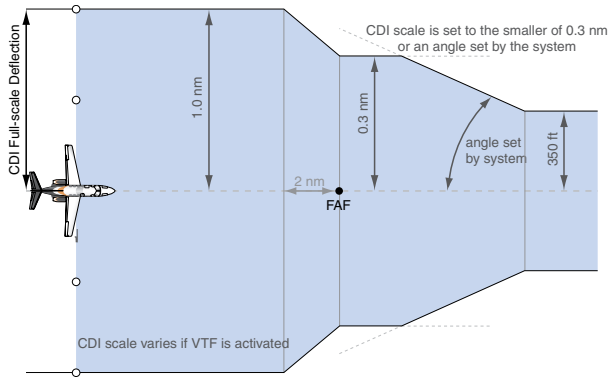

Figure 2-28 Typical LNAV and LNAV+V Approach CDI Scaling

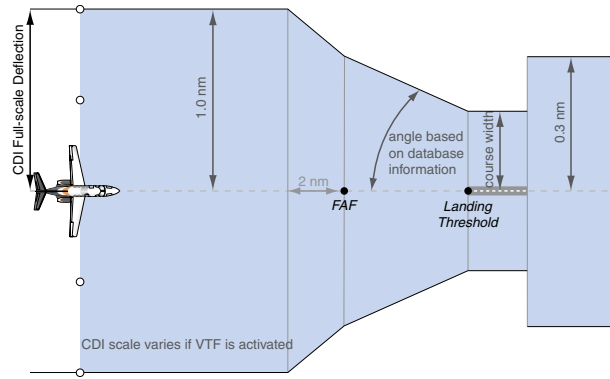

Figure 2-29 Typical LNAV/VNAV and LPV Approach CDI Scaling

- When a **missed approach** is activated, the CDI scale changes to 0.3 nm.
- The system automatically switches back to **terminal** mode under the following conditions:
  - The next leg in the missed approach procedure is not aligned with the final approach path
  - The next leg in the missed approach procedure is not a CA, CD, CF, CI, CR, DF, FA, FC, FD, FM, IF, or TF leg
  - After any leg in the missed approach procedure that is not a CA or FA leg

Flight Phase	Annunciation*	Automatic CDI Full-scale Deflection
Departure	DPRT	0.3 nm
Terminal	TERM	1.0 nm
Enroute	ENR	2.0 nm
Oceanic	OCN	2.0 nm
Approach (Non-precision)	LNAV	1.0 nm decreasing to 350 feet depending on variables (Figure 2-28)
Approach (Non-precision with Vertical Guidance)	LNAV + V	
Approach (LNAV/VNAV)	L/VNAV	1.0 nm decreasing to a specified course width, then 0.3 nm, depending on variables (Figure 2-29)
Approach (LPV)	LPV	
Missed Approach	MAPR	0.3 nm

\* Flight phase annunciations are normally shown in magenta, but when cautionary conditions exist the color changes to yellow.

Table 2-2 Automatic GPS CDI Scaling

OBS MODE



**NOTE:** VNV is inhibited while automatic waypoint sequencing has been suspended.

Enabling Omni-bearing Selector (OBS) Mode suspends the automatic sequencing of waypoints in a GPS flight plan (GPS must be the selected navigation source), but retains the current Active-to waypoint as the navigation reference even after passing the waypoint. OBS is annunciated to the lower right of the aircraft symbol when OBS Mode is selected.

While OBS Mode is enabled, a course line is drawn through the Active-to waypoint on the moving map. If desired, the course to/from the waypoint can now be adjusted. When OBS Mode is disabled, the GPS flight plan returns to normal operation with automatic sequencing of waypoints, following the course set in OBS Mode. The flight path on the moving map retains the modified course line.

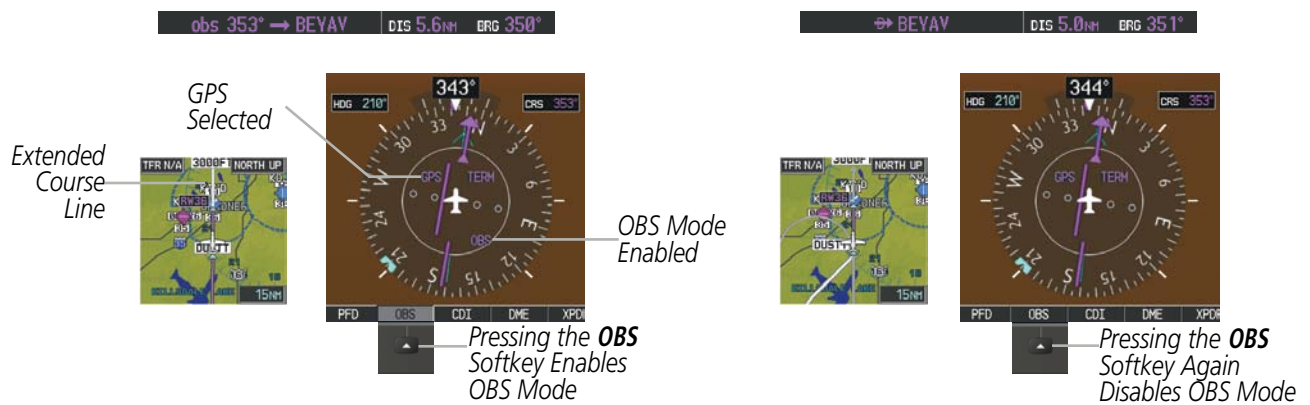

Figure 2-30 Omni-bearing Selector (OBS) Mode

**Enabling/disabling OBS Mode while navigating a GPS flight plan:**

- 1) Select the **OBS** Softkey to select OBS Mode.
- 2) Turn the **CRS** Knob to select the desired course to/from the waypoint. Press the **CRS** Knob to synchronize the Selected Course with the bearing to the next waypoint.
- 3) Select the **OBS** Softkey again to return to automatic waypoint sequencing.

As the aircraft crosses the missed approach point (MAP), automatic approach waypoint sequencing is suspended. SUSP appears on the HSI at the lower right of the aircraft symbol. The OBS Softkey label changes to indicate the suspension is active as shown in Figure 2-31. Selecting the SUSP Softkey, deactivates the suspension and resumes automatic sequencing of approach waypoints.

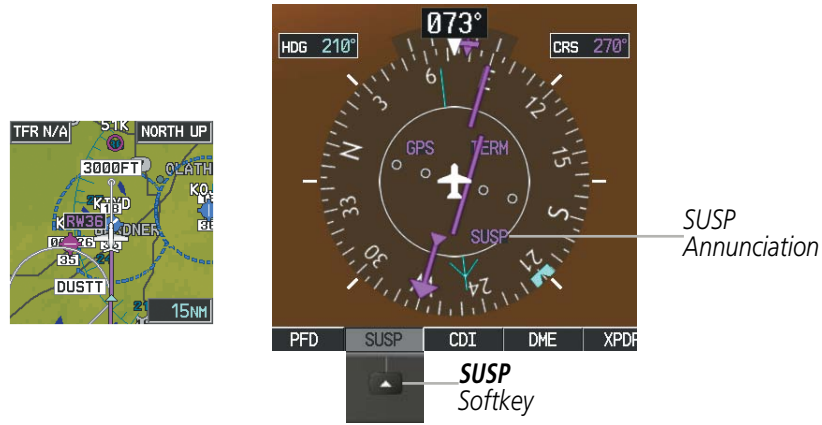

Figure 2-31 Suspending Automatic Waypoint Sequencing

## 2.2 SUPPLEMENTAL FLIGHT DATA

**NOTE:** Selecting the *DFLTS* Softkey turns off metric altimeter display, the Inset Map, and wind data display.

In addition to the flight instruments, the PFDs also display various supplemental information, including temperatures, wind data, and Vertical Navigation (VNV) indications.

### TEMPERATURE DISPLAYS

The Total and Static air temperatures (TAT and SAT) are displayed in the lower left of the PFD under normal conditions, or underneath the Airspeed Indicator in reversionary display mode. Both are displayed in degrees Celsius (°C) or Fahrenheit (°F) as configured by the installation personnel.

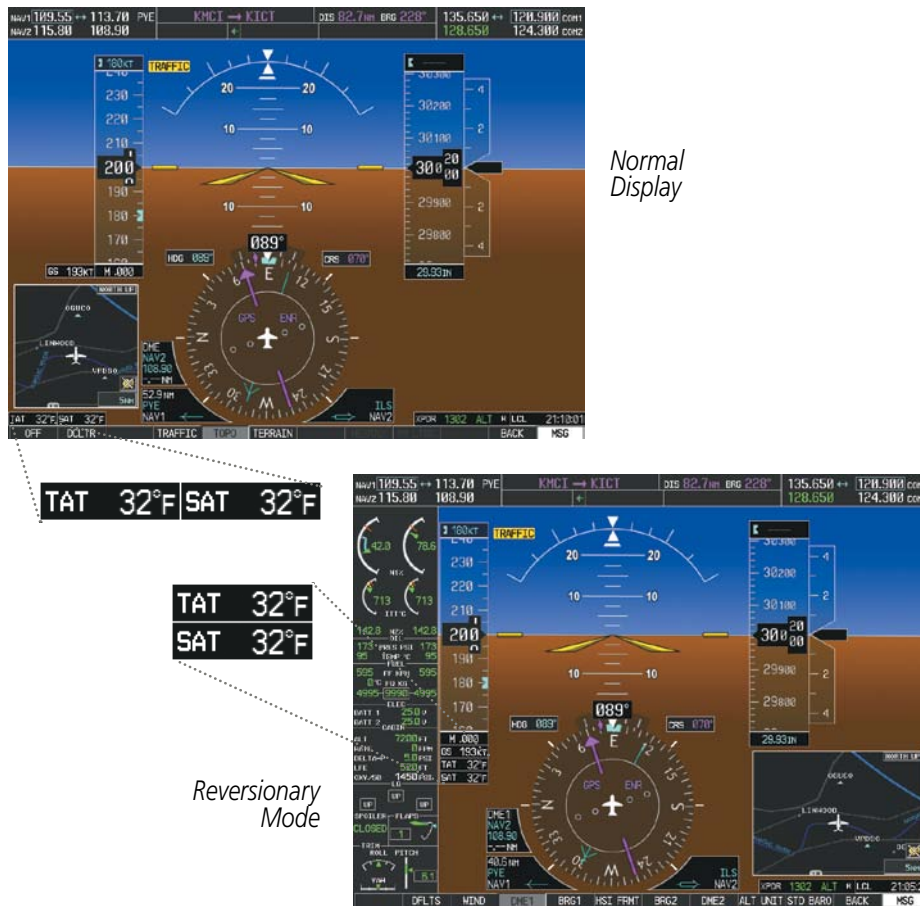

Figure 2-32 Total and Static Air Temperatures

## WIND DATA

Wind direction and speed in knots can be displayed relative to the aircraft in a window to the upper left of the HSI. When the window is selected for display, but wind information is invalid or unavailable, the window displays NO WIND DATA. Valid wind data can be displayed in three different ways:

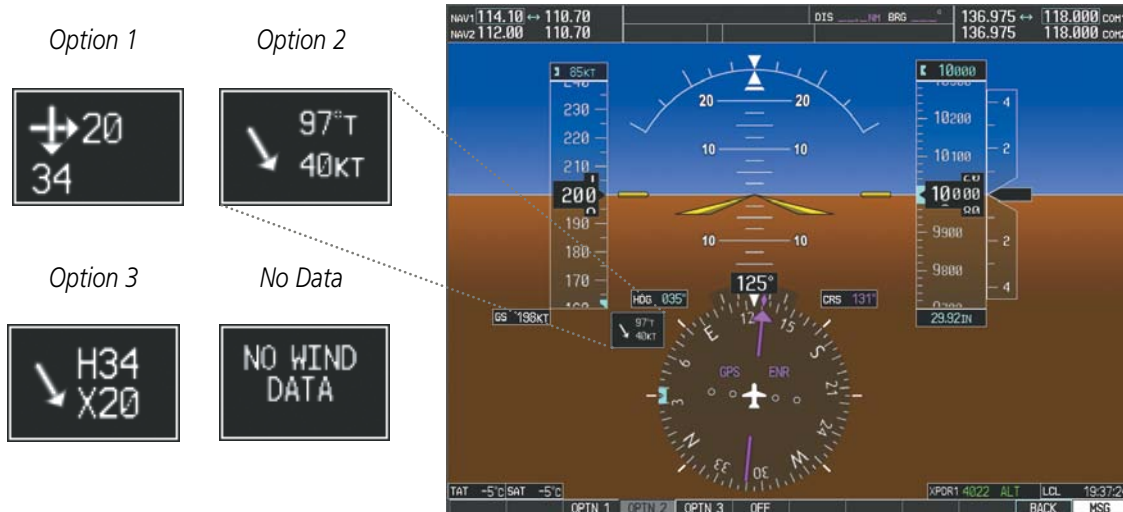

Figure 2-33 Wind Data

### Displaying wind data:

- 1) Select the **PFD** Softkey.
- 2) Select the **WIND** Softkey to access the wind data display options.
- 3) Select one of the **OPTN** softkeys to change how wind data is displayed below the Selected Heading:
  - **OPTN 1:** Wind direction arrows with numeric headwind/tailwind and crosswind components
  - **OPTN 2:** Wind direction arrow with numeric True direction and numeric speed
  - **OPTN 3:** Wind direction arrow with headwind (H) or tailwind (T) and crosswind (X) speed components
- 4) To remove the window, select the **OFF** Softkey.

## VERTICAL NAVIGATION (VNV) INDICATIONS

When a VNV flight plan has been activated, VNV indications (VNV Target Altitude, RVSI, VDI) appear on the PFD in conjunction with the “TOD within 1 minute” message and “Vertical track” voice alert. See the Flight Management and AFCS sections for details on VNV features. VNV indications are removed from the PFD according to the criteria listed in Table 2-3.



Figure 2-34 Vertical Navigation Indications (PFD)

Criteria	VNV Indication Removed		
	Required Vertical Speed (RVSI)	Vertical Deviation (VDI)	VNV Target Altitude
Aircraft > 1 min before the next TOD due to flight plan change	X	X	X
VNV cancelled ( <b>CNCL VNV</b> Softkey selected on MFD)	X	X	X
Distance to active waypoint cannot be computed due to unsupported flight plan leg type (see Flight Management Section)	X	X	X
Aircraft > 250 feet below active VNV Target Altitude	X	X	X
Current crosstrack or track angle error has exceeded limit	X	X	X
Active altitude-constrained waypoint can not be reached within maximum allowed flight path angle and vertical speed	X	X	

Table 2-3 VNV Indication Removal Criteria

## 2.3 PFD ANNUNCIATIONS AND ALERTING FUNCTIONS

The following annunciations and alerting functions are displayed on the PFD. Refer to Appendix A for more information on alerts and annunciations.

### SYSTEM ANNUNCIATIONS

The System Messages Window conveys messages to the flight crew regarding problems with the Prodigy® System. When a new message is issued, the **MSG** Softkey flashes to alert the flight crew. It continues to flash until selected, which opens the System Messages Window and acknowledges the message(s) which initiated the flashing. When the window is open, messages for which the trigger conditions no longer exist turn gray. Messages generated while the window is open are not automatically displayed, but cause the **MSG** Softkey to begin flashing again. Pressing the **MSG** Softkey while the System Messages Window is open closes the window, unless the **MSG** Softkey is flashing.

Critical values generated by redundant sensors are monitored by comparators. If differences in the sensors exceed a specified amount, the Comparator Window appears in the upper right corner of the PFD and the discrepancy is annunciated in the Comparator Window as a MISCOMP (miscompare). If one or both of the sensed values are unavailable, it is annunciated as a NO COMP (no compare).

Reversionary sensor selection is annunciated in a window on the right side of the PFD. These annunciations reflect reversionary sensors selected on one or both PFDs. Pressing the **SENSOR** Softkey accesses the **ADC1**, **ADC2**, **ADCSTBY**, **AHRS1**, **AHRS2**, and **ATTSTBY** softkeys. These softkeys allow switching of the sensors being viewed on each PFD. With certain types of sensor failures, the system may make some sensor selections automatically. The GPS sensor cannot be switched manually.

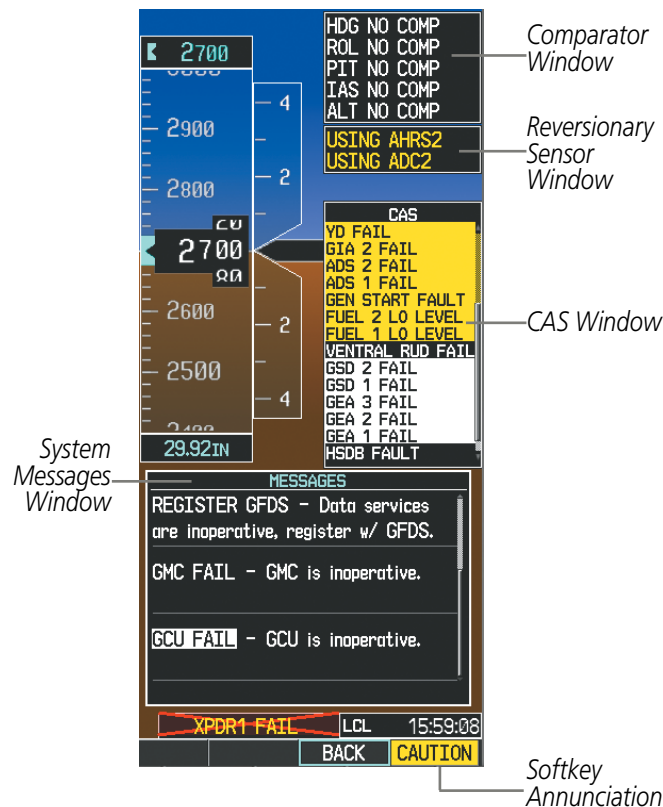

Figure 2-35 Prodigy Alerting System



## MARKER BEACON ANNUNCIATIONS

Marker Beacon Annunciations are displayed on the PFD to the left of the Selected Altitude. Outer marker reception is indicated in blue, middle in yellow, and inner in white. Refer to the Audio Panel and CNS Section for more information on Marker Beacon Annunciations.

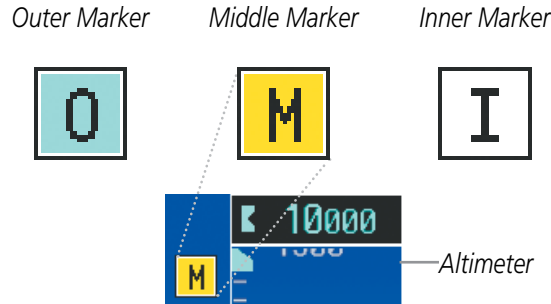

Figure 2-36 Marker Beacon Annunciations

## TRAFFIC ANNUNCIATIONS

Traffic is displayed symbolically on the Inset Map (PFD), the Navigation Map Page (MFD), and various other MFD page maps. Refer to the Hazard Avoidance Section and Appendix F for more details about the Traffic Information Service (TIS) and optional Traffic Collision Avoidance System II (TCAS II). When a Traffic Advisory (TA) or TCAS II Resolution Advisory (RA) detected, the following automatically occur:

- The PFD Inset Map is enabled, displaying traffic.
- A flashing black-on-yellow (TA) TRAFFIC annunciation or white-on red (RA) TRAFFIC annunciation appears to the top left of the Attitude Indicator for five seconds and remains displayed until no TAs or RAs are detected in the area.
- One or more aural traffic alerts is generated.
- For TCAS II installations with an active RA, vertical guidance pitch cues will appear on the Attitude Indicator and Vertical Speed Indicator; see the Hazard Avoidance Section for details about TCAS II.

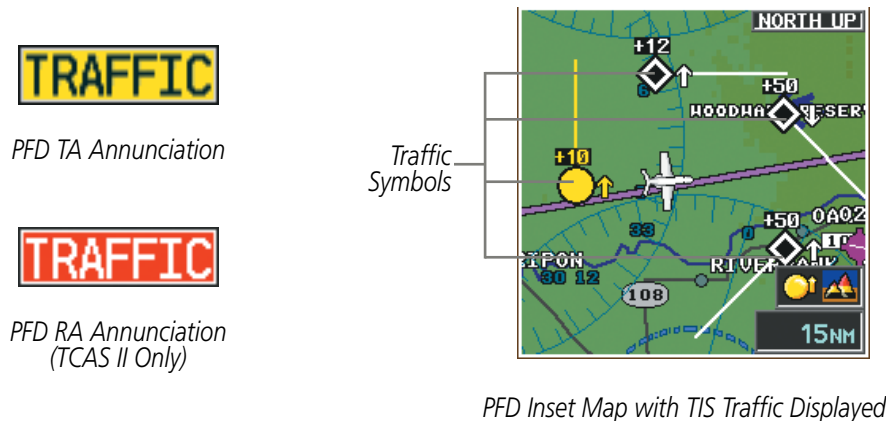

Figure 2-37 Traffic Annunciation and Inset Map with Traffic Displayed

## TAWS ANNUNCIATIONS

Terrain Awareness and Warning System (TAWS) annunciations appear on the PFD to the upper left of the Altimeter. In TAWS-A installations, additional annunciations also appear to the upper right of the Airspeed Indicator. Refer to the Hazard Avoidance Section and Appendix A for information on TAWS alerts and annunciations.



Figure 2-38 Example TAWS-A Annunciations

## ALTITUDE ALERTING

The Altitude Alerting function provides visual and audio alerts when approaching the Selected Altitude. Whenever the Selected Altitude is changed, Altitude Alerting is reset. Altitude Alerting is based on the altitude information shown on PFD1. Altitude Alerting is independent of the AFCS.

The following occur when approaching the Selected Altitude:

- Upon passing through 1000 feet of the Selected Altitude, the Selected Altitude Box changes to black text on a light blue background, flashes for five seconds, and an aural tone is generated.
- When the aircraft passes within 200 feet of the Selected Altitude, the Selected Altitude changes to light blue text on a black background and flashes for five seconds.
- After reaching the Selected Altitude, if the aircraft flies outside the deviation band ( $\pm 200$  feet of the Selected Altitude), the Selected Altitude Box changes to yellow text on a black background, flashes for five seconds. In addition, two aural tones are generated followed by an “Altitude” voice alert.



Figure 2-39 Altitude Alerting Visual Annunciations

## LOW ALTITUDE ANNUNCIATION

 **NOTE:** A Low Altitude Annunciation is available only when SBAS is available. This annunciation is not shown for systems with TAWS, unless TAWS is inhibited.

When the Final Approach Fix (FAF) is the active waypoint in a RNAV GPS approach using vertical guidance, a Low Altitude Annunciation may appear if the current aircraft altitude is at least 164 feet below the prescribed altitude at the FAF. A black-on-yellow LOW ALT annunciation appears to the top left of the altimeter, flashing for several seconds then remaining displayed until the condition is resolved.

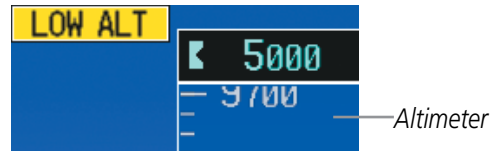

Figure 2-40 Low Altitude on GPS SBAS Approach

## MINIMUM DESCENT ALTITUDE/DECISION HEIGHT ALERTING

For altitude awareness, a Minimum Descent Altitude (MDA) or Decision Height (DH), based on barometric altitude can be set. When active, the altitude setting is displayed to the lower left of the altimeter and with a bug at the corresponding altitude along the altimeter (once the altitude is within the visible range of the tape). The following visual annunciations alert the pilot when approaching MDA or DH:

- When the aircraft altitude descends to within 2500 feet of the MDA/DH setting, the BARO MIN or RA MIN box appears with the altitude in light blue text. The bug appears on the altitude tape in light blue once in range.
- When the aircraft passes through 100 feet of the MDA/DH, the bug and text turn white.
- Once the aircraft reaches MDA/DH, the bug and text become yellow and the aural alert, “Minimums. Minimums”, is generated.

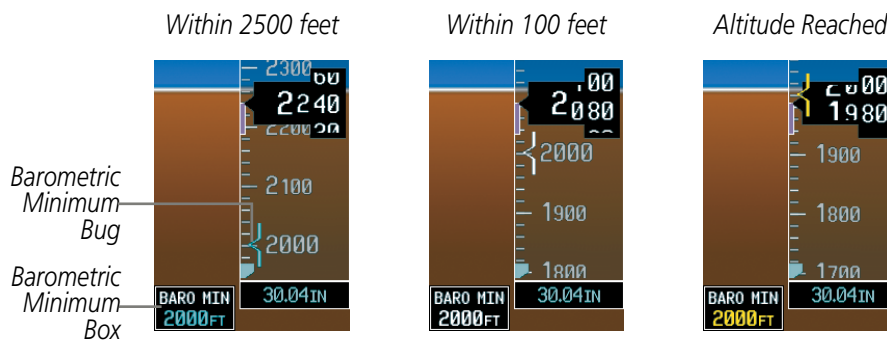

Figure 2-41 Barometric Minimum Descent Altitude/Decision Height Alerting Visual Annunciations

Alerting is inhibited while the aircraft is on the ground and until the aircraft reaches 150 feet above the setting for the alert. If the aircraft proceeds to climb after having reached the MDA/DH, once it reaches 50 feet above the MDA/DH, alerting is disabled.

The MDA/DH may be set from either PFD and is synchronized on both PFDs. The function is reset when the power is cycled or another approach is activated.

### Setting the Minimum Descent Altitude/Decision Height:

- 1) Press the **TMR/REF** Softkey.
- 2) Turn the large **FMS** Knob to highlight the Minimums field (Figure 2-42).
- 3) Turn the small **FMS** Knob to select the barometric (BARO) or radar altimeter (RAD ALT) altitude source. OFF is selected by default. Press the **ENT** Key or turn the large **FMS** Knob to highlight the next field.
- 4) Use the small **FMS** Knob to enter the desired altitude (BARO from zero to 16,000 feet, RAD ALT from zero to 2,500 feet).
- 5) To remove the window, press the **CLR** Key or press the **TMR/REF** Softkey.

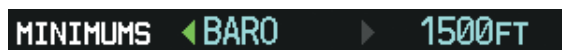

Figure 2-42 Barometric MDA/DH

## RADAR ALTIMETER

When the radar height (the aircraft altitude above ground level detected by the radar altimeter) is between zero and 2500 feet, the current value is displayed in green above the selected course box (Figure 2-43). Display of radar height becomes more sensitive as the height above ground decreases (Table 2-4).



Figure 2-43 Current Radar Height

Radar Height Range	Shown to Nearest
0 to 200 feet	5 feet
200 to 1500 feet	10 feet
1500 to 2500 feet	50 feet

Table 2-4 Radar Altimeter Sensitivity

When the radar altimeter is selected as the altitude source for the minimum descent altitude/decision height alerting function (Figure 2-44), the color of the radar height changes to yellow upon descent to or below this altitude (Figure 2-45). Refer to the Minimum Descent Altitude/Decision Height Alerting discussion in this section for more information about this function.

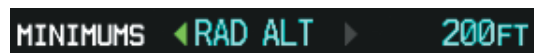

Figure 2-44 RAD ALT Setting (Timer/References Window)



Figure 2-45 RA as Altitude Source for MDA/DH

A ground line (Figure 2-46) is shown on the Altimeter to display the aircraft's height relative to the ground. If the data becomes invalid, the message "RA FAIL" is displayed in yellow in place of the current radar height (Figure 2-47).

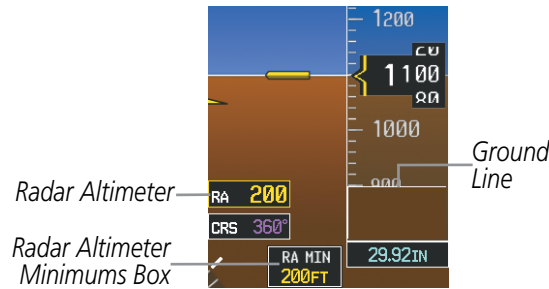

Figure 2-46 Altimeter Displaying the Ground Line (RAD ALT)

**RA FAIL**

Figure 2-47 Radar Altimeter Invalid Data

## 2.4 ABNORMAL OPERATIONS

### ALTITUDE ALERTING

Under normal conditions, the Altitude Alerting function is based on the Selected Altitude shown on PFD 1. If the MFD is operating in Reversionary Mode, the Selected Altitude shown on the MFD will be used for Altitude Alerting instead. If the MFD has also failed, then Altitude Alerting will be based on the PFD 2 Selected Altitude.

### ABNORMAL GPS CONDITIONS

The annunciations listed in the table can appear on the HSI when abnormal GPS conditions occur. Refer to the Flight Management Section for more information on Dead Reckoning Mode.

Annunciation	Location	Description
LOI	Lower left of aircraft symbol	Loss of Integrity Monitoring—GPS integrity is insufficient for the current phase of flight
INTEG OK	Lower left of aircraft symbol	Integrity OK—GPS integrity has been restored to within normal limits (annunciation displayed for five seconds)
DR	Upper right of aircraft symbol	Dead Reckoning—System is using projected position rather than GPS position to compute navigation data and sequence active flight plan waypoints

Table 2-5 Abnormal GPS Conditions Annunciated on HSI

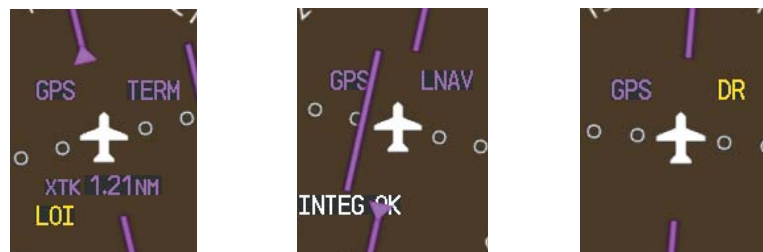

Figure 2-48 Example HSI Annunciations

In DR Mode the CDI is removed from the display when GPS is the selected navigation source. In addition, all GPS-derived data is computed based upon an estimated position and is displayed as yellow text on the display to denote degraded navigation source information. This data includes the following:

- Navigation Status Box fields except Active Leg, TAS, and DTK
- GPS Bearing Pointer
- Wind data and pointers in the Wind Data Box on the PFD
- Track Indicator
- All Bearing Pointer Distances

These items should be verified when operating in DR Mode.



- Active Flight Plan distances, bearings, and ETE values
- Groundspeed

These items should be verified when operating in Dead Reckoning Mode.

It is important to note that estimated navigation data supplied by the system in DR Mode may become increasingly unreliable and must not be used as a sole means of navigation. See the Flight Management section for more information about DR Mode

## UNUSUAL ATTITUDES

When the aircraft enters an unusual pitch attitude, red extreme pitch warning chevrons pointing toward the horizon are displayed on the Attitude Indicator, starting at 50° above and 30° below the horizon line.

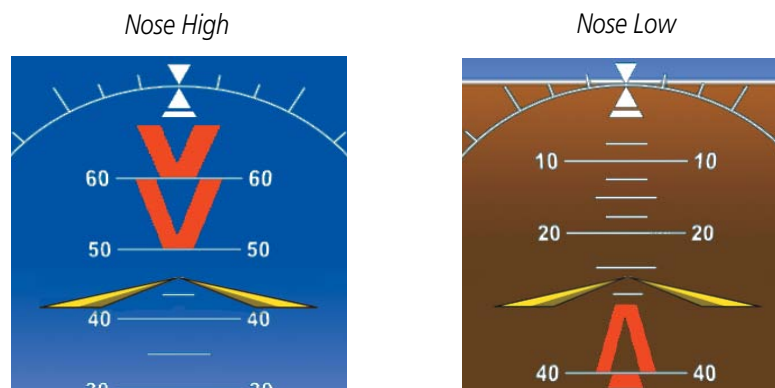

Figure 2-49 Pitch Attitude Warnings

If pitch exceeds +30°/-20° or bank exceeds 65°, some information displayed on the PFD is removed. The Altimeter and Airspeed, Attitude, Vertical Speed, and Horizontal Situation indicators remain on the display and the Bearing Information, Alerts, and Annunciation windows can be displayed during such situations. The following information is removed from the PFD (and corresponding softkeys are disabled) when the aircraft experiences unusual attitudes:

- |                                |   |  |
|--------------------------------|---|--|
| • Traffic Annunciations        | • Selected Course Box                                     | – Procedures   |
| • AFCS Annunciations           | • Transponder Status Box                                  | – ADF/DME Tuning   |
| • Flight director Command Bars | • System Time   | • Minimum Descent Altitude/ Decision Height readout        |
| • Inset Map                    | • PFD Setup Menu  | • Vertical Deviation, Glideslope, and Glidepath Indicators |
| • Total Air Temperature (TAT)  | • Windows displayed in the lower right corner of the PFD: | • Altimeter Barometric Setting                             |
| • Static Air Temperature (SAT) | – Timer/References  | • Selected Altitude  |
| • Airspeed Reference           | – Nearest Airports  | • VNV Target Altitude                                      |
| • DME Information Window       | – Flight Plan   |  |
| • Wind data                    | – Messages  |  |
| • Selected Heading Box         |   |  |

## SECTION 3 ENGINE AND AIRFRAME SYSTEMS



**NOTE:** Refer to the Airplane Flight Manual (AFM) for limitations.

The system offers improved flight operations and reduces crew workload by automatically monitoring critical system parameters and providing system alerts during all phases of flight using the following:

- The **Engine Indication System** (EIS) displays electrical, fuel, engine, pressurization, and flight control information on the left side of the Multi Function Display (MFD).
- **Synoptics pages** are provided for monitoring the status of the doors, brakes, hydraulics, oxygen, pressurization, environmental control, electrical, fuel, and de-icing systems.
- The **Crew Alerting System** (CAS) displays advisories, cautions, and warnings to communicate conditions, statuses, and system failures. CAS messages are grouped by level of importance and color-coded based on urgency and appear in a window to the right of the Altimeter on the Primary Flight displays (PFDs).

In combination with these, aural alerts, additional avionics messages, and master indicators are used to inform the crew of aberrant flight conditions. The system also provides an improved level of maintenance data for the ground crew.

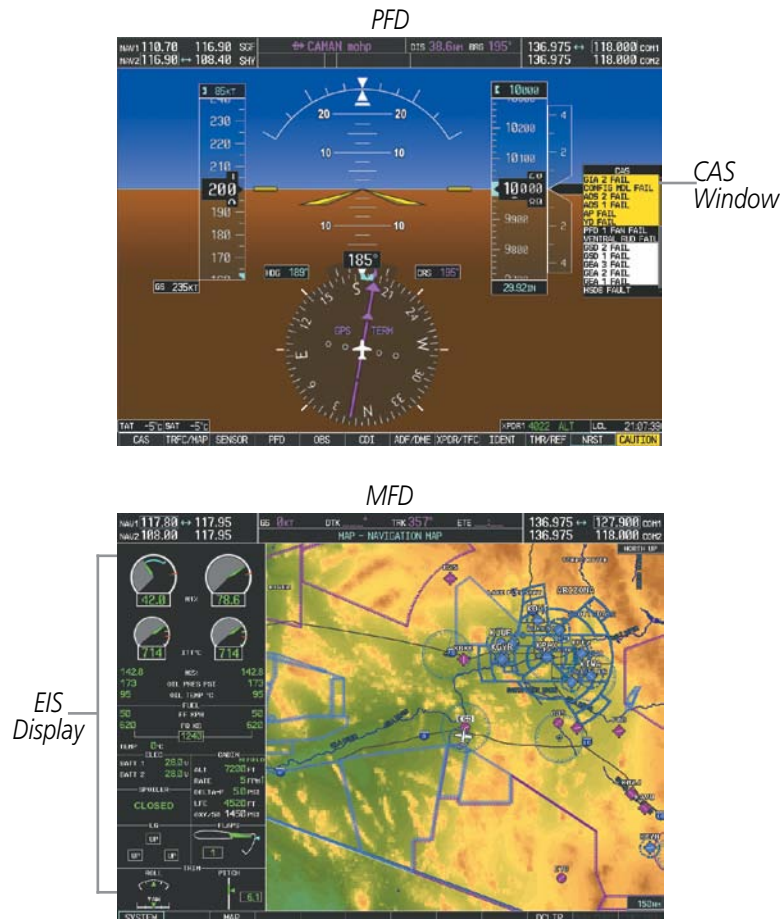

Figure 3-1 EICAS (Normal)

In the event of a display failure, depending on the failed display(s), the operating display(s) may be re-configured to present Primary Flight Display (PFD) symbology together with condensed EIS information (refer to the System Overview for more information about Reversionary Mode).



Figure 3-2 EICAS (Reversionary Mode)

The **SYSTEM** Softkey accesses the EIS softkeys. The **STATUS**, **ECS**, **ELEC**, **FUEL**, **ICEPROT**, and **ENG MNT** softkeys or the small **FMS** Knob access the Synoptic pages (see Section 3.2). To return to the previous softkey level and exit the Synoptics pages, select the **BACK** Softkey, press the **CLR** Key, or turn the large **FMS** Knob.

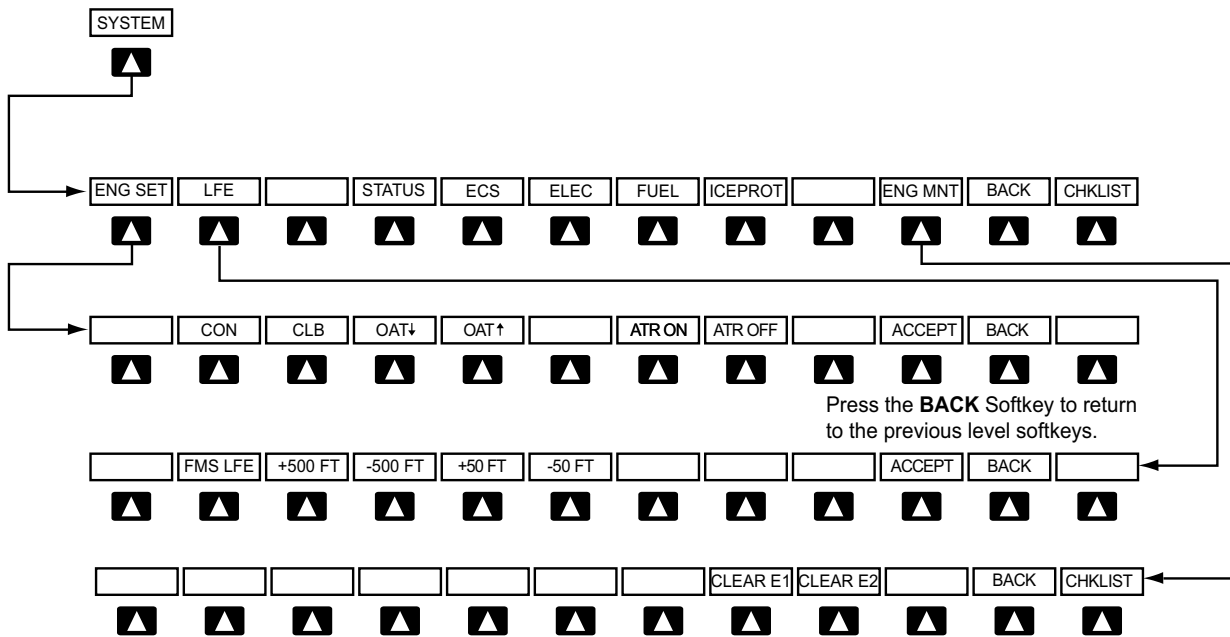

Figure 3-3 EIS and Synoptics Softkeys

- **ENG SET**      Accesses the FADEC settings softkeys; displays the Takeoff Data Set Window when aircraft is parked or taxiing
- **CON\***         Selects the continuous thrust rating
- **CLB\***         Selects the maximum climb thrust rating
- **OAT↑\*\***       Increases the takeoff outside air temperature (OAT) setting in one-degree Celsius (°C) increments
- **OAT↓\*\***       Decreases the takeoff OAT setting in one-degree Celsius (°C) increments
- **ATR ON\*\***     Enables Automatic Thrust Reserve (ATR)
- **ATR OFF\*\***    Disables ATR
- **ACCEPT\*\***    Confirms the selected takeoff settings
- **LFE**            Accesses softkeys for manually setting the Landing Field Elevation (LFE)
- **FMS LFE**      Sets current flight plan destination elevation as displayed LFE
- **+500 FT**       Increases currently displayed LFE value by 500 ft
- **-500 FT**       Decreases currently displayed LFE value by 500 ft
- **+50 FT**        Increases currently displayed LFE value by 50 ft
- **-50 FT**        Decreases currently displayed LFE value by 50 ft
- **ACCEPT**        Confirms the LFE setting and returns to the previous softkey level
- **STATUS**       Displays the Status Synoptics Page
- **ECS**            Displays the Environmental Control System (ECS) Synoptics Page
- **ELEC**          Displays the Electrical Synoptics Page
- **FUEL**          Displays the Fuel Synoptics Page
- **ICEPROT**      Displays the Ice Protection Synoptics Page
- **ENG MNT\*\*\***   Displays the Engine Maintenance Page
- **CLEAR E1\*\*\***   Clears Engine 1 exceedances and long time dispatch faults
- **CLEAR E2\*\*\***   Clears Engine 2 exceedances and long time dispatch faults

\* *Softkey disabled while aircraft is on the ground*

\*\* *Softkey disabled while aircraft is in the air*

\*\*\* *Enabled only while the aircraft is on the ground and engines are turned off*

### 3.1 ENGINE INDICATION SYSTEM (EIS)

EIS information is presented using gauges and digital readouts. During normal operating conditions, gauge pointers and readout text appear in green. When unsafe operating conditions occur, gauge pointers and readouts change color to indicate caution (yellow) or warning (red). Refer to each indicator description for additional details on display behavior.

If the time limit for an unsafe condition is exceeded, the color of the pointers and digits may change to denote an increase in priority level. Parameters out of the range of the readout display a red 'X'. If sensor data for a parameter becomes invalid or unavailable, a red "X" is displayed across the indicator and/or readout.

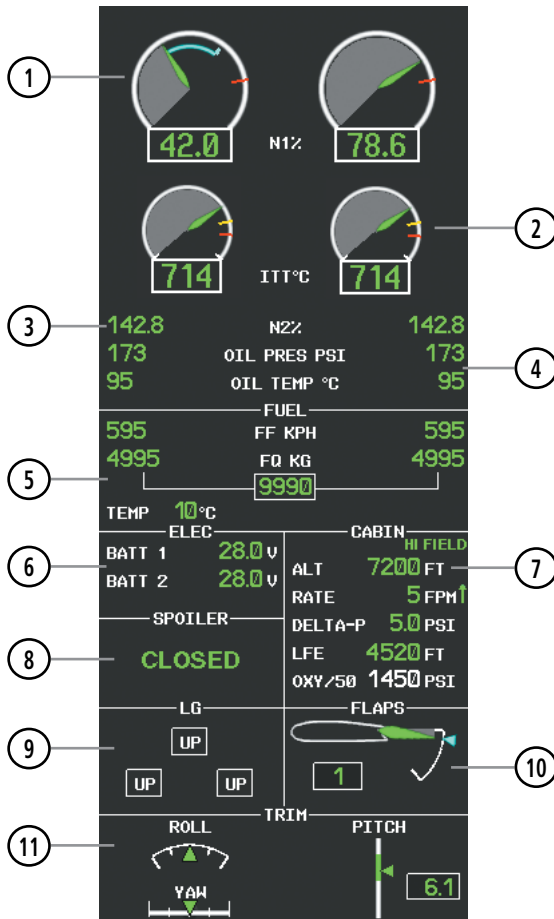

Figure 3-4 EICAS Display (Normal)

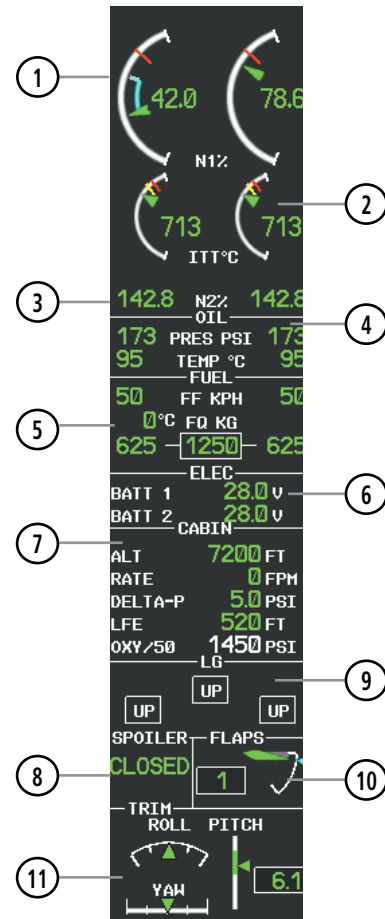

Figure 3-5 EIS Display (Reversionary)

- |  |                                |                       |
|--|--------------------------------|-----------------------|
| ① Engine Fan Rotation Speed                      | ④ Oil Pressure and Temperature | ⑧ Spoiler Status      |
| ② Interstage Turbine Temperature (ITT)           | ⑤ Fuel Display                 | ⑨ Landing Gear Status |
| ③ Engine High Pressure Compressor Rotation Speed | ⑥ Battery Voltmeter            | ⑩ Flap Indicator      |
|  | ⑦ Pressurization Display       | ⑪ Trim Indicator      |

**TAKEOFF DATA SET WINDOW**

When the aircraft is parked or is taxiing, the Outside Air Temperature (OAT) for the departure airport can be set and Automatic Thrust Reserve (ATR) enabled/disabled in the Takeoff Data Set Window.



**Figure 3-6 Takeoff Data Set Window**

**Setting the Outside Air Temperature (OAT):**

- 1) Select the **SYSTEM** Softkey.
- 2) Select the **ENG SET** Softkey to display the Takeoff Data Set Window.
- 3) To adjust the temperature in 1 °C increments, use the **OAT↑** and **OAT↓** softkeys,
- 4) If desired, change the ATR status while the Takeoff Data Set Window is displayed.
- 5) To confirm the selected takeoff settings and close the Takeoff Data Set Window, select the **ACCEPT** Softkey,

**Or:**

To cancel the operation, select the **BACK** Softkey.

On aircraft electrical power-up, Automatic Thrust Reserve (ATR) is enabled by default. ATR status (defined in Table 3-1) is shown at the top of the EIS Display (Figure 3-7).

Indication*	Description
<b>ATR</b>	ATR enabled in both engines
<b>ATR</b>	ATR armed in both engines, but inactive
<b>TO - RSV</b>	ATR activated in at least one engine
<b>GA - RSV</b>	ATR activated in at least one engine in Go-Around Mode

\* When no indication is shown, ATR has not been enabled or armed in both engines.

**Table 3-1 Automatic Thrust Reserve (ATR) Status**



**Disabling/enabling Automatic Thrust Reserve (ATR):**

- 1) Select the **SYSTEM** Softkey.
- 2) Select the **ENG SET** Softkey to display the Takeoff Data Set Window.
- 3) To disable ATR, select the **ATR OFF** Softkey;  
Or:  
To enable ATR, select the **ATR ON** Softkey.
- 4) If desired, change the OAT while the Takeoff Data Set Window is displayed.
- 5) To confirm the selected takeoff settings and close the Takeoff Data Set Window, select the **ACCEPT** Softkey,  
Or:  
To cancel the operation, select the **BACK** Softkey.

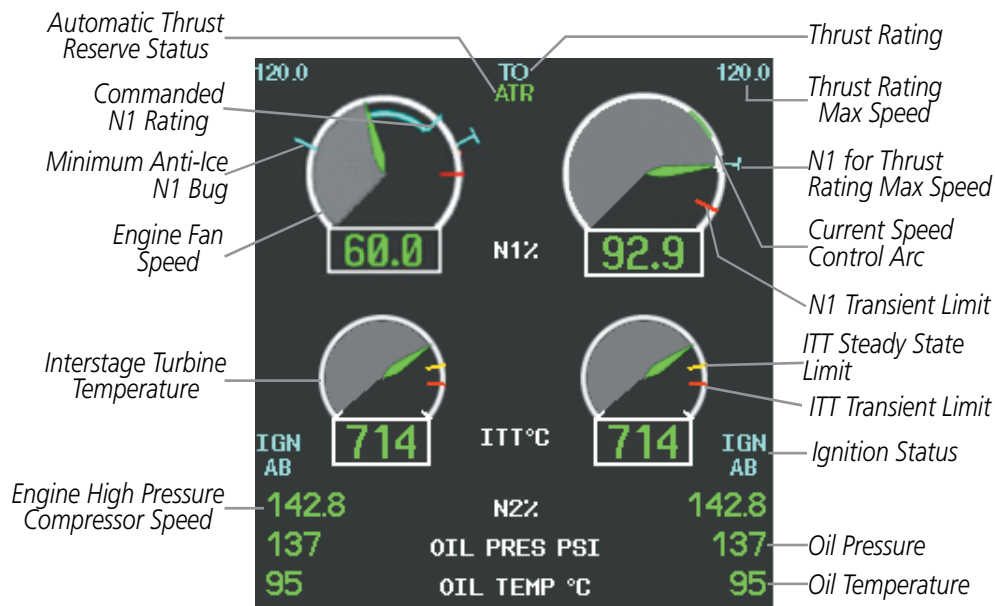
**ENGINE INDICATIONS****Figure 3-7 Engine and Oil Indications**

The upper portion of the EIS Display is devoted to showing indications for the engines: engine stage rotation speeds (N1 and N2; shown as percentages), ATR status, thrust rating information, Interstage Turbine Temperatures (ITT; degrees Celsius, °C), and oil pressure (pounds per square inch, psi) and temperature (°C).

The N1 gauges indicate the engine fan rotation speeds, while the N2 readouts show the engine high pressure compressor rotation speeds. Both are shown as percentages. Values and limits are obtained from the Full Authority Digital Engine Controller (FADEC).



On the N1 gauges, the following indications can be displayed:

- Commanded N1 Rating (based on Thrust Lever Angle, TLA, position) – When the current N1 value is below the commanded rating, a light blue arc is drawn from the current to the commanded N1 value.
- N1 value corresponding to the Thrust Rating Maximum Speed (shown as a light blue T-shaped bug)
- Current Speed Control N1 value (shown as a green arc)
- Minimum Anti-Ice N1 Bug – Indicates which N1 should be commanded for full anti-ice capacity (shown as a light blue tick mark)
- Engine shutdown (normal operations) – When the engines are shutting down normally, the N1 gauges display a light blue “OFF” annunciation (Figure 3-8).



**Figure 3-8 Engine Shutdown Indication**

Interstage Turbine Temperatures (ITT) values and limits are obtained from the Full Authority Digital Engine Control (FADEC). Ignition status appears below the ‘IGN’ label beside the ITT scales (A, B, AB, or OFF).

## THRUST RATING

The thrust rating for the engines is shown at the center top of the EIS Display, above and between the N1 gauges (see Table 3-2 for indications). The maximum value of the speed range (in kt) for the displayed thrust rating is shown above each N1 gauge. While the aircraft is in the air, the rating can be changed to suit the conditions for maximum climb or continuous thrust.

Indication	Thrust Rating
CRZ	Cruise
CLB	Max Climb
CON	Continuous
TO	Takeoff
GA	Go Around

**Table 3-2 Thrust Rating Indications**

### Selecting a thrust rating:

- 1) Select the **SYSTEM** Softkey.
- 2) Select the **ENG SET** Softkey
- 3) To choose the continuous thrust rating, select the **CON** Softkey,  
Or:  
To choose the maximum climb thrust rating, select the **CLB** Softkey.
- 4) Select the **BACK** Softkey to return to the previous softkey level.

### CURRENT SPEED CONTROL (CSC)

Current Speed Control (CSC), if available, can be activated while the autopilot is engaged and AFCS Altitude Hold Mode is active. During CSC, the FADEC varies engine thrust to maintain the desired airspeed, within a certain control range.

When CSC is active, green arcs appear on the N1 gauges, at values corresponding to the current speed selected (Figure 3-7).

The N1 gauge flashes ‘LIM’ (black text on yellow background) if the CSC maximum authority limit has been reached for the corresponding engine (Figure 3-9).



Figure 3-9 N1 Current Speed Control Limit

#### Selecting Current Speed Control (CSC):

- 1) Enter Altitude Hold Mode (see the AFCS Section for details).
- 2) Press the **CSC** Key (on the AFCS Control Unit).

### FUEL AND ELECTRICAL INDICATIONS

The fuel display is located beneath the oil indicators and shows the fuel flow in pounds per hour (pph) and the tank fuel quantity in pounds (lb) for each engine, the total fuel quantity, and the fuel tank temperature in °C. The factory can also configure the Fuel Display for metric units.

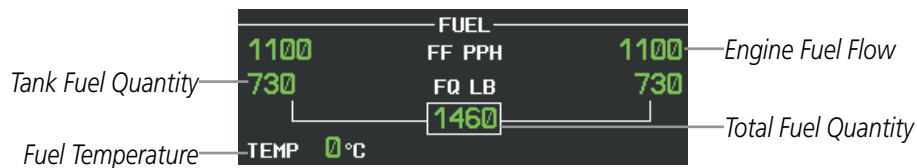

Figure 3-10 Fuel Display

Voltages for batteries 1 and 2 are shown as readouts below the fuel indications.

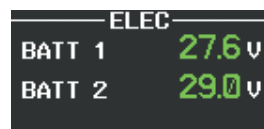

Figure 3-11 Electrical Display

## CABIN PRESSURIZATION

The Cabin Display shows cabin pressurization information (cabin altitude and rate of change, differential cabin pressure) is shown along with the Landing Field Elevation (LFE) and oxygen system pressure. The trend of cabin pressure altitude rate change is indicated by a green arrow beside the rate readout.

The LFE is set automatically based on the destination in the active flight plan by pressing the FMS LFE Softkey, but can also be adjusted manually by the pilot. Automatically entered values appear in green; if the value is entered by the pilot, it changes to light blue. Pilot-selected LFE is yellow for 30 seconds when a difference of >5 feet occurs. A red “X” is displayed if the LFE is out of range or the data source is invalid.

If the landing field elevation is high enough, the indication “HI FIELD” is shown at the top of the Cabin Display and the cabin altitude caution and warning thresholds are increased to avoid generation of nuisance alert indications.

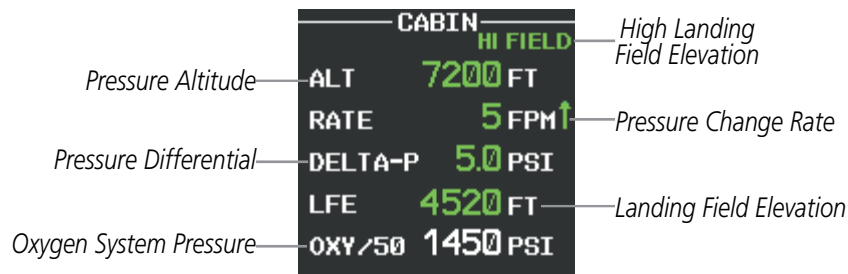

Figure 3-12 Cabin Pressure Display

### Setting the displayed landing field elevation:

- 1) Select the **SYSTEM** Softkey.
- 2) Select the **LFE** Softkey.
- 3) Select the **FMS LFE** Softkey to set the LFE to the value for the destination airport in the current flight plan.

Or:

Use the **±500** and **±50 FT** softkeys to set the desired elevation.

- 4) To confirm the new LFE value, select the **ACCEPT** Softkey.

### SPOILER AND LANDING GEAR

Spoiler and landing gear statuses are shown using the indications in Tables 3-3 and 3-4, respectively.

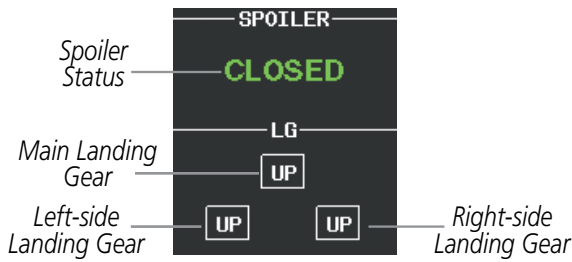

Figure 3-13 Spoiler and Landing Gear Indications

Indication	Description
	Invalid information
<b>SPDBRK</b>	Spoilers out of takeoff configuration
<b>FAIL</b>	Spoilers failed
<b>CLOSED</b>	Spoilers retracted
<b>GND SPLR</b>	Ground spoilers deployed
<b>SPDBRK</b>	Speedbrakes deployed

Table 3-3 Spoiler Indications

Indication	Description
	Landing Gear Down
	Landing Gear Up
	Landing Gear Transitioning (Normal)
	Landing Gear Locked Down (Abnormal)
	Landing Gear Locked Up (Abnormal)
	Landing Gear Transitioning (Abnormal)

Table 3-4 Landing Gear Position Indications

### FLAPS AND TRIM

Flap deflection is normally displayed beneath the trim indications using a rotating pointer and a green readout indicating the flap lever setting (0, 1, 2, 3, or FULL). A light blue bug marks the selected flap position. When the flap is in motion, the readout is dashed. If the position data becomes invalid, a red 'X' is displayed over the flap pointer.

Pitch, roll, and yaw trim indications are shown along scales at the bottom of the EIS Display. If the trim information becomes invalid, the pointers are removed and the readout (for pitch) is displayed with a red "X".

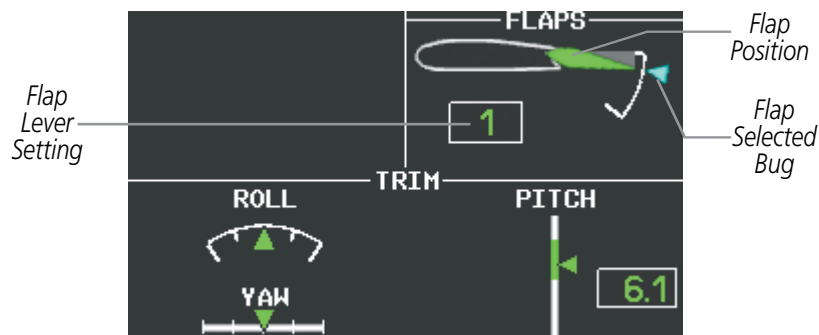

Figure 3-14 Flap and Trim Indications

### 3.2 SYNOPTICS

The Synoptics pages show current conditions of certain aircraft functionalities on aviation system diagrams, reducing workload by allowing the flight crew to rapidly analyze the situation. Aircraft systems graphically depicted in the synoptic diagrams include:

- Anti-ice system
- Brake system
- Doors
- Electrical system
- Environmental system
- Fuel system
- Hydraulics system
- Oxygen system
- Pressurization system

#### SYSTEM STATUS

The Status Synoptics Page is displayed after the power-up splash screen is acknowledged on the MFD. The aircraft diagram displays open passenger and emergency doors in red and open baggage doors in yellow.

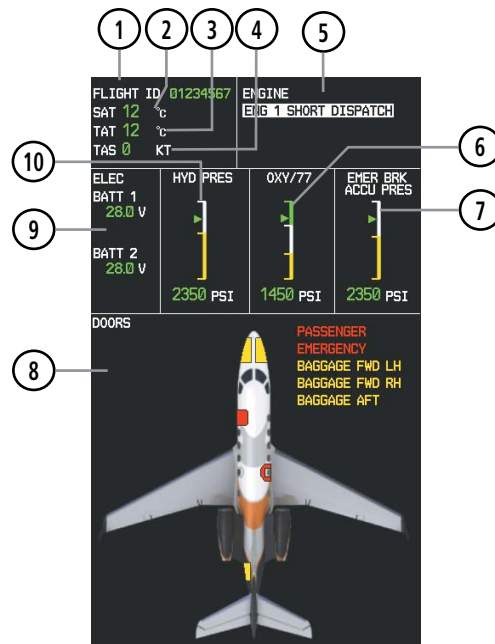

- ① Flight ID
- ② Static Air Temperature (SAT)
- ③ Total Air Temperature (TAT)
- ④ True Airspeed (TAS)
- ⑤ Engine Dispatch Message Box
- ⑥ Oxygen
- ⑦ Emergency Brake Accumulator Pressure
- ⑧ Door Status
- ⑨ Electrical Status
- ⑩ Hydraulic Pressure

Figure 3-15 System Status Synoptics Page

## ENVIRONMENTAL CONTROL SYSTEM (ECS)

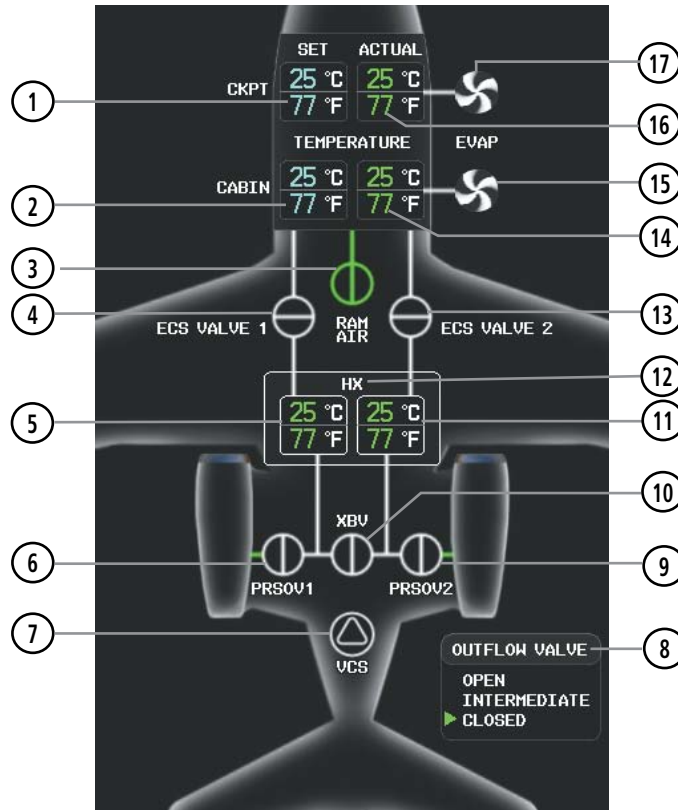













- |   |  |
|---|--|
| ① Cockpit Temperature Setting                 | ⑩ Crossbleed Valve Status (XBV)              |
| ② Cabin Temperature Setting                   | ⑪ Cabin Duct Temperature Setting             |
| ③ Ram Air Valve (RAV)                         | ⑫ Heat Exchanger Cooling Pack Circuit        |
| ④ Environmental Control System Valve (ECS) 1  | ⑬ Environmental Control System Valve (ECS) 2 |
| ⑤ Cockpit Duct Temperature Setting            | ⑭ Actual Cabin Temperature                   |
| ⑥ Pressure Regulating Shutoff Valve (PRSOV) 1 | ⑮ Cabin Evaporator Fan                       |
| ⑦ Vapor Cycle System (VCS)                    | ⑯ Actual Cockpit Temperature                 |
| ⑧ Outflow Valve (OFV) Status*                 | ⑰ Cockpit Evaporator Fan                     |
| ⑨ Pressure Regulating Shutoff Valve (PRSOV) 2 |  |

**Figure 3-16 Environmental Control System Synoptics Page**

\* Outflow valve (OFV) status is displayed only while the aircraft is parked or taxiing.

Lines between icons on the diagram denote ducting. Icons shown in green are operating normally. A white icon may indicate that a unit is off or not otherwise operating normally (see Table 3-5). A red “X” indicates failure of a unit.

Unit	Icons and Descriptions		
Fan	 On	 Off	
Heat Exchanger	 On	 Off	
Vapor Cycle System	 On	 Off	
PRSOV Valve Crossbleed Valve	 Open with flow	 Open, no flow	 Closed
ECS Valve Ram Air Valve	 Open with flow	 Open, no flow	 Closed

**Table 3-5 Environmental Control System Unit Status Indications**



## ELECTRICAL

The Electrical Synoptics Page uses a diagram of the aircraft’s electrical system to display the system status. The generators, ground power supply (GPU), batteries, and buses are shown in green to denote normal operation. Color of the units changes depending on the condition (Table 3-6). A red “X” over a component indicated invalid data or a failed unit.

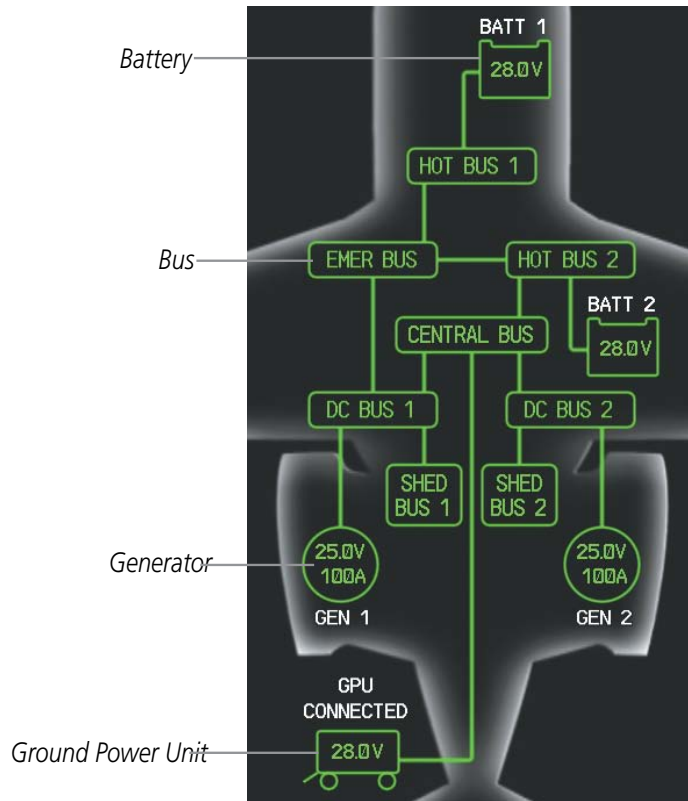

Figure 3-17 Electrical Synoptics Page

Unit	Icons and Descriptions		
Generator	N2>52%	Bus off	N2<52%
Bus	On	Bus off	
Hot Bus	Normal	Abnormal	
Battery	Normal	Abnormal	

Table 3-6 Electrical System Unit Status Indications

**FUEL**

The Fuel Synoptics Page displays the status of the fuel tanks and feed system. A red “X” over a component indicated invalid data or a failed unit.

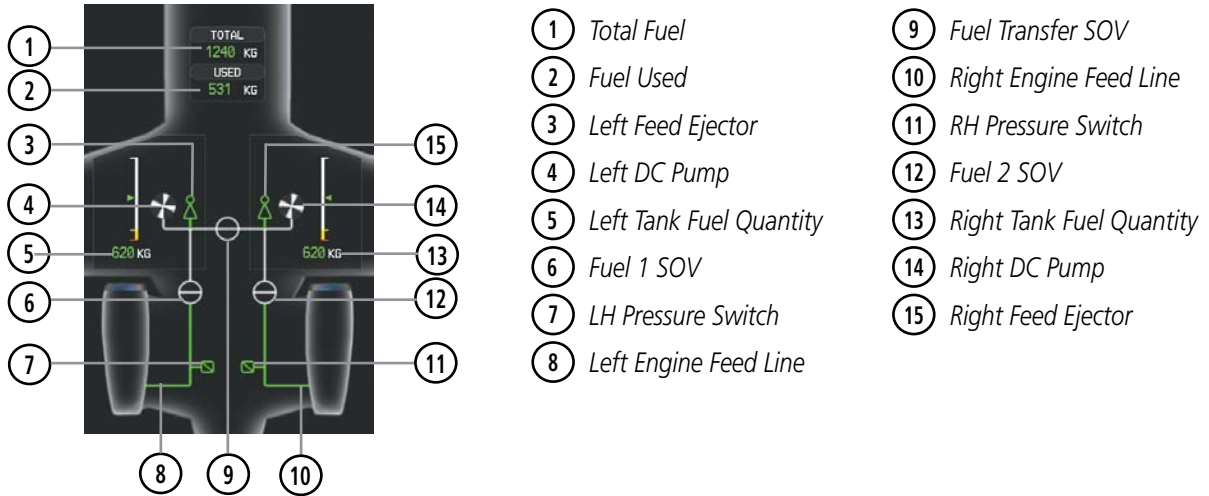

Figure 3-18 Fuel Synoptics Page

Unit	Icons and Descriptions			
Fuel Line				
	Operating	Not operating		
Feed Ejector				
	Operating	Not operating		
Fuel Pressure Switch				
	Operating	Not operating		
Fuel Shut Off Valve				
	Open with flow	Open, no flow	In transit	Closed
DC Pump				
	Operating	Not operating		
Fuel Transfer Valve				
	Open with flow	Open, no flow	In transit	Closed

Table 3-7 Fuel System Unit Status Indications





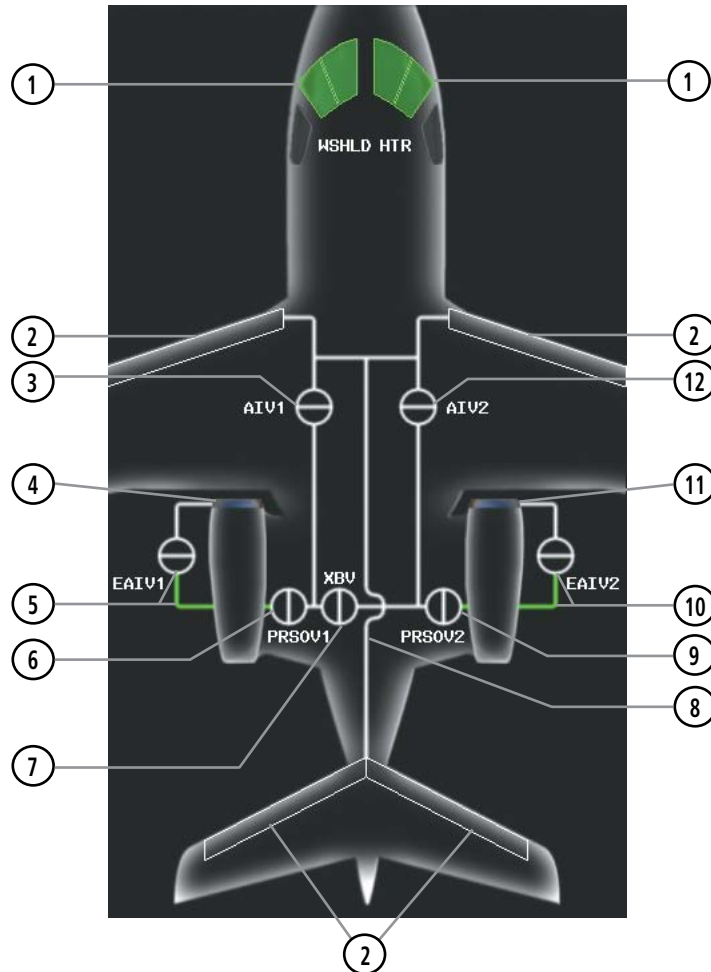



## ICE PROTECTION SYSTEM

When the ice protection system is operating normally, all components are shown in green on the system diagram. Items in white indicate components which are off. A red “X” over a component indicated invalid data or a failed unit.



- |  |  |
|--|--|
| ① Windshield Heaters                                 | ⑦ Crossbleed Valve                                   |
| ② Boot Lines and Valves                              | ⑧ Ice Protection Bleed Duct                          |
| ③ Anti Ice Valve (AIV) 1                             | ⑨ Pressure Regulating Shut-Off Valve 2 (PRSOV 2)     |
| ④ Bleed Duct and Skin 1                              | ⑩ Engine Anti Ice Valve (EAI) 2 Valve and Bleed Line |
| ⑤ Engine Anti Ice Valve (EAI) 1 Valve and Bleed Line | ⑪ Bleed Duct and Skin 2                              |
| ⑥ Pressure Regulating Shut-Off Valve 1 (PRSOV 1)     | ⑫ Anti Ice Valve (AIV) 2                             |

Figure 3-19 Ice Protection Synoptics Page

Unit	Icons and Descriptions		
Anti Ice Line			
	Operating	Not operating	
Crossbleed Valve (XBV) Pressure Regulating Shutoff Valve (PRSOV)			
	Open with flow	Open, no flow	Closed
Anti Ice Valve (AIV) Engine Anti Ice Valve (EAIV)			
	Open with flow	Open, no flow	Closed

**Table 3-8 Ice Protection System Unit Status Indications**

The Minimum Anti-Ice N1 Bug (Figure 3-20) appears as a light blue tick mark on the N1 engine gauges. It indicates which N1 should be commanded to achieve full anti-ice capability. The bug is visible when the landing gear is extended and wing anti-ice is on, or when an engine or engine bleed air is lost. If the anti-ice capacity is not fully operational, the message “A-I LO CAPACITY” appears on the Crew Alerting System (CAS).

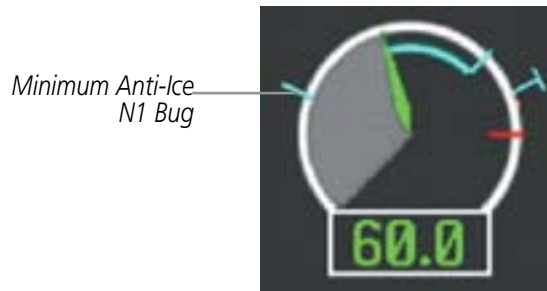

**Figure 3-20 Engine Minimum N1 Anti-Ice Indication**

## ENGINE MAINTENANCE



**NOTE:** Refer to the Airplane Flight Manual (AFM) for required actions.

The Engine Maintenance Synoptics Page can only be displayed when the aircraft is on the ground and both engines are off. Maintenance personnel can view status messages for engine dispatch items and the following engine parameter exceedance peaks and durations recorded by the FADEC for the last engine start-shutdown cycle:

- Engine fan rotation speed (N1)
- Engine high pressure compressor rotation speed (N2)
- Inter Turbine Temperature (ITT)
- Main oil temperature and Pressure
- Fuel temperature

If no peaks are detected, the values and times are displayed as dashes. The data is cleared from the display using the **CLEAR E1** and **CLEAR E2** softkeys.

The Engine Maintenance Page also displays ITT and N1 trims loaded in each Engine Data Collection Unit (EDCU).

ENGINE MAINTENANCE PAGE			
ENGINE DISPATCH			
ENG 1 NO DISPATCH	ENG 2 NO DISPATCH		
	ENG 2 LOW MARGIN		
ENG 1 FUEL FILTER BYP	ENG 2 FUEL FILTER BYP		
ENGINE 1			
	PEAK	SEC	ZONE
N1 HIGH	---	---	
N2 HIGH	---	---	
ITT HIGH	---	---	C
OIL TEMP	103	10	
OIL PRESS	26	12	C
FUEL TEMP	138	1	
ENGINE 2			
	PEAK	SEC	ZONE
N1 HIGH	---	---	
N2 HIGH	---	---	
ITT HIGH	---	---	C
OIL TEMP	103	10	
OIL PRESS	26	12	B
FUEL TEMP	138	1	
ENGINE TRIMS			
ENG1 N1	154.321	ENG2 N1	138.230
ENG1 ITT	430.012	ENG2 ITT	4.823

Figure 3-21 Engine Maintenance Synoptics Page

### 3.3 CREW ALERTING SYSTEM (CAS)

**NOTE:** Aural alerts associated with abnormal conditions and advisories are managed through the audio panels. Refer to the Audio Panel and CNS Section for more information.

When Crew Alerting System (CAS) messages are generated, the CAS Window opens to the right of the Altimeter (on the PFDs). Up to 14 messages can be displayed; when more than 14 messages accumulate, the **CAS** Softkey becomes available. Pressing the **CAS** Softkey displays softkeys for scrolling up and down through the messages in the CAS Window.

In Reversionary Mode, the **CAS** Softkey takes the place of the **INSET** Softkey.



Figure 3-22 CAS Display

### CAS MESSAGE PRIORITIZATION

**NOTE:** Information on CAS messages in this pilot's guide is always superseded by the AFM.

CAS messages are grouped by criticality (warning, caution, advisory) and sorted by order of appearance (most recent messages on top). The color of the message is based on its urgency and on required action, and the **MSG** Softkey label changes to display the appropriate annunciation when a CAS message is generated.

- **Warning** (red) – Immediate crew awareness and action required; accompanied by an aural tone (triple chime every 3 seconds) and flashing 'WARNING' softkey annunciation
- **Caution** (yellow) – Immediate crew awareness and possible future corrective action required; accompanied by an aural tone (single chime every 5 seconds) and flashing 'CAUTION' softkey annunciation
- **Advisory** (white) – Crew awareness required and subsequent action may be required; accompanied by a flashing 'ADVISORY' softkey.

The softkey annunciation flashes and the corresponding aural alert sounds until acknowledged by depressing the softkey.



Figure 3-23 Softkey Annunciations (MSG Softkey Labels)

A CAS message does not appear more than once at a given time. Warning and caution CAS messages flash when they are generated, and continue to flash until acknowledged. Advisory CAS messages, flash for 5 seconds or until acknowledged.

Some CAS messages are differentiated as root causes of other failures and should be considered first during the decision-making process when multiple CAS messages are displayed. These “golden” messages flash until acknowledged and remain in inverse video after being acknowledged manually.

After the acknowledgment, a message remains displayed at the top of its respective priority group in the CAS Window until either a newer message of the same priority appears or the condition(s) that caused the alert to display no longer exist.

CAS messages listed in tables 3-9 through 3-12 are shown in the acknowledged state (colored text on black backgrounds), with Caution and Advisory “golden” CAS messages shown in black text on colored backgrounds corresponding to their alert levels.

## CAS MESSAGES



**NOTE:** Refer to the Airplane Flight Manual (AFM) for recommended pilot actions.

### WARNING MESSAGES

Message	Description
<b>BAG SMK</b>	Smoke detected in baggage compartment
<b>CAB ALTITUDE HI</b>	Cabin altitude pressure altitude high
<b>DOOR EMER OPEN</b>	Emergency door open
<b>DOOR PAX OPEN</b>	Passenger door open
<b>E1 FIRE</b>	Fire in engine 1
<b>E2 FIRE</b>	Fire in engine 2
<b>E1 OIL LO PRES</b>	Low oil pressure in engine 1
<b>E2 OIL LO PRES</b>	Low oil pressure in engine 2
<b>ELEC EMERGENCY</b>	Generators offline
<b>ELEC XFR FAIL</b>	Generators offline and electrical emergency transfer has failed
<b>FUEL 1 LO LEVEL</b>	Low fuel level in tank 1
<b>FUEL 2 LO LEVEL</b>	Low fuel level in tank 2
<b>LG LEVER DISAG</b>	Landing gear position and control lever disagreement
<b>NO TO CONFIG</b>	No takeoff configuration

Table 3-9 Warning CAS Alerts



**CAUTION MESSAGES**

Message	Description
<b>ADS 1 FAIL</b>	ADS 1 offline or failed
<b>ADS 2 FAIL</b>	ADS 2 offline or failed
<b>ADS 1 HTR FAIL</b>	Pitot heater 1 offline or heater element failed
<b>ADS 2 HTR FAIL</b>	Pitot heater 2 offline or heater element failed
<b>AHRS 1 FAIL</b>	AHRS 1 failure
<b>AHRS 2 FAIL</b>	AHRS 2 failure
<b>A-I E1 FAIL</b>	Anti-ice system failure in engine 1
<b>A-I E2 FAIL</b>	Anti-ice system failure in engine 2
<b>A-I LO CAPACITY</b>	Not enough thermal energy available for WHSAIS (Wing and Horizontal Stabilizer Anti-ice System) operation
<b>A-I WINGSTB FAIL</b>	Component failure (AIV, pressure transducers, AMS Controller, other)
<b>A-I WINGSTB INHB</b>	WHSAIS switched ON outside the icing envelope. Or, aircraft is in single bleed configuration and above the 15,000 ft. icing envelope when WHSAIS is switched on.
<b>A-I WINGSTB LEAK</b>	Bleed hot air leakage at WHSAIS pneumatic ducting
<b>AMS CTRL FAIL</b>	Pneumatic sources and icing protection are not available
<b>ANTI-SKID FAIL</b>	Anti-skid function lost; main brake still available
<b>AP FAIL</b>	Loss of AP function
<b>AP PITCH MISTRIM</b>	Airplane mistrimmed in pitch axis when AP is engaged
<b>AP ROLL MISTRIM</b>	Airplane mistrimmed in roll axis when AP is engaged
<b>AUDIO PNL 1 FAIL</b>	Audio panel 1 is offline
<b>AUDIO PNL 2 FAIL</b>	Audio panel 2 is offline
<b>AURAL WRN FAIL</b>	Aural warning system failure due to non-communicating LRUs
<b>AUTO PTRIM FAIL</b>	Auto pitch trim failure; other pitch trim functions still available
<b>BAG SMK FAIL</b>	Baggage compartment smoke detector has failed
<b>BATT DISCHARGE</b>	Battery discharging under normal operation
<b>BATT 1 OFF BUS</b>	Battery 1 offline
<b>BATT 2 OFF BUS</b>	Battery 2 offline
<b>BATT EXCEEDANCE</b>	Battery voltage has exceeded 29 VDC
<b>BLEED 1 FAIL</b>	Bleed 1 system not under control.
<b>BLEED 2 FAIL</b>	Bleed 2 system not under control.
<b>BLEED 1 LEAK</b>	Bleed 1 hot air leakage at some region of the ducting
<b>BLEED 2 LEAK</b>	Bleed 2 hot air leakage at some region of the ducting
<b>BLEED 1 OVERPRES</b>	Pressure in bleed ducting is higher than an acceptable value chosen to not compromise ECS and Anti-ice components integrity
<b>BLEED 2 OVERPRES</b>	Pressure in bleed ducting is higher than an acceptable value chosen to not compromise ECS and Anti-ice components integrity
<b>BRK FAIL</b>	Main brake system lost
<b>CAB DELTA-P FAIL</b>	Excessive cabin pressure differential
<b>CLUTCH PIT FAIL</b>	Slip clutch maintenance test failed
<b>CLUTCH ROL FAIL</b>	Slip clutch maintenance test failed
<b>CLUTCH YAW FAIL</b>	Slip clutch maintenance test failed
<b>CONFIG MDL FAIL</b>	Master Configuration Module failed or non-communicative
<b>DOORBAG AFT OPEN</b>	Crew baggage door open
<b>DOORBAG LH OPEN</b>	Forward left-hand baggage door open
<b>DOORBAG RH OPEN</b>	Forward right-hand baggage door open
<b>DUCT 1 OVERTEMP</b>	Duct 1 temperature over specified safe value
<b>DUCT 2 OVERTEMP</b>	Duct 2 temperature over specified safe value
<b>E1 CTRL FAULT</b>	Engine 1 responds slowly or not at all to thrust commands

Message	Description
E2 CTRL FAULT	Engine 2 responds slowly or not at all to thrust commands
E1 FAIL	Uncommanded shutdown detected for engine 1
E2 FAIL	Uncommanded shutdown detected for engine 2
E1 FIRE DET FAIL	Fire detection system failure in engine 1
E2 FIRE DET FAIL	Fire detection system failure in engine 2
E1 FIREX FAIL	Fire extinguisher failure in engine 1
E2 FIREX FAIL	Fire extinguisher failure in engine 2
E1 FUEL IMP BYP	Fuel filter impending bypass condition for engine 1
E2 FUEL IMP BYP	Fuel filter impending bypass condition for engine 2
E1 TLA FAIL	Thrust Lever Angle failure for engine 1
E2 TLA FAIL	Thrust Lever Angle failure for engine 2
E1 TTO HTR FAIL	Heater failure in engine 1
E2 TTO HTR FAIL	Heater failure in engine 2
EBAY LEAK	Leak inside E-Bay
EBAY OVHT	Electrical bay over temperature
ECS 1 VALVE FAIL	Flow control valve monitor for ECS 1 detected improper valve operation
ECS 2 VALVE FAIL	Flow control valve monitor for ECS 2 detected improper valve operation
EMER BRK LO PRES	Few emergency brake functions available
EMER LT NOT ARM	Emergency lights switch not in ARMED position
ENG EXCEEDANCE	Limit exceeded in engine(s) during flight
ENG NO DISPATCH	FADEC detected no dispatch fault condition in engine(s)
ENG NO TO DATA	No takeoff data entered
FLAP FAIL	Loss of flaps deployment or retraction
FUEL 1 LO PRES	Fuel pressure low in engine 1 feed line
FUEL 2 LO PRES	Fuel pressure low in engine 2 feed line
FUEL 1 SOV FAIL	Fuel feed SOV 1 closed or unavailable
FUEL 2 SOV FAIL	Fuel feed SOV 2 closed or unavailable
FUEL IMBALANCE	Fuel is imbalanced between the tanks
FUEL XFEED FAIL	Disagreement between valve command and its feedback
GEN 1 OFF BUS	Generator 1 offline
GEN 2 OFF BUS	Generator 2 offline
GEN OVLD	Generator(s) overload
GEN START FAULT	Generator start fault
GIA 1 FAIL	Failure of GIA 1
GIA 2 FAIL	Failure of GIA 2
GIA 1 OVHT	GIA 1 over temperature
GIA 2 OVHT	GIA 2 over temperature
GND SPLR FAIL	Loss of ground spoilers
HYD HI TEMP	Hydraulic temperature high
HYD LO PRES	Hydraulic pressure low
HYD SOV 1 FAIL	EDP 1 Fire Shutoff valve was commanded to close, but failed to close
HYD SOV 2 FAIL	EDP 2 Fire Shutoff valve was commanded to close, but failed to close
ICE CONDITION*	Aircraft is flying in icing conditions
LG WOW SYS FAIL	Landing gear weight-on-wheels system failure
MFD CONFIG	MFD configuration error
MFD FAULT	Fault with the MFD
MFD OVHT	MFD over temperature
OXY LO PRES	Oxygen system pressure low

Message	Description
<b>PARK BRK NOT REL</b>	Parking brake not released
<b>PAX OXY NO PRES</b>	Cabin altitude high and passenger oxygen system pressure low
<b>PFD 1 CONFIG</b>	PFD 1 configuration error
<b>PFD 2 CONFIG</b>	PFD 2 configuration error
<b>PFD 1 FAULT</b>	Fault with PFD 1
<b>PFD 2 FAULT</b>	Fault with PFD 2
<b>PFD 1 OVHT</b>	PFD 1 over temperature
<b>PFD 2 OVHT</b>	PFD 2 over temperature
<b>PRESN AUTO FAIL</b>	Pressurization controller failure
<b>PTRIM BKP FAIL</b>	Loss of backup pitch trim actuator
<b>PTRIM NML FAIL</b>	Loss of normally-operating pitch trim actuator
<b>PUSHER FAIL</b>	Stall Warning & Protection System pusher has failed
<b>PUSHER OFF</b>	Stall Warning Pusher is off
<b>RUD OVERBOOST</b>	SLRB (Spring Loaded Rudder Booster) uncommanded actuation
<b>STBY HTR FAIL</b>	Failure of standby heater
<b>SWPS FAIL</b>	Stall Warning & Protection System inoperative
<b>SWPS FAULT</b>	Stall Warning & Protection System activation angles anticipated to conservative settings
<b>SWPS UNTESTED</b>	Stall Warning & Protection System has not been tested
<b>TCAS FAIL*</b>	Traffic & Collision Avoidance System failure. TCASII installations only.
<b>WSHLD 1 HTR FAIL</b>	Windshield 1 heater failure
<b>WSHLD 2 HTR FAIL</b>	Windshield 2 heater failure
<b>YD FAIL</b>	Loss of yaw damper function
<b>YD MISTRIM</b>	Airplane mistrimmed in yaw axis when YD is engaged
* Optional	

Table 3-10 Caution CAS Alerts

## ADVISORY MESSAGES

Message	Description
<b>A-I E1 FAULT</b>	Engine 1 Anti-ice system valve failed when commanded to close
<b>A-I E2 FAULT</b>	Engine 2 Anti-ice system valve failed when commanded to close
<b>A-I E1 ON</b>	Anti-ice system on in engine 1
<b>A-I E2 ON</b>	Anti-ice system on in engine 2
<b>A-I WINGSTB ARM</b>	WINGSTAB toggle switch has been armed prior to takeoff
<b>A-I WINGSTB ON</b>	WHSAIS is operating
<b>ADS 1 SLIP FAIL</b>	ADS 1 side-slip compensation is off
<b>ADS 2 SLIP FAIL</b>	ADS 2 side-slip compensation is off
<b>ADS HTR SW ON</b>	ADS Probe switch is on
<b>AHRS 1 FAULT</b>	Fault with AHRS 1
<b>AHRS 2 FAULT</b>	Fault with AHRS 2
<b>AMS CTRL FAULT</b>	One pneumatic and Anti-ice controller channel is inoperative
<b>AUDIO PNL 1 FAULT</b>	Fault with audio panel 1
<b>AUDIO PNL 2 FAULT</b>	Fault with audio panel 2
<b>AURAL WRN FAULT</b>	Partial loss of aural warning function
<b>AVNX FAN FAIL</b>	Avionics fan failure
<b>BAG SMK FAULT</b>	Two baggage compartment smoke detectors have failed
<b>BLEED 1 OFF</b>	Bleed pressure regulator 1 and shut-off valve closed

Message	Description
<b>BLEED 2 OFF</b>	Bleed pressure regulator 2 and shut-off valve closed
<b>BRK CTRL 1 FAIL *</b>	Brake control channel #1 is not available (failed or powered off)
<b>BRK CTRL 2 FAIL *</b>	Brake control channel #2 is not available (failed or powered off)
<b>BRK FAULT*</b>	Active channel of brake control system has failure(s) which reduce safety margins without adversely affect the aircraft operation. Non-dispatchable.
<b>CLUTCH PIT PASS</b>	Pitch slip clutch maintenance test passed
<b>CLUTCH PIT PROG</b>	Pitch slip clutch maintenance test in progress
<b>CLUTCH ROLL PASS</b>	Roll slip clutch maintenance test passed
<b>CLUTCH ROLL PROG</b>	Roll slip clutch maintenance test in progress
<b>CLUTCH YAW PASS</b>	Yaw slip clutch maintenance test passed
<b>CLUTCH YAW PROG</b>	Yaw slip clutch maintenance test in progress
<b>DC BUS 1 OFF</b>	DC bus 1 offline
<b>DC BUS 2 OFF</b>	DC bus 2 offline
<b>DOOR REFUEL OPEN</b>	Refueling door is open
<b>E1 CHIP DETECTED</b>	Chip detected by engine 1 oil chip detector
<b>E2 CHIP DETECTED</b>	Chip detected by engine 2 oil chip detector
<b>E1 FADEC FAULT</b>	FADEC fault in engine 1
<b>E2 FADEC FAULT</b>	FADEC fault in engine 2
<b>E1 OIL IMP BYP</b>	Engine 1 oil filter impending bypass set
<b>E2 OIL IMP BYP</b>	Engine 2 oil filter impending bypass set
<b>ECS 1 OFF</b>	Flow control valve monitor detected improper valve operation
<b>ECS 2 OFF</b>	Flow control valve monitor detected improper valve operation
<b>ELEC SYS FAULT</b>	Electrical system fault
<b>EMER BUS OFF</b>	Emergency bus OFF
<b>ENG FIREX DISCH</b>	Engine fire extinguisher discharge
<b>FLAP NOT AVAIL</b>	Flaps not available
<b>FUEL EQUAL</b>	Fuel quantity asymmetry corrected; XFEED SOV is open
<b>FUEL 1 FEED FAULT</b>	DC pump on due to low fuel pressure
<b>FUEL 2 FEED FAULT</b>	DC pump on due to low fuel pressure
<b>FUEL 1 PSW FAIL</b>	Fuel pressure switch stuck in "high" position
<b>FUEL 2 PSW FAIL</b>	Fuel pressure switch stuck in "high" position
<b>FUEL PUMP 1 FAIL</b>	Fuel pump 1 failure
<b>FUEL PUMP 2 FAIL</b>	Fuel pump 2 failure
<b>GEA 1 FAIL</b>	Failure of GEA 1
<b>GEA 2 FAIL</b>	Failure of GEA 2
<b>GEA 3 FAIL</b>	Failure of GEA 3
<b>GPU CONNECTED</b>	Ground power unit connected to the aircraft
<b>GSD 1 FAIL</b>	GSD 1 non-communicative
<b>GSD 2 FAIL</b>	GSD 2 non-communicative
<b>HSDB FAULT</b>	An LRU has stopped communicating over an HSDB
<b>HSDB SW REV POS</b>	HSDB switch in reversionary position
<b>HYD SYS FAULT</b>	Degradation of hydraulic system available power
<b>ICE DET FAIL *</b>	Ice Detector failure
<b>MFD FAN FAIL</b>	Failure of MFD fan
<b>OXY SW NOT AUTO</b>	Oxygen system switch in manual mode
<b>PFD 1 FAN FAIL</b>	Failure of PFD 1 fan
<b>PFD 2 FAN FAIL</b>	Failure of PFD 2 fan
<b>PTRIM LO RATE</b>	Pitch trim is being actuated in low rate

Message	Description
PTRIM SW1 FAIL	Failure of pilot pitch trim switch
PTRIM SW2 FAIL	Failure of copilot pitch trim switch
RALT FAIL*	Radar altimeter failure
RAM AIR FAIL	Ram air valve failure
RUD BOOST FAIL	Loss of SLRB (Spring Loaded Rudder Booster) force assistance in case of thrust asymmetry
SHED BUS OFF	Shed bus off
SPDBRK SW DISAG	Speed brake switch position is in disagreement with the spoiler surfaces position
SPOILER FAULT	Loss of roll spoilers and/or speed brake functions
SWPS ICE SPEED	Stall Warning System activation angles anticipated due to icing conditions
VENTRAL RUD FAIL	Ventral rudder has failed
XBLEED FAIL	Cross bleed valve has failed closed or open
XBLEED SW OFF	Cross bleed switch is in the OFF position
* Optional	

Table 3-11 Advisory CAS Alerts

### CAS AURAL ALERTS

Message	Priority	Description
"Autopilot"	Warning	Warning – Autopilot is disengaged Single alert for manual AP disengagement Continuous alert for automatic AP disengagement; cancelled with <b>AP DISC</b> Switch
"Cabin"		High cabin altitude
"Fire, Fire"		Engine fire
"Flight Director"		Flight director has reverted to pitch or roll default mode
"High Speed"		Maximum operating speed exceeded
"Landing Gear"		Gear up in landing condition
"Minimums, minimums"		The aircraft has descended below the preset barometric minimum descent altitude.
"No Takeoff Brake"		No Takeoff Configuration due to brake status
"No Takeoff Flaps"		No Takeoff Configuration due to flap status
"No Takeoff Spoilers"		No Takeoff Configuration due to spoiler status
"No Takeoff Trim"		No Takeoff Configuration due to trim status
"Rudder Overboost"		Rudder booster system uncommanded actuation
"Stall, Stall"		Airplane in stall condition
"Timer Expired"		Countdown timer on the PFD has reached zero
"Thrust Thrust"		CSC disengaged abnormally
"Altitude"	Advisory	Aircraft has deviated $\pm 200$ feet of the selected altitude
"Traffic"		The Traffic Information Service (TIS) has issued a Traffic Advisory alert.
"Trim Trim Trim"		Trim switch malfunction
"Vertical track"	The aircraft is one minute from Top of Descent. Issued only when vertical navigation is enabled.	
"Aural Warning OK"	Status	Aural warning system test passes
"Aural Warning One Channel"		Aural warning system test detects failure in one channel
"Incoming Call"		Satellite telephone is receiving a call
"SelCal"		Incoming communication through the HF radio
"Takeoff OK"		Takeoff configuration test passed
"TIS not available"		The aircraft is outside the Traffic Information Service (TIS) coverage area.

Table 3-12 CAS Aural Alerts

## 3.4 ABNORMAL OPERATIONS



**NOTE:** Refer to the Airplane Flight Manual (AFM) for corrective pilot actions.

### ENGINE

When an engine failure occurs, besides the CAS message corresponding to the failed engine (“E1 FAIL” or “E2 FAIL”), the corresponding N1 gauge displays the annunciation “FAIL” in black text over a yellow background (Figure 3-24). Detection of an engine fire causes a CAS message corresponding to the engine on fire (“E1 FIRE” or “E2 FIRE”) in addition to the “FIRE” annunciation to be displayed over the ITT gauge in white text over a red background (Figure 3-25).



Figure 3-24 Engine Failure Indication



Figure 3-25 Engine Fire Indication

### CABIN PRESSURIZATION

If the cabin altitude (ALT) reaches a caution level, the readout displays black text on a yellow background. When a high cabin altitude warning occurs, the readout is displayed with white text on a red background, and the corresponding CAS message “CAB ALTITUDE HI” is issued.

A cabin pressure change rate (RATE) caution readout is indicated with black text on a yellow background. If low flow or a cabin leak is detected, the cabin pressure change rate readout displays white text on a red background and the trend arrow becomes red (Figure 3-26).

Excessive cabin differential pressure (DELTA-P) causes the pressure readout to display a yellow background and black text; warnings are indicated with red background with white readout text. The CAS message “CAB DELTA-P FAIL” accompanies this condition.

Low oxygen system pressure (OXY) is indicated by a yellow background and black text. The CAS message “OXY LO PRES” is also issued.

If the pilot selected landing field elevation (LFE) differs by more than five feet from the FMS LFE value, the LFE readout is shown as black text with a yellow background for 30 seconds.

A red “X” is displayed in place of any readout on the Cabin Display that is invalid or out of range.

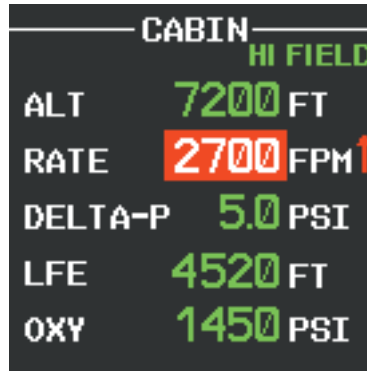

Figure 3-26 Cabin Display with Leak Detected

## FLAPS

The following denote abnormal flap conditions:

- Flaps not in position for takeoff – Flap pointer and readout are shown in red with white text (Figures 3-27 and 3-28).
- Flaps have failed or become jammed – Flap pointer and readout are shown in yellow with black text (Figure 3-29)
- Flaps unavailable – Flap pointer is removed and readout is shown in light blue with black text (Figure 3-30)
- Flaps position data invalid – Flap pointer and readout displayed with a red “X”



Figure 3-27 Flaps Retracted at Takeoff



Figure 3-28 Flaps at FULL (Landing) Position at Takeoff

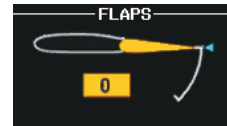

Figure 3-29 Flaps Failed



Figure 3-30 Flaps Unavailable

## TRIM

Aileron or rudder mistrim are denoted with yellow arrows pointing in the direction of mistrim on the Roll and Yaw Trim indicators (Figure 3-31).

If takeoff configuration has been selected and the pitch trim position is not within the green band on the pitch trim scale, the pointer and readout turn red with white text (Figure 3-32).



Figure 3-31 Mistrim



Figure 3-32 Pitch Trim Outside Takeoff Configuration



**BLANK PAGE**

## SECTION 4 AUDIO PANEL AND CNS

### 4.1 OVERVIEW

The Communication/Navigation/Surveillance (CNS) system includes the Audio Panels, communication radios, navigation radios, and Mode S transponders. The System Overview Section provides a block diagram description of the Audio Panels and CNS system interconnection.

CNS operation in the Embraer Phenom 300 is performed by the following Line Replaceable Units (LRUs):

- Primary Flight Display (PFD) (2)
- Multi Function Display (MFD)
- Integrated Avionics Unit (2)
- Audio Panel (2)
- Mode S Transponder (2)  
or TCAS II Mode S Transponder
- Control Unit

The MFD/PFD controls are used to tune the communication transceivers and navigation radios.

The two Audio Panels provide the traditional audio selector functions of microphone and receiver audio selection. Each Audio Panel includes an intercom system (ICS) between the pilot, copilot, and passengers, a marker beacon receiver, and a COM clearance recorder. Ambient noise from the aircraft radios is reduced by a feature called Master Avionics Squelch (MASQ). When no audio is detected, MASQ processing further reduces the amount of background noise from the radios.

The Mode S Transponders are controlled with softkeys and the **FMS** Knob located on the PFD. The Transponder Data Box is located to the left of the System Time Box. The data box displays the active four-digit code, mode, and a reply status (Figure 4-1).

### AUDIO PANEL VOLUME CONTROL

Adjusting the master volume control affects all radio audio volume and airframe type warnings that are heard in the headsets (not the speaker) for the pilot or copilot side Audio Panel. Radio adjustments made on the MFD/PFD controls to compensate for the master volume change on the Audio Panel, also affect the radio levels for the other pilot. Independent radio volume adjustments made using the Audio Panel Master Volume controls affect only the audio heard in the corresponding crew position headset.

Radio volume adjustments may be overridden by each crew position independently using the master volume control on the Audio Panel for the respective crew position. In addition, the master volume control for each Audio Panel affects all other system audio output to its designated crew position headset much like volume adjustments found on many aviation headsets.

MFD/PFD CONTROLS AND FREQUENCY DISPLAY



Figure 4-1 MFD/PFD Controls, COM/NAV Frequency Tuning Boxes, and ADF/DME Tuning

- ① **NAV VOL/ID Knob** – Controls NAV audio volume level. Press to turn the Morse code identifier audio on and off. Volume level is shown in the NAV frequency field as a percentage.
- ② **NAV Frequency Transfer Key** – Transfers the standby and active NAV frequencies.
- ③ **NAV Knob** – Tunes the standby frequencies for the NAV receiver (large knob for MHz; small knob for kHz). Press to move the tuning box (light blue box) and Frequency Transfer Arrow between NAV1 and NAV2.
- ④ **NAV Frequency Box** – Displays NAV standby and active frequency fields, volume, and station ID. The frequency of the NAV radio selected for navigation is displayed in green.
- ⑤ **COM Frequency Box** – Displays COM standby and active frequency fields and volume. The selected COM transceiver frequency is displayed in green.
- ⑥ **COM Knob** – Tunes the standby frequencies for the COM transceiver (large knob for MHz; small knob for kHz). Press to move the tuning box (light blue box) and Frequency Transfer Arrow between COM1 and COM2.
- ⑦ **COM Frequency Transfer Key** – Transfers the standby and active COM frequencies. Press and hold this key for two seconds to tune the emergency frequency (121.500 MHz) automatically into the active frequency field.
- ⑧ **COM VOL/SQ Knob** – Controls COM audio volume level. Press to turn the COM automatic squelch on and off. Volume level is shown in the COM frequency field as a percentage.
- ⑨ **ADF/DME Tuning Window** – Displays ADF frequencies, volume setting, and modes, and DME tuning selection. Display by selecting the **ADF/DME** Softkey.
- ⑩ **ENT Key** – Validates or confirms an ADF frequency or ADF/DME mode and Auto-tune selection.
- ⑪ **FMS Knob** – Flight Management System Knob, used to enter ADF frequencies and select ADF/DME modes, enter transponder codes, and Auto-tune entries when ADF/DME Tuning Window or NRST Window is present. Press the **FMS** Knob to turn the selection cursor on and off. The large knob moves the cursor in the window. The small knob selects individual characters for the highlighted cursor location.
- ⑫ **Transponder Data Box** – Indicates the selected transponder code, operating mode, reply, and ident status for the applicable transponder.

## AUDIO PANEL CONTROLS

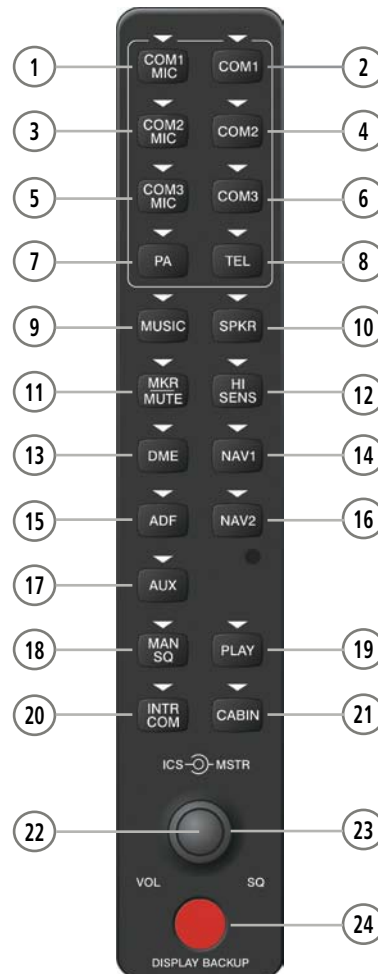

Figure 4-2 Audio Panel Controls



**NOTE:** When a key is selected, a triangular annunciator above the key is illuminated.

- ① **COM1 MIC** – Selects the #1 transmitter for transmitting. COM1 receive is simultaneously selected when this key is pressed allowing received audio from the #1 COM receiver to be heard. COM2 receive can be added by pressing the **COM2** Key.
- ② **COM1** – When selected, audio from the #1 COM receiver can be heard.
- ③ **COM2 MIC** – Selects the #2 transmitter for transmitting. COM2 receive is simultaneously selected when this key is pressed allowing received audio from the #2 COM receiver to be heard. COM1 receive can be added by pressing the **COM1** Key.
- ④ **COM2** – When selected, audio from the #2 COM receiver can be heard.
- ⑤ **COM3 MIC** – Selects the #3 transmitter (HF), if installed, for transmitting. COM3 receive is simultaneously selected when this key is pressed allowing received audio from the #3 COM receiver to be heard.

- ⑥ **COM3** – When selected, audio from the #3 COM receiver (HF), if installed, can be heard.
- ⑦ **PA** – Selects the passenger address system. The selected COM transmitter is deselected when the **PA** Key is pressed.
- ⑧ **TEL** – When selected, activates the SATCOM transceiver.
- ⑨ **MUSIC** – Toggles the Music 1 input on or off. Pressing and holding toggles music muting on or off.
- ⑩ **SPKR** – Selects and deselects the on-side cockpit speaker. COM and NAV receiver audio can be heard on the speaker.
- ⑪ **MKR/MUTE** – Selects marker beacon receiver audio. Mutes the currently received marker beacon receiver audio. Unmutes automatically when new marker beacon audio is received.
- ⑫ **HI SENS** – Press to increase marker beacon receiver sensitivity. Press again to return to low sensitivity.
- ⑬ **DME** – Turns optional DME 1 audio on or off.
- ⑭ **NAV1** – When selected, audio from the #1 NAV receiver can be heard.
- ⑮ **ADF** – Pressing turns on or off the audio from the ADF receiver, if installed.
- ⑯ **NAV2** – When selected, audio from the #2 NAV receiver can be heard.
- ⑰ **AUX** – Turns optional DME 2 audio on or off..
- ⑱ **MAN SQ** – Enables manual squelch for the intercom. When the intercom is active, press the **ICS** Knob to illuminate SQ. Turn the **ICS** Knob to adjust squelch.
- ⑲ **PLAY** – Press once to play the last recorded COM audio. Press again to stop playing. Press twice within 0.5 second while audio is playing and the previous block of recorded audio is played. Each subsequent two presses within 0.5 second plays each previously recorded block.
- ⑳ **INTR COM** – Selects and deselects the pilot/copilot intercom on both Audio Panels.
- ㉑ **CABIN** – Initiates intercom communications with passengers in the cabin.
- ㉒ **ICS Knob** – Turn to adjust intercom volume or squelch. Press to switch between volume and squelch control as indicated by illumination of VOL or SQ. The **MAN SQ** Key must be selected to allow squelch adjustment.
- ㉓ **MSTR Knob** – The Master Volume Control adjusts volume for the blended NAV, COM, intercom audio, and alert warnings.
- ㉔ **DISPLAY BACKUP Button** – Manually selects Reversionary Mode.

### CONTROL UNIT

The Control Unit (GCU 477) is a pedestal-mounted interface allowing MFD operation, data entry, COM and NAV tuning, and transponder control. Many procedures can be performed using the Control Unit rather than the MFD/PFD display bezel controls. Annunciators beside the **FMS**, **XPDR**, **COM**, and **NAV** keys illuminate when their respective control modes are selected. The unit is in FMS control mode by default on system power-up.

The appropriate frequency box on the selected display is outlined by a light blue selection box, which flashes for a few seconds to indicate control unit activity. Selection of a different display control or radio tuning mode results in cancelation of the previous radio tuning mode.



Figure 4-3 MFD/PFD Control Unit

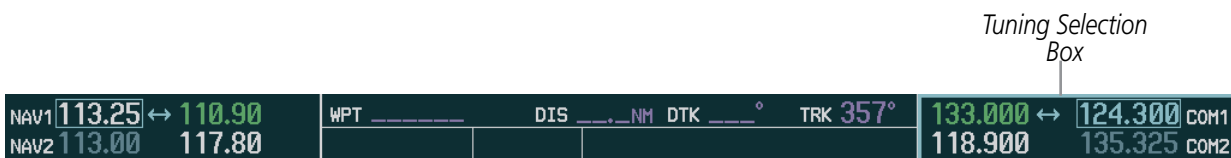

Figure 4-4 Frequency Tuning with the Control Unit



- ① **CLR Key** – Erases information, cancels entries, or removes menus.
- ② **MENU Key** – Displays a list of options for accessing additional features or making setting changes.
- ③ **ENT Key** – Validates or confirms a menu selection or data entry.
- ④ **FMS Knob** – Flight Management System Knob. The **FMS** Knob is used to enter transponder codes, select DME modes, and Auto-tune entries when NRST Window is present. The large knob moves the cursor in the window. The small knob selects individual characters for the highlighted cursor location.
- ⑤ **FMS Key** – Places Control Unit in Flight Management System (FMS) Mode.
- ⑥ **COM Key** – Selects COM radio tuning mode on the Control Unit. The COM Tuning Selection Box is outlined with a light blue line when the COM frequency is active on the control unit (Figure 4-4). Subsequent presses of the **COM** Key switches between COM 1 and COM 2.
- ⑦ **Frequency Transfer Key (EMERG)** – Transfers the standby and active COM or NAV frequencies. Press and hold for two seconds to tune the emergency frequency (121.500 MHz) automatically into the COM active frequency field.
- ⑧ **NAV Key** – Selects NAV radio tuning mode on the Control Unit. The NAV Tuning Selection Box is outlined with a light blue line when the NAV frequency is active on the control unit. Subsequent presses of the **NAV** Key switches between NAV 1 and NAV 2.
- ⑨ **XPDR Key** – Places Control Unit in Transponder Mode. Transponder code entry can be performed with either the number keypad or **FMS** Knob.
- ⑩ **IDENT Key** – When the **IDENT** Key is pressed, a green IDNT indication is displayed in the mode field of the Transponder Data Box for 18 seconds.
- ⑪ **SEL Key** – Arrows move light blue Softkey Selection Box on selected display. Press the center to activate the selected softkey
- ⑫ **Decimal Key** – Enters a decimal point.
- ⑬ **BKSP Key** – Moves cursor back one character space and removes last character entered.
- ⑭ **Alphanumeric Keys** – Allows data entry (rather than using the **FMS** Knob to select characters/numbers).

## 4.2 COM OPERATION

### COM TRANSCEIVER SELECTION AND ACTIVATION

- NOTE:** During PA Mode, the COM MIC Annunciator is extinguished and the COM active frequency color changes to white, indicating that neither COM transmitter is active.
- NOTE:** When turning on the system for use, the system remembers the last frequencies used and the active COM transceiver state prior to shutdown.

The COM Frequency Box is composed of four fields; the two active frequencies are on the left side and the two standby frequencies are on the right. The COM transceiver is selected for transmitting by pressing the **COM MIC** Keys on the Audio Panel.

An active COM frequency displayed in green indicates that the COM transceiver is selected on the Audio Panel (**COM1 MIC** or **COM2 MIC** Key). When the **PA** Key is selected on the Audio Panel, both active COM frequencies appear in white indicating that no COM radio is selected for transmitting. Frequencies in the standby fields are displayed in white.

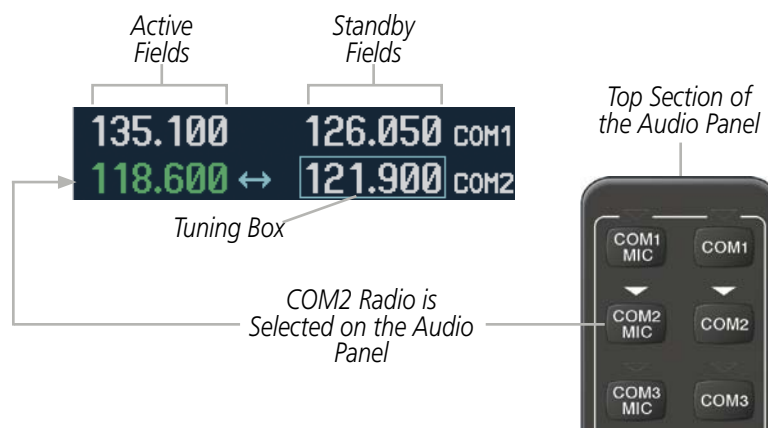

Figure 4-5 Selecting a COM Radio for Transmit

COM3 is reserved for the optional HF radio. The active HF frequency is not shown on the system.

The active COM frequency displayed in green on the MFD is the same as on PFD1.

**TRANSMIT/RECEIVE INDICATIONS**

During COM transmission, a white TX appears by the active COM frequency replacing the Frequency Transfer Arrow. On the Audio Panel, when the active COM is transmitting, the active transceiver **COM MIC** Key Annunciator flashes approximately once per second.

During COM signal reception, a white RX appears by the active COM frequency replacing the Frequency Transfer Arrow.



**Figure 4-6 COM Radio Transmit and Receive Indications**

When the same COM radio is selected on both Audio Panels, the pilot has transmit priority on COM1, the copilot has transmit priority on COM2.

**COM TRANSCIVER MANUAL TUNING**

The COM frequency controls and frequency boxes are on the right side of each PFD and the MFD. The MFD frequency controls and displays are linked to the pilot side PFD (PFD1) only.

**Manually tuning a COM frequency:**

- 1) Turn the **COM** Knob to tune the desired frequency in the COM Tuning Box (large knob for MHz; small knob for kHz).
- 2) Press the **Frequency Transfer** Key to transfer the frequency to the active field.
- 3) Adjust the volume level with the COM **VOL/SQ** Knob.
- 4) Press the COM **VOL/SQ** Knob to turn automatic squelch on and off.



**Figure 4-7 COM Frequency Tuning**

**Manual COM frequency tuning from the Control Unit**

- 1) Press the **COM** Key to select the COM Tuning Selection Box.
- 2) Press the numeric keys on the keypad to enter a Frequency.
- 3) Press the **Frequency Transfer** Key to transfer the frequency to the active field.

If an error is made during frequency entry with the numeric keypad, pressing the **BKSP** Key moves the cursor back one space. If an incorrect frequency is entered, reenter the correct one using the same procedure.

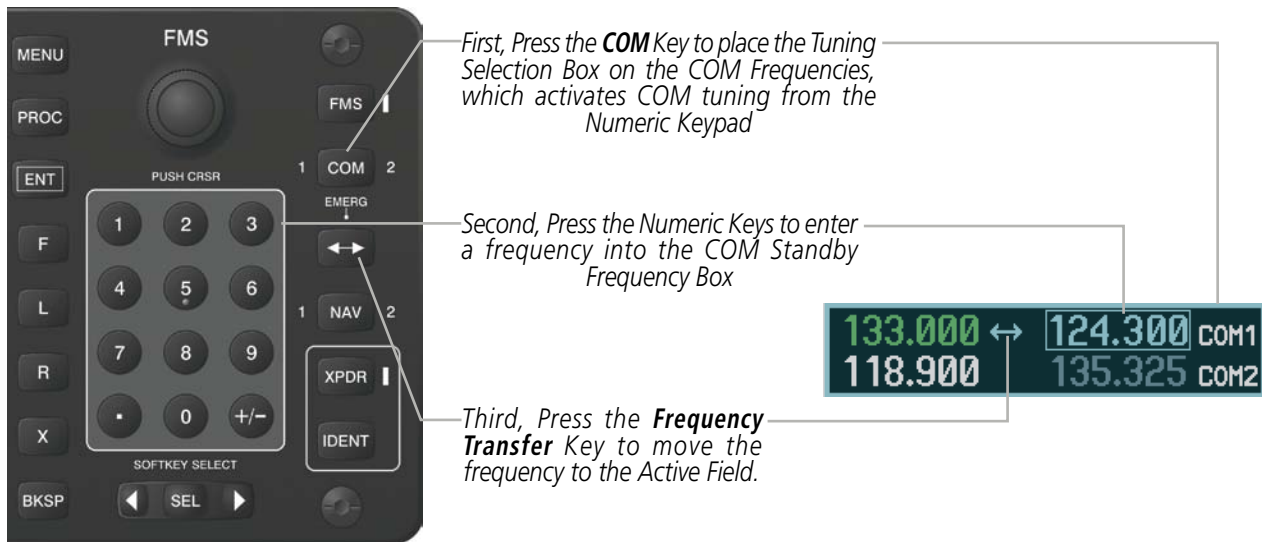

Figure 4-8 Frequency Tuning from the Control Unit

### SELECTING THE RADIO TO BE TUNED

Press the small **COM** Knob or the **COM** Key on the Control Unit to transfer the frequency tuning box and Frequency Transfer Arrow between the upper and lower radio frequency fields.

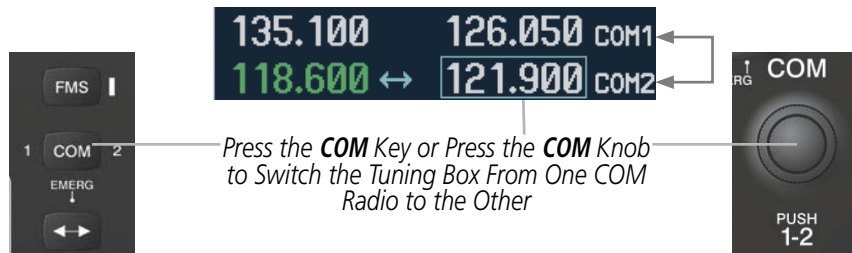

Figure 4-9 Switching COM Tuning Boxes

### QUICK-TUNING AND ACTIVATING 121.500 MHZ

Pressing and holding the **COM Frequency Transfer** Key for two seconds automatically loads the emergency COM frequency (121.500 MHz) in the active field of the COM radio selected for tuning (the one with the transfer arrow). In the example shown, pressing the Audio Panel **COM2 MIC** Key activates the transceiver.

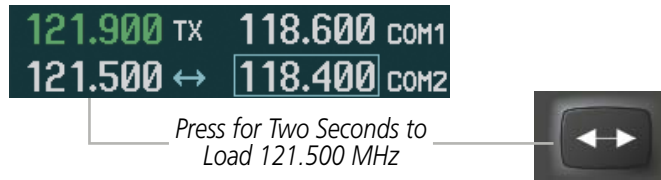

Figure 4-10 Quickly Tuning 121.500 MHz

## AUTO-TUNING THE COM FREQUENCY

COM frequencies can be automatically tuned from the following:

- Nearest Airports Window (PFD)
- WPT – Airport Information Page
- NRST – Nearest Airports Page
- NRST – Nearest Frequencies Page (ARTCC, FSS, WX)
- NRST – Nearest Airspaces Page

### AUTO-TUNING FROM THE PFD

COM frequencies for the nearest airports can be automatically tuned from the Nearest Airports Window on the PFD. When the desired frequency is entered, it becomes a standby frequency. Pressing the **Frequency Transfer** Key places this frequency into the COM Active Frequency Field.

#### Auto-tuning a COM frequency for a nearby airport from the PFD:

- 1) Select the **NRST** Softkey on the PFD to open the Nearest Airports Window. A list of 25 nearest airport identifiers and COM frequencies is displayed.
- 2) Turn the **FMS** Knob to scroll through the list and highlight the desired COM frequency.
- 3) Press the **ENT** Key to load the COM frequency into the COM Standby Tuning Box.
- 4) Press the **Frequency Transfer** Key to transfer the frequency to the COM Active Frequency Field.



Select the **NRST** Softkey to Open the Nearest Airports Window

Figure 4-11 Nearest Airports Window (PFD)

### AUTO-TUNING FROM THE MFD

Frequencies can be automatically loaded into the COM Frequency Box from pages in the NRST or WPT page group by highlighting the frequency and pressing the **ENT** Key (Figures 4-12, 4-13, and 4-14).

#### Auto-tuning a COM frequency from the WPT and NRST Pages:

- 1) From any page that the COM frequency can be auto-tuned, activate the cursor by pressing the **FMS** Knob or selecting the appropriate softkey.
- 2) Turn the **FMS** Knob to place the cursor on the desired COM frequency.
- 3) Press the **ENT** Key to load the COM frequency into the standby field of the selected COM radio.
- 4) Press the **Frequency Transfer** Key to transfer the frequency to the COM Active Frequency Field.

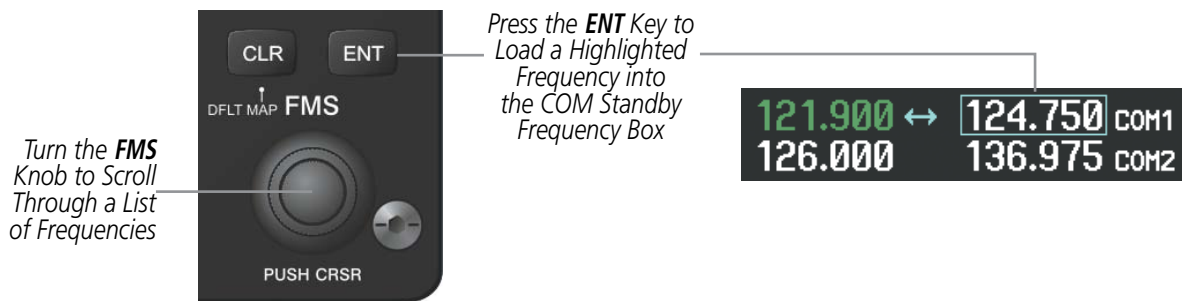

Figure 4-12 Frequency Auto-Tuning from the MFD

Or:

- 1) On the Nearest Airports, Frequencies, or Airspaces page, press the **MENU** Key to display the page menu (Figure 4-13).
- 2) Turn the large **FMS** Knob to scroll through the menu options.
- 3) Press the **ENT** Key to place the cursor on the desired selection.
- 4) Scroll through the frequency selections with the **FMS** Knob.
- 5) Press the **ENT** Key to load the COM frequency into the standby field of the selected COM radio.
- 6) Press the **Frequency Transfer** Key to transfer the frequency to the COM Active Frequency Field.

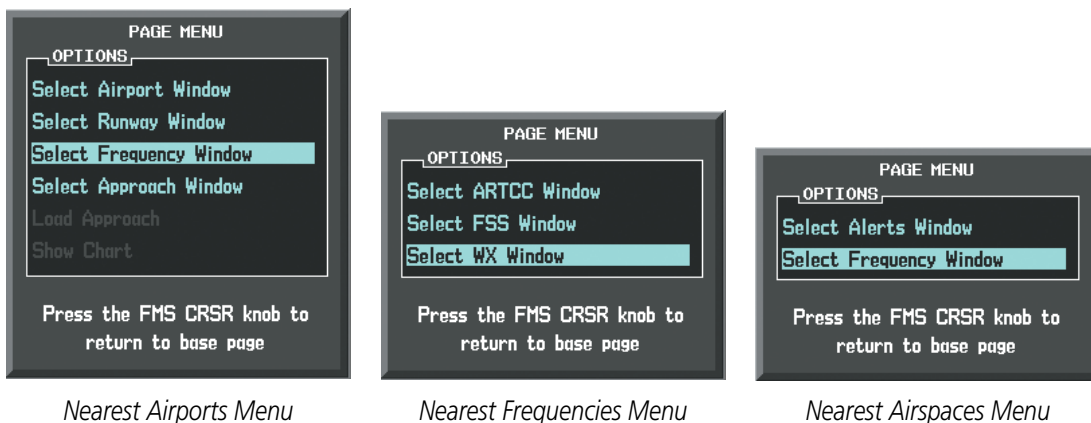

Figure 4-13 Nearest Pages Menus



On the WPT - Airport Information Page, the cursor can be placed on the frequency field by pressing the **FMS** Knob and scrolling through the list. The frequency is transferred to the COM Standby Field with the **ENT** Key.

The screenshot displays the WPT - Airport Information Page. At the top, flight data includes speed (283KT), heading (DTK 147°), track (TRK 146°), and estimated time en route (ETE 05:15). The current frequency is 118.900, and the COM1 standby frequency is 133.000. The selected airport is KTOP (Philip Billard Municipal Airport, Topeka, KS), with an elevation of 881 feet and an ICAO code of UTC-6. The selected runway is 04-22, which is 3002 feet by 100 feet with a hard surface and a precision frequency of 118.700. A list of frequencies is shown, with 123.800 highlighted. The bottom of the screen features softkeys: INFO-1, DP, STAR, APR, and WX.

*Press **INFO-N** Softkey for AIRPORT, RUNWAYS, and FREQUENCIES Window or AOPA Directory Window*

*Press **Frequency Transfer** Key to Load Frequency into COM Active Tuning Box*

*Selected Airport Identifier and Information*

*Runway Information*

*Press **ENT** Key to load frequency into COM Standby Field. Cursor then advances to the next frequency.*

Figure 4-14 WPT – Airport Information Page

COM frequencies can also be auto-tuned from the NRST – Nearest Airspaces, NRST – Nearest Frequencies, and NRST – Nearest Airports Pages on the MFD in a similar manner using the appropriate softkeys or **MENU** Key, the **FMS** Knob, and the **ENT** Key.



Figure 4-15 NRST – Nearest Airspaces, NRST – Nearest Airports, and NRST – Nearest Frequencies Pages

## FREQUENCY SPACING

The COM radios can tune either 25-kHz spacing (118.000 to 136.975 MHz) or 8.33-kHz spacing (118.000 to 136.990 MHz) for 760-channel or 3040-channel configuration. When 8.33-kHz channel spacing is selected, all of the 25-kHz channel spacing frequencies are also available in the complete 3040-channel list. Variable rate tuning is provided with 8.33-kHz spacing to achieve faster selection of the decimal digits.

COM channel spacing is set on the System Setup Page of the AUX Page Group.

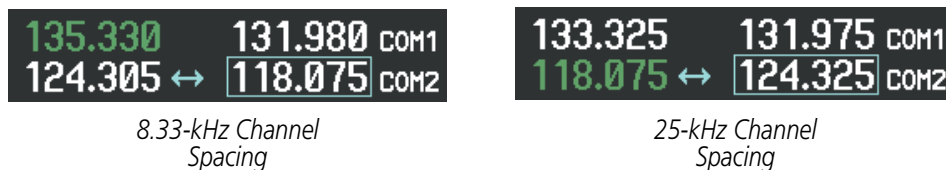
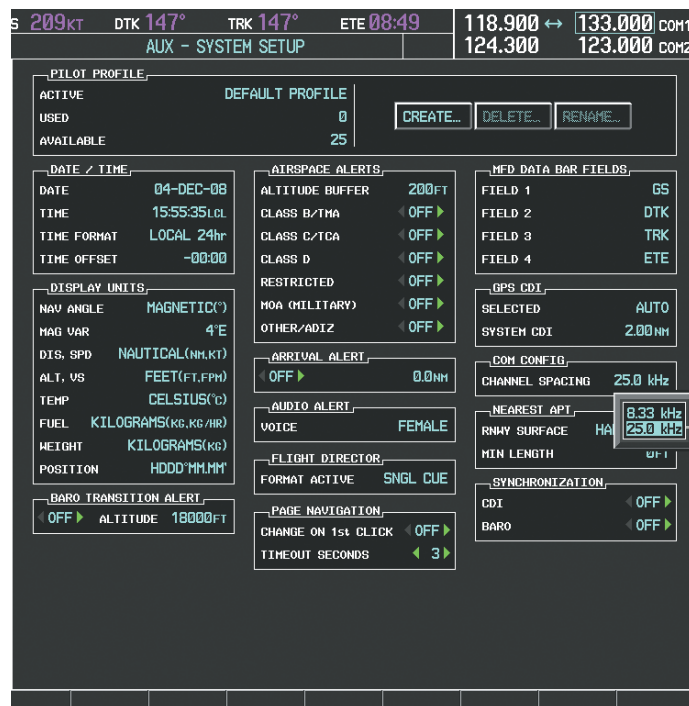

Figure 4-16 COM Channel Spacing

### Changing COM frequency channel spacing:

- 1) Select the AUX – System Setup Page.
- 2) Press the **FMS** Knob to activate the flashing cursor.
- 3) Turn the large **FMS** Knob to highlight the Channel Spacing Field in the COM Configuration Box.
- 4) Turn the small **FMS** Knob to select the desired channel spacing.
- 5) Press the **ENT** Key to complete the channel spacing selection.

While the COM CONFIG Box is selected, the softkeys are blank.



Select 8.33-kHz or 25.0-kHz COM Frequency Channel Spacing

Figure 4-17 AUX – System Setup Page

## AUTOMATIC SQUELCH

Automatic Squelch quiets unwanted static noise when no audio signal is received, while still providing good sensitivity to weak COM signals. To disable Automatic Squelch, press the **VOL/SQ** Knob. When Automatic Squelch is disabled, COM audio reception is always on. Continuous static noise is heard over the headsets and speaker, if selected. Pressing the **VOL/SQ** Knob again enables Automatic Squelch.

When Automatic Squelch is disabled, a white SQ appears next to the COM frequency.



Figure 4-18 Overriding Automatic Squelch

## VOLUME

COM radio volume level can be adjusted from 0 to 100% using the **VOL/SQ** Knob. Turning the knob clockwise increases volume, turning the knob counterclockwise decreases volume. When adjusting volume, the level is displayed in place of the standby frequencies. Volume level indication remains for two seconds after the change.



Figure 4-19 COM Volume Level

## 4.3 NAV OPERATION

### NAV RADIO SELECTION AND ACTIVATION

The NAV Frequency Box is composed of four fields; two standby fields and two active fields. The active frequencies are on the right side and the standby frequencies are on the left.

A NAV radio is selected for navigation by selecting the **CDI** Softkey located on the PFD. The active NAV frequency selected for navigation is displayed in green. Selecting the **CDI** Softkey once selects NAV1 as the navigation radio. Selecting the **CDI** Softkey a second time selects NAV2 as the navigation radio. Selecting the **CDI** Softkey a third time activates GPS mode. Selecting the **CDI** Softkey again cycles back to NAV1.

While cycling through the **CDI** Softkey selections, the NAV Tuning Box and the Frequency Transfer Arrow are placed in the active NAV Frequency Field and the active NAV frequency color changes to green.

The three navigation modes that can be cycled through are:

- VOR1 (or LOC1) – If NAV1 is selected, a green single line arrow (not shown) labeled either VOR1 or LOC1 is displayed on the HSI and the active NAV1 frequency is displayed in green.
- VOR2 (or LOC2) – If NAV2 is selected, a green double line arrow (shown) labeled either VOR2 or LOC2 is displayed on the HSI and the active NAV2 frequency is displayed in green.
- GPS – If GPS Mode is selected, a magenta single line arrow (not shown) appears on the HSI and neither NAV radio is selected. Both active NAV frequencies are then displayed in white.

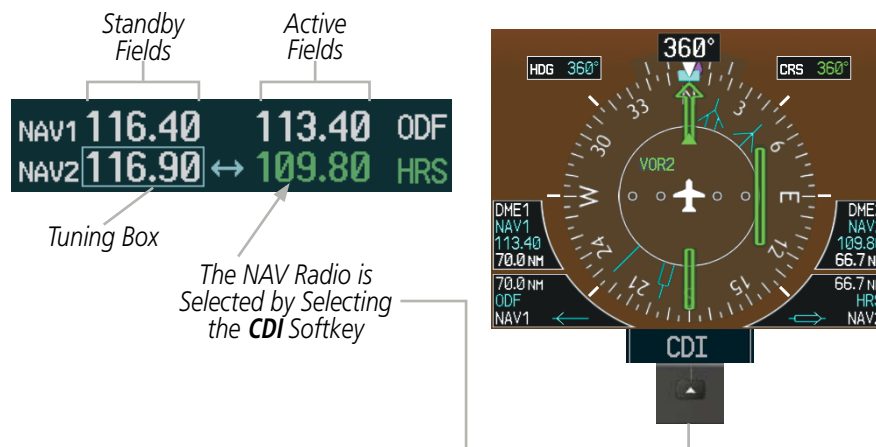

Figure 4-20 Selecting a NAV Radio for Navigation

The active NAV frequency displayed in green on the MFD is the same as on PFD1.

See the Flight Instruments Section for selecting the DME and Bearing Information windows and using VOR as the source for the bearing pointer.

NAV radios are selected for listening by pressing the corresponding keys on the Audio Panel. Pressing the **NAV1**, **NAV2**, **ADF**, **DME**, or **AUX** Key selects and deselects the navigation radio source. The **DME** Key selects and deselects optional DME 1 audio. The **AUX** Key selects and deselects optional DME 2 audio. Selected audio can be heard over the headset and the speakers (if selected). All radios can be selected individually or simultaneously.



Figure 4-21 Selecting a NAV Radio Receiver

## NAV RECEIVER MANUAL TUNING

The NAV frequency controls and frequency boxes are on the left side of the PFD and MFD. The MFD frequency controls and displays are linked to the pilot side PFD (PFD1) only.

### Manually tuning a NAV frequency:

- 1) Turn the **NAV** Knob to tune the desired frequency in the NAV Tuning Box.
- 2) Press the **Frequency Transfer** Key to transfer the frequency to the NAV Active Frequency Field.
- 3) Adjust the volume level with the NAV **VOL/ID** Knob.
- 4) Press the NAV **VOL/ID** Knob to turn the Morse code identifier audio on and off.

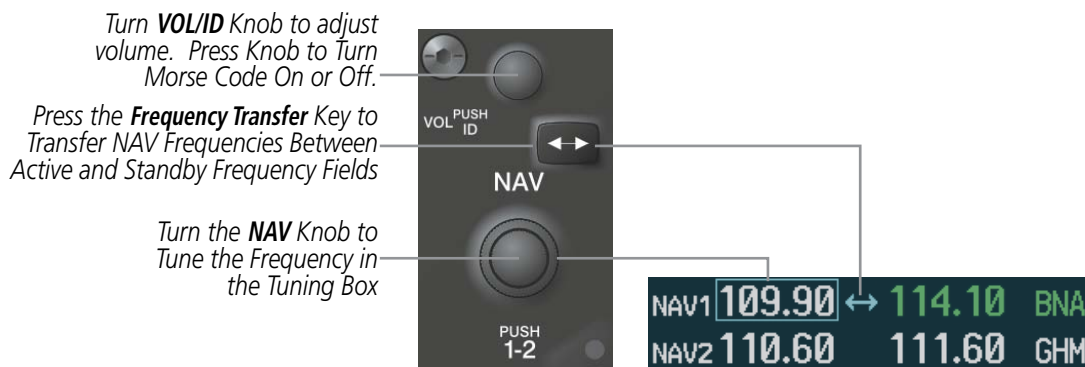

Figure 4-22 NAV Frequency Tuning

**Manual NAV frequency tuning from the Control Unit**

- 1) Press the **NAV** Key to select the NAV Tuning Selection Box.
- 2) Press the numeric keys on the keypad to enter a Frequency.
- 3) Press the **Frequency Transfer** Key to transfer the frequency to the active field.

If an error is made during frequency entry with the numeric keypad, pressing the **BKSP** Key moves the cursor back one space. If an incorrect frequency is entered, reenter the correct one using the same procedure.

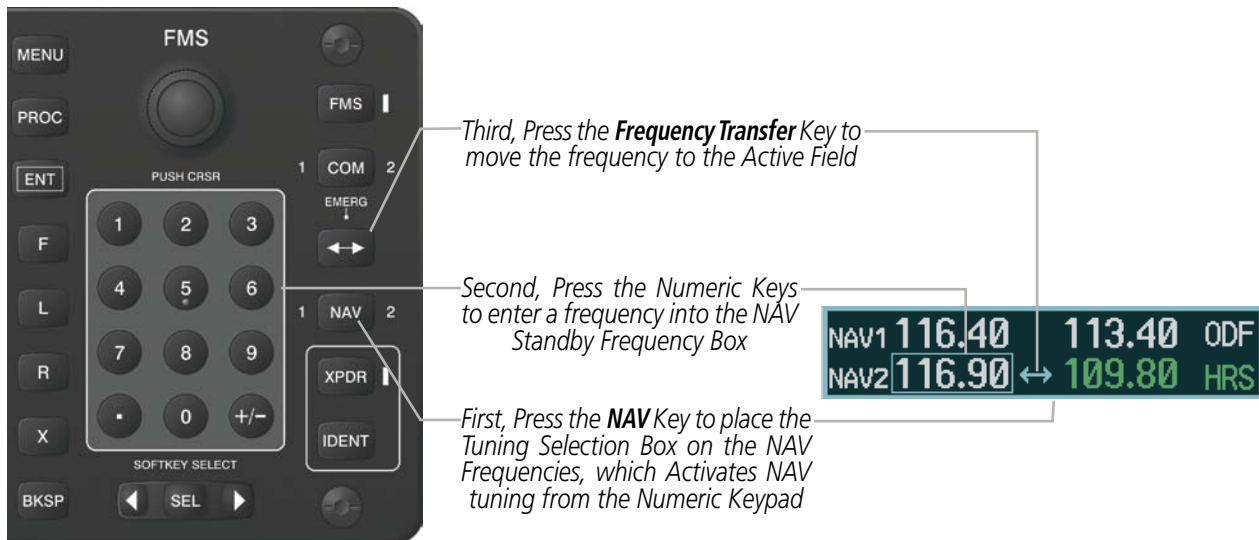

Figure 4-23 Frequency Tuning from the Control Unit



### SELECTING THE RADIO TO BE TUNED

Press the small **NAV** Knob to transfer the frequency tuning box and Frequency Transfer Arrow between the upper and lower radio frequency fields.

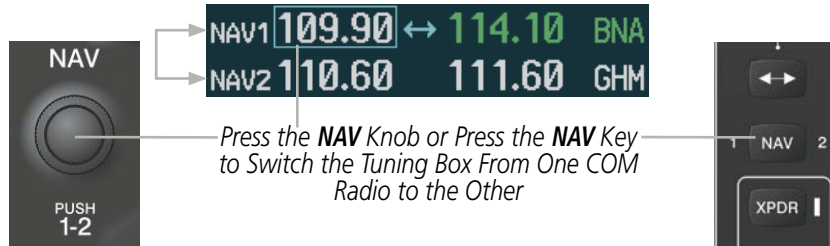

Figure 4-24 Switching NAV Tuning Boxes

### VOR/LOC ID

When the Morse code Identifier audio is on for a NAV radio, a white ID appears to the left of the active NAV frequency.

In the example shown, in order to listen to either station identifier, press the **NAV1** or **NAV2** Key on the Audio Panel. Pressing the **VOL/ID** Knob turns off the Morse code audio only in the radio with the NAV Tuning Box. To turn off both NAV IDs, transfer the NAV Tuning Box between NAV1 and NAV2 by pressing the small **NAV** Knob and pressing the **VOL/ID** Knob again to turn the Morse code off in the other radio.

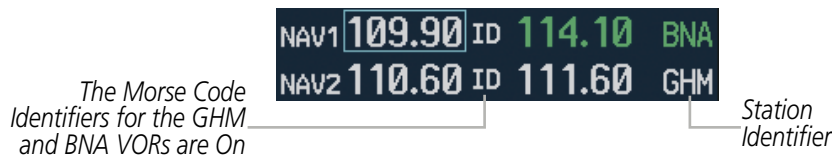

Figure 4-25 NAV Radio ID Indication

### VOLUME

NAV Radio volume level can be adjusted from 0 to 100% using the **VOL/ID** Knob. Turning the knob clockwise increases volume, counterclockwise decreases volume.

When adjusting, the level is displayed in place of the standby frequencies. Volume level indication remains for two seconds after the change.

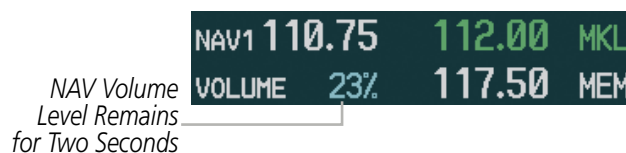

Figure 4-26 NAV Volume Levels

## AUTO-TUNING A NAV FREQUENCY FROM THE MFD

NAV frequencies can be selected and loaded from the following MFD pages:

- WPT – Airport Information
- WPT – VOR Information
- NRST – Nearest Airports
- NRST – Nearest VOR
- NRST – Nearest Frequencies (FSS, WX)
- NRST – Nearest Airspaces

The MFD provides auto-tuning of NAV frequencies from waypoint and nearest pages. During enroute navigation, the NAV frequency is entered automatically into the NAV standby frequency field. During approach activation the NAV frequency is entered automatically into the NAV active frequency field.

Frequencies can be automatically loaded into the NAV Frequency Box from pages in the NRST or WPT page group by highlighting the frequency and pressing the **ENT** Key (Figures 4-27, 4-28, and 4-29).

### Auto-tuning a NAV frequency from the WPT and NRST Pages:

- 1) From any page that the NAV frequency can be auto-tuned, activate the cursor by pressing the **FMS** Knob or selecting the appropriate softkey.
- 2) Turn the **FMS** Knob to place the cursor on the desired NAV identifier or NAV frequency.
- 3) On the Nearest VOR, Nearest Airspaces, and Nearest Airports pages, select the **FREQ** Softkey to place the cursor on the NAV frequency (Figure 4-27).
- 4) Press the **ENT** Key to load the NAV frequency into the standby field of the selected NAV radio.
- 5) Press the **Frequency Transfer** Key to transfer the frequency to the NAV Active Frequency Field.

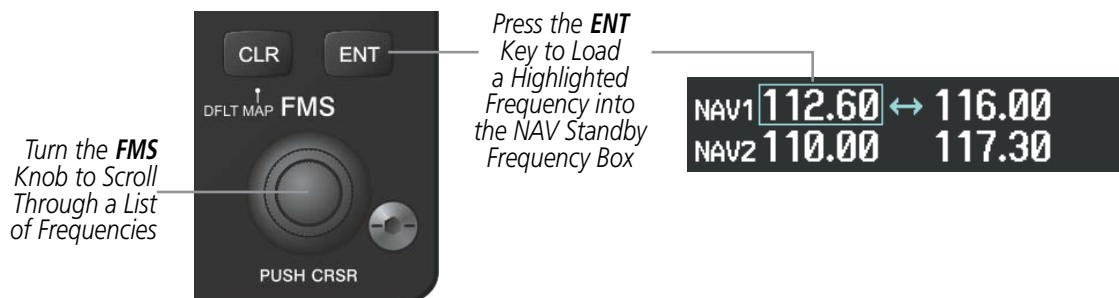

Figure 4-27 NAV Frequency Auto-Tuning from the MFD

Or:

- 1) When on the NRST pages, press the **MENU** Key to display the page menu.
- 2) Turn the large **FMS** Knob to scroll through the menu options.
- 3) Press the **ENT** Key to place the cursor in the desired window.
- 4) Scroll through the frequency selections with the **FMS** Knob.
- 5) Press the **ENT** Key to load the NAV frequency into the standby field of the selected NAV radio.
- 6) Press the **Frequency Transfer** Key to transfer the frequency to the NAV Active Frequency Field.

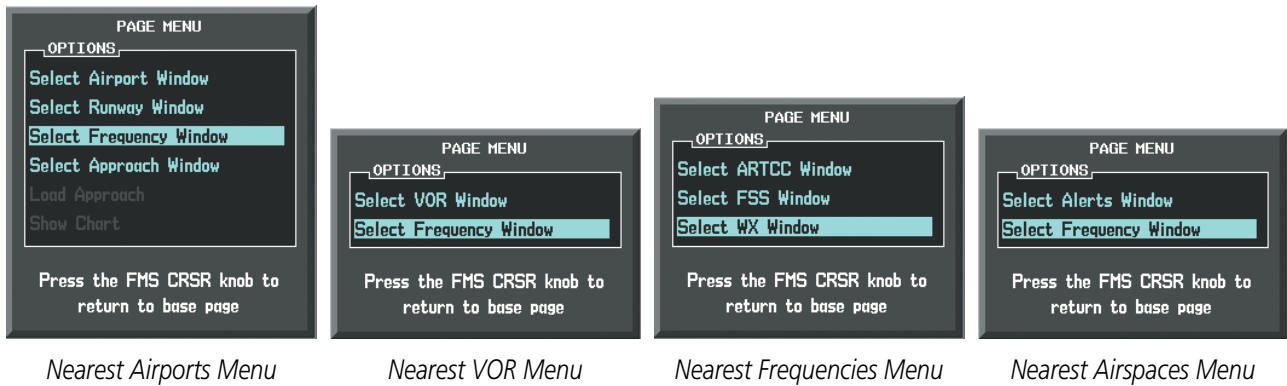
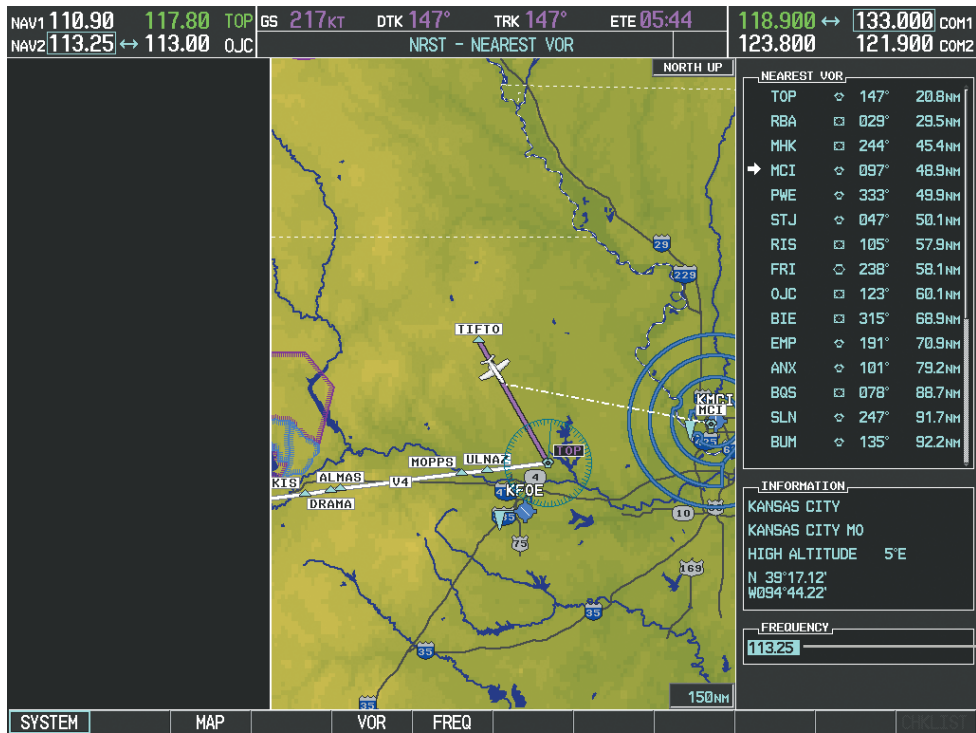

Figure 4-28 Nearest Pages Menus

In the example shown, the VOR list is selected with the **VOR** Softkey or from the page menu. The **FMS** Knob or **ENT** Key is used to scroll through the list. The cursor is placed on the frequency with the **FREQ** Softkey and loaded into the NAV Tuning Box with the **ENT** Key.



Press the **ENT** Key to Load the Frequency into the NAV Standby Field.

Select the **VOR** Softkey to Place the Cursor on the VOR Identifier

Select the **FREQ** Softkey to Place the Cursor on the VOR Frequency

Figure 4-29 Loading the NAV Frequency from the NRST – Nearest VOR Page

While enroute, NAV frequencies can also be auto-tuned from the NRST – Nearest Airports, WPT – Airport Information, WPT – VOR Information, and NRST – Nearest Frequencies Pages on the MFD in a similar manner using the appropriate softkeys or **MENU** Key, the **FMS** Knob, and the **ENT** Key.



Figure 4-30 NRST – Nearest Frequencies, WPT – VOR Information, WPT – Airport Information, and NRST – Nearest Airports Pages

## AUTO-TUNING NAV FREQUENCIES ON APPROACH ACTIVATION



---

**NOTE:** *The primary NAV frequency is auto-tuned upon loading a VOR or ILS/Localizer approach.*

---



---

**NOTE:** *When an ILS/LOC approach has been activated in GPS Mode, the system switches to NAV Mode as the final approach course is intercepted (within 15 nm of the FAF). See the Flight Management Section for details.*

---

NAV frequencies are automatically loaded into the NAV Frequency Box on approach activation.

When loading or activating a VOR or ILS/LOC approach, the approach frequency is automatically transferred to a NAV frequency field as follows:

- If the current CDI navigation source is GPS, the approach frequency is transferred to the NAV1 or NAV2 active frequency fields. The frequency that was previously in the NAV1 or NAV2 active frequency fields are transferred to standby.
- If the current CDI navigation source is GPS, and if the approach frequency is already loaded into the NAV1 or NAV2 standby frequency field, the standby frequency is transferred to active.
- If the current CDI navigation source is NAV1 or NAV2, the approach frequency is transferred to the standby frequency fields of the selected CDI NAV radio.

## MARKER BEACON RECEIVER

**NOTE:** The marker beacon indicators operate independently of marker beacon audio and cannot be turned off.

The marker beacon receiver is used as part of the ILS. The marker beacon receiver is always on and detects any marker beacon signals within the reception range of the aircraft.

The receiver detects the three marker tones – outer, middle, and inner – and provides the marker beacon annunciations located to the left of the Altimeter on the PFD.

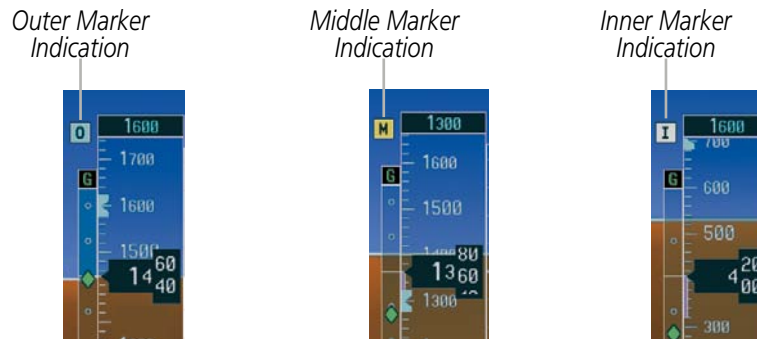

Figure 4-31 Marker Beacon Annunciations on the PFD



Figure 4-32 Marker Beacon Keys

The Audio Panels provide three different states of marker beacon operation; On, Muted, and Deselected. Pressing the **MKR/MUTE** Key selects and deselected marker beacon audio. The key annunciator indicates when marker beacon audio is selected.

During marker beacon audio reception, pressing the **MKR/MUTE** Key mutes the audio but does not affect the marker annunciations (Figure 4-31). The marker tone is silenced, then waits for the next marker tone. The **MKR/MUTE** Key Annunciator is illuminated, indicating audio muting. The audio returns when the next marker beacon signal is received. If the **MKR/MUTE** Key is pressed during signal reception (O, M, I indication) while marker beacon audio is muted, the audio is deselected and the **MKR/MUTE** Key Annunciator is extinguished.

Pressing the **HI SENS** Key switches between high and low marker beacon receiver sensitivity. The HI SENS function (annunciator illuminated) is used to provide an earlier indication when nearing a marker during an approach. The LO SENS function (annunciator extinguished) results in a narrower marker dwell while over a station.



## ADF/DME TUNING



**NOTE:** When another auxiliary window is turned on, the ADF/DME Tuning Window is replaced on the PFD.

See the Flight Instruments Section for displaying the DME and bearing information windows (ADF) and using the ADF as the source for the bearing pointer.

The system tunes the optional ADF receiver and DME transceiver. The ADF is tuned by entering the frequency in the ADF standby frequency field of the ADF/DME Tuning Window. (The softkey may be labeled **ADF/DME** or **DME**, depending on installed equipment.)

The UHF DME frequency is tuned by pairing with a VHF NAV frequency. DME frequency pairing is automatic and only the VHF NAV frequency is shown.

The following ADF/DME information is displayed in the ADF/DME Tuning Window:

- Active and standby ADF frequencies
- ADF receiver mode
- DME tuning mode (DME transceiver pairing)

When the ADF/DME Tuning Window is displayed, the selection cursor is placed over the standby ADF frequency field.

Turning the large **FMS** Knob moves the selection cursor through the various fields (standby ADF frequency, ADF receiver mode, and DME tuning mode). Pressing the **FMS** Knob activates/deactivates the selection cursor in the ADF/DME Tuning Window. The ADF frequency is entered using the **FMS** Knob and the **ENT** Key.

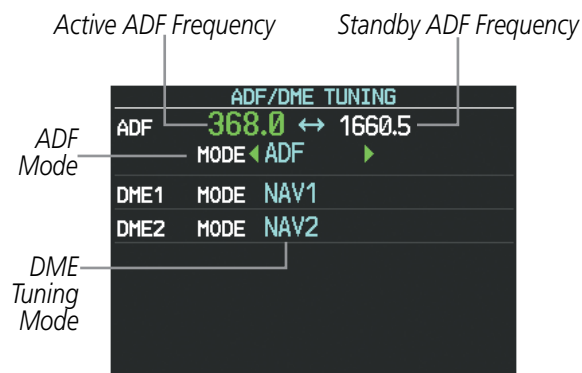

Figure 4-33 ADF/DME Tuning Window

## ADF TUNING

ADF frequencies in the 190.0-kHz to 1799.5-kHz range are entered in the standby ADF frequency field of the ADF/DME Tuning Window. The system does not tune the ADF emergency frequency, 2182.0-kHz.

### Tuning an ADF frequency:

- 1) Select the **ADF/DME** Softkey to display the ADF/DME Tuning Window.
- 2) Turn the large **FMS** Knob to place the selection cursor over the standby ADF frequency field.
- 3) Turn the small **FMS** Knob to begin data entry and change each digit.
- 4) Turn the large **FMS** Knob to move the cursor to the next digit position.
- 5) Press the **ENT** Key to complete data entry for the standby frequency.

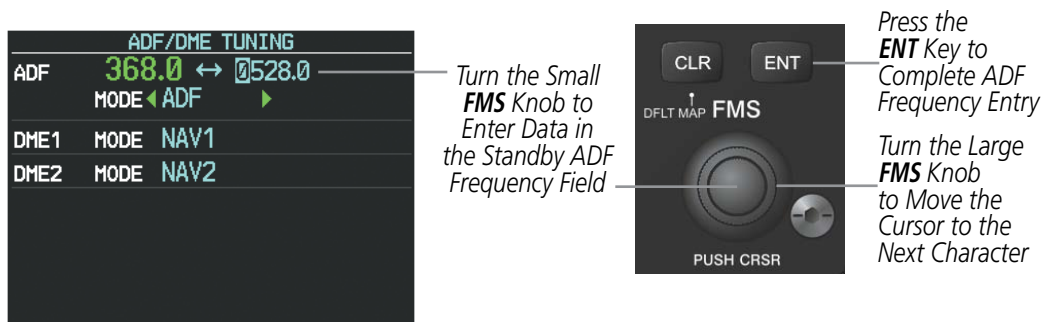

Figure 4-34 Entering ADF Standby Frequencies

Pressing the **CLR** Key before completing frequency entry cancels the frequency change and reverts back to the previously entered frequency.

Pressing the **CLR** Key when the cursor is flashing, clears the frequency and replaces the standby field with '0000.0'.

### Transferring the active and standby ADF frequencies:

- 1) Turn the large **FMS** Knob to place the selection cursor over the standby ADF frequency field.
- 2) Press the **ENT** Key to complete the frequency transfer.

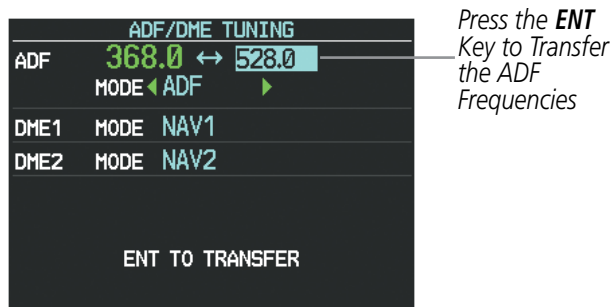

Figure 4-35 Transferring ADF Frequencies

## SELECTING ADF RECEIVER MODE

The following modes can be selected: (In all modes NDB audio can be heard by selecting the **ADF** Key on the Audio Panel.)

- **ANT** (Antenna) – The ADF bearing pointer parks on the HSI at 90 degrees. Best mode for listening to NDB audio.
- **ADF** (Automatic Direction Finder) – The ADF pointer points to the relative bearing of the NDB station.
- **ADF/BFO** (ADF/Beat Frequency Oscillator) – The ADF pointer points to the relative bearing of the NDB station and an audible tone confirms signal reception. This mode allows identification of the interrupted carrier beacon stations used in various parts of the world.
- **ANT/BFO** (Antenna/Beat Frequency Oscillator) – The ADF bearing pointer parks on the HSI at 90 degrees while an audible tone is provided when a signal is received. This mode also allows identification of the interrupted carrier beacon stations and confirms signal reception.

### Selecting an ADF receiver mode:

- 1) Turn the large **FMS** Knob to place the selection cursor over the ADF mode field.
- 2) Turn the small **FMS** Knob to select the desired ADF receiver mode.

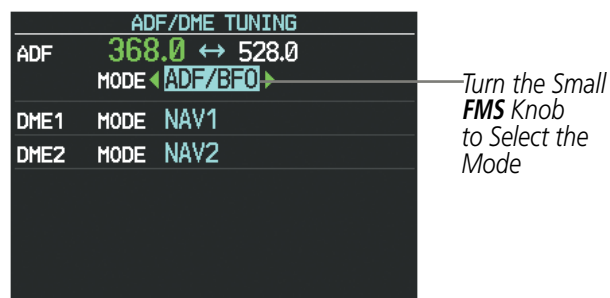

Figure 4-36 Selecting ADF Receiver Mode

## DME TUNING



**NOTE:** When turning on the system for use, the system remembers the last frequency used for DME tuning and the NAV1, NAV2, or HOLD state prior to shutdown.

The DME transceiver is tuned by selecting NAV1, NAV2, or HOLD in the ADF/DME Tuning Window.

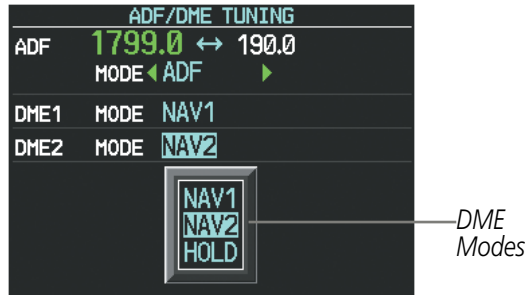

Figure 4-37 DME Tuning Window

The following DME transceiver pairings can be selected:

- NAV1 – Pairs the DME frequency from the selected NAV1 frequency.
- NAV2 – Pairs the DME frequency from the selected NAV2 frequency.
- HOLD – When in the HOLD position, the DME frequency remains paired with the last selected NAV frequency.

### Selecting DME transceiver pairing:

- 1) Select the **ADF/DME** Softkey to display the ADF/DME Tuning Window.
- 2) Turn the small **FMS** Knob to select the DME tuning mode.
- 3) Press the **ENT** Key to complete the selection.

Pressing the **CLR** Key or **FMS** Knob while in the process of DME pairing cancels the data entry and reverts back to the previously selected DME tuning state. Pressing the **FMS** Knob activates/deactivates the cursor in the ADF/DME Tuning Window.

## 4.4 MODE S TRANSPONDER

The GTX 33 Mode S Transponder and GTX 33D Diversity Mode S Transponder provide Mode A, Mode C, and Mode S interrogation and reply capabilities. Diversity incorporates antennas mounted on the top and bottom of the aircraft for dependable operation while maneuvering. Selective addressing or Mode Select (Mode S) capability includes the following features:

- Level-2 reply data link capability (used to exchange information between aircraft and ATC facilities)
- Surveillance identifier capability
- Flight ID (Flight Identification) reporting – The Mode S Transponder reports aircraft identification as either the aircraft registration or a unique Flight ID.
- Altitude reporting
- Airborne status determination
- Transponder capability reporting
- Mode S Enhanced Surveillance (EHS) requirements
- Acquisition squitter – Acquisition squitter, or short squitter, is the transponder 24-bit identification address. The transmission is sent periodically, regardless of the presence of interrogations. The purpose of acquisition squitter is to enable Mode S ground stations and aircraft equipped with a Traffic Avoidance System (TAS) to recognize the presence of Mode S-equipped aircraft for selective interrogation.

The Hazard Avoidance Section provides more details on traffic avoidance systems.

## GTX 33 TRANSPONDER CONTROLS

Transponder function is displayed on three levels of softkeys on the PFD: Top-level, Mode Selection, and Code Selection. When the top-level **XPDR** Softkey is selected, the Mode Selection softkeys appear: **XPDR1**, **XPDR2**, **STBY**, **ON**, **ALT**, **GND**, **VFR**, **CODE**, **IDENT**, **BACK**.

When the **CODE** Softkey is selected, the number softkeys appear: **0**, **1**, **2**, **3**, **4**, **5**, **6**, **7**, **IDENT**, **BKSP**, **BACK**. The digits 8 and 9 are not used for code entry. Selecting the numbered softkeys in sequence enters the transponder code. If an error is made, selecting the **BKSP** Softkey moves the code selection cursor to the previous digit. Selecting the **BKSP** Softkey again moves the cursor to the next previous digit.

Selecting the **BACK** Softkey during code selection reverts to the Mode Selection Softkeys. Selecting the **BACK** Softkey during mode selection reverts to the top-level softkeys.

The code can also be entered with the **FMS** Knob on either PFD. Code entry must be completed with either the softkeys or the **FMS** Knob, but not a combination of both.

Selecting the **IDENT** Softkey while in Mode or Code Selection initiates the ident function and reverts to the top-level softkeys.

After 45 seconds of transponder control inactivity, the system reverts back to the top-level softkeys.

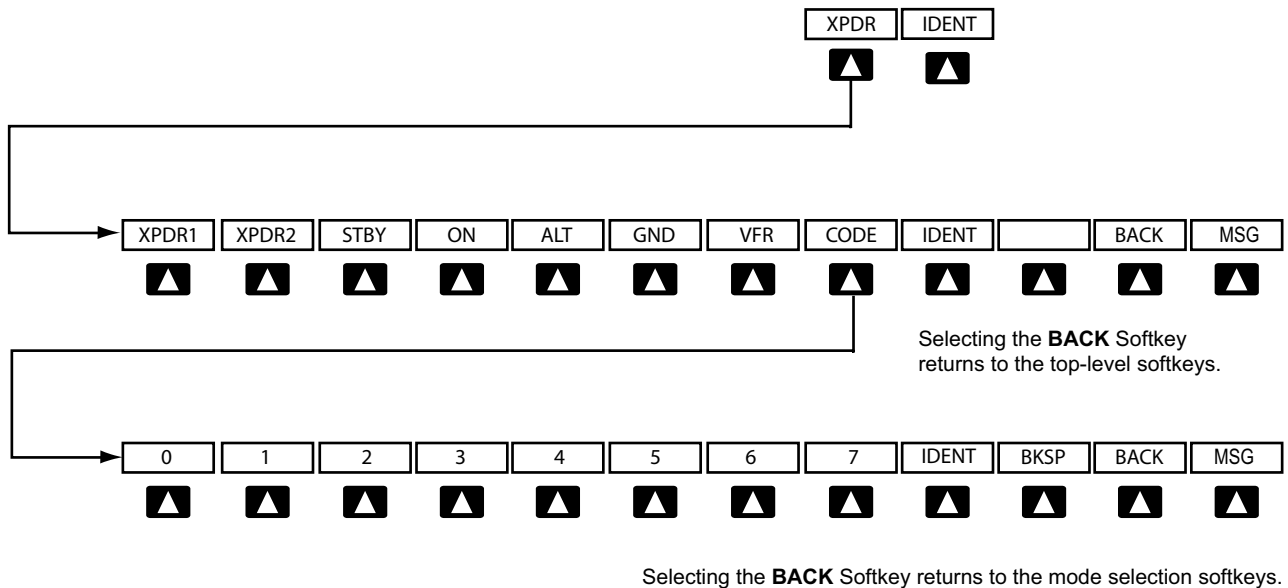

Figure 4-34 Transponder Softkeys (PFD)

### Selecting and activating Transponder 1 or Transponder 2:

- 1) Select the **XPDR** Softkey to display the Transponder Mode Selection Softkeys.
- 2) Select the **XPDR1** or **XPDR2** Softkey to select and activate the other transponder.

When turning on the system for use, the system defaults to the transponder active prior to shutdown. When switching between Transponder 1 and Transponder 2, the code and mode remain the same. If a new code is entered in the active transponder, switching transponders does not bring back the previous code.

## GTX 33 TRANSPONDER MODE SELECTION

Mode selection can be automatic (Ground and Altitude Modes) or manual (Standby, On, and Altitude Modes). The **STBY**, **ON**, **ALT**, and **GND** Softkeys can be accessed by selecting the **XPDR** Softkey.

### Selecting a transponder mode:

- 1) Select the **XPDR** Softkey to display the Transponder Mode Selection Softkeys.
- 2) Select the desired softkey to activate the transponder mode.

## STANDBY MODE (MANUAL)



**NOTE:** In Standby Mode, the IDENT function is inhibited.

Standby Mode can be selected at any time by selecting the **STBY** Softkey. In Standby, the transponder does not reply to interrogations, but new codes can be entered. When Standby is selected, a white STBY indication and transponder code appear in the mode field of the Transponder Data Box. In all other modes, these fields appear in green.



Figure 4-35 Standby Mode

## ON MODE (MANUAL)

ON Mode can be selected at any time by selecting the **ON** Softkey. ON Mode generates Mode A replies, but Mode C altitude reporting is inhibited. Acquisition squitter and replies to discretely addressed Mode S interrogations are also permitted. In ON Mode, a green ON indication and transponder code appear in the mode field of the Transponder Data Box.

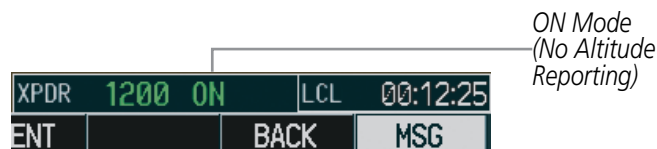

Figure 4-36 ON Mode



**ALTITUDE MODE (AUTOMATIC OR MANUAL)**

Altitude Mode is automatically selected when the aircraft becomes airborne. Altitude Mode may also be selected manually by selecting the **ALT** Softkey. ALT Mode generates Mode A and Mode C replies. Acquisition squitter and replies to discretely addressed Mode S interrogations are also permitted.

If Altitude Mode is selected, a green ALT indication and transponder code appear in the mode field of the Transponder Data Box, and all transponder replies requesting altitude information are provided with pressure altitude information.



**Figure 4-37 Altitude Mode**

**GROUND MODE**

Ground Mode is normally selected automatically when the aircraft is on the ground. The transponder powers up in the last mode it was in when shut down. Ground Mode can be overridden by selecting any one of the Mode Selection Softkeys. A green GND indication and transponder code appear in the mode field of the Transponder Data Box. In Ground Mode, the transponder does not allow Mode A and Mode C replies, but it does permit acquisition squitter and replies to discretely addressed Mode S interrogations.

When Standby Mode has been selected on the ground, the transponder can be returned to Ground Mode by selecting the **GND** Softkey.



**Figure 4-38 Ground Mode**

**REPLY STATUS**

When the transponder sends replies to interrogations, a white R indication appears momentarily in the reply status field of the Transponder Data Box.



**Figure 4-39 Reply Indication**

### TCAS II TRANSPONDER CONTROLS (OPTIONAL)

Transponder function is displayed on three levels of softkeys on the PFD: Top-level, Transponder/Traffic Selection, and Mode Selection or Code Entry. When the top-level **XPDR/TFC** Softkey is selected, the Function Select softkeys appear: **XPDR1**, **XPDR2**, **MODE**, **TCAS**, **CODE**, **IDENT**, **BACK**.

When the **MODE** Softkey is selected, the Mode Selection softkeys appear: **STBY**, **ON**, **ALT**, **TA ONLY**, **TA/RA**, **BACK**.

When the **CODE** Softkey is selected, the number softkeys appear: **0**, **1**, **2**, **3**, **4**, **5**, **6**, **7**, **IDENT**, **BKSP**, **BACK**. The digits 8 and 9 are not used for code entry. Selecting the numbered softkeys in sequence enters the transponder code. If an error is made, selecting the **BKSP** Softkey moves the code selection cursor to the previous digit. Selecting the **BKSP** Softkey again moves the cursor to the next previous digit.

Selecting the **BACK** Softkey returns to the previous level softkeys.

The code can also be entered with the **FMS** Knob on either PFD. Code entry must be completed with either the softkeys or the **FMS** Knob, but not a combination of both.

Selecting the **IDENT** Softkey while in Code Selection initiates the ident function and reverts to the top-level softkeys.

After 45 seconds of transponder control inactivity, the system reverts back to the top-level softkeys.

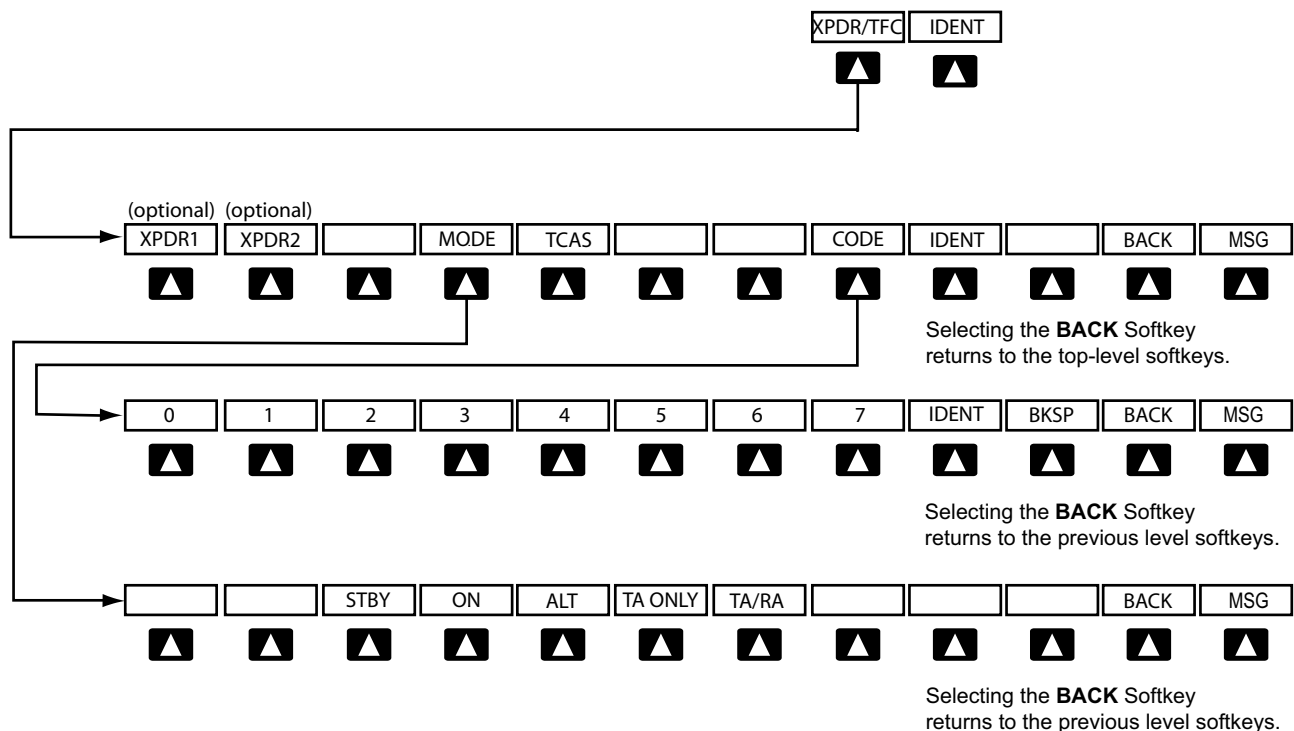

Figure 4-40 Transponder Softkeys (with TCAS II option)

## TCAS II TRANSPONDER MODE SELECTION (OPTIONAL)

Mode selection can be automatic (Altitude Mode) or manual (Standby, On, and Altitude Modes). The **STBY**, **ON**, **ALT**, **TA ONLY**, and **TA/RA** Softkeys can be accessed by selecting the **XPDR/TFC** Softkey, then the **MODE** Softkey.

### Selecting a transponder mode:

- 1) Select the **XPDR/TFC** Softkey.
- 2) Select the **MODE** Softkey to display the Transponder Mode Selection Softkeys.
- 3) Select the desired softkey to activate the transponder mode (STBY, ON, or ALT).

### Selecting a TCAS II mode:

- 1) Select the **XPDR/TFC** Softkey.
- 2) Select the **MODE** Softkey to display the TCAS II Mode Selection Softkeys.
- 2) Select the desired softkey to activate the TCAS II mode (TA ONLY or TA/RA).

## STANDBY MODE (MANUAL)



**NOTE:** In Standby Mode, the IDENT function is inhibited. TCAS II is switched to Standby Mode, because the transponder is not capable of supporting TCAS II operation in Standby Mode.

Standby Mode can be selected at any time by selecting the **STBY** Softkey. In Standby, the transponder does not reply to interrogations, but new codes can be entered. When Standby is selected, a white STBY indication and transponder code appear in the mode field of the Transponder Data Box. In all other modes, these fields appear in green.



Figure 4-41 Standby Mode

### ON MODE (MANUAL)

**NOTE:** TCAS II is switched to Standby Mode, because the transponder is not capable of supporting TCAS II operation in On Mode.

ON Mode can be selected at any time by selecting the **ON** Softkey. ON Mode generates Mode A replies, but Mode C altitude reporting is inhibited. Acquisition squitter and replies to discretely addressed Mode S interrogations are also permitted. In ON Mode, a green ON indication and transponder code appear in the mode field of the Transponder Data Box.

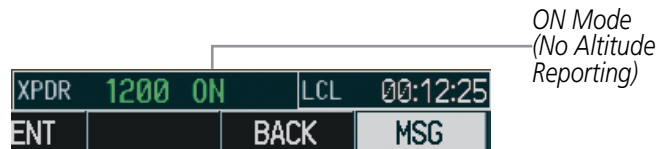

Figure 4-42 ON Mode

### ALTITUDE MODE (AUTOMATIC OR MANUAL)

**NOTE:** TCAS II is switched to Standby Mode when the altitude mode is manually selected using the **ALT** Softkey.

Altitude Mode is automatically selected when the aircraft becomes airborne. Altitude Mode may also be selected manually by selecting the **ALT** Softkey. ALT Mode generates Mode A and Mode C replies. Acquisition squitter and replies to discretely addressed Mode S interrogations are also permitted.

If Altitude Mode is selected, a green ALT indication and transponder code appear in the mode field of the Transponder Data Box, and all transponder replies requesting altitude information are provided with pressure altitude information.



Figure 4-43 Altitude Mode

## ENTERING A TRANSPONDER CODE

### Entering a transponder code with softkeys:

- 1) Select the **XPDR** Softkey to display the Transponder Mode Selection Softkeys.
- 2) Select the **CODE** Softkey to display the Transponder Code Selection Softkeys, for digit entry.
- 3) Select the digit softkeys to enter the code in the code field. When entering the code, the next softkey in sequence must be selected within 10 seconds, or the entry is cancelled and restored to the previous code. Selecting the **BKSP** Softkey moves the code selection cursor to the previous digit. Five seconds after the fourth digit has been entered, the transponder code becomes active.

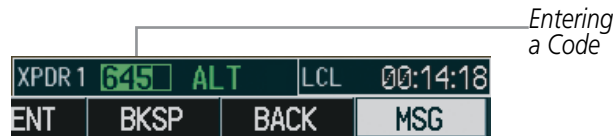

Figure 4-44 Entering a Code

### Entering a transponder code with the PFD FMS Knob:

- 1) Select the **XPDR** and the **CODE** Softkeys as in the previous procedure to enable code entry.
- 2) Turn the small **FMS** Knob on the PFD to enter the first two code digits.
- 3) Turn the large **FMS** Knob to move the cursor to the next code field.
- 4) Enter the last two code digits with the small **FMS** Knob.
- 5) Press the **ENT** Key to complete code digit entry.

Pressing the **CLR** Key or small **FMS** Knob before code entry is complete cancels code entry and restores the previous code. Waiting for 10 seconds after code entry is finished activates the code automatically.



Figure 4-45 Entering a Code with the FMS Knob

**Manual code entry from the Control Unit**

- 1) Press the **XPDR** Key to select the transponder code field.
- 2) Turn the small **FMS** Knob to enter the first two code digits.
- 3) Turn the large **FMS** Knob to move the cursor to the next code field.
- 4) Enter the last two code digits with the small **FMS** Knob.
- 5) Press the **ENT** Key to complete code digit entry.

**Or:**

- 1) Press the **XPDR** Key to select the transponder code field.
- 2) Press the numeric keys on the keypad to enter a code.

If an error is made during code entry with the numeric keypad, pressing the **BKSP** Key moves the cursor back one space. If an incorrect code is entered, reenter the correct one using the same procedure.

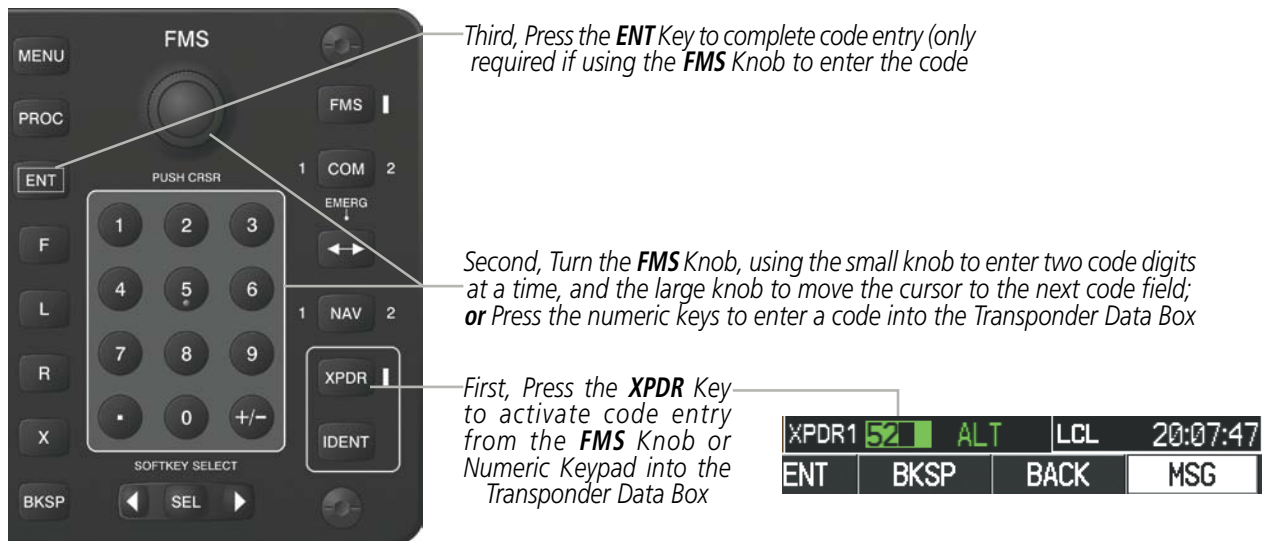

**Figure 4-46 Transponder Code Entry from the Control Unit**

### VFR CODE

The VFR code can be entered either manually or by selecting the **XPDR** Softkey, then the **VFR** Softkey. When the **VFR** Softkey is selected, the pre-programmed VFR code is automatically displayed in the code field of the Transponder Data Box. Selecting the **VFR** Softkey again restores the previous identification code.

The pre-programmed VFR Code is set at the factory to 1200. If a VFR code change is required, contact a Garmin-authorized service center for configuration.

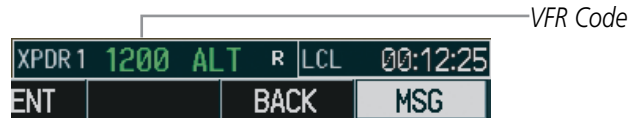

Figure 4-47 VFR Code

### IDENT FUNCTION

**NOTE:** In Standby Mode, the **IDENT** Softkey is inoperative.

Selecting the **IDENT** Softkey or the **IDENT** Key on the Control Unit sends a distinct identity indication to Air Traffic Control (ATC). The indication distinguishes the identifying transponder from all the others on the air traffic controller’s screen. The **IDENT** Softkey appears on all levels of transponder softkeys. When the **IDENT** Softkey or the **IDENT** Key is selected, a green IDNT indication is displayed in the mode field of the Transponder Data Box for a duration of 18 seconds.

After the **IDENT** Softkey is selected while in Mode or Code Selection, the system reverts to the top-level softkeys.



Figure 4-48 IDENT Softkey and Indication



## FLIGHT ID REPORTING



**NOTE:** If the Flight ID is required but the system is not configured for it, contact a Garmin-authorized service center for configuration.

When the Flight ID must be entered before flight operation, the identifier is placed in the Timer/References Window on the PFD. The Flight ID can be up to eight characters. No space is needed when entering Flight ID. When a Flight ID contains a space, the system automatically removes it upon completion of Flight ID entry. The Flight ID is also displayed on the System - Status Page.

### Entering a Flight ID:

- 1) Select the **TMR/REF** Softkey to display the Timer/References Window.
- 2) Press the **FMS** Knob to activate the selection cursor, if not already activated.
- 3) Turn the large **FMS** Knob to scroll down to the Flight ID.
- 4) Turn the small **FMS** Knob to enter the desired Flight ID.
- 5) Press the **ENT** Key to complete Flight ID entry. The word "updating" appears until the new entry is completed.

If an error is made during Flight ID entry, pressing the **CLR** Key returns to the original Flight ID entry. While entering a Flight ID, turning the **FMS** Knob counterclockwise moves the cursor back one space for each detent of rotation. If an incorrect Flight ID is discovered after the unit begins operation, reenter the correct Flight ID using the same procedure.



Figure 4-49 Timer/References Window, Entering Flight ID

## 4.5 ADDITIONAL AUDIO PANEL FUNCTIONS

### POWER-UP

---

The Audio Panels perform a self-test during power-up. During the self-test all Audio Panel annunciator lights illuminate for approximately two seconds. Once the self-test is completed, most of the settings are restored to those in use before the unit was last turned off. The exceptions are the speaker and intercom, which are always selected during power up.

### MONO/STEREO HEADSETS

---

Stereo headsets are recommended for use in this aircraft.

Using a monaural headset in a stereo jack shorts the right headset channel output to ground. While this does not damage the Audio Panel, a person listening on a monaural headset hears only the left channel in both ears. If a monaural headset is used at one of the passenger positions, any other passenger using a stereo headset hears audio in the left ear only.

### SPEAKER

---

Each Audio Panel controls a separate cabin speaker. Pressing the **SPKR** Key selects and deselects the on-side speaker unless oxygen masks are in use. While using oxygen masks, the on-side cabin speaker is always on, pilot audio is always heard on the speaker, and the **SPKR** Key is disabled (the speaker remains on) on the side in which the oxygen mask is in use.

All of the radios can be heard over the cabin speakers. Speaker audio is muted when the PTT is pressed. The “Stall” aural warning is always heard on the speaker, even when the speaker is not selected.

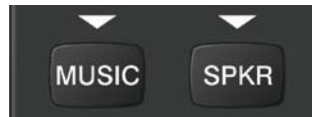

Figure 4-50 Music and Speaker Keys

## INTERCOM

Pressing the **INTR COM** Key on either Audio Panel selects and deselects the intercom on both Audio Panels. The annunciator is lit when the intercom is active. The intercom connects the pilot and copilot together. Either the pilot or copilot may select or deselect the intercom.

The **CABIN** Key initiates two way communication between the pilot or copilot and the passengers in the cabin. The annunciator is lit when the cabin intercom is active on either Audio Panel.

When the flight crew wants to communicate with the passengers, the pilot or copilot presses the **CABIN** Key to signal that communication is desired. The cabin signal must be acknowledged to begin intercom conversation.

When the passengers want to communicate with the pilot/copilot, they press the HAIL Key at their seat in the cabin. The CABIN annunciator flashes on both Audio Panels to signal the pilot and copilot that cabin communication is desired. The hail signal must be acknowledged by pressing the **CABIN** Key to begin intercom conversation.

The **MAN SQ** Key allows either automatic or manual control of the intercom squelch setting. Pressing the **MAN SQ** Key enables manual squelch control, indicated by the MAN SQ annunciator.

- When the MAN SQ Annunciator is extinguished (Automatic Squelch is on), the **ICS** Knob controls only the volume (pressing the **ICS** Knob has no effect on the VOL/SQ selection).
- When the MAN SQ Annunciator is illuminated (Manual Squelch), the **ICS** Knob controls either volume or squelch (selected by pressing the **ICS** Knob and indicated by the VOL or SQ annunciation).

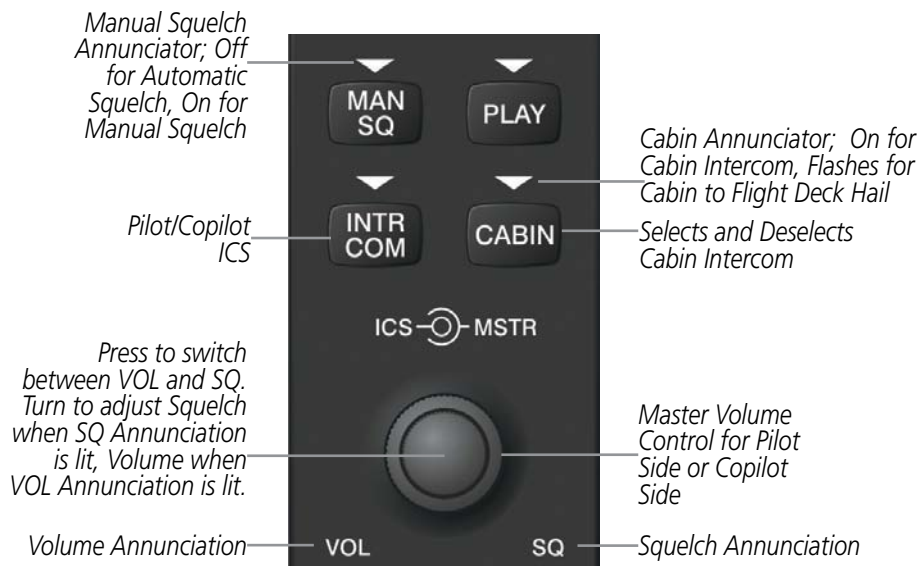

Figure 4-51 Intercom Controls

## PASSENGER ADDRESS (PA) SYSTEM

A passenger address system is provided by pressing the **PA** Key to deliver messages to the passengers. The message is heard by the other pilot on the headset only if the **PA** Key is enabled on both audio panels. PA messages are one way from the flight deck to the passengers.

A Push-to-talk (PTT) must be pressed to deliver PA announcements to the passengers over their headphones.

When PA is selected on the Audio Panel, the annunciator flashes about once per second while pressing the PTT, the COM MIC annunciator is no longer lit, and the active COM frequency for that Audio Panel changes to white, indicating that there is no COM selected.

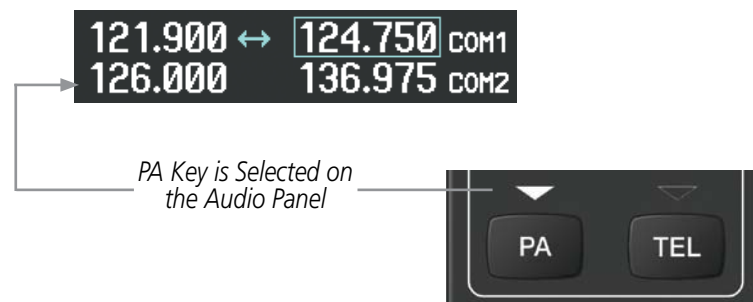

Figure 4-52 PA Key Selected for Cabin Announcements

## SIMULTANEOUS COM OPERATION

Both the pilot and the copilot can transmit and receive simultaneously over separate COM radios. The selected COM MIC Annunciator flashes when either pilot's microphone PTT is pressed.

If both pilots select the same COM radio, the pilot has priority on COM1 and the copilot has priority on COM2.

## CLEARANCE RECORDER AND PLAYER



**NOTE:** Pressing the play key on the pilot's Audio Panel plays recorded audio to the Pilot. Pressing the play key on the Copilot's Audio Panel plays recorded audio to the Copilot.

The Audio Panel contains a digital clearance recorder that continually records up to 2.5 minutes of the selected COM radio signal. Recorded COM audio is stored in separate memory blocks. Once 2.5 minutes of recording time have been reached, the recorder begins recording over the stored memory blocks, starting from the oldest block.

The **PLAY** Key controls the play function. The PLAY annunciator remains lit to indicate when play is in progress. The PLAY annunciator turns off after playback is finished.

Pressing the **PLAY** Key once plays the latest recorded memory block and then returns to normal operation. Pressing the **PLAY** Key again during play of a memory block stops play. If a COM input signal is detected during play of a recorded memory block, play is halted.

Pressing the **PLAY** Key twice within one-half second while audio is playing plays the previous block of recorded audio. Each subsequent two presses of the **PLAY** Key within one-half second backtracks through the recorded memory blocks to reach and play any recorded block.

Powering off the unit automatically clears all recorded blocks.



Figure 4-53 Play Key

## ENTERTAINMENT INPUTS



**NOTE:** *MUSIC 1 and MUSIC 2 inputs cannot be completely turned off. Audio level for MUSIC 1 and MUSIC 2 can be adjusted by a Garmin-authorized service center.*

The Audio Panel provides two stereo auxiliary entertainment inputs: MUSIC 1 and MUSIC 2. These inputs are compatible with popular portable entertainment devices such as MP3 and CD players. Two 3.5-mm stereo phone jacks are installed in convenient locations for audio connection. The headphone outputs of the entertainment devices are plugged into the MUSIC 1 or MUSIC 2 jacks. The availability of the Entertainment Inputs is as shown in the following table.

Pilot Music In (Music 1)	Copilot Music In (Music 2)	Crew	Passengers
OFF*	OFF	GDL 69A (XM Radio)	GDL 69A (XM Radio)
OFF	ON**	Copilot Music In	Copilot Music In
ON	OFF	Pilot Music In	GDL 69A (XM Radio)
ON	ON	Pilot Music In	Copilot Music In

\* OFF means no audio source is plugged into the respective Audio Jack Panel.

\*\*ON means an audio source (e.g MP3 player) is plugged into the respective Audio Jack Panel.

### MUSIC 1

MUSIC 1 can be heard by the pilot and copilot when the **MUSIC** Key is selected.

#### MUSIC 1 MUTING

MUSIC 1 muting occurs when aircraft radio, aural warning alerts, or marker beacon activity is heard. MUSIC 1 is always soft muted when an interruption occurs from an aircraft radio. Soft muting is the gradual return of MUSIC 1 to its original volume level. The time required for MUSIC 1 volume to return to normal is between one-half and four seconds.

### MUSIC 2

MUSIC 2 can be heard only by the passengers. MUSIC 2 is muted during PA announcements and when aircraft radio or marker beacon activity is heard.

### XM RADIO ENTERTAINMENT

XM Radio audio from the Data Link Receiver may be heard by the pilot and passengers simultaneously (optional: requires subscription to XM Radio Service). Refer to the Additional Features Section for more details on the Data Link Receiver.

Connecting a stereo input to either MUSIC 1 or MUSIC 2 jacks removes the XM Radio Audio from that input.

## 4.6 AUDIO PANELS PREFLIGHT PROCEDURE

- NOTE:** If the pilot and/or copilot are using headsets that have a high/low switch or volume control knob, verify that the switch is in the high position and the volume control on the headsets are at maximum volume setting. On single-pilot flights, verify that all other headsets are not connected to avoid excess noise in the audio system.

---

- NOTE:** Adjusting the PILOT volume control affects ICS audio that is heard in the headset for the flight crew member that is performing the adjustment. Keep in mind that the intercom volumes on the Audio Panels are independent of one another, but the radio volumes are not.

---

- NOTE:** When the **MAN SQ** Key is pressed, the ICS squelch can be set manually by the pilot and copilot. If manual squelch is set to full open (SQ annunciated and the knobs turned counterclockwise) background noise is heard in the ICS system as well as during COM transmissions.

After powering up the system, the following steps aid in maximizing the use of the Audio Panels as well as prevent pilot and copilot induced issues. These preflight procedures should be performed each time a pilot boards the aircraft to insure awareness of all audio levels in the Audio Panel and radios.



Figure 4-54 Audio Panel Controls

Independent radio volume adjustments made using the MFD/PFD controls affect only the audio output for each radio selected for adjustment. Radio volume adjustment affects both crew positions equally for each radio that is adjusted. Turning the master volume control located on either Audio Panel affects only the audio heard in the corresponding crew position headset. Thus, radio volume adjustments may be overridden by each crew position independently using the master volume control on the Audio Panel for the respective crew position. The master volume control for each Audio Panel affects all other system audio output for the pilot or copilot headset.

**Setting the Audio Panel volume levels during preflight:**

- 1) Verify the **INTR COM** Key is selected.
- 2) Verify manual squelch is set to minimum.
- 3) Turn the **MSTR** Knob (Master Volume Control) on both Audio Panels clockwise two full turns. This sets the headset audio level to max volume (least amount of attenuation).
- 4) Adjust radio volume levels (COM, NAV, etc.) to a suitable level.
- 5) Adjust the **ICS** volume Knob on each Audio Panel to the desired intercom level.
- 6) Reset squelch to automatic, or adjust to the appropriate level manually.

Once this procedure has been completed, the master volume controls on both Audio Panels may now be adjusted. The flight crew can change settings, keeping in mind the notes above.

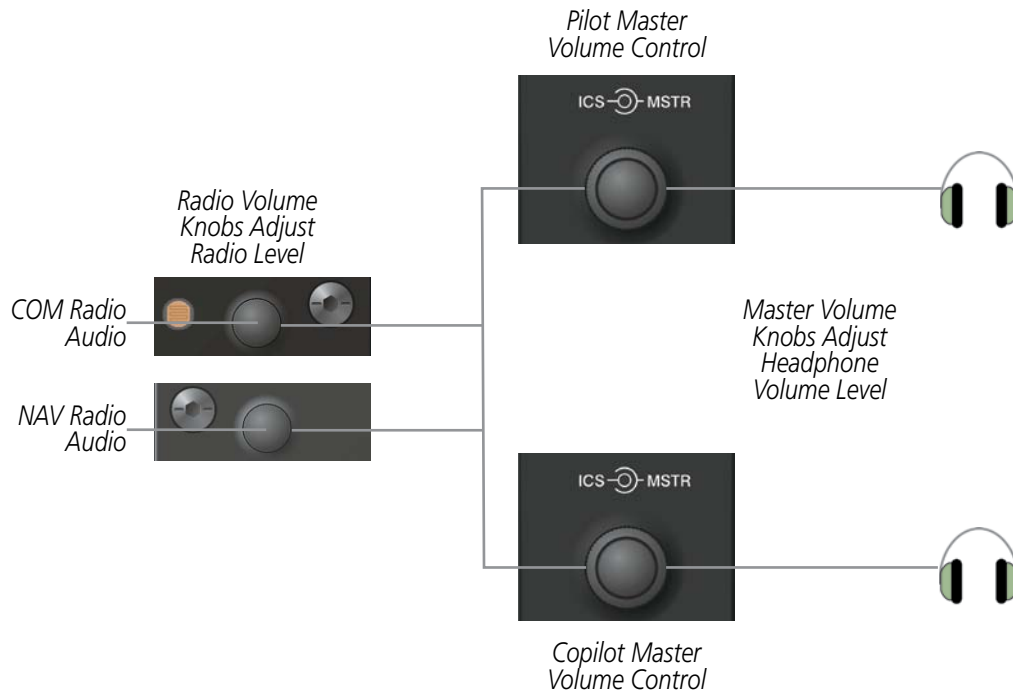

**Figure 4-55 Radio and Headphone Volume Controls**



## 4.7 ABNORMAL OPERATION

Abnormal operation of the system includes failures of the system components and failure of associated equipment, including switches and external devices.

### STUCK MICROPHONE

If the push-to-talk (PTT) Key becomes stuck, the COM transmitter stops transmitting after 35 seconds of continuous operation. An alert appears on the PFD to advise the crew of a stuck microphone.

The **COM1 MIC** or **COM2 MIC** Key Annunciator on the Audio Panel flashes as long as the PTT Key remains stuck.

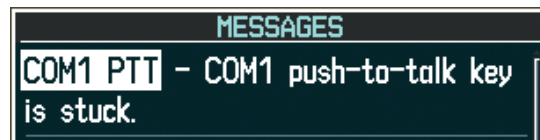

Figure 4-56 Stuck Microphone Alert

### COM TUNING FAILURE

In case of a COM system tuning failure, the emergency frequency (121.500 MHz) is automatically tuned in the radio in which the tuning failure occurred. Depending on the failure mode, a red X may appear on the frequency display.



Figure 4-57 COM Tuning Failure

### PFD OR MFD FAILURE, DUAL SYSTEM

If PFD1 fails, COM1 and NAV1 display a red X on both remaining displays. NAV1 is unavailable. COM1 automatically tunes 121.500 MHz, but the frequency is not shown.



Figure 4-58 Frequency Section of PFD2 Display after PFD1 Failure

If the HSDB switch is in NORMAL MODE and the MFD fails, COM2 and NAV2 display a red X on the remaining PFD display. NAV2 is unavailable. COM2 tunes 121.500 MHz, but the frequency is not shown.

If the HSDB switch is in REV MODE and PFD2 fails, COM2 and NAV2 display a red X on the remaining PFD display. NAV2 is unavailable. COM2 tunes 121.500 MHz, but the frequency is not shown.



Figure 4-59 PFD1 Display after PFD2 Failure with HSDB Switch in REV Mode

## AUDIO PANEL FAIL-SAFE OPERATION

If there is a failure of both Audio Panels, a fail-safe circuit connects the pilot's headset and microphone directly to the COM1 transceiver and the copilot's headset directly to the COM2 transceiver. Audio is not available on the speakers. If there is a failure of one Audio Panel, that side only has access to their respective on-side fail-safe COM.



**NOTE:** Audio is not available on the speakers in case of an Audio Panel and its cross-side GIA unit simultaneous failure.

If there is a failure of one Audio Panel, the remaining Audio Panel does not have access to the other side's COM or NAV. For example, if the pilot side Audio Panel fails, the copilot side Audio Panel has access to all the radios except for COM1 and NAV1. In this case, the copilot can receive the audio from NAV2 and operate COM2 for transmission/reception.

In addition, if there is a failure of one Audio Panel, the following functions are no longer available on the failed side; NAV/ILS audio, speaker, cockpit/cockpit-passengers intercom, aural warning alerts on headset, entertainment inputs, and digital recording radio. Also, if a stereo headset is in use, and an Audio Panel fails, only the left channel will be heard in the headphones.

## REVERSIONARY MODE

The red **DISPLAY BACKUP** Button selects the Reversionary Mode. See the System Overview Section for more information on Reversionary Mode.



Figure 4-60 Reversionary Mode Button

## SECTION 5 FLIGHT MANAGEMENT

### 5.1 INTRODUCTION

The Prodigy® Flight Deck 300 is an integrated flight, engine, communication, navigation and surveillance system. This section of the Pilot's Guide explains flight management using the Prodigy® Flight Deck 300.

The most prominent part of the system are the three full color displays: two Primary Flight Displays (PFD) and a Multi Function Display (MFD). The information to successfully navigate the aircraft using the GPS sensors is displayed on the PFD and the MFD. See examples in the Figure 5-1 and Figure 5-2. Detailed descriptions of flight management functions are discussed later in this section.

A brief description of the GPS navigation data on the PFD and MFD follows.

Navigation mode indicates which sensor is providing the course data (e.g., GPS, VOR) and the flight plan phase (e.g., Departure (DPRT), Terminal (TERM), Enroute (ENR), Oceanic (OCN), Approach (LNAV, LNAV+V, L/VNAV, or LPV), or Missed Approach (MAPR)).

The Inset Map is a small version of the MFD Navigation Map and can be displayed in the lower left corner of the PFD. When the system is in reversionary mode, the Inset Map is displayed in the lower right corner. The Inset Map is displayed by pressing the **INSET** Softkey. Pressing the **INSET** Softkey again, then pressing the **OFF** Softkey removes the Inset Map.

The Navigation Map displays aviation data (e.g., airports, VORs, airways, airspaces), geographic data (e.g., cities, lakes, highways, borders), topographic data (map shading indicating elevation), and hazard data (e.g., traffic, terrain, weather). The amount of displayed data can be reduced by selecting the **DCLTR** Softkey. The Navigation Map can be oriented four different ways: North Up (NORTH UP), Track Up (TRK UP), Desired Track Up (DTK UP), or Heading Up (HDG UP).

An aircraft icon is placed on the Navigation Map at the location corresponding to the calculated present position. The aircraft position and the flight plan legs are accurately based on GPS calculations. The basemap upon which these are placed are from a source with less resolution, therefore the relative position of the aircraft to map features is not exact. The leg of the active flight plan currently being flown is shown as a magenta line on the navigation map. The other legs are shown in white.

There are 28 different map ranges available, from 500 feet to 2000 nm. The current range is indicated in the lower right corner of the map and represents the top-to-bottom distance covered by the map. To change the map range on any map, turn the **Joystick** counter-clockwise to zoom in (-, decreasing), or clockwise to zoom out (+, increasing).

The Direct-to Window, the Flight Plan Window, the Procedures Window, and the Nearest Airports Window can be displayed in the lower right corner of the PFD. Details of these windows are discussed in detail later in the section.



Figure 5-1 GPS Navigation Information on the PFD

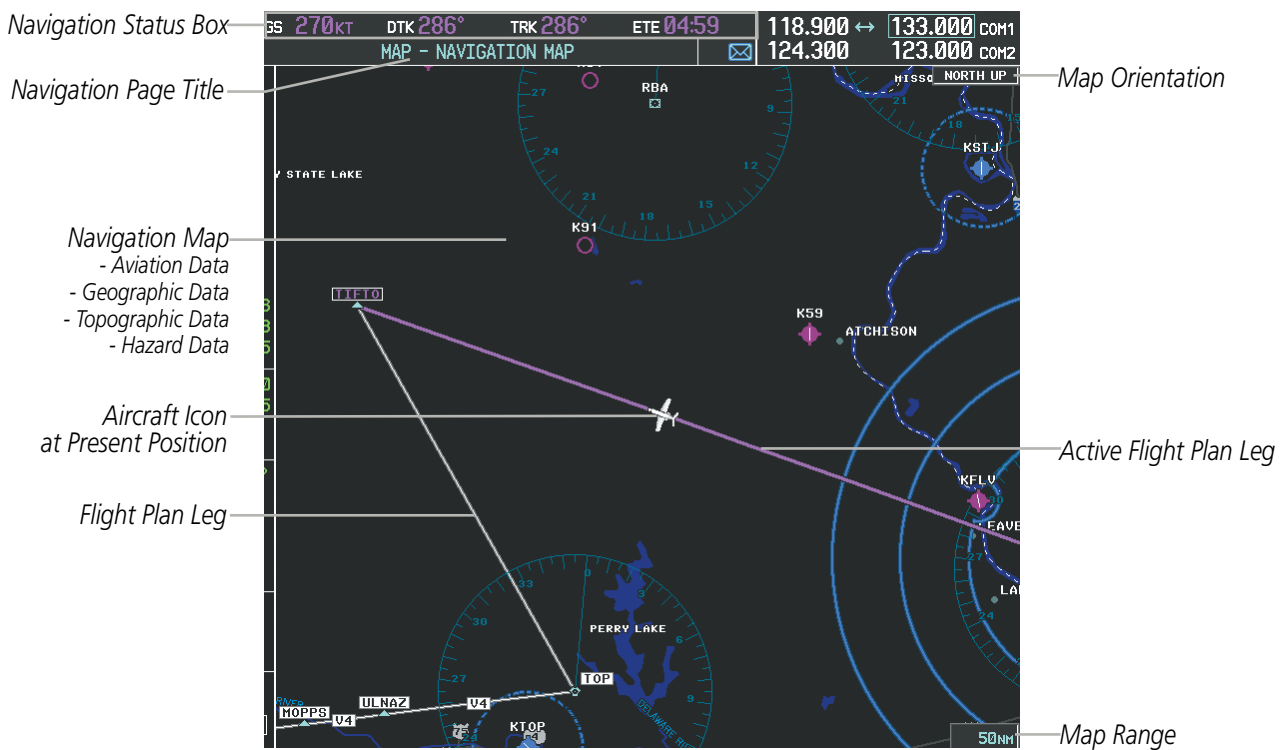

Figure 5-2 GPS Navigation Information on the MFD Navigation Page

## NAVIGATION STATUS BOX

The Navigation Status Box located at the top of the PFD contains two fields displaying the following information:



PFD Navigation Status Box

- Active flight plan leg (e.g., ‘D-> KICT’ or ‘KIXD -> KCOS’) **or** flight plan annunciations (e.g., ‘Turn right to 021° in 8 seconds’)
- Distance (DIS) and Bearing (BRG) to the next waypoint **or** flight plan annunciations (e.g., ‘TOD within 1 minute’)

The symbols used in the PFD status bar are:

Symbol	Description
	Active Leg
	Direct-to
	Right Procedure Turn
	Left Procedure Turn
	Right Holding Pattern
	Left Holding Pattern
	Vector to Final
	Right DME Arc
	Left DME Arc

The Navigation Status Box located at the top of the MFD contains four data fields, each displaying one of the following items:

- Bearing (BRG)
- Distance (DIS)
- Desired Track (DTK)
- Endurance (END)
- Enroute Safe Altitude (ESA)
- Estimated Time of Arrival (ETA)
- Estimated Time Enroute (ETE)
- Fuel on Board (FOB)
- Fuel over Destination (FOD)
- Ground Speed (GS)
- Minimum Safe Altitude (MSA)
- True Air Speed (TAS)
- Track Angle Error (TKE)
- Track (TRK)
- Vertical Speed Required (VSR)
- Crosstrack Error (XTK)



MFD Navigation Status Box

The navigation information displayed in the four data fields can be selected on the MFD Data Bar Fields Box on the AUX - System Setup Page. The default selections (in order left to right) are GS, DTK, TRK, and ETE.

**Changing a field in the MFD Navigation Status Box:**

- 1) Select the System Setup Page.
- 2) Press the **FMS** Knob momentarily to activate the flashing cursor.
- 3) Turn the large **FMS** Knob to highlight the desired field number in the MFD Data Bar Fields Box.
- 4) Turn the small **FMS** Knob to display and scroll through the data options list.
- 5) Select the desired data.
- 6) Press the **ENT** Key. Selecting the **DFLTS** Softkey returns all fields to the default setting.

## 5.2 USING MAP DISPLAYS

Map displays are used extensively to provide situational awareness in flight. Most maps can display the following information:

- Airports, NAVAIDs, airspaces, airways, land data (highways, cities, lakes, rivers, borders, etc.) with names
- Map Pointer information (distance and bearing to pointer, location of pointer, name, and other pertinent information)
- Map range
- Wind direction and speed
- Map orientation
- Icons for enabled map features
- Aircraft icon (representing present position)
- Nav range ring
- Fuel range ring
- Flight plan legs
- User waypoints
- Track vector
- Topography scale
- Topography data
- Obstacle data

The information in this section applies to the following maps unless otherwise noted:

- All Map Group Pages (MAP)
- All Waypoint Group Pages (WPT)
- AUX - Trip Planning
- All Nearest Group Pages (NRST)
- Flight Plan Pages (FPL)
- Direct-to Window
- PFD Inset Map
- Procedure Loading Pages

### MAP ORIENTATION

Maps are shown in one of four different orientation options, allowing flexibility in determining aircraft position relative to other items on the map (north up) or for determining where map items are relative to where the aircraft is going (track up, desired track up, or heading up). The map orientation is shown in the upper right corner of the map.

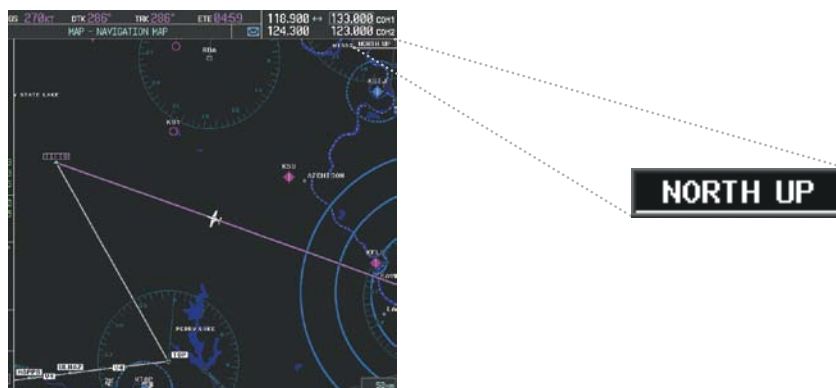

Figure 5-3 Map Orientation

- North up (NORTH UP) aligns the top of the map display to north (default setting).
- Track up (TRK UP) aligns the top of the map display to the current ground track.



- Desired track up (DTK UP) aligns the top of the map display to the desired course.
- Heading up (HDG UP) aligns the top of the map display to the current aircraft heading.

**NOTE:** When panning or reviewing active flight plan legs in a non-North Up orientation, the map does not show the map orientation nor the wind direction and speed.

**NOTE:** Map orientation can only be changed on the Navigation Map Page. Any other displays that show navigation data reflect the orientation selected for the Navigation Map Page.

**Changing the Navigation Map orientation:**

- 1) With the Navigation Map Page displayed, press the **MENU** Key. The cursor flashes on the 'Map Setup' option.



**Figure 5-4 Navigation Map Page Menu Window**

- 2) Press the **ENT** Key to display the Map Setup Window.
- 3) Turn the large **FMS** Knob, or press the **ENT** Key once, to select the 'ORIENTATION' field.



**Figure 5-5 Map Setup Menu Window - Map Group**



- 4) Turn the small **FMS** Knob to select the desired orientation.
- 5) Press the **ENT** Key to select the new orientation.
- 6) Press the **FMS** Knob to return to the base page.

## MAP RANGE

There are 28 different map ranges available, from 500 feet to 2000 nm. The current range is indicated in the lower right corner of the map and represents the top-to-bottom distance covered by the map. When the map range is decreased to a point that exceeds the capability of the system to accurately represent the map, a magnifying glass icon is shown to the left of the map range. To change the map range turn the **Joystick** counter-clockwise to decrease the range, or clockwise to increase the range.

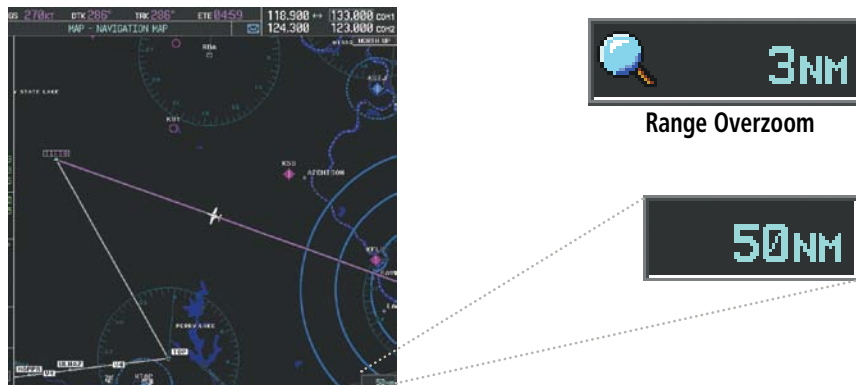

Figure 5-6 Map Range

## AUTO ZOOM

Auto zoom allows the system to change the map display range to the smallest range clearly showing the active waypoint. Auto zoom can be overridden by adjusting the range with the Joystick, and remains until the active waypoint changes, a terrain or traffic alert occurs, the aircraft takes off, or the manual override times out (timer set on Map Setup Window).

If a terrain caution or warning occurs, any map page displaying terrain data automatically adjusts to the smallest map range clearly showing the highest priority alert. If a new traffic advisory alert occurs, any map page capable of displaying traffic advisory alerts automatically adjusts to the smallest map range clearly showing the traffic advisory. When terrain or traffic alerts clear, the map returns to the previous auto zoom range based on the active waypoint.

The auto zoom function can be turned on or off independently for the PFDs and MFD. Control of the ranges at which the auto zoom occurs is done by setting the minimum and maximum 'look forward' times (set on the Map Setup Window for the Map Group). These settings determine the minimum and maximum distance to display based upon the aircraft's ground speed.

- Waypoints that are long distances apart cause the map range to increase to a point where many details on the map are decluttered. If this is not acceptable, lower the maximum look ahead time to a value that limits the auto zoom to an acceptable range.
- Waypoints that are very short distances apart cause the map range to decrease to a point where situational awareness may not be what is desired. Increase the minimum look ahead time to a value that limits the auto zoom to a minimum range that provides acceptable situational awareness.
- Flight plans that have a combination of long and short legs cause the range to increase and decrease as waypoints sequence. To avoid this, auto zoom can be disabled or the maximum/minimum times can be adjusted.
- The 'time out' time (configurable on the Map Setup Page for the Map Group) determines how long auto zoom is overridden by a manual adjustment of the range knob. At the expiration of this time, the auto zoom range is restored. Setting the 'time out' value to zero causes the manual override to never time out.
- When the maximum 'look forward' time is set to zero, the upper limit becomes the maximum range available (2000 nm).
- When the minimum 'look forward' time is set to zero, the lower limit becomes 1.5 nm.

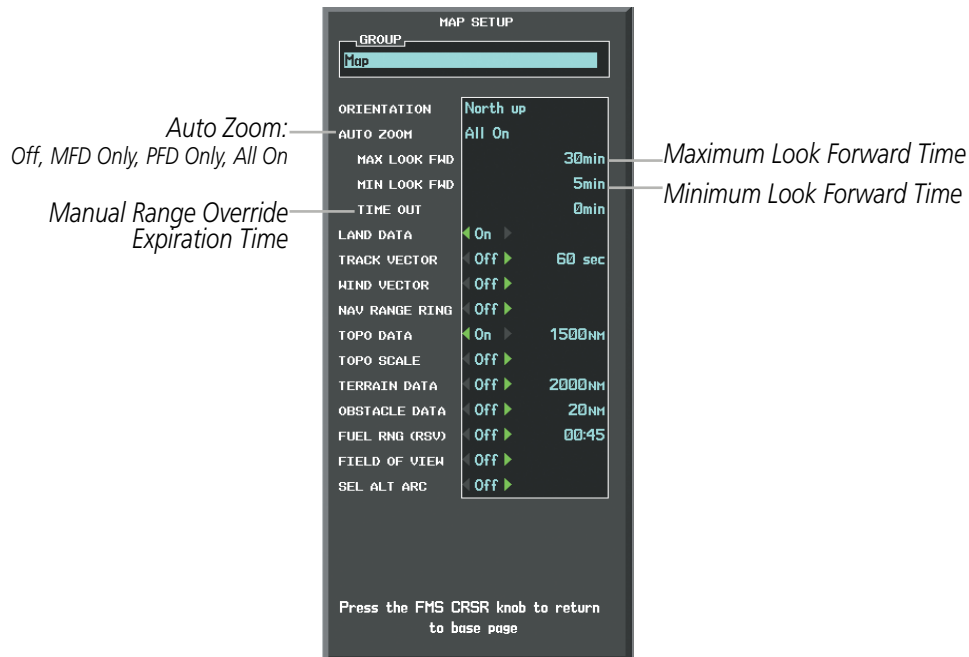

Figure 5-7 Map Setup Menu Window - Map Group, Auto Zoom

### Configuring automatic zoom:

- 1) Press the **MENU** Key with the Navigation Map Page displayed. The cursor flashes on the 'Map Setup' option.
- 2) Press the **ENT** Key. The Map Setup Menu is displayed.
- 3) Select the 'Map' group.
- 4) Press the **ENT** Key.
- 5) Highlight the 'AUTO ZOOM' field.
- 6) Select 'Off', 'MFD Only', 'PFD Only', or 'ALL On'.
- 7) Press the **ENT** Key to accept the selected option. The flashing cursor highlights the 'MAX LOOK FWD' field. Times are from zero to 999 minutes.
- 8) Use the **FMS** Knobs to set the time. Press the **ENT** Key.
- 9) Repeat step 8 for 'MIN LOOK FWD' (zero to 99 minutes) and 'TIME OUT' (zero to 99 minutes).
- 10) Press the **FMS** Knob to return to the Navigation Map Page.

## MAP PANNING

Map panning allows the pilot to:

- View parts of the map outside the displayed range without adjusting the map range
- Highlight and select locations on the map
- Review information for a selected airport, NAVAID or user waypoint
- Designate locations for use in flight planning
- View airspace and airway information

When the panning function is selected by pressing the **Joystick**, the Map Pointer flashes on the map display. A window also appears at the top of the map display showing the latitude/longitude position of the pointer, the bearing and distance to the pointer from the aircraft's present position, and the elevation of the land at the position of the pointer.



Figure 5-8 Navigation Map - Map Pointer Activated



**NOTE:** The map is normally centered on the aircraft's position. If the map has been panned and there has been no pointer movement for about 60 seconds, the map reverts back to centered on the aircraft position and the flashing pointer is removed.

When the Map Pointer is placed on an object, the name of the object is highlighted (even if the name was not originally displayed on the map). When any map feature or object is selected on the map display, pertinent information is displayed.

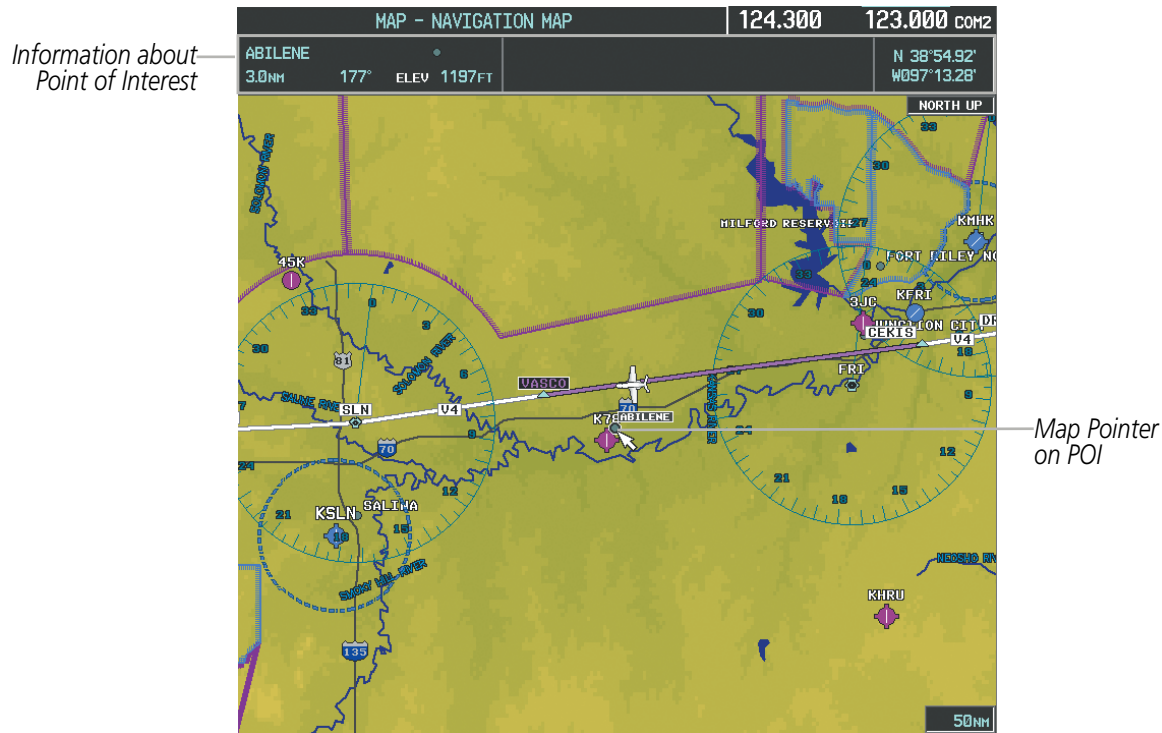

Figure 5-9 Navigation Map - Map Pointer on Point of Interest

When the Map Pointer crosses an airspace boundary, the boundary is highlighted and airspace information is shown at the top of the display. The information includes the name and class of airspace, the ceiling in feet above Mean Sea Level (MSL), and the floor in feet MSL.



Figure 5-10 Navigation Map - Map Pointer on Airspace

**Panning the map:**

- 1) Press the **Joystick** to display the Map Pointer.
- 2) Move the **Joystick** to move the Map Pointer around the map.
- 3) Press the **Joystick** to remove the Map Pointer and recenter the map on the aircraft's current position.

**Reviewing information for an airport, NAVAID, or user waypoint:**

- 1) Place the Map Pointer on a waypoint.
- 2) Press the **ENT** Key to display the Waypoint Information Page for the selected waypoint.
- 3) Select the **GO BACK** Softkey, the **CLR** Key, or the **ENT** Key to exit the Waypoint Information Page and return to the Navigation Map showing the selected waypoint.

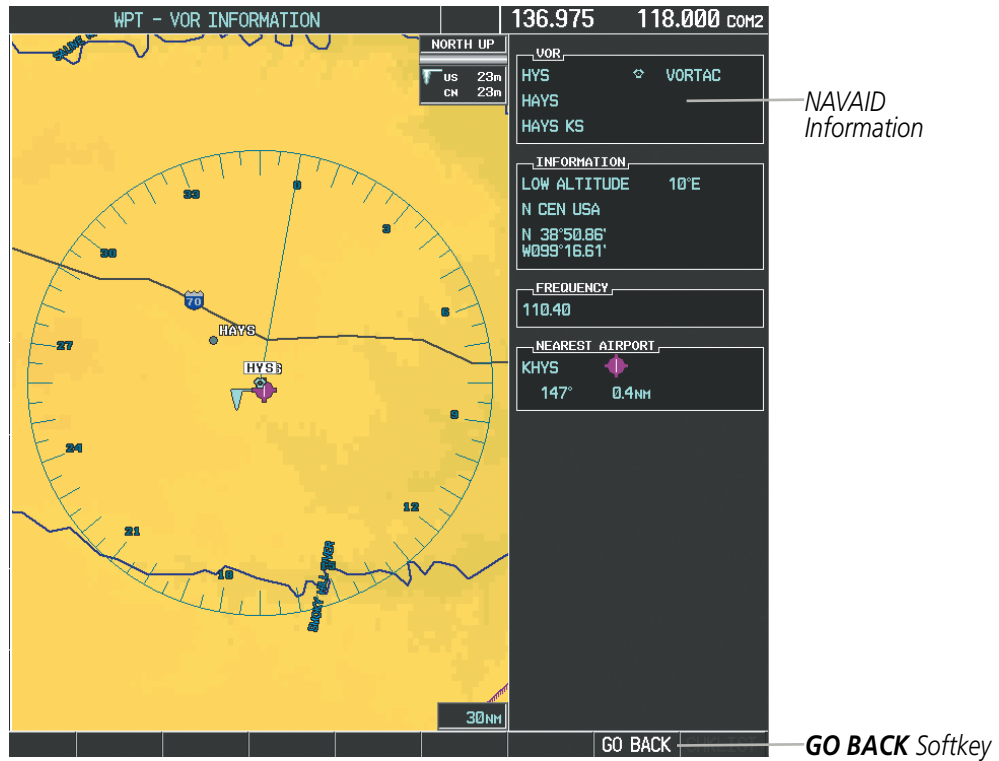

Figure 5-11 Navigation Map - Information Window - NAVAID

**Viewing airspace information for a special-use or controlled airspace:**

- 1) Place the Map Pointer on an open area within the boundaries of an airspace.
- 2) Press the **ENT** Key to display an options menu.
- 3) 'Review Airspaces' should already be highlighted, if not select it. Press the **ENT** Key to display the Airspace Information Page for the selected airspace.
- 4) Press the **CLR** or **ENT** Key to exit the Airspace Information Page.

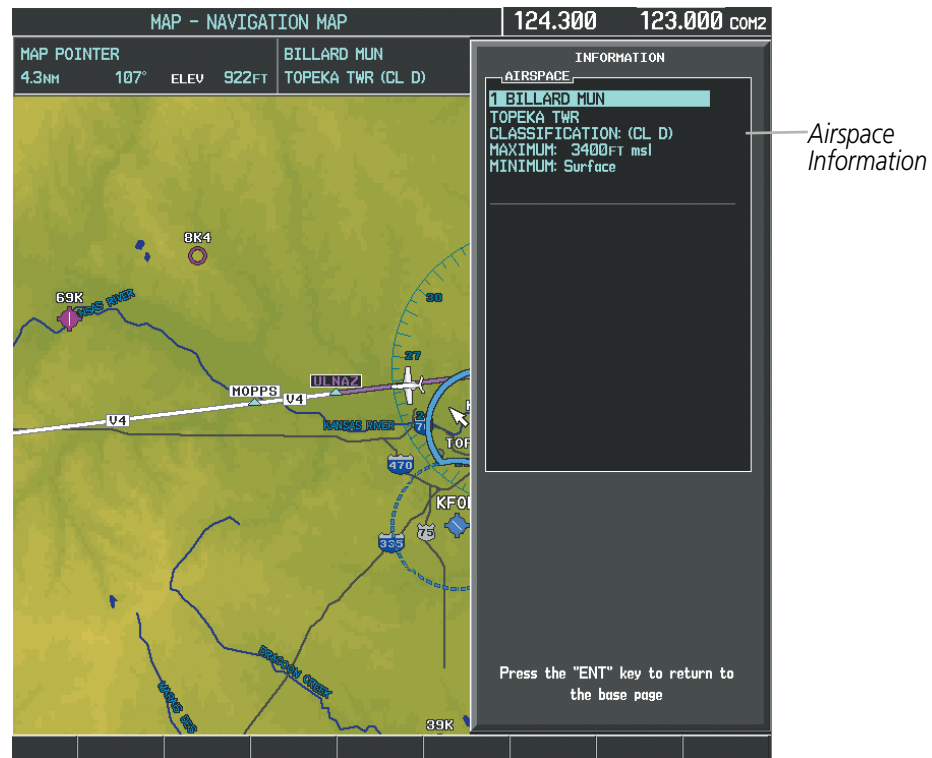

Figure 5-12 Navigation Map - Information Window - Airspace



## MEASURING BEARING AND DISTANCE

Distance and bearing from the aircraft's present position to any point on the viewable navigation map may be calculated using the 'Measure Bearing and Distance' selection from Navigation Map page menu. The bearing and distance tool displays a dashed Measurement Line and a Measure Pointer to aid in graphically identifying points with which to measure. Lat/Long, distance and elevation data for the Measure Pointer is provided in a window at the top of the navigation map.

### Measuring bearing and distance between any two points:

- 1) Press the **MENU** Key (with the Navigation Map Page displayed).
- 2) Highlight the 'Measure Bearing/Distance' field.
- 3) Press the **ENT** Key. A Measure Pointer is displayed on the map at the aircraft's present position.
- 4) Move the **Joystick** to place the reference pointer at the desired location. The bearing and distance are displayed at the top of the map. Elevation at the current pointer position is also displayed. Pressing the **ENT** Key changes the starting point for measuring.
- 5) To exit the Measure Bearing/Distance option, press the **Joystick**; or select 'Stop Measuring' from the Page Menu and press the **ENT** Key.



Figure 5-13 Navigation Map - Measuring Bearing and Distance

**TOPOGRAPHY**

All navigation maps can display various shades of topography colors representing land elevation, similar to aviation sectional charts. Topographic data can be displayed or removed as described in the following procedures.

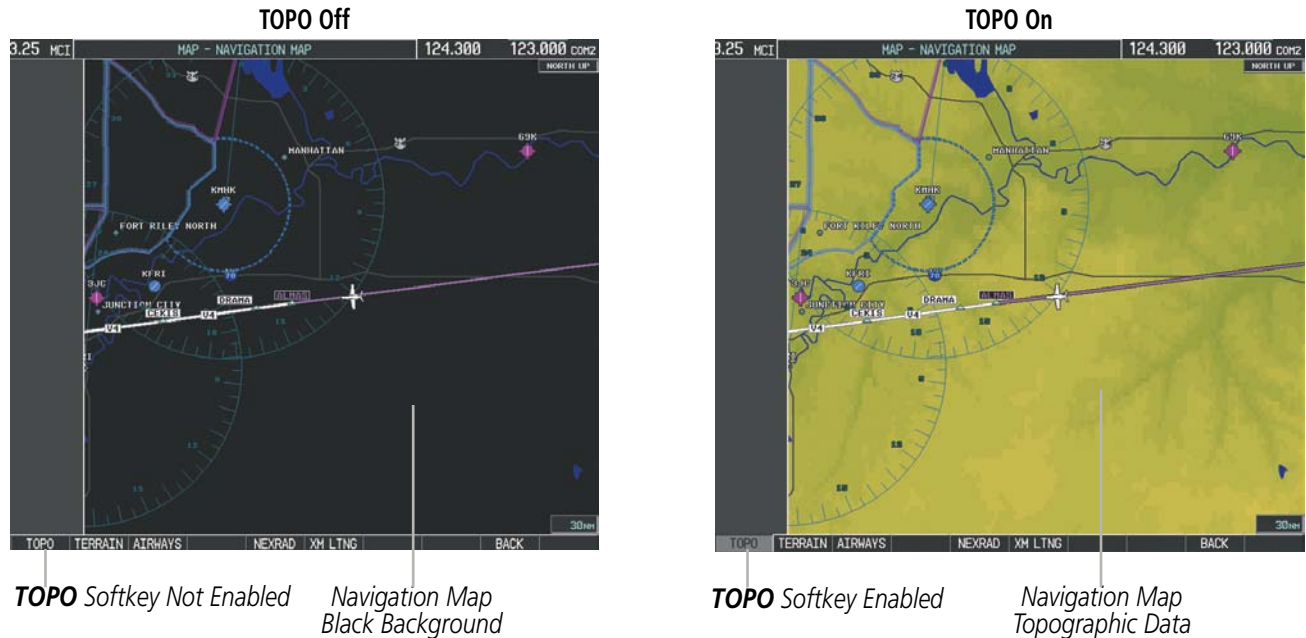

**Figure 5-14 Navigation Map - Topographic Data**

**Displaying/removing topographic data on all pages displaying navigation maps:**

- 1) Select the **MAP** Softkey (the **INSET** Softkey for the PFD Inset Map).
- 2) Select the **TOPO** Softkey.
- 3) Select the **TOPO** Softkey again to remove topographic data from the Navigation Map. When topographic data is removed from the page, all navigation data is presented on a black background.

**Displaying/removing topographic data (TOPO DATA) using the Navigation Map Page Menu:**

- 1) Press the **MENU** Key with the Navigation Map Page displayed. The cursor flashes on the 'Map Setup' option.
- 2) Press the **ENT** Key. The Map Setup Menu is displayed.
- 3) Select the 'Map' group.
- 4) Press the **ENT** Key.
- 5) Highlight the 'TOPO DATA' field.
- 6) Select 'On' or 'Off'.
- 7) Press the **FMS** Knob to return to the Navigation Map Page.

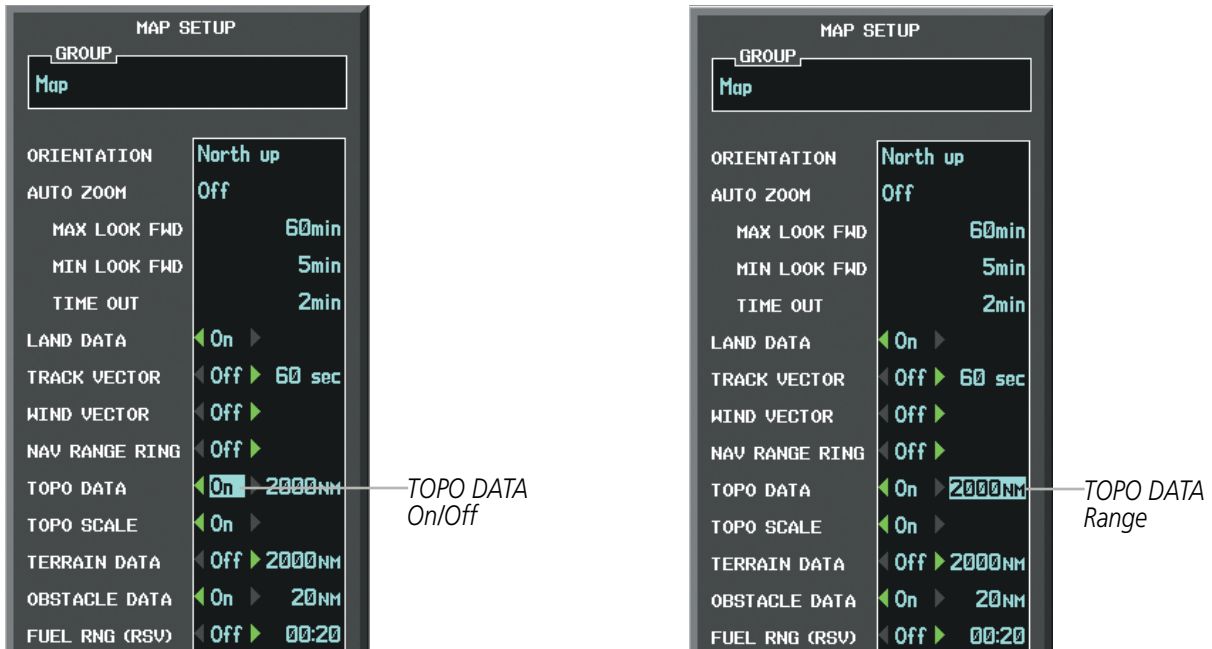

Figure 5-15 Navigation Map Setup Menu - TOPO DATA Setup

The topographic data range is the maximum map range on which topographic data is displayed.



**NOTE:** Since the PFD Inset Map is much smaller than the MFD navigation maps, items are removed on the PFD Inset Map two range levels smaller than the range selected in the Map Setup pages (e.g., a setting of 100 nm removes the item at ranges above 100 nm on MFD navigation maps, while the PFD Inset Map removes the same item at 50 nm).

#### Selecting a topographical data range (TOPO DATA):

- 1) Press the **MENU** Key with the Navigation Map Page displayed. The cursor flashes on the 'Map Setup' option.
- 2) Press the **ENT** Key. The Map Setup Menu is displayed.
- 3) Select the 'Map' group.
- 4) Press the **ENT** Key.
- 5) Highlight the 'TOPO DATA' range field. TOPO ranges are from 500 ft to 2000 nm.
- 6) To change the TOPO range setting, turn the small **FMS** Knob to display the range list.
- 7) Select the desired range using the small **FMS** Knob.
- 8) Press the **ENT** Key.
- 9) Press the **FMS** Knob to return to the Navigation Map Page.

In addition, the Navigation Map can display a topographic scale (located in the lower right hand side of the map) showing a scale of the terrain elevation and current elevation values.

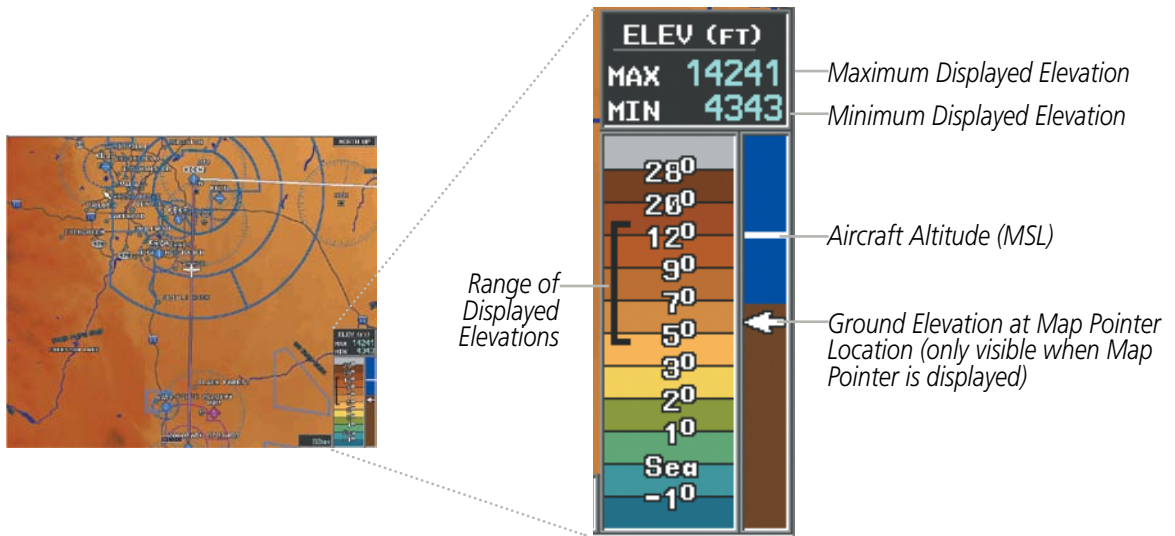

Figure 5-16 Navigation Map - TOPO SCALE

**Displaying/removing the topographic scale (TOPO SCALE):**

- 1) Press the **MENU** Key with the Navigation Map Page displayed. The cursor flashes on the 'Map Setup' option.
- 2) Press the **ENT** Key. The Map Setup Menu is displayed.
- 3) Select the 'Map' group and press the **ENT** Key.
- 4) Highlight the 'TOPO SCALE' field.
- 5) Select 'On' or 'Off'.
- 6) Press the **FMS** Knob to return to the Navigation Map Page.

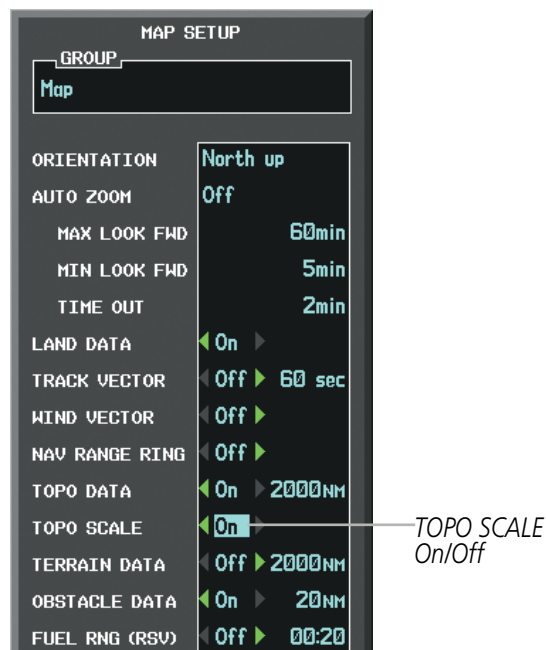

Figure 5-17 Navigation Map Setup Menu - TOPO SCALE Setup

## MAP SYMBOLS

This section discusses the types of land and aviation symbols that can be displayed. Each listed type of symbol can be turned on or off, and the maximum range to display each symbol can be set. The decluttering of the symbols from the map using the **DCLTR** Softkey is also discussed.

### LAND SYMBOLS

The following items are configured on the land menu:













Land Symbols <i>(Text label size can be None, Small, Medium (Med), or Large (Lrg))</i>	Symbol	Default Range (nm)	Maximum Range (nm)
Latitude/Longitude (LAT/LON)		Off	2000
Highways and Roads			
Interstate Highway (FREEWAY)		300	800
International Highway (FREEWAY)		300	800
US Highway (NATIONAL HWY)		30	80
State Highway (LOCAL HWY)		15	30
Local Road (LOCAL ROAD)	N/A	8	15
Railroads (RAILROAD)		15	30
LARGE CITY (> 200,000)		800	1500
MEDIUM CITY (> 50,000)		100	200
SMALL CITY (> 5,000)		20	50
States and Provinces (STATE/PROV)		800	1500
Rivers and Lakes (RIVER/LAKE)		200	500
USER WAYPOINT		150	300

Table 5-1 Land Symbol Information

**AVIATION SYMBOLS**

The following items are configured on the aviation menu:

<b>Aviation Symbols</b> <i>(Text label size can be None, Small, Medium (Med), or Large (Lrg))</i>	<b>Symbol</b>	<b>Default Range (nm)</b>	<b>Maximum Range (nm)</b>
Active Flight Plan Leg (ACTIVE FPL)		2000	2000
Non-active Flight Plan Leg (ACTIVE FPL)		2000	2000
Active Flight Plan Waypoint (ACTIVE FPL WPT)	See Airports, NAVAIDs	2000	2000
Large Airports (LARGE APT)		250	500
Medium Airports (MEDIUM APT)		150	300
Small Airports (SMALL APT)		50	100
Taxiways (SAFETAXI)	See Additional Features	3	20
Runway Extension (RWY EXTENSION)	N/A	Off	100
Intersection (INT WAYPOINT)		15	30
Non-directional Beacon (NDB WAYPOINT)		15	30
VOR (VOR WAYPOINT)		150	300
Class B Airspace/TMA (CLASS B/TMA)		200	500
Class C Airspace/TCA (CLASS C/TCA)		200	500
Class D Airspace (CLASS D)		150	300
Restricted Area (RESTRICTED)		200	500
Military Operations Area [MOA(MILITARY)]		200	500
Other/Air Defense Interdiction Zone (OTHER/ADIZ)		200	500
Temporary Flight Restriction (TFR)		500	2000

**Table 5-2 Aviation Symbol Information**

## SYMBOL SETUP

All pages with maps can display land symbols (roads, lakes, borders, etc). Land symbols can be removed totally (turned off).

### Displaying/removing all land symbols:

- 1) Press the **MENU** Key with the Navigation Map Page displayed. The Page Menu is displayed and the cursor flashes on the 'Map Setup' option.
- 2) Press the **ENT** Key. The Map Setup Group Menu is displayed and the cursor flashes on the 'Map' option.
- 3) Highlight the 'LAND DATA' field.
- 4) Select 'On' or 'Off'.
- 5) Press the **FMS** Knob to return to the Navigation Map Page.

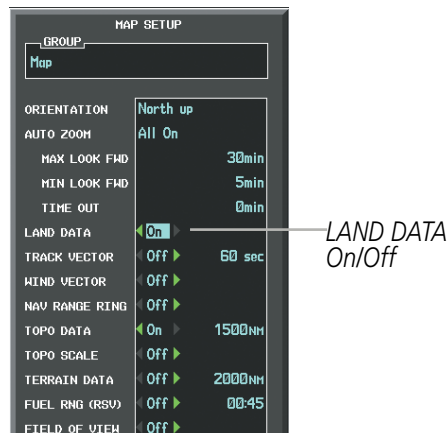

Figure 5-18 Navigation Map Setup Menu - LAND DATA Setup

The label size (TEXT) sets the size at which labels appear on the display (none, small, medium, and large). The range (RNG) sets the maximum range at which items appear on the display.

### Selecting a 'Land' or 'Aviation' group item text size and range:

- 1) Press the **MENU** Key with the Navigation Map Page displayed. The cursor flashes on the 'Map Setup' option.
- 2) Press the **ENT** Key. The Map Setup Menu is displayed.
- 3) Select the 'Land' or 'Aviation' group.
- 4) Press the **ENT** Key. The cursor flashes on the first field.
- 5) Select the desired land option.
- 6) Select the desired text size.
- 7) Press the **ENT** Key to accept the selected size.
- 8) Select the desired range.
- 9) Press the **ENT** Key to accept the selected range.
- 10) Press the **FMS** Knob to return to the Navigation Map Page.

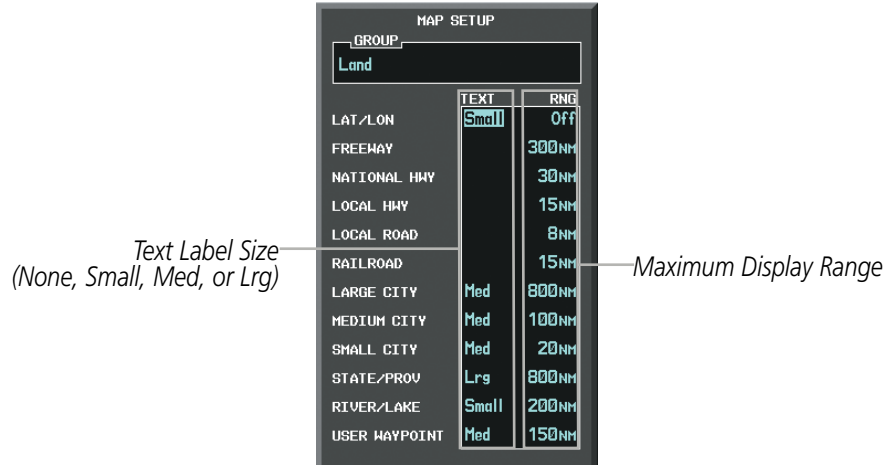

Figure 5-19 Navigation Map Setup Menu - LAND GROUP Setup

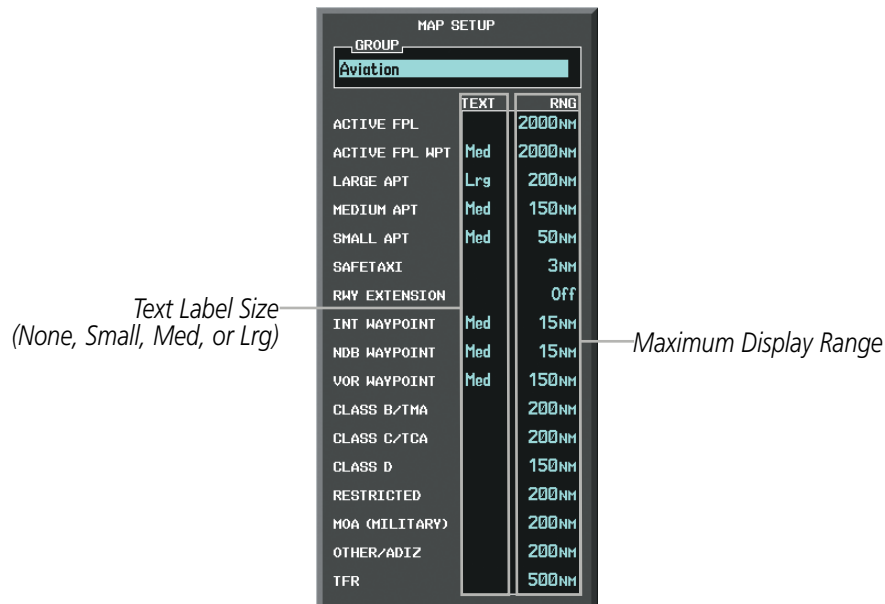

Figure 5-20 Navigation Map Setup Menu - AVIATION GROUP Setup



**NOTE:** Since the PFD Inset Map is much smaller than the MFD navigation maps, items are removed on the PFD Inset Map two range levels smaller than the range selected in the Map Setup pages (e.g., a setting of 100 nm removes the item at ranges above 100 nm on MFD navigation maps, while the PFD Inset Map removes the same item at 50 nm).



## MAP DECLUTTER

The declutter feature allows the pilot to progressively step through four levels of removing map information. The declutter level is displayed in the **DCLTR** Softkey and next to the Declutter Menu Option.



Figure 5-21 Navigation Map - Declutter Level Indications

### Decluttering the map:

Select the **DCLTR** Softkey with the Navigation Map Page displayed. The current declutter level is shown. With each softkey selection, another level of map information is removed.

Or:

- 1) Press the **MENU** Key with the Navigation Map Page displayed.
- 2) Select 'Declutter'. The current declutter level is shown.
- 3) Press the **ENT** Key.

### Decluttering the PFD Inset Map:

- 1) Press the **INSET** Softkey.
- 2) Press the **DCLTR** Softkey. The current declutter level is shown. With each selection, another level of map information is removed.

Table 5-3 lists the items displayed at each declutter level. The 'X' represents map items displayed for the various levels of declutter.

Item	No Declutter	Declutter-1	Declutter-2	Declutter-3
Flight Plan Route Lines	X	X	X	X
Flight Plan Route Waypoints	X	X	X	X
Rivers/Lakes	X	X	X	X
Topography Data	X	X	X	X
International Borders	X	X	X	X
Track Vector	X	X	X	X
Navigation Range Ring	X	X	X	X
Fuel Range Ring	X	X	X	X
Terrain Data	X	X	X	X
Traffic	X	X	X	X
Airways	X	X	X	X
NEXRAD	X	X	X	
XM Lightning Data	X	X	X	
Airports	X	X	X	
Runway Labels	X	X	X	
Restricted	X	X	X	
MOA (Military)	X	X	X	
User Waypoints	X	X		
Latitude/Longitude Grid	X	X		
NAVAIDs	X	X		
Class B Airspaces/TMA	X	X		
Class C Airspaces/TCA	X	X		
Class D Airspaces	X	X		
Other Airspaces/ADIZ	X	X		
TFRs	X	X		
Obstacles	X	X		
Land/Country Text	X			
Cities	X			
Roads	X			
Railroads	X			
State/Province Boundaries	X			
River/Lake Names	X			

**Table 5-3 Navigation Map Items Displayed by Declutter Level**

## AIRWAYS

This airways discussion is based upon the North American airway structure. The airway structure in places other than North America vary by location, etc. and are not discussed in this book. Low Altitude Airways (or Victor Airways) primarily serve smaller piston-engine, propeller-driven airplanes on shorter routes and at lower altitudes. Airways are eight nautical miles wide and start 1,200 feet above ground level (AGL) and extend up to 18,000 feet mean sea level (MSL). Low Altitude Airways are designated with a “V” before the airway number (hence the name “Victor Airways”) since they run primarily between VORs.

High Altitude Airways (or Jet Routes) primarily serve airliners, jets, turboprops, and turbocharged piston aircraft operating above 18,000 feet MSL. Jet Routes start at 18,000 feet MSL and extend upward to 45,000 feet MSL (altitudes above 18,000 feet are called “flight levels” and are described as FL450 for 45,000 feet MSL). Jet Routes are designated with a “J” before the route number.

Low Altitude Airways are drawn in gray (the same shade used for roads). High Altitude Airways are drawn in green. When both types of airways are displayed, High Altitude Airways are drawn on top of Low Altitude Airways.

When airways are selected for display on the map, the airway waypoints (VORs, NDBs and Intersections) are also displayed.

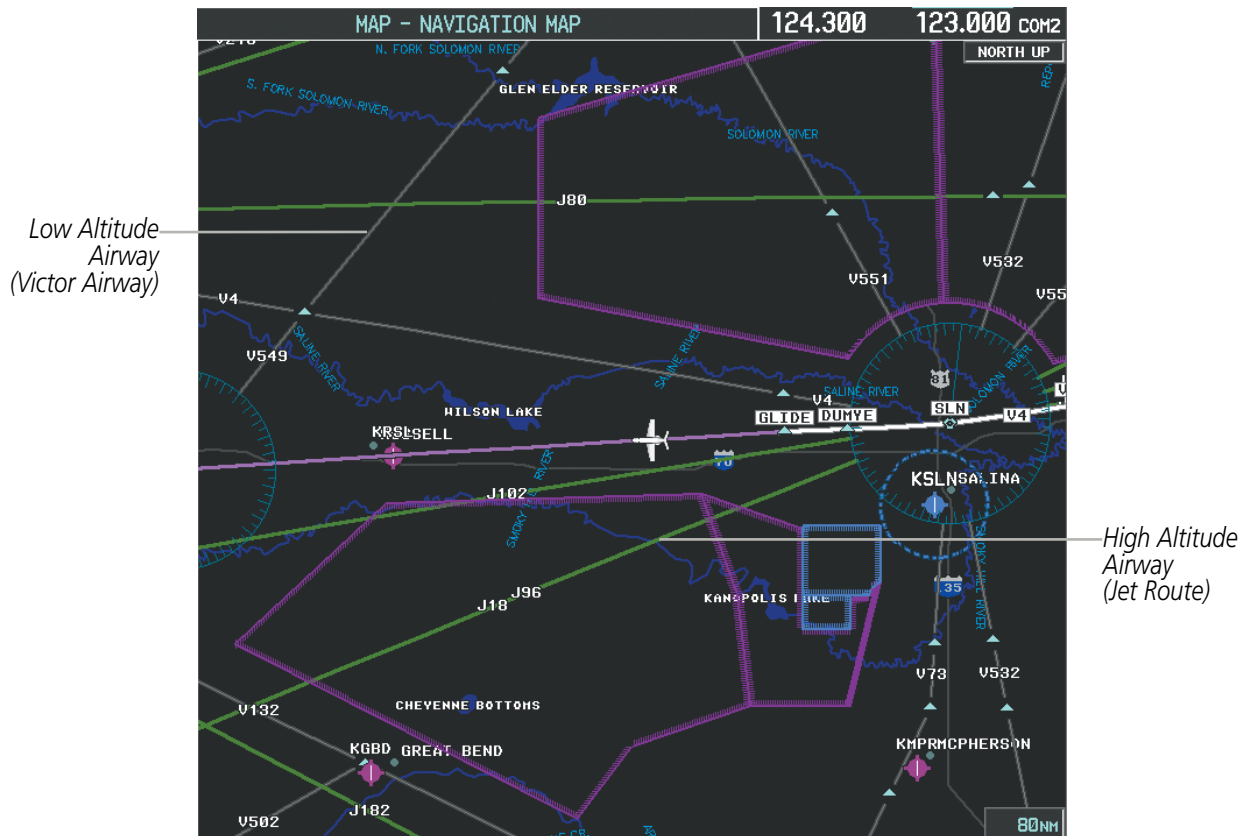

Figure 5-22 Airways on MFD Navigation Page

Airways may be displayed on the map at the pilot's discretion using either a combination of **AIRWAYS** Softkey presses, or menu selections using the **MENU** Key from the Navigation Map Page. The Airway range can also be programmed to only display Airways on the MFD when the map range is at or below a specific number.

**Displaying/removing airways:**

- 1) Select the **MAP** Softkey.
- 2) Select the **AIRWAYS** Softkey. Both High and Low Altitude Airways are displayed (AIRWAY ON).
- 3) Select the softkey again to display Low Altitude Airways only (AIRWAY LO).
- 4) Select the softkey again to display High Altitude Airways only (AIRWAY HI).
- 5) Select the softkey again to remove High Altitude Airways. No airways are displayed (AIRWAYS).

**Or:**

- 1) Press the **MENU** Key with the Navigation Map Page displayed. The cursor flashes on the 'Map Setup' option.
- 2) Press the **ENT** Key. The Map Setup Menu is displayed.
- 3) Turn the small **FMS** Knob to select the 'Airways' group, and press the **ENT** Key.
- 4) Turn the large **FMS** Knob to highlight the 'AIRWAYS' field.
- 5) Turn the **FMS** Knob to select 'Off', 'All', 'LO Only', or 'HI Only', and press the **ENT** Key.
- 6) Press the **FMS** Knob to return to the Navigation Map Page.

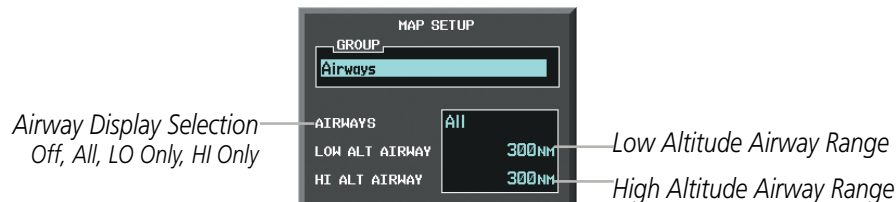

**Figure 5-23 Navigation Map Setup Menu - AIRWAYS Setup**

The airway range is the maximum map range on which airways are displayed.

**Selecting an airway range (LOW ALT AIRWAY or HI ALT AIRWAY):**

- 1) Press the **MENU** Key with the Navigation Map Page displayed. The cursor flashes on the 'Map Setup' option.
- 2) Press the **ENT** Key. The Map Setup Menu is displayed.
- 3) Turn the small **FMS** Knob to select the 'Airways' group, and press the **ENT** Key.
- 4) Highlight the 'LOW ALT AIRWAY' or 'HI ALT AIRWAY' range field.
- 5) To change the range setting, turn the small **FMS** Knob to display the range list.
- 6) Select the desired range using the small **FMS** Knob.
- 7) Press the **ENT** Key.
- 8) Press the **FMS** Knob to return to the Navigation Map Page.

The following range items are configurable on the airways menu:



Airway Type	Symbol	Default Range (nm)	Maximum Range (nm)
Low Altitude Airway (LOW ALT AIRWAY)		200	500
High Altitude Airway (HI ALT AIRWAY)		300	500

Table 5-4 Airway Range Information

## TRACK VECTOR

The Navigation Map can display a track vector that is useful in minimizing track angle error. The track vector is a solid light blue line segment extended to a predicted location. The track vector look-ahead time is selectable (30 sec, 60 sec (default), 2 min, 5 min, 10 min, 20 min) and determines the length of the track vector. The track vector shows up to 90 degrees of a turn for the 30 and 60 second time settings.

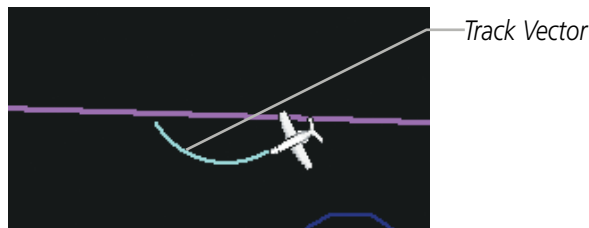

Figure 5-24 Navigation Map -Track Vector

### Displaying/removing the track vector:

- 1) Press the **MENU** Key with the Navigation Map Page displayed. The cursor flashes on the 'Map Setup' option.
- 2) Press the **ENT** Key. The Map Setup Menu is displayed.
- 3) Select the 'Map' group.
- 4) Press the **ENT** Key.
- 5) Highlight the 'TRACK VECTOR' field.
- 6) Select 'On' or 'Off'. Press the **ENT** Key to accept the selected option. The flashing cursor highlights the look ahead time field. Use the **FMS** Knob to select the desired time. Press the **ENT** Key.
- 7) Press the **FMS** Knob to return to the Navigation Map Page.

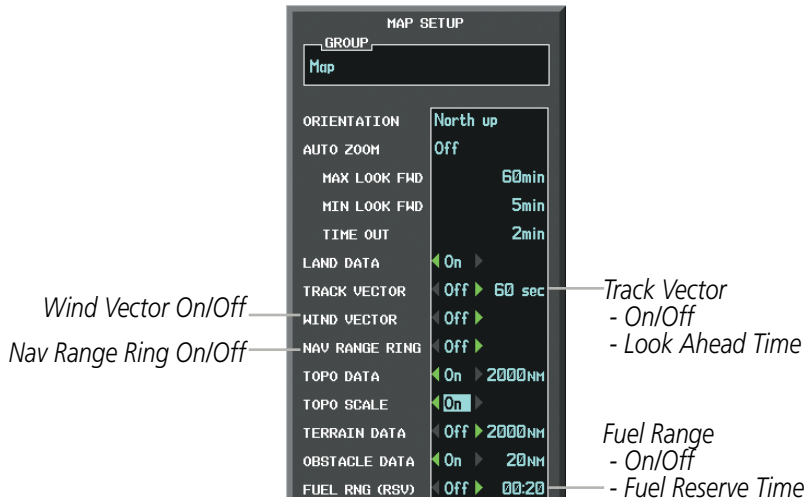

Figure 5-25 Navigation Map Setup Menu -TRACK VECTOR, WIND VECTOR, NAV RANGE RING, FUEL RANGE RING Setup

## WIND VECTOR

The map displays a wind vector arrow in the upper right-hand portion of the screen. Wind vector information is displayed as a white arrow pointing in the direction in which the wind is moving for wind speeds greater than or equal to 1 kt.

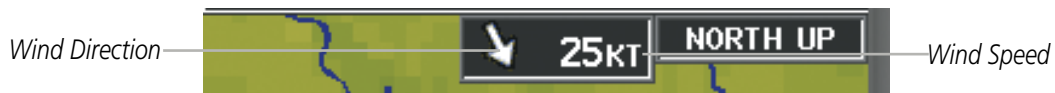

Figure 5-26 Navigation Map - Wind Vector



**NOTE:** The wind vector is not displayed until the aircraft is moving. It is not displayed on the Waypoint Information pages.

### Displaying/removing the wind vector:

- 1) Press the **MENU** Key with the Navigation Map Page displayed. The cursor flashes on the 'Map Setup' option.
- 2) Press the **ENT** Key. The Map Setup Menu is displayed.
- 3) Select the 'Map' group.
- 4) Press the **ENT** Key.
- 5) Highlight the 'WIND VECTOR' field.
- 6) Select 'On' or 'Off'.
- 7) Press the **FMS** Knob to return to the Navigation Map Page.

## NAV RANGE RING

The Nav Range Ring shows the direction of travel (ground track) on a rotating compass card. The range is determined by the map range. The range is 1/4 of the map range (e.g., 37.5 nm on a 150 nm map).

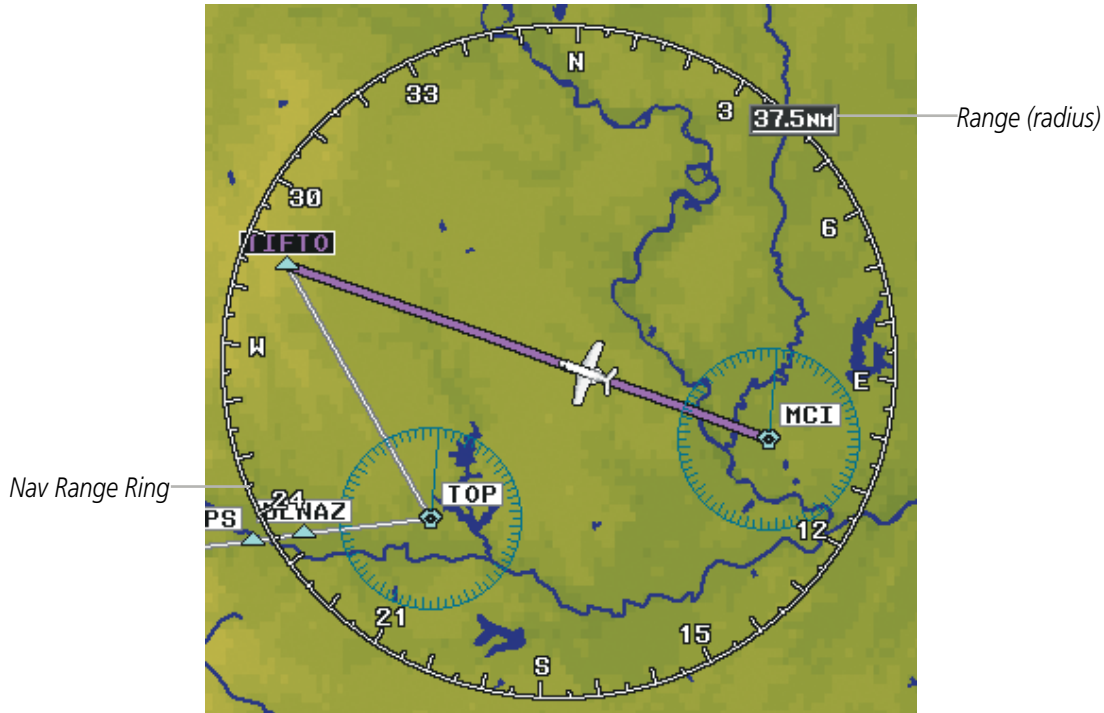

Figure 5-27 Navigation Map - Nav Range Ring



**NOTE:** The Nav Range Ring is not displayed on the Waypoint Information pages, Nearest pages, or Direct-to Window map.

### Displaying/removing the Nav Range Ring:

- 1) Press the **MENU** Key with the Navigation Map Page displayed. The cursor flashes on the 'Map Setup' option.
- 2) Press the **ENT** Key. The Map Setup Menu is displayed.
- 3) Select the 'Map' group.
- 4) Press the **ENT** Key.
- 5) Highlight the 'NAV RANGE RING' field.
- 6) Select 'On' or 'Off'.
- 7) Press the **FMS** Knob to return to the Navigation Map Page.



**NOTE:** The Nav Range Ring is referenced to either magnetic or true north, based on the selection on the AUX - System Setup Page.

**FUEL RANGE RING**

The map can display a fuel range ring which shows the remaining flight distance. A dashed green circle indicates the selected range to reserve fuel. A solid green circle indicates the total endurance range. If only reserve fuel remains, the range is indicated by a solid yellow circle.

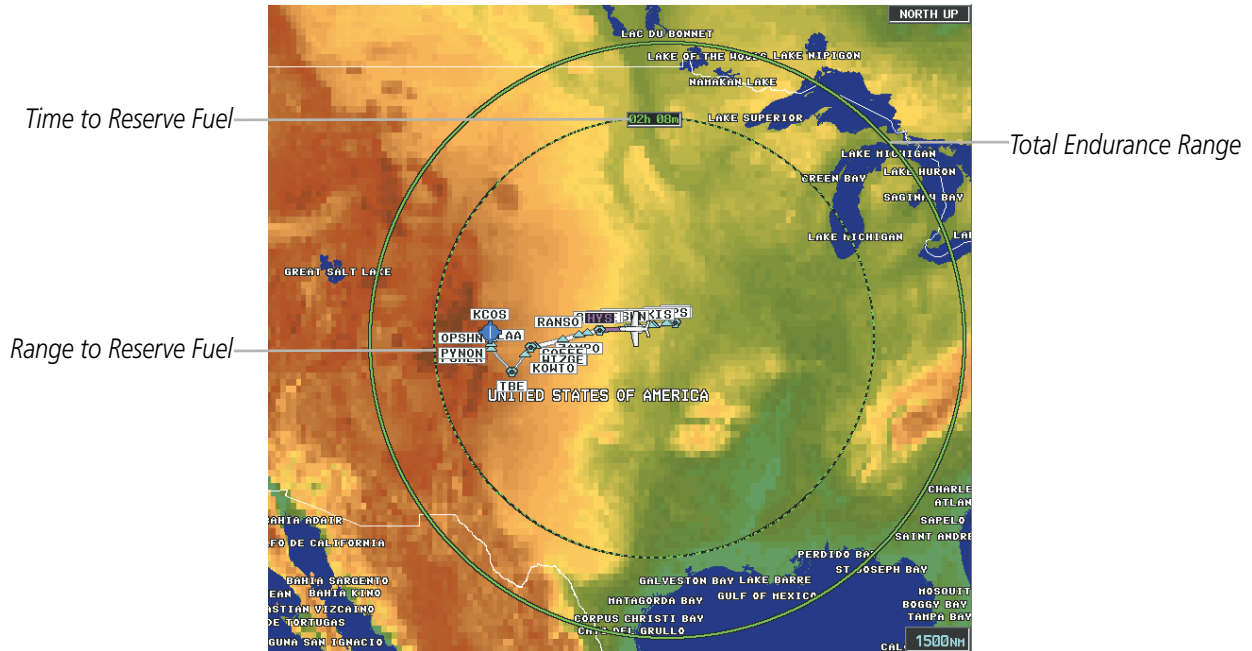

**Figure 5-28 Navigation Map - Fuel Range Ring**

**Displaying/removing the fuel range ring and selecting a fuel range time:**

- 1) Press the **MENU** Key with the Navigation Map Page displayed. The cursor flashes on the 'Map Setup' option.
- 2) Press the **ENT** Key. The Map Setup Menu is displayed.
- 3) Select the 'Map' group.
- 4) Press the **ENT** Key.
- 5) Highlight the 'FUEL RNG (RSV)' field.
- 6) Select 'On' or 'Off'.
- 7) Highlight the fuel reserve time field. This time should be set to the amount of flight time equal to the amount of fuel reserve desired.
- 8) To change the reserve fuel time, enter a time (00:00 to 23:59; hours:minutes). The default setting is 00:45 minutes.
- 9) Press the **ENT** Key.
- 10) Press the **FMS** Knob to return to the Navigation Map Page.



## FIELD OF VIEW (SVS)

The map can display the boundaries of the PFD Synthetic Vision System (SVS) lateral field of view. The field of view is shown as two dashed lines forming a V shape in front of the aircraft symbol on the map. This is only available if SVS is installed on the aircraft.

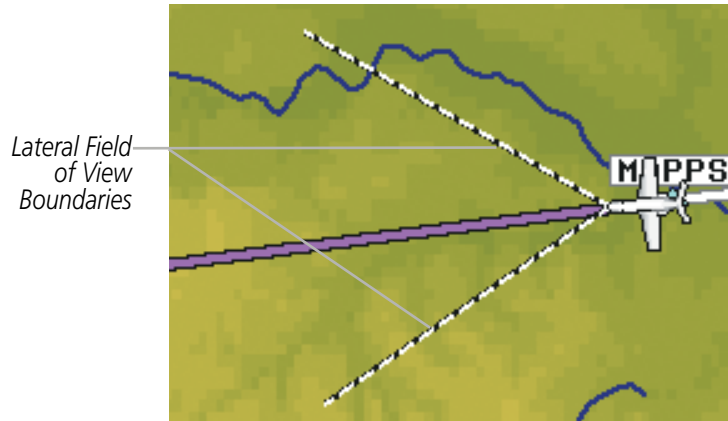

Figure 5-29 Navigation Map - Field of View

### Displaying/removing the field of view:

- 1) Press the **MENU** Key with the Navigation Map Page displayed. The cursor flashes on the 'Map Setup' option.
- 2) Press the **ENT** Key. The Map Setup Menu is displayed.
- 3) Select the 'Map' group.
- 4) Press the **ENT** Key.
- 5) Highlight the 'FIELD OF VIEW' field.
- 6) Select 'On' or 'Off'.
- 7) Press the **FMS** Knob to return to the Navigation Map Page.

## SELECTED ALTITUDE INTERCEPT ARC

The map can display the location along the current track where the aircraft will intercept the selected altitude. The location will be shown as a light blue arc when the aircraft is actually climbing or descending.

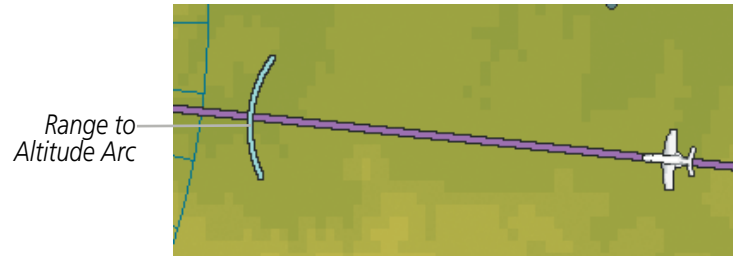

Figure 5-30 Navigation Map - Range to Altitude Arc

### Displaying/removing the selected altitude intercept arc:

- 1) Press the **MENU** Key with the Navigation Map Page displayed. The cursor flashes on the 'Map Setup' option.
- 2) Press the **ENT** Key. The Map Setup Menu is displayed.
- 3) Select the 'Map' group.
- 4) Press the **ENT** Key.
- 5) Highlight the 'SEL ALT ARC' field.
- 6) Select 'On' or 'Off'.
- 7) Press the FMS Knob to return to the Navigation Map Page.

### 5.3 WAYPOINTS

Waypoints are predetermined geographical positions (internal database) or pilot-entered positions, and are used for all phases of flight planning and navigation.

Communication and navigation frequencies can be tuned “automatically” from various Waypoint Information (WPT) pages, Nearest (NRST) pages, and the Nearest Airports Window (on PFD). This auto-tuning feature simplifies frequency entry over manual tuning. Refer to the Audio Panel and CNS section for details on auto-tuning.

Waypoints can be selected by entering the ICAO identifier, entering the name of the facility, or by entering the city name. See the System Overview section for detailed instructions on entering data. As a waypoint identifier, facility name, or location is entered, the Spell’N’Find™ feature scrolls through the database, displaying those waypoints matching the characters which have been entered to that point. A direct-to navigation leg to the selected waypoint can be initiated by pressing the **Direct-to** Key on any of the waypoint pages.

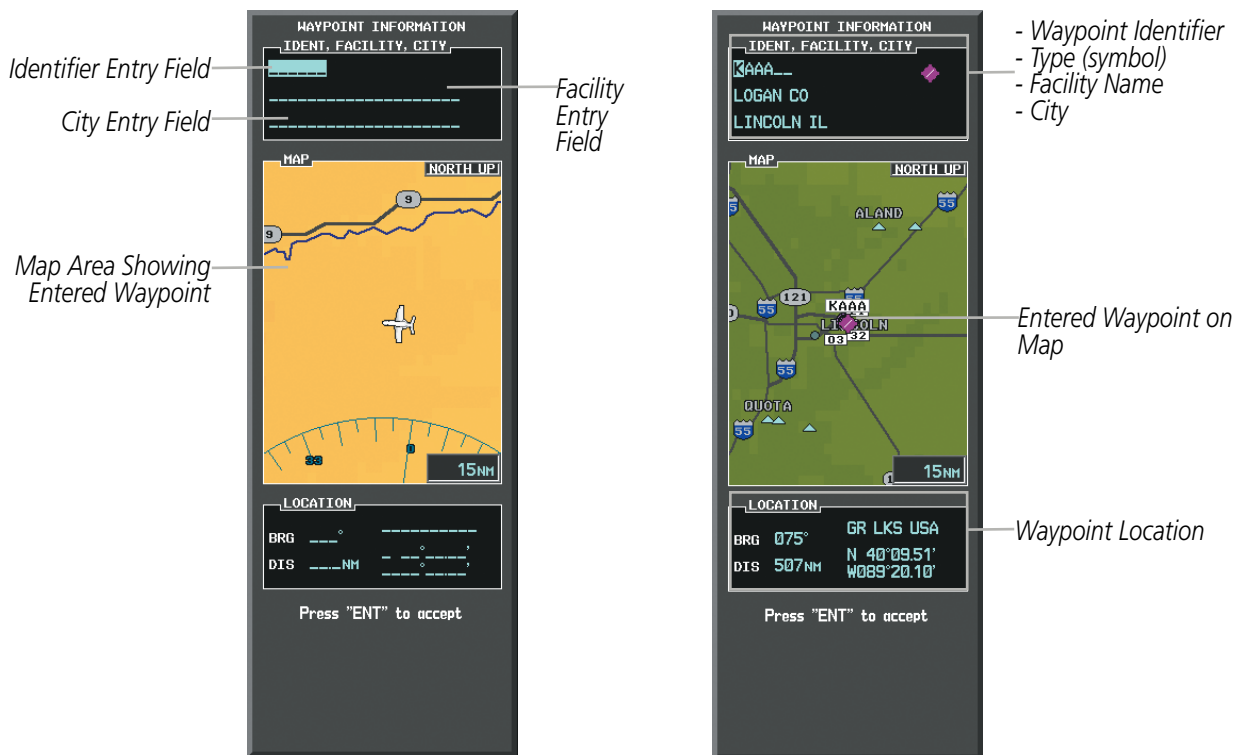

Figure 5-31 Waypoint Information Window

If duplicate entries exist for the entered facility name or location, additional entries may be viewed by continuing to turn the small **FMS** Knob during the selection process. If duplicate entries exist for an identifier, a Duplicate Waypoints Window is displayed when the **ENT** Key is pressed.

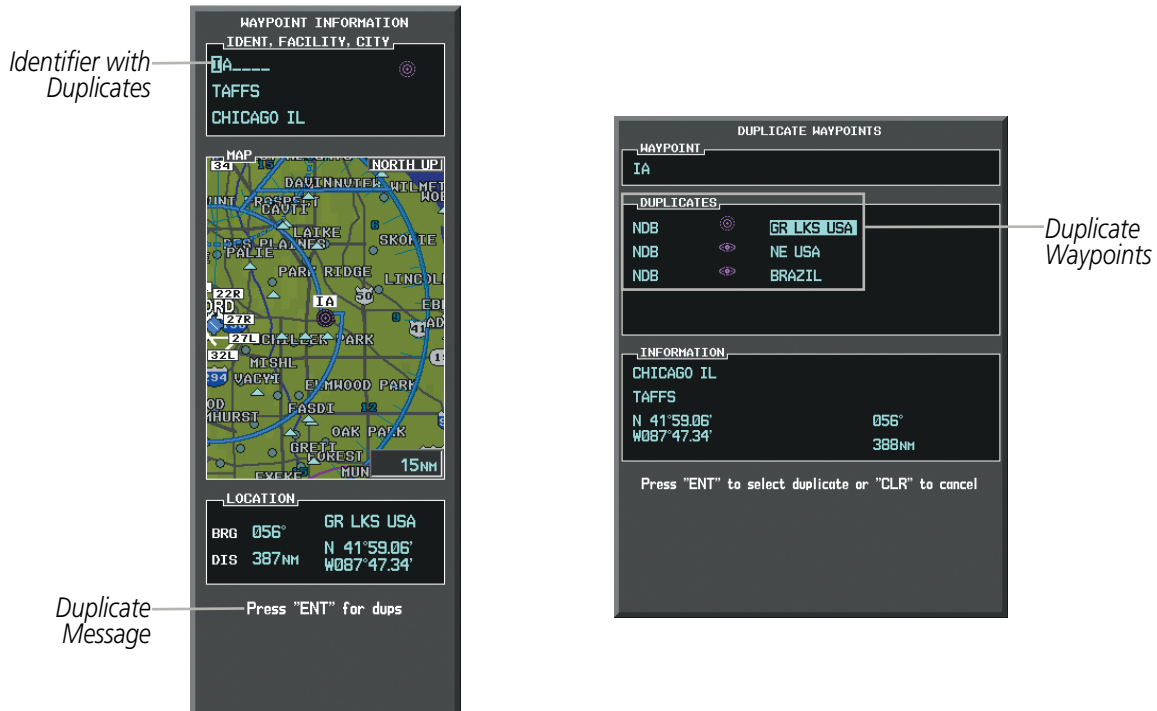

Figure 5-32 Waypoint Information Window - Duplicate Identifier

## AIRPORTS



**NOTE:** 'North Up' orientation on the Airport Information Page cannot be changed; the pilot needs to be aware of proper orientation if the Navigation Map orientation is different from the Airport Information Page Map.

The Airport Information Page is the first page in WPT group and allows the pilot to view airport information, load frequencies (COM, NAV, and lighting), review runways, and review instrument procedures that may be involved in the flight plan. See the Audio Panel and CNS Section for more information on loading frequencies (auto-tuning). After engine startup, the Airport Information Page defaults to the airport where the aircraft is located. After a flight plan has been loaded, it defaults to the destination airport. On a flight plan with multiple airports, it defaults to the airport which is the current active waypoint.

In addition to displaying a map of the currently selected airport and surrounding area, the Airport Information Page displays airport information in three boxes labeled 'AIRPORT', 'RUNWAYS', and 'FREQUENCIES'. For airports with multiple runways, information for each runway is available. This information is viewed on the Airport Information Page by pressing the INFO softkey until **INFO-1** is displayed.

The following descriptions and abbreviations are used on the Airport Information Page:

- Usage type: Public, Military, Private, or Heliport
- Runway surface type: Hard, Turf, Sealed, Gravel, Dirt, Soft, Unknown, or Water
- Runway lighting type: No Lights, Part Time, Full Time, Unknown, or PCL Freq (for pilot-controlled lighting)
- COM Availability: TX (transmit only), RX (receive only), PT (part time), i (additional information available)

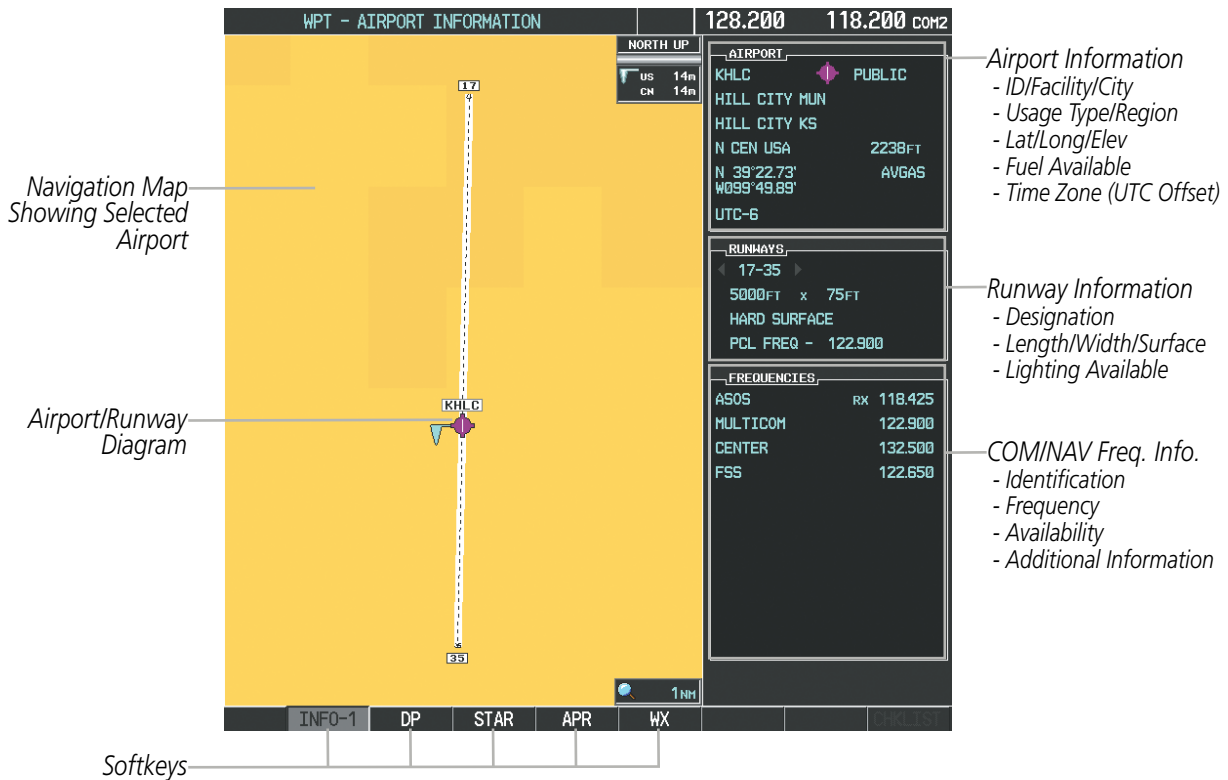
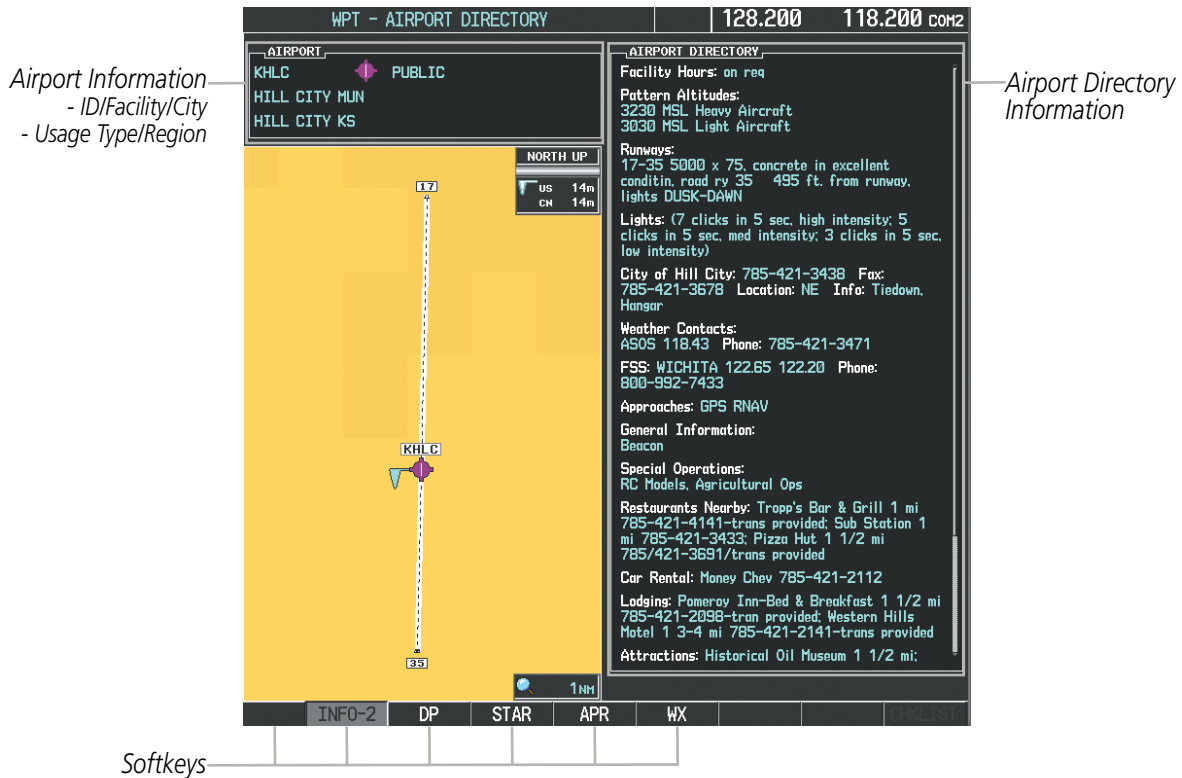

Figure 5-33 Airport Information Page

The AOPA directory information is viewed on the Airport Directory Page by pressing the INFO softkey until **INFO-2** is displayed. The following are types of AOPA airport directory information shown (if available) on the Airport Directory Page:

- **Airport:** Identifier, Site Number, Name, City, State
- **Phones:** Phone/Fax Numbers
- **Hours:** Facility Hours, Light Hours, Tower Hours, Beacon Hours
- **Location:** Sectional, Magnetic Variation
- **Frequencies:** Type/Frequency
- **Transportation:** Ground Transportation Type Available
- **Approach:** Approach Facility Name, Frequency, Frequency Parameter
- **Traffic Pattern Altitudes (TPA):** Aircraft Class/Altitude
- **Weather:** Service Type, Frequency, Phone Number
- **Flight Service Station (FSS):** FSS Name, Phone Numbers
- **Instrument Approaches:** Published Approach, Frequency
- **NAVAIDS:** Type, Identifier, Frequency, Radial, Distance
- **Noise:** Noise Abatement Procedures
- **Charts:** Low Altitude Chart Number
- **Runway:** Headings, Length, Width, Obstructions, Surface
- **Obstructions:** General Airport Obstructions
- **Special Operations at Airport**
- **Services Available:** Category, Specific Service
- **Notes:** Airport Notes
- **Pilot Controlled Lighting:** High/Med/Low Clicks/Second
- **FBO:** Type, Frequencies, Services, Fees, Fuel, Credit Cards, Phone/Fax Numbers



**Figure 5-34 Airport Directory Page Example**

**Selecting an airport for review by identifier, facility name, or location:**

- 1) From the Airport Information Page, press the **FMS** Knob.
- 2) Use the **FMS** Knobs and enter an identifier, facility name, or location.
- 3) Press the **ENT** Key.
- 4) Press the **FMS** Knob to remove the cursor.

**Selecting a runway:**

- 1) With the Airport Information Page displayed, press the **FMS** Knob to activate the cursor.
- 2) Turn the large **FMS** Knob to place the cursor in the 'RUNWAYS' Box, on the runway designator.
- 3) Turn the small **FMS** Knob to display the desired runway (if more than one) for the selected airport.
- 4) To remove the flashing cursor, press the **FMS** Knob.

**Viewing a destination airport:**

From the Airport Information Page press the **MENU** Key. Select 'View Destination Airport'. The Destination Airport is displayed.

The Airport Frequencies Box uses the descriptions and abbreviations listed in the following table:

Communication Frequencies			Navigation Frequencies
Approach *	Control	Pre-Taxi	ILS
Arrival *	CTA *	Radar	LOC
ASOS	Departure *	Ramp	
ATIS	Gate	Terminal *	
AWOS	Ground	TMA *	
Center	Helicopter	Tower	
Class B *	Multicom	TRSA *	
Class C *	Other	Unicom	
Clearance			
* May include Additional Information			

Table 5-5 Airport Frequency Abbreviations

A departure, arrival, or approach can be loaded using the softkeys on the Airport Information Page. See the Procedures section for details. METARs or TAFs applicable to the selected airport can be selected for display (see the Hazard Avoidance section for details about weather).

The system provides a **NRST** Softkey on the PFD, which gives the pilot quick access to nearest airport information (very useful if an immediate landing is required). The Nearest Airports Window displays a list of up to the 25 nearest airports (three entries can be displayed at one time). If there are more than three they are displayed in a scrollable list. If there are no nearest airports available, “NONE WITHIN 200NM” is displayed.

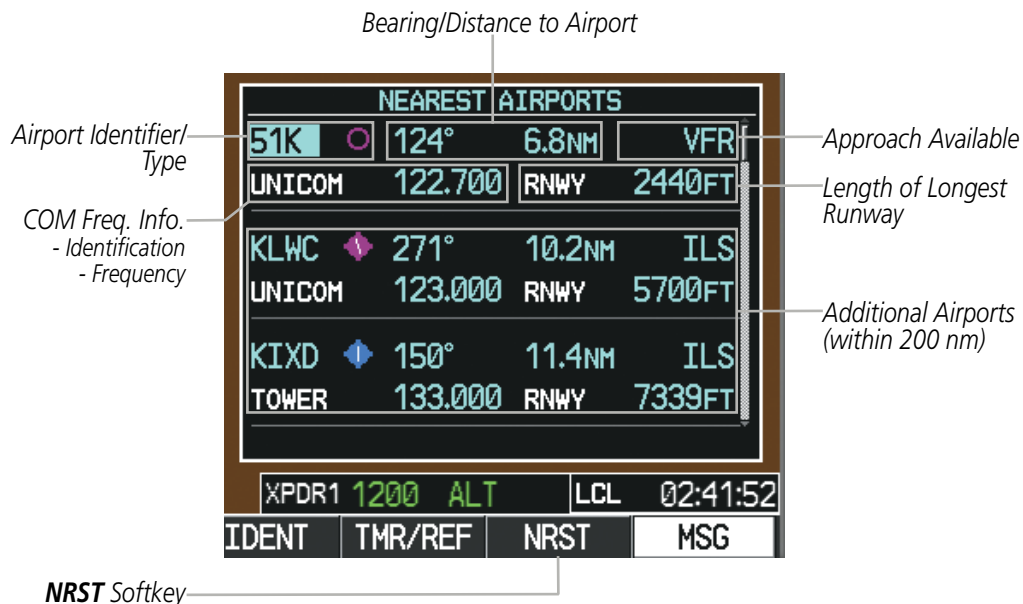

Figure 5-35 Nearest Airports Window on PFD

Pressing the **ENT** Key displays the PFD Airport Information Window for the highlighted airport. Pressing the **ENT** Key again returns to the Nearest Airports Window with the cursor on the next airport in the list. Continued presses of the **ENT** Key sequences through the information pages for all airports in the Nearest Airports list.

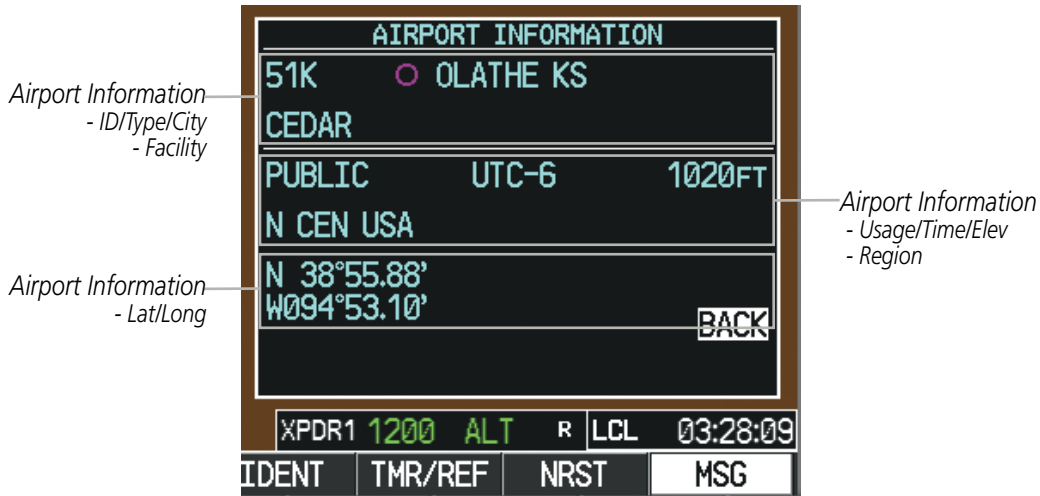

Figure 5-36 Airport Information Window on PFD

The Nearest Airports Page on the MFD is first in the group of NRST pages because of its potential use in the event of an in-flight emergency. In addition to displaying a map of the currently selected airport and surrounding area, the page displays nearest airport information in five boxes labeled ‘NEAREST AIRPORTS’, ‘INFORMATION’, ‘RUNWAYS’, ‘FREQUENCIES’, and ‘APPROACHES’.

The selected airport is indicated by a white arrow, and a dashed white line is drawn on the navigation map from the aircraft position to the nearest airport. Up to five nearest airports, one runway, up to five frequencies, and up to six approaches are visible at one time. If there are more than can be shown, each list can be scrolled. If there are no items for display in a boxed area, text indicating that fact is displayed. The currently selected airport remains in the list until it is unselected.





Figure 5-37 Nearest Airport Page

**Viewing information for a nearest airport on the PFD:**

- 1) Select the **NRST** Softkey to display the Nearest Airports Window. Press the **FMS** Knob to activate the cursor.
- 2) Highlight the airport identifier with the **FMS** Knob and press the **ENT** Key to display the Airport Information Window.
- 3) To return to the Nearest Airports Window press the **ENT** Key (with the cursor on 'BACK') or press the **CLR** Key. The cursor is now on the next airport in the nearest airports list. (Repeatedly pressing the **ENT** Key moves through the airport list, alternating between the Nearest Airports Window and the Airport Information Window.)
- 4) Press the **CLR** Key or the **NRST** Softkey to close the PFD Nearest Airports Window.

**Viewing information for a nearest airport on the MFD:**

- 1) Turn the large **FMS** Knob to select the NRST page group.
- 2) Turn the small **FMS** Knob to select the Nearest Airports Page (it is the first page of the group, so it may already be selected). If there are no Nearest Airports available, "NONE WITHIN 200 NM" is displayed.
- 3) Select the **APT** Softkey; or press the **FMS** Knob; or press the **MENU** Key, highlight 'Select Airport Window' and press the **ENT** Key. The cursor is placed in the 'NEAREST AIRPORTS' Box. The first airport in the nearest airports list is highlighted.
- 4) Turn the **FMS** Knob to highlight the desired airport. (Pressing the **ENT** Key also moves to the next airport.)
- 5) Press the **FMS** Knob to remove the flashing cursor.

**Viewing runway information for a specific airport:**

- 1) With the Nearest Airports Page displayed, select the **RNWX** Softkey; or press the **MENU** Key, highlight 'Select Runway Window'; and press the **ENT** Key. The cursor is placed in the 'RUNWAYS' Box.
- 2) Turn the small **FMS** Knob to select the desired runway.
- 3) Press the **FMS** Knob to remove the flashing cursor.

See the Audio Panel and CNS Section for frequency selection and the Procedures section for approaches.

The Nearest Airports Box on the System Setup Page defines the minimum runway length and surface type used when determining the 25 nearest airports to display on the MFD Nearest Airports Page. A minimum runway length and/or surface type can be entered to prevent airports with small runways or runways that are not appropriately surfaced from being displayed. Default settings are 0 feet (or meters) for runway length and "HARD/SOFT" for runway surface type.

**Selecting nearest airport surface matching criteria:**

- 1) Use the **FMS** Knob to select the System Setup Page.
- 2) Press the **FMS** Knob momentarily to activate the flashing cursor.
- 3) Turn the large **FMS** Knob to highlight the runway surface field in the Nearest Airports Box.
- 4) Turn the small **FMS** Knob to select the desired runway option (ANY, HARD ONLY, HARD/SOFT).
- 5) Press the **ENT** Key.
- 6) Press the **FMS** Knob to remove the flashing cursor.

**Selecting nearest airport minimum runway length matching criteria:**

- 1) Use the **FMS** Knob to select the System Setup Page.
- 2) Press the **FMS** Knob momentarily to activate the flashing cursor.
- 3) Turn the large **FMS** Knob to highlight the minimum length field in the Nearest Airport Box.
- 4) Use the **FMS** Knob to enter the minimum runway length (zero to 25,000 feet) and press the **ENT** Key.
- 5) Press the **FMS** Knob to remove the flashing cursor.

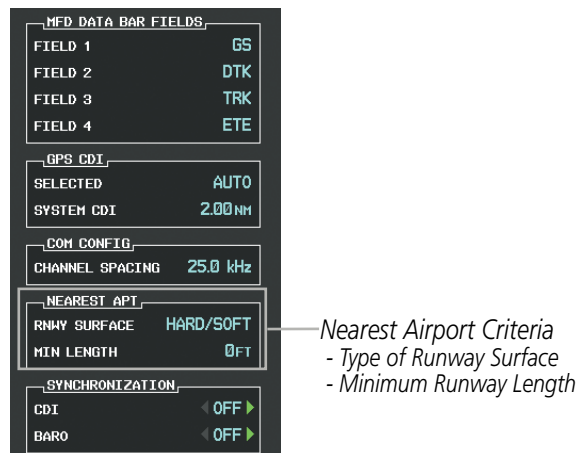

**Figure 5-38 System Setup Page - Nearest Airport Selection Criteria**

## INTERSECTIONS



**NOTE:** The VOR displayed on the Intersection Information Page is the nearest VOR, not necessarily the VOR used to define the intersection.

The Intersection Information Page is used to view information about intersections. In addition to displaying a map of the currently selected intersection and surrounding area, the Intersection Information Page displays intersection information in three boxes labeled ‘INTERSECTION’, ‘INFORMATION’, and ‘NEAREST VOR’.

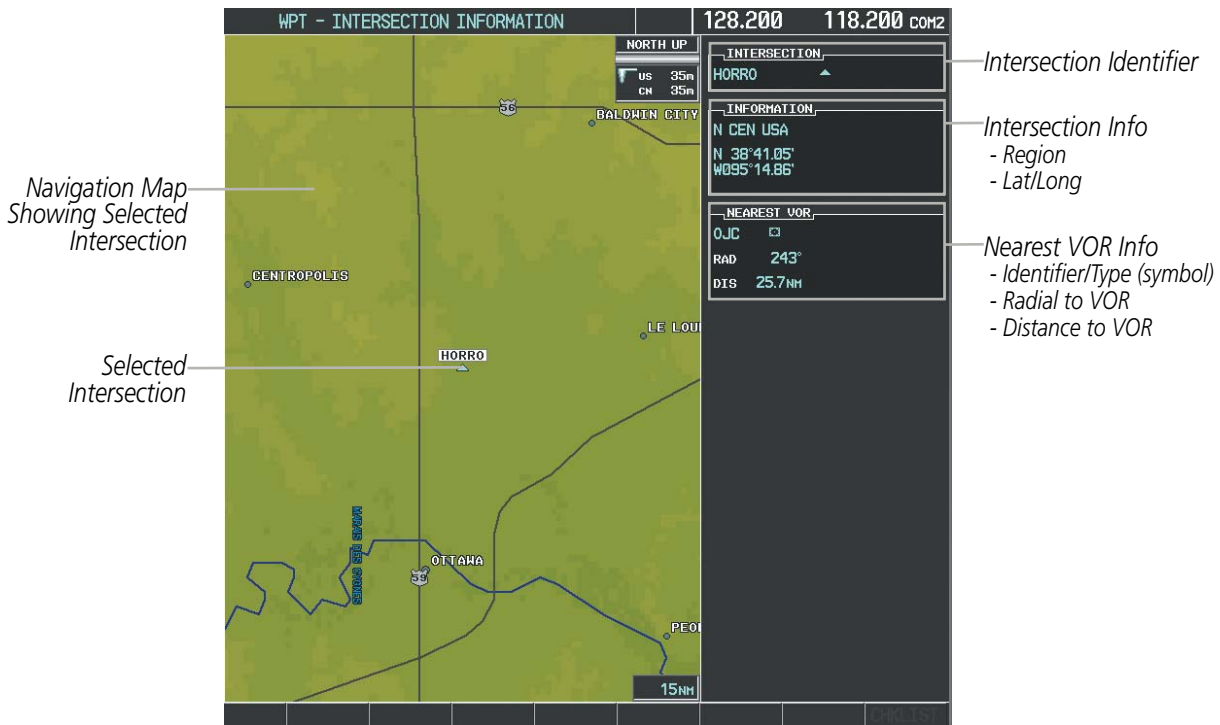

Figure 5-39 Intersection Information Page

### Selecting an intersection:

- 1) With the Intersection Information Page displayed, enter an identifier in the Intersection Box.
- 2) Press the **ENT** Key.
- 3) Press the **FMS** Knob to remove the flashing cursor.

**Or:**

- 1) With the Nearest Intersections Page displayed, press the **FMS** Knob.
- 2) Press the **ENT** Key or turn either **FMS** Knob to select an identifier in the Nearest Intersection Box.
- 3) Press the **FMS** Knob to remove the flashing cursor.

The Nearest Intersections Page can be used to quickly find an intersection close to the flight path. In addition to displaying a map of the surrounding area, the page displays information for up to 25 nearest intersections in three boxes labeled 'NEAREST INT', 'INFORMATION', and 'REFERENCE VOR'.

The selected intersection is indicated by a white arrow. Up to sixteen intersections are visible at a time. If there are more than can be shown, the list can be scrolled. If there are no items for display, text indicating that fact is displayed.



**NOTE:** The list only includes waypoints that are within 200 nm.

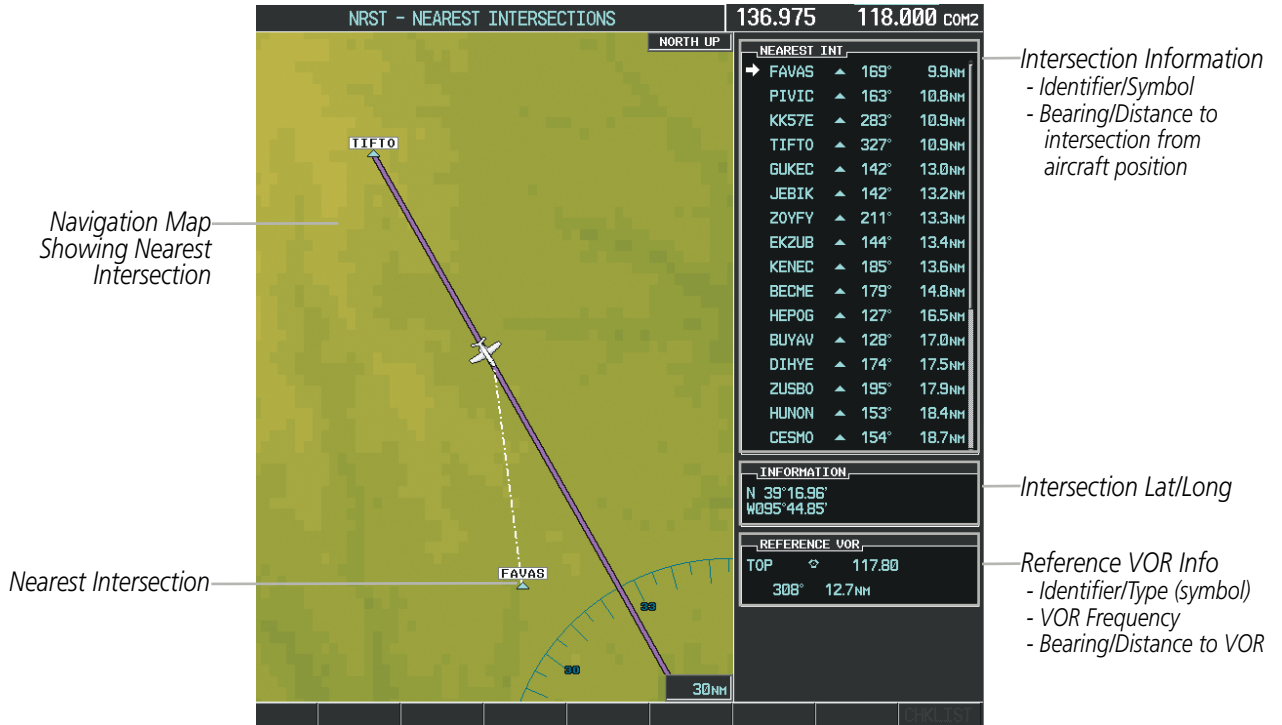

Figure 5-40 Nearest Intersections Page

## NDBs

The NDB Information Page is used to view information about NDBs. In addition to displaying a map of the currently selected NDB and surrounding area, the page displays NDB information in four boxes labeled 'NDB', 'INFORMATION', 'FREQUENCY', and 'NEAREST AIRPORT'.



Figure 5-41 NDB Information Page



**NOTE:** Compass locator (LOM, LMM): a low power, low or medium frequency radio beacon installed in conjunction with the instrument landing system. When LOM is used, the locator is at the Outer Marker; when LMM is used, the locator is at the Middle Marker.

### Selecting an NDB:

- 1) With the NDB Information Page displayed, enter an identifier, the name of the NDB, or the city in which it's located in the NDB Box.
- 2) Press the **ENT** Key.
- 3) Press the **FMS** Knob to remove the flashing cursor.

**Or:**

- 1) With the Nearest NDB Page displayed, press the **FMS** Knob.
- 2) Press the **ENT** Key or turn either **FMS** Knob to select an identifier in the Nearest NDB Box.
- 3) Press the **FMS** Knob to remove the flashing cursor.

The Nearest NDB Page can be used to quickly find a NDB close to the flight path. In addition to displaying a map of the surrounding area, the page displays information for up to 25 nearest NDBs in three boxes labeled 'NEAREST NDB', 'INFORMATION', and 'FREQUENCY'.

A white arrow before the NDB identifier indicates the selected NDB. Up to sixteen NDBs are visible at a time. If there are more than can be shown, each list can be scrolled. The list only includes waypoints that are within 200nm. If there are no NDBs in the list, text indicating that there are no nearest NDBs is displayed. If there are no nearest NDBs in the list, the information and frequency fields are dashed.



Figure 5-42 Nearest NDB Page

## VORs

The VOR Information Page can be used to view information about VOR and ILS signals (since ILS signals can be received on a NAV receiver), or to quickly auto-tune a VOR or ILS frequency. Localizer information cannot be viewed on the VOR Information Page. If a VOR station is combined with a TACAN station it is listed as a VORTAC on the VOR Information Page and if it includes only DME, it is displayed as VOR-DME.

In addition to displaying a map of the currently selected VOR and surrounding area, the VOR Information Page displays VOR information in four boxes labeled 'VOR', 'INFORMATION', 'FREQUENCY', and 'NEAREST AIRPORT'.

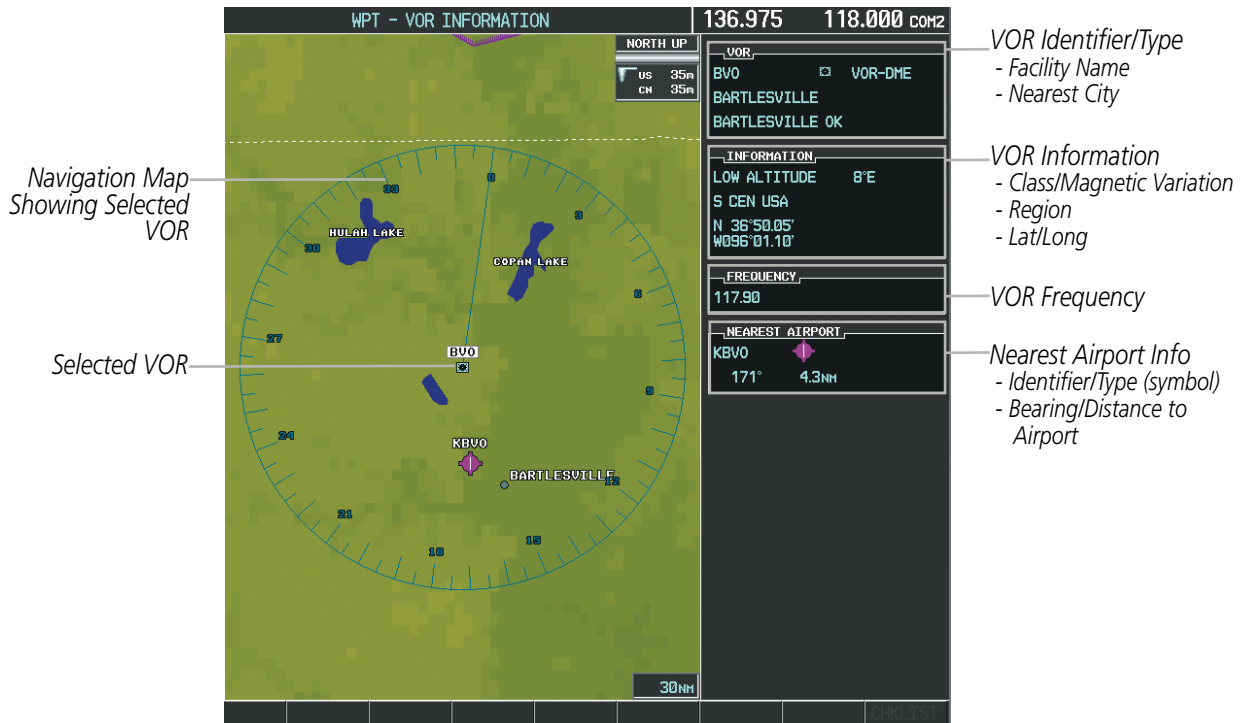

Figure 5-43 VOR Information Page

The VOR classes used in the VOR information box are: LOW ALTITUDE, HIGH ALTITUDE, and TERMINAL.

### Selecting a VOR:

- 1) With the VOR Information Page displayed, enter an identifier, the name of the VOR, or the city in which it's located in the VOR Box.
- 2) Press the **ENT** Key.
- 3) Press the **FMS** Knob to remove the flashing cursor.

Or:

- 1) With the Nearest VOR Page displayed, press the **FMS** Knob or press the **VOR** Softkey.
- 2) Press the **ENT** Key or turn either **FMS** Knob to select an identifier in the Nearest VOR Box.
- 3) Press the **FMS** Knob to remove the flashing cursor.



Or:

- 1) With the Nearest VOR Page displayed, press the **MENU** Key.
- 2) Highlight 'Select VOR Window', and press the **ENT** Key.
- 3) Press the **ENT** Key or turn either **FMS** Knob to select an identifier in the Nearest VOR Box.
- 4) Press the **FMS** Knob to remove the flashing cursor.

The Nearest VOR Page can be used to quickly find a VOR station close to the aircraft. Also, a NAV frequency from a selected VOR station can be loaded from the Nearest VOR Page. In addition to displaying a map of the surrounding area, the Nearest VOR Page displays information for up to 25 nearest VOR stations in three boxes labeled 'NEAREST VOR', 'INFORMATION', and 'FREQUENCY'. The list only includes waypoints that are within 200 nm.

A white arrow before the VOR identifier indicates the selected VOR. Up to sixteen VORs are visible at a time. If there are more than can be shown, each list can be scrolled. If there are no VORs in the list, text indicating that there are no nearest VORs is displayed. If there are no nearest VORs in the list, the information is dashed.

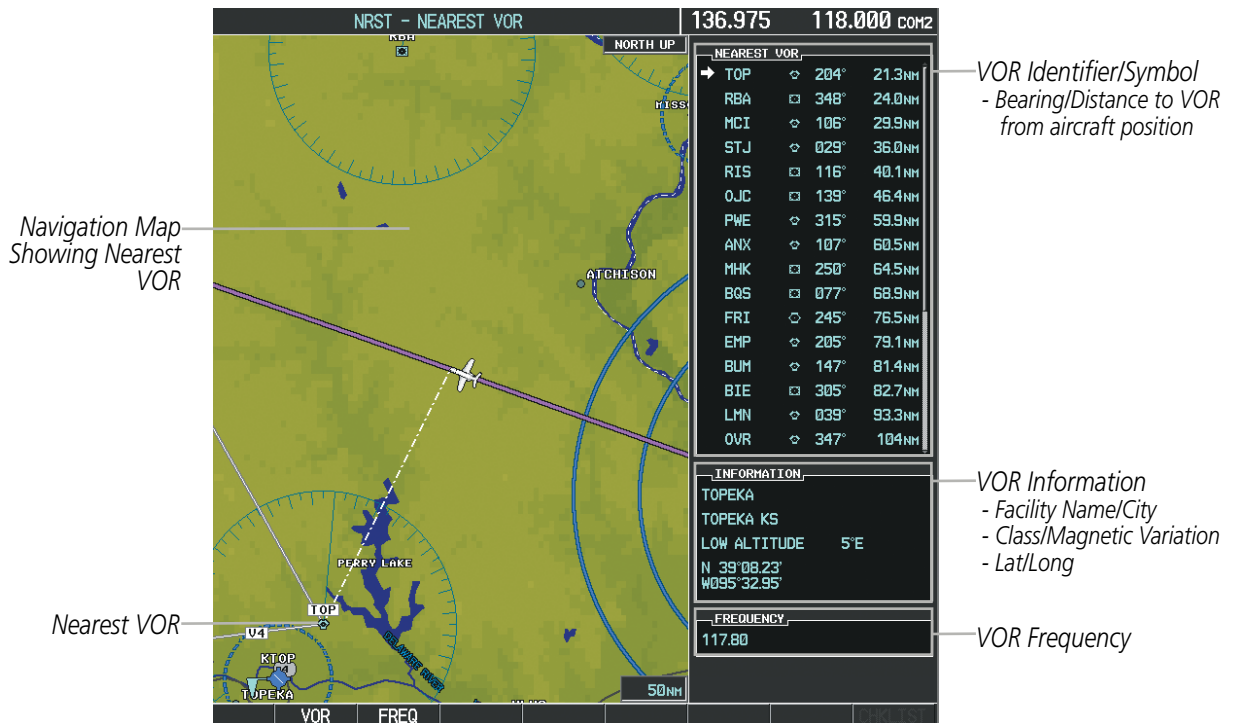

Figure 5-44 Nearest VOR Page



## USER WAYPOINTS

The system can create and store up to 1,000 user-defined waypoints. User waypoints can be created from any map page (except PFD Inset Map, AUX-Trip Planning Page, or Procedure Pages) by selecting a position on the map using the **Joystick**, or from the User Waypoint Information Page by referencing a bearing/distance from an existing waypoint, bearings from two existing waypoints, or entering a latitude/longitude. Once a waypoint has been created, it can be renamed, deleted, or moved. Temporary user waypoints are erased upon system power down.



Figure 5-45 User Waypoint Information Page

### Selecting a User Waypoint:

- 1) With the User Waypoint Information Page displayed, enter the name of the User Waypoint, or scroll to the desired waypoint in the User Waypoint List using the large **FMS** Knob.
  - 2) Press the **ENT** Key.
  - 3) Press the **FMS** Knob to remove the flashing cursor.
- Or:**
- 1) With the Nearest User Waypoints Page displayed, press the **FMS** Knob.
  - 2) Press the **ENT** Key or turn either **FMS** Knob to select an identifier in the Nearest USR Box.
  - 3) Press the **FMS** Knob to remove the flashing cursor.

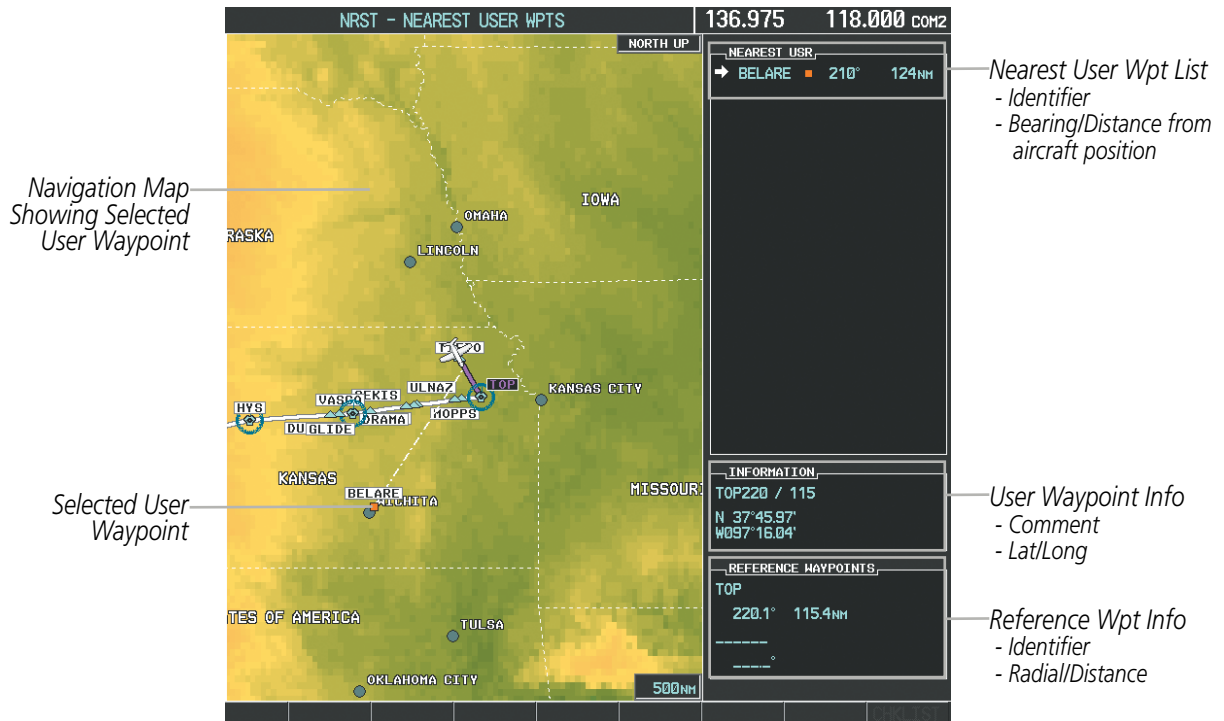

Figure 5-46 Nearest User Waypoint Page

## CREATING USER WAYPOINTS

User waypoints can be created from the User Waypoint Information Page in the following ways:

### Creating user waypoints from the User Waypoint Information Page:

- 1) Press the **NEW** Softkey, **or** press the **MENU** Key and select 'Create New User Waypoint'.
- 2) Enter a user waypoint name (up to six characters).
- 3) Press the **ENT** Key. The current aircraft position is the default location of the new waypoint.
- 4) If desired, define the type and location of the waypoint in one of the following ways:
  - a) Select "RAD/RAD" using the small **FMS** Knob, press the **ENT** Key, and enter the two reference waypoint identifiers and radials into the REFERENCE WAYPOINTS window using the **FMS** Knobs.
  - Or:
  - b) Select "RAD/DIS" using the small **FMS** Knob, press the **ENT** Key, and enter the reference waypoint identifier, the radial, and the distance into the REFERENCE WAYPOINTS window using the **FMS** Knobs.
  - Or:
  - c) Select "LAT/LON" using the small **FMS** Knob, press the **ENT** Key, and enter the latitude and longitude into the INFORMATION window using the **FMS** Knobs.
- 5) Press the **ENT** Key to accept the new waypoint.

- 6) If desired, change the storage method of the waypoint to "TEMPORARY" or "NORMAL" by moving the cursor to "TEMPORARY" and selecting the **ENT** Key to check or uncheck the box.
- 7) Press the **FMS** Knob to remove the flashing cursor.
 

**Or:**

  - 1) Press the **FMS** Knob to activate the cursor.
  - 2) Enter a user waypoint name (up to six characters).
  - 3) Press the **ENT** Key. The message 'Are you sure you want to create the new User Waypoint AAAAAA?' is displayed.
  - 4) With 'YES' highlighted, press the **ENT** Key.
  - 5) If desired, define the type and location of the waypoint in one of the following ways:
    - a) Select "RAD/RAD" using the small **FMS** Knob, press the **ENT** Key, and enter the two reference waypoint identifiers and radials into the REFERENCE WAYPOINTS window using the **FMS** Knobs.
    - Or:**
    - b) Select "RAD/DIS" using the small **FMS** Knob, press the **ENT** Key, and enter the reference waypoint identifier, the radial, and the distance into the REFERENCE WAYPOINTS window using the **FMS** Knobs.
    - Or:**
    - c) Select "LAT/LON" using the small **FMS** Knob, press the **ENT** Key, and enter the latitude and longitude into the INFORMATION window using the **FMS** Knobs.
  - 6) Press the **ENT** Key to accept the new waypoint.
  - 7) If desired, change the storage method of the waypoint to "TEMPORARY" or "NORMAL" by moving the cursor to "TEMPORARY" and selecting the **ENT** Key to check or uncheck the box.
  - 8) Press the **FMS** Knob to remove the flashing cursor.

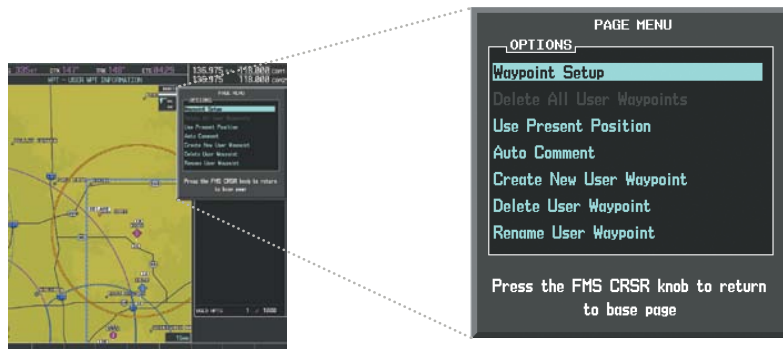

Figure 5-47 User Waypoint Information Page Menu

**Creating user waypoints from map pages:**

- 1) Press the **Joystick** to activate the panning function and pan to the map location of the desired user waypoint.
- 2) Press the **ENT** Key. The User Waypoint Information Page is displayed with the captured position.



**NOTE:** If the pointer has highlighted a map database feature, one of three things happens upon pressing the **ENT** Key: 1) information about the selected feature is displayed instead of initiating a new waypoint, 2) a menu pops up allowing a choice between 'Review Airspaces' or 'Create User Waypoint', or 3) a new waypoint is initiated with the default name being the selected map item.

- 3) Enter a user waypoint name (up to six characters).
- 4) Press the **ENT** Key to accept the selected name.
- 5) If desired, define the type and location of the waypoint in one of the following ways:
  - a) Select "RAD/RAD" using the small **FMS** Knob, press the **ENT** Key, and enter the two reference waypoint identifiers and radials into the REFERENCE WAYPOINTS window using the **FMS** Knobs.  
**Or:**
  - b) Select "RAD/DIS" using the small **FMS** Knob, press the **ENT** Key, and enter the reference waypoint identifier, the radial, and the distance into the REFERENCE WAYPOINTS window using the **FMS** Knobs.  
**Or:**
  - c) Select "LAT/LON" using the small **FMS** Knob, press the **ENT** Key, and enter the latitude and longitude into the INFORMATION window using the **FMS** Knobs.
- 6) Press the **ENT** Key to accept the new waypoint.
- 7) If desired, change the storage method of the waypoint to "TEMPORARY" or "NORMAL" by moving the cursor to "TEMPORARY" and selecting the **ENT** Key to check or uncheck the box.
- 8) Press the **FMS** Knob to remove the flashing cursor.
- 9) Press the **GO BACK** Softkey to return to the map page.

## EDITING USER WAYPOINTS

### Editing a user waypoint comment or location:

- 1) With the User Waypoint Information Page displayed, press the **FMS** Knob to activate the cursor.
- 2) Select a user waypoint in the User Waypoint List, if required, and press the **ENT** Key.
- 3) Move the cursor to the desired field.
- 4) Turn the small **FMS** Knob to make any changes.
- 5) Press the **ENT** Key to accept the changes.
- 6) Press the **FMS** Knob to remove the flashing cursor.

**Renaming user waypoints:**

- 1) Highlight a user waypoint in the User Waypoint List. Select the **RENAME** Softkey, or press the **MENU** Key and select 'Rename User Waypoint'.
- 2) Enter a new name.
- 3) Press the **ENT** Key. The message 'Do you want to rename the user waypoint AAAAAA toBBBBBB?' is displayed.
- 4) With 'YES' highlighted, press the **ENT** Key.
- 5) Press the **FMS** Knob to remove the flashing cursor.

**Changing the location of an existing waypoint to the aircraft present position:**

- 1) Enter a waypoint name or select the waypoint in the User Waypoint List, then press the **ENT** Key.
- 2) Press the **MENU** Key.
- 3) Select 'Use Present Position'.
- 4) Press the **ENT** Key twice. The new waypoint's location is saved.
- 5) Press the **FMS** Knob to remove the flashing cursor.

A system generated comment for a user waypoint incorporates the reference waypoint identifier, bearing, and distance. If a system generated comment has been edited, a new comment can be generated.

**Resetting the comment field to the system generated comment:**

- 1) Enter a waypoint name or select the waypoint in the User Waypoint List, then press the **ENT** Key.
- 2) Press the **MENU** Key.
- 3) Select 'Auto Comment'.
- 4) Press the **ENT** Key. The generated comment is based on the reference point used to define the waypoint.

The default type of user waypoint (normal or temporary) can be changed using the user waypoint information page menu. Temporary user waypoints are automatically deleted upon the next power cycle.

**Changing the user waypoint storage duration default setting:**

- 1) With the User Waypoint Information Page displayed, press the **MENU** Key.
- 2) Move the cursor to select 'Waypoint Setup', and press the **ENT** Key.
- 3) Select 'NORMAL' or 'TEMPORARY' as desired, and press the **ENT** Key.
- 4) Press the **FMS** Knob to remove the flashing cursor and return to the User Waypoint Information Page.

## DELETING USER WAYPOINTS

### Deleting a single user waypoint:

- 1) Highlight a User Waypoint in the User Waypoint List, or enter a waypoint in the User Waypoint field.
- 2) Press the **DELETE** Softkey or press the **CLR** Key. 'Yes' is highlighted in the confirmation window.
- 3) Press the **ENT** Key.
- 4) Press the **FMS** Knob to remove the flashing cursor.

### Or:

- 1) Highlight a User Waypoint in the User Waypoint List, or enter a waypoint in the User Waypoint field.
- 2) Press the **MENU** Key.
- 3) Select 'Delete User Waypoint'.
- 4) Press the **ENT** Key twice to confirm the selection.
- 5) Press the **FMS** Knob to remove the flashing cursor.



---

**NOTE:** *The option to 'Delete All User Waypoints' is not available while the aircraft is in flight.*

---

### Deleting all user waypoints:

- 1) Highlight a User Waypoint in the User Waypoint List.
- 2) Press the **MENU** Key.
- 3) Select 'Delete All User Waypoints'.
- 4) Press the **ENT** Key twice to confirm the selection.
- 5) Press the **FMS** Knob to remove the flashing cursor.

### 5.4 AIRSPACES

The system can display the following types of airspaces: Class B/TMA, Class C/TCA, Class D, Restricted, MOA (Military), Other Airspace, Air Defense Identification Zone (ADIZ), and Temporary Flight Restriction (TFR).

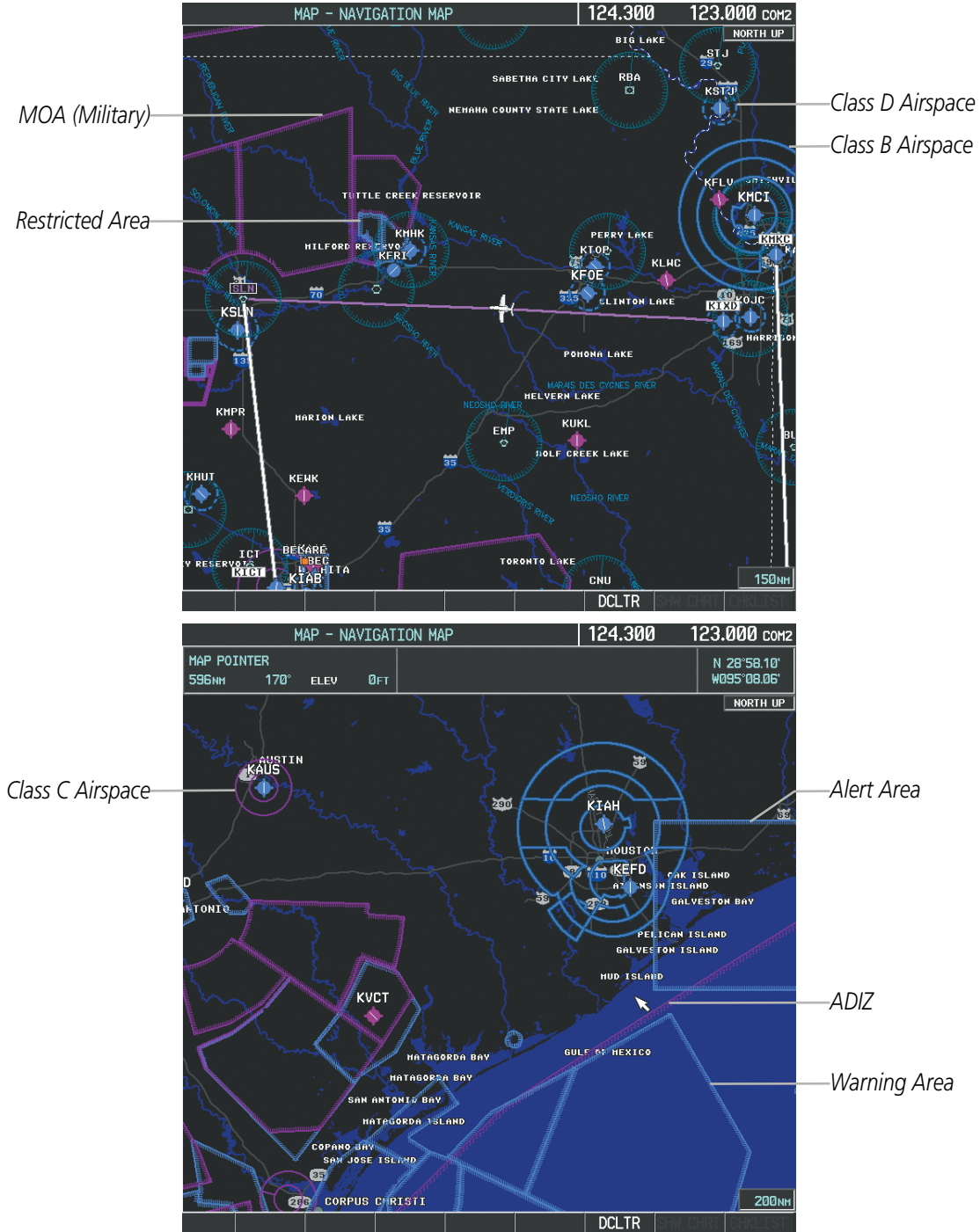

Figure 5-48 Airspaces



The Nearest Airspaces Page, Airspace Alerts Window, and Airspace Alerts on the PFD provide additional information about airspaces and the location of the aircraft in relationship to them.

The Airspace Alerts Box allows the pilot to turn the controlled/special-use airspace message alerts on or off. This does not affect the alerts listed on the Nearest Airspaces Page or the airspace boundaries depicted on the Navigation Map Page. It simply turns on/off the warning provided when the aircraft is approaching or near an airspace.

An altitude buffer is also provided which “expands” the vertical range above or below an airspace. For example, if the buffer is set at 500 feet, and the aircraft is more than 500 feet above/below an airspace, an alert message is not generated, but if the aircraft is less than 500 feet above/below an airspace and projected to enter it, the pilot is notified with an alert message. The default setting for the altitude buffer is 200 feet.

#### **Changing the altitude buffer distance setting:**

- 1) Use the **FMS** Knob to select the AUX - System Setup Page.
- 2) Press the **FMS** Knob momentarily to activate the flashing cursor.
- 3) Turn the large **FMS** Knob to highlight the altitude buffer field in the Airspace Alerts Box.
- 4) Use the **FMS** Knob to enter an altitude buffer value and press the **ENT** Key.
- 5) Press the **FMS** Knob to remove the flashing cursor.

#### **Turning an airspace alert on or off:**

- 1) Use the **FMS** Knob to select the AUX - System Setup Page.
- 2) Press the **FMS** Knob momentarily to activate the flashing cursor.
- 3) Turn the large **FMS** Knob to highlight the desired field in the Airspace Alerts Box.
- 4) Turn the small **FMS** Knob clockwise to turn the airspace alert ON or counterclockwise to turn the alert OFF.
- 5) Press the **FMS** Knob to remove the flashing cursor.



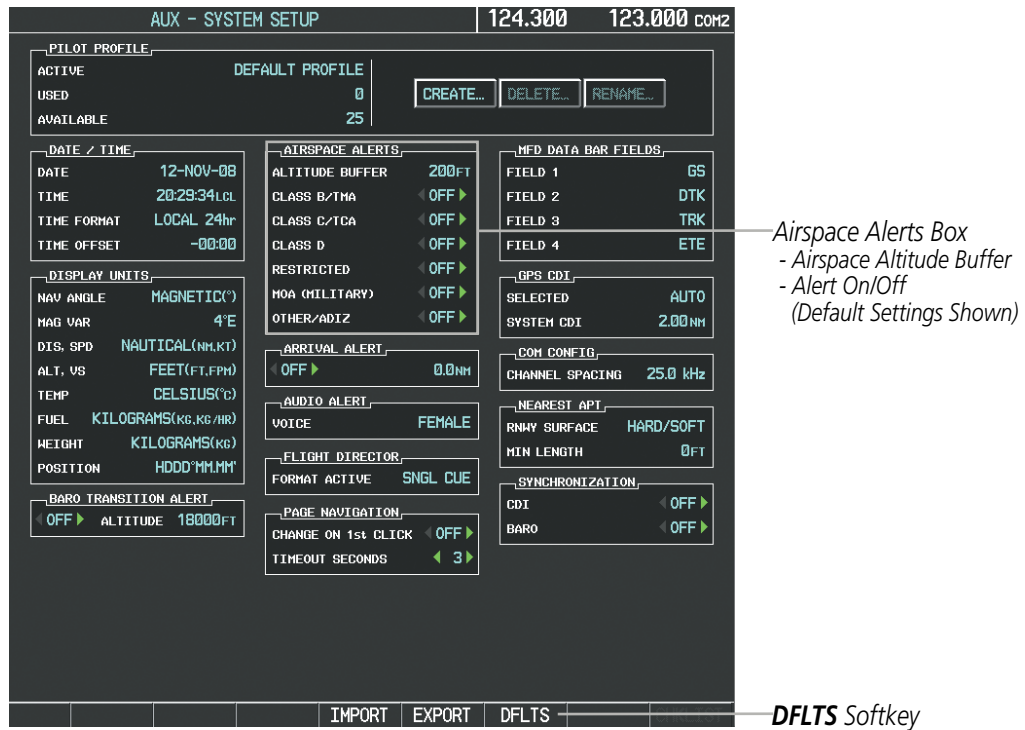

Figure 5-49 System Setup Page - Airspace Alerts

Map ranges for the airspace boundaries are selected from the Aviation Group in the Map Setup Menu. See Table 5-2 for the default and maximum ranges for each type of airspace and the symbol used to define the airspace area.

The Nearest Airspaces Page can be used to quickly find airspaces close to the flight path. In addition, a selected frequency associated with the airspace can be loaded from the Nearest Airspaces Page. In addition to displaying a map of airspace boundaries and surrounding area, the Nearest Airspaces Page displays airspace information in four boxes labeled 'AIRSPACE ALERTS', 'AIRSPACE, AGENCY', 'VERTICAL LIMITS', and 'FREQUENCIES'.

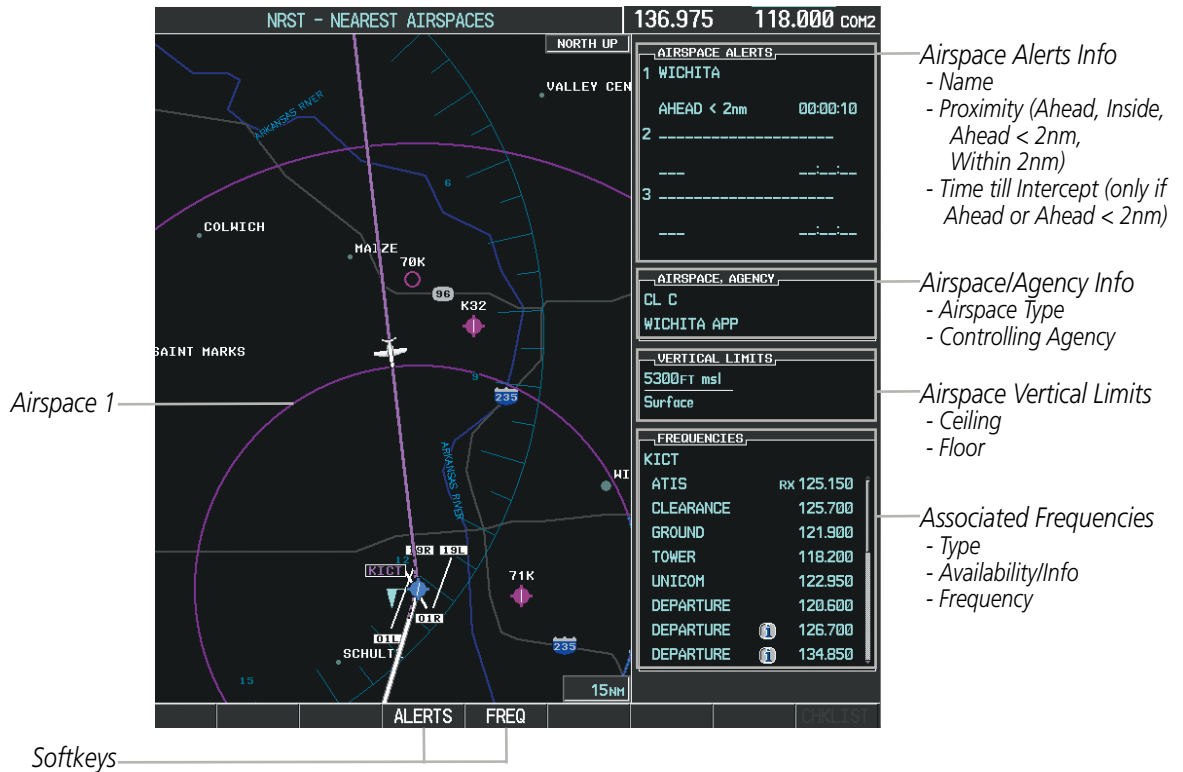

Figure 5-50 Nearest Airspaces Page

Airspace alerts and associated frequencies are shown in scrollable lists on the Nearest Airspaces Page. The **ALERTS** and **FREQ** softkeys place the cursor in the respective list. The **FREQ** Softkey is enabled only if one or more frequencies exist for a selected airspace.

**Selecting and viewing an airspace alert with its associated information:**

- 1) Select the Nearest Airspaces Page.
- 2) Select the **ALERTS** Softkey; or press the **FMS** Knob; or press the **MENU** Key, highlight 'Select Alerts Window', and press the **ENT** Key. The cursor is placed in the 'AIRSPACE ALERTS' Box.
- 3) Select the desired airspace.
- 4) Press the **FMS** Knob to remove the flashing cursor.

Pressing the PFD **MSG** Softkey displays the message window on the PFD. The following airspace alerts are displayed in the message window:

Message	Comments
<b>INSIDE ARSPC</b> – Inside airspace.	The aircraft is inside the airspace.
<b>ARSPC AHEAD</b> – Airspace ahead – less than 10 minutes.	Special use airspace is ahead of aircraft. The aircraft penetrates the airspace within 10 minutes.
<b>ARSPC NEAR</b> – Airspace near and ahead.	Special use airspace is near and ahead of the aircraft position.
<b>ARSPC NEAR</b> – Airspace near – less than 2 nm.	Special use airspace is within 2 nm of the aircraft position.

Table 5-6 PFD Airspace Alert Messages

## 5.5 DIRECT-TO-NAVIGATION

The Direct-to method of navigation, initiated by pressing the **Direct-to** Key on either the MFD or PFD, is quicker to use than a flight plan when the desire is to navigate to a single point such as a nearby airport.

Once a direct-to is activated, the system establishes a point-to-point course line from the present position to the selected direct-to destination. Course guidance is provided until the direct-to is replaced with a new direct-to or flight plan, or cancelled.

A vertical navigation (VNV) direct-to creates a descent path (and provides guidance to stay on the path) from the current altitude to a selected altitude at the direct-to waypoint. Vertical navigation is based on barometric altitudes, not on GPS altitude, and is used for cruise and descent phases of flight.

The Direct-to Window allows selection and activation of direct-to navigation. The Direct-to Window displays selected direct-to waypoint data on the PFD and the MFD.

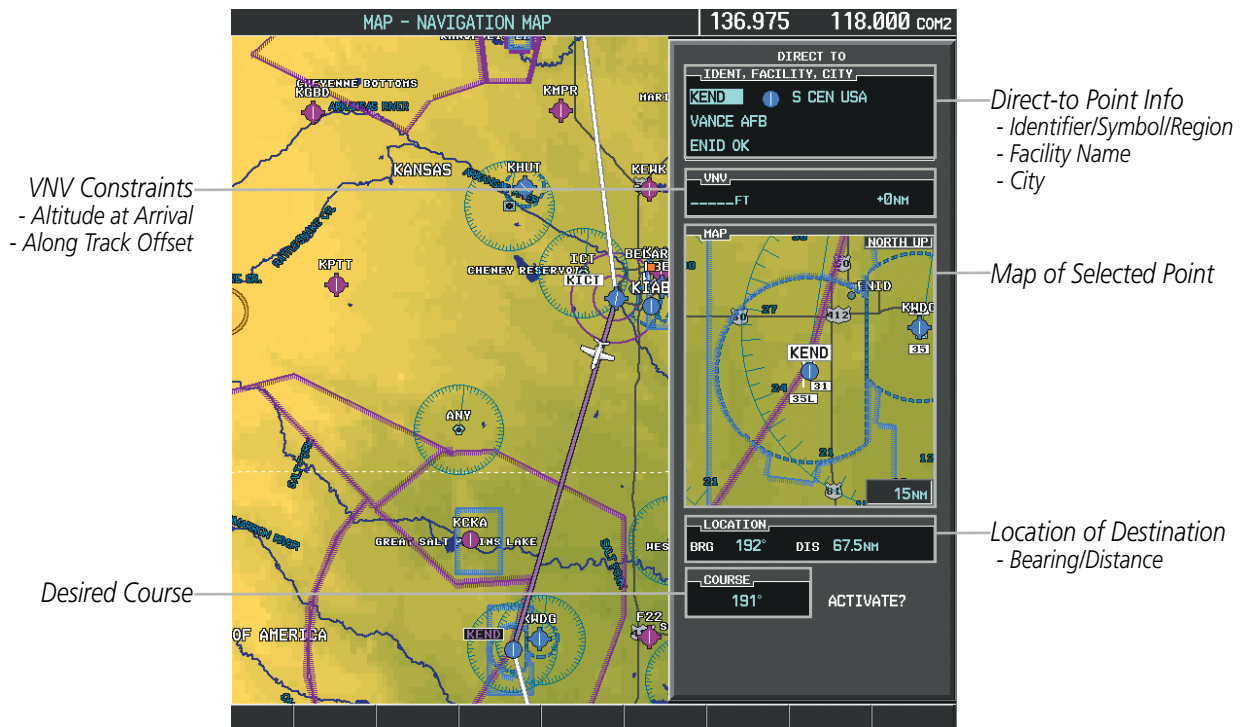

Figure 5-51 Direct-to Window - MFD



Figure 5-52 Direct-to Window - PFD

Any waypoint can be entered as a direct-to destination from the Direct-to Window.

**Entering a waypoint identifier, facility name, or city as a direct-to destination:**

- 1) Press the **Direct-to** Key. The Direct-to Window is displayed (with the active flight plan waypoint as the default selection or a blank waypoint field if no flight plan is active).
- 2) Turn the small **FMS** Knob clockwise to begin entering a waypoint identifier (turning it counter-clockwise brings up the waypoint selection submenu - press the **CLR** Key to remove it), or turn the large **FMS** Knob to select the facility name, or city field and turn the small **FMS** Knob to begin entering a facility name or city. If duplicate entries exist for the entered facility or city name, additional entries can be viewed by turning the small **FMS** Knob during the selection process.
- 3) Press the **ENT** Key. The 'Activate?' field is highlighted.
- 4) Press the **ENT** Key to activate the direct-to.

Any waypoint contained in the active flight plan can be selected as a direct-to waypoint from the Direct-to Window, the Active Flight Plan Page, or the Active Flight Plan Window.

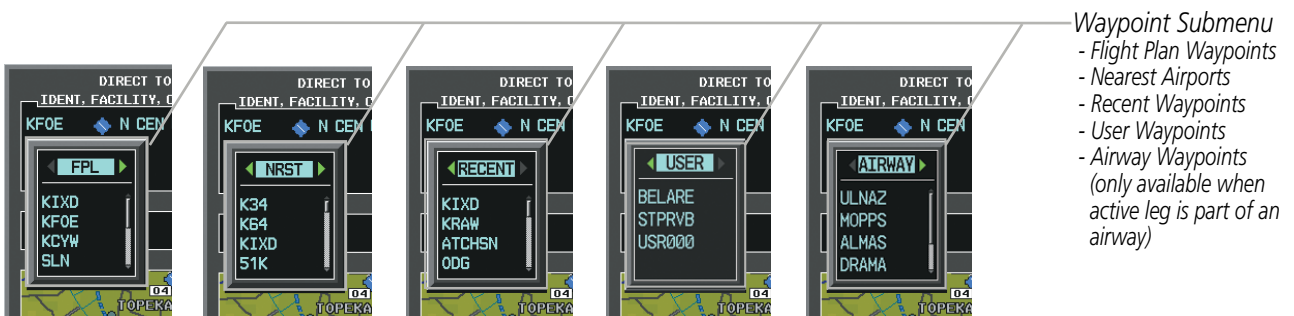

Figure 5-53 Waypoint Submenu

**Selecting an active flight plan waypoint as a direct-to destination:**

- 1) While navigating an active flight plan, press the **Direct-to** Key. The Direct-to Window is displayed with the active flight plan waypoint as the default selection.
- 2) Turn the small **FMS** Knob counter-clockwise to display a list of flight plan waypoints (the FPL list is populated only when navigating a flight plan).
- 3) Select the desired waypoint.
- 4) Press the **ENT** Key. The cursor is now displayed on 'ACTIVATE?'.
- 5) Press the **ENT** Key again to activate the direct-to.

**Or:**

- 1) Select the Active Flight Plan Page on the MFD, or the Active Flight Plan Window on the PFD.
- 2) Select the desired waypoint.
- 3) Press the **Direct-to** Key.
- 4) Press the **ENT** Key. The cursor is now displayed on 'ACTIVATE?'.
- 5) Press the **ENT** Key again to activate the direct-to.

Any NRST, RECENT, USER, or AIRWAY waypoint can be selected as a direct-to destination in the Direct-to Window.

**Selecting a NRST, RECENT, USER, or AIRWAY waypoint as a direct-to destination:**

- 1) Press the **Direct-to** Key. The Direct-to Window is displayed (with the active flight plan destination as the default selection or a blank destination if no flight plan is active).
- 2) Turn the small **FMS** Knob counter-clockwise to display a list of flight plan waypoints (the FPL list is populated only when navigating a flight plan).
- 3) Turn the small **FMS** Knob clockwise to display the NRST, RECENT, USER, or AIRWAY waypoints.
- 4) Turn the large **FMS** Knob clockwise to select the desired waypoint.
- 5) Press the **ENT** Key. The cursor is now displayed on 'ACTIVATE?'.
- 6) Press the **ENT** Key again to activate the direct-to.

The Direct-to Window can be displayed from any page and allows selection and activation of direct-to navigation. If the direct-to is initiated from any page except the WPT pages, the default waypoint is the active flight plan waypoint (if a flight plan is active) or a blank waypoint field. Direct-to requests on any WPT page defaults to the displayed waypoint.

**Selecting any waypoint as a direct-to destination:**

- 1) Select the page or window containing the desired waypoint type and select the desired waypoint.
- 2) Press the **Direct-to** Key to display the Direct-to Window with the selected waypoint as the direct-to destination.
- 3) Press the **ENT** Key. The cursor is now displayed on 'ACTIVATE?'.
- 4) Press the **ENT** Key again to activate the direct-to.

**Selecting a nearby airport as a direct-to destination:**

- 1) Press the **NRST** Softkey on the PFD; or turn the **FMS** Knob to display the Nearest Airports Page and press the **FMS** Knob.
- 2) Select the desired airport (the nearest one is already selected).
- 3) Press the **Direct-to** Key.
- 4) Press the **ENT** Key. The cursor is now displayed on 'ACTIVATE?'.  
5) Press the **ENT** Key again to activate the direct-to.

Direct-to destinations may also be selected by using the pointer on the navigation map pages. If no airport, NAVAID, or user waypoint exists at the desired location, a temporary waypoint named 'MAPWPT' is automatically created at the location of the map arrow.

**Selecting a waypoint as a direct-to destination using the pointer:**

- 1) From a navigation map page, press the **Joystick** to display the pointer.
- 2) Move the **Joystick** to place the pointer at the desired destination location.
- 3) If the pointer is placed on an existing airport, NAVAID, or user waypoint, the waypoint name is highlighted.
- 4) Press the **Direct-to** Key to display the Direct-to Window with the selected point entered as the direct-to destination.
- 5) Press the **ENT** Key. The cursor is now displayed on 'ACTIVATE?'.  
6) Press the **ENT** Key again to activate the direct-to.

**Cancelling a Direct-to:**

- 1) Press the **Direct-to** Key to display the Direct-to Window.
- 2) Press the **MENU** Key.
- 3) With 'Cancel Direct-To NAV' highlighted, press the **ENT** Key. If a flight plan is still active, the system resumes navigating the flight plan along the closest leg.

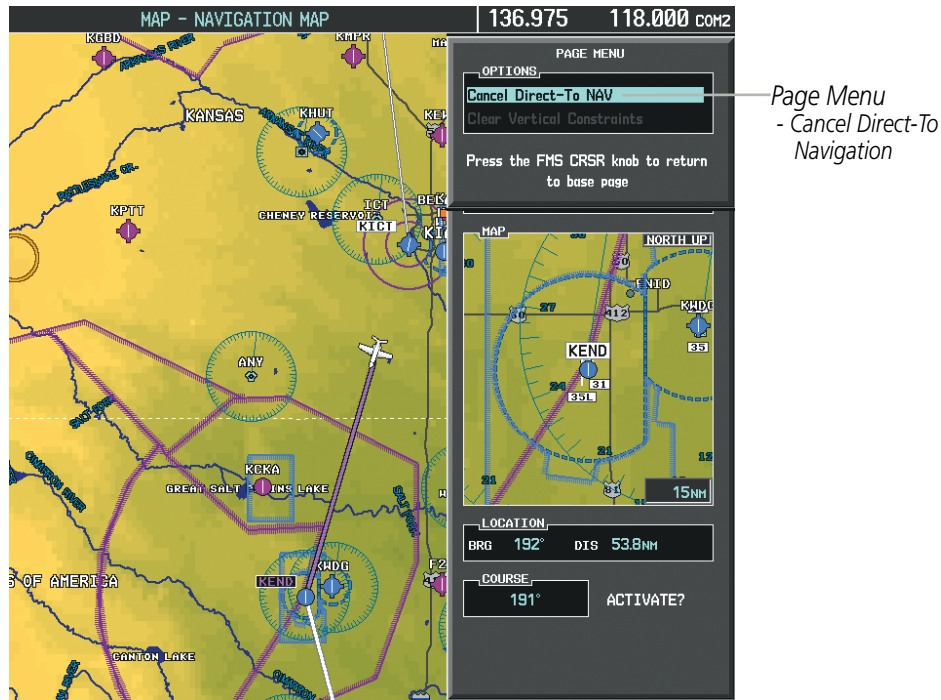

Figure 5-54 Direct-to Window - Cancelling Direct-to Navigation

When navigating a direct-to, the system sets a direct great circle course to the selected destination. The course to a destination can also be manually selected using the course field ('COURSE') on the Direct-to Window.

**Selecting a manual direct-to course:**

- 1) Press the **Direct-to** Key. The Direct-to Window is displayed with the destination field highlighted.
- 2) Highlight the course field.
- 3) Enter the desired course.
- 4) Press the **ENT** Key. The cursor is now displayed on 'ACTIVATE?'.
- 5) Press the **ENT** Key again to activate the direct-to.

**Reselecting the direct course from the current position:**

- 1) Press the **Direct-to** Key. The Direct-to Window is displayed with the destination field highlighted.
- 2) Press the **ENT** Key. The cursor is now displayed on 'ACTIVATE?'.
- 3) Press the **ENT** Key again to activate the direct-to.

A direct-to with altitude constraints creates a descent path (and provides guidance to stay on the path) from the aircraft's current altitude to the altitude of the direct-to waypoint. The altitude is reached at the waypoint, or at the specified distance along the flight path if an offset distance has been entered. All VNV altitudes prior to the direct-to destination are removed from the active flight plan upon successful activation of the direct-to. All VNV altitudes following the direct-to waypoint are retained. See the section on Vertical Navigation for more information regarding the use and purpose of VNV altitudes and offset distances.



**Entering a VNV altitude and along-track offset for the waypoint:**

- 1) Press the **Direct-to** Key to display the Direct-to Window.
- 2) Turn the large **FMS** Knob to place the cursor over the 'VNV' altitude field.
- 3) Enter the desired altitude.
- 4) Press the **ENT** Key. The option to select MSL or AGL is now displayed.
- 5) Turn the small **FMS** Knob to select 'MSL' or 'AGL'.
- 6) Press the **ENT** Key. The cursor is now flashing in the VNV offset distance field.
- 7) Enter the desired along-track distance before the waypoint.
- 8) Press the **ENT** Key. The 'Activate?' field is highlighted.
- 9) Press the **ENT** Key to activate.

**Removing a VNV altitude constraint:**

- 1) Press the **Direct-to** Key to display the Direct-to Window.
- 2) Press the **MENU** Key.
- 3) With 'Clear Vertical Constraints' highlighted, press the **ENT** Key.

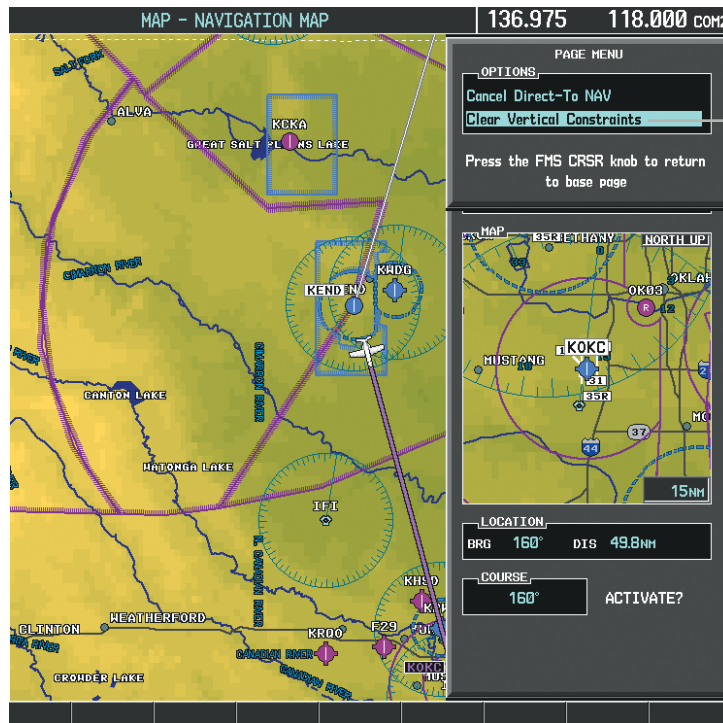

Page Menu  
- Clear Vertical Navigation Constraints

Figure 5-55 Direct-to Window - Clearing Vertical Constraints



## 5.6 FLIGHT PLANNING

Flight planning consists of building a flight plan by entering waypoints one at a time, adding waypoints along airways, and inserting departures, airways, arrivals, or approaches as needed. The system allows flight planning information to be entered from either the MFD or PFD. The flight plan is displayed on maps using different line widths, colors, and types, based on the type of leg and the segment of the flight plan currently being flown (departure, enroute, arrival, approach, or missed approach).

Flight Plan Leg Type	Symbol
Active non-heading Leg	
Active heading Leg	
Non-heading Leg in the current flight segment	
Heading Leg not in the current flight segment	
Non-heading Leg not in the active flight segment	
Turn Anticipation Arc	

Table 5-7 Flight Plan Leg Symbols

Up to 99 flight plans with up to 99 waypoints each can be created and stored in memory. One flight plan can be activated at a time and becomes the active flight plan. The active flight plan is erased when the system is turned off and overwritten when another flight plan is activated. When storing flight plans with an approach, departure, or arrival, the system uses the waypoint information from the current database to define the waypoints. If the database is changed or updated, the system automatically updates the information if the procedure has not been modified. If an approach, departure, or arrival procedure is no longer available, the procedure is deleted from the affected stored flight plan(s), and an alert is displayed (see Miscellaneous Messages in Appendix A) advising that one or more stored flight plans need to be edited.

Whenever an approach, departure, or arrival procedure is loaded into the active flight plan, a set of approach, departure, or arrival waypoints is inserted into the flight plan along with a header line describing the instrument procedure the pilot selected. The original enroute portion of the flight plan remains active (unless an instrument procedure is activated) when the procedure is loaded.

When the database is updated, the airways need to be reloaded also. Each airway segment is reloaded from the database given the entry waypoint, the airway identifier and the exit waypoint. This reloads the sequence of waypoints between the entry and exit waypoints (the sequence may change when the database is updated). The update of an airway can fail during this process. If that happens, the airway waypoints are changed to regular (non-airway) flight plan waypoints, and an alert is displayed (see Miscellaneous Messages in Appendix A).

The following could cause the airway update to fail:

- Airway identifier, entry waypoint or exit waypoint not found in the new database.
- Airway entry/exit waypoint is not an acceptable waypoint for the airway – either the waypoint is no longer on the airway, or there is a new directional restriction that prevents it being used.
- Loading the new airway sequence would exceed the capacity of the flight plan.

**FLIGHT PLAN CREATION**

There are three methods to create or modify a flight plan:

- Active Flight Plan Page on the MFD (create/modify the active flight plan)
- Active Flight Plan Window on the PFD (create/modify the active flight plan)
- Flight Plan Catalog Page on the MFD (create/modify a stored flight plan)

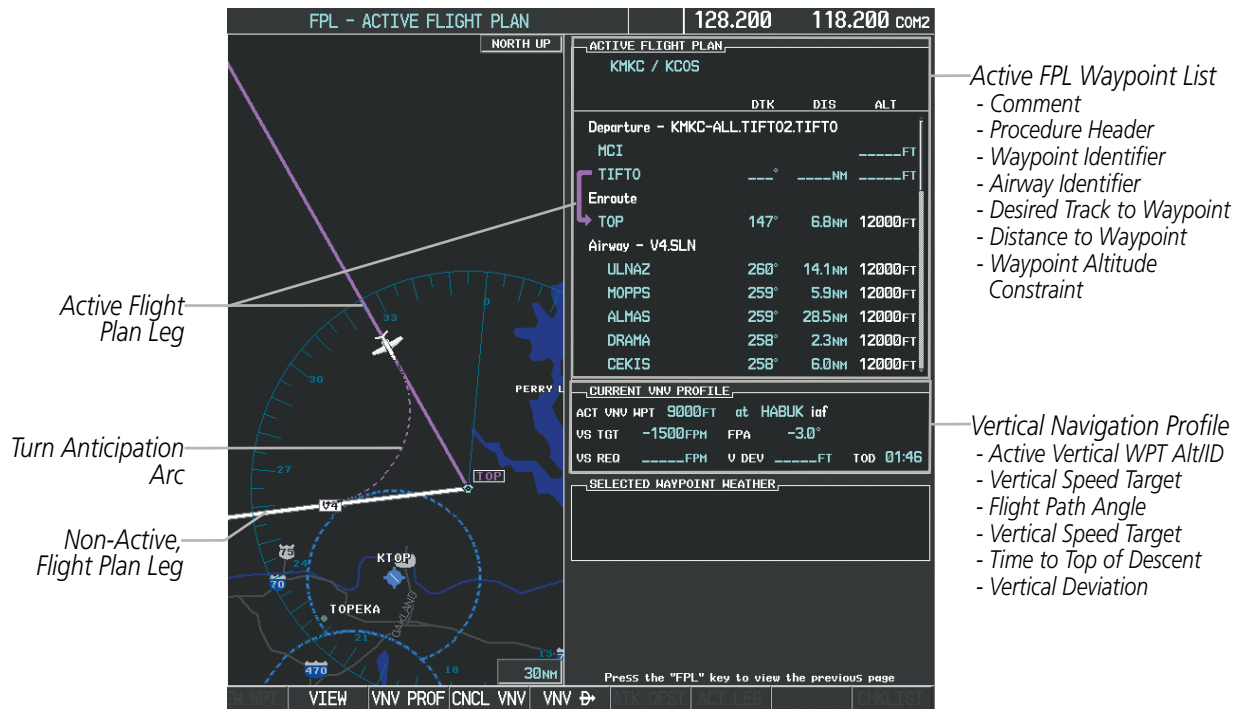

Figure 5-56 Active Flight Plan Page

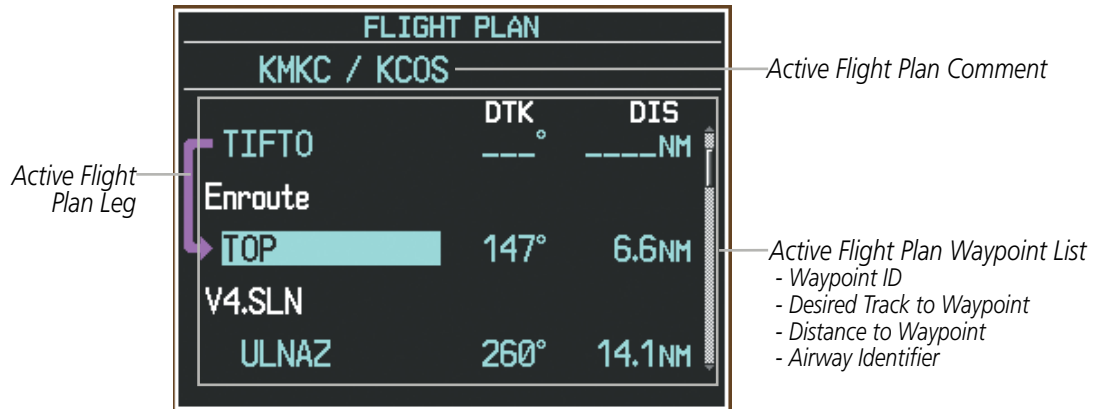

Figure 5-57 Active Flight Plan Window on PFD

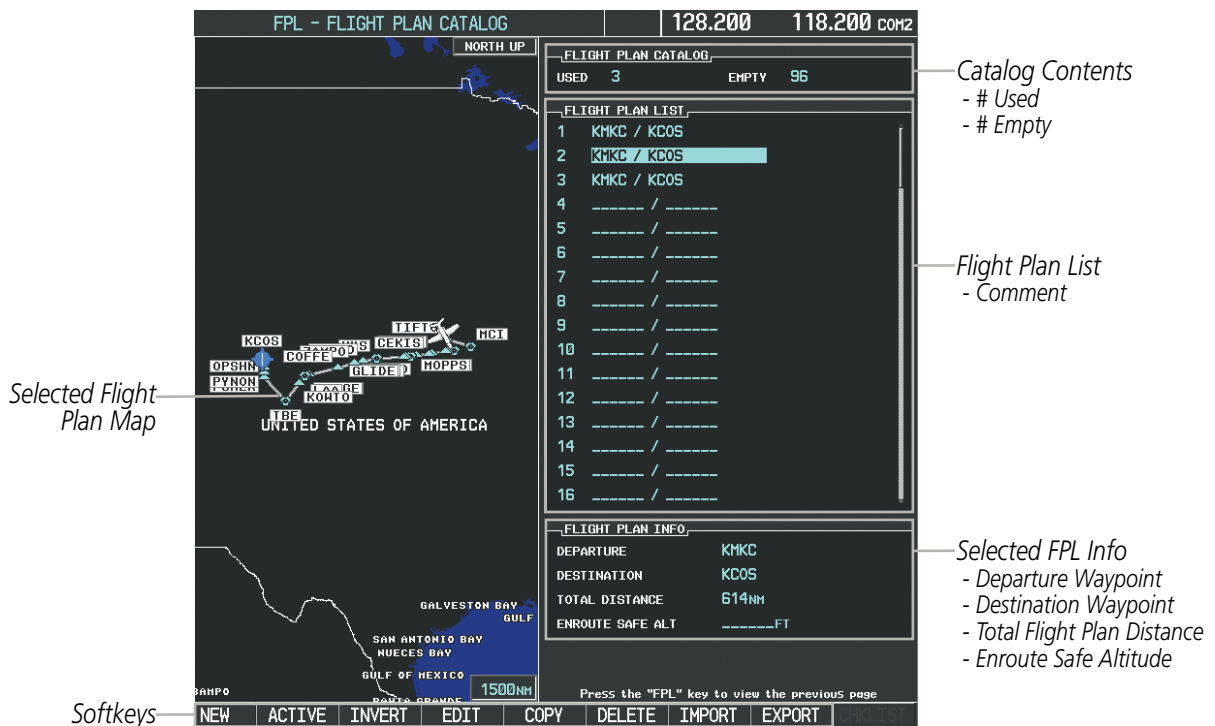

Figure 5-58 Flight Plan Catalog Page

The active flight plan is listed on the active Flight Plan Page on the MFD, and in the Active Flight Plan Window on the PFD. It is the flight plan to which the system is currently providing guidance, and is shown on the navigation maps. Stored flight plans are listed on the Flight Plan Catalog Page, and are available for activation (becomes the active flight plan).

#### Creating an active flight plan:

- 1) Press the **FPL** Key.
- 2) Press the **FMS** Knob to activate the cursor (only on MFD).
- 3) Turn the small **FMS** Knob to display the Waypoint Information Window. (Turning it clockwise displays a blank Waypoint Information Window, turning it counter-clockwise displays the Waypoint Information Window with a waypoint selection submenu allowing selection of active flight plan, nearest, recent, user, or airway waypoints).
- 4) Enter the identifier, facility, or city name of the departure waypoint or select a waypoint from the submenu of waypoints and press the **ENT** Key. The active flight plan is modified as each waypoint is entered.
- 5) Repeat step numbers 3 and 4 to enter each additional flight plan waypoint.
- 6) When all waypoints have been entered, press the **FMS** Knob to remove the cursor.

#### Creating a stored flight plan:

- 1) Press the **FPL** Key.
- 2) Turn the small **FMS** Knob clockwise to display the Flight Plan Catalog Page.
- 3) Select the **NEW** Softkey; or press the **MENU** Key, highlight 'Create New Flight Plan', and press the **ENT** Key to display a blank flight plan for the first empty storage location.
- 4) Turn the small **FMS** Knob to display the Waypoint Information Window. (Turning it clockwise displays a blank Waypoint Information Window, turning it counter-clockwise displays the Waypoint Information Window with a waypoint selection submenu allowing selection of active flight plan, nearest, recent, user, or airway waypoints).
- 5) Enter the identifier, facility, or city name of the departure waypoint or select a waypoint from the submenu of waypoints and press the **ENT** Key.
- 6) Repeat step numbers 4 and 5 to enter each additional flight plan waypoint.
- 7) When all waypoints have been entered, press the **FMS** Knob to return to the Flight Plan Catalog Page. The new flight plan is now in the list.

Flight plans can be imported from an SD Card or exported to an SD Card from the Stored Flight Plan Page.

### Importing a Flight Plan from an SD Card

- 1) Insert the SD card containing the flight plan in the top card slot on the MFD.
- 2) Press the **FPL** Key to display the Active Flight Plan Page on the MFD.
- 3) Turn the small **FMS** Knob to select the Flight Plan Catalog Page.
- 4) Press the **FMS** Knob to activate the cursor.
- 5) Turn either **FMS** Knob to highlight an empty or existing flight plan.
- 6) Press the **IMPORT** Softkey; or press the **MENU** Key, select "Import Flight Plan", and press the **ENT** Key.

If an empty slot is selected, a list of the available flight plans on the SD card will be displayed.

Or:

If an existing flight plan is selected, an "Overwrite existing flight plan? OK or CANCEL" prompt is displayed. Press the **ENT** Key to choose to overwrite the selected flight plan and see the list of available flight plans on the SD card. If overwriting the existing flight plan is not desired, select "CANCEL" using the **FMS** Knob, press the **ENT** Key, select another flight plan slot, and press the **IMPORT** Softkey again.

- 7) Turn the small **FMS** Knob to highlight the desired flight plan for importing.
- 8) Press the **ENT** Key to initiate the import.
- 9) Press the **ENT** Key again to confirm the import.

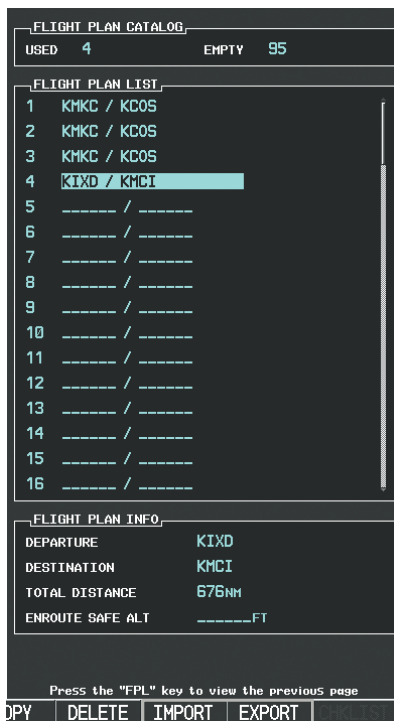

Import/Export Softkeys

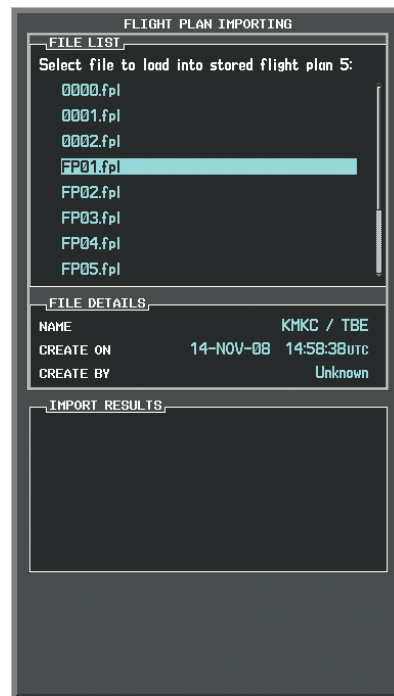

List of Flight Plans to Import & Details for the Selected File

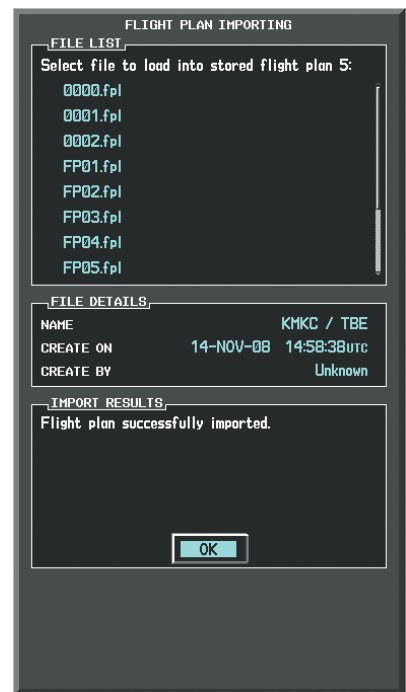

Import Successful

Figure 5-59 Flight Plan Import



**NOTE:** If the imported flight plan contains a waypoint with a name that duplicates the name of a waypoint already stored on the system, the system compares the coordinates of the imported waypoint with those of the existing waypoint. If the coordinates are different, the imported waypoint is automatically renamed by adding characters to the end of the name.

### Exporting a Flight Plan to an SD Card

- 1) Insert the SD card into the top card slot on the MFD.
- 2) Press the **FPL** Key to display the Active Flight Plan Page on the MFD.
- 3) Turn the small **FMS** Knob to select the Flight Plan Catalog Page.
- 4) Press the **FMS** Knob to activate the cursor.
- 5) Turn the large **FMS** Knob to highlight the flight plan to be exported.
- 6) Press the **EXPORT** Softkey; or press the **MENU** Key, select "Export Flight Plan".
- 7) If desired, change the name for the exported file by turning the large **FMS** Knob to the left to highlight the name, then use the small and large **FMS** knobs to enter the new name, and press the **ENT** Key.
- 8) Press the **ENT** Key to initiate the export.
- 9) Press the **ENT** Key to confirm the export.



**NOTE:** The exported flight plan will not contain any procedures or airways.

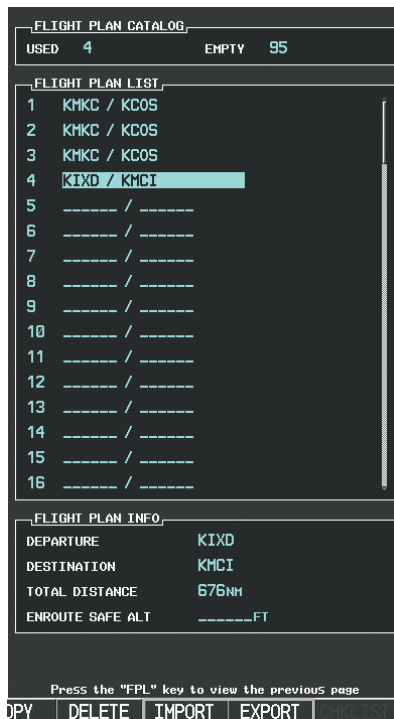

Import/Export Softkeys



Stored Flight Plan to be Exported & Exported Flight Plan Name

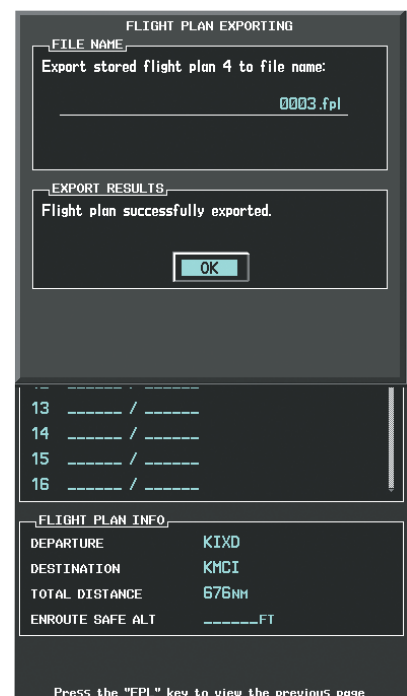

Export Successful

Figure 5-60 Flight Plan Export

## ADDING WAYPOINTS TO AN EXISTING FLIGHT PLAN

Waypoints can be added to the active flight plan or any stored flight plan. Choose the flight plan, select the desired point of insertion, enter the waypoint, and it is added in front of the selected waypoint. Flight plans are limited to 99 waypoints (including waypoints within airways and procedures). If the number of waypoints in the flight plan exceeds 99, the message “Flight plan is full. Remove unnecessary waypoints.” appears and the new waypoint(s) are not added to the flight plan.

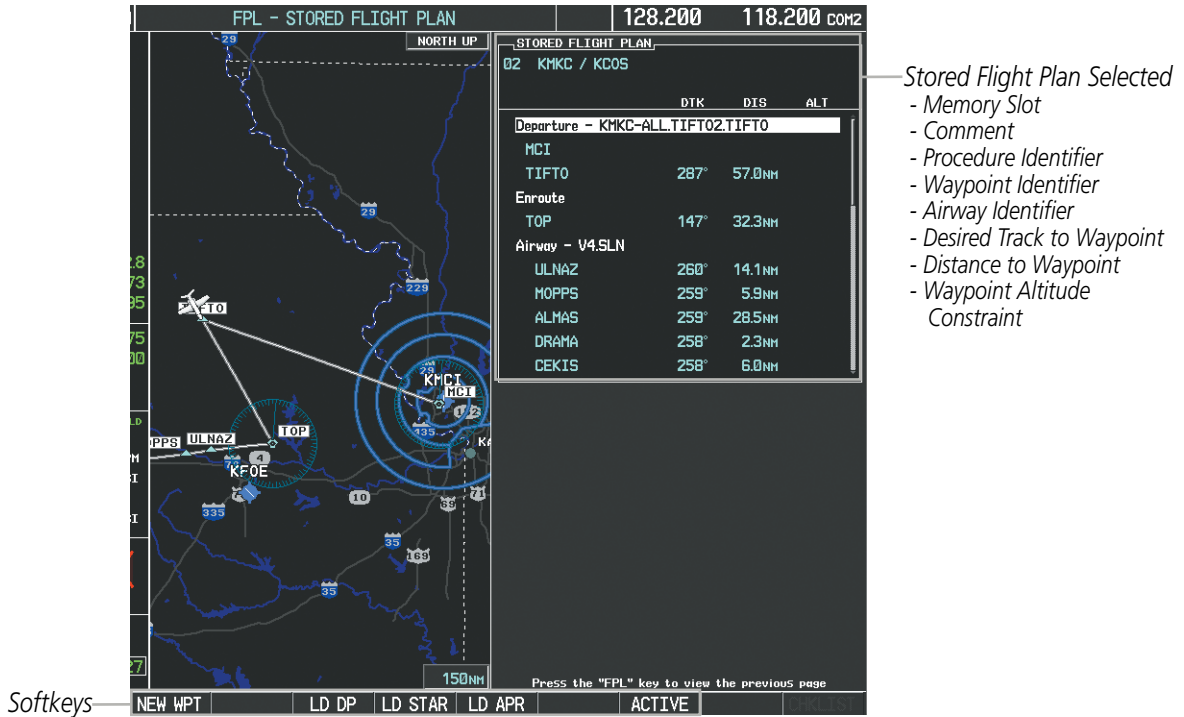

Figure 5-61 Stored Flight Plan Page

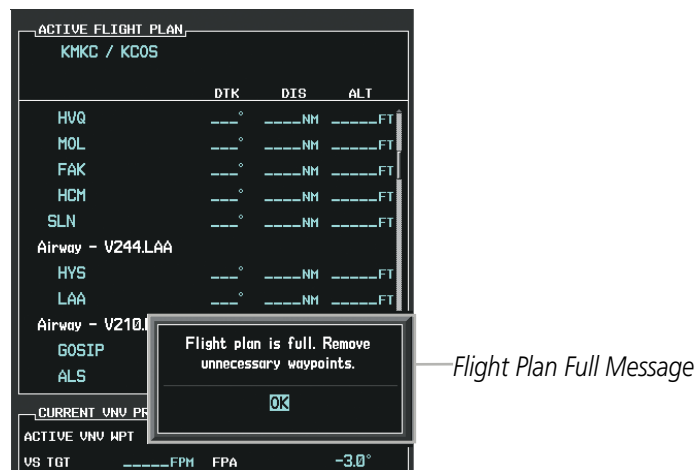

Figure 5-62 Active Flight Plan Page - FPL Full



### Adding a waypoint to a stored flight plan:

- 1) On the Flight Plan Catalog Page, press the **FMS** Knob to activate the cursor.
- 2) Highlight the desired flight plan.
- 3) Select the **EDIT** Softkey; or press the **ENT** Key, turn the large **FMS** Knob clockwise to select "EDIT" and press the **ENT** Key. The Stored Flight Plan Page is displayed.
- 4) Select the point in the flight plan to add the new waypoint. The new waypoint is placed directly in front of the highlighted waypoint.
- 5) Turn the small **FMS** Knob to display the Waypoint Information Window. (Turning it clockwise displays a blank Waypoint Information Window, turning it counter-clockwise displays the Waypoint Information Window with a waypoint selection submenu allowing selection of active flight plan, nearest, recent, user, or airway waypoints).
- 6) Enter the identifier, facility, or city name of the waypoint; or select a waypoint from the submenu of waypoints and press the **ENT** Key. The new waypoint now exists in the flight plan.



**NOTE:** If the identifier entered in the Waypoint Information Window has duplicates, a Duplicate Waypoint Window is displayed. Use the FMS Knob to select the correct waypoint.

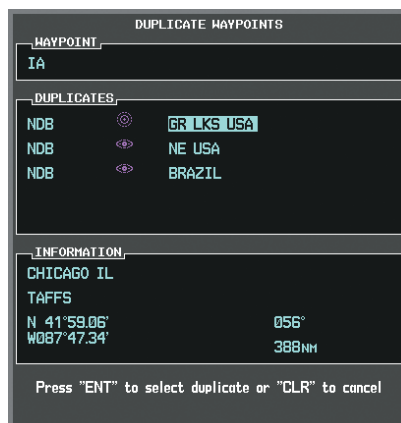

Figure 5-63 Duplicate Waypoints Window

### Adding a waypoint to the active flight plan:

- 1) Press the **FPL** Key.
- 2) Press the **FMS** Knob to activate the cursor (not required on the PFD).
- 3) Select the point in the flight plan before which to add the new waypoint. The new waypoint is placed directly in front of the highlighted waypoint.
- 4) Turn the small **FMS** Knob to display the Waypoint Information Window. (Turning it clockwise displays a blank Waypoint Information Window, turning it counter-clockwise displays the Waypoint Information Window with a waypoint selection submenu allowing selection of active flight plan, nearest, recent, user, or airway waypoints).
- 5) Enter the identifier, facility, or city name of the waypoint or select a waypoint from the submenu of waypoints and press the **ENT** Key. The active flight plan is modified as each waypoint is entered.



**Creating and adding user waypoints to the active flight plan:**

- 1) Press the **Joystick** to activate the panning function on the Active Flight Plan Page and pan to the map location of the desired user waypoint.
- 2) Select the **LD WPT** Softkey; or press the **MENU** Key, select 'Load Waypoint', and press the **ENT** Key. The user waypoint is created with a name of USRxxx (using the next available in sequence) and is added to the end of the active flight plan.

**ADDING AIRWAYS TO A FLIGHT PLAN**

Airways can be added to the active flight plan or any stored flight plan. Choose a flight plan (add the desired airway entry point if not already in the flight plan), select the waypoint after the desired airway entry point, select the airway, and it is added in front of the selected waypoint. An airway can only be loaded if there is a waypoint in the flight plan that is part of the desired airway and is not part of an arrival or approach procedure. The system also anticipates the desired airway and exit point based on loaded flight plan waypoints.

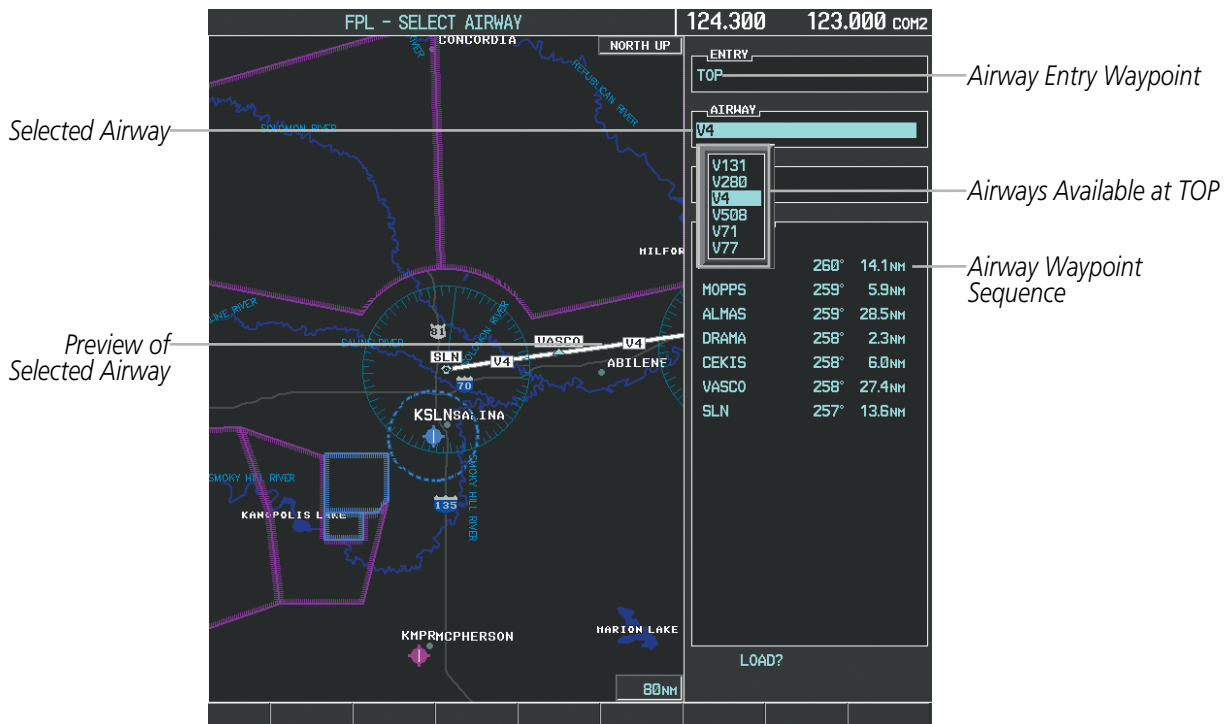

Figure 5-64 Select Airway Page - Selecting Airway

**Adding an airway to a flight plan:**

- 1) Press the **FPL** Key.
- 2) Press the **FMS** Knob to activate the cursor (not required on the PFD).
- 3) Turn the large **FMS** Knob to highlight the waypoint after the desired airway entry point. If this waypoint is not a valid airway entry point, a valid entry point should be entered at this time.

- 4) Turn the small **FMS** Knob one click clockwise and select the **LD AIRWY** Softkey, or press the **MENU** Key and select "Load Airway". The Select Airway Page is displayed. The **LD AIRWY** Softkey or the "Load Airway" menu item is available only when a valid airway entry waypoint has been chosen (the waypoint ahead of the cursor position).
- 5) Turn the **FMS** Knob to select the desired airway from the list, and press the **ENT** Key. Low altitude airways are shown first in the list, followed by "all" altitude airways, and then high altitude airways.
- 6) Turn the **FMS** Knob to select the desired airway exit point from the list, and press the **ENT** Key. 'LOAD?' is highlighted.
- 7) Press the **ENT** Key. The system returns to editing the flight plan with the new airway inserted.



Figure 5-65 Select Airway Page - Selecting Exit Point

ACTIVE FLIGHT PLAN			
KMKC / KDOS			
	DTK	DIS	ALT
Departure - KMKC-ALL.TIFT02.TIFT0			
MCI			_____FT
TIFT0	___°	___NM	_____FT
Enroute			
TOP	147°	6.8NM	12000FT
Airway - V4.SLN			
ULNAZ	260°	14.1NM	12000FT
MOPPS	259°	5.9NM	12000FT
ALMAS	259°	28.5NM	12000FT
DRAMA	258°	2.3NM	12000FT
CEKIS	258°	6.0NM	12000FT
CURRENT UNV PROFILE			
ACT UNV HPT	9000FT	at HABUK	inf
VS TGT	-1500FPM	FPA	-3.0°
VS REQ	_____FPM	V DEV	_____FT TOD 01:46
SELECTED WAYPOINT WEATHER			

Inserted Airway Header  
 - Airway Identifier: [airway identifier].[exit waypoint identifier]  
 (e.g., V4.SLN)

Figure 5-66 Active Flight Plan Page - Airway Inserted

### RESTRICTIONS ON ADDING AIRWAYS

Some airways have directional restrictions on all or part of the route. Airway “A2” in Europe has a directional restriction over the whole route such that it can be flown only in the direction MTD-ABB-BNE-DEVAL.

Airway “UR975” in North Africa has more complicated directional restrictions within the list of airway waypoints AMANO, VAKOR, LIBRO, NELDA, DIRKA, GZO, KOSET, and SARKI:

- Starting from AMANO, the airway can be flown only to LIBRO.
- Starting from SARKI, the airway can be flown only to LIBRO.
- Between NELDA and GZO, the airway can be flown in either direction.

In the US, airways that are “one-way” for specified hours of operation are not uncommon. These airways are always bidirectional in the database.

The system only allows correct airway sequences to be inserted. If the pilot subsequently inverts the flight plan, the system inverts the airway waypoint sequence and removes the airway header.

## ADDING PROCEDURES TO A STORED FLIGHT PLAN

The system allows the pilot to insert pre-defined instrument procedures from the navigation database into a flight plan. The procedures are designed to facilitate routing of traffic leaving an airport (departure), arriving at an airport (arrival), and landing at an airport (approach). See the procedures section for more details.

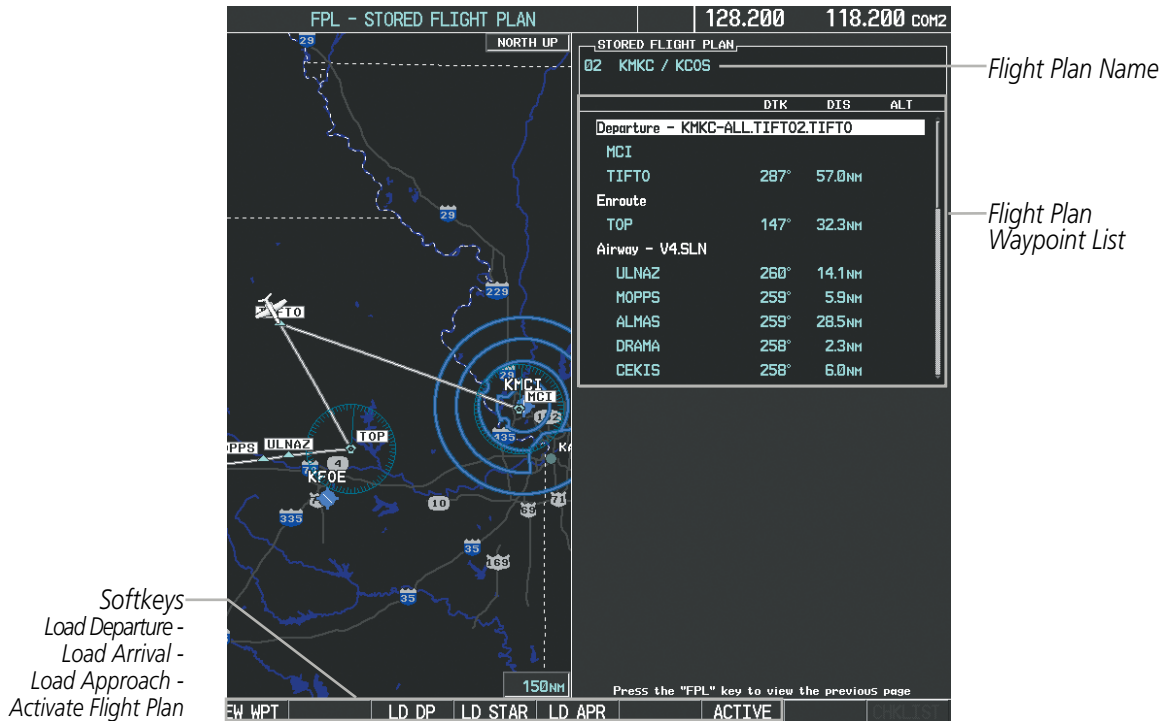

Figure 5-67 Stored Flight Plan Page

## DEPARTURE (DP)

A Departure Procedure (DP) is loaded at the departure airport in the flight plan. Only one departure can be loaded at a time in a flight plan. The route is defined by selection of a departure, the transition waypoints, and a runway.

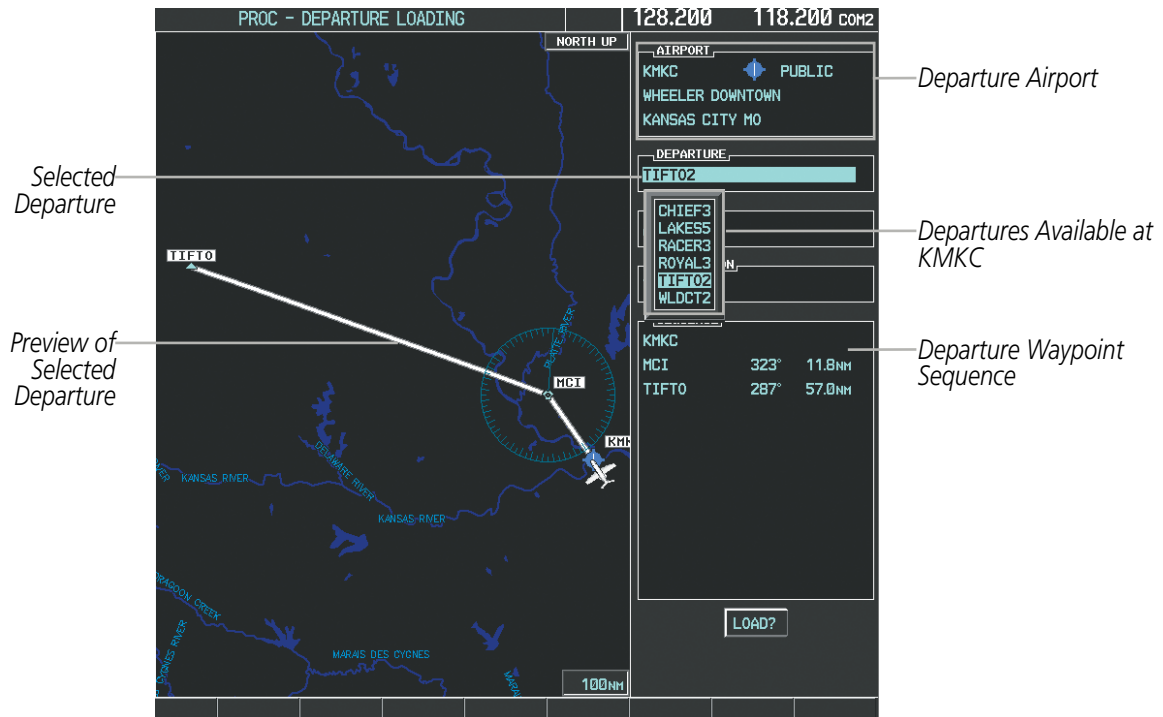

Figure 5-68 Departure Loading Page - Selecting the Departure

### Loading a departure procedure into a stored flight plan:

- 1) Select a stored flight plan from the Flight Plan Catalog Page.
- 2) Select the **EDIT** Softkey; or press the **MENU** Key, select 'Edit Flight Plan', and press the **ENT** Key. The Stored Flight Plan Page is displayed.
- 3) Select the **LD DP** Softkey; or press the **MENU** Key, select "Load Departure", and press the **ENT** Key. The Departure Loading Page is displayed.
- 4) Select a departure. Press the **ENT** Key.
- 5) Select a runway served by the selected departure, if required. Press the **ENT** Key.
- 6) Select a transition for the selected departure. Press the **ENT** Key.
- 7) Press the **ENT** Key to load the selected departure procedure.

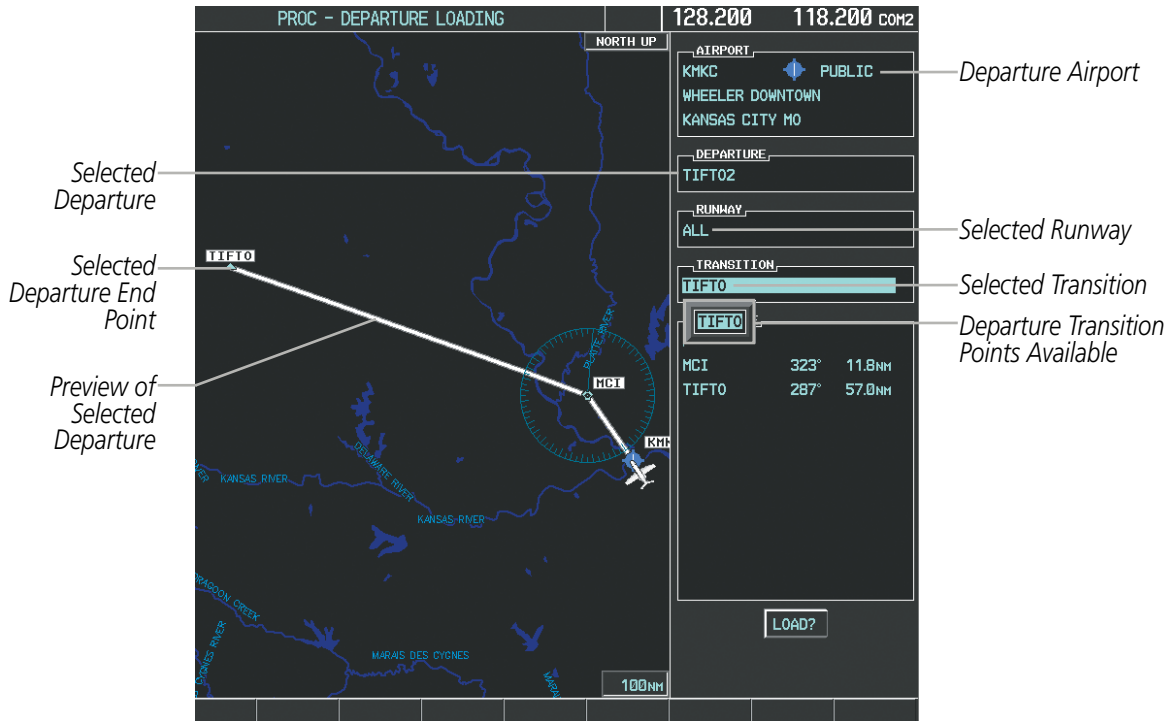

Figure 5-69 Departure Loading Page - Selecting Transition

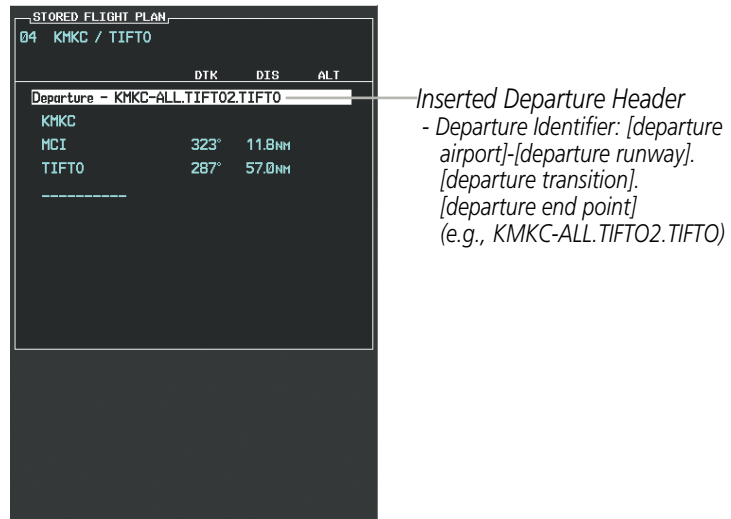

Figure 5-70 Stored Flight Plan Page - Departure Inserted

## ARRIVAL (STAR)

A Standard Terminal Arrival (STAR) is loaded at the destination airport in the flight plan. Only one arrival can be loaded at a time in a flight plan. The route is defined by selection of an arrival, the transition waypoints, and a runway.

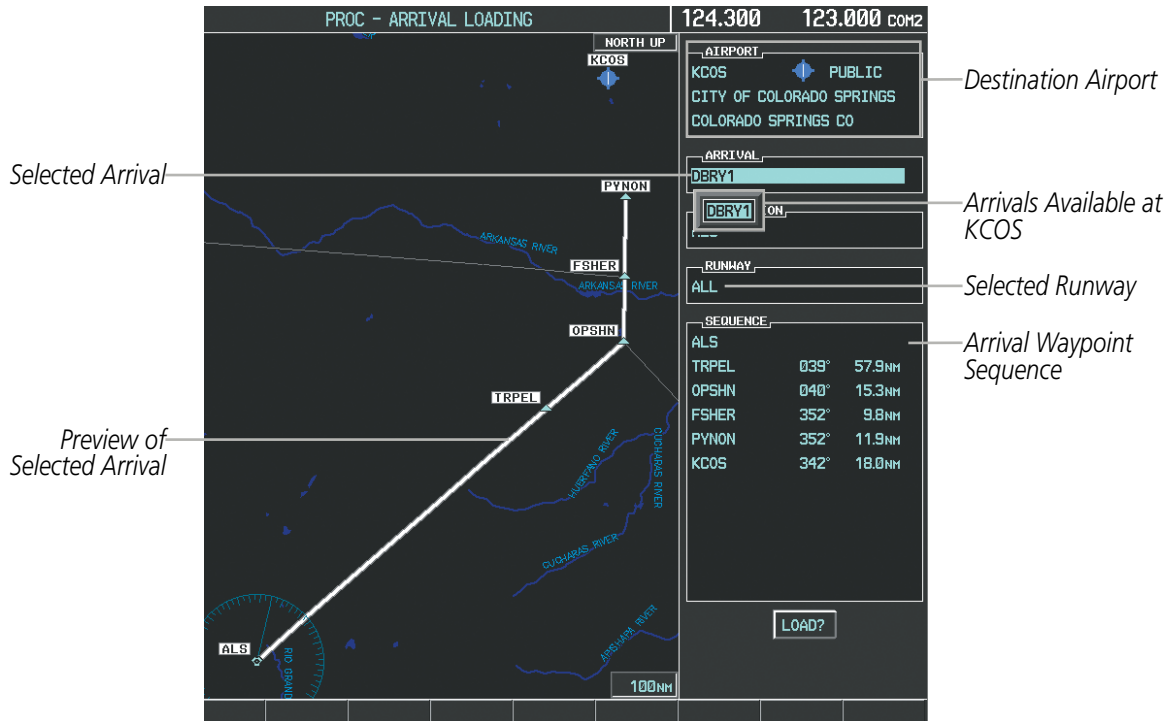

Figure 5-71 Arrival Loading Page - Selecting the Arrival

### Loading an arrival procedure into a stored flight plan:

- 1) Select a stored flight plan from the Flight Plan Catalog Page.
- 2) Select the **EDIT** Softkey; or press the **MENU** Key, select 'Edit Flight Plan', and press the **ENT** Key. The Stored Flight Plan Page is displayed.
- 3) Select the **LD STAR** Softkey; or press the **MENU** Key, select "Load Arrival", and press the **ENT** Key. The Arrival Loading Page is displayed.
- 4) Select an arrival. Press the **ENT** Key.
- 5) Select a transition for the selected arrival. Press the **ENT** Key.
- 6) Select a runway served by the selected arrival, if required. Press the **ENT** Key.
- 7) Press the **ENT** Key to load the selected arrival procedure.



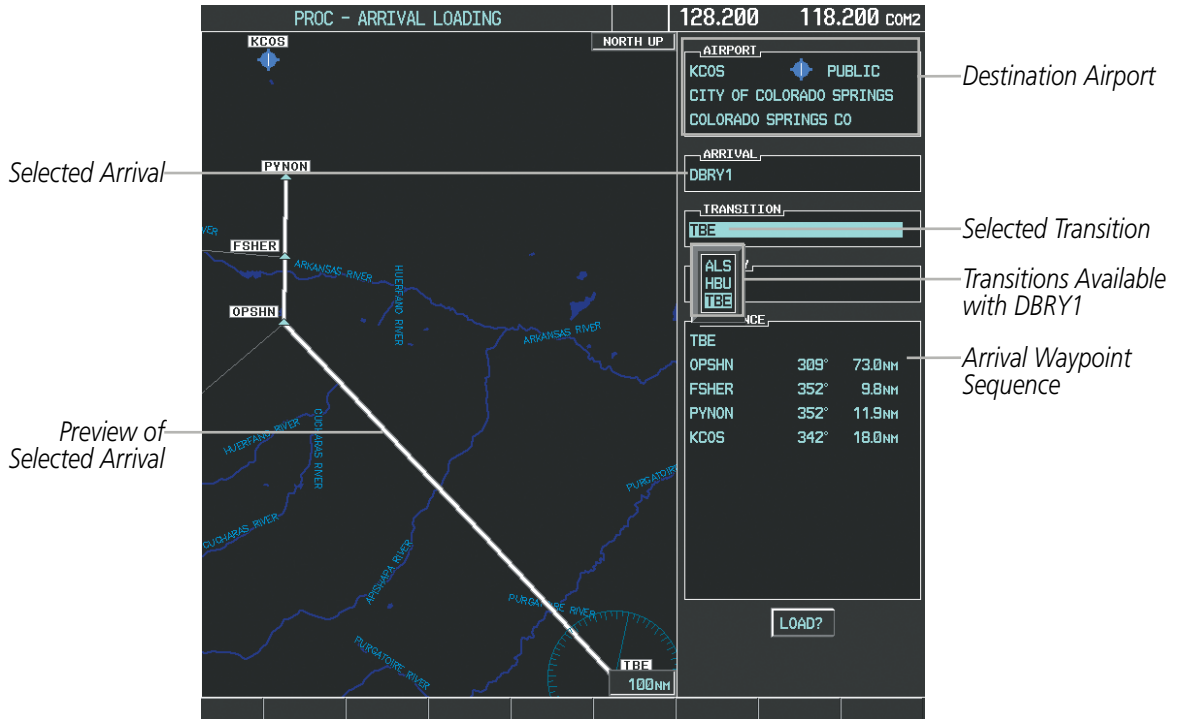

Figure 5-72 Arrival Loading Page - Selecting the Transition

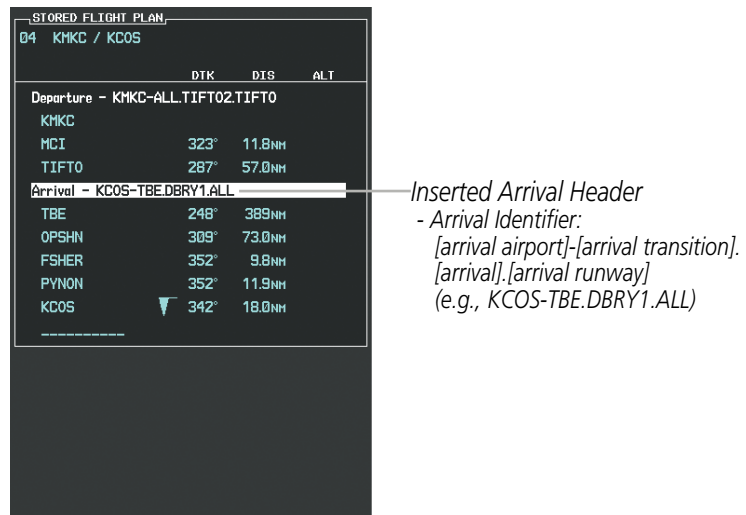

Figure 5-73 Stored Flight Plan Page - Arrival Inserted



## APPROACH (APPR)

An Approach Procedure (APPR) can be loaded at any airport that has an approach available. Only one approach can be loaded at a time in a flight plan. The route for a selected approach is defined by designating transition waypoints.

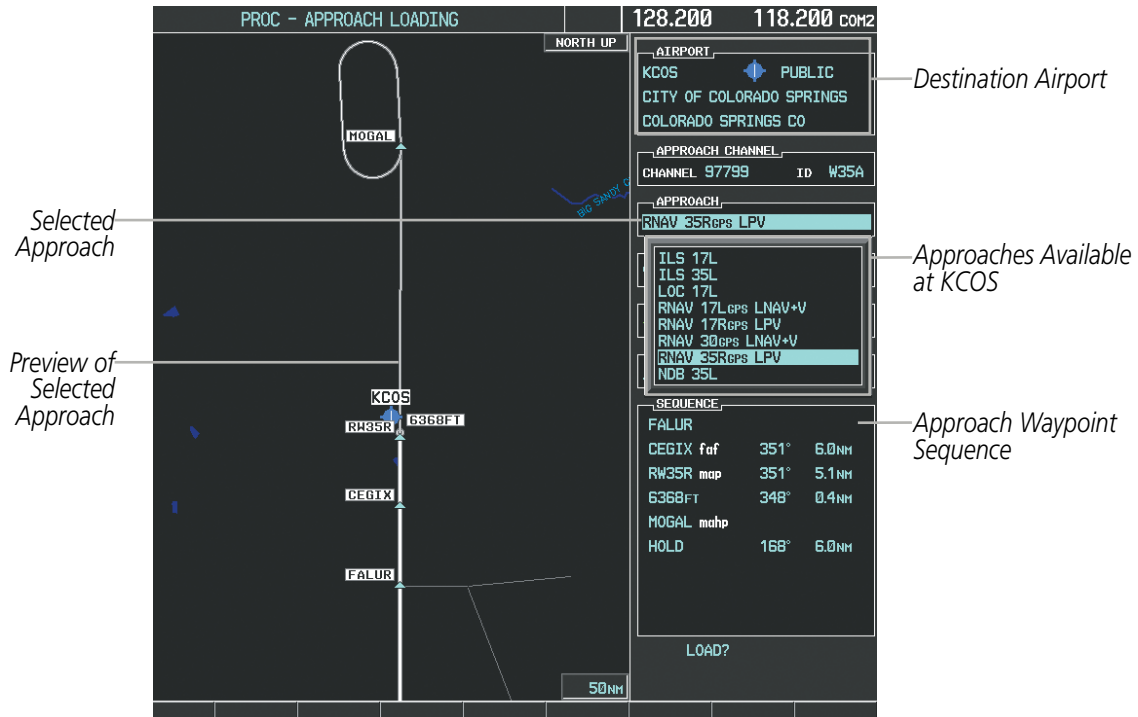

Figure 5-74 Approach Loading Page - Selecting the Approach

### Loading an approach procedure into a stored flight plan:

- 1) Select a stored flight plan from the Flight Plan Catalog Page.
- 2) Select the **EDIT** Softkey; or press the **MENU** Key, select 'Edit Flight Plan', and press the **ENT** Key. The Stored Flight Plan Page is displayed.
- 3) Select the **LD APR** Softkey; or press the **MENU** Key, select "Load Approach", and press the **ENT** Key. The Approach Loading Page is displayed.
- 4) Select an approach. Press the **ENT** Key.
- 5) Select a transition for the selected approach. Press the **ENT** Key.
- 6) Press the **ENT** Key to load the selected approach procedure.

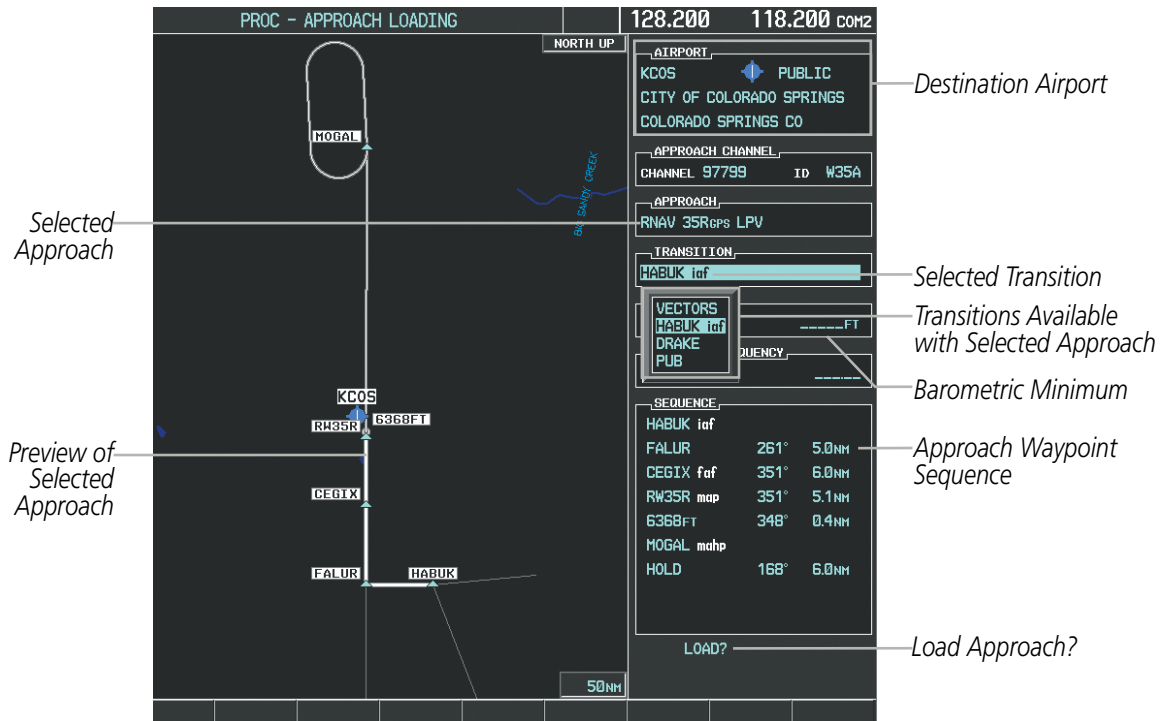

Figure 5-75 Approach Loading Page - Selecting the Transition

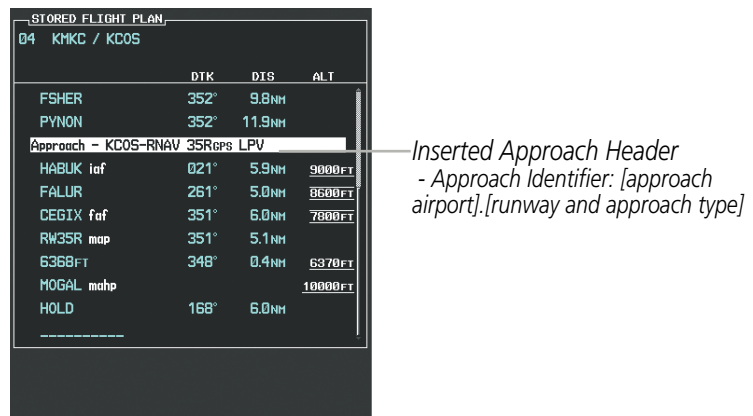

Figure 5-76 Stored Flight Plan Page - Approach Inserted



## ACTIVATE A FLIGHT PLAN

Activating a stored flight plan erases the active flight plan and replaces it with the flight plan being activated. Inverting a stored flight plan reverses the waypoint order, erases the active flight plan, and replaces it with the flight plan being activated (the stored flight plan is not changed).

### Activating a stored flight plan on the MFD:

- 1) Press the **FPL** Key and turn the small **FMS** Knob to display the Flight Plan Catalog Page.
- 2) Press the **FMS** Knob to activate the cursor, and turn the **FMS** Knob to highlight the desired flight plan.
- 3) Select the **ACTIVE** Softkey; or press the **ENT** Key twice; or press the **MENU** Key, highlight 'Activate Flight Plan', and press the **ENT** Key. The 'Activate Stored Flight Plan?' window is displayed.
- 4) With 'OK' highlighted, press the **ENT** Key. To cancel the request, press the **CLR** Key, or highlight 'CANCEL' and press the **ENT** Key.

### Inverting and activating a stored flight plan on the MFD:

- 1) Press the **FPL** Key and turn the small **FMS** Knob to display the Flight Plan Catalog Page.
- 2) Press the **FMS** Knob to activate the cursor, and turn the **FMS** Knob to highlight the desired flight plan.
- 3) Select the **INVERT** Softkey; or press the **MENU** Key, highlight 'Invert & Activate FPL?', and press the **ENT** Key. The 'Invert and activate stored flight plan?' window is displayed.
- 4) With 'OK' highlighted, press the **ENT** Key. To cancel the request, press the **CLR** Key, or highlight 'CANCEL' and press the **ENT** Key.

## COPY A FLIGHT PLAN

The system allows copying a flight plan into a new flight plan memory slot, allowing editing, etc., without affecting the original flight plan. This can be used to duplicate an existing stored flight plan for use in creating a modified version of the original stored flight plan.

### Copying a stored flight plan on the MFD:

- 1) Press the **FPL** Key and turn the small **FMS** Knob to display the Flight Plan Catalog Page.
- 2) Press the **FMS** Knob to activate the cursor, and turn the **FMS** Knob to highlight the desired flight plan.
- 3) Select the **COPY** Softkey; or press the **MENU** Key, highlight 'Copy Flight Plan', and press the **ENT** Key. The 'Copy to Flight Plan XX?' window is displayed.
- 4) With 'OK' highlighted, press the **ENT** Key to copy the flight plan. To cancel the request, press the **CLR** Key, or highlight 'CANCEL' and press the **ENT** Key.

## DELETE A STORED FLIGHT PLAN

Individual or all stored flight plans can be deleted from memory.

### Deleting a stored flight plan:

- 1) Press the **FPL** Key and turn the small **FMS** Knob to display the Flight Plan Catalog Page.
- 2) Press the **FMS** Knob to activate the cursor, and turn the **FMS** Knob to highlight the desired flight plan.
- 3) Select the **DELETE** Softkey; press the **CLR** Key; or press the **MENU** Key, highlight 'Delete Flight Plan', and press the **ENT** Key. The 'Delete Flight Plan XX?' window is displayed.
- 4) With 'OK' highlighted, press the **ENT** Key to delete the flight plan. To cancel the request, press the **CLR** Key, or highlight 'CANCEL' and press the **ENT** Key.



**NOTE:** The option to delete all stored flight plans is not available while the aircraft is in flight.

### Deleting all stored flight plans:

- 1) Press the **FPL** Key and turn the small **FMS** Knob to display the Flight Plan Catalog Page.
- 2) Press the **MENU** Key.
- 3) Highlight 'Delete All' and press the **ENT** Key. A 'Delete all flight plans?' confirmation window is displayed.
- 4) With 'OK' highlighted, press the **ENT** Key to delete all flight plans. To cancel the request, press the **CLR** Key, or highlight 'CANCEL' and press the **ENT** Key.

## FLIGHT PLAN EDITING

The active flight plan or any stored flight plan can be edited. The edits made to the active flight plan affect navigation as soon as they are entered.

### DELETING THE ACTIVE FLIGHT PLAN

The system allows deleting an active flight plan. Deleting the active flight plan suspends navigation by the system.

#### Deleting the active flight plan:

- 1) Press the **FPL** Key to display the Active Flight Plan Page (MFD) or the Active Flight Plan Window (PFD).
- 2) Press the **MENU** Key, highlight 'Delete Flight Plan', and press the **ENT** Key. The 'Delete all waypoints in flight plan?' window is displayed.
- 3) With 'OK' highlighted, press the **ENT** Key to delete the active flight plan. To cancel the request, press the **CLR** Key, or highlight 'CANCEL' and press the **ENT** Key.

## DELETING FLIGHT PLAN ITEMS

Individual waypoints, entire airways, and entire procedures can be deleted from a flight plan. Some waypoints in the final approach segment (such as the FAF or MAP) can not be deleted individually. Attempting to delete a waypoint that is not allowed results in a window displaying 'Invalid flight plan modification.'

### Deleting an individual waypoint from the active flight plan:

- 1) Press the **FPL** Key to display the Active Flight Plan Page (MFD) or the Active Flight Plan Window (PFD).
- 2) Press the **FMS** Knob to activate the cursor (not required on the PFD) and turn the large **FMS** Knob to highlight the waypoint to be deleted.
- 3) Press the **CLR** Key. The 'Remove XXXXX?' window is displayed.
- 4) With 'OK' highlighted, press the **ENT** Key. To cancel the request, press the **CLR** Key, or highlight 'CANCEL' and press the **ENT** Key.
- 5) Press the **FMS** Knob to remove the flashing cursor.

### Deleting an entire airway from the active flight plan:

- 1) Press the **FPL** Key to display the Active Flight Plan Page (MFD) or the Active Flight Plan Window (PFD).
- 2) Press the **FMS** Knob to activate the cursor (not required on the PFD) and turn the large **FMS** Knob to highlight the white header of the airway to be deleted.
- 3) Press the **CLR** Key. The 'Remove <airway name>?' window is displayed.
- 4) With 'OK' highlighted, press the **ENT** Key. To cancel the request, press the **CLR** Key, or highlight 'CANCEL' and press the **ENT** Key.
- 5) Press the **FMS** Knob to remove the flashing cursor.

### Deleting an entire procedure from the active flight plan:

- 1) Press the **FPL** Key to display the Active Flight Plan Page (MFD) or the Active Flight Plan Window (PFD).
- 2) Press the **FMS** Knob to activate the cursor (not required on the PFD) and turn the large **FMS** Knob to highlight the white header of the procedure to be deleted.
- 3) Press the **CLR** Key. The 'Remove <procedure name> from flight plan?' window is displayed.
- 4) With 'OK' highlighted, press the **ENT** Key. To cancel the request, press the **CLR** Key, or highlight 'CANCEL' and press the **ENT** Key.
- 5) Press the **FMS** Knob to remove the flashing cursor.

#### Or:

- 1) Press the **FPL** Key to display the Active Flight Plan Page (MFD) or the Active Flight Plan Window (PFD).
- 2) Press the **MENU** Key to display the Page Menu and turn the **FMS** Knob to highlight 'Remove <procedure>'.  
3) Press the **ENT** Key. The 'Remove <procedure name> from flight plan?' window is displayed.
- 4) With 'OK' highlighted, press the **ENT** Key. To cancel the request, press the **CLR** Key, or highlight 'CANCEL' and press the **ENT** Key.

**Deleting an individual waypoint from a stored flight plan:**

- 1) Press the **FPL** Key to display the Active Flight Plan Page.
- 2) Turn the small **FMS** Knob clockwise one click to display the Flight Plan Catalog Page.
- 3) Press the **FMS** Knob to activate the cursor and turn the **FMS** Knob to highlight the flight plan to be edited.
- 4) Select the **EDIT** Softkey; or press the **MENU** Key, select 'Edit Flight Plan' and press the **ENT** Key. The Stored Flight Plan Page is displayed.
- 5) Turn the large **FMS** Knob to highlight the waypoint to be deleted.
- 6) Press the **CLR** Key. The 'Remove XXXXX?' window is displayed.
- 7) With 'OK' highlighted, press the **ENT** Key. To cancel the request, press the **CLR** Key, or highlight 'CANCEL' and press the **ENT** Key.
- 8) Press the **FMS** Knob to remove the flashing cursor.

**Deleting an entire airway from a stored flight plan:**

- 1) Press the **FPL** Key to display the Active Flight Plan Page.
- 2) Turn the small **FMS** Knob clockwise one click to display the Flight Plan Catalog Page.
- 3) Press the **FMS** Knob to activate the cursor and turn the **FMS** Knob to highlight the flight plan to be edited.
- 4) Select the **EDIT** Softkey; or press the **MENU** Key, select 'Edit Flight Plan' and press the **ENT** Key. The Stored Flight Plan Page is displayed.
- 5) Turn the large **FMS** Knob to highlight the white header of the airway to be deleted.
- 6) Press the **CLR** Key. The 'Remove <airway name>?' window is displayed.
- 7) With 'OK' highlighted, press the **ENT** Key. To cancel the request, press the **CLR** Key, or highlight 'CANCEL' and press the **ENT** Key.
- 8) Press the **FMS** Knob to remove the flashing cursor.

**Deleting an entire procedure from a stored flight plan:**

- 1) Press the **FPL** Key to display the Active Flight Plan Page.
- 2) Turn the small **FMS** Knob clockwise one click to display the Flight Plan Catalog Page.
- 3) Press the **FMS** Knob to activate the cursor and turn the **FMS** Knob to highlight the flight plan to be edited.
- 4) Select the **EDIT** Softkey; or press the **MENU** Key, select 'Edit Flight Plan' and press the **ENT** Key. The Stored Flight Plan Page is displayed.
- 5) Turn the large **FMS** Knob to highlight the white header of the procedure to be deleted.
- 6) Press the **CLR** Key. The 'Remove <procedure name> from flight plan?' window is displayed.
- 7) With 'OK' highlighted, press the **ENT** Key. To cancel the request, press the **CLR** Key, or highlight 'CANCEL' and press the **ENT** Key.
- 8) Press the **FMS** Knob to remove the flashing cursor.

**Or:**

- 1) Press the **FPL** Key to display the Active Flight Plan Page.
- 2) Turn the small **FMS** Knob clockwise one click to display the Flight Plan Catalog Page.
- 3) Press the **FMS** Knob to activate the cursor and turn the **FMS** Knob to highlight the flight plan to be edited.
- 4) Select the **EDIT** Softkey; or press the **MENU** Key, select 'Edit Flight Plan' and press the **ENT** Key. The Stored Flight Plan Page is displayed.
- 5) Press the **MENU** Key to display the Page Menu and turn the **FMS** Knob to highlight 'Remove <procedure>'.  
6) Press the **ENT** Key. The 'Remove <procedure name> from flight plan?' window is displayed.
- 7) With 'OK' highlighted, press the **ENT** Key. To cancel the request, press the **CLR** Key, or highlight 'CANCEL' and press the **ENT** Key.
- 8) Press the **FMS** Knob to remove the flashing cursor.

## CHANGING FLIGHT PLAN COMMENTS (NAMES)

The comment field (or name) of each flight plan can be changed to something that is useful for identification and sorting.

### Changing the active flight plan comment:

- 1) Press the **FPL** Key to display the Active Flight Plan Page.
- 2) Press the **FMS** Knob to activate the cursor and turn the large **FMS** Knob to highlight the comment field.
- 3) Use the **FMS** Knobs to edit the comment.
- 4) Press the **ENT** Key to accept the changes.
- 5) Press the **FMS** Knob to remove the flashing cursor.

### Changing a stored flight plan comment:

- 1) Press the **FPL** Key to display the Active Flight Plan Page.
- 2) Turn the small **FMS** Knob clockwise one click to display the Flight Plan Catalog Page.
- 3) Press the **FMS** Knob to activate the cursor and turn the **FMS** Knob to highlight the flight plan to be edited.
- 4) Select the **EDIT** Softkey; or press the **MENU** Key, select 'Edit Flight Plan' and press the **ENT** Key. The Stored Flight Plan Page is displayed.
- 5) Turn the large **FMS** Knob to highlight the comment field.
- 6) Use the **FMS** Knobs to edit the comment.
- 7) Press the **ENT** Key to accept the changes.
- 8) Press the **FMS** Knob to remove the flashing cursor.



## ALONG TRACK OFFSETS

A waypoint having an “along track offset” distance from an existing waypoint can be entered into a flight plan. Along track offset waypoints lie along the path of the existing flight plan, and can be used to make the system reach a specified altitude before or after reaching the specified flight plan waypoint. Offset distances can be entered from 1 to 99 nm in increments of 1 nm. Entering a negative offset distance results in an along track offset waypoint inserted before the selected waypoint, whereas entering a positive offset distance results in an along track offset waypoint inserted after the selected waypoint. Multiple offset waypoints are allowed.

A waypoint must be adjacent to its parent waypoint in the flight plan, so the system limits the along-track distance to less than the length of the leg before or after the selected waypoint. If the selected waypoint is the active waypoint, the distance is limited to less than the distance to go to the active waypoint. Assigning an along track offset to a leg with indeterminate length is not permitted. An along track offset is not allowed at or after the final approach fix of an approach.

An along track offset distance cannot be modified once entered. If the along track offset distance must be changed, the existing along track offset waypoint must be deleted and a new one created with the new offset distance.

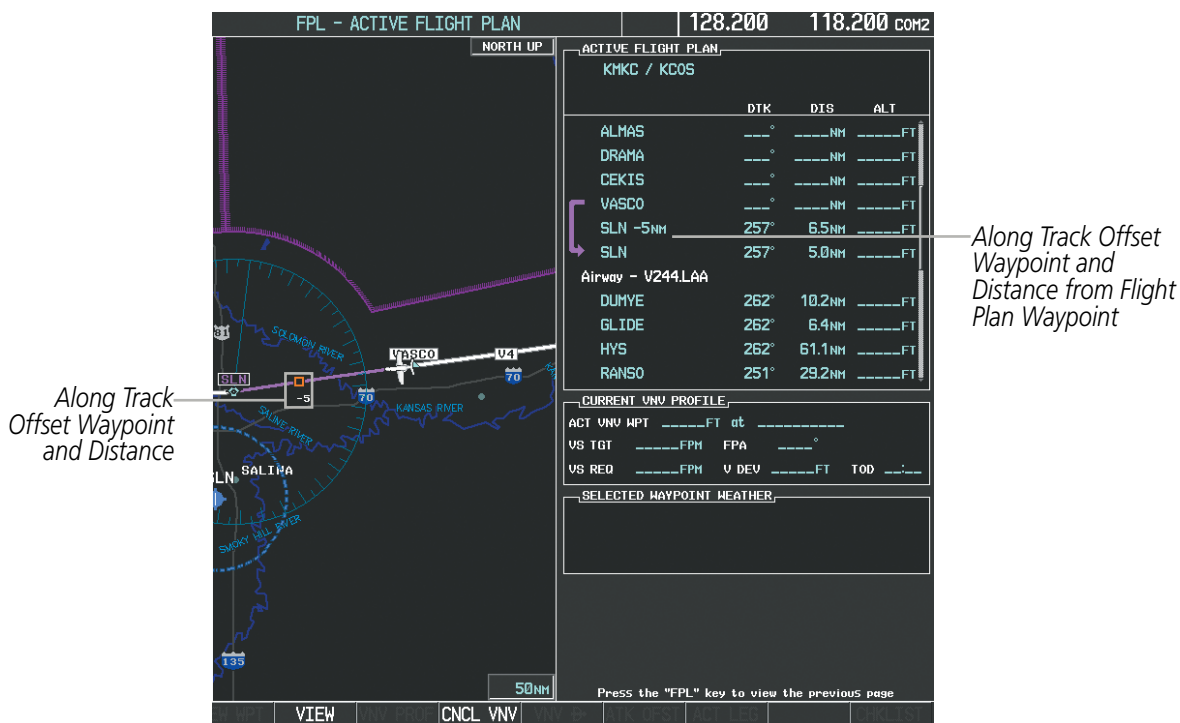

Figure 5-78 Along Track Offset

### Entering an along track offset distance:

- 1) Press the **FPL** Key to display the Active Flight Plan Page (MFD) or the Active Flight Plan Window (PFD).
- 2) Press the **FMS** Knob to activate the cursor (not required on the PFD) and turn the large **FMS** Knob to highlight the waypoint for the along track offset.
- 3) Select the **ATK OFST** Softkey (MFD only); or press the **MENU** Key, highlight 'Create ATK Offset Waypoint', and press the **ENT** Key.

- 4) Enter a positive or negative offset distance in the range of +/- 1 to 99 nm (limited by leg distance).
- 5) Press the **ENT** Key to create the offset waypoint.
- 6) Press the **FMS** Knob to remove the flashing cursor.

## PARALLEL TRACK

The Parallel Track (PTK) feature allows creation of a parallel course offset of 1 to 50 nm left or right of the current flight plan. When Parallel Track is activated, the course line drawn on the map pages shows the parallel course, and waypoint names have a lower case “p” placed after the identifier.

Using direct-to, loading an approach, a holding pattern, or editing and activating the flight plan automatically cancels Parallel Track. Parallel Track is also cancelled if a course change occurs greater than 120° or the parallel tracks overlap as a result of the course change.



**NOTE:** Vertical navigation is unavailable while the Parallel Track feature is active.

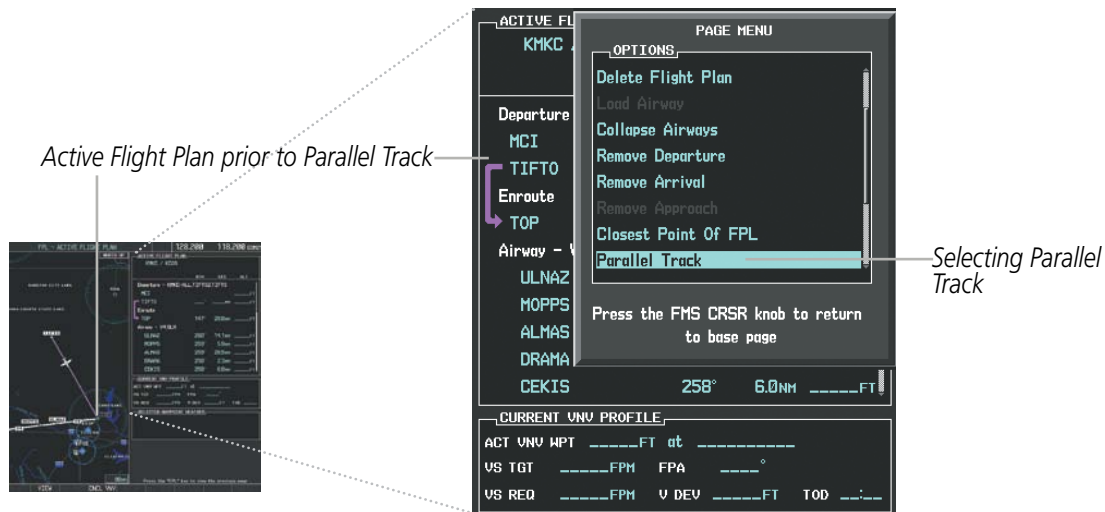

Figure 5-79 Active Flight Plan Window - Selecting Parallel Track

### Activating parallel track:

- 1) Press the **FPL** Key to display the Active Flight Plan Page (MFD) or the Active Flight Plan Window (PFD).
- 2) Press the **MENU** Key, highlight ‘Parallel Track’, and press the **ENT** Key. The Parallel Track Window is displayed with the direction field highlighted.
- 3) Turn the small **FMS** Knob to select ‘Left’ or ‘Right’ and press the **ENT** Key. The ‘DISTANCE’ field is highlighted.
- 4) Turn the small **FMS** Knob to enter a distance from 1-99 nm and press the **ENT** Key. ‘ACTIVATE PARALLEL TRACK’ is highlighted.
- 5) Press the **ENT** Key to activate parallel track. Press the **FMS** Knob or the **CLR** Key to cancel the parallel track activation.

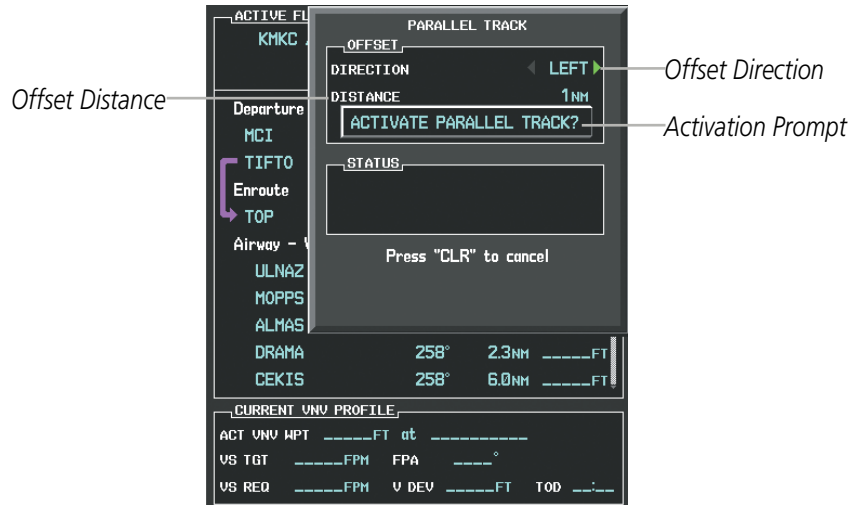

Figure 5-80 Parallel Track Window

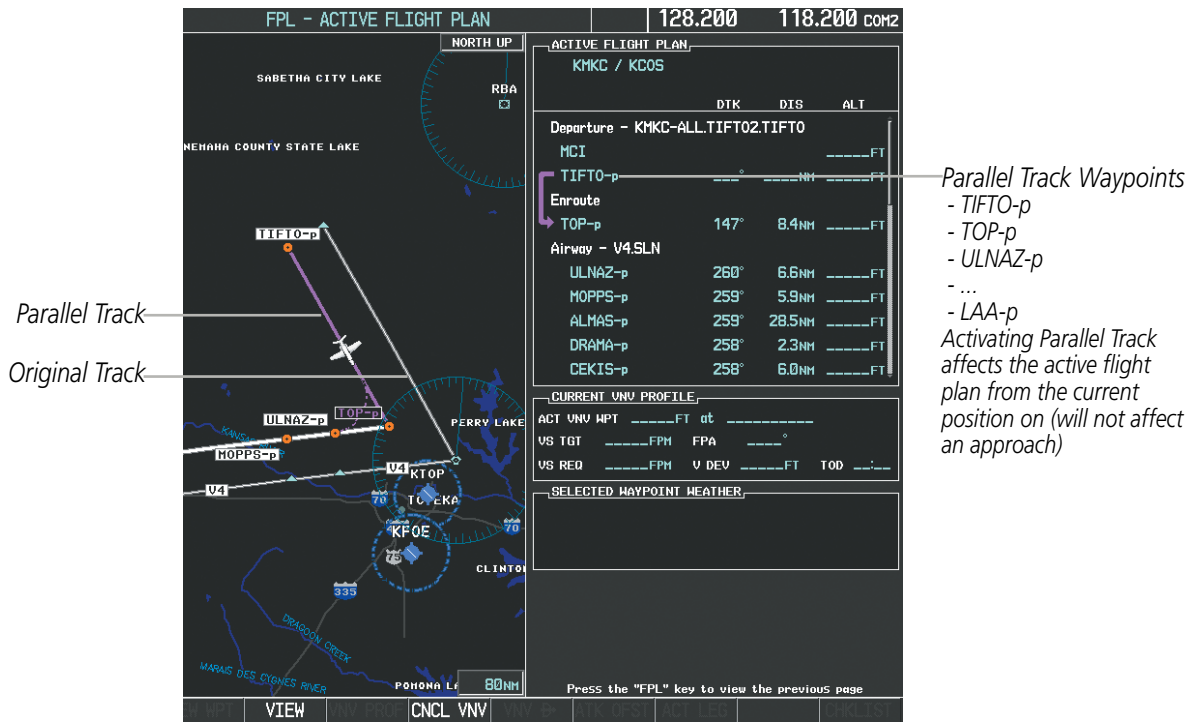

Figure 5-81 Parallel Track Active

If the parallel track proposed by the offset direction and distance is not allowed by the system, the activation prompt is displayed, but disabled. Parallel Track cannot be activated if a course is set using direct-to or if the active leg is the first leg of the departure procedure. Attempting to activate parallel track with these conditions results in the message ‘Parallel Track Unavailable Invalid Route Geometry’. If an approach leg is active the status indicates that the system is unable to activate the parallel track with the message ‘Parallel Track Unavailable Approach Leg Active’. If the offset direction and distance results in an unreasonable route geometry the status indicates that the system is unable to activate the parallel track because of invalid geometry.

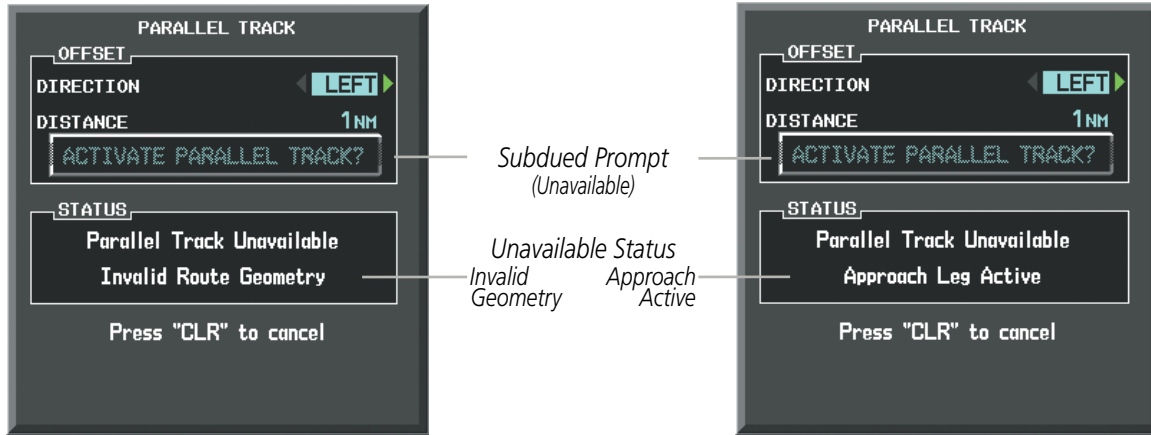

Figure 5-82 Parallel Track Unavailable

If the active leg is not a track between two fixes (TF) or a course to a fix (DF) leg, the status indicates that the system is unable to activate the parallel track because parallel track is not available for the active leg type.

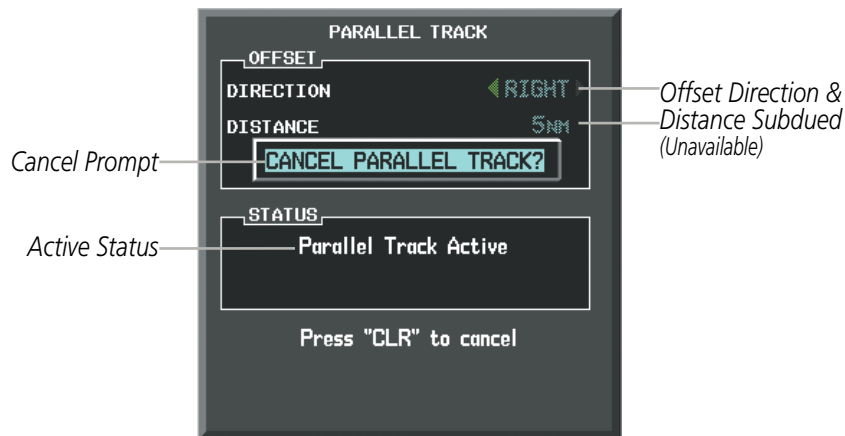

Figure 5-83 Cancelling Parallel Track

**Cancelling parallel track:**

- 1) Press the **FPL** Key to display the Active Flight Plan Page (MFD) or the Active Flight Plan Window (PFD).
- 2) Press the **MENU** Key, highlight 'Parallel Track', and press the **ENT** Key. The Parallel Track Window is displayed with 'CANCEL PARALLEL TRACK?' highlighted.
- 3) Press the **ENT** Key.

## ACTIVATING A FLIGHT PLAN LEG

The system allows selection of a highlighted leg as the “active leg” (the flight plan leg which is currently used for navigation guidance).

### Activating a flight plan leg:

- 1) Press the **FPL** Key to display the Active Flight Plan Page (MFD) or the Active Flight Plan Window (PFD).
- 2) Press the **FMS** Knob to activate the cursor (not required on the PFD) and turn the large **FMS** Knob to highlight the destination waypoint for the desired leg.
- 3) Select the **ACT LEG** Softkey (MFD only); or press the **MENU** Key, highlight ‘Activate Leg’, and press the **ENT** Key. A confirmation window is displayed with ‘ACTIVATE’ highlighted.
- 4) Press the **ENT** Key to activate the flight plan leg. To cancel, press the **CLR** Key, or highlight ‘CANCEL’ and press the **ENT** Key.
- 5) Press the **FMS** Knob to remove the flashing cursor.

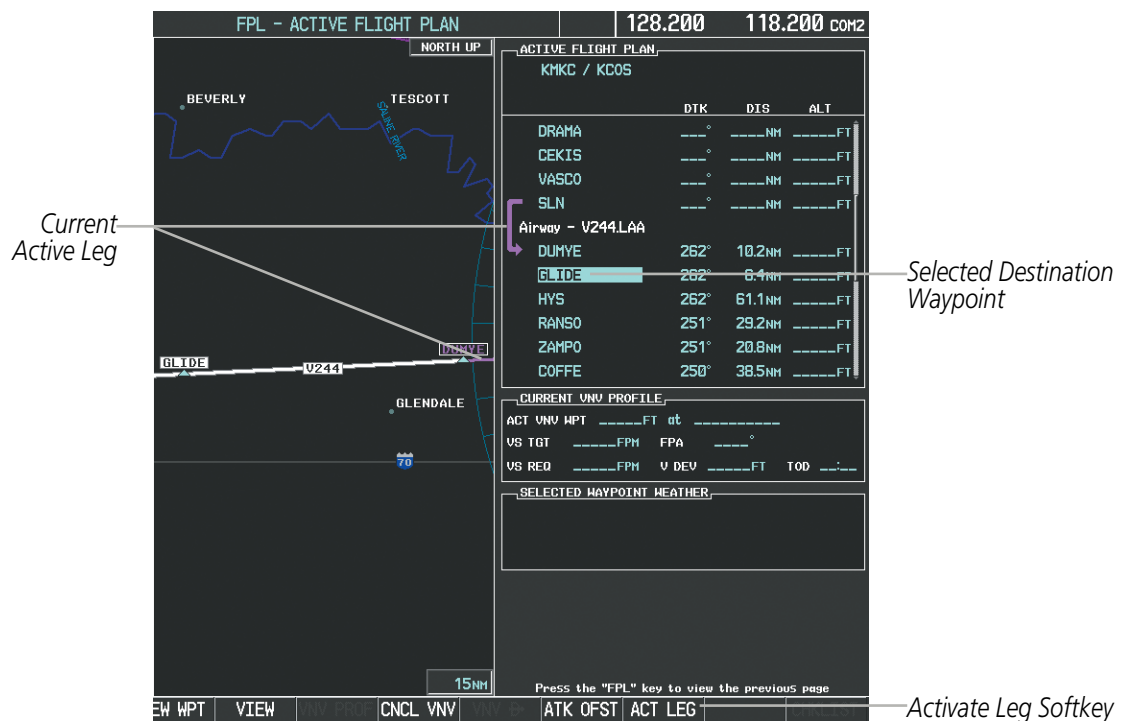

Figure 5-84 Active Flight Plan Page - Selecting the Leg Destination Waypoint

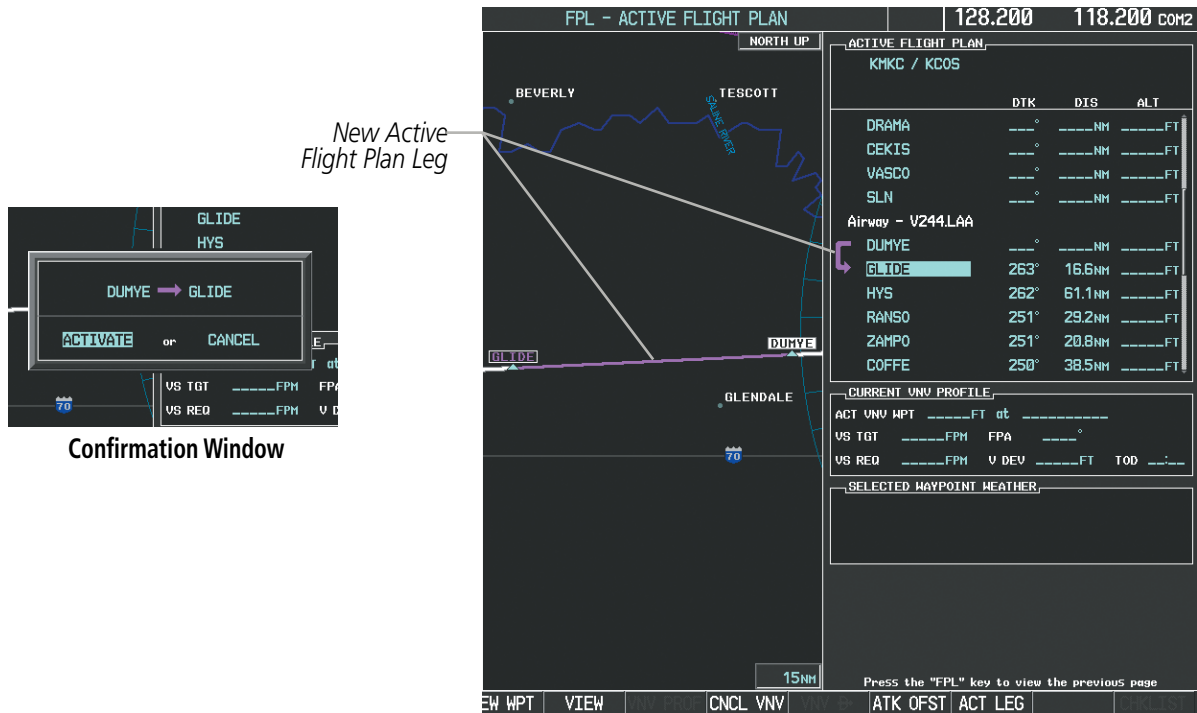

Figure 5-85 Active Flight Plan Page - New Active Leg

## INVERTING A FLIGHT PLAN

Any flight plan may be inverted (reversed) for navigation back to the original departure point.

### Inverting the active flight plan:

- 1) Press the **FPL** Key to display the Active Flight Plan Page (MFD) or the Active Flight Plan Window (PFD).
- 2) Press the **MENU** Key, highlight 'Invert Flight Plan', and press the **ENT** Key. An 'Invert Active Flight Plan?' confirmation window is displayed.
- 3) Select 'OK'.
- 4) Press the **ENT** Key to invert and activate the active flight plan. To cancel, press the **CLR** Key, or highlight 'CANCEL' and press the **ENT** Key.

### Inverting and activating a stored flight plan:

- 1) Press the **FPL** Key and turn the small **FMS** Knob to display the Flight Plan Catalog Page.
- 2) Press the **FMS** Knob to activate the cursor, and turn the **FMS** Knob to highlight the desired flight plan.
- 3) Select the **INVERT** Softkey; or press the **MENU** Key, highlight 'Invert & Activate FPL?', and press the **ENT** Key. The 'Invert and activate stored flight plan?' window is displayed.
- 4) With 'OK' highlighted, press the **ENT** Key. To cancel the request, press the **CLR** Key, or highlight 'CANCEL' and press the **ENT** Key.



## FLIGHT PLAN VIEWS

Information about flight plans can be viewed in more than one way. The active flight plan can be configured to show cumulative distance over the length of the flight plan or the distance for each leg of the flight plan; and the active flight plan can be viewed in a narrow or wide view. In the wide view, additional information is displayed: Fuel Remaining (FUEL REM), Estimated Time Enroute (ETE), Estimated Time of Arrival (ETA), and Bearing to the waypoint (BRG).

### Switching between leg-to-leg waypoint distance and cumulative waypoint distance:

- 1) Press the **FPL** Key on the MFD to display the Active Flight Plan Page.
- 2) Select the **VIEW** Softkey to display the **CUM** and **LEG-LEG** Softkeys.
- 3) Select the **CUM** Softkey to view cumulative waypoint distance, or select the **LEG-LEG** Softkey to view leg-to-leg waypoint distance.
- 4) Select the **BACK** Softkey to return to the top level active flight plan softkeys.

Active Flight Plan Leg to Leg Distance

Active Flight Plan Cumulative Distance



WIDE Softkey, NARROW Softkey, LEG-LEG Softkey, CUM Softkey

Figure 5-86 Active Flight Plan - Leg to Leg vs. Cumulative Distance

Switching between wide and narrow view:

- 1) Press the **FPL** Key on the MFD to display the Active Flight Plan Page.
- 2) Select the **VIEW** Softkey to display the **WIDE** and **NARROW** Softkeys.
- 3) Select the **WIDE** Softkey to display the wide view, or select the **NARROW** Softkey to display the narrow view.
- 4) Select the **BACK** Softkey to return to the top level active flight plan softkeys.

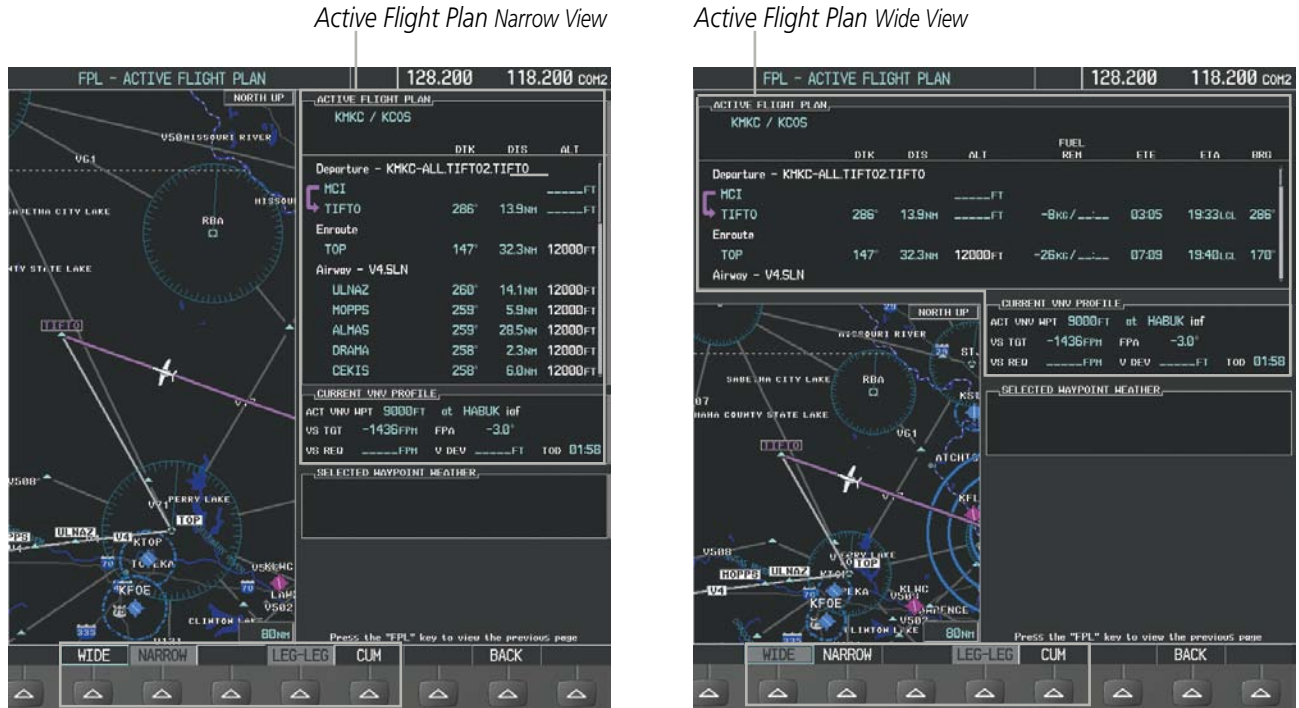

WIDE Softkey, NARROW Softkey, LEG-LEG Softkey, CUM Softkey

Figure 5-87 Active Flight Plan - Wide vs. Narrow View



## COLLAPSING AIRWAYS

The system allows airways on the active flight plan to be collapsed or expanded from the Active Flight Plan Page/Window. When airways have been collapsed, it is indicated on the airway heading.

When airways are collapsed, leg-to-leg computed values such as DIS or ETE shown for the exit waypoint reflect the total of all the legs on the airway that have been hidden in the collapsed display. The DTK value is inhibited because it is not usable in this context.

The Active Flight Plan Page always keeps the following three waypoints visible: “From” waypoint, “To” waypoint, and “Next” waypoint. To prevent one or more of these waypoints from being hidden in a collapsed airway segment, the airway segment that contains either the “To” or the “Next” waypoint is automatically expanded. When an airway is loaded, airways are automatically expanded to facilitate flight plan review.

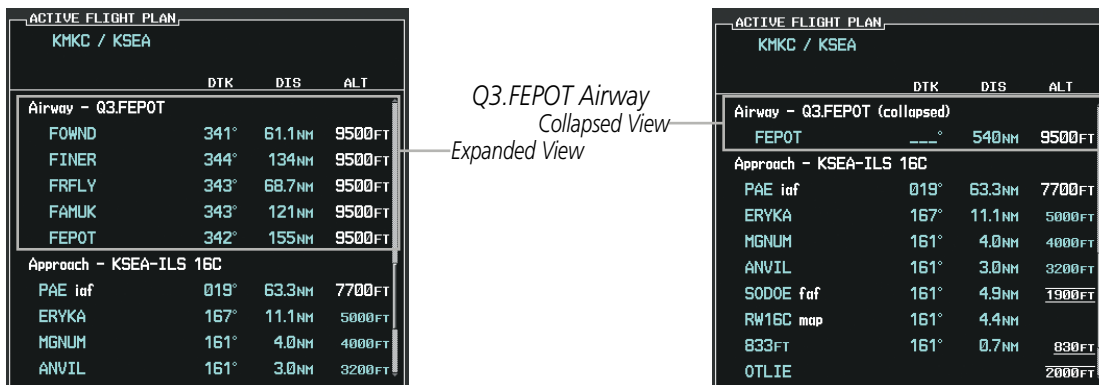

Figure 5-88 Expanded/Collapsed Airways

### Collapsing/expanding the airways in the active flight plan:

- 1) Press the **FPL** Key to display the Active Flight Plan Page (MFD) or the Active Flight Plan Window (PFD).
- 2) Press the **MENU** Key, highlight 'Collapse Airways' or 'Expand Airways', and press the **ENT** Key. The airways are collapsed/expanded.

## CLOSEST POINT OF FPL

'Closest Point of FPL' calculates the bearing and closest distance at which a flight plan passes a reference waypoint, and creates a new user waypoint along the flight plan at the location closest to a chosen reference waypoint.

### Determining the closest point along the active flight plan to a selected waypoint:

- 1) Press the **FPL** Key to display the Active Flight Plan Page (MFD) or the Active Flight Plan Window (PFD).
- 2) Press the **MENU** Key, highlight 'Closest Point Of FPL', and press the **ENT** Key. A window appears with the reference waypoint field highlighted.
- 3) Enter the identifier of the reference waypoint and press the **ENT** Key. The system displays the bearing (BRG) and distance (DIS) to the closest point along the flight plan to the selected reference waypoint and creates a user waypoint at this location. The name for the new user waypoint is derived from the identifier of the reference waypoint.

## 5.7 VERTICAL NAVIGATION



**NOTE:** The system supports vertical navigation for all lateral leg types except for CA, CI, FA, FM, HA, HM, PI, VA, VD, VI, VR, and VM. Vertical constraints are not retained in stored flight plans.

The Vertical Navigation (VNV) feature provides vertical profile guidance during the enroute and terminal phases of flight. Guidance based on specified altitudes at waypoints in the active flight plan or to a direct-to waypoint is provided. It includes vertical path guidance to a descending path, which is provided as a linear deviation from the desired path. The desired path is defined by a line joining two waypoints with specified altitudes or as a vertical angle from a specified waypoint/altitude. The vertical waypoints are integrated into the active flight plan. Both manual and autopilot-coupled guidance are supported with a Garmin autopilot.

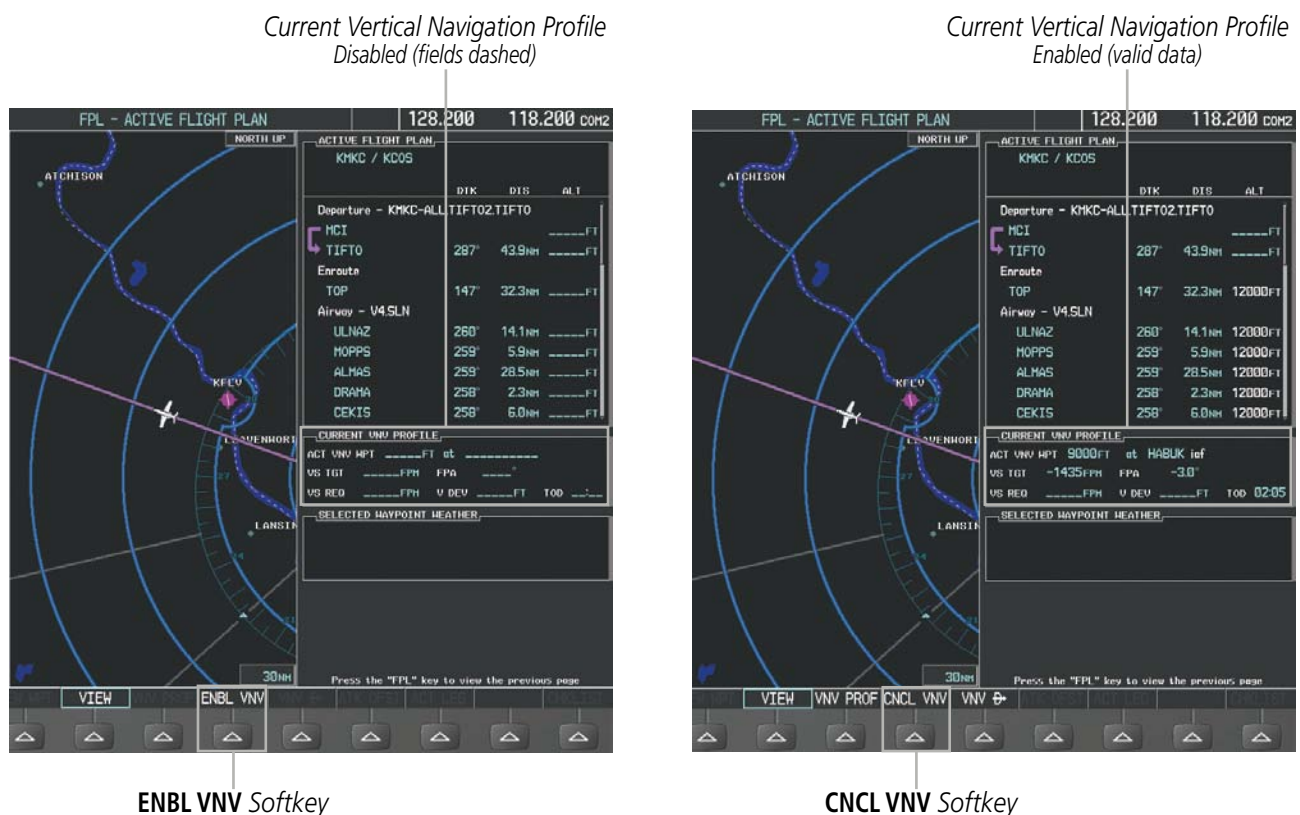

Figure 5-89 Enabling/Disabling Vertical Navigation

### Enabling VNV guidance:

- 1) Press the **FPL** Key to display the Active Flight Plan Page on the MFD.
- 2) Select the **ENBL VNV** Softkey; or press the **MENU** Key, highlight 'Enable VNV', and press the **ENT** Key. Vertical navigation is enabled, and vertical guidance begins with the waypoint shown in the CURRENT VNV PROFILE box (defaults first waypoint in the active flight plan with an altitude enabled for vertical navigation (e.g., HABUK)).

**Disabling VNV guidance:**

- 1) Press the **FPL** Key to display the Active Flight Plan Page on the MFD.
- 2) Select the **CNCL VNV** Softkey; or press the **MENU** Key, highlight 'Cancel VNV', and press the **ENT** Key. Vertical navigation is disabled.

Canceling vertical navigation results in vertical deviation (V DEV), vertical speed required (VS REQ), and time to top of descent/bottom of descent (TIME TO TOD/BOD) going invalid. The Vertical Deviation Indicator (VDI) and Required Vertical Speed Indicator (RVS) on the PFD are removed, and the V DEV, VS REQ, and TIME TO TOD items displayed in the CURRENT VNV PROFILE box are dashed. VNV remains disabled until manually enabled. Vertical guidance in reversionary mode can only be enabled for a direct-to waypoint.

The system allows a vertical navigation direct-to to any waypoint in the active flight plan with an altitude constraint “designated” for vertical guidance. Selecting the **VNV Direct-to** Softkey on the Active Flight Plan Page allows the flight plan to be flown, while vertical guidance based on the altitude constraint at the VNV direct-to waypoint is provided. The altitude change begins immediately and is spread along the flight plan from current position to the vertical direct-to waypoint, not just along the leg for the direct-to waypoint. A direct-to with altitude constraint activated by pressing the **Direct-to** Key also provides vertical guidance, but would bypass flight plan waypoints between the current position in the flight plan and the direct-to waypoint. A top of descent (TOD) point is computed based on the default flight path angle; descent begins once the TOD is reached.

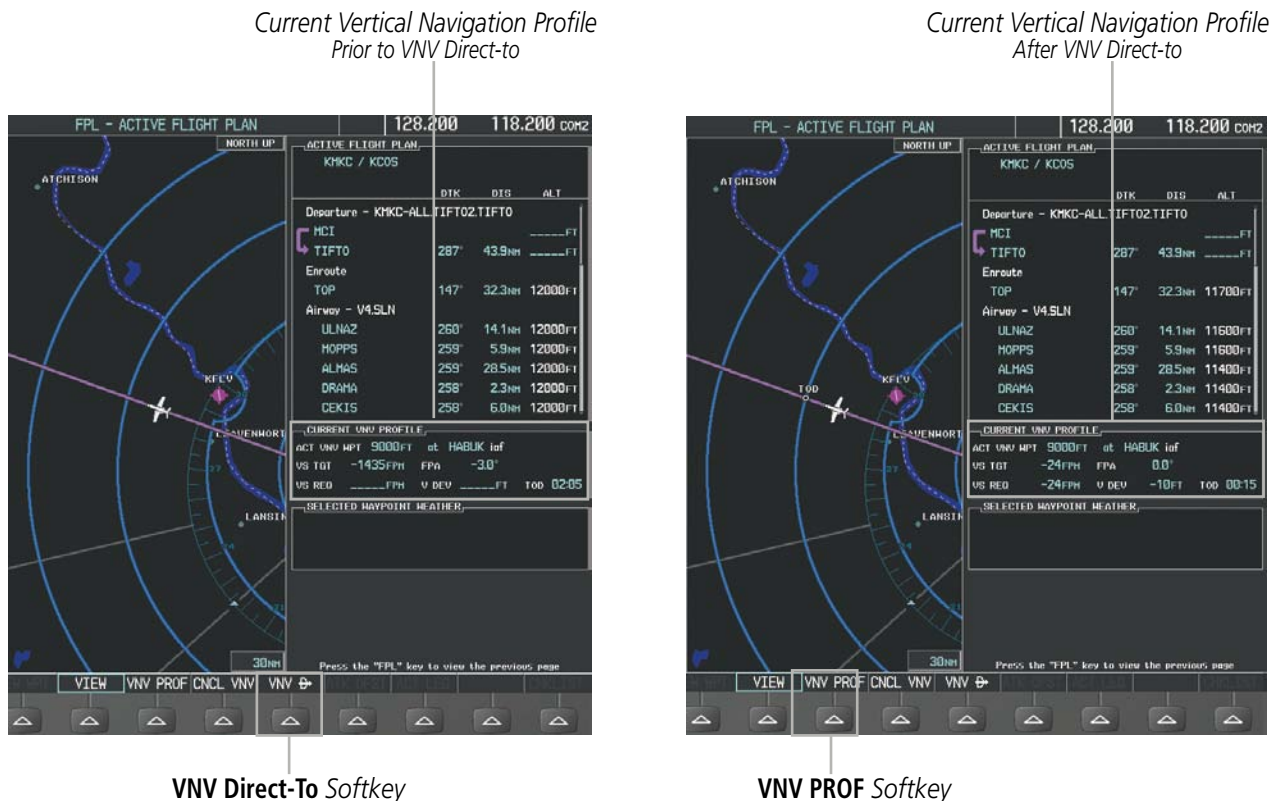

Figure 5-90 Vertical Navigation Direct-To

**Activating a vertical navigation direct-to:**

- 1) Press the **FPL** Key to display the Active Flight Plan Page on the MFD.
- 2) Press the **FMS** Knob to activate the cursor and turn the **FMS** Knob to highlight the desired waypoint.



**NOTE:** *The selected waypoint must have a designated altitude constraint (light blue number) to be used. If not, the first waypoint in the flight plan with a designated altitude constraint is selected.*

- 3) Select the **VNV Direct-To** Softkey; or press the **MENU** Key, highlight 'VNV Direct-To', and press the **ENT** Key. An 'Activate vertical Direct-to to: NNNNNFT at XXXXXX?' confirmation window is displayed.
- 4) Press the **ENT** Key. Vertical guidance begins to the altitude constraint for the selected waypoint.
- 5) Press the **FMS** Knob to remove the flashing cursor.

The vertical navigation profile can be modified by directly entering a vertical speed target (VS TGT) and/or flight path angle (FPA) in the CURRENT VNV PROFILE box.

**Modifying the VS TGT and FPA:**

- 1) Press the **FPL** Key to display the Active Flight Plan Page on the MFD.
- 2) Select the **VNV PROF** Softkey; or press the **MENU** Key, highlight 'Select VNV Profile Window', and press the **ENT** Key. The cursor is now located in the CURRENT VNV PROFILE box.
- 3) Turn the **FMS** Knobs as needed to edit the values.
- 4) Press the **FMS** Knob to remove the flashing cursor.

**ALTITUDE CONSTRAINTS**

The system can use altitude constraints associated with lateral waypoints to give guidance for vertical navigation. These altitudes are, depending on the specific instance, manually entered or retrieved from the published altitudes in the navigation database. The navigation database only contains altitudes for procedures that call for "Cross at" altitudes. If the procedure states "Expect to cross at," then the altitude is not in the database. In this case the altitude may be entered manually.

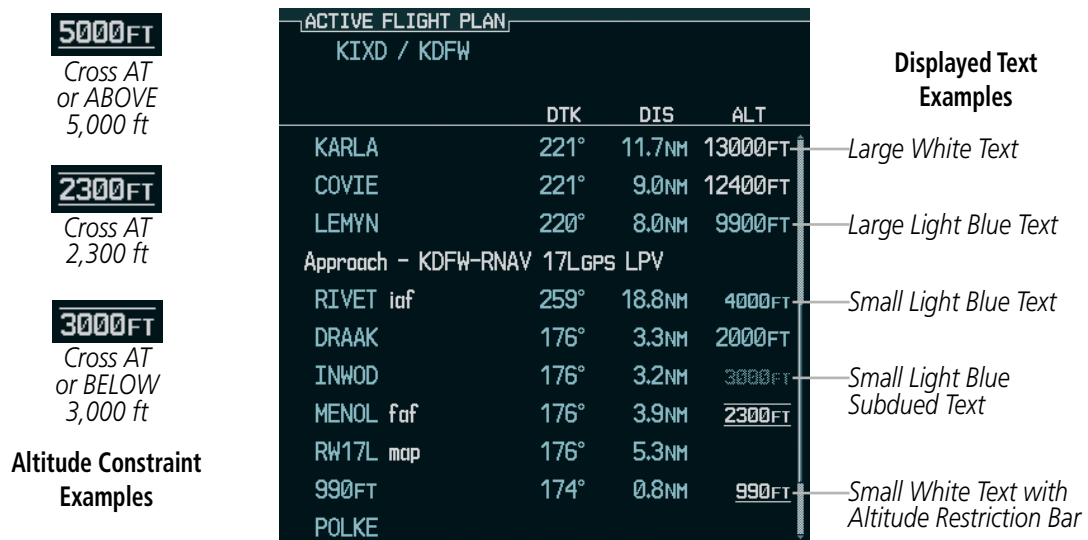

Figure 5-91 Waypoint Altitude Constraints

	White Text	Light Blue Text	Light Blue Subdued Text
Large Text	Altitude calculated by the system estimating the altitude of the aircraft as it passes over the navigation point. This altitude is provided as a reference and is not designated to be used in determining vertical speed and deviation guidance.	Altitude has been entered manually. Altitude is designated for use in giving vertical speed and deviation guidance. Altitude does not match the published altitude in navigation database or no published altitude exists.	The system cannot use this altitude in determining vertical speed and deviation guidance because of an invalid constraint condition.
Small Text	Altitude is not designated to be used in determining vertical speed and deviation guidance. Altitude has been retrieved from the navigation database and is provided as a reference.	Altitude is designated for use in giving vertical speed and deviation guidance. Altitude has been retrieved from the navigation database or has been entered manually and matches a published altitude in the navigation database.	The system cannot use this altitude in determining vertical speed and deviation guidance because of an invalid constraint condition.

**Table 5-8 Altitude Constraint Size and Color Coding**

Altitudes associated with arrival and approach procedures are “auto-designated”. This means the system automatically uses the altitudes loaded with the arrival or approach for giving vertical speed and deviation guidance. Note that these altitudes are displayed as blue text up to, but not including, the FAF. The FAF is always a “reference only” altitude and cannot be designated, unless the selected approach does not provide vertical guidance. In this case, the FAF altitude can be designated.

Altitudes that have been designated for use in vertical guidance can be “un-designated” using the **CLR** Key. The altitude is now displayed only as a reference. It is not used to give vertical guidance. Other displayed altitudes may change due to re-calculations or be rendered invalid as a result of manually changing an altitude to a non-designated altitude.

**Designating a waypoint altitude to be used for vertical guidance:**

- 1) Press the **FPL** Key to display the Active Flight Plan Page on the MFD.
- 2) Press the **FMS** Knob, and turn to highlight the desired waypoint altitude.
- 3) Turn the small **FMS** Knob to enter editing mode.
- 4) Press the **ENT** Key. The altitude is now shown in blue, indicating it is usable for vertical guidance.

**Designating a procedure waypoint altitude to be used for vertical guidance:**

- 1) Press the **FPL** Key to display the Active Flight Plan Page on the MFD.
- 2) Press the **FMS** Knob, and turn to highlight the desired waypoint altitude.
- 3) Press the **ENT** Key. The altitude is now shown in blue, indicating it is usable for vertical guidance.

Altitude constraints are displayed and entered in feet mean sea level (MSL) values to the nearest hundred. An altitude constraint in feet above ground level (AGL) format is supported for airports. When a database altitude restriction is displayed, the system allows entry of a different altitude when creating a waypoint, effectively overriding the database restriction (only before the FAF). When a database altitude restriction of type “AT or ABOVE” or “AT or BELOW” is activated, the system uses the “AT” portion of the restriction to define the vertical profile.



An altitude constraint is invalid if:

- Meeting the constraint requires the aircraft to climb
- Meeting the constraint requires the maximum flight path angle (6° down) or maximum vertical speed (-6000 fpm) to be exceeded
- The altitude constraint results in a TOD behind the aircraft present position
- The constraint is within a leg type for which altitude constraints are not supported
- The altitude constraint is added to the FAF of an approach that provides vertical guidance (i.e., ILS or GPS SBAS approach)
- The altitude constraint is added to a waypoint past the FAF

#### **Entering/modifying an altitude constraint:**

- 1) Press the **FPL** Key to display the Active Flight Plan Page on the MFD.
- 2) Press the **FMS** Knob, and turn to highlight the desired waypoint altitude constraint.
- 3) Enter an altitude constraint value using the **FMS** Knobs. To enter altitudes as a flight level, turn the small **FMS** Knob counter-clockwise past zero or clockwise past 9 on the first character, and the system automatically changes to show units of Flight Level. Turn the large **FMS** Knob clockwise to highlight the first zero and enter the three digit flight level.
- 4) Press the **ENT** Key to accept the altitude constraint; if the selected waypoint is an airport, an additional choice is displayed. Turn the small **FMS** Knob to choose 'MSL' or 'AGL', and press the **ENT** Key to accept the altitude.

Altitude constraints can be modified or deleted after having been added to the flight plan. In the event an altitude constraint is deleted and the navigation database contains an altitude restriction for the lateral waypoint, the system displays the altitude restriction from the database provided no predicted altitude can be provided. The system also provides a way to reinstate a published altitude constraint that has been edited.

#### **Deleting an altitude constraint provided by the navigation database:**

- 1) Press the **FPL** Key to display the Active Flight Plan Page on the MFD.
- 2) Press the **FMS** Knob, and turn to highlight the desired waypoint altitude constraint.
- 3) Press the **CLR** Key. A 'Remove VNV altitude constraint?' confirmation window is displayed.
- 4) Select 'OK' and press the **ENT** Key.

#### **Deleting an altitude constraint that has been manually entered:**

- 1) Press the **FPL** Key to display the Active Flight Plan Page on the MFD.
- 2) Press the **FMS** Knob, and turn to highlight the desired waypoint altitude constraint.
- 3) Press the **CLR** Key. A 'Remove or Revert to published VNV altitude of nnnnnFT?' confirmation window is displayed.
- 4) Select 'REMOVE' and press the **ENT** Key. The manually entered altitude is deleted (it is replaced by a system calculated altitude, if available).

**Reverting a manually entered altitude constraint back to the navigation database value:**

- 1) Press the **FPL** Key to display the Active Flight Plan Page on the MFD.
- 2) Press the **FMS** Knob, and turn to highlight the desired waypoint altitude constraint.
- 3) Press the **CLR** Key. A 'Remove or Revert to published VNV altitude of nnnnnFT?' confirmation window is displayed.
- 4) Select 'REVERT' and press the **ENT** Key. The altitude is changed to the navigation database value.
- 5) Press the **FMS** Knob to remove the flashing cursor.

**Modifying a system calculated altitude constraint:**

- 1) Press the **FPL** Key to display the Active Flight Plan Page on the MFD.
- 2) Press the **FMS** Knob, and turn to highlight the desired waypoint altitude constraint.
- 3) Press the **CLR** Key. An 'Edit or Revert to published VNV altitude of nnnnnFT?' confirmation window is displayed.
- 4) Select 'EDIT' and press the **ENT** Key.
- 5) Edit the value using the **FMS** Knobs, and press the **ENT** Key.
- 6) Press the **FMS** Knob to remove the flashing cursor.

## 5.8 PROCEDURES

The system can access the whole range of instrument procedures available. Departures (DPs), arrivals (STARs), and non-precision and precision approaches (APPRs) are stored within the database and can be loaded using the Procedures (**PROC**) Key.

The selected procedure for the departure or arrival airport is added to the active flight plan. No waypoints are required to be in the active flight plan to load procedures; however, if the departure and arrival airport are already loaded, the procedure loading window defaults to the appropriate airport, saving some time selecting the correct airport on the Procedure Loading Page. Whenever an approach is selected, the choice to either “load” or “activate” is given. “Loading” adds the approach to the end of the flight plan without immediately using it for navigation guidance. This allows continued navigation via the intermediate waypoints in the original flight plan, but keeps the procedure available on the Active Flight Plan Page for quick activation when needed. “Activating” also adds the procedure to the end of the flight plan but immediately begins to provide guidance to the first waypoint in the approach.

### DEPARTURES

---

A Departure Procedure (DP) is loaded at the departure airport in the flight plan. Only one departure can be loaded at a time in a flight plan. If a departure is loaded when another departure is already in the active flight plan, the new departure replaces the previous departure. The route is defined by selection of a departure, the transition waypoints, and a runway.

#### LOADING A DEPARTURE INTO THE ACTIVE FLIGHT PLAN

##### Loading a departure into the active flight plan using the **PROC** Key:

- 1) Press the **PROC** Key. The Procedures Window is displayed.
- 2) Highlight ‘SELECT DEPARTURE’.
- 3) Press the **ENT** Key. The Departure Loading Page is displayed.
- 4) Use the **FMS** Knob to select an airport and press the **ENT** Key.
- 5) Select a departure from the list and press the **ENT** Key.
- 6) Select a runway (if required) and press the **ENT** Key.
- 7) Select a transition (if required) and press the **ENT** Key. ‘LOAD?’ is highlighted.
- 8) Press the **ENT** Key to load the departure procedure.



Available Procedure Actions

Departure Airport

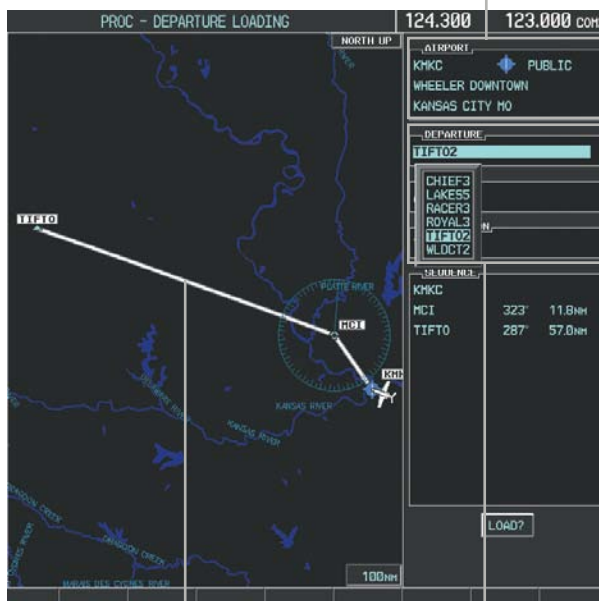
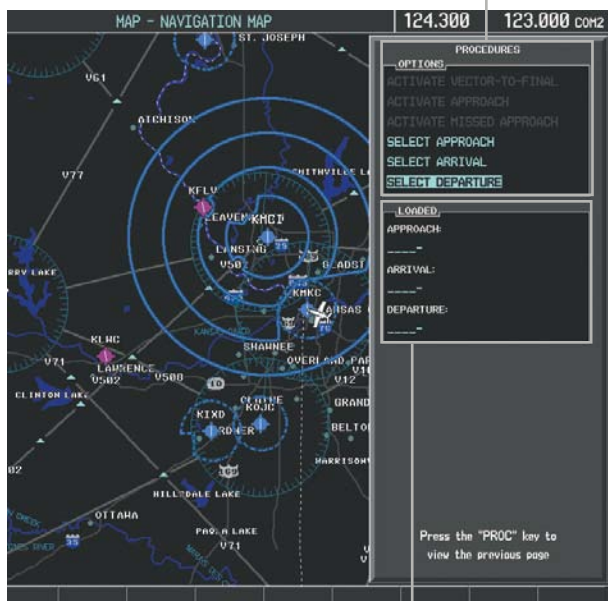

Loaded Procedures

Departure Preview

Departure Choices

Figure 5-92 Departure Selection

Selected Departure

Loaded Departure

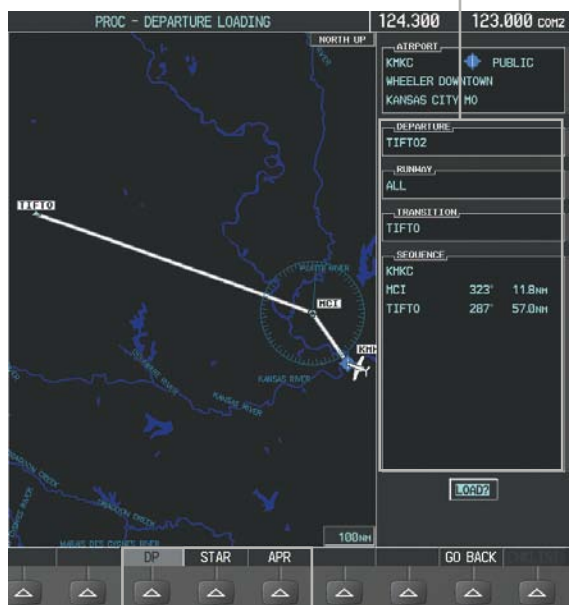

Procedure Loading Page Selection Softkeys

Figure 5-93 Departure Loading

**Viewing available departures at an airport:**

- 1) From the Airport Information Page (first page in the WPT group), select the **DP** Softkey. The Departure Information Page is displayed, defaulting to the airport displayed on the Airport information Page.
- 2) To select another airport, press the **FMS** Knob to activate the cursor, enter an identifier/facility name/city, and press the **ENT** Key.
- 3) Turn the large **FMS** Knob to highlight the Departure. The departure is previewed on the map.
- 4) Turn the small **FMS** Knob to view the available departures. Press the **ENT** Key to select the departure. The cursor moves to the Runway box. The departure is previewed on the map.
- 5) Turn the small **FMS** Knob to view the available runways. Press the **ENT** Key to select the runway. The cursor moves to the Transition box (only if there are available transitions). The departure is previewed on the map.
- 6) Turn the small **FMS** Knob to view the available transitions. Press the **ENT** Key to select the transition. The cursor moves to the Sequence box. The departure is previewed on the map.
- 7) Select the **INFO-x** Softkey to return to the Airport Information Page.

**REMOVING A DEPARTURE FROM THE ACTIVE FLIGHT PLAN**

When plans change while flying IFR, departures can be easily removed from the Active Flight Plan.

**Removing a departure procedure from the active flight plan:**

- 1) Press the **FPL** Key to display the Active Flight Plan Page (MFD) or the Active Flight Plan Window (PFD).
- 2) Press the **MENU** Key, and highlight 'Remove Departure'.
- 3) Press the **ENT** Key. A confirmation window is displayed listing the departure procedure.
- 4) With 'OK' highlighted, press the **ENT** Key. To cancel the removal request, highlight 'CANCEL' and press the **ENT** Key.

**Or:**

- 1) Press the **FPL** Key to display the Active Flight Plan Page (MFD) or the Active Flight Plan Window (PFD).
- 2) Press the **FMS** Knob, and turn to highlight the departure header in the active flight plan.
- 3) Press the **CLR** Key. A confirmation window is displayed listing the departure procedure.
- 4) With 'OK' highlighted, press the **ENT** Key. To cancel the removal request, highlight 'CANCEL' and press the **ENT** Key.
- 5) Press the **FMS** Knob to remove the flashing cursor.

## ARRIVALS

A Standard Terminal Arrival (STAR) can be loaded at any airport that has one available. Only one arrival can be loaded at a time in a flight plan. If an arrival is loaded when another arrival is already in the active flight plan, the new arrival replaces the previous arrival. The route is defined by selection of an arrival, the transition waypoints, and a runway.

### LOADING AN ARRIVAL INTO THE ACTIVE FLIGHT PLAN

#### Loading an arrival into the active flight plan using the PROC Key:

- 1) Press the **PROC** Key. The Procedures Window is displayed.
- 2) Highlight 'SELECT ARRIVAL'.
- 3) Press the **ENT** Key. The Arrival Loading Page is displayed.
- 4) Use the **FMS** Knob to select an airport and press the **ENT** Key.
- 5) Select an arrival from the list and press the **ENT** Key.
- 6) Select a transition (if required) and press the **ENT** Key.
- 7) Select a runway (if required) and press the **ENT** Key. 'LOAD?' is highlighted.
- 8) Press the **ENT** Key to load the arrival procedure.

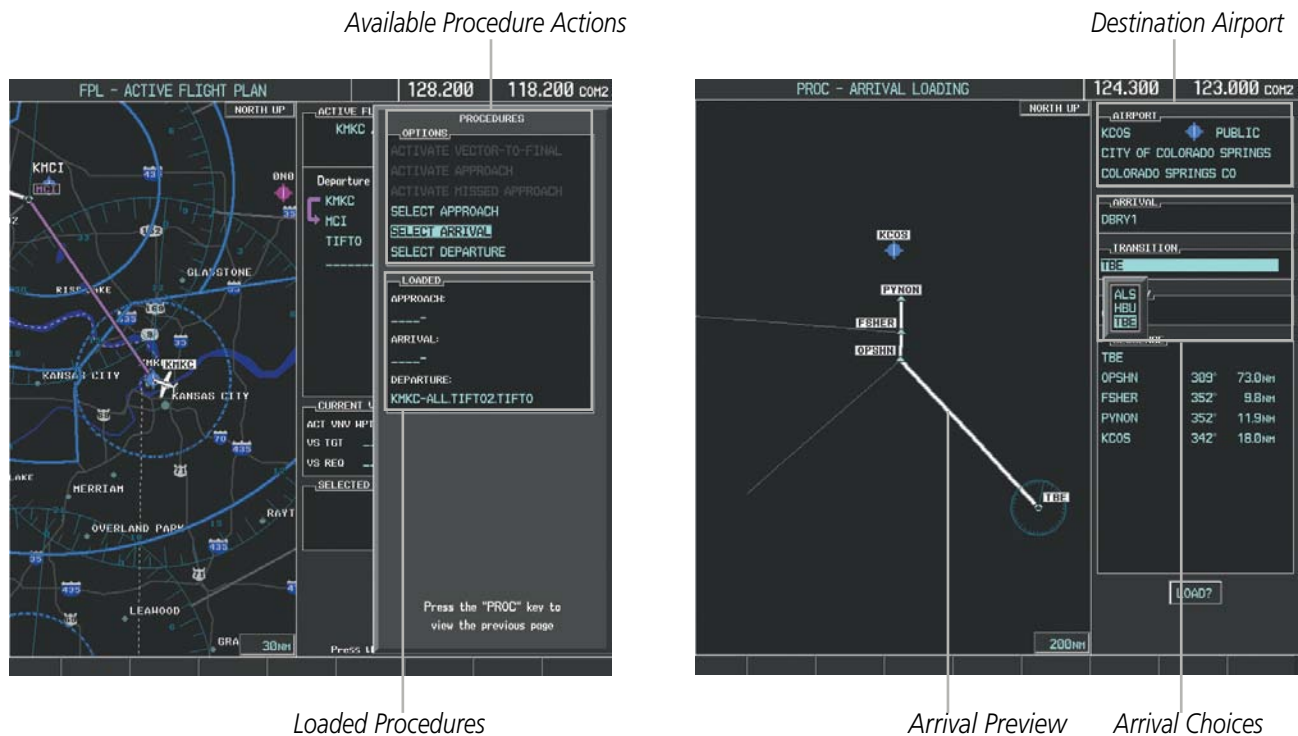

Figure 5-94 Arrival Selection



Procedure Loading Page Selection Softkeys

Figure 5-95 Arrival Loading

**Viewing available arrivals at an airport:**

- 1) From the Airport Information Page (first page in the WPT group), select the **STAR** Softkey. The Arrival Information Page is displayed, defaulting to the airport displayed on the Airport Information Page.
- 2) To select another airport, press the **FMS** Knob to activate the cursor, enter an identifier/facility name/city, and press the **ENT** Key.
- 3) Turn the large **FMS** Knob to highlight the Arrival. The arrival is previewed on the map.
- 4) Turn the small **FMS** Knob to view the available arrivals. Press the **ENT** Key to select the arrival. The cursor moves to the Transition box. The arrival is previewed on the map.
- 5) Turn the small **FMS** Knob to view the available transitions. Press the **ENT** Key to select the transition. The cursor moves to the Runway box. The arrival is previewed on the map.
- 6) Turn the small **FMS** Knob to view the available runways. Press the **ENT** Key to select the runway. The cursor moves to the Sequence box. The arrival is previewed on the map.
- 7) Select the **INFO-x** Softkey to return to the Airport Information Page.

## REMOVING AN ARRIVAL FROM THE ACTIVE FLIGHT PLAN

When plans change while flying IFR, arrivals can be easily removed from the Active Flight Plan.

### Removing an arrival from the active flight plan:

- 1) Press the **FPL** Key to display the Active Flight Plan Page (MFD) or the Active Flight Plan Window (PFD).
- 2) Press the **MENU** Key, and highlight 'Remove Arrival'.
- 3) Press the **ENT** Key. A confirmation window is displayed listing the arrival procedure.
- 4) With 'OK' highlighted, press the **ENT** Key. To cancel the removal request, highlight 'CANCEL' and press the **ENT** Key.

Or:

- 1) Press the **FPL** Key to display the Active Flight Plan Page (MFD) or the Active Flight Plan Window (PFD).
- 2) Press the **FMS** Knob, and turn to highlight the arrival header in the active flight plan.
- 3) Press the **CLR** Key. A confirmation window is displayed listing the arrival procedure.
- 4) With 'OK' highlighted, press the **ENT** Key. To cancel the removal request, highlight 'CANCEL' and press the **ENT** Key.
- 5) Press the **FMS** Knob to remove the flashing cursor.

## APPROACHES



**NOTE:** *If certain GPS parameters (SBAS, RAIM, etc.) are not available, some published approach procedures for the desired airport may not be displayed in the list of available approaches.*

An Approach Procedure (APPR) can be loaded at any airport that has one available, and provides guidance for non-precision and precision approaches to airports with published instrument approach procedures. Only one approach can be loaded at a time in a flight plan. If an approach is loaded when another approach is already in the active flight plan, the new approach replaces the previous approach. The route is defined by selection of an approach and the transition waypoints.

Whenever an approach is selected, the choice to either "load" or "activate" is given. "Loading" adds the approach to the end of the flight plan without immediately using it for navigation guidance. This allows continued navigation via the intermediate waypoints in the original flight plan, but keeps the procedure available on the Active Flight Plan Page for quick activation when needed. "Activating" also adds the procedure to the end of the flight plan but immediately begins to provide guidance to the first waypoint in the approach.

When selecting an approach, a "GPS" designation to the right of the procedure name indicates the procedure can be flown using the GPS receiver. Some procedures do not have this designation, meaning the GPS receiver can be used for supplemental navigation guidance only. If the GPS receiver cannot be used for primary guidance, the appropriate navigation receiver must be used for the selected approach (e.g., VOR or ILS). The final course segment of ILS approaches, for example, must be flown by tuning the NAV receiver to the proper frequency and selecting that NAV receiver on the CDI.



The SBAS GPS allows for flying LNAV, LNAV/VNAV, and LPV approaches according to the published chart. LNAV+V is a standard LNAV approach with advisory vertical guidance provided for assistance in maintaining a constant vertical glidepath similar to an ILS glideslope on approach. This guidance is displayed on the PFD in the same location as the ILS glideslope using a magenta diamond. In all cases where LNAV+V is indicated by the system during an approach, LNAV minima are used. The active approach type is annunciated on the HSI as shown in the following table:

HSI Annunciation	Description	Example on HSI
LNAV	GPS approach using published LNAV minima	 <p>Approach Type</p> <ul style="list-style-type: none"> <li>- LNAV</li> <li>- LNAV+V</li> <li>- L/VNAV</li> <li>- LPV</li> </ul>
LNAV+V	GPS approach using published LNAV minima. Advisory vertical guidance is provided	
L/VNAV	GPS approach using published LNAV/VNAV minima	
LPV	GPS approach using published LPV minima	

Table 5-9 Approach Types

## LOADING AN APPROACH INTO THE ACTIVE FLIGHT PLAN

### Loading an approach into the active flight plan using the PROC Key:

- 1) Press the **PROC** Key. The Procedures Window is displayed.
- 2) Highlight 'SELECT APPROACH', and press the **ENT** Key. The Approach Loading Page is displayed.
- 3) Use the **FMS** Knob to select an airport and press the **ENT** Key.
- 4) Select an approach from the list and press the **ENT** Key.
- 5) Select a transition (if required) and press the **ENT** Key.
- 6) Minimums
  - a) To set 'MINIMUMS', turn the small **FMS** Knob to select 'BARO' or 'RAD ALT' (optional), and press the **ENT** Key. Turn the small **FMS** Knob to select the altitude, and press the **ENT** Key.

**Or:**

  - b) To skip setting minimums, press the **ENT** Key.
- 7) Press the **ENT** Key with 'LOAD?' highlighted to load the approach procedure; or turn the large **FMS** Knob to highlight 'ACTIVATE' and press the **ENT** Key to load and activate the approach procedure.



**NOTE:** When GPS is not approved for the selected final approach course, the message 'NOT APPROVED FOR GPS' is displayed. GPS provides guidance to the approach, but the HSI must be switched to a NAV receiver to fly the final course of the approach.

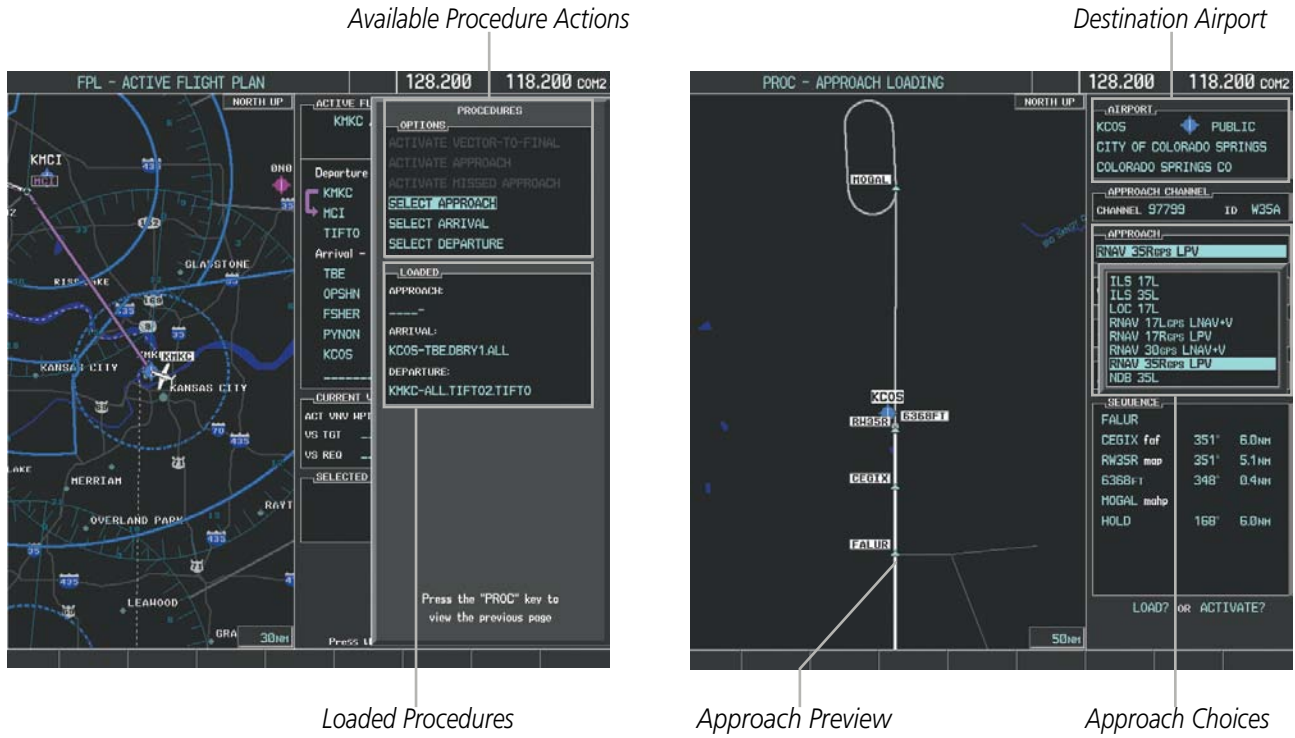

Figure 5-96 Approach Selection

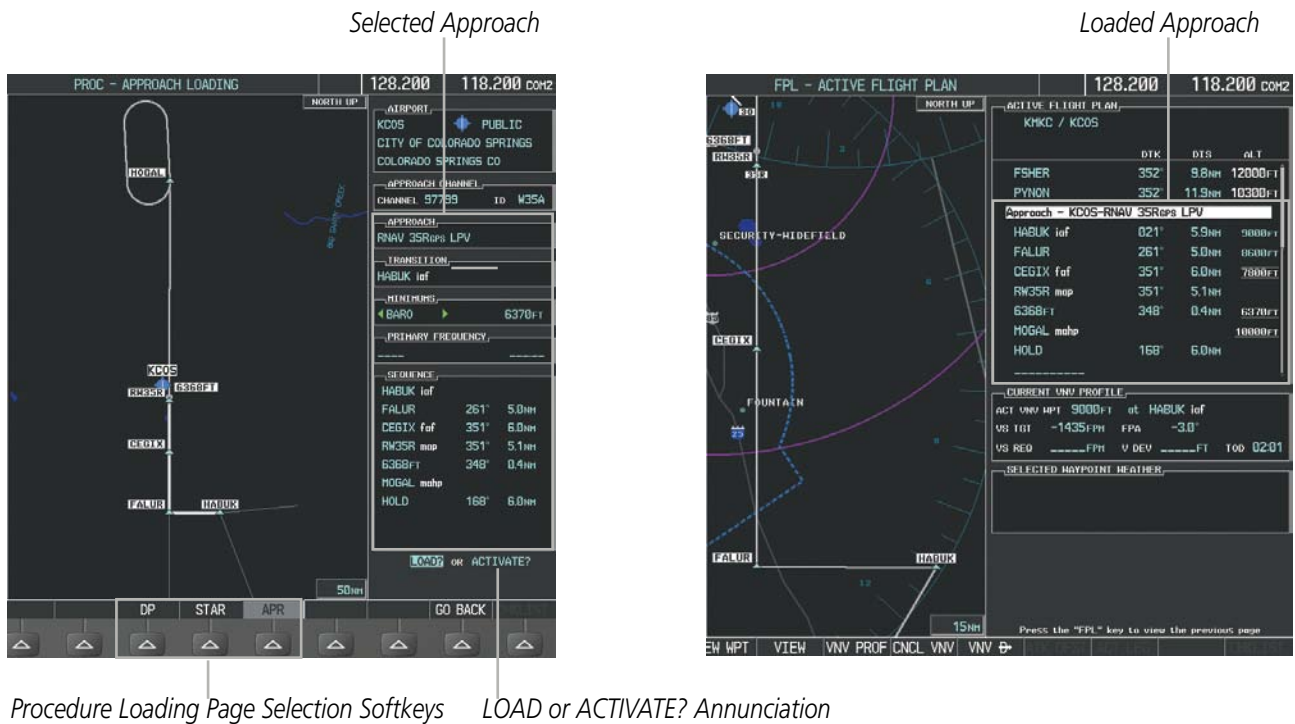

Figure 5-97 Approach Loading



**Viewing available approaches at an airport:**

- 1) From the Airport Information Page (first page in the WPT group), select the **APR** Softkey. The Approach Information Page is displayed, defaulting to the airport displayed on the Airport information Page.
- 2) To select another airport, press the **FMS** Knob to activate the cursor, enter an identifier/facility name/city, and press the **ENT** Key.
- 3) Press the **FMS** Knob, then turn the large **FMS** Knob to highlight the Approach. The approach is previewed on the map.
- 4) Turn the small **FMS** Knob to view the available approaches. Press the **ENT** Key to select the approach. The cursor moves to the Transition box. The approach is previewed on the map.
- 5) Turn the small **FMS** Knob to view the available transitions. Press the **ENT** Key to select the transition. The cursor moves to the Minimums box. The approach is previewed on the map.
- 6) Turn the small **FMS** Knob to select BARO (or optional RAD ALT) minimums on or off. Press the **ENT** Key.
  - a) When minimums are selected on, the cursor moves to the minimum altitude field. Use the small FMS Knob to select the altitude. Press the **ENT** Key. The cursor moves to the Sequence box. The approach is previewed on the map.
- Or:**
  - b) When minimums are selected off, the cursor moves to the Sequence box. The approach is previewed on the map.
- 7) Select the **INFO-x** Softkey to return to the Airport Information Page.

**Loading an approach into the active flight plan from the Nearest Airport Page:**

- 1) Select the Nearest Airports Page.
- 2) Press the **FMS** Knob, then turn the large **FMS** Knob to highlight the desired nearest airport. The airport is previewed on the map.
- 3) Select the **APR** Softkey; or press the **MENU** Key, highlight 'Select Approach Window', and press the **ENT** Key.
- 4) Turn the **FMS** Knob to highlight the desired approach.
- 5) Select the **LD APR** Softkey; or press the **MENU** Key, highlight 'Load Approach', and press the **ENT** Key. The Approach Loading Page is displayed with the transitions field highlighted.
- 6) Turn the **FMS** Knob to highlight the desired transition, and press the **ENT** Key.
- 7) Minimums
  - a) To set 'MINIMUMS', turn the small **FMS** Knob to select 'BARO' or 'RAD ALT' (optional), and press the **ENT** Key. Turn the small **FMS** Knob to select the altitude, and press the **ENT** Key. The 'LOAD?' field is highlighted.
- Or:**
  - b) To skip setting minimums, press the **ENT** Key. The 'LOAD?' field is highlighted.
- 8) Press the **ENT** Key with 'LOAD?' highlighted to load the approach procedure; or turn the large **FMS** Knob to highlight 'ACTIVATE' and press the **ENT** Key to load and activate the approach procedure. The system continues navigating the current flight plan until the approach is activated. When GPS is not approved for the selected final approach course, the message 'NOT APPROVED FOR GPS' is displayed. GPS provides guidance to the approach, but the HSI must be switched to a NAV receiver to fly the final course of the approach.

## ACTIVATING AN APPROACH

A previously loaded approach can be activated from the Procedures Window.

### Activating a previously loaded approach:

- 1) Press the **PROC** Key. The Procedures Window is displayed with 'Activate Approach' highlighted.
- 2) Press the **ENT** Key to activate the approach.

In many cases, it may be easiest to “load” the full approach while still some distance away, enroute to the destination airport. Later, if vectored to final, use the steps above to select 'Activate Vector-To-Final' — which makes the inbound course to the FAF waypoint active.

### Activating a previously loaded approach with vectors to final:

- 1) Press the **PROC** Key to display the Procedures Window.
- 2) Highlight 'ACTIVATE VECTOR-TO-FINAL' and press the **ENT** Key.

### Loading and activating an approach using the MENU Key:

- 1) From the Approach Loading Page, press the **MENU** Key. The page menu is displayed with 'Load & Activate Approach' highlighted.
- 2) Press the **ENT** Key. When GPS is not approved for the selected final approach course, the message 'NOT APPROVED FOR GPS' is displayed. GPS provides guidance to the approach, but the HSI must be switched to a NAV receiver to fly the final course of the approach.

## REMOVING AN APPROACH FROM THE ACTIVE FLIGHT PLAN

When plans change while flying IFR, approaches can be easily removed from the Active Flight Plan.

### Removing an approach from the active flight plan:

- 1) Press the **FPL** Key to display the Active Flight Plan Page (MFD) or the Active Flight Plan Window (PFD).
- 2) Press the **MENU** Key, and highlight 'Remove Approach'.
- 3) Press the **ENT** Key. A confirmation window is displayed listing the approach procedure.
- 4) With 'OK' highlighted, press the **ENT** Key. To cancel the removal, highlight 'CANCEL' and press the **ENT** Key.

Or:

- 1) Press the **FPL** Key to display the Active Flight Plan Page (MFD) or the Active Flight Plan Window (PFD).
- 2) Press the **FMS** Knob, and turn to highlight the approach header in the active flight plan.
- 3) Press the **CLR** Key. A confirmation window is displayed listing the approach procedure.
- 4) With 'OK' highlighted, press the **ENT** Key. To cancel the removal, highlight 'CANCEL' and press the **ENT** Key.
- 5) Press the **FMS** Knob to remove the flashing cursor.

## MISSED APPROACH

### Activating a missed approach in the active flight plan:

- 1) Press the **PROC** Key.
- 2) Turn the **FMS** Knob to highlight 'ACTIVATE MISSED APPROACH'.
- 3) Press the **ENT** Key. The aircraft automatically sequences to the MAHP.

Or:

Press the Go-Around Button.

## COURSE TO ALTITUDE

In this missed approach procedure, the altitude immediately following the MAP (in this case '6368ft') is not part of the published procedure. It is simply a Course to Altitude (CA) leg which guides the aircraft along the runway centerline until the altitude required to safely make the first turn toward the MAHP is exceeded. This altitude is provided by Jeppesen, and may be below, equal to, or above the published minimums for this approach. In this case, if the aircraft altitude is below the specified altitude (6,368 feet) after crossing the MAP, a direct-to is established to provide a course on runway heading until an altitude of 6,368 feet is reached. After reaching 6,368 feet, a direct-to is established to the published MAHP (in this case MOGAL). If the aircraft altitude is above the specified altitude after crossing the MAP, a direct-to is established to the published fix (MOGAL) to begin the missed approach procedure.

In some missed approach procedures this Course to Altitude leg may be part of the published procedure. For example, a procedure may dictate a climb to 5,500 feet, then turn left and proceed to the Missed Approach Hold Point (MAHP). In this case, the altitude would appear in the list of waypoints as '5500ft'. Again, if the aircraft altitude is lower than the prescribed altitude, a direct-to is established on a Course to Altitude leg when the missed approach procedure is activated.

ACTIVE FLIGHT PLAN			
KMKC / KCOS			
	DTK	DIS	ALT
FSHER	352°	9.8NM	9500FT
PYNON	352°	11.9NM	9500FT
Approach - KCOS-RNAV 35R <sub>GPS</sub> LPV			
HABUK <i>iaf</i>	021°	5.9NM	9000FT
FALUR	261°	5.0NM	8600FT
CEGIX <i>faf</i>	351°	6.0NM	7800FT
RW35R <i>map</i>	351°	5.1NM	
6368FT	348°	0.4NM	6370FT
MOGAL <i>mahp</i>			10000FT
HOLD	168°	6.0NM	

Figure 5-98 Course to Altitude

## 5.9 TRIP PLANNING

The system allows the pilot to view trip planning information, fuel information, and other information for a specified flight plan or flight plan leg based on automatic data, or based on manually entered data. Weight planning is also available, based on fuel sensor data and the active flight plan (to estimate remaining fuel).

### TRIP PLANNING

All of the input of data needed for calculation and viewing of the statistics is done on the Trip Planning Page located in the AUX Page Group.

*Selected Flight Plan Segment*  
 - FPL Number/Cumulative Legs (CUM or REM) or Leg Number (NN)  
 - Waypoints Defining Selected Flight Plan/Flight Plan Leg

**AUX - TRIP PLANNING** | 124.300 | 123.000 COM2

INPUT DATA | PAGE MODE - AUTOMATIC

**Preview of Selected Flight Plan/ Flight Plan Leg**

**Trip Input Data (sensor/pilot)**

- Departure Time (local)
- Ground Speed
- Fuel Flow
- Fuel On Board Aircraft
- Calibrated Airspeed
- Indicated Altitude
- Barometric Pressure
- Total Air Temperature

**Trip Statistics**

- Desired Track
- Distance
- Est. Time Enroute
- Est. Time of Arrival
- Enroute Safe Altitude
- Sunrise Time (local)
- Sunset Time (local)

**Fuel Statistics**

- Efficiency
- Total Endurance
- Remaining Fuel
- Remaining Endurance
- Fuel Required
- Total Range

**Other Statistics**

- Density Altitude
- True Airspeed (TAS)

**Softkeys**

- Automatic/Manual Page Mode
- Flight Plan/Waypoint Mode

TRIP STATS	FUEL STATS	OTHER STATS
DTK _____°	EFFICIENCY 1.7	DENSITY ALT _____FT
DIS 754NM	TOTAL ENDUR 04:02	TRUE AIRSPEED 239KT
ETE 03:56	REM FUEL 11KG	
ETA 02:20LCL	REM ENDUR 00:05	
ESA 16500FT	FUEL REQ 433.9KG	
SUNRISE 13:38LCL	TOTAL RANGE 773NM	
SUNSET 23:47LCL		

Figure 5-99 Trip Planning Page

The trip planning inputs are based on sensor inputs (automatic page mode) or on pilot inputs (manual page mode). Some additional explanation of the sources for some of the inputs is as follows:

- Departure time (DEP TIME) - This defaults to the current time in automatic page mode. The computations are from the aircraft present position, so the aircraft is always just departing.
- Calibrated airspeed (CALIBRATED AS) - The primary source is from the air data system, and the secondary source of information is GPS ground speed.
- Indicated altitude (IND ALTITUDE) - The primary source is the barometric altitude, and the secondary source of information is GPS altitude.

## TRIP STATISTICS

The trip statistics are calculated based on the selected starting and ending waypoints and the trip planning inputs.

In flight plan mode (FPL) with a stored flight plan selected (NN), and the entire flight plan (CUM) selected, the waypoints are the starting and ending waypoints of the selected flight plan.

In flight plan mode (FPL) with a stored flight plan selected (NN), and a specific leg (NN) selected, the waypoints are the endpoints of the selected leg.

In flight plan mode (FPL) with the active flight plan selected (00), and the remaining flight plan (REM) selected, the 'from' waypoint is the present position of the aircraft and the 'to' waypoint is the endpoint of the active flight plan.

In flight plan mode (FPL) with the active flight plan selected (00), and a specific leg (NN) selected, the 'from' waypoint is the current aircraft position and the 'to' waypoint is the endpoint of the selected leg.

In waypoint (WPTS) mode these are manually selected waypoints (if there is an active flight plan, these default to the endpoints of the active leg).

Some of the calculated trip statistics are dashed when the selected leg of the active flight plan has already been flown.

- Desired Track (DTK) - DTK is shown as nnn° and is the desired track between the selected waypoints. It is dashed unless only a single leg is selected.
- Distance (DIS) - The distance is shown in tenths of units up to 99.9, and in whole units up to 9999.
- Estimated time enroute (ETE) - ETE is shown as hours:minutes until less than an hour, then it is shown as minutes:seconds.
- Estimated time of arrival (ETA) - ETA is shown as hours:minutes and is the local time at the destination.
  - If in waypoint mode then the ETA is the ETE added to the departure time.
  - If a flight plan other than the active flight plan is selected it shows the ETA by adding to the departure time all of the ETEs of the legs up to the selected leg. If the entire flight plan is selected, then the ETA is calculated as if the last leg of the flight plan was selected.
  - If the active flight plan is selected the ETA reflects the current position of the aircraft and the current leg being flown. The ETA is calculated by adding to the current time the ETEs of the current leg up to and including the selected leg. If the entire flight plan is selected, then the ETA is calculated as if the last leg of the flight plan was selected.
- Enroute safe altitude (ESA) - The ESA is shown as nnnnnFT
- Destination sunrise and sunset times (SUNRISE, SUNSET) - These times are shown as hours:minutes and are the local time at the destination.

## FUEL STATISTICS

The fuel statistics are calculated based on the selected starting and ending waypoints and the trip planning inputs. Some of the calculated trip statistics are dashed when the selected leg of the active flight plan has already been flown.

- Fuel efficiency (EFFICIENCY) - This value is calculated by dividing the current ground speed by the current fuel flow.
- Time of fuel endurance (TOTAL ENDUR) - This time is shown as hours:minutes. This value is obtained by dividing the amount of fuel on board by the current fuel flow.
- Fuel on board upon reaching end of selected leg (REM FUEL) - This value is calculated by taking the amount of fuel onboard and subtracting the fuel required to reach the end of the selected leg.
- Fuel endurance remaining at end of selected leg (REM ENDUR) - This value is calculated by taking the time of fuel endurance and subtracting the estimated time enroute to the end of the selected leg.
- Fuel required for trip (FUEL REQ) - This value is calculated by multiplying the time to go by the fuel flow.
- Total range at entered fuel flow (TOTAL RANGE) - This value is calculated by multiplying the time of fuel endurance by the ground speed.

## OTHER STATISTICS

These statistics are calculated based on the system sensor inputs or the manual trip planning inputs.

- Density altitude (DENSITY ALT)
- True airspeed (TRUE AIRSPEED)

The pilot may select automatic (AUTO) or manual (MANUAL) page mode, and flight plan (FPL) or waypoint (WPTS) mode. In automatic page mode, only the FPL, LEG, or waypoint IDs are editable (based on FPL/WPTS selection).

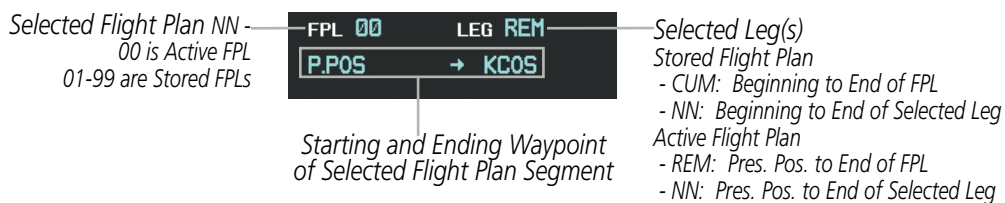

Figure 5-100 Trip Planning Page - Flight Plan Mode



Figure 5-101 Trip Planning Page - Waypoint Mode

**Selecting automatic or manual page mode:**

Select the **AUTO** Softkey or the **MANUAL** Softkey; or press the **MENU** Key, highlight 'Auto Mode' or 'Manual Mode', and press the **ENT** Key.

**Selecting flight plan or waypoint mode:**

Select the **FPL** Softkey or the **WPTS** Softkey; or press the **MENU** Key, highlight 'Flight Plan Mode' or 'Waypoints Mode', and press the **ENT** Key.

**Selecting a flight plan and leg for trip statistics:**

- 1) Press the **FMS** Knob to activate the cursor in the flight plan number field.
- 2) Turn the small **FMS** Knob to select the desired flight plan number.
- 3) Turn the large **FMS** Knob to highlight 'CUM' or 'REM'. The statistics for each leg can be viewed by turning the small **FMS** Knob to select the desired leg. The Inset Map also displays the selected data.

**Selecting waypoints for waypoint mode:**

- 1) Select the **WPTS** Softkey; or press the **MENU** Key, highlight 'Waypoints Mode', and press the **ENT** Key. The cursor is positioned in the waypoint field directly below the FPL field.
- 2) Turn the **FMS** knobs to select the desired waypoint (or select from the Page Menu 'Set WPT to Present Position' if that is what is desired), and press the **ENT** Key. The cursor moves to the second waypoint field.
- 3) Turn the **FMS** knobs to select the desired waypoint, and press the **ENT** Key. The statistics for the selected leg are displayed.

In manual page mode, the other eight trip input data fields must be entered by the pilot, in addition to flight plan and leg selection.

**Entering manual data for trip statistics calculations:**

- 1) Select the **MANUAL** Softkey or select 'Manual Mode' from the Page Menu, and press the **ENT** Key. The cursor may now be positioned in any field in the top right two boxes.
- 2) Turn the **FMS** Knobs to move the cursor onto the DEP TIME field and enter the desired value. Press the **ENT** Key. The statistics are calculated using the new value and the cursor moves to the next entry field. Repeat until all desired values have been entered.



WEIGHT PLANNING

**NOTE:** All weight planning page data fields displays data rounded to the nearest 10 pounds or 5 kilograms.

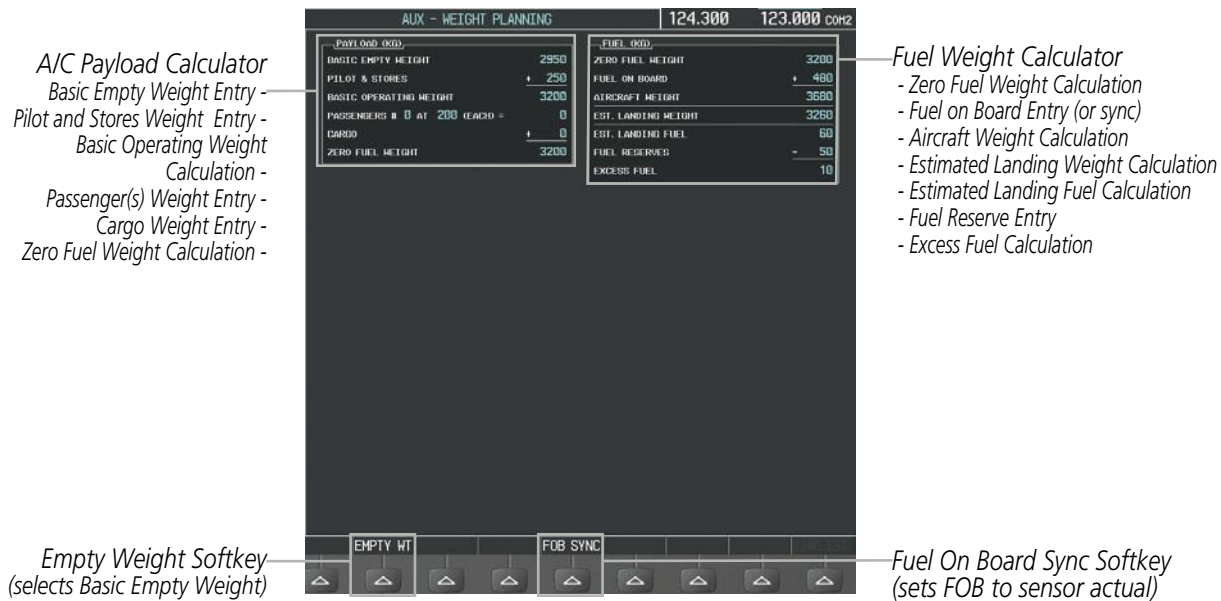

Figure 5-102 Weight Planning Page

**Entering basic empty weight:**

- 1) Select the **EMPTY WT** Softkey; or press the **MENU** Key, highlight 'Set Basic Empty Weight', and press the **ENT** Key to select the 'BASIC EMPTY WEIGHT' field.
- 2) Turn the small **FMS** Knob to enter the basic empty weight.
- 3) Press the **ENT** Key to confirm the entry.
- 4) Press the **FMS** Knob to remove the flashing cursor.

**Entering a pilot and stores weight:**

- 1) Press the **FMS** Knob to activate the cursor and highlight the 'PILOT AND STORES' field.
- 2) Turn the small **FMS** Knob to enter the pilot and stores weight.
- 3) Press the **ENT** Key to confirm the entry.
- 4) Press the **FMS** Knob to remove the flashing cursor.

The basic operating weight is calculated by adding the basic empty weight and the pilot and stores weight.

**Entering the number of passengers:**

- 1) Press the **FMS** Knob to activate the cursor and highlight the 'PASSENGERS #' field.

- 2) Turn the small **FMS** Knob to enter the number of passengers.
- 3) Press the **ENT** Key to confirm the entry.
- 4) Press the **FMS** Knob to remove the flashing cursor.

#### **Entering the average passenger weight:**

- 1) Press the **FMS** Knob to activate the cursor and highlight the passenger weight field.
- 2) Turn the small **FMS** Knob to enter the average passenger weight.
- 3) Press the **ENT** Key to confirm the entry.
- 4) Press the **FMS** Knob to remove the flashing cursor

The total weight of passengers is calculated by multiplying the number of passengers by the average passenger weight.

#### **Entering the cargo weight:**

- 1) Press the **FMS** Knob to activate the cursor and highlight the 'CARGO' field.
- 2) Turn the small **FMS** Knob to enter the cargo weight.
- 3) Press the **ENT** Key to confirm the entry.
- 4) Press the **FMS** Knob to remove the flashing cursor

The 'ZERO FUEL WEIGHT' is calculated by adding the basic empty, pilot and stores, passenger, and cargo weights.

#### **Entering a fuel on board weight:**

- 1) Press the **FMS** Knob to activate the cursor and highlight the 'FUEL ON BOARD' field.
- 2) Turn the small **FMS** Knob to enter the fuel on board.
- 3) Press the **ENT** Key to confirm the entry.
- 4) Press the **FMS** Knob to remove the flashing cursor

#### **Entering fuel reserve:**

- 1) Press the **FMS** Knob to activate the cursor and highlight the 'FUEL RESERVES' field.
- 2) Turn the small **FMS** Knob to enter the fuel reserves amount.
- 3) Press the **ENT** Key to confirm the entry.
- 4) Press the **FMS** Knob to remove the flashing cursor

#### **Synchronizing the fuel on board with the actual measured fuel on board:**

Select the **FOB SYNC** Softkey; or select the **MENU** Key, highlight 'Synchronize Fuel on Board', and press the **ENT** Key. The actual measured fuel on board is displayed in the 'FUEL ON BOARD' field.

When the aircraft is in the air and a destination waypoint has been entered, the fuel calculations can be completed.

- Estimated landing weight = zero fuel weight + estimated landing fuel weight.
- Estimated landing fuel weight = fuel on board weight - (fuel flow x ETE)
- Excess fuel weight = estimated landing fuel weight - fuel reserves weight

If the aircraft is on the ground or a destination waypoint has not been entered, the following fields display invalid values consisting of six dashes:

- Estimated landing weight
- Estimated landing fuel weight
- Excess fuel weight

## **WEIGHT CAUTION AND WARNING CONDITIONS**

---

If the zero fuel weight is greater than the maximum allowable zero fuel weight, then the zero fuel weight is displayed in amber.

If the aircraft weight is greater than the maximum allowable takeoff weight, then the aircraft weight is displayed in amber.

If the estimated landing weight is greater than the maximum allowable landing weight, then the estimated landing weight is displayed in amber.

If the estimated landing fuel weight is positive, but less than or equal to the fuel reserves weight, the following values are displayed in amber:

- Estimated fuel at landing weight
- Excess fuel weight

If the estimated landing fuel weight is zero or negative, then the following values are displayed in red:

- Estimated fuel at landing weight
- Excess fuel weight

## 5.10 RAIM PREDICTION

RAIM (Receiver Autonomous Integrity Monitoring) is a GPS receiver function that performs a consistency check on all tracked satellites. RAIM ensures that the available satellite geometry allows the receiver to calculate a position within a specified RAIM protection limit (2.0 nm for oceanic, 2.0 nm for enroute, 1.0 nm for terminal, and 0.3 nm for non-precision approaches). During oceanic, enroute, and terminal phases of flight, RAIM is available nearly 100% of the time. The RAIM prediction function also indicates whether RAIM is available at a specified date and time. RAIM computations predict satellite coverage within ±15 min of the specified arrival date and time. Because of the tighter protection limit on approaches, there may be times when RAIM is not available. RAIM prediction must be initiated manually if there is concern over SBAS coverage at the destination or some other reason that compromises navigation precision. If RAIM is not predicted to be available for the final approach course, the approach does not become active. If RAIM is not available when crossing the FAF, the missed approach procedure must be flown.

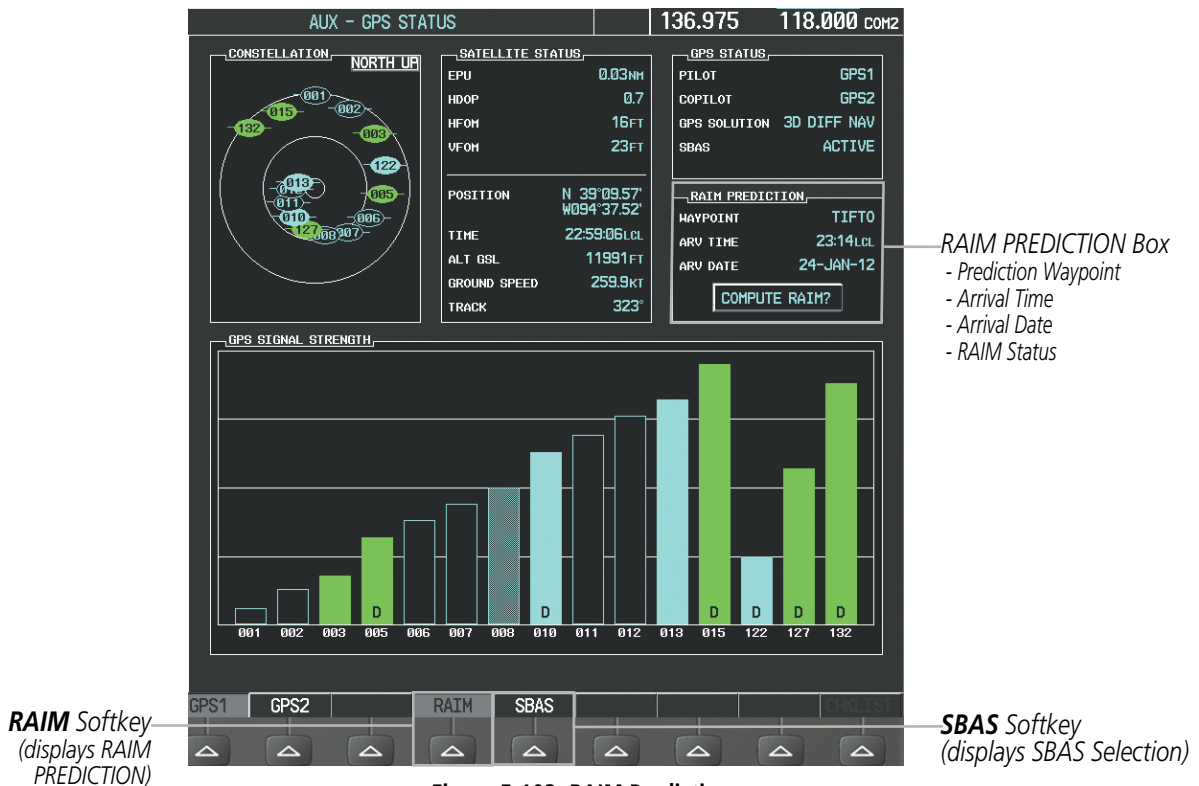

Figure 5-103 RAIM Prediction

### Predicting RAIM availability at a selected waypoint:

- 1) Select the AUX-GPS Status Page.
- 2) Press the **FMS** Knob. The RAIM Prediction 'WAYPOINT' field is highlighted.
- 3) Turn the small **FMS** Knob to display the Waypoint Information Window. (Turning it clockwise displays a blank Waypoint Information Window, turning it counter-clockwise displays the Waypoint Information Window with a waypoint selection submenu allowing selection of active flight plan, nearest, recent, user, or airway waypoints).

- 4) Enter the identifier, facility, or city name of the departure waypoint; or select a waypoint from the submenu of waypoints and press the **ENT** Key to accept the waypoint entry.
- 5) Turn the FMS Knobs to enter an arrival time and press the **ENT** Key.
- 6) Turn the FMS Knobs to enter an arrival date and press the **ENT** Key.
- 7) Press the **ENT** Key with 'COMPUTE RAIM?' highlighted to begin the computation.

**Predicting RAIM availability at the aircraft present position:**

- 1) Select the AUX-GPS Status Page.
- 2) Press the **FMS** Knob. The RAIM Prediction 'WAYPOINT' field is highlighted.
- 3) Press the **MENU** Key, highlight 'Set WPT to Present Position', and press the **ENT** Key.
- 4) Press the **ENT** Key to accept the waypoint entry.
- 5) Turn the FMS Knobs to enter an arrival time and press the **ENT** Key.
- 6) Turn the FMS Knobs to enter an arrival date and press the **ENT** Key.
- 7) Press the **ENT** Key with 'COMPUTE RAIM?' highlighted to begin the computation.

Status of the RAIM computation for the selected waypoint, time, and date is displayed at the bottom of the RAIM PREDICTION Box as follows:

- 'COMPUTE RAIM?' - RAIM has not been computed.
- 'COMPUTING AVAILABILITY' - RAIM calculation is in progress.
- 'RAIM AVAILABLE' - RAIM is predicted to be available.
- 'RAIM NOT AVAILABLE' - RAIM is predicted to be unavailable.

The Satellite Based Augmentation System (SBAS) provides increased navigation accuracy when available. SBAS can be enabled or disabled manually on the GPS Status Page.

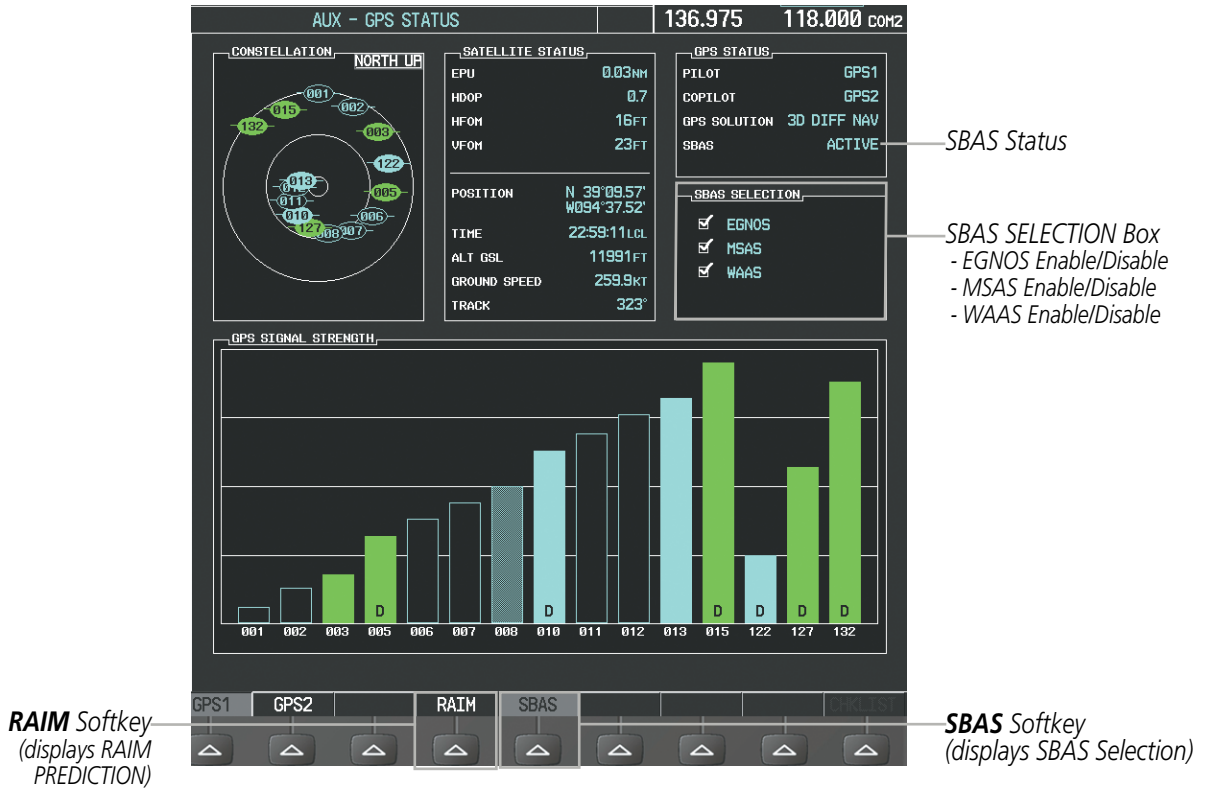

Figure 5-104 SBAS Display - Active

**Enabling/Disabling SBAS:**

- 1) Select the AUX-GPS Status Page.
- 2) Select the **SBAS** Softkey.
- 3) Press the **FMS** Knob, and turn the large FMS Knob to highlight 'EGNOS', 'MSAS' or 'WAAS'.
- 4) Press the **ENT** Key to disable SBAS. Press the **ENT** Key again to enable SBAS.

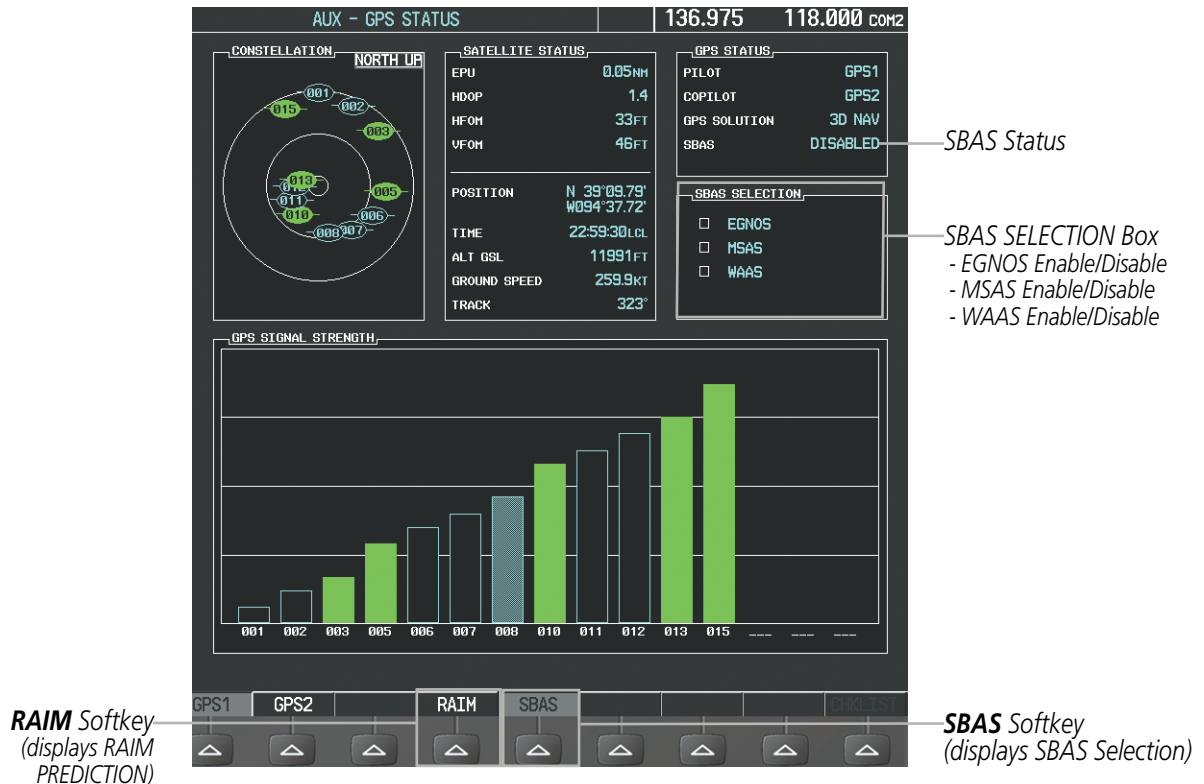

Figure 5-105 SBAS Display - Disabled



### 5.11 NAVIGATING A FLIGHT PLAN

The following discussion is an example of navigating a flight plan with the SBAS capable GPS system while the system provides vertical guidance through descents. A lateral flight plan (LNAV) would be navigated in much the same way, but would not include vertical guidance when the final approach course is active.

**NOTE:** The following example flight plan is for instructional purposes only. All database information depicted should be considered not current.

The example is a flight plan from KMKC to KCOS filed using the TIFTO2 departure, various Victor Airways, and the DBRY1 arrival with the transition at TBE. The flight plan includes an enroute altitude of 12,000 feet, an LPV (WAAS) approach selected for runway 35R, and a missed approach executed at the Missed Approach Point (MAP). A few enroute changes are demonstrated.

- 1) Prior to departure, the TIFTO2 departure, the airways, and the DBRY1 arrival at KCOS are loaded. See the Procedures section for loading departures and arrivals. Note the magenta arrow in Figure 5-106 indicating the active departure leg.
- After takeoff, ATC assigns a heading of 240°.
- 2) Figure 5-106 shows the aircraft on the assigned heading of 240°. 'TERM' (Terminal) is the current CDI flight phase displayed on the HSI indicating 1.0 nm CDI scaling.

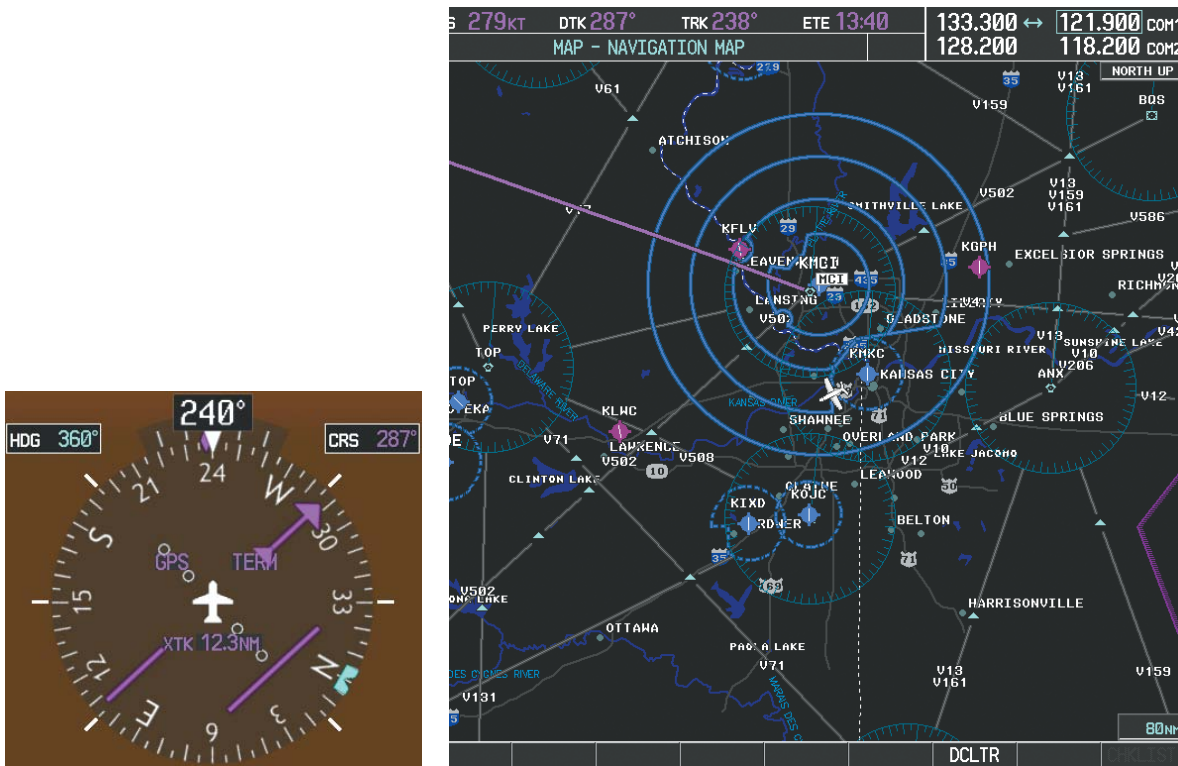

Figure 5-106 Assigned Heading of 240°

- 3) ATC now assigns routing to join V4. A heading of 290° is assigned to intercept V4. The aircraft turns to heading 290° as seen in Figure 5-107.

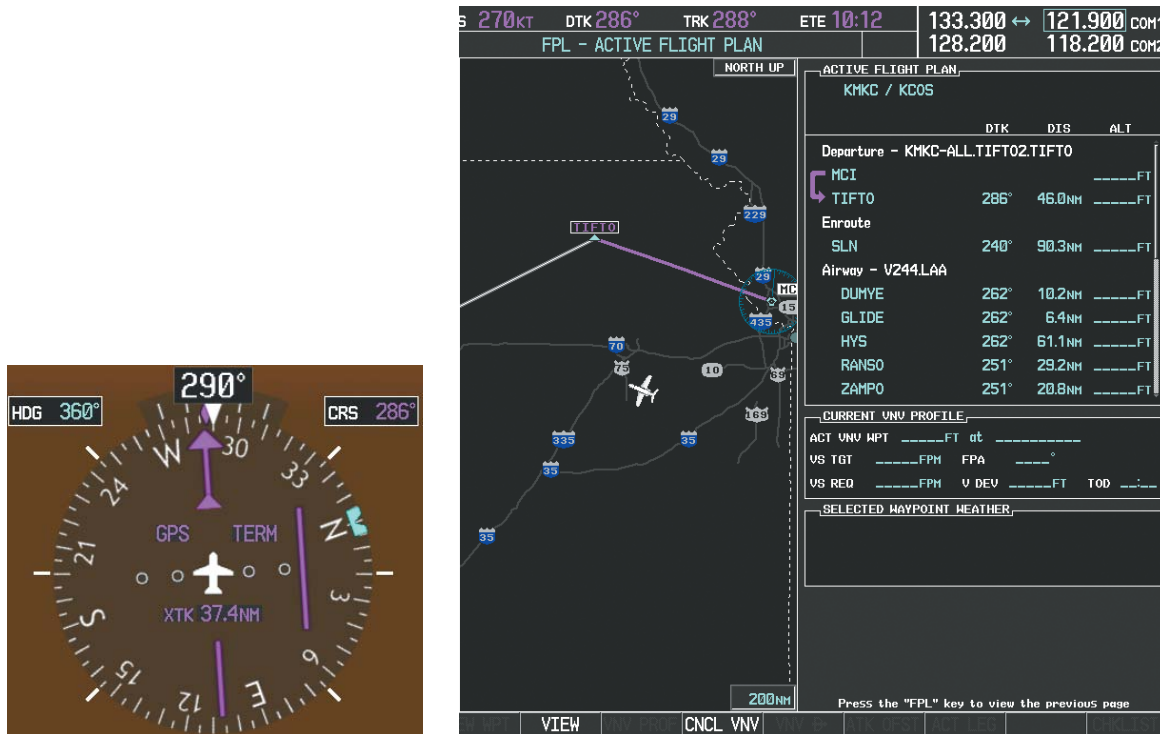

Figure 5-107 Assigned Heading of 290°

- 4) Enter V4 into the flight plan.
  - a) Press the **FMS** Knob to activate the cursor.

- b) The desired entry point for V4 (TOP) must be entered. Turn the large **FMS** Knob to highlight the desired flight plan insertion point (SLN) as shown in Figure 5-108. When the V4 entry point (TOP) is inserted, it is placed immediately above the highlighted waypoint (SLN).

ACTIVE FLIGHT PLAN			
KMKC / KCOS			
	DTK	DIS	ALT
Departure - KMKC-ALL.TIFT02.TIFT0			
MCI			-----FT
TIFT0	288°	46.0NM	-----FT
Enroute			
SLN	240°	90.3NM	-----FT
Airway - V244.LAA			
DUMYE	262°	10.2NM	-----FT
GLIDE	262°	6.4NM	-----FT
HYS	262°	61.1NM	-----FT
RANSO	251°	29.2NM	-----FT
ZAMPO	251°	20.8NM	-----FT
CURRENT UNV PROFILE			
ACT UNV HPT	-----FT	at	-----
VS TGT	-----FPM	FPA	-----°
VS REQ	-----FPM	V DEV	-----FT TOD

Figure 5-108 Begin Adding V4 to the Flight Plan

- c) Turn the small **FMS** Knob to display the Waypoint Information Window. Enter the desired entry point for V4, Topeka VOR (TOP), as shown in Figure 5-109.



Figure 5-109 Entering V4 Entry Point

d) Press the **ENT** Key. TOP is inserted into the flight plan as in Figure 5-110.

ACTIVE FLIGHT PLAN			
KHKC / KCOS			
	DTK	DIS	ALT
Departure - KHKC-ALL.TIFT02.TIFT0			
MCI			-----FT
TIFT0	286°	46.0NM	-----FT
Enroute			
TOP	147°	32.3NM	-----FT
SLN	260°	97.7NM	-----FT
Airway - V244.LAA			
DUMYE	262°	10.2NM	-----FT
GLIDE	262°	6.4NM	-----FT
HYS	262°	61.1NM	-----FT
RANSO	251°	29.2NM	-----FT

CURRENT UNV PROFILE			
ACT UNV HPT	-----FT	at	-----
VS TGT	-----FPM	FPA	-----°
VS REQ	-----FPM	V DEV	-----FT TOD

Figure 5-110 TOP Inserted into the Flight Plan

- e) With SLN still highlighted as in Figure 5-110, turn the small **FMS** Knob clockwise. The Waypoint Information Page is displayed and the **LD AIRWY** Softkey is now available.
- f) Select the **LD AIRWY** Softkey to display the list of available airways for TOP as seen in Figure 5-111.

ENTRY	
TOP	
AIRWAY	
V4	
V131	
V280	
V4	
V508	
V71	
V77	
	260° 14.1NM
MOPPS	259° 5.9NM
ALMAS	259° 28.5NM
DRAMA	258° 2.3NM
CEKIS	258° 6.0NM
VASCO	258° 27.4NM
SLN	257° 13.6NM

LOAD?

Figure 5-111 List of Available Airways for TOP

g) Turn either **FMS** Knob to highlight V4 in the list as seen in Figure 5-111.

h) Press the **ENT** Key. The list of available exits for V4 is now displayed as in Figure 5-112.

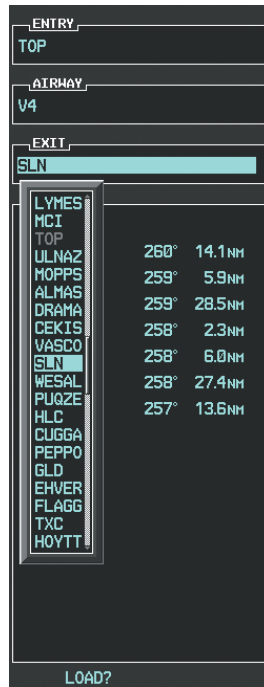

Figure 5-112 List of Available Exits for V4

- i) If necessary, turn either **FMS** Knob to select the desired exit. In this case Salina VOR (SLN) is selected as in Figure 5-112.
- j) Press the **ENT** Key. The selected airway and exit are displayed, and the prompt “LOAD?” highlighted as in Figure 5-113.

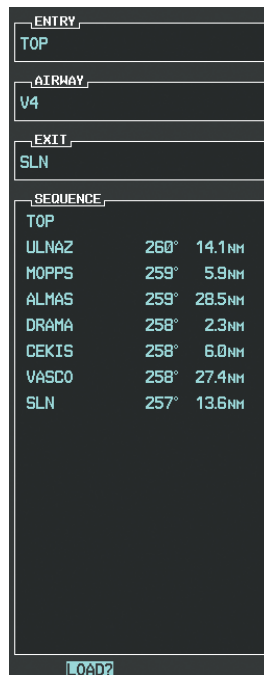

Figure 5-113 Ready to Load V4

- k) Press the **ENT** Key.
- l) V4 is now loaded into the flight plan as shown in Figure 5-114.

ACTIVE FLIGHT PLAN			
KHKC / KCOS			
	DTK	DIS	ALT
Departure - KHKC-ALL.TIFT02.TIFT0			
MCI			-----FT
TIFT0	286°	46.0NM	-----FT
Enroute			
TOP	147°	32.3NM	-----FT
Airway - V4.SLN			
ULNAZ	260°	14.1NM	-----FT
HOPPS	259°	5.9NM	-----FT
ALMAS	259°	28.5NM	-----FT
DRAMA	258°	2.3NM	-----FT
CEKIS	258°	6.0NM	-----FT

CURRENT UNV PROFILE			
ACT UNV WPT	-----FT	at	-----
VS TGT	-----FPM	FPA	-----°
VS REQ	-----FPM	V DEV	-----FT TOD -----

Figure 5-114 V4 is Loaded in the Flight Plan

- 5) Making V4 the active leg of the flight plan.
  - a) Press the **FMS** Knob to activate the cursor.
  - b) Turn the large **FMS** Knob to highlight ULNAZ. The TO waypoint of the leg is selected in order to activate the leg.
  - c) Select the **ACT LEG** Softkey. The confirmation window is now displayed as in Figure 5-115. Note the TOP to ULNAZ leg is actually part of V4.

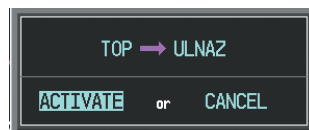

Figure 5-115 Confirm Active Leg

d) Verify the displayed leg is the desired leg and press the **ENT** Key. Note in Figure 5-116, the magenta arrow in the flight plan window and magenta line on the map indicating V4 is now the active flight plan leg. Note the phase of flight remained in Terminal (TERM) mode up to this point because a departure leg was active. Since a leg after the departure is now active, the current CDI flight phase is ENR (Enroute) and CDI scaling has changed to 2.0 nm.

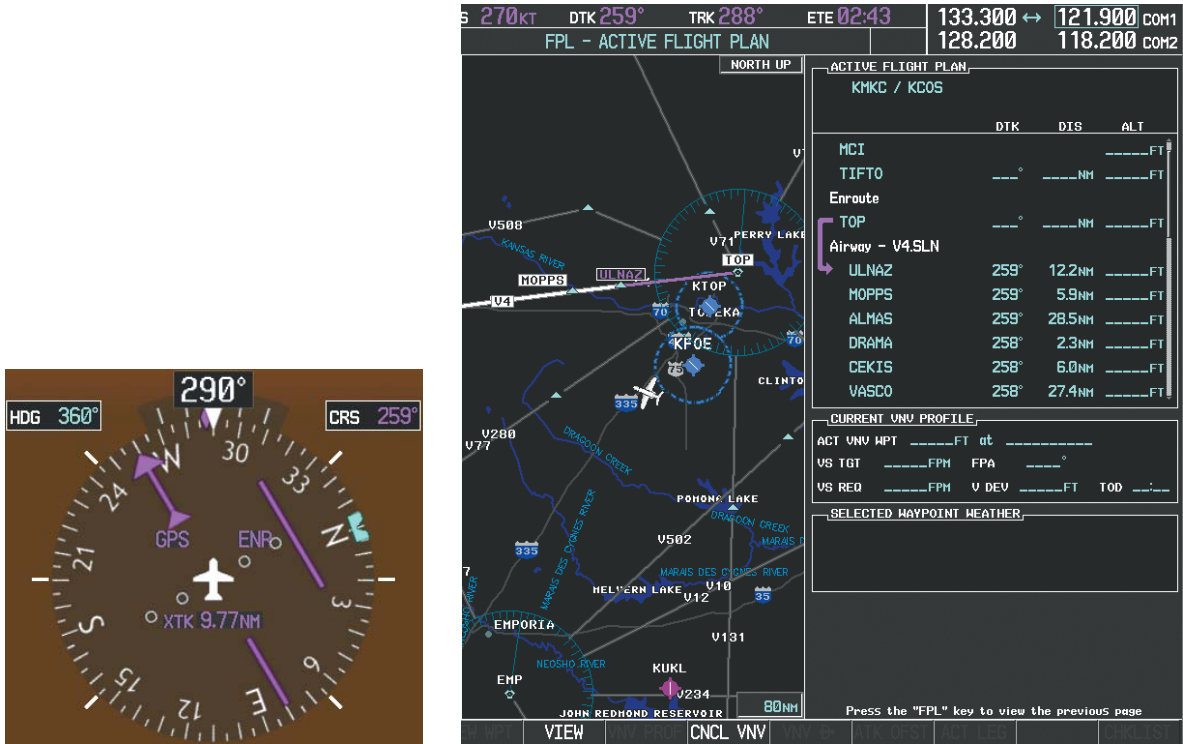

Figure 5-116 V4 Now Active Leg

6) The aircraft continues on heading 290°. When crosstrack distance is less than 2.0 nm, the XTK disappears from the HSI and the CDI is positioned on the last dot indicating a 2.0 nm distance from the centerline of the next course.



7) As the CDI approaches center, the aircraft turns onto the active leg as seen in Figure 5-117.

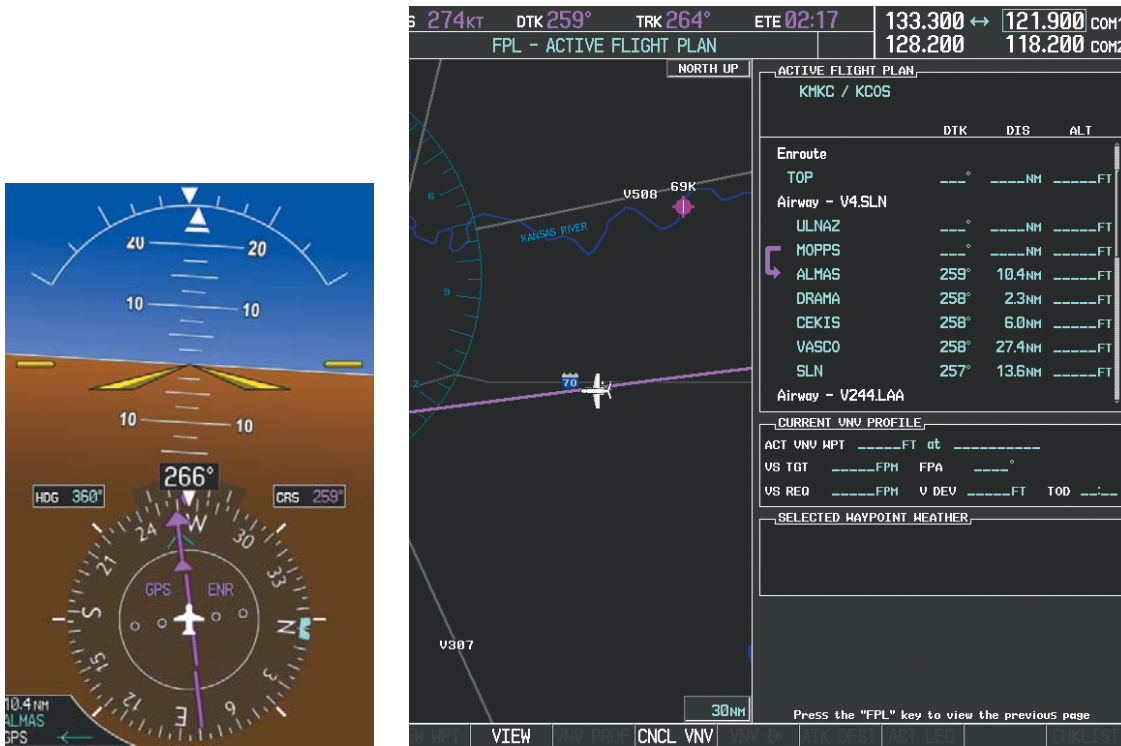

Figure 5-117 Turn on to Active Leg

8) At SLN, Victor Airway 244 (V244) is intercepted. Turn prompts are displayed in the PFD Navigation Status Box as seen in Figure 5-118.

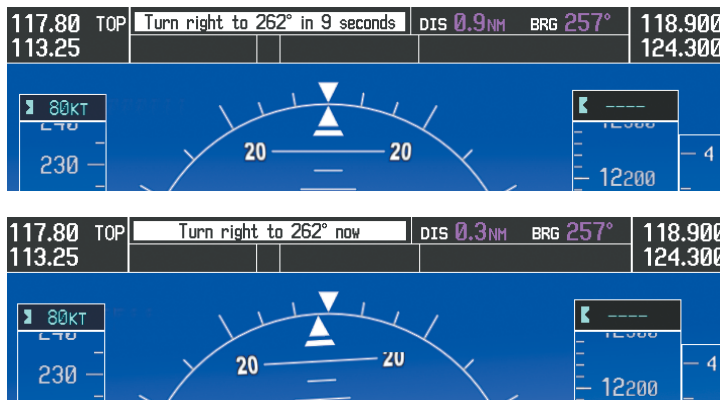

Figure 5-118 Turn to Intercept V244

9) As seen in Figure 5-119, V244 is now the active flight plan leg.

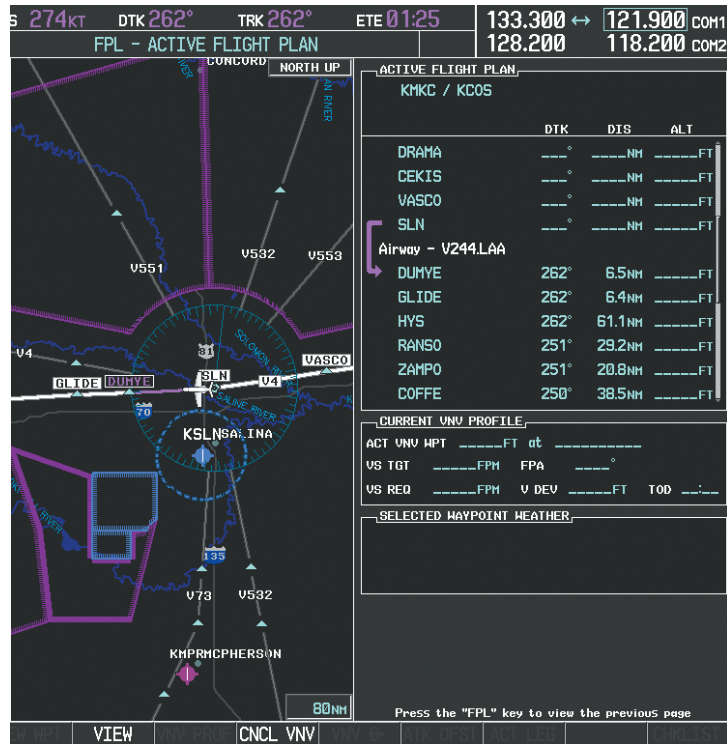

Figure 5-119 V244 Now Active Leg

10) At Lamar VOR (LAA) V263 is intercepted. See Figure 5-120.

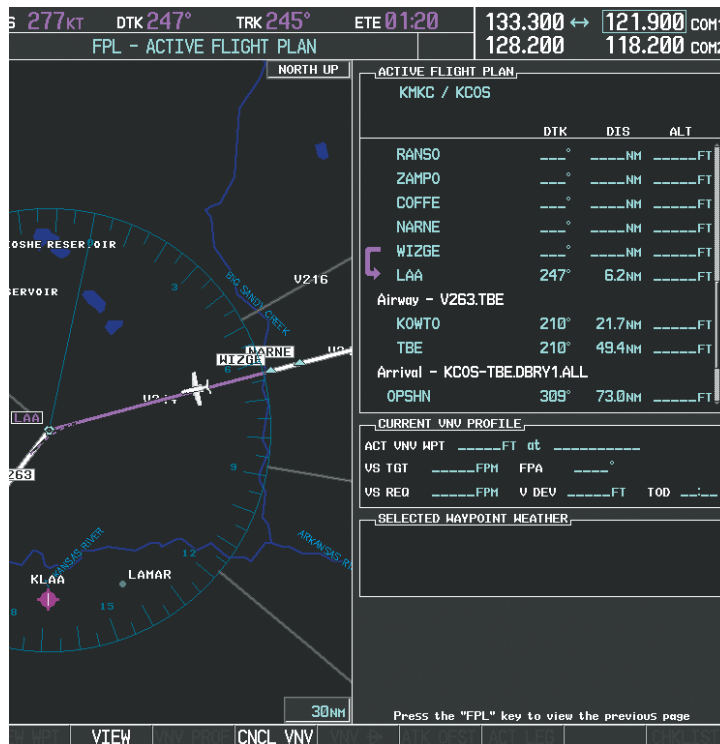

Figure 5-120 WIZGE to LAA Leg Active

11) ATC grants clearance to proceed direct to the OPSHN intersection to begin the arrival procedure. ATC advises to expect an altitude of 10,000 feet at OPSHN.

- a) Press the **FMS** Knob to activate the cursor.
- b) Turn the large **FMS** Knob to select OPSHN in the flight plan list.
- c) Press the **Direct-to** (D➤) Key. The Direct-to Window is now displayed as shown in Figure 5-121.



Figure 5-121 Direct To OPSHN

d) Turn the large **FMS** Knob to place the cursor in the VNV altitude field as shown in Figure 5-122.



Figure 5-122 Enter VNV Altitude

e) An altitude of 10,000 feet is entered as requested by ATC.

f) Press the **ENT** Key. The cursor is now displayed in the VNV offset field as shown in Figure 5-123.



Figure 5-123 Enter VNV Offset Distance

g) Enter the offset, or distance from the waypoint at which to reach the selected altitude. In this case, three miles prior to OPHSN is entered. In other words, the system gives vertical guidance so the aircraft arrives at an altitude of 10,000 feet three miles prior to OPHSN.

h) Press the **ENT** Key twice to activate the direct-to. Note, in Figure 5-124, the magenta arrow indicating the direct-to OPSHN after the offset waypoint for OPSHN. The preceding offset waypoint indicates the offset distance and altitude that were previously entered. The remaining waypoints in the loaded arrival procedure have no database specified altitudes, therefore, dashes are displayed. Keep the CDI centered and maintain a track along the magenta line to OPSHN.

Note the Direct-to waypoint is within the loaded arrival procedure, therefore, phase of flight scaling for the CDI changes to Terminal Mode and is annunciated by displaying 'TERM' on the HSI.



**NOTE:** If the loaded arrival procedure has waypoints with altitude constraints retrieved from the database that will be used as is, the altitude must be manually accepted by placing the cursor over the desired altitude, then pressing the ENT Key. The altitude is now displayed as light blue meaning it is now used by the system to determine vertical speed and deviation guidance.

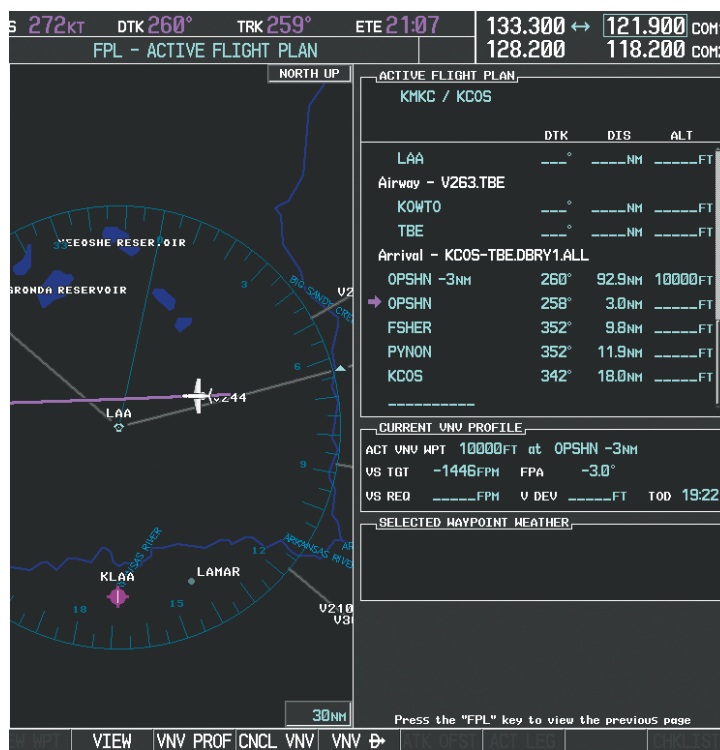

Figure 5-124 Direct-to Active

12) The aircraft is proceeding to OPSHN. The expected approach is the RNAV LPV approach to runway 35R, so it is selected.

a) Press the **PROC** Key to display the Procedures Window.

b) 'SELECT APPROACH' should be highlighted as shown in Figure 5-125.



Figure 5-125 Procedures Window

c) Press the ENT Key. A list of available approaches for the destination airport is displayed as in Figure 5-126.

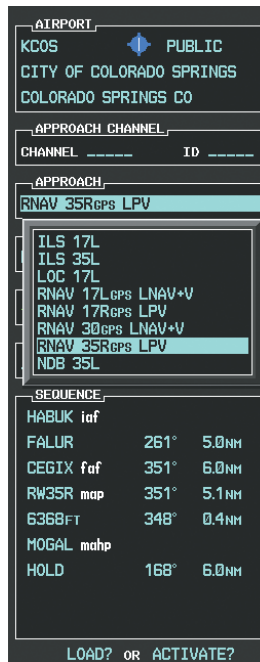

Figure 5-126 List of Available Approaches

d) Turn either FMS Knob to select the LPV approach for 35R as shown in Figure 5-125.

e) Press the **ENT** Key. A list of available transitions for the selected approach is displayed as in Figure 5-127.

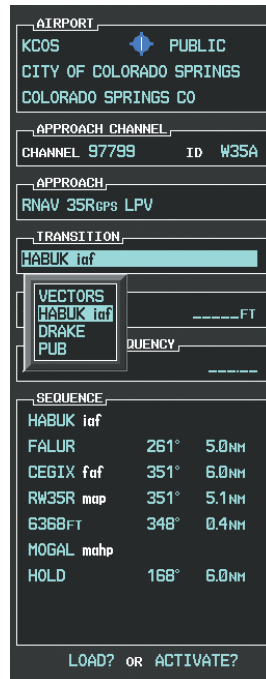

Figure 5-127 List of Available Transitions

f) Turn either **FMS** Knob to select the desired transition. In this case, the Initial Approach Fix (IAF) at HABUK is used.

g) Press the **ENT** Key.

h) Barometric Minimums

To set 'MINIMUMS', turn the small **FMS** Knob to select 'BARO', and press the **ENT** Key. Turn the small **FMS** Knob to select the altitude, and press the **ENT** Key.

**Or:**

To skip setting minimums, press the **ENT** Key.





Figure 5-128 Barometric Minimums Set

- i) With 'LOAD?' highlighted, again press the ENT Key. The selected approach is added to the flight plan as seen in Figure 5-129.

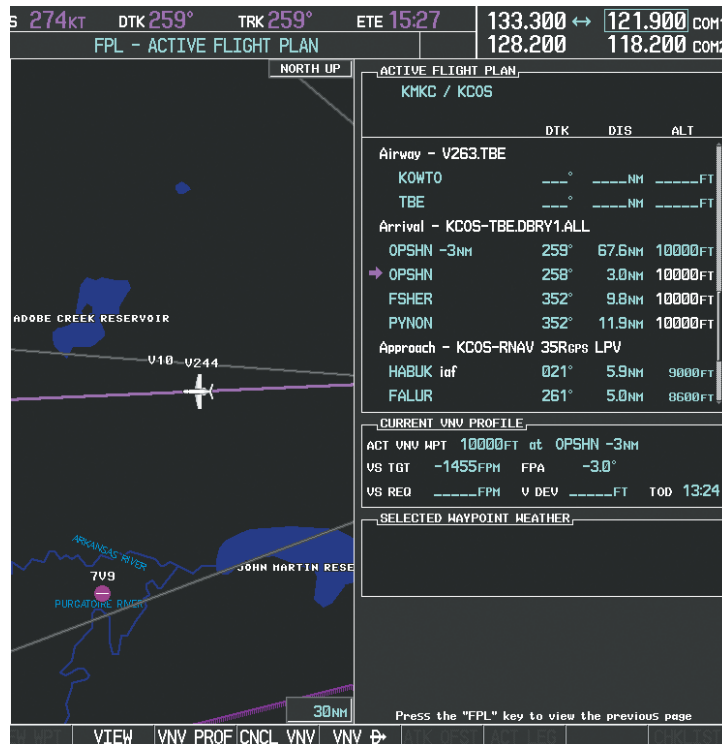

Figure 5-129 Loaded Approach

- 13) Note the altitude constraints associated with each of the approach waypoints as seen in Figure 5-130. These altitudes are loaded from the database and are displayed as light blue text, indicating these values are “designated” for use in computing vertical deviation guidance.

Note: To no longer use the displayed altitude for calculating vertical deviation guidance, perform the following:

- a) Press the **FMS** Knob to activate the cursor.
- b) Turn the small **FMS** Knob to highlight the desired altitude.
- c) Press the **CLR** Key.
- d) Press the **FMS** Knob to deactivate the cursor.

After making the altitude “non-designated”, it is displayed as white text.

Altitude constraint values associated with the Final Approach Fix (FAF) and waypoints beyond the FAF cannot be designated for vertical guidance. These altitude values are always displayed as white text, as in Figure 5-130. Vertical guidance from the FAF and on to the Missed Approach Point (MAP) is given using the SBAS GPS altitude source, therefore, the displayed altitude values are for reference only.

ACTIVE FLIGHT PLAN			
KMKC / KCOS			
	DTK	DIS	ALT
FSHER	352°	9.8NM	10000FT
PYNON	352°	11.9NM	10000FT
Approach - KCOS-RNAV 3SRGPS LPV			
HABUK iaf	021°	5.9NM	9000FT
FALUR	261°	5.0NM	8600FT
CEGIX faf	351°	6.0NM	7800FT
RW3SR map	351°	5.1NM	
6368FT	348°	0.4NM	6370FT
MOGAL mahp			10000FT
HOLD	168°	6.0NM	
-----			
CURRENT UNV PROFILE			
ACT UNV WPT 10000FT at OPSHN -3NM			
VS TGT	-1455FPM	FPA	-3.0°
VS REQ	-----FPM	V DEV	-----FT TOD 13:24

Figure 5-130 Vertical Guidance is Active to the FAF

- 14) As the aircraft approaches OP SHN, it may be desirable to adjust the speed, or steepness of the upcoming descent. The default Flight Path Angle (FPA) is -3.0 degrees and a required vertical speed is computed to maintain the -3.0 FPA. To change the vertical flight path, perform the following steps.
  - a) Select the **VNV PROF** Softkey to place the cursor in the target vertical speed field (VS TGT) as shown in Figure 5-131.
  - b) At this point, the descent vertical speed can be selected, or the FPA can be selected. Turn the large **FMS** Knob to select the desired selection field, then turn the small **FMS** Knob to enter the desired value.

Note the information now displayed in the 'CURRENT VNV PROFILE' box. Also, note the offset waypoint (orange box) and gray circle are now displayed on the map. The gray circle marks the Top of Descent (TOD). In this example, vertical guidance is provided at the TOD that results in a -3.0 degree FPA descent to an altitude of 10,000 feet upon reaching the offset waypoint.

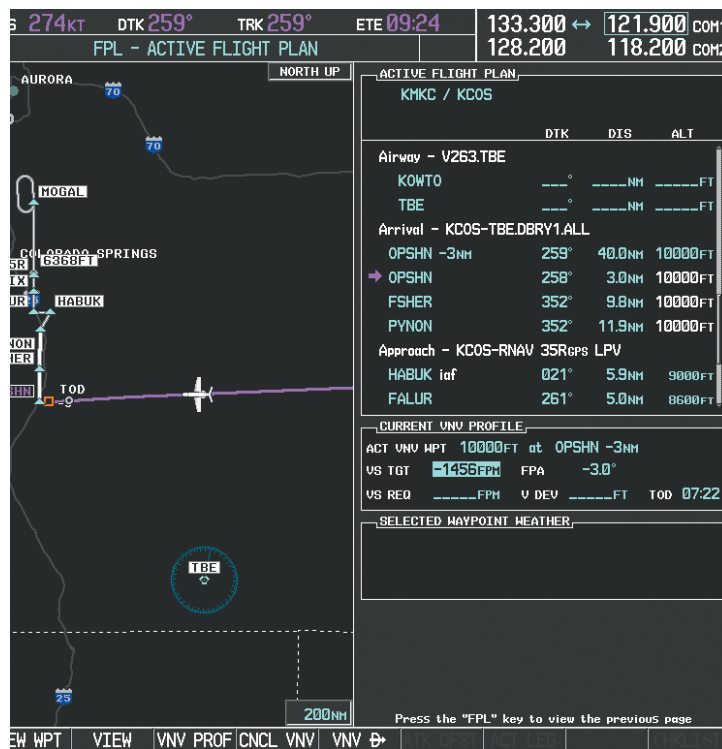

Figure 5-131 Adjusting the Descent

- c) Press the **ENT** Key.

15) As seen in Figure 5-132, the aircraft is approaching TOD. Note the target vertical speed required to reach the selected altitude. The Vertical Deviation Indicator (VDI) and the Required Vertical Speed Indicator (RVSI) are now displayed on the PFD as shown in Figure 5-133. When the aircraft is within one minute of the TOD, it is annunciated as shown in Figure 5-133, and an aural alert 'Vertical track' will be heard.



Figure 5-132 Approaching Top of Descent (TOD)

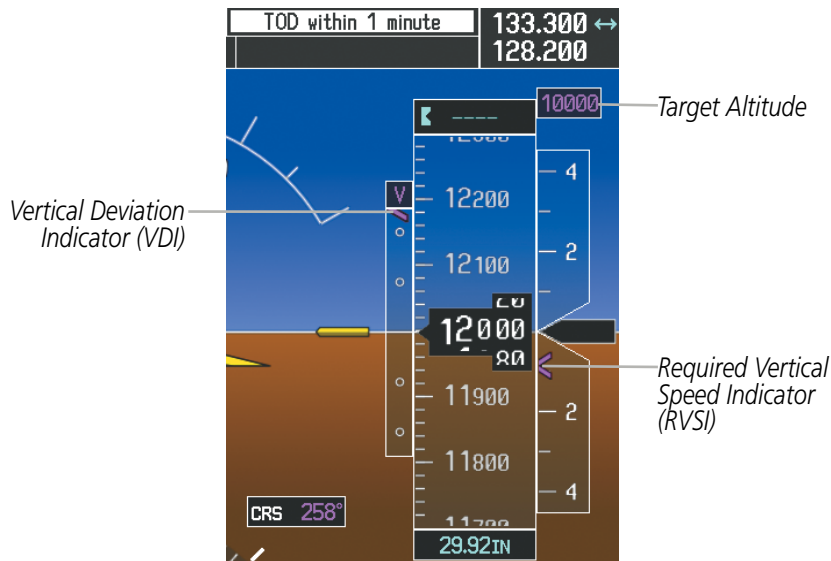

Figure 5-133 VDI & RVSI When Approaching Top of Descent (TOD)

- 16) Upon reaching TOD, a descent vertical speed is established by placing the VSI pointer in line with the RVSI as shown in Figure 5-134.

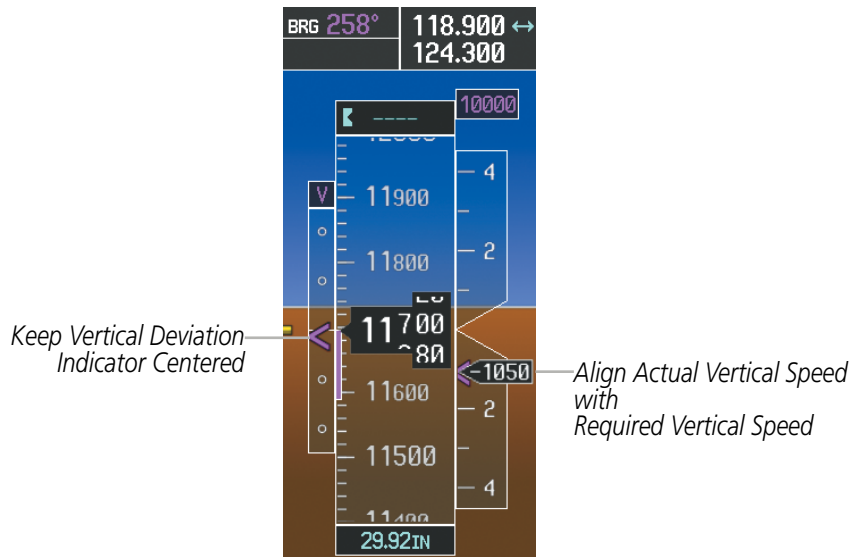

Figure 5-134 VDI & RVSI Showing Correctly Established Descent

- 17) When the aircraft is one minute from the bottom of descent (BOD) it is annunciated as shown in Figure 5-135. Upon reaching the offset waypoint for OPSHN, the aircraft is at 10,000 feet.

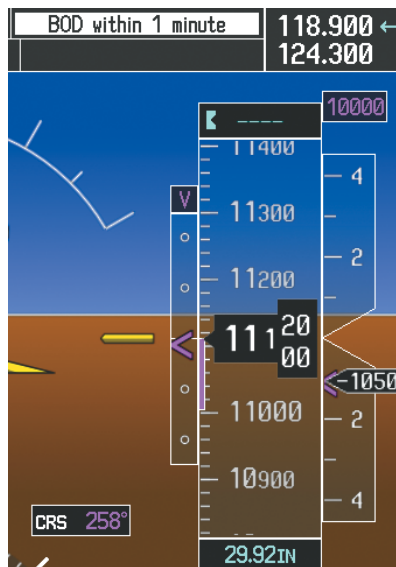

Figure 5-135 Approaching Bottom of Descent (BOD) at OPSHN Offset Waypoint

- 18) The aircraft is approaching OPSHN. The upcoming turn and next heading are annunciated at the top left of the PFD as seen in Figure 5-136. Initiate the turn and maneuver the aircraft on a track through the turn radius to intercept the magenta line for the OPSHN to FSHER leg and center the CDI.

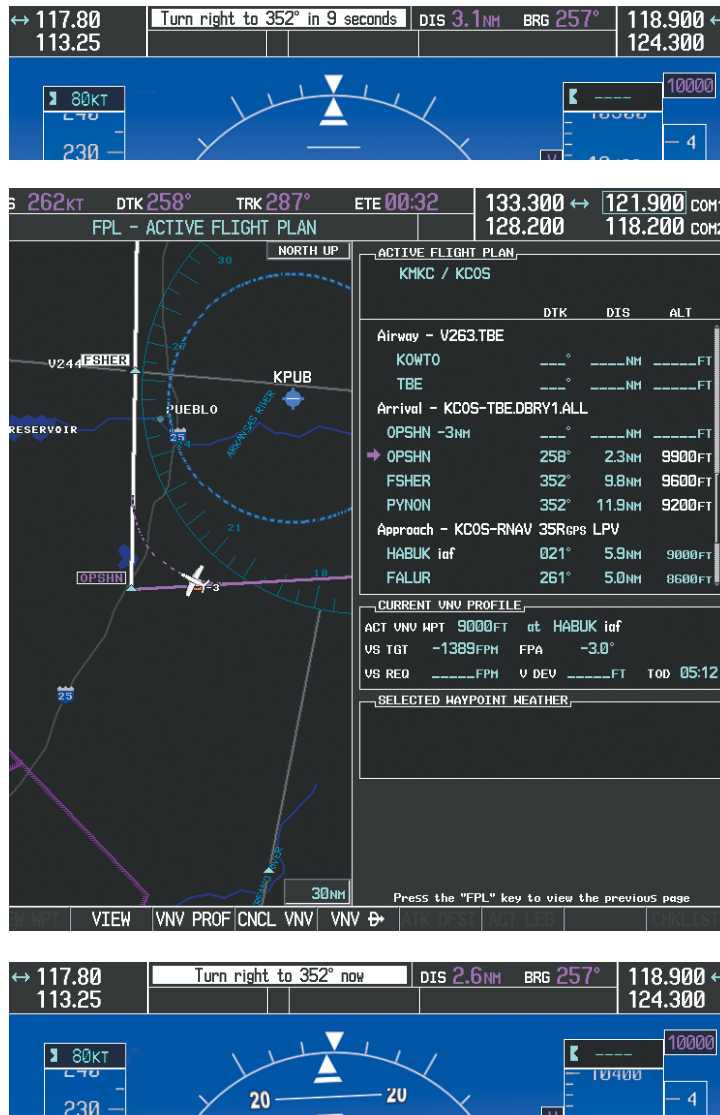

Figure 5-136 Turn to intercept OPSHN to FSHER Leg

- 19) After passing OPSHN, the next leg of the arrival turns magenta as shown in Figure 5-137. The magenta arrow in the flight plan list now indicates the OPSHN to FSHER leg of the arrival procedure is now active.

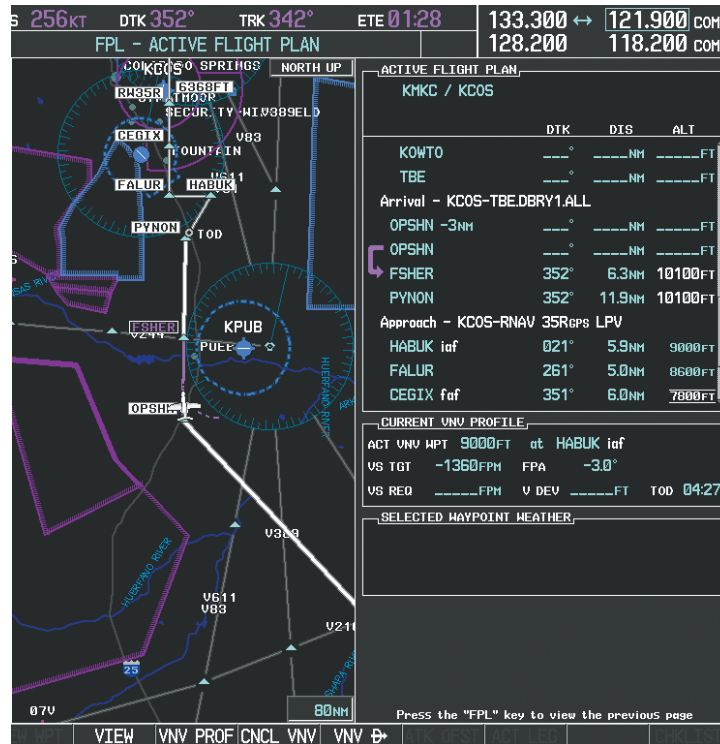

Figure 5-137 Tracking the OPSHN to FSHER Leg

- 20) The flight continues through the arrival procedure to PYNON (see Figure 5-138). At a point 31 nm from the destination airport, the phase of flight scaling for the CDI changes to Terminal Mode and is annunciated by displaying 'TERM' on the HSI.

A descent to HABUK is in the next leg. Note the TOD point on the map. Annunciations for the upcoming turn and descent, as well as the VDI and RVSI, appear on the PFD as the flight progresses.



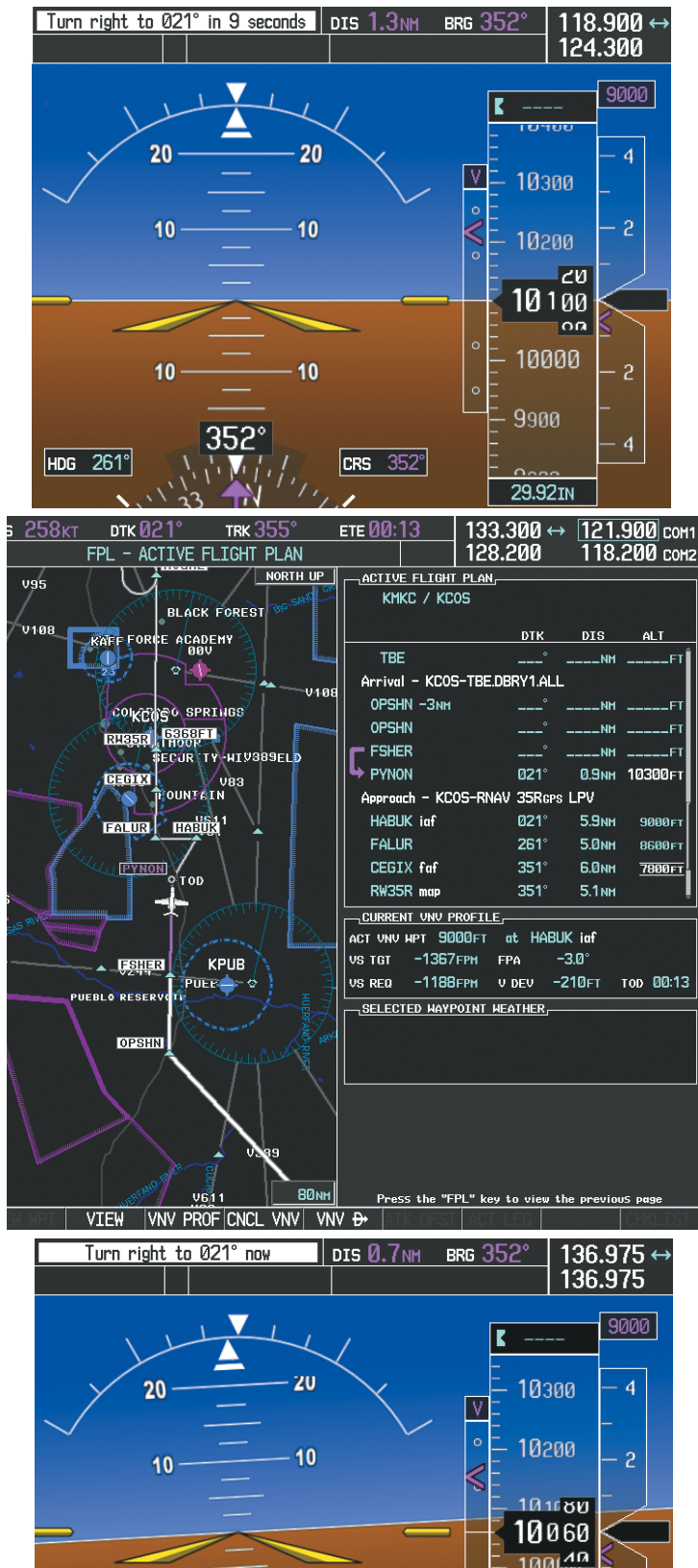

Figure 5-138 Approaching PYNON

21) Upon passing PYNON the approach procedure automatically becomes active. The approach may be activated at any point to proceed directly to the IAF. In this example, the aircraft has progressed through the final waypoint of the arrival and the flight plan has automatically sequenced to the IAF as the active leg, activating the approach procedure (see Figure 5-139).

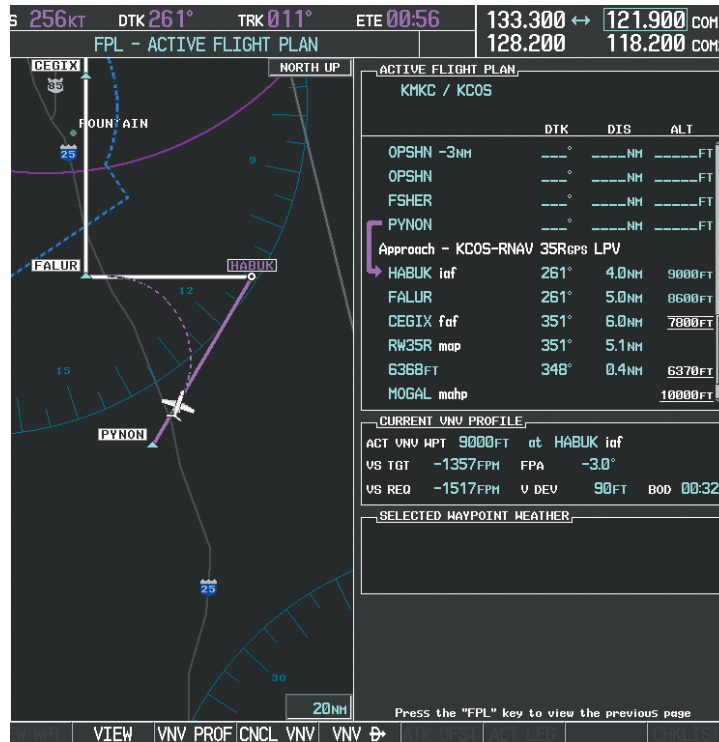

Figure 5-139 Approach is Now Active

Note: To manually activate the approach procedure, perform the following steps:

- Press the **PROC** Key.
- Turn the large **FMS** Knob to highlight 'ACTIVATE APPROACH' as shown in Figure 5-140.
- Press the **ENT** Key to activate the approach.

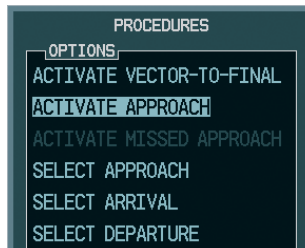

Figure 5-140 Manually Activate Approach

22) The IAF is the next waypoint. At the TOD, establish a descent vertical speed as previously discussed in Step 16. The aircraft altitude is 9,000 feet upon reaching HABUK.

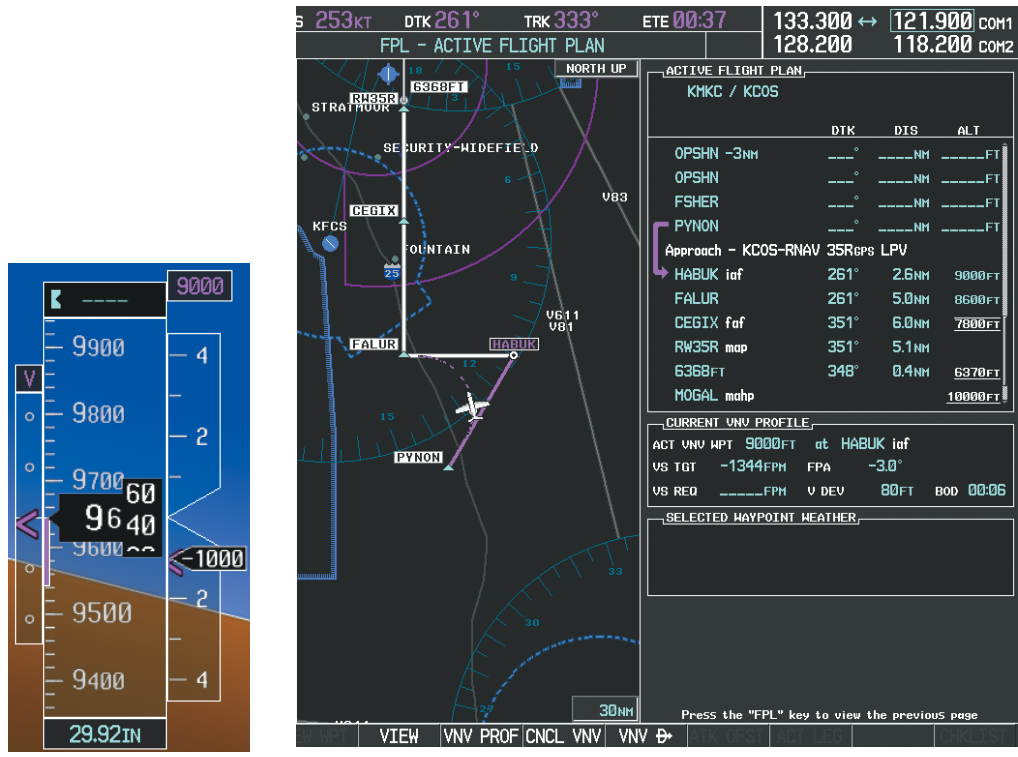

Figure 5-141 Descending Turn to the Initial Approach Fix (IAF)

- 23) After crossing FALUR the next waypoint is the FAF. The flight phase changes to LPV on the HSI indicating the current phase of flight is in Approach Mode and the approach type is LPV. CDI scaling changes accordingly and is used much like a localizer when flying an ILS approach. The RVSI is no longer displayed and the VDI changes to the Glidepath Indicator (as shown in Figure 5-142) when the final approach course becomes active.

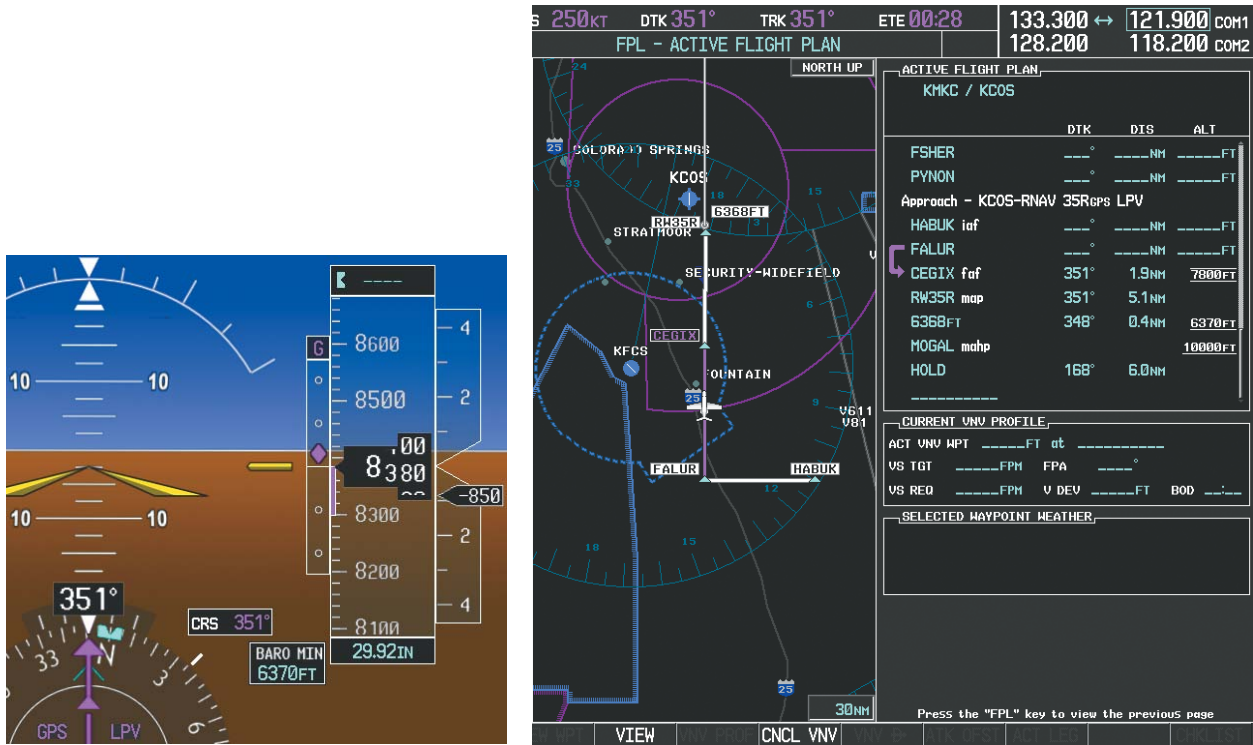

Figure 5-142 Descending to the FAF

The descent continues through the FAF (CEGIX) using the Glidepath Indicator, as one would use a glideslope indicator, to obtain an altitude "AT" 7,800 feet at the FAF. Note the altitude restriction lines over and under (At) the altitude in the 'ALT' field in Figure 5-142.

- 24) After crossing CEGIX, the aircraft continues following the glidepath to maintain the descent to "AT or ABOVE" 6,370 feet at the Missed Approach Point (MAP) (RW35R) as seen in Figure 5-143.

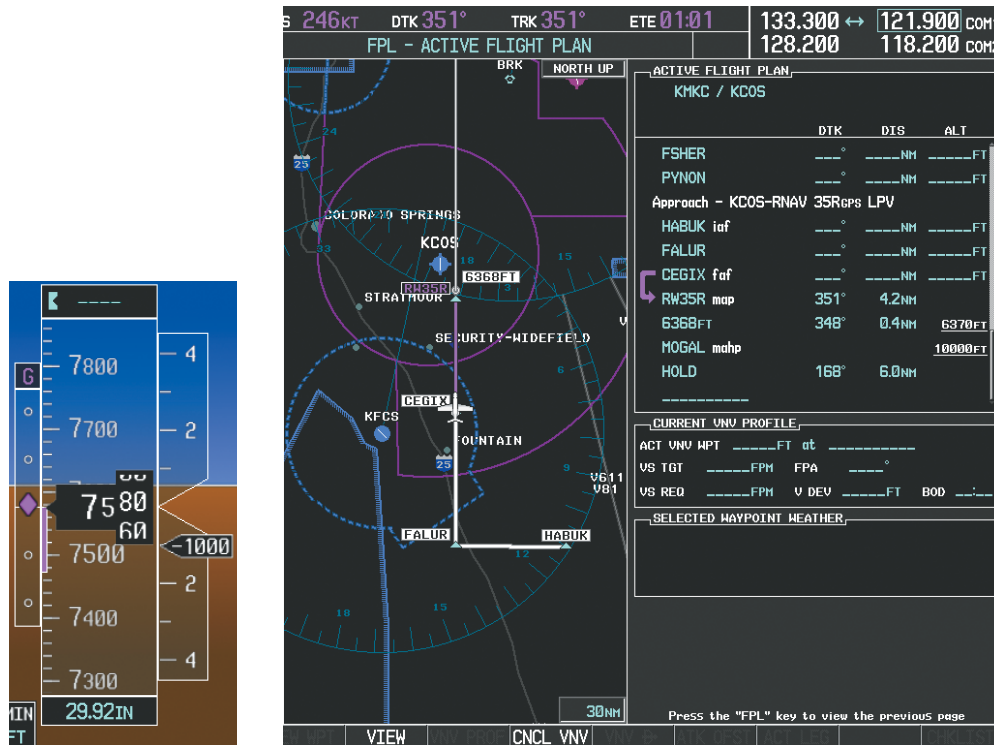

Figure 5-143 Descending to the Missed Approach Point

In this missed approach procedure, the altitude immediately following the MAP (in this case '6368ft') is not part of the published procedure. It is simply a Course to Altitude (CA) leg which guides the aircraft along the runway centerline until the altitude required to safely make the first turn toward the MAHP is exceeded. This altitude is provided by Jeppesen, and may be below, equal to, or above the published minimums for this approach. In this case, if the aircraft altitude is below the specified altitude (6,368 feet) after crossing the MAP, a direct-to is established to provide a course on runway heading until an altitude of 6,368 feet is reached. After reaching 6,368 feet, a direct-to is established to the published MAHP (in this case MOGAL). If the aircraft altitude is above the specified altitude after crossing the MAP, a direct-to is established to the published fix (MOGAL) to begin the missed approach procedure.

In some missed approach procedures this Course to Altitude leg may be part of the published procedure. For example, a procedure may dictate a climb to 5,500 feet, then turn left and proceed to the Missed Approach Hold Point (MAHP). In this case, the altitude would appear in the list of waypoints as '5500ft'. Again, if the aircraft altitude is lower than the prescribed altitude, a direct-to is established on a Course to Altitude leg when the missed approach procedure is activated.

- 25) Upon reaching the MAP, it is decided to execute a missed approach. Automatic waypoint sequencing is suspended past the MAP. Press the **SUSP** Softkey on the PFD to resume automatic waypoint sequencing through the missed approach procedure.

A direct-to is initiated to MOGAL, which is the Missed Approach Hold Point (MAHP) as seen in Figure 5-144. The aircraft is climbing to 10,000 feet. The CDI flight phase now changes from LPV to MAPR as seen on the HSI.

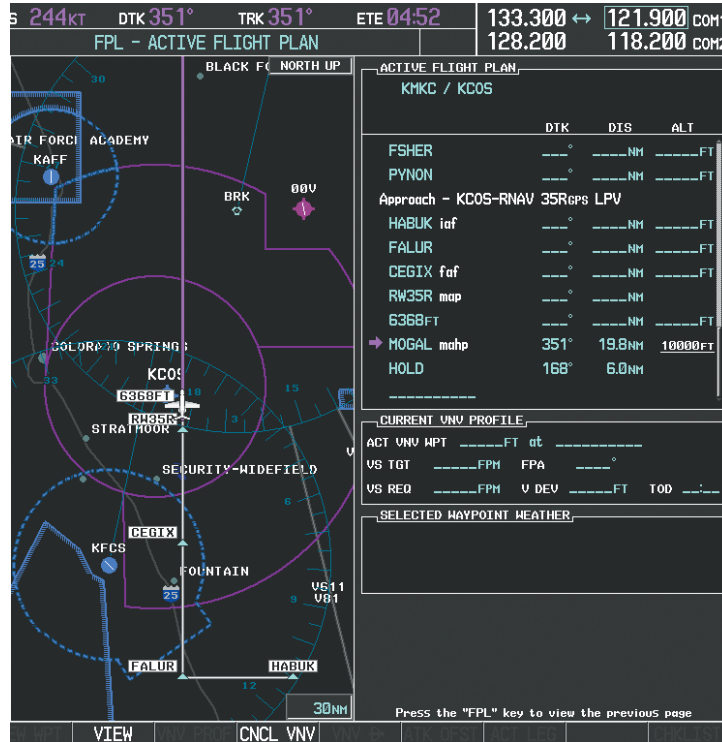

Figure 5-144 Missed Approach Active



26) The aircraft continues climbing to “AT or ABOVE” 10,000 feet at MOGAL. A holding pattern is established at the MAHP (MOGAL) as shown in Figure 5-145.

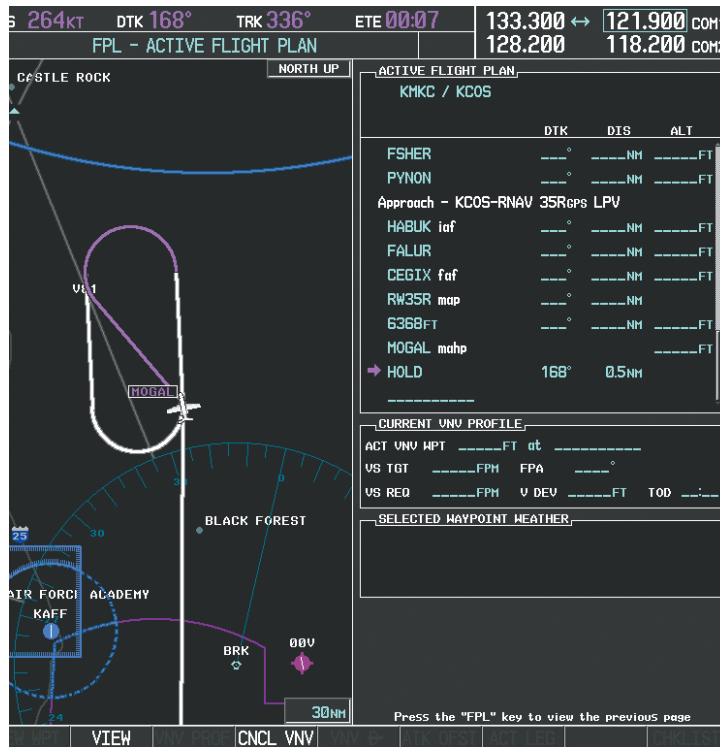

Figure 5-145 Establishing the Holding Pattern

27) The aircraft maintains 10,000 feet while following the magenta line through the hold as in Figure 5-146.

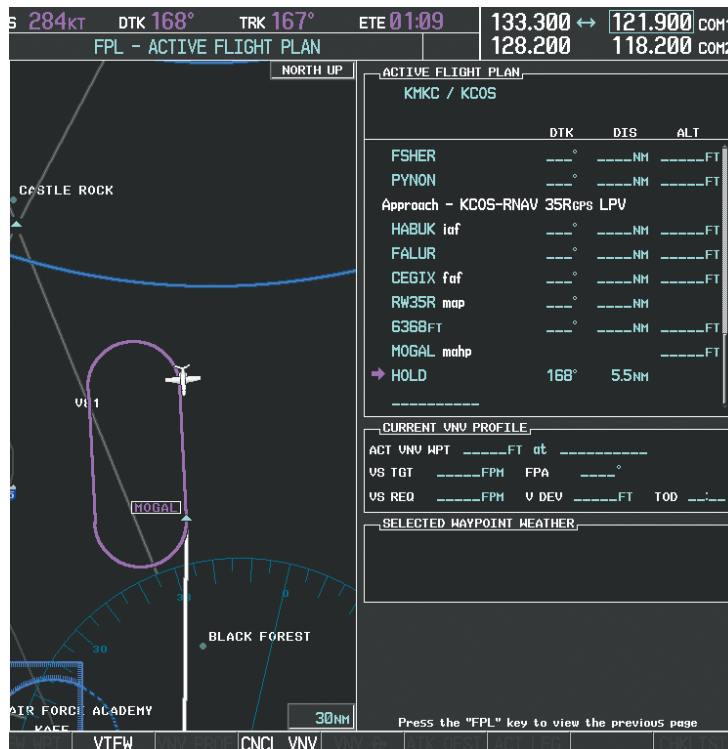

Figure 5-146 Hold Established



## 5.12 ABNORMAL OPERATION

This section discusses the Dead Reckoning mode of operation and the subsequent indications.



**NOTE:** *Dead Reckoning Mode only functions in Enroute (ENR) or Oceanic (OCN) phase of flight. In all other phases, an invalid GPS solution produces a "NO GPS POSITION" annunciation on the map and the system stops using GPS.*

While in Enroute or Oceanic phase of flight, if the system detects an invalid GPS solution or is unable to calculate a GPS position, the system automatically reverts to Dead Reckoning (DR) Mode. In DR Mode, the system uses its last-known position combined with continuously updated airspeed and heading data (when available) to calculate and display the aircraft's current estimated position.

It is important to note that estimated navigation data supplied by the system in DR Mode may become increasingly unreliable and must not be used as a sole means of navigation. If while in DR Mode airspeed and/or heading data is also lost or not available, the DR function may not be capable of accurately tracking estimated position and, consequently, the system may display a path that is different than the actual movement of the aircraft. Estimated position information displayed through DR while there is no heading and/or airspeed data available should not be used for navigation.

DR Mode is inherently less accurate than the standard GPS/SBAS Mode due to the lack of satellite measurements needed to determine a position. Changes in wind speed and/or wind direction compound the relative inaccuracy of DR Mode. Because of this degraded accuracy, other navigation equipment must be relied upon for position awareness until GPS-derived position data is restored.

DR Mode is indicated by the appearance of the letters 'DR' superimposed in yellow over the 'own aircraft' symbol as shown in Figure 5-147. In addition, 'DR' is prominently displayed in yellow on the HSI slightly above and to the right of the aircraft symbol on the CDI as shown in Figure 5-147. Also, the CDI deviation bar is removed from the display. Lastly, but at the same time, a 'GPS NAV LOST' alert message appears on the PFD. Normal navigation using GPS/SBAS source data resumes automatically once a valid GPS solution is restored.

As a result of operating in DR Mode, all GPS-derived data is computed based upon an estimated position and is displayed as yellow text on the display to denote degraded navigation source information as shown in Figure 5-147.

Also, while the system is in DR Mode, the autopilot does not couple to GPS, and TAWS is disabled. Additionally, the accuracy of all nearest information (airports, airspaces, and waypoints) is questionable. Finally, airspace alerts continue to function, but with degraded accuracy.

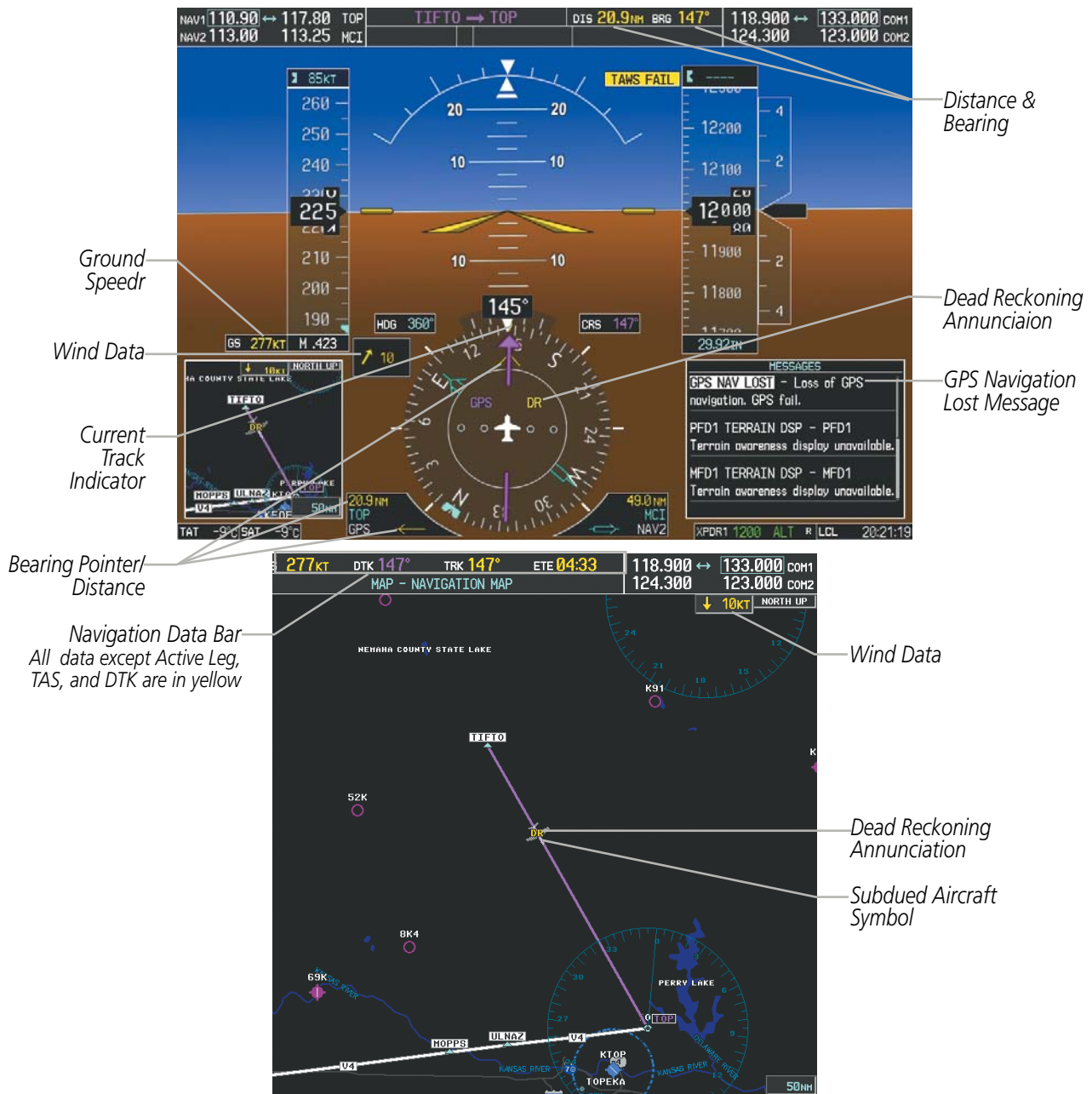

Figure 5-147 Dead Reckoning Mode - GPS Derived Data Shown in Yellow



**NOTE:** The Inset Map is removed from the PFD any time aircraft pitch is greater than +30° or less than -20°, or when a 65° bank angle is reached.

## SECTION 6 HAZARD AVOIDANCE

Hazard avoidance features available for the Prodigy® Flight Deck 300 are designed to aid situational awareness and provide advisory information with regard to potential hazards to flight safety associated with weather, terrain, and air traffic.

### **Weather**

- GDL 69A SiriusXM Weather (Subscription Optional)
- GWX 68 Airborne Color Weather Radar (Optional)

### **Terrain Avoidance**

- Terrain Awareness and Warning System - Class B (TAWS-B)
- Terrain Awareness and Warning System - Class A (TAWS-A) (Optional)

### **Traffic**

- TIS (Traffic Information Service)
- ACSS TCAS 3000SP™ Traffic Alert and Collision and Avoidance System II (TCAS II) (Optional)

## 6.1 SIRIUSXM WEATHER



**NOTE:** *SiriusXM Weather data provides information for avoiding hazardous weather. Do not use SiriusXM Weather information to penetrate hazardous weather.*

The GDL 69A is a remote-mounted data link satellite receiver which provides SiriusXM Weather information. Received graphical weather information and associated text is displayed on the Multi Function Display (MFD) and the Primary Flight Display (PFD) Inset Map. The GDL 69A can also receive SiriusXM Satellite Radio entertainment services. Both weather data and audio entertainment programming operate in the S-band frequency range to provide continuous reception capabilities at any altitude throughout North America.

Both services are subscription-based. For more information on specific service packages, visit [www.siriusxm.com](http://www.siriusxm.com).

### ACTIVATING SERVICES

Before SiriusXM Weather can be used, the service must be activated. Service is activated by providing SiriusXM with coded IDs unique to the installed GDL 69A. SiriusXM Satellite Radio (audio) and SiriusXM Weather (data) services each have coded IDs. The Data and Audio Radio IDs must be provided to SiriusXM to activate the weather service and entertainment subscriptions, respectively. These IDs are located on:

- The label on the back of the Data Link Receiver
- The XM Information Page on the MFD (Figure 6-1)
- The XM Satellite Radio Activation Instructions included with the unit (available at [www.garmin.com](http://www.garmin.com), P/N 190-00355-04)

Contact the installer if the Audio and Data Radio IDs cannot be located.

SiriusXM uses the coded IDs to send an activation signal that allows the system to provide weather data and/or audio entertainment programming provided through the GDL 69A.

#### Activating SiriusXM Weather and SiriusXM Satellite Radio services:

- 1) Contact SiriusXM using the customer service phone number listed on the website. Follow the instructions provided by SiriusXM customer service.
- 2) Select the XM Radio page in the Auxiliary Page Group.
- 3) Select the **INFO** Softkey to display the XM Information Page.
- 4) Verify that the desired services are activated.
- 5) Select the **LOCK** Softkey.
- 6) Turn the large **FMS** Knob to highlight 'YES'.
- 7) To complete activation, press the **ENT** Key.



**Figure 6-1 XM Information Page**

**USING SIRIUSXM WEATHER PRODUCTS**

The principal map page for viewing SiriusXM Weather data is the Weather Data Link (XM) Page in the Map Page Group. This is the only map display capable of showing information for all available SiriusXM Weather products.

**Viewing the Weather Data Link (XM) Page:**

- 1) Turn the large **FMS** Knob to select the Map Page Group.
- 2) Turn the small **FMS** Knob to select the Weather Data Link (XM) Page.

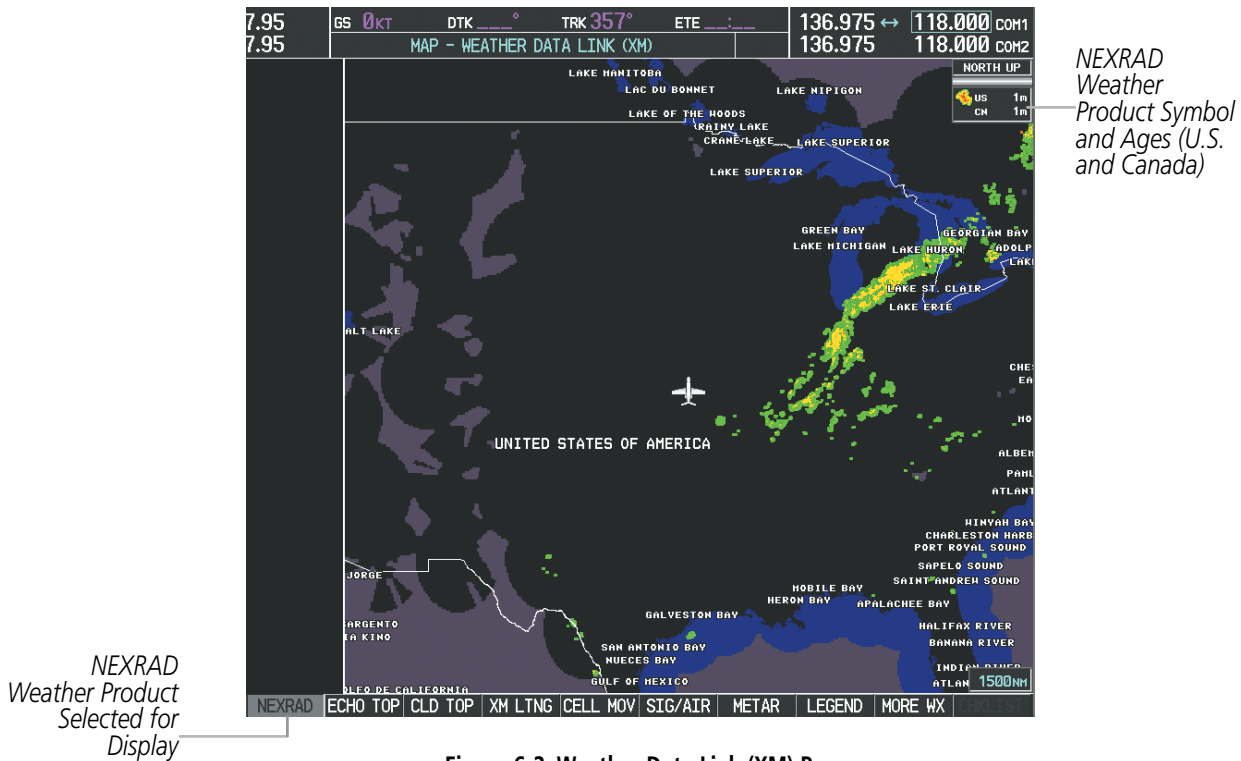



















Figure 6-2 Weather Data Link (XM) Page

When a weather product is active on the Weather Data Link (XM) Page or the Navigation Map Page, the system displays the age of the weather data next to the weather product symbol (Figure 6-2). The age of the product is based on the time difference between when the data was assembled on the ground and the current GPS time. Weather products are refreshed at specific intervals (defined in the **Refresh Rate** column in Table 6-1).

If for any reason, a weather product is not refreshed within the designated **Expiration Time** intervals (see Table 6-1), the data is considered expired and is removed from the display, and the product age display is replaced by dashes. This ensures that the displayed data is consistent with what is currently being provided by SiriusXM Weather services. If more than half of the expiration time has elapsed, the color of the product age changes to yellow. If no data is available for a weather product, 'N/A' is displayed next to the weather product symbol.

Table 6-1 shows the weather product symbols, the expiration times and the refresh rates. The refresh rate represents the interval at which SiriusXM Weather services provides new signals that may or may not contain new weather data. It does not represent the rate at which weather data is updated or new content is received by the Data Link Receiver. Weather data is updated at intervals that are defined and controlled by SiriusXM and its weather suppliers, and are subject to change.

SiriusXM Weather Product	Product Symbol	Expiration Time (Minutes)	Refresh Rate (Minutes)
Next-generation Radar (NEXRAD)		30	5 (U.S.) 10 (Canada)
Cloud Top (CLD TOP)		60	15
Echo Top (ECHO TOP)		30	7.5
SiriusXM Lightning (XM LTNG)		30	5
Cell Movement (CELL MOV)		30	12
SIGMETs/AIRMETs (SIG/AIR)		60	12
Meteorological Aerodrome Report (METARs)		90	12
City Forecast (CITY)		60	12
Surface Analysis (SFC)		60	12
Freezing Levels (FRZ LVL)		60	12
Winds Aloft (WIND)		60	12
County Warnings (COUNTY)		60	5
Cyclone Warnings (CYCLONE)		60	12
Icing Potential (CIP and SLD) (ICNG)		90	22
Pilot Weather Report (PIREPs)		90	12
Air Report (AIREPs)		90	12
Turbulence (TURB)		180	12
No Radar Coverage (RADAR CVRG)	no product image	30	5
Temporary Flight Restrictions (TFRs)	no product image	60	12
Terminal Aerodrome Reports (TAFs)	no product image	60	12

**Table 6-1 SiriusXM Weather Product Symbols and Data Timing**



Table 6-2 shows which SiriusXM Weather products can be displayed (indicated with a '+' symbol) on specific maps.

SiriusXM Weather Product	PFD Inset Map	Navigation Map Page	Weather Data Link (XM) Page	Weather Information Page	AUX - Trip Planning Page	SYS Page Group	Nearest Page Group	Flight Plan Pages
NEXRAD	+	+	+		+	+	+	+
Cloud Top (CLD TOP)			+					
Echo Top (ECHO TOP)			+					
SiriusXM Lightning (XM LTNG)	+	+	+		+	+	+	+
Cell Movement (CELL MOV)	+	+	+		+	+	+	+
SIGMETs/AIRMETs (SIG/AIR)			+					
METARs	+	+	+	+	+	+	+	+
City Forecast (CITY)			+					
Surface Analysis (SFC)			+					
Freezing Levels (FRZ LVL)			+					
Winds Aloft (WIND)			+					
County Warnings (COUNTY)			+					
Cyclone Warnings (CYCLONE)			+					
Icing Potential (ICNG)			+					
PIREPs			+	+				
AIREPs			+	+				
Turbulence (TURB)			+					
Radar Coverage	+	+	+		+	+	+	+
TFRs	+	+	+	+	+	+	+	+
TAFs			+	+				

**Table 6-2 SiriusXM Weather Product Display Maps**

Softkeys control the display of weather information on most MFD pages and the PFD Inset Map (Figure 6-3 shows the weather product softkeys for the Weather Data Link (XM) Page). When a weather product is selected for display, the corresponding softkey label changes to gray to indicate the product is enabled.

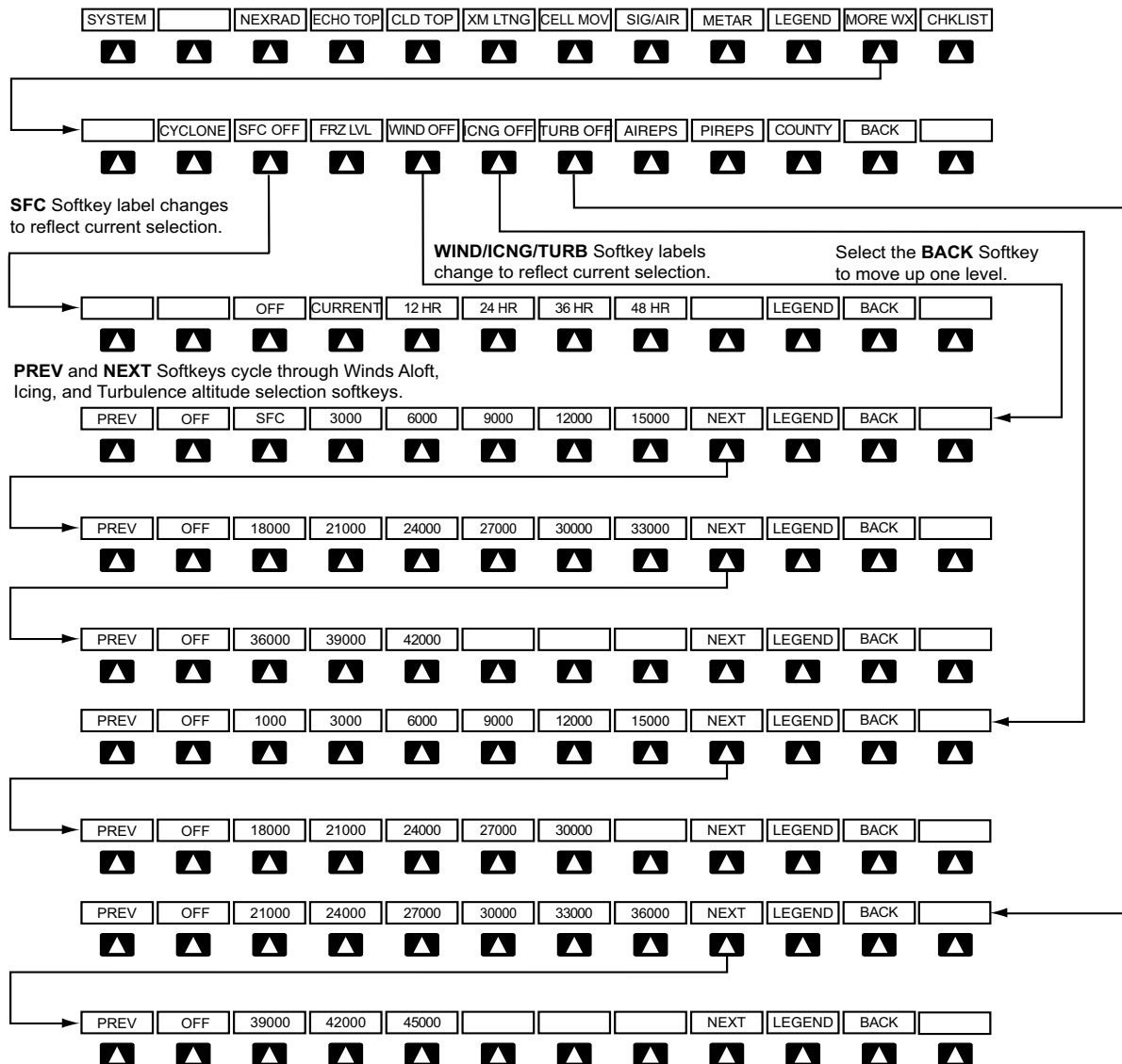

Figure 6-3 Weather Data Link (XM) Page Weather Product Softkeys

**Displaying SiriusXM Weather products on the PFD Inset Map:**

- 1) On the PFD, press the **INSET** Softkey (in non-TCAS II installations) or the **TRFC/MAP** Softkey (TCAS II installations).
- 2) If the PFD Inset Map is showing the traffic map, press the **TRFC-2** Softkey to display the navigation map.
- 3) Press the desired weather product softkey(s) to enable/disable the display of SiriusXM Weather products on the Inset Map.

### Showing/hiding weather product icon and product age on PFD Inset Map:

- 1) On the PFD, press the **INSET** Softkey (in non-TCAS II installations) or the **TRFC/MAP** Softkey (TCAS II installations).
- 2) If the PFD Inset Map is showing the traffic map, press the **TRFC-2** Softkey to display the navigation map.
- 3) Press the **WX LGND** Softkey. The system displays the weather product icons and ages for the enabled weather products on the inset map when the **WX LGND** Softkey is enabled.

The setup menus for the Navigation Map Page and the Weather Data Link (XM) Page control the map range settings above which weather products data are decluttered from the display. If a map range larger than the weather product map range setting is selected, the weather product data is removed from the map. The menus also provide a means in addition to the softkeys for enabling/disabling display of weather products.

### Setting up and customizing the Weather Data Link (XM) Page:

- 1) Select the Weather Data Link (XM) Page.
- 2) Press the **MENU** Key.
- 3) With 'Weather Setup' highlighted, press the **ENT** Key (Figure 6-4).
- 4) Turn the small **FMS** Knob to select 'PRODUCT GROUP 1' or 'PRODUCT GROUP 2', and press the **ENT** Key (Figure 6-5).
- 5) Turn the large **FMS** Knob or press the **ENT** Key to scroll through product selections.
- 6) Turn the small **FMS** Knob to scroll through options for each product (ON/OFF, range settings, etc.).
- 7) Press the **ENT** Key to select an option.
- 8) Press the **FMS** Knob or **CLR** Key to return to the Weather Data Link (XM) Page with the changed settings.



Figure 6-4 Weather Data Link (XM) Page Menu

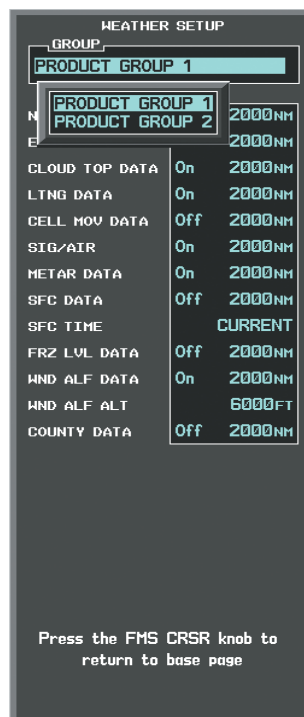

Figure 6-5 Weather Data Link (XM) Page Setup Menu

**Restoring default Weather Data Link (XM) Page settings:**

- 1) Select the Weather Data Link (XM) Page.
- 2) Press the **MENU** Key.
- 3) With 'Weather Setup' highlighted, press the **ENT** Key.
- 4) Press the **MENU** Key.
- 5) Highlight the desired default(s) to restore (all or for selection) and press **ENT** Key.

Maps besides the Weather Data Link (XM) Page use settings based on those selected for the Navigation Map Page.

**Setting up and customizing weather data for the Navigation Map Page:**

- 1) Select the Navigation Map Page.
- 2) Press the **MENU** Key.
- 3) With 'Map Setup' highlighted, press the **ENT** Key (Figure 6-6).
- 4) Turn the small **FMS** Knob to select the 'Weather' Group and press the **ENT** Key (Figure 6-7).
- 5) Turn the large **FMS** Knob or press the **ENT** Key to scroll through product selections (Figure 6-8).
- 6) Turn the small **FMS** Knob to scroll through options for each product (ON/OFF, range settings).
- 7) Press the **ENT** Key to select an option.
- 8) Press the **FMS** Knob or **CLR** Key to return to the Navigation Map Page with the changed settings.

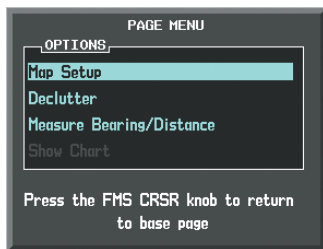

**Figure 6-6 Navigation Map Page Menu**



**Figure 6-7 Navigation Map Page Setup Menu**

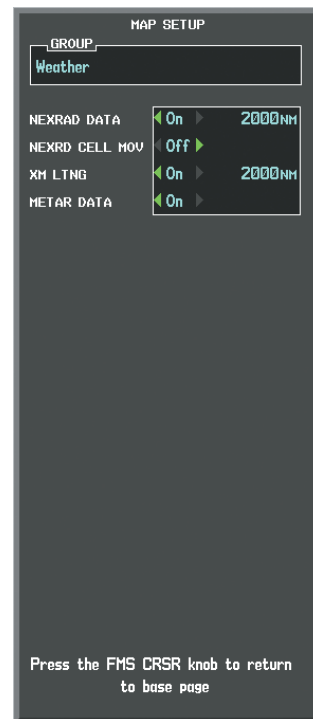

**Figure 6-8 Navigation Map Page Setup Menu, Weather Group**

Each active weather product has an associated legend which can be displayed on the Weather Data Link (XM) Page and on most MFD pages displaying a navigation map.

**Viewing legends for displayed weather products (on the Weather Data Link (XM) Page):**

- 1) Select the Weather Data Link (XM) Page.
- 2) Press the **LEGEND** Softkey to display the legends for the displayed weather products.  
**Or:**
  - a) Press the **MENU** Key.
  - b) Select 'Weather Legend' and press the **ENT** Key.
- 3) Turn the **FMS** Knob to scroll through the legends if more are available than fit in the window.
- 4) To remove the Legend Window, select the **LEGEND** Softkey, the **ENT** or the **CLR** Key, or press the **FMS** Knob.

**Viewing legends for displayed weather products (on the Navigation Map Page):**

- 1) Select the Navigation Map Page.
- 2) Select the **MAP** Softkey.
- 3) Select the **LEGEND** Softkey (available if one or more SiriusXM Weather products are enabled for display).
- 4) To remove the Legend Window, select the **LEGEND** Softkey, or press the **ENT** or the **CLR** Key, or press the **FMS** Knob.

Additional information about the following can be displayed by panning over the display on the map:

- Echo Tops
- Cell Movement
- SIGMETs
- AIRMETs
- METARs
- County Warnings
- TFRs
- AIREPs
- PIREPs

The map panning feature is enabled by pressing the **RANGE** Knob. The map range is adjusted by turning the **RANGE** Knob. If the map range is adjusted while panning is enabled, the map is re-centered on the Map Pointer.

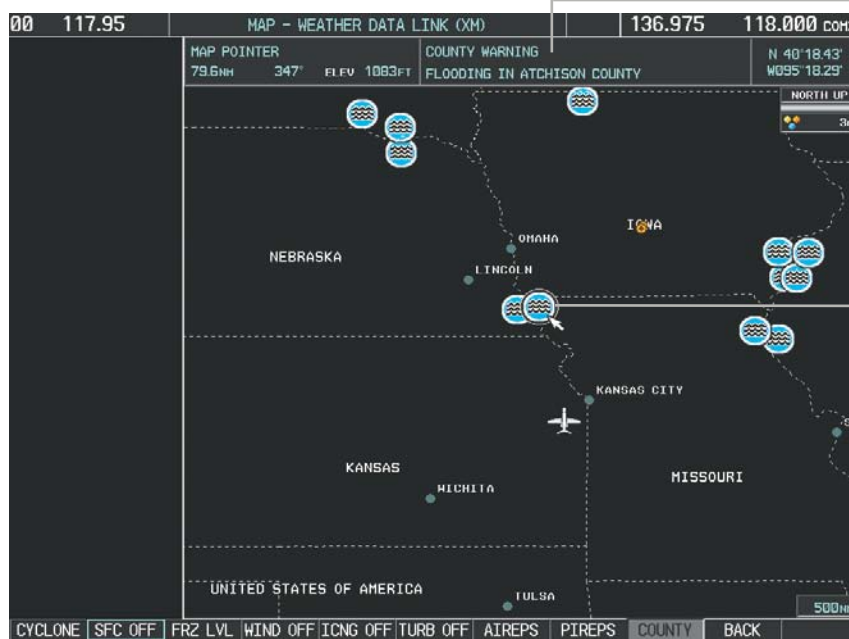

Additional Information on Weather Feature Selected with Map Pointer

Flash Flood Warning Selected with Map Pointer

Figure 6-9 Panning on the Weather Data Link (XM) Page

## NEXRAD



**NOTE:** NEXRAD cannot be displayed at the same time as terrain, echo tops, cloud tops, or turbulence data.

WSR-88D, or NEXRAD (NEXt-generation RADar), is a network of 158 high-resolution Doppler radar systems that are operated by the National Weather Service (NWS). NEXRAD data provides centralized meteorological information for the continental United States and selected overseas locations. The maximum range of a single NEXRAD radar site is 250 nm. In addition to a wide array of services, the NEXRAD network provides important information about severe weather and air traffic safety.

NEXRAD data is not real-time. The lapsed time between collection, processing, and dissemination of NEXRAD images can be significant and may not reflect the current radar synopsis. Due to the inherent delays and the relative age of the data, it should be used for long-range planning purposes only. Never use NEXRAD data or any radar data to penetrate hazardous weather.

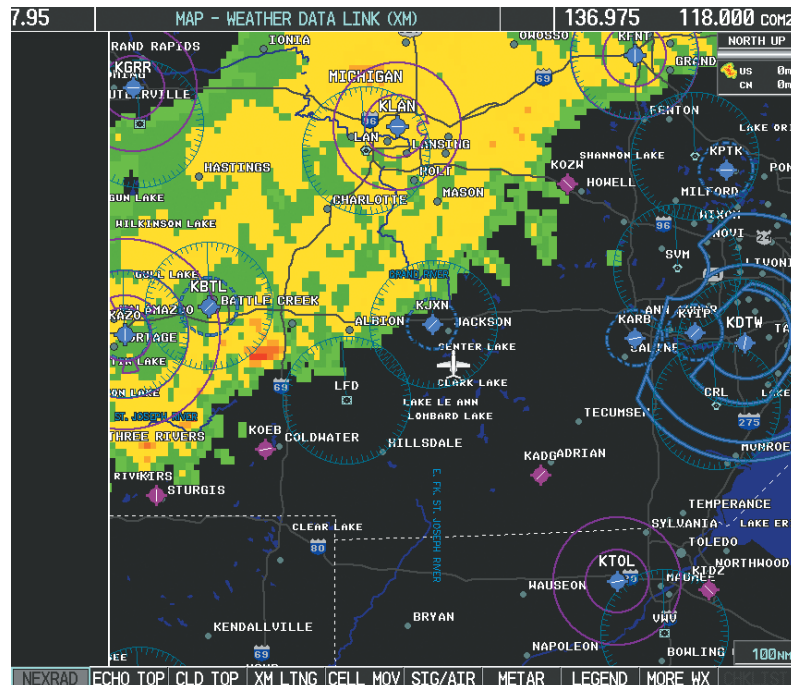

Figure 6-10 NEXRAD Data on the Weather Data Link (XM) Page

NEXRAD data can be displayed on the following maps:

- PFD Inset Map
- Navigation Map Page
- Weather Data Link (XM) Page
- Airport Information Page
- Trip Planning Page
- Nearest Pages
- Flight Plan Pages

#### Displaying NEXRAD weather information:

- 1) Select the **MAP** Softkey. This step is not necessary on the Weather Data Link (XM) Page.
- 2) Select the **NEXRAD** Softkey.

Composite data from all the NEXRAD radar sites in the United States is shown. This data is composed of the maximum reflectivity from the individual radar sweeps. The display of the information is color-coded to indicate the weather severity level. All weather product legends can be viewed on the Weather Data Link (XM) Page. For the NEXRAD legend (Figure 6-11), select the **LEGEND** Softkey when NEXRAD is selected for display.



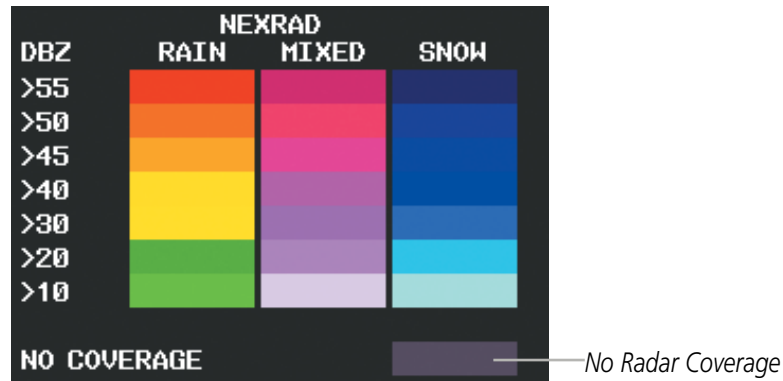

Figure 6-11 NEXRAD Legend

The display of radar coverage is always active when either NEXRAD or Echo Tops is selected. Areas where NEXRAD radar coverage and Echo Tops information is not currently available or is not being collected are indicated in gray shade of purple.

**REFLECTIVITY**

Reflectivity is the amount of transmitted power returned to the radar receiver. Colors on the NEXRAD display are directly correlative to the level of detected reflectivity. Reflectivity as it relates to hazardous weather can be very complex.

The role of radar is essentially to detect moisture in the atmosphere. Simply put, certain types of weather reflect radar better than others. The intensity of a radar reflection is not necessarily an indication of the weather hazard level. For instance, wet hail returns a strong radar reflection, while dry hail does not. Both wet and dry hail can be extremely hazardous.

The different NEXRAD echo intensities are measured in decibels (dB) relative to reflectivity (Z). NEXRAD measures the radar reflectivity ratio, or the energy reflected *back to* the radar receiver (designated by the letter Z). The value of Z increases as the returned signal strength increases.

**NEXRAD LIMITATIONS**

NEXRAD radar images may have certain limitations:

- NEXRAD base reflectivity does not provide sufficient information to determine cloud layers or precipitation characteristics (wet hail vs. rain). For example, it is not possible to distinguish between wet snow, wet hail, and rain.
- NEXRAD base reflectivity is sampled at the minimum antenna elevation angle. An individual NEXRAD site cannot depict high altitude storms at close ranges. It has no information about storms directly over the site.
- When zoomed in to a range of 30 nm, each square block on the display represents an area of four square kilometers. The intensity level reflected by each square represents the *highest* level of NEXRAD data sampled within the area (Figure 6-12).
- Below 52°N, if the type of precipitation is unavailable, the system displays the precipitation using the color codes associated with rain.

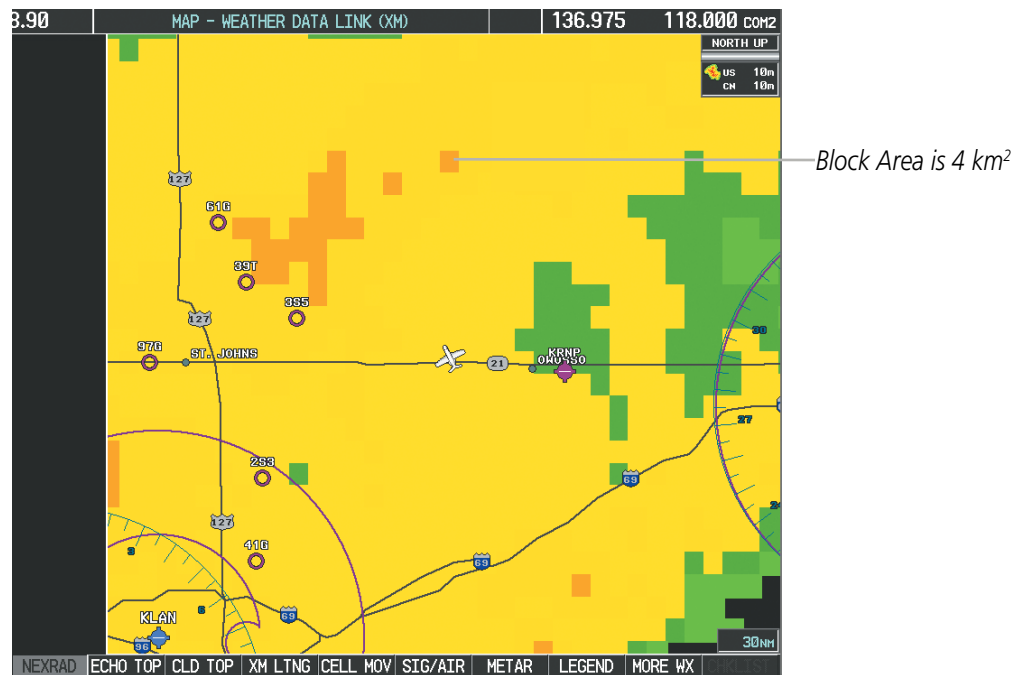

Figure 6-12 NEXRAD Data - Zoomed

The following may cause abnormalities in displayed NEXRAD radar images:

- Ground clutter
- Strokes and spurious radar data
- Sun strokes (when the radar antenna points directly at the sun)
- Interference from buildings or mountains, which may cause shadows
- Metallic dust from military aircraft, which can cause alterations in radar scans

### NEXRAD LIMITATIONS (CANADA)

- Radar coverage extends to 55°N.
- Any precipitation displayed between 52°N and 55°N is displayed as mixed regardless of actual precipitation type.
- Below 52°N, if the type of precipitation is unavailable, the system displays the precipitation using the color codes associated with rain.

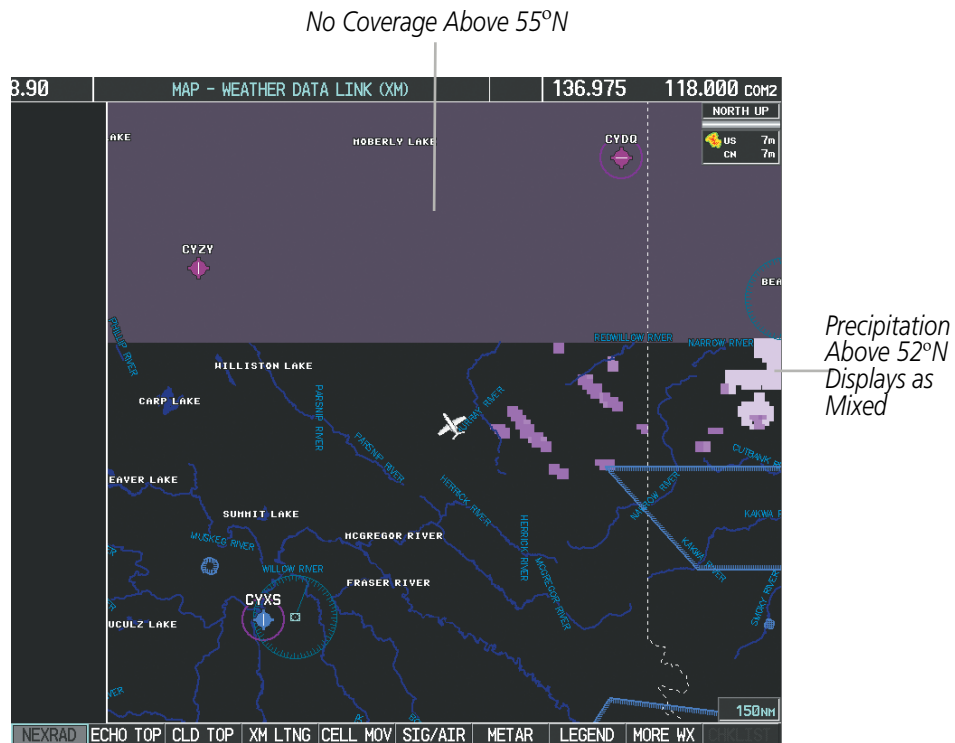

Figure 6-13 NEXRAD Data - Canada

## ECHO TOPS



**NOTE:** Echo Tops cannot be displayed at the same time as Cloud Tops or NEXRAD data.

Echo Tops data (Figure 6-14) shows the location, elevation, and direction of the highest radar echo. The highest radar echo does not indicate the top of a storm or clouds; rather it indicates the highest altitude at which precipitation is detected. Information is derived from NEXRAD data.

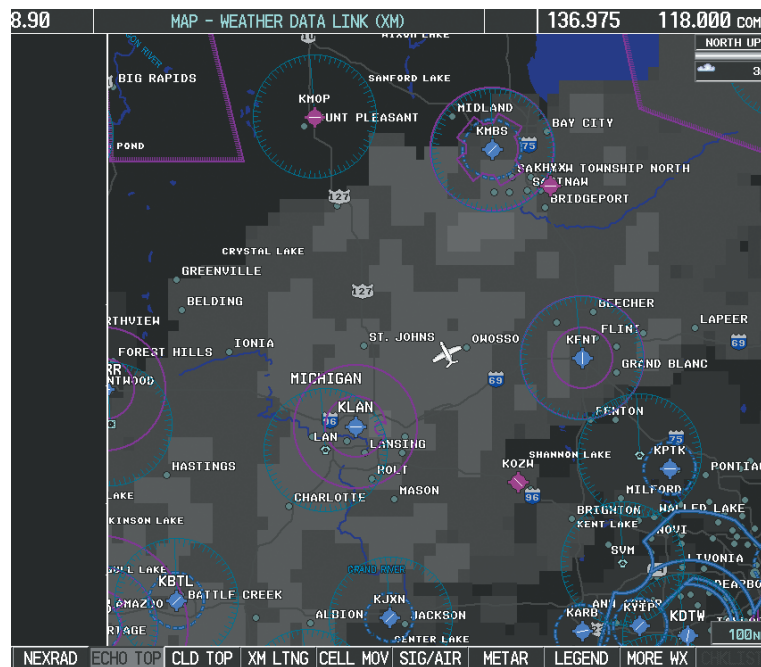

Figure 6-14 Echo Tops Data

### Displaying Echo Tops information:

- 1) Select the Weather Data Link (XM) Page.
- 2) Select the **ECHO TOP** Softkey.

To display the Echo Tops legend (Figure 6-15), select the **LEGEND** Softkey when Echo Tops is selected for display. Since Echo Tops and Cloud Tops use the same color scaling to represent altitude, display of these weather products is mutually exclusive. When Echo Tops is activated, NEXRAD and Cloud Tops data are removed.

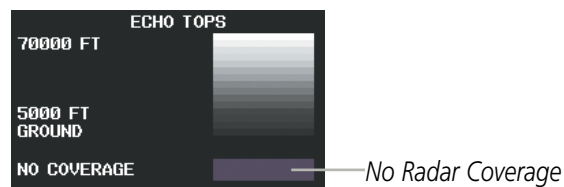

Figure 6-15 Echo Tops Legend

The display of radar coverage is always active when either NEXRAD or ECHO TOPS is selected. Areas where NEXRAD radar coverage and Echo Tops information is not currently available or is not being collected are indicated in gray shade of purple.

**CLOUD TOPS**



**NOTE:** *Cloud Tops and Echo Tops cannot be displayed at the same time.*

Cloud Tops data (Figure 6-16) depicts cloud top altitudes as determined from satellite imagery.

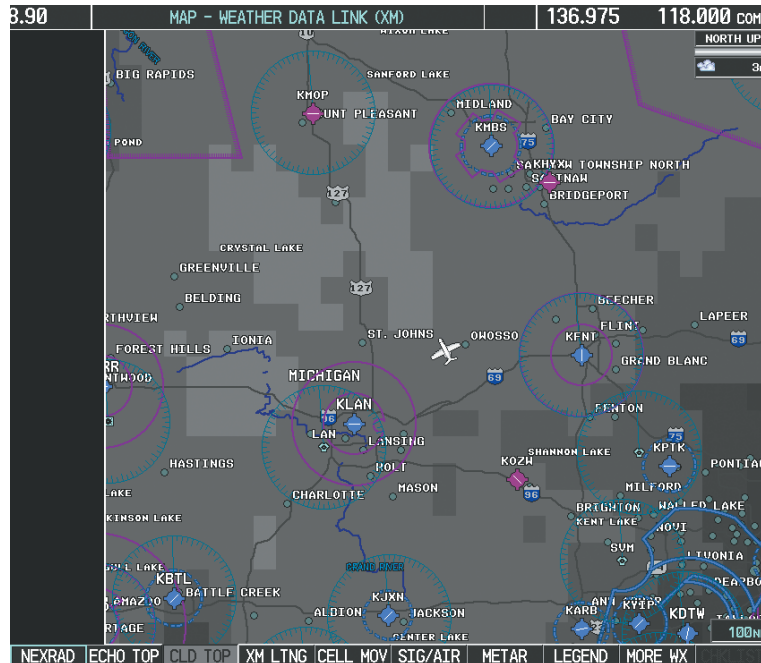
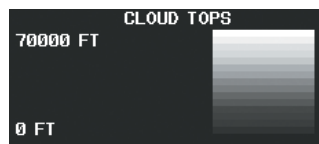

**Figure 6-16 Cloud Tops Data**

**Displaying Cloud Tops information:**

- 1) Select the Weather Data Link (XM) Page.
- 2) Select the **CLD TOP** Softkey.

To display the Cloud Tops legend (Figure 6-17), select the **LEGEND** Softkey when Cloud Tops is selected for display. Since Cloud Tops and Echo Tops use the same color scaling to represent altitude, display of these weather products is mutually exclusive. When Cloud Tops is activated, Echo Tops data is removed.



**Figure 6-17 Cloud Tops Legend**

## SIRIUSXM LIGHTNING

SiriusXM Lightning data (Figure 6-18) shows the approximate location of cloud-to-ground lightning strikes. A strike icon represents a strike that has occurred within a two-kilometer region. The exact location of the lightning strike is not displayed.

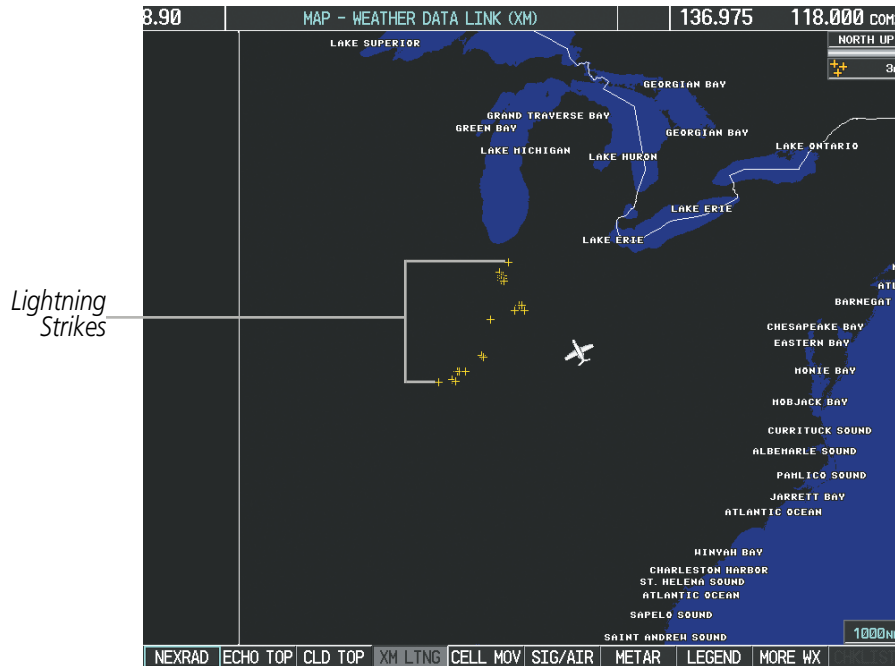

Figure 6-18 SiriusXM Lightning Data

SiriusXM Lightning data displays on the following maps:

- PFD Inset Map
- Navigation Map Page
- Weather Data Link (XM) Page
- Trip Planning Page
- Nearest Pages
- Flight Plan Pages

### Displaying SiriusXM Lightning information:

- 1) Select the **MAP** Softkey. This step is not necessary on the Weather Data Link (XM) Page.
- 2) Select the **XM LTNG** Softkey.

To display the SiriusXM Lightning legend on the Weather Data Link (XM) Page (Figure 6-19), select the **LEGEND** Softkey when SiriusXM Lightning is selected for display.



Figure 6-19 Lightning Legend

### CELL MOVEMENT

Cell Movement data (Figure 6-20) shows the location and movement of storm cells as identified by the ground-based system. Cells are represented by yellow squares, with direction of movement indicated with short, orange arrows.

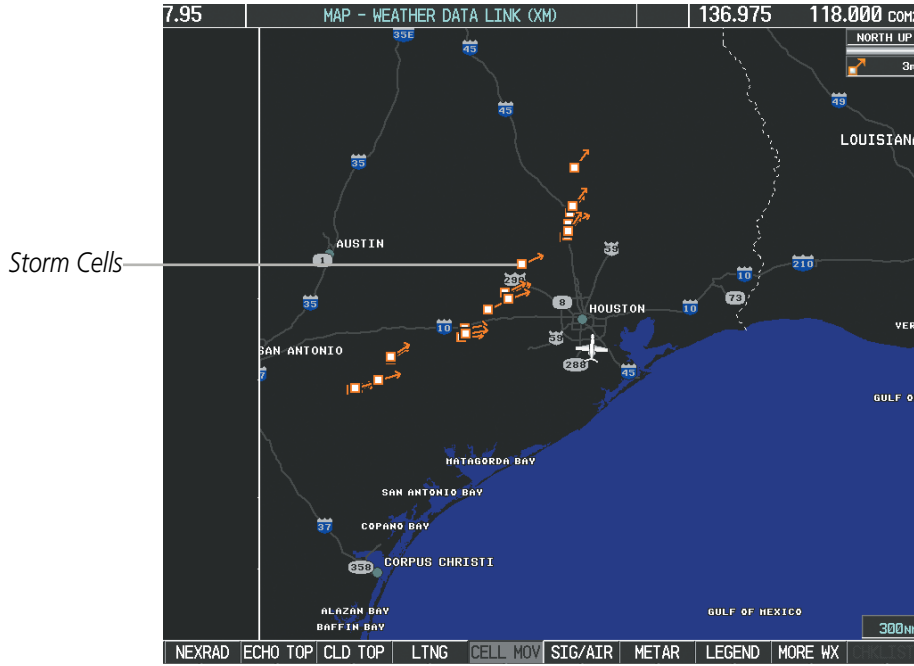

Figure 6-20 Cell Movement Data

On most applicable maps, Cell Movement data is selected for display along with NEXRAD. On the Weather Data Link (XM) Page, Cell Movement data can be selected independently. Cell Movement data can be displayed on the following maps:

- PFD Inset Map
- Navigation Map
- AUX - Trip Planning Page
- Nearest Pages

**Displaying Cell Movement information:**

- 1) Select the **MAP** Softkey. This step is not necessary on the Weather Data Link (XM) Page.
- 2) Select the **NEXRAD** Softkey (**CEL MOV** Softkey on the Weather Data Link (XM) Page). For Cell Movement to be displayed on maps other than the Weather Data Link (XM) Page, Cell Movement must be turned on in the Navigation Map Setup Menu (see the procedure 'Setting up and customizing weather data for the Navigation Map Page').

To display the Cell Movement legend on the Weather Data Link (XM) Page, (Figure 6-21), select the **LEGEND** Softkey when Cell Movement is selected for display.

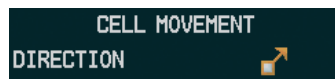

Figure 6-21 Cell Movement Legend



## SIGMETS AND AIRMETS

SIGMET (SIGNificant METeorological Information) and AIRMET (AIRmen's METeorological Information) are issued for potentially hazardous weather. A Convective SIGMET is issued for hazardous convective weather such as severe or widespread thunderstorms.

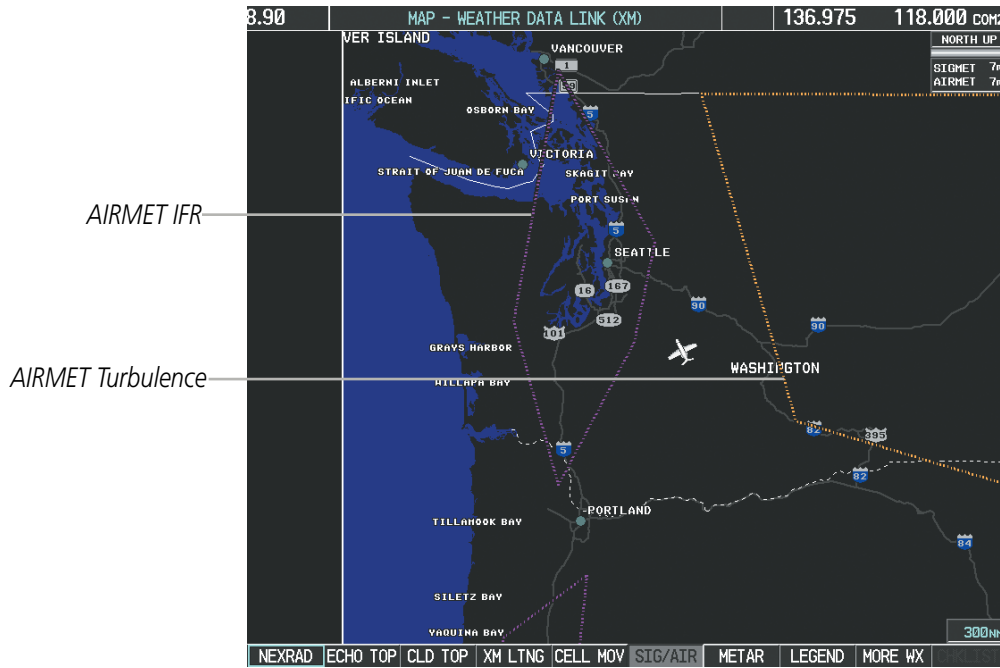

Figure 6-22 SIGMET/AIRMET Data

### Displaying SIGMETs and AIRMETS:

- 1) Select the Weather Data Link (XM) Page.
- 2) Select the **SIG/AIR** Softkey.
- 3) To view the text of the SIGMET or AIRMET, press the **RANGE** Knob and move the Map Pointer over the icon.
- 4) Press the **ENT** key. Figure 6-23 shows sample SIGMET text.

To display the SIGMET and AIRMET legend (Figure 6-24), select the **LEGEND** Softkey when SIGMETs and AIRMETS are selected for display.

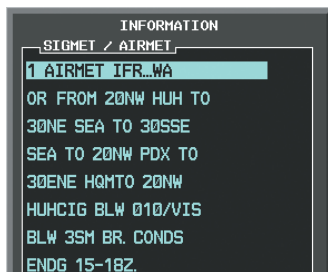

Figure 6-23 Sample SIGMET Text



Figure 6-24 SIGMET/AIRMET Legend

## METARS AND TAFS

**NOTE:** Atmospheric pressure as reported for METARs is given in hectopascals (hPa), except for in the United States, where it is reported in inches of mercury (in Hg). Temperatures are reported in Celsius.

**NOTE:** METAR information is only displayed within the installed navigation database service area.

METARs (METEorological Aerodrome Reports) typically contain information about the temperature, dewpoint, wind, precipitation, cloud cover, cloud base heights, visibility, and barometric pressure at an airport or observation station. They can also contain information on precipitation amounts, lightning, and other critical data. METARs reflect hourly observations; non-routine updates include the code “SPECI” in the report. METARs are shown as colored flags at airports that provide them.

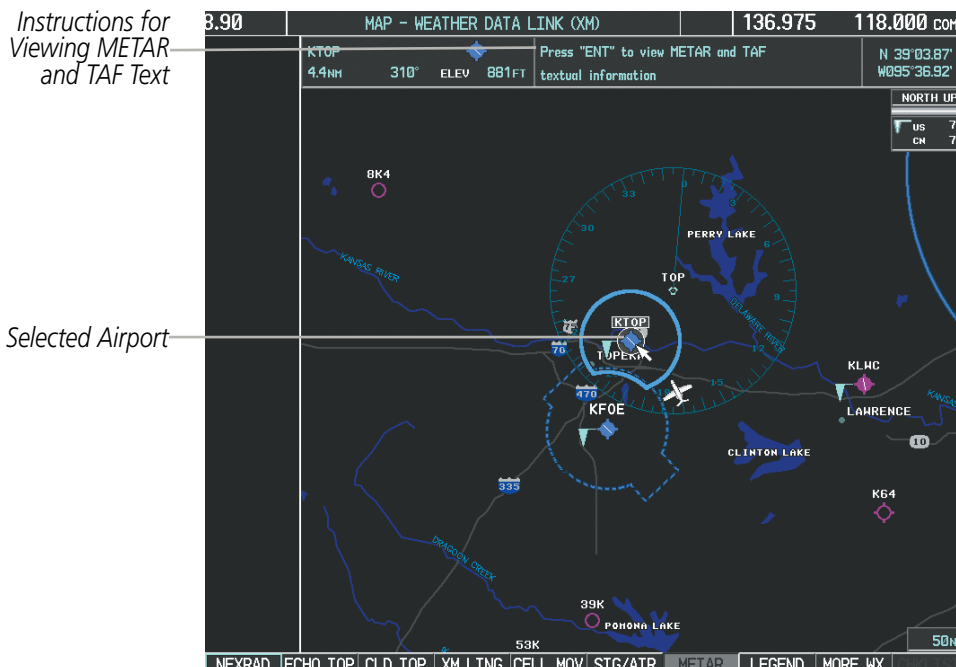

Figure 6-25 METAR Flags on the Weather Data Link Page

TAFs (Terminal Aerodrome Forecasts) are weather predictions for specific airports within a 24- hour period, and may span up to 36 hours. TAFs typically include forecast wind, visibility, weather phenomena, and sky conditions using METAR codes.

METAR and TAF text are displayed on the Weather Information Page. METAR data is displayed first in a decoded fashion, then as raw text. TAF information is displayed only in its raw form when it is available

### Displaying METAR and TAF text:

- 1) On the Weather Data Link (XM) Page, select the **METAR** Softkey.
- 2) Press the **RANGE** Knob and pan to the desired airport.
- 3) Press the **ENT** Key. The Weather Information Page is shown with METAR and TAF text.

- 4) Use the **FMS** Knob or the **ENT** Key to scroll through the METAR and TAF text. METAR text must be completely scrolled through before scrolling through the TAF text.
- 5) Press the **FMS** Knob or the **CLR** Key to return to the Weather Data Link (XM) Page.
 

Or:

  - 1) Select the Weather Information Page.
    - a) Turn the large **FMS** Knob to select the Waypoint Page Group.
    - b) Select the **WX** Softkey to select the Weather Information Page.
  - 2) Press the **FMS** Knob to display the cursor.
  - 3) Use the **FMS** Knob to enter the desired airport and press the **ENT** Key.
  - 4) Use the **FMS** Knob or the **ENT** Key to scroll through the METAR and TAF text. Note that the METAR text must be completely scrolled through before scrolling through the TAF text.



Figure 6-26 METAR and TAF Text on the Weather Information Page

Raw METAR text is also accessible while panning the map cursor over a METAR flag on any map page on which a METAR is displayed. The METAR text is shown in a box near the METAR flag.

In addition, METAR flags and their associated text are displayed on the Active Flight Plan Page on the MFD. METAR flags appears next to waypoints in the flight plan with an associated METAR.

#### Displaying raw METAR text on the Active Flight Plan Page:

- 1) Select the Active Flight Plan Page on the MFD.
- 2) Press the **FMS** Knob to activate the cursor.
- 3) Turn the large **FMS** Knob to highlight the desired waypoint. The METAR text will appear in the 'SELECTED WAYPOINT WEATHER' window below.
- 4) When finished, press the **FMS** Knob to remove the cursor or press the **FPL** Key to exit the Active Flight Plan Page.

To display the METAR legend on the Weather Data Link (XM) Page (Figure 6-27), select the **LEGEND** Softkey when METARs are selected for display.

The METAR flag color is determined by the information in the METAR text. A gray METAR flag is displayed when the METAR text does not contain adequate information.

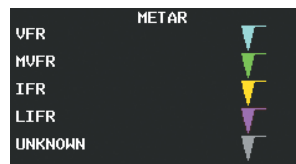

Figure 6-27 METAR Legend

## SURFACE ANALYSIS AND CITY FORECAST



**NOTE:** Surface Analysis and City Forecast data are displayed only within the installed navigation database coverage area.

Surface Analysis and City Forecast information is available for current and forecast weather conditions. Forecasts are available for intervals of 12, 24, 36, and 48 hours.

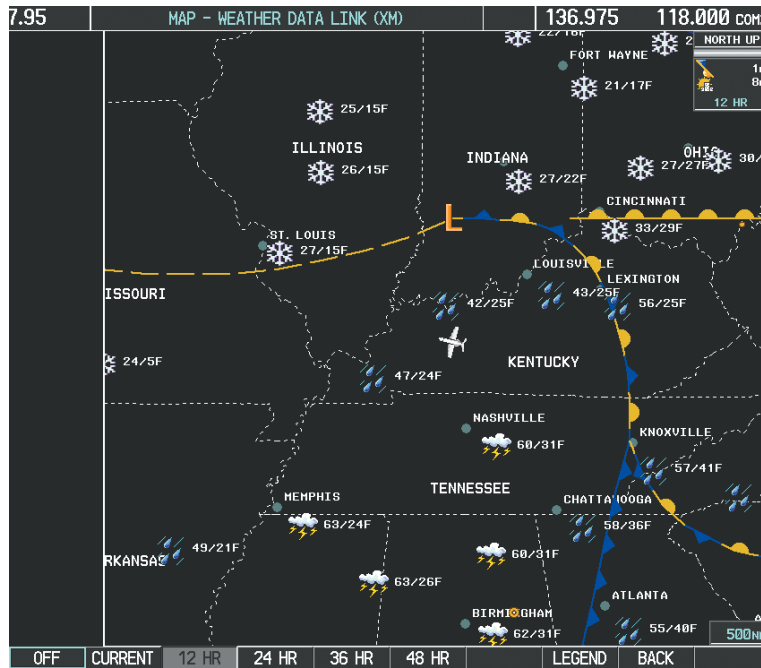

Figure 6-28 12 Hour Surface Analysis and City Forecast Data

### Displaying Surface Analysis and City Forecast information:

- 1) Select the Weather Data Link (XM) Page.
- 2) Select the **MORE WX** Softkey.
- 3) Select the **SFC** Softkey.
- 4) Select the desired forecast time: **CURRENT, 12 HR, 24 HR, 36 HR,** or **48 HR**. The **SFC** Softkey label changes to reflect the forecast time selected.

To display the Surface Analysis and City Forecast legend (Figure 6-29), select the **LEGEND** Softkey when the Surface Analysis and City Forecast weather product is displayed.

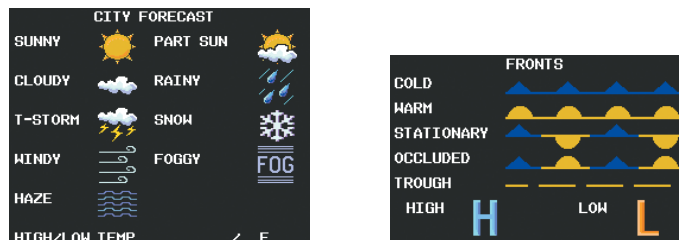

Figure 6-29 Surface Analysis Legend

### FREEZING LEVELS

Freezing Level data shows the color-coded contour lines for the altitude and location at which the first isotherm is found (Figure 6-30). When no data is displayed for a given altitude, the data for that altitude has not been received, or is out of date and has been removed from the display. New data will appear when it is available.

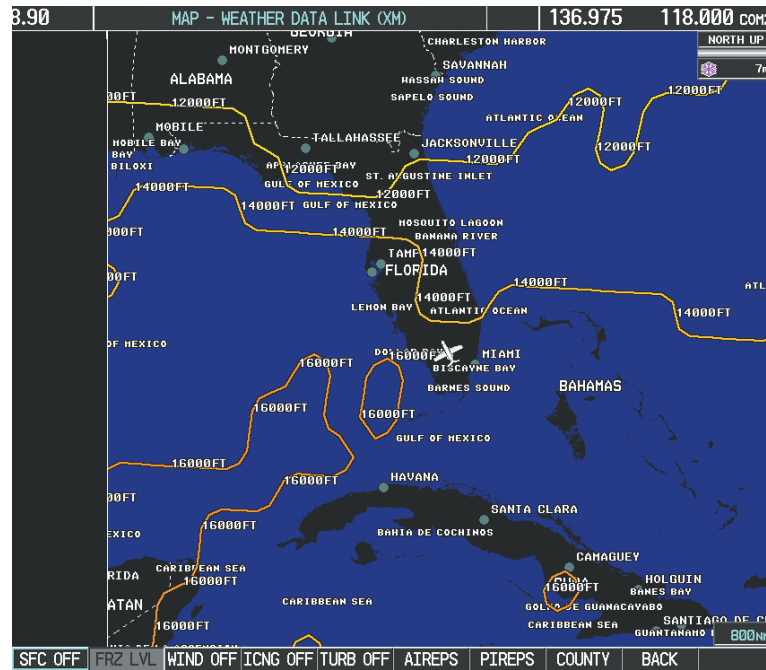

Figure 6-30 Freezing Level Data

#### Displaying Freezing Level information:

- 1) Select the Weather Data Link (XM) Page.
- 2) Select the **MORE WX** Softkey.
- 3) Select the **FRZ LVL** Softkey.

To display the Freezing Level legend (Figure 6-31), select the **LEGEND** Softkey when Freezing Level data is displayed.



Figure 6-31 Freezing Level Legend

## WINDS ALOFT

Winds Aloft data (Figure 6-32) shows the predicted wind speed and direction at the surface and at selected altitudes. Altitude can be displayed in 3,000-foot increments from the surface up to 42,000 feet MSL.

### Displaying Winds Aloft data:

- 1) Select the Weather Data Link (XM) Page.
- 2) Select the **MORE WX** Softkey.
- 3) Select the **WIND** Softkey.
- 4) Select the desired altitude level: SFC (surface) up to 42,000 feet. Select the **NEXT** or **PREV** Softkey to cycle through the altitude softkeys. The **WIND** Softkey label changes to reflect the altitude selected.

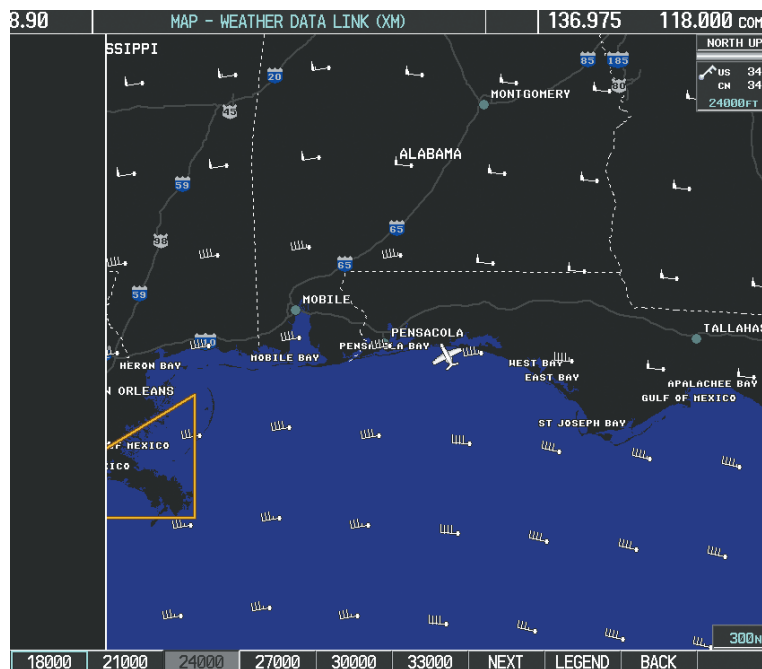

Figure 6-32 Winds Aloft Data at 24,000 Feet

To display the Winds Aloft legend (Figure 6-33), select the **LEGEND** Softkey when Winds Aloft is selected for display.

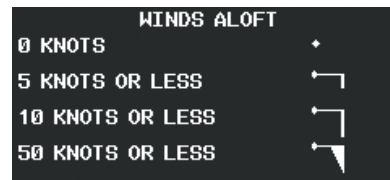
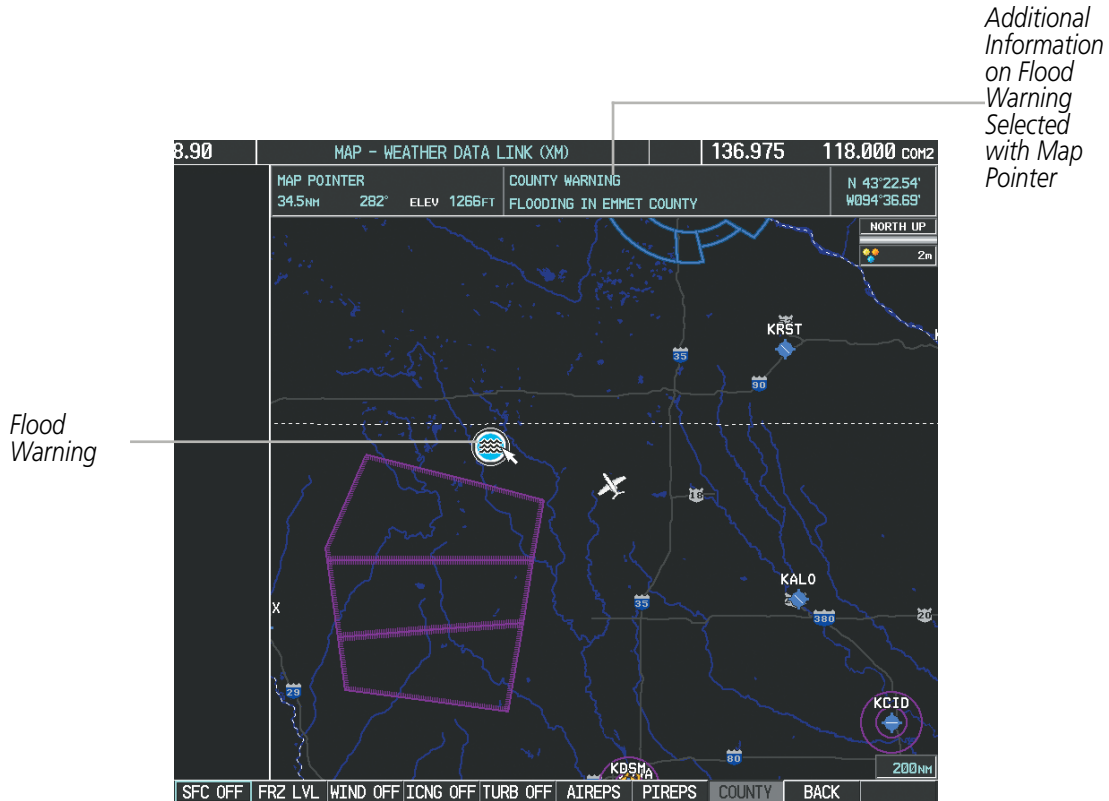

Figure 6-33 Winds Aloft Data with Legend



**COUNTY WARNINGS**

County data (Figure 6-34) provides specific public awareness and protection weather warnings from the National Weather Service (NWS). This can include information on tornadoes, severe thunderstorms, and flood conditions.

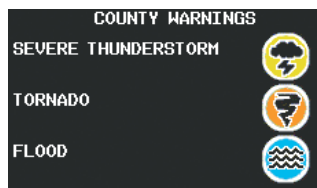

**Figure 6-34 County Flood Warning**

**Displaying County Warning information:**

- 1) Select the Weather Data Link (XM) Page.
- 2) Select the **MORE WX** Softkey.
- 3) Select the **COUNTY** Softkey.

To display the County Warnings legend (Figure 6-35), select the **LEGEND** Softkey when County Warnings are selected to be displayed.



**Figure 6-35 County Warnings Legend**

## CYCLONE

The Cyclone weather product (Figure 6-36) shows the current location of cyclones (hurricanes), tropical storms, and their projected tracks.



Figure 6-36 Cyclone Data Selected for Display

### Displaying cyclone (hurricane) track information:

- 1) Select the Weather Data Link (XM) Page.
- 2) Select the **MORE WX** Softkey.
- 3) Select the **CYCLONE** Softkey.

To display the Cyclone legend (Figure 6-37), select the **LEGEND** Softkey when Cyclones are selected to be displayed.

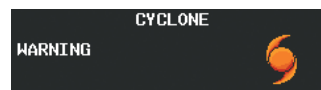

Figure 6-37 Cyclone Legend

**ICING (CIP & SLD)**

Current Icing Product (CIP) data shows a graphical view of the current icing environment (Figure 6-38). Icing severity is displayed in four categories: light, moderate, severe, and extreme (not specific to aircraft type). The CIP product is not a forecast, but a presentation of the current conditions at the time of the analysis.

Supercooled Large Droplet (SLD) icing conditions are characterized by the presence of relatively large, super cooled water droplets indicative of freezing drizzle and freezing rain aloft. SLD threat areas are depicted as magenta dots over the CIP colors.

**Displaying Icing data:**

- 1) Select the Weather Data Link (XM) Page.
- 2) Press the **MORE WX** Softkey.
- 3) Press the **ICNG** Softkey.
- 4) Select the desired altitude level: 1,000 feet up to 30,000 feet. Press the **NEXT** or **PREV** Softkey to cycle through the altitude softkeys. The **ICNG** Softkey label changes to reflect the altitude selected.

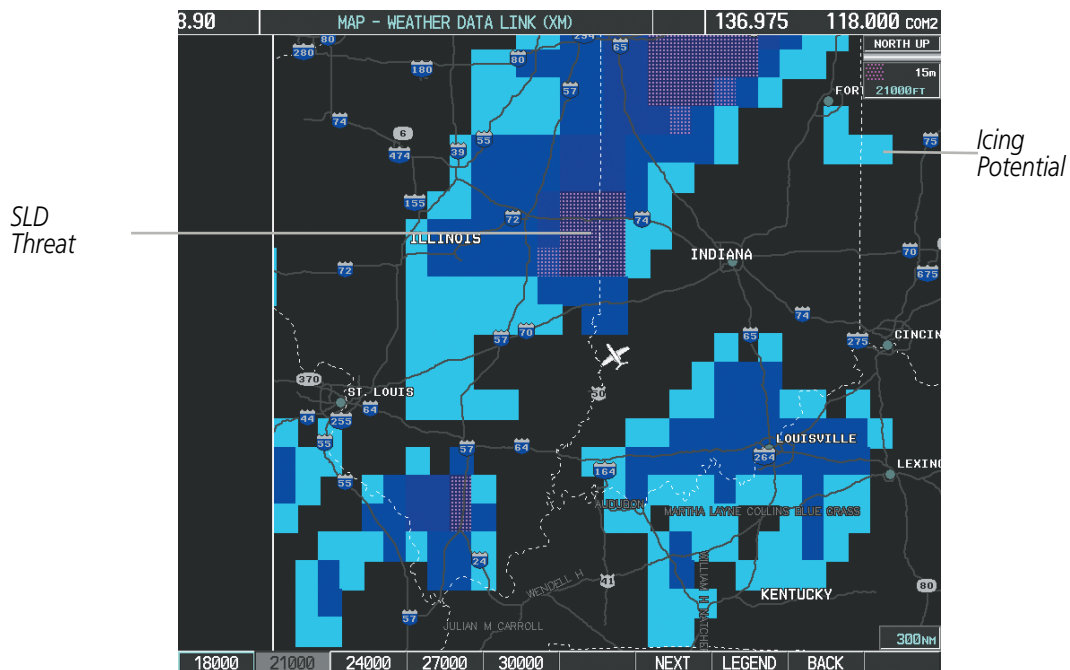

**Figure 6-38 Icing Data at 21,000 Feet**

To display the Icing Potential legend (Figure 6-39), press the **LEGEND** Softkey when Icing is selected for display.

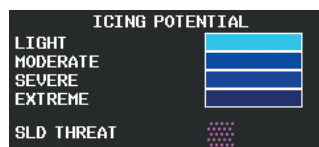

**Figure 6-39 Icing Potential Legend**

## TURBULENCE

Turbulence data (Figure 6-40) identifies the potential for erratic movement of high-altitude air mass associated winds. Turbulence is classified as light, moderate, severe or extreme, at altitudes between 21,000 and 45,000 feet. Turbulence data is intended to supplement AIRMETs and SIGMETs.

### Displaying Turbulence data:

- 1) Select the Weather Data Link (XM) Page.
- 2) Select the **MORE WX** Softkey.
- 3) Select the **TURB** Softkey.
- 4) Select the desired altitude level: 21,000 feet up to 45,000 feet. Select the **NEXT** or **PREV** Softkey to cycle through the altitude softkeys. The **TURB** Softkey label changes to reflect the altitude selected.

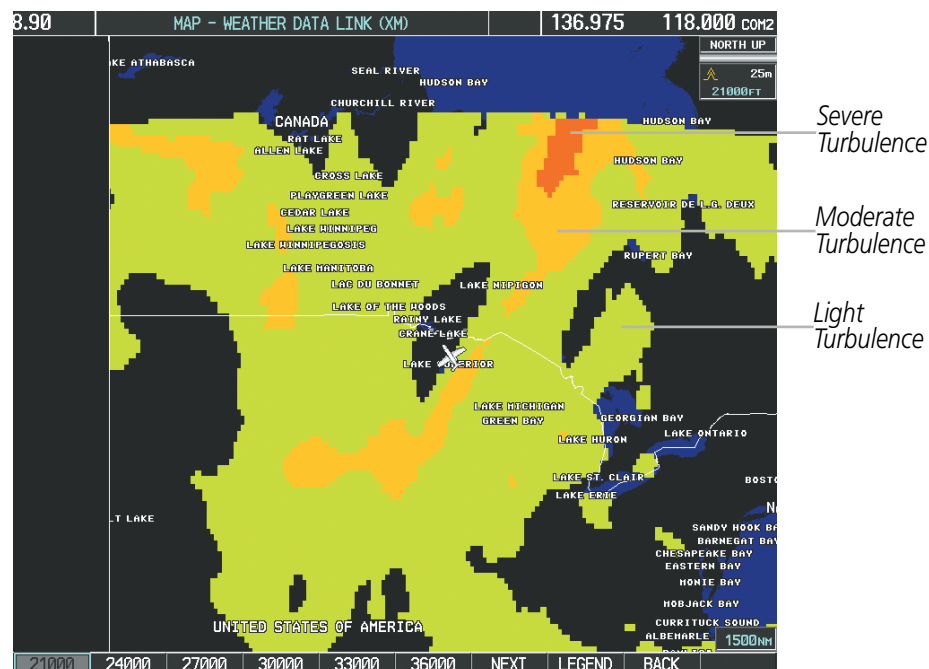

Figure 6-40 Turbulence Data at 21,000 Feet

To display the Turbulence legend (Figure 6-41), select the **LEGEND** Softkey when Turbulence is selected for display.



Figure 6-41 Turbulence Legend

## PIREPS AND AIREPS

Pilot Weather Reports (PIREPs) describe in-flight weather encountered by pilots. When significant weather conditions are reported or forecast, Air Traffic Control (ATC) facilities are required to solicit PIREPs. A PIREP may contain adverse weather conditions, such as low in-flight visibility, icing conditions, wind shear, turbulence, and type of aircraft flown. PIREPs are issued as either Routine (UA) or Urgent (UUA).

Another type of PIREP is an Air Report (AIREP). AIREPs are used almost exclusively by commercial airlines.

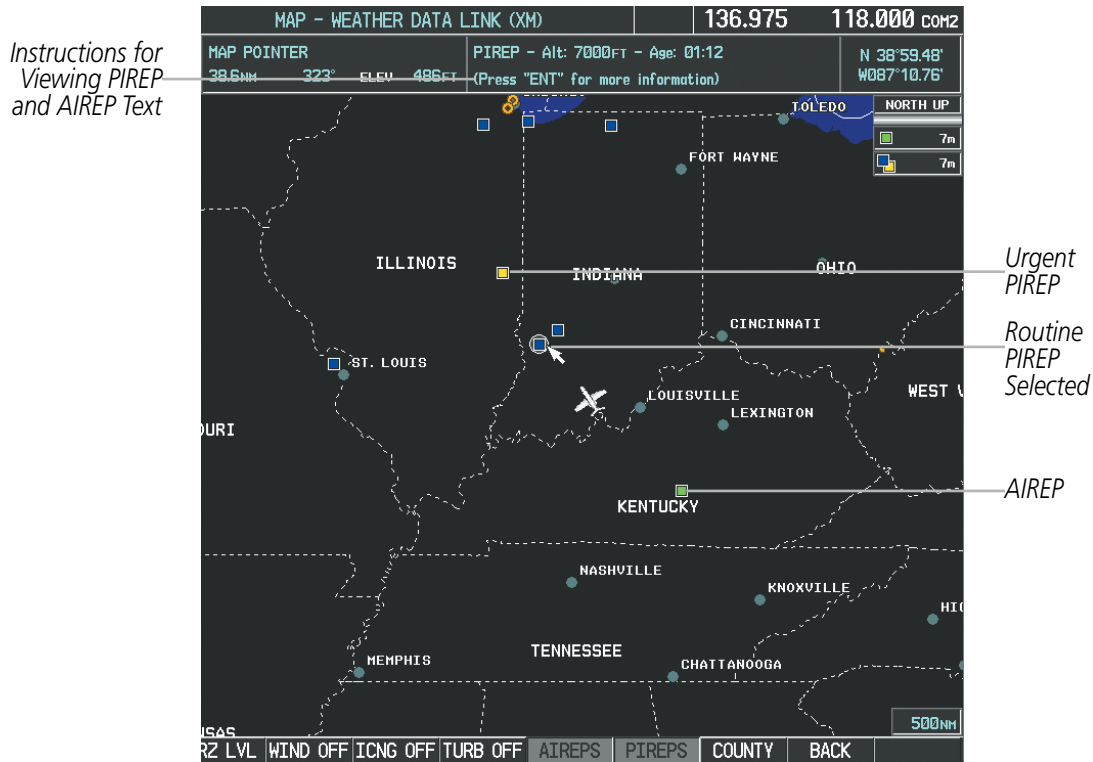

Figure 6-42 AIREPs and PIREPs on the Weather Data Link (XM) Page

### Displaying PIREP and AIREP text:

- 1) Select the Weather Data Link (XM) Page.
- 2) Select the **MORE WX** Softkey.
- 3) Select the **AIREPS** or **PIREPS** Softkey.
- 4) Press the **RANGE** Knob and pan to the desired weather report. A gray circle will appear around the weather report when it is selected.
- 5) Press the **ENT** Key. The Weather Information Page is shown with PIREP or AIREP text. The data is first displayed in a decoded fashion, then as raw text.
- 6) Use the **FMS** Knob or the **ENT** Key to scroll through the PIREP or AIREP text.
- 7) Press the **FMS** Knob or the **CLR** Key to return to the Weather Data Link (XM) Page.

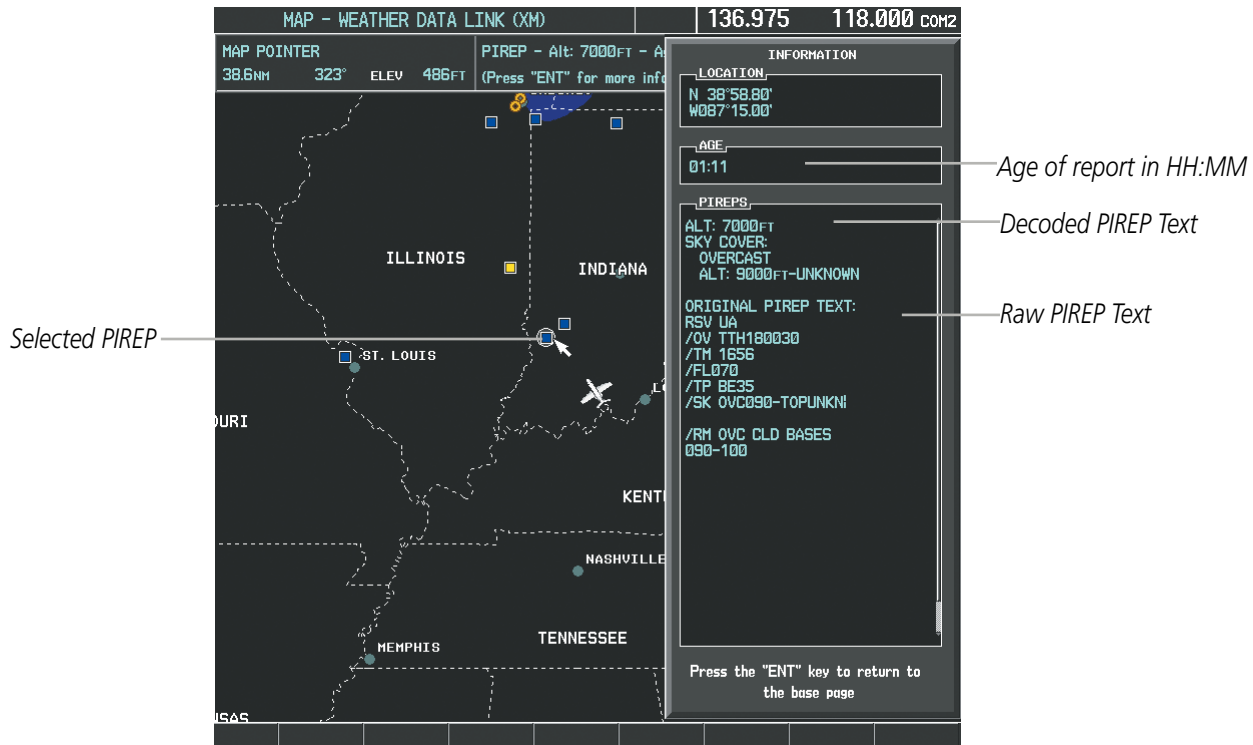

Figure 6-43 PIREP Text on the Weather Information Page

To display the PIREP or AIREP legend (Figure 6-44), select the **LEGEND** Softkey when PIREPs or AIREPs are selected for display.

The PIREP color is determined by the type (routine or urgent).

AIREPS	
ALL AIREPS	<span style="color: green;">■</span>
PIREPS	
URGENT	<span style="color: yellow;">■</span>
ROUTINE	<span style="color: blue;">■</span>

Figure 6-44 AIREPs & PIREPs Legend

TFRS

In the United States, the Federal Aviation Administration (FAA) issues Temporary Flight Restrictions (TFRs) to designate areas where flight is restricted. TFRs are issued to restrict flight for a variety of reasons including national security, law enforcement, firefighting, natural disasters, airshows, and large sporting events. TFRs may be issued at any time, and TFR data displayed is only intended to supplement official TFR information obtained from Flight Service Stations (FSS), and air traffic control.

The age of TFR data is not shown; however, if TFR data is not available or has expired, the system displays 'TFR N/A' in the upper-left corner of maps on which TFRs can be displayed.

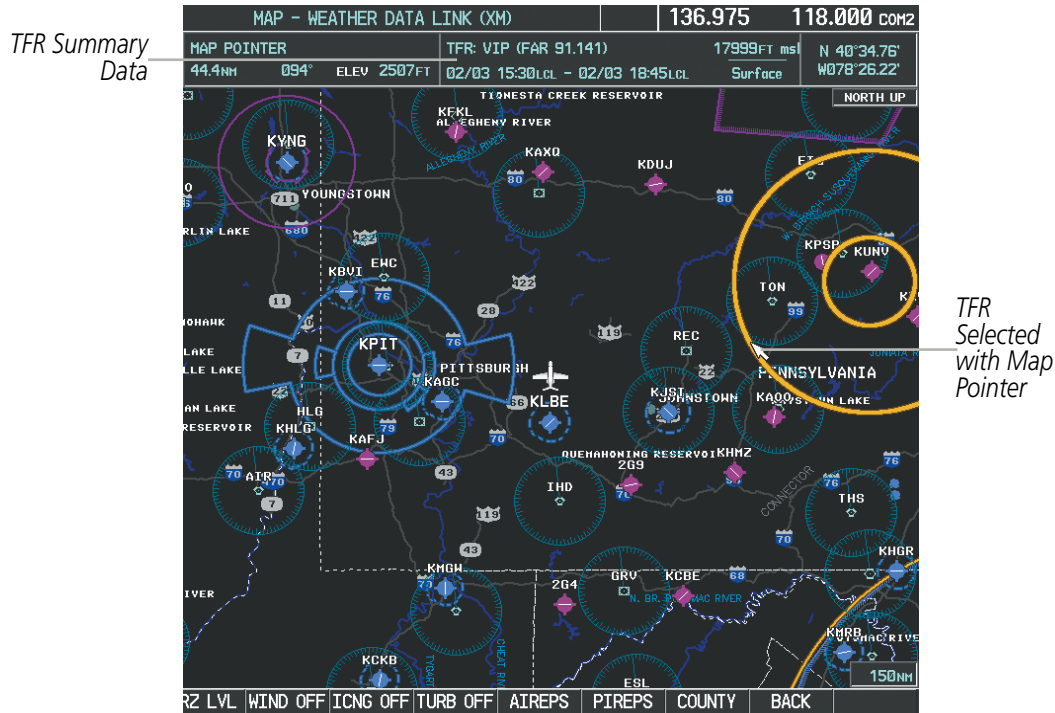

Figure 6-45 TFR Data on the Weather Data Link (XM) Page

Displaying TFR Data:

- 1) Select the Weather Data Link (XM) Page or Navigation Map Page.
- 2) Press the **RANGE** Knob and pan the map pointer over a TFR to highlight it. The system displays TFR summary information above the map.
- 3) Press the **ENT** Key. The system displays a pop-up menu.
- 4) If necessary, turn the **FMS** Knob to select 'Review Airspaces' and press the **ENT** Key. The system displays the TFR Information window.
- 5) Press the **FMS** Knob or the **CLR** Key to remove the TFR Information window.



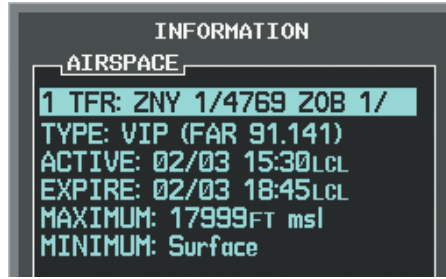

Figure 6-46 Full Text for Selected TFR

The setup menus for the Navigation Map Page control the map range settings above which TFR data is decluttered from the display. If a map range larger than the TFR product map range setting is selected, the TFR product data is removed from the map.

Maps other than the Navigation Map Page use settings based on those selected for the Navigation Map Page.

**Setting up and customizing TFR data for maps on which TFR data can be displayed:**

- 1) Select the Navigation Map Page.
- 2) Press the **MENU** Key.
- 3) With Map Setup highlighted, press the **ENT** Key (Figure 6-47).
- 4) Turn the small **FMS** Knob to select the Aviation Group and press the **ENT** Key (Figure 6-48).
- 5) Turn the large **FMS** Knob to scroll to the TFR product range setting (Figure 6-49).
- 6) Turn the small **FMS** Knob to scroll through options (Off, range settings).
- 7) Press the **ENT** Key to select an option.
- 8) Press the **FMS** Knob or **CLR** Key to return to the Navigation Map Page with the changed settings.

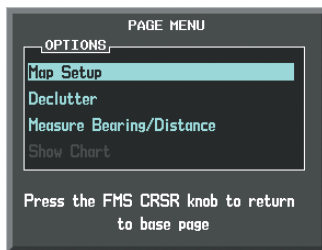

Figure 6-47 Navigation Map Page Menu

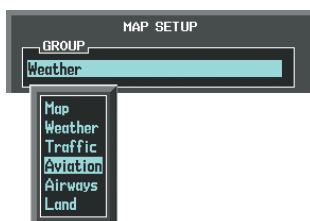

Figure 6-48 Navigation Map Page Setup Menu

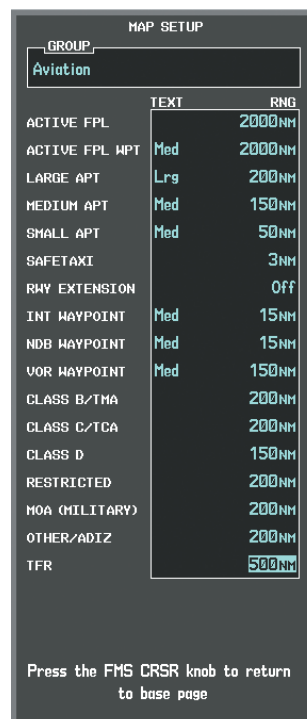

Figure 6-49 Navigation Map Page Setup Menu, Weather Group

## 6.2 AIRBORNE COLOR WEATHER RADAR

### SYSTEM DESCRIPTION

---

The Garmin GWX 68 Airborne Color Weather Radar is a 4-color digital pulsed radar with 6.5 kilowatts of output power. It combines excellent range and adjustable scanning profiles with a high-definition target display. The pulse width is four microseconds ( $\mu\text{s}$ ) on all ranges except the 2.5 nm range. The GWX 68 uses a one  $\mu\text{s}$  pulse width at this range to reduce the targets smearing together on the display for better target definition at close range.

The Embraer Phenom 300 uses a 12-inch phased array antenna that is fully stabilized to accommodate 30° of pitch and roll.

To focus radar scanning on specific areas, Sector Scanning offers pilot-adjustable horizontal scan angles of 20°, 40°, 60°, or 90°. A vertical scanning function helps to analyze storm tops, gradients, and cell buildup activity at various altitudes.

Radar features include:

- Extended Sensitivity Time Constant (STC) logic that automatically correlates distance of the return echo with intensity, so cells do not suddenly appear to get larger as they get closer.
- WATCH<sup>®</sup> (Weather ATtenuated Color Highlight) helps identify possible shadowing effects of short-range cell activity, identifying areas where radar return signals are weakened or attenuated by intense precipitation (or large areas of lesser precipitation) and may not fully reflect the weather behind a storm.
- Weather Alert that looks ahead for intense cell activity in the 80-320 nm range, even if these ranges are not being monitored.

### PRINCIPLES OF PULSED AIRBORNE WEATHER RADAR

---

The term RADAR is an acronym for RAdio Detecting And Ranging. Pulsed radar locates targets by transmitting a microwave pulse beam that, upon encountering a target, is reflected back to the radar receiver as a return echo. The microwave pulses are focused and radiated by the antenna, with the most intense energy in the center of the beam and decreasing intensity near the edge. The same antenna is used for both transmitting and receiving. The returned signal is then processed and displayed on the MFD.

Radar detection is a two-way process that requires 12.36  $\mu\text{s}$  for the transmitted microwave pulses to travel out and back for each nautical mile of target range. It takes 123.6  $\mu\text{s}$  for a transmitted pulse to make the round trip if a target is ten nautical miles away.

Airborne weather radar should be used to avoid severe weather, not for penetrating severe weather. The decision to fly into an area of radar targets depends on target intensity, spacing between the targets, aircraft capabilities, and pilot experience. Pulse type weather radar detects only precipitation, not clouds or turbulence. The display may indicate clear areas between intense returns, but this does not necessarily mean it is safe to fly between them. Only Doppler radar can detect turbulence.

Airborne weather radar has other capabilities beyond weather detection. It also has the ability to detect and provide distance to cities, mountains, coastlines, rivers, lakes, and oceans.

## NEXRAD AND AIRBORNE WEATHER RADAR

Both Airborne Weather Radar and NEXRAD measure weather reflectivity in decibels (dB). A decibel is a logarithmic expression of the ratio of two quantities. Airborne Weather Radar measures the ratio of power against the gain of the antenna, while NEXRAD measures the energy reflected back to the radar, or the radar reflectivity ratio.

Both systems use colors to identify the different echo intensities, but the colors are not interchangeable. Airborne color radar values used by Garmin Airborne Color Weather Radar should not be confused with NEXRAD radar values.

## ANTENNA BEAM ILLUMINATION

The radar beam is much like the beam of a spotlight. The further the beam travels, the wider it becomes. The radar is only capable of seeing what is inside the boundaries of the beam. The figure below depicts a radar beam's characteristics. The figure illustrates vertical dimensions of the radar beam, although the same holds true for the horizontal dimensions. In other words, the beam is as wide as it is tall. Note that it is possible to miss areas of precipitation on the radar display because of the antenna tilt setting. With the antenna tilt set to zero in this illustration, the beam overshoots the precipitation at 15 nautical miles.

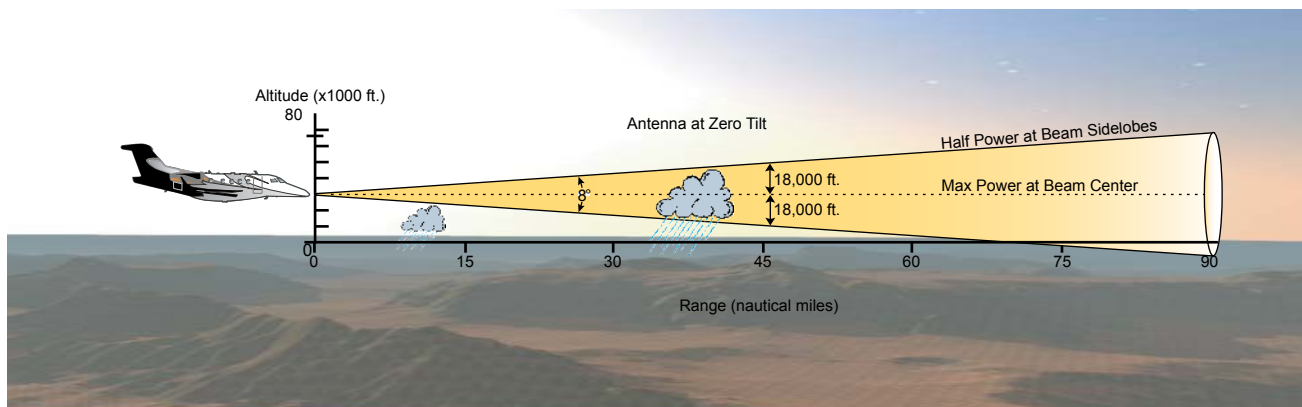

Figure 6-50 Radar Beam from a 12 inch Antenna

The curvature of the earth can also be a factor in missing areas of precipitation, especially at range settings of 150 nautical miles or more. Here the beam overshoots the precipitation at less than 320 nautical miles.

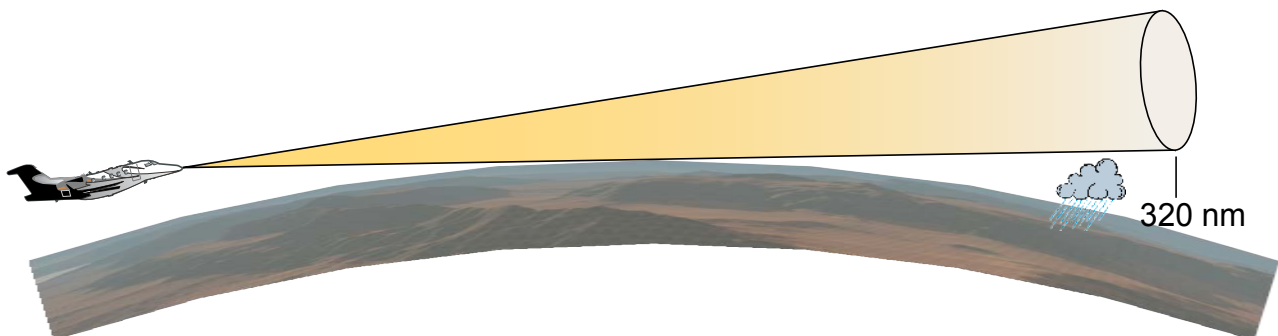

Figure 6-51 Radar Beam in Relation to the Curvature of the Earth

## RADAR SIGNAL ATTENUATION

The phenomenon of radar signal attenuation affects the operation of weather radar. When the radar signal is transmitted, it is progressively absorbed and scattered, making the signal weaker. This weakening, or attenuation, is caused by two primary sources, distance and precipitation.

Attenuation because of distance is due to the fact that the radar energy leaving the antenna is inversely proportional to the square of the distance. The reflected radar energy from a target 40 miles away that fills the radar beam is one fourth the energy reflected from an equivalent target 20 miles away. This would appear to the operator that the storm is gaining intensity as the aircraft gets closer. Internal signal processing within the GWX 68 system compensates for much of this distance attenuation.

Attenuation due to precipitation is not as predictable as distance attenuation. It is also more intense. As the radar signal passes through moisture, a portion of the radar energy is reflected back to the antenna. However, much of the energy is absorbed. If precipitation is very heavy, or covers a large area, the signal may not reach completely through the area of precipitation. The weather radar system cannot distinguish between an attenuated signal and an area of no precipitation. If the signal has been fully attenuated, the radar displays a radar shadow. This appears as an end to the precipitation when, in fact, the heavy rain may extend much further. A cell containing heavy precipitation may block another cell located behind the first, preventing it from being displayed on the radar. Never fly into these shadowed areas and never assume that all of the heavy precipitation is being displayed unless another cell or a ground target can be seen beyond the heavy cell. The WATCH<sup>®</sup> feature of the GWX 68 Weather Radar system can help in identifying these shadowed areas. Areas in question appear as shadowed or gray on the radar display. Proper use of the antenna tilt control can also help detect radar shadows.

Attenuation can also be due to poor maintenance or degradation of the radome. Even the smallest amount of wear and scratching, pitting, and pinholes on the radome surface can cause damage and system inefficiency.

## RADAR SIGNAL REFLECTIVITY

### PRECIPITATION

Precipitation or objects more dense than water, such as the surface of the earth or solid structures, are detected by the weather radar. The weather radar does not detect clouds, thunderstorms, or turbulence directly. It detects precipitation associated with clouds, thunderstorms, and turbulence. The best radar signal reflectors are raindrops, wet snow, or wet hail. The larger the raindrop, the better the reflectivity. The size of the precipitation droplet is the most important factor in radar reflectivity. Because large drops in a small concentrated area are characteristic of a severe thunderstorm, the radar displays the storm as a strong return. Ice crystals, dry snow, and dry hail have low levels of reflectivity as shown in the illustration, and often not displayed by the radar. Additionally, a cloud that contains only small raindrops, such as fog or drizzle, does not reflect enough radar energy to produce a measurable target return.

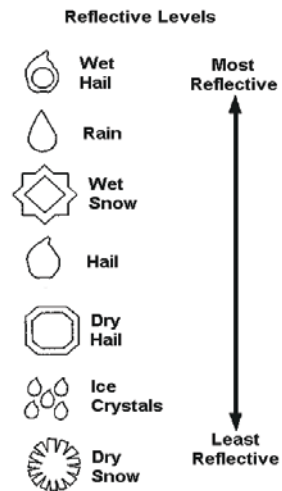

Figure 6-52 Precipitation Type and Reflectivity

## GROUND RETURNS

The intensity of ground target returns depends upon the angle at which the radar beam strikes the ground target (Angle of Incidence) and the reflective properties of that target. The gain can be adjusted so shorelines, rivers, lakes, and cities are well defined. Increasing the gain too much causes the display to fill in between targets, thus obscuring some landmarks.

Cities normally provide a strong return signal. While large buildings and structures provide good returns, small buildings can be shadowed from the radar beam by the taller buildings. As the aircraft approaches and shorter ranges are selected, details become more noticeable as the highly reflective regular lines and edges of the city become more defined.

Bodies of water such as lakes, rivers, and oceans are not good reflectors and normally do not provide good returns. The energy is reflected in a forward scatter angle with inadequate energy being returned. They can appear as dark areas on the display. However, rough or choppy water is a better reflector and provides stronger returns from the downwind sides of the waves.

Mountains also provide strong return signals to the antenna, but also block the areas behind. However, over mountainous terrain, the radar beam can be reflected back and forth in the mountain passes or off canyon walls, using up all or most of the radar energy. In this case, no return signal is received from this area, causing the display to show a dark spot which could indicate a pass where no pass exists.

### ANGLE OF INCIDENCE

The angle at which the radar beam strikes the target is called the Angle of Incidence. The figure illustrates the incident angle ('A'). This directly affects the detectable range, the area of illumination, and the intensity of the displayed target returns. A large incident angle gives the radar system a smaller detectable range and lower display intensity due to minimized reflection of the radar energy.

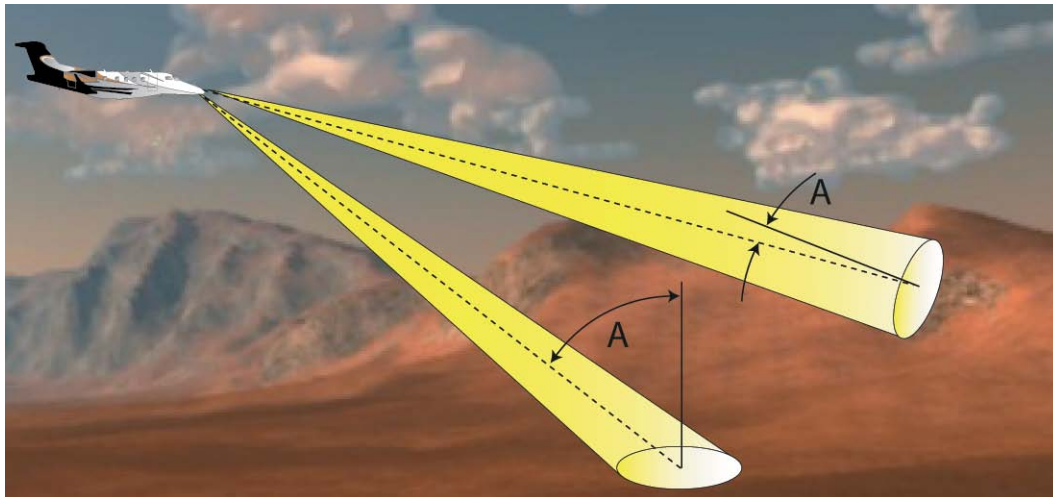

Figure 6-53 Angle of Incidence

A smaller incident angle gives the radar a larger detectable range of operation and the target display shows a higher intensity. Since more radar energy is reflected back to the antenna with a low incident angle, the resulting detectable range is increased for mountainous terrain.

### SAFE OPERATING DISTANCE

The following information establishes a minimum safe distance from the antenna for personnel near operating weather radar. The minimum safe distance is based on the FCC's exposure limit at 9.3 to 9.5 GHz for general population/uncontrolled environments, which is 1 mW/cm<sup>2</sup>. See Advisory Circular 20-68B for more information on safe distance determination.

### MAXIMUM PERMISSIBLE EXPOSURE LEVEL (MPEL)

The zone in which the radiation level exceeds the US Government standard of 1 mW/cm<sup>2</sup> is the semicircular area of at least 11 feet from the 12-inch antenna. All personnel must remain outside of this zone. With a scanning or rotating beam, the averaged power density at the MPEL boundary is significantly reduced.

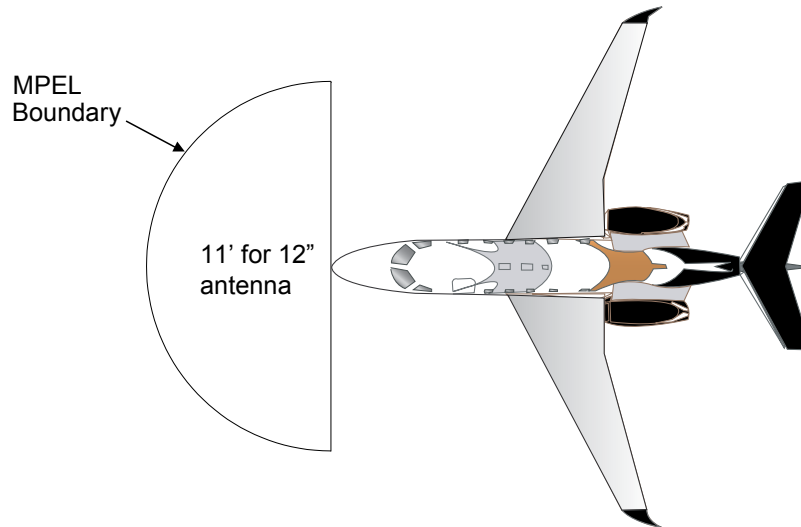

Figure 6-54 MPEL Boundary

## BASIC ANTENNA TILT SETUP

The following discussion is a simple method for setting up the weather radar antenna tilt for most situations. It is not to be considered an all encompassing setup that works in all situations, but this method does provide good overall parameters for the monitoring of threats. Ultimately, it is desired to have the antenna tilted so that the bottom of the radar beam is four degrees below parallel with the ground. The following example explains one way of achieving this.

With the aircraft flying level, adjust the antenna tilt so ground returns are displayed at a distance that equals the aircraft's current altitude (AGL) divided by 1,000. For example, if the aircraft is at 14,000 feet, adjust the tilt so the front edge of ground returns are displayed at 14 nautical miles. Note this antenna tilt angle setting. Now, raise the antenna tilt 6 degrees above this setting. The bottom of the radar beam is now angled down 4° from parallel with the ground.



**PRACTICAL APPLICATION USING THE BASIC TILT SETUP**

With the antenna tilt set as previously described, any displayed target return should be scrutinized when flying at altitudes between 2,000 and 30,000 feet AGL. If the displayed target advances on the screen to within 5 nautical miles of the aircraft, avoid it. This may be either weather or ground returns that are 2,000 feet or less below the aircraft. Raising the antenna tilt 4 degrees can help separate ground returns from weather returns in relatively flat terrain. This aligns the bottom of the radar beam parallel with the ground. Return the antenna tilt to the previous setting after a few sweeps.

If the aircraft is above 29,000 feet, be cautious of any target return that gets to within 30 nautical miles. This is likely a thunderstorm that has a top high enough that the aircraft cannot fly over it safely.

If the aircraft altitude is 15,000 feet or lower, setting the displayed range to 60 miles may be more helpful. Closely monitor anything that enters the display.

Also, after setting up the antenna tilt angle as described previously, ground returns can be monitored for possible threats. The relationship between antenna tilt angle, altitude, and distance is one degree of tilt equals 100 feet of altitude for every one nautical mile.

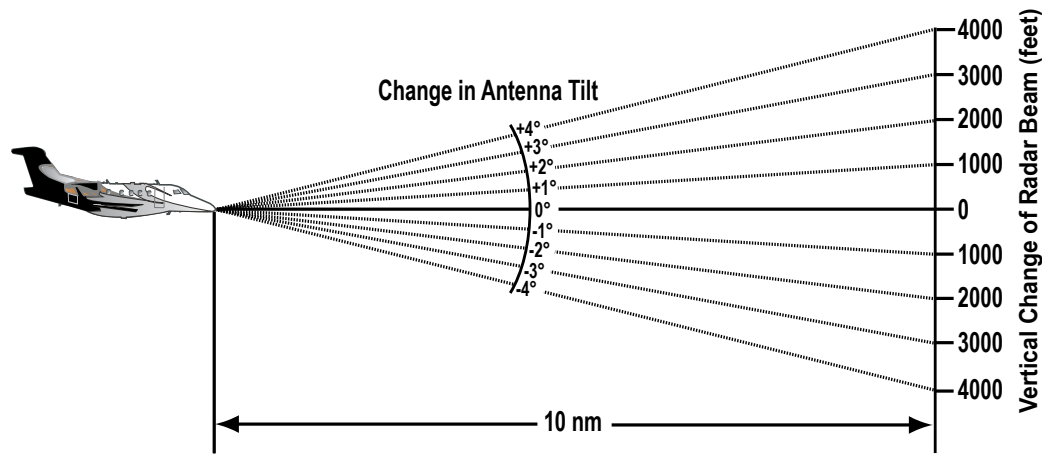

**Figure 6-55 Vertical Change in Radar Beam per Nautical Mile**

Therefore, with the antenna tilt set so that the bottom of the beam is four degrees below parallel with the ground, a target return at 10 nm is approximately 4,000 feet below the aircraft; at 20 nm, 8,000 feet; at 50 nm, 20,000 feet. In other words, at this tilt setting, a ground return (such as a mountain peak) being displayed at 10 nm would have a maximum distance below the aircraft of 4,000 feet. A ground target return being displayed at 5 nm would have a maximum distance below the aircraft of 2,000 feet.

This setup provides a good starting point for practical use of the GWX 68. There are many other factors to consider in order to become proficient at using weather radar in all situations.

## WEATHER MAPPING AND INTERPRETATION

### WEATHER DISPLAY INTERPRETATION

When evaluating various target returns on the weather radar display, the colors denote precipitation intensity and rates shown in the table.

Weather Mode Color	Intensity	Approximate Precipitation Rate (in/hr.)
Black	< 23 dBZ	< .01.
Green	23 dBZ to < 32 dBZ	.01 - 0.1.
Yellow	32 dBZ to < 41 dBZ	0.1 - 0.5
Red	41 dBZ to < 50 dBZ	0.5 - 2
Magenta	50 dBZ and greater	> 2

Table 6-3 Precipitation Intensity Levels

### THUNDERSTORMS

Updrafts and downdrafts in thunderstorms carry water through the cloud. The more severe the drafts, the greater the number and size of the precipitation droplets. With this in mind, the following interpretations can be made from what is displayed on the weather radar. Avoid these areas by an extra wide margin.

- In areas where the displayed target intensity is red or magenta (indicating large amounts of precipitation), the turbulence is considered severe.
- Areas that show steep color gradients (intense color changes) over thin bands or short distances suggest irregular rainfall rate and strong turbulence.
- Areas that show red or magenta are associated with hail or turbulence, as well as heavy precipitation. Vertical scanning and antenna tilt management may be necessary to identify areas of maximum intensity.

Along squall lines (multiple cells or clusters of cells in a line) individual cells may be in different stages of development. Areas between closely spaced, intense targets may contain developing clouds not having enough moisture to produce a return. However, these areas could have strong updrafts or downdrafts. Targets showing wide areas of green are generally precipitation without severe turbulence. Targets showing irregularities in the target return may also indicate turbulence, appearing as hooks, fingers, or scalloped edges. These irregularities may be present in green areas with no yellow, red, or magenta areas and should be treated as highly dangerous areas. Avoid these areas as if they are red or magenta.

Irregularities in the target return may also indicate turbulence, appearing as hooks, fingers, or scalloped edges. These irregularities may be present in green areas with no yellow, red, or magenta areas and should be treated as highly dangerous areas. Avoid these areas as if they are red or magenta.

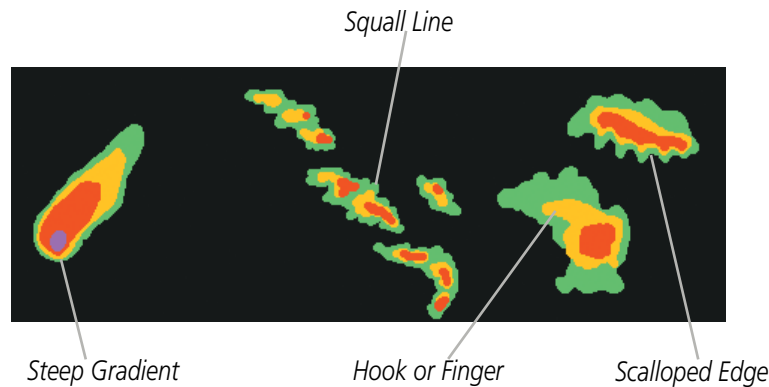

Figure 6-56 Cell Irregularities

Thunderstorm development is rapid. A course may become blocked within a short time. When displaying shorter ranges, periodically select a longer range to see if problems are developing further out. That can help prevent getting trapped in a blind alley or an area that is closed at one end by convective weather.

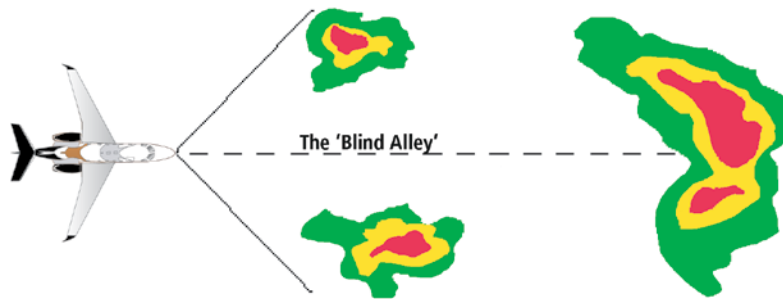
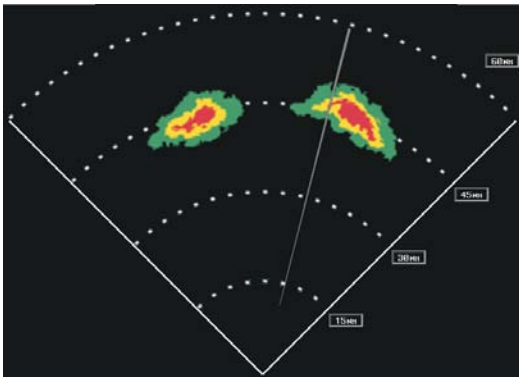
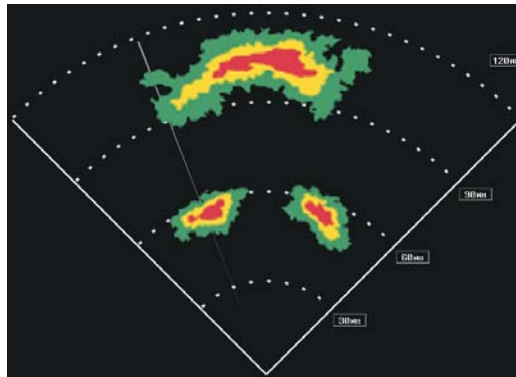

Figure 6-57 The Blind Alley - Horizontal Scan

In areas of multiple heavy cells, use the Vertical Scan feature along with antenna tilt management to examine the areas. Remember to avoid shadowed areas behind targets.



*The Blind Alley at Close Range*



*The Large Storm Behind*

**Figure 6-58 The Blind Alley**

## TORNADOES

There are no conclusive radar target return characteristics which identify a tornado. However, tornadoes may be present if the following characteristics are observed:

- A narrow, finger-like portion extends and in a short time curls into a hook and closes on itself.
- A hook, which may be in the general shape of the numeral 6 (numeral 9 in the southern hemisphere), especially if bright and projecting from the southwest quadrant (northeast quadrant in the southern hemisphere) of a major thunderstorm.
- V-shaped notches.
- Doughnut shapes.

These shapes do not always indicate tornadoes, and tornado returns are not limited to these characteristics. Confirmed radar observations of tornadoes most often have not shown shapes different from those of a normal thunderstorm display.

## HAIL

Hail results from updrafts carrying water high enough to freeze. Therefore, the higher the top of a thunderstorm, the greater the probability that it contains hail. Vertically scanning the target return can give the radar top of a thunderstorm that contains hail. Radar top is the top of a storm cell as detected by radar. It is not the actual top, or true top of the storm. The actual top of a storm cell is seen with the eyes in clear air and may be much higher than the radar top. The actual top does not indicate the top of the hazardous area.

Hail can fall below the minimum reflectivity threshold for radar detection. It can have a film of water on its surface, making its reflective characteristics similar to a very large water droplet. Because of this film of water, and because hail stones usually are larger than water droplets, thunderstorms with large amounts of wet hail return stronger signals than those with rain. Some hail shafts are extremely narrow (100 yards

or less) and make poor radar targets. In the upper regions of a cell where ice particles are dry (no liquid coating), target returns are less intense.

Hail shafts are associated with the same radar target return characteristics as tornados. U-shaped cloud edges three to seven miles across can also indicate hail. These target returns appear quite suddenly along any edge of the cell outline. They also change in intensity and shape in a matter of seconds, making vigilant monitoring essential.

**OPERATION IN WEATHER MODE**

**WARNING:** Begin transmitting only when it is safe to do so. When transmitting while the aircraft is on the ground, no personnel or objects should be within 11 feet of the antenna.

**CAUTION:** In Standby mode, the antenna is parked at the center line. It is always a good idea to put the radar in Standby mode before taxiing the aircraft to prevent the antenna from bouncing on the bottom stop and possibly causing damage to the radar assembly.

When the weather radar system is in the Weather or Ground Map mode, the system automatically switches to Standby mode on landing.

In Reversionary mode, the weather radar system automatically switches to Standby mode. The system remains in Standby mode until both displays are restored. In Reversionary mode, the weather radar system cannot be controlled.

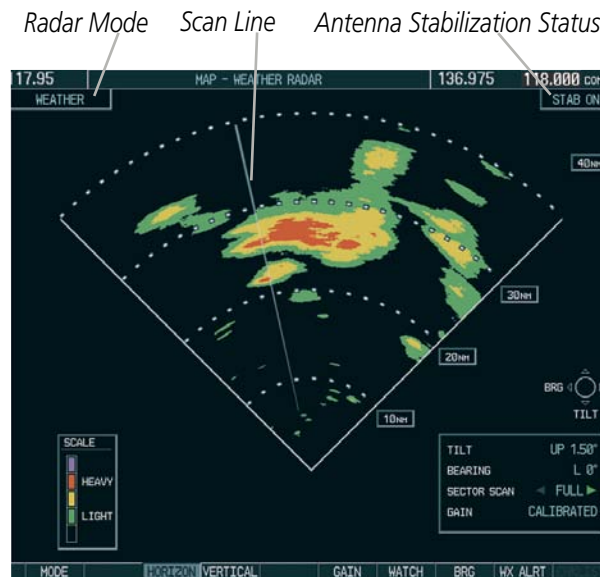

**Figure 6-59 Horizontal Scan Display**

**Displaying weather on the Weather Radar Page:**

- 1) Select the Weather Radar Page in the Map Page Group with the **FMS** Knob.
- 2) Select the **MODE** Softkey.
- 3) While on the ground, select the **STANDBY** Softkey. A one-minute warm-up period is initiated (countdown is displayed on the screen). After the warm-up is complete, the radar enters the Standby Mode.
  - a) Select the **WEATHER** Softkey. A confirmation window is displayed.

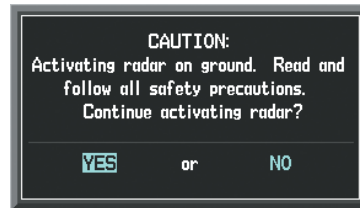

Figure 6-60 Confirming Activating Radar

- b) Turn the small **FMS** Knob to highlight YES and press the **ENT** Key to continue radar activation.
- OR:**
- If the aircraft is airborne, select the **WEATHER** Softkey. A 1 minute warm-up period is initiated (countdown is displayed on the screen). After the warm-up is complete, the radar begins transmitting.
- 4) Turn the **RANGE** Knob to select the desired map range.
  - 5) The horizontal scan is initially displayed (Figure 6-61). If desired, select the **VERTICAL** Softkey to change to vertical scanning.

Vertically scanning a storm cell:



**NOTE:** Vertical scanning of a storm cell should be done with the aircraft wings level to avoid constant adjustment of the Bearing Line.

- 1) While in the Horizontal Scan view, select the **BRG** Softkey. This places the cursor in the BEARING field and displays the Bearing Line.  
If the Bearing Line is not displayed, press the **MENU** Key and turn the large **FMS** Knob to select Show Bearing Line. Press the **ENT** Key.
- 2) Press the **ENT** Key.
- 3) Turn the small **FMS** Knob to place the Bearing Line on the desired storm cell or other area to be vertically scanned.

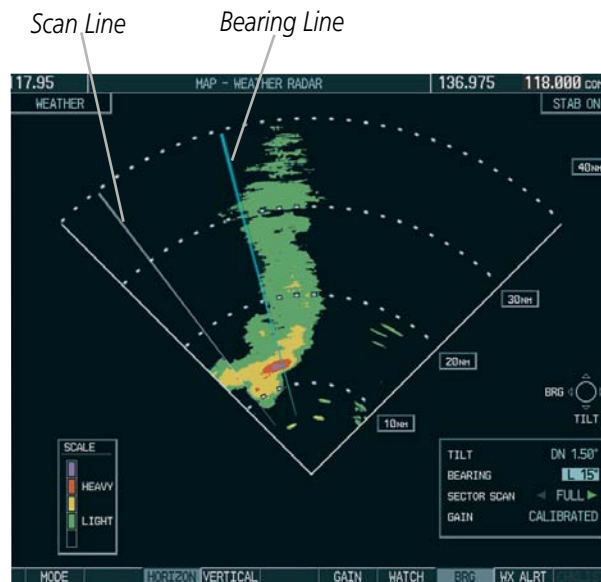

Figure 6-61 Bearing Line on Horizontal Scan

- 4) Select the **VERTICAL** Softkey. A vertical scan of the selected area is displayed (Figure 6-62).
- 5) The small **FMS** Knob may be used to move the scanned bearing line a few degrees right or left.
- 6) Turn the **RANGE** Knob to adjust the range.
- 7) Press the **FMS** Knob to remove the cursor.
- 8) To select a new area to be vertically scanned, select the **HORIZON** Softkey to return to the Horizontal Scan view and repeat the previous steps.

The **RANGE** Knob can also be used to adjust bearing from left to right.



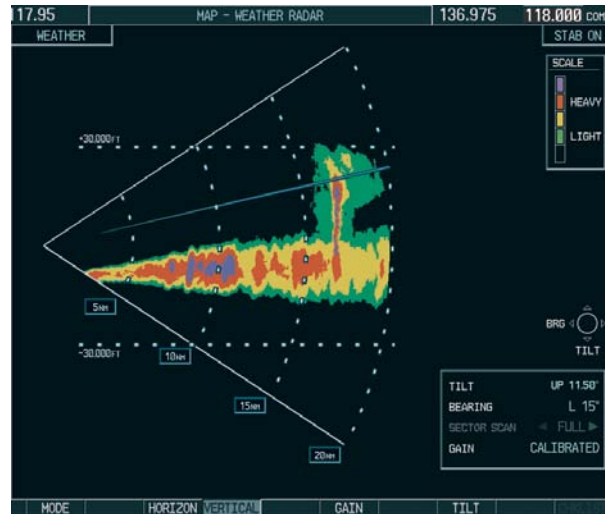

Figure 6-62 Vertical Scan Display

## ADJUSTING ANTENNA TILT ANGLE

In order to make an accurate interpretation of a storm cell, the radar beam should be pointed at the wet part of the weather cell to record the proper rainfall intensity (color level). The ideal aiming point is just below the freezing level of the storm. The best way to find this point is to use the Vertical Scan feature. The antenna tilt angle can be centered on the strongest return area in the vertical scan to get a more accurate view of the coverage and intensity of the target in the horizontal scan.

### Adjusting antenna tilt on the Horizontal Scan display:

- 1) Press the **FMS** Knob to activate the cursor in the TILT field.
- 2) Turn the small **FMS** Knob to select the desired antenna tilt angle.
- 3) Press the **ENT** Key.
- 4) Press the **FMS** Knob to remove the cursor.

The **RANGE** Knob can also be used to adjust tilt up and down.

**Adjusting antenna tilt on the Vertical Scan display:**

- 1) Select the **TILT** Softkey to activate the cursor in the TILT field and display the Tilt Line.  
If the Tilt Line is not displayed, press the **MENU** Key and turn the large **FMS** Knob to select Show Tilt Line. Press the **ENT** Key.
  - 2) Turn the small **FMS** Knob to adjust the antenna tilt angle. The selected tilt angle is implemented when Horizontal Scan is selected again.
- The **RANGE** Knob can also be used to adjust tilt.

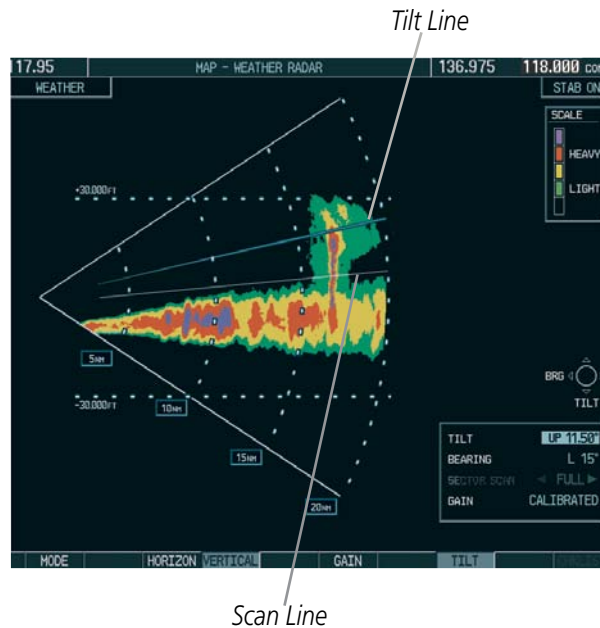

Figure 6-63 Adjusting Tilt on Vertical Scan Display

## ADJUSTING GAIN



**WARNING:** Changing the gain in weather mode causes precipitation intensity to be displayed as a color not representative of the true intensity. Remember to return the gain setting to Calibrated for viewing the actual intensity of precipitation.

- 1) Select the **GAIN** Softkey to activate the cursor in the GAIN field.
- 2) Turn the small **FMS** Knob to adjust the gain for the desirable level. The gain setting is visible in the GAIN field as a movable horizontal bar in a flashing box. The line pointer is a reference depicting the calibrated position.
- 3) Press the **FMS** Knob to remove the cursor.
- 4) Select the **GAIN** Softkey again to recalibrate the gain. 'CALIBRATED' is displayed in the GAIN field.

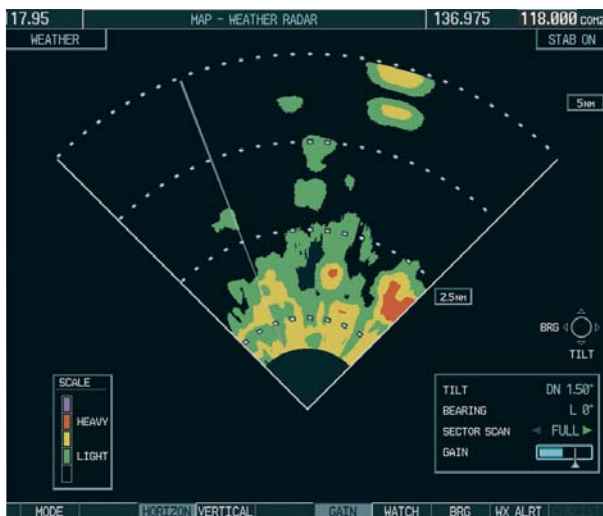

Manual Gain Set Below Calibrated

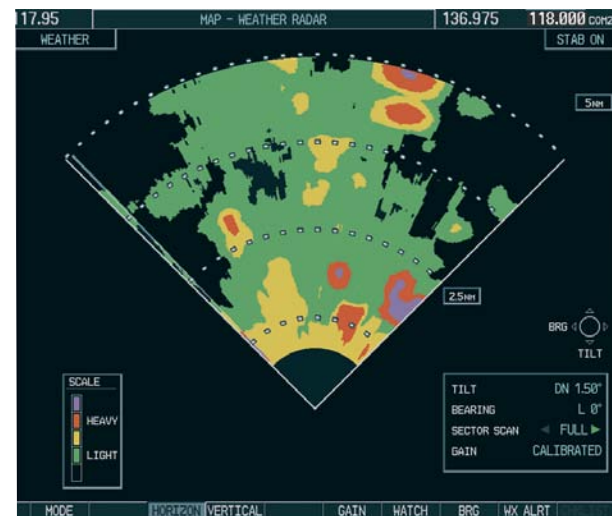

Calibrated Gain

Figure 6-64 Gain Calibration

SECTOR SCAN

- 1) While in horizontal scan mode, select the **BRG** Softkey to display the Bearing Line and place the cursor in the BEARING field. If the Bearing Line is not displayed, press the **MENU** Key and turn the large **FMS** Knob to select Show Bearing Line.
- 2) Press the **ENT** Key.



Figure 6-65 Selecting Sector Scan Position

- 3) Turn the small **FMS** Knob to place the Bearing Line in the desired position. The location of the Bearing Line becomes the center point of the Sector Scan.
- 4) Turn the large **FMS** Knob to place the cursor in the SECTOR SCAN field.
- 5) Turn the small **FMS** Knob to select FULL, 60°, 40°, or 20° scan.
- 6) If desired, readjust the Bearing Line as discussed previously to change the center of the Sector Scan.
- 7) Select the **BRG** Softkey again to remove the Bearing Line and cursor. The bearing reference is reset to 0°.



Figure 6-66 40° Sector Scan

### ANTENNA STABILIZATION

- 1) To activate or deactivate the antenna stabilization, select the **MODE** Softkey.
- 2) Select the **STAB ON** Softkey to activate antenna stabilization or select the **STAB OFF** Softkey to deactivate. The current stabilization condition is shown in the upper right of the weather radar display.

### WEATHER ATTENUATED COLOR HIGHLIGHT (WATCH®)

WATCH® identifies deceptively strong or unknown intensity parts of a storm. While in horizontal scan mode, this feature can be used as a tool to determine areas of possible inaccuracies in displayed intensity due to weakening of the radar energy. This weakening is known as attenuation. The radar energy weakens as it passes through areas of intense precipitation, large areas of lesser precipitation, and distance. Issues with the radome attenuates the radar energy. All these factors have an effect on the return intensity. The more energy that dissipates, the lesser the displayed intensity of the return. Accuracy of the displayed intensity of returns located in the shaded areas are suspect. Make maneuvering decisions with this information in mind. Proper antenna tilt management should still be employed to determine the extent of attenuation in a shaded area.

To activate or deactivate the WATCH® feature, select the **WATCH** Softkey.

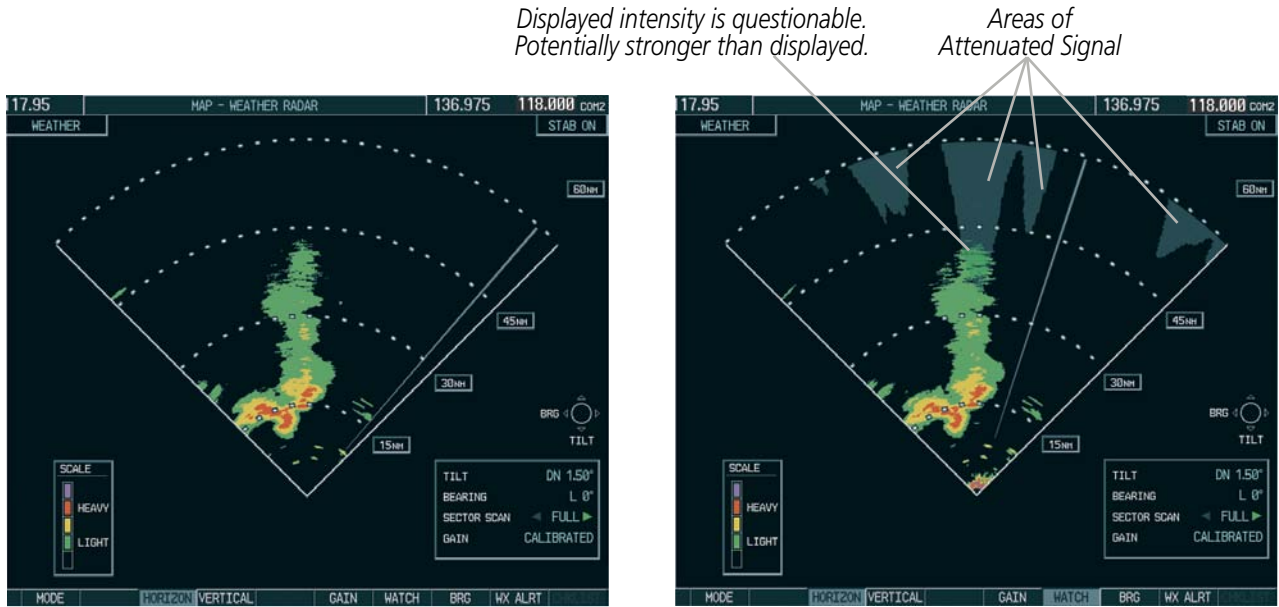

Horizontal Scan Without WATCH®

Horizontal Scan With WATCH®

Figure 6-67 Horizontal Scan Without and With WATCH®

**WEATHER ALERT**

The Weather Alert feature indicates the presence of heavy precipitation between the ranges of 80 and 320 nm regardless of the currently displayed range. Weather Alert targets appear as red bands along the outer range ring at the approximate azimuth of the detected returns.

If a Weather Alert is detected within  $\pm 10^\circ$  of the aircraft heading, an alert is displayed on the PFD in the Messages Window.

If the antenna tilt is adjusted too low, a weather alert can be generated by ground returns. To avoid unwanted weather alerts, deselect the **WX ALRT** Softkey.

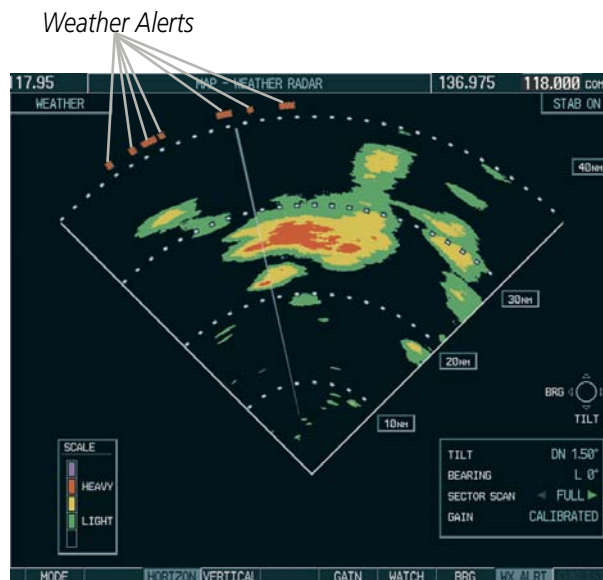

Figure 6-68 Weather Alert Indications

To activate or deactivate Weather Alerts, select the **WX ALERT** Softkey. Activating and deactivating enables or inhibits the alert on the PFD.

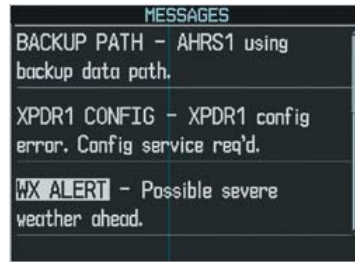

Figure 6-69 Weather Alert on PFD

## GROUND MAPPING AND INTERPRETATION

A secondary use of the weather radar system is for the presentation of terrain. This can be a useful tool for verifying aircraft position. A picture of the ground is represented much like a topographical map that can be used as a supplement to the navigation map on the MFD.

Ground Map mode uses a different gain range than Weather mode. Different colors are also used to represent the intensity levels. The displayed intensity of ground target returns are defined in the table below. Use of the **GAIN** and **TILT** controls help improve contrast so that specific ground targets can be recognized more easily. As previously discussed, the type and orientation of the target in relation to the aircraft affects the intensity displayed.

When the weather radar system is in either the Weather or Ground Map mode, the system automatically switches to Standby mode upon landing.

Ground Map Mode Color	Intensity
Black	0 dB
Light blue	> 0 dB to < 9 dB
Yellow	9 dB to < 18 dB
Magenta	18 dB to < 27 dB
Blue	27 dB and greater

Table 6-4 Ground Target Return Intensity Levels

### Operation in Ground Map Mode

- 1) Select the **MODE** Softkey.
- 2) Select the **GROUND** Softkey to place the radar in Ground Map mode.
- 3) Select the **BACK** Softkey.
- 4) Select the **FMS** Knob to activate the cursor.
- 5) Turn the large **FMS** Knob to place the cursor in the TILT field.
- 6) Adjust the antenna tilt angle by turning the small **FMS** Knob to display ground returns at the desired distance.
- 7) Press the **FMS** Knob to remove the cursor.



**SYSTEM STATUS**

The system displays the radar mode annunciation in the upper left corner of the Weather Radar Page. Additional information may be displayed in the center of the Weather Radar Page as a banner annunciation.

Radar Mode	Radar Mode Annunciation Box	Center Banner Annunciation
Standby	<b>STANDBY</b>	<b>STANDBY</b>
Standby (During Warm-Up)	<b>STANDBY</b>	<b>WARM-UP</b> <b>XX</b> (XX indicates number of seconds remaining in warm-up)
Weather	<b>WEATHER</b>	None
Ground Mapping	<b>GROUND MAPPING</b>	None
Off	<b>OFF</b>	<b>OFF</b>
Radar Failed*	<b>FAIL</b>	<b>RADAR FAIL</b>

\* See Table 6-7 for additional failure annunciations

**Table 6-5 Radar Modes on the Weather Radar Page**

The system displays the status of the radar antenna stabilization feature in the upper right corner of the Weather Radar Page.

Radar Antenna Stabilization Status	Description
<b>STAB ON</b>	Antenna stabilization is selected on.
<b>STAB OFF</b>	Antenna stabilization is selected off.
<b>STAB INOP</b>	The radar is not receiving pitch and roll information. The antenna stabilization feature is inoperative.

**Table 6-6 Antenna Stabilization Annunciations on the Weather Radar Page**

If the unit fails, an annunciation as to the cause of the failure is shown as a banner in the center of the Weather Radar Page.

Weather Radar Page Center Banner Annunciation	Description
<b>BAD CONFIG</b>	The radar configuration is invalid. The radar should be serviced.
<b>RDR FAULT</b>	The radar unit is reporting a fault. The radar should be serviced.
<b>RADAR FAIL</b>	The system is not receiving valid data from the radar unit. The system should be serviced.

**Table 6-7 Abnormal Radar Status Annunciations on the Weather Radar Page**

## 6.3 TAWS-B



**WARNING:** Do not use TAWS information for primary terrain avoidance. TAWS is intended only to enhance situational awareness.



**NOTE:** Terrain data is not displayed if the aircraft is outside of the installed terrain database coverage area.



**NOTE:** The data contained in the TAWS databases comes from government agencies. Garmin accurately processes and cross-validates the data but cannot guarantee the accuracy and completeness of the data.

TAWS-B (Terrain Awareness and Warning System - Class B) provides increased situational awareness and aids in reducing controlled flight into terrain (CFIT). TAWS-B provides visual and aural annunciations when terrain and obstacles are within the given altitude threshold from the aircraft. The displayed alerts and warnings are advisory in nature only.

TAWS-B satisfies TSO-C151b Class B requirements for certification.

TAWS-B requires the following to operate properly:

- A valid terrain/obstacle/airport terrain database
- A valid 3-D GPS position solution

TAWS-B uses terrain and obstacle information supplied by government sources. Terrain information is based on terrain elevation information in a database that may contain inaccuracies. Individual obstructions may be shown if available in the database. Garmin verifies the data to confirm accuracy of the content, per TSO-C151b. However, the displayed information should never be understood as being all-inclusive and data may be inaccurate.

TAWS-B uses information provided from the GPS receiver to provide a horizontal position and altitude. GPS altitude is derived from satellite measurements. GPS altitude is then converted to the height above geodetic sea level (GSL), which is the height above mean sea level (MSL) calculated geometrically. GSL altitude is used to determine TAWS-B alerts. GSL altitude accuracy is affected by satellite geometry, but is not subject to variations in pressure and temperature that normally affect pressure altitude sensors. GSL altitude does not require local altimeter settings to determine MSL altitude. It is a widely-used MSL altitude source. Therefore, GSL altitude provides a highly accurate and reliable MSL altitude source to calculate terrain and obstacle alerts.

The terrain and obstacle databases used by TAWS-B are referenced to MSL. Using the GPS position and GSL altitude, TAWS-B displays a 2-D picture of the surrounding terrain and obstacles relative to the position and altitude of the aircraft. Furthermore, the GPS position and GSL altitude are used to calculate and “predict” the aircraft’s flight path in relation to the surrounding terrain and obstacles. In this manner, TAWS-B can provide advanced alerts of predicted dangerous terrain conditions.

Baro-corrected altitude (or indicated altitude) is derived by adjusting the altimeter setting for local atmospheric conditions. The most accurate baro-corrected altitude can be achieved by frequently updating the altimeter setting to the nearest reporting station along the flight path. However, because actual atmospheric conditions seldom match the standard conditions defined by the International Standard Atmosphere (ISA) model (where pressure, temperature, and lapse rates have fixed values), it is common for the baro-corrected altitude (as read from the altimeter) to differ from the GSL altitude. This variation results in the aircraft’s GSL altitude differing from the baro-corrected altitude.

### DISPLAYING TAWS-B DATA

TAWS-B uses yellow (caution) and red (warning) to depict terrain and obstacles (with heights greater than 200 feet above ground level, AGL) alerts relative to aircraft altitude. Colors are adjusted automatically as the aircraft altitude changes. The colors and symbols in the figure and tables below are used to represent terrain, obstacles, and potential impact points.

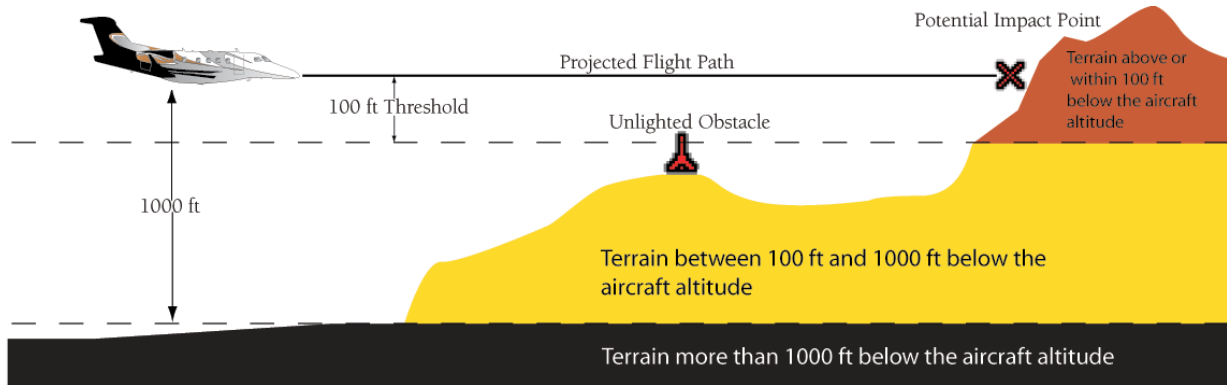

Figure 6-70 Terrain Altitude/Color Correlation for TAWS-B

Unlighted Obstacle		Lighted Obstacle		Obstacle Location
< 1000' AGL	> 1000' AGL	< 1000' AGL	> 1000' AGL	
				Red obstacle is above or within 100 ft below the aircraft altitude
				Yellow obstacle is between 100 ft and 1000 ft below the aircraft altitude

Table 6-8 TAWS-B Obstacle Colors and Symbology

Potential Impact Point Symbol	Alert Type	Example Annunciation
	Warning	
	Caution	

Table 6-9 TAWS-B Potential Impact Point Symbols with Alert Types

TAWS-B information can be displayed on the following maps:

- PFD Inset Navigation Map
- Navigation Map Page
- TAWS-B Page
- Trip Planning Page
- Flight Plan Pages

#### Displaying terrain and obstacle information (maps except the TAWS-B Page or PFD Inset Navigation Map):

- 1) Press the **MAP** Softkey.
- 2) Press the **TERRAIN** Softkey to display terrain and obstacle data.

#### Displaying terrain and obstacle information on the PFD Inset Navigation Map:

- 1) On the PFD, press the **INSET** Softkey (in non-TCAS II installations) or the **TRFC/MAP** Softkey (TCAS II installations).
- 2) If the PFD Inset Map is showing the traffic map, press the **TRFC-2** Softkey to display the navigation map.
- 3) Press the **TERRAIN** Softkey to display terrain and obstacle data.

When TAWS-B is selected on MFD maps other than the TAWS-B Page, an icon to indicate the feature is enabled for display and a legend for TAWS-B terrain colors are shown (Figure 6-71).

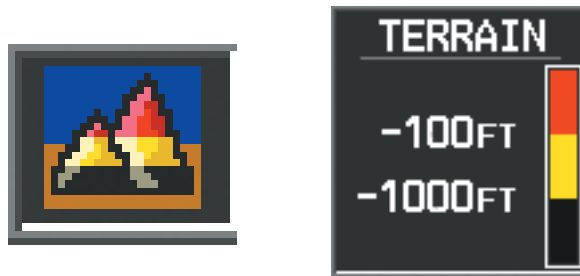

Figure 6-71 TAWS-B Icon and Legend

The Navigation Map Page Setup Menu provides a means in addition to the softkey for enabling/disabling display of terrain and obstacles. The setup menu also controls the map range settings above which terrain and obstacle data are decluttered from the display. If a map range larger than the map range setting is selected, the data is removed from the map. For terrain data, the enable/disable function applies only to the MFD, while the range setting also affects the PFD Inset Map.

Terrain data can be selected for display independently of obstacle data; however, obstacles for which warnings and cautions are issued are shown when terrain is selected for display and the map range is within the setting limit.

Maps besides the TAWS-B Page use settings based on those selected for the Navigation Map Page. The maximum display ranges for obstacles on each map are dependent on the range setting made for the Navigation Map. If the maximum range for obstacle display on the Navigation Map is adjusted to below 20 nm, the highest obstacle display range settings on the other applicable maps are also adjusted proportionally.

**Customizing terrain and obstacle display on the Navigation Map Page:**

- 1) Select the Navigation Map Page.
- 2) Press the **MENU** Key.
- 3) With 'Map Setup' highlighted, press the **ENT** Key (Figure 6-72).
- 4) Turn the small **FMS** Knob to select the 'Map' Group and press the **ENT** Key (Figure 6-73).
- 5) Turn the large **FMS** Knob or press the **ENT** Key to scroll through product selections (Figure 6-74).
  - TERRAIN DATA – Turns the display of terrain data on or off and sets maximum range at which terrain is shown
  - OBSTACLE DATA – Turns the display of obstacle data on or off and sets maximum range at which obstacles are shown
- 6) Turn the small **FMS** Knob to scroll through options for each product (ON/OFF, range settings).
- 7) Press the **ENT** Key to select an option.
- 8) Press the **FMS** Knob or **CLR** Key to return to the Navigation Map Page with the changed settings.

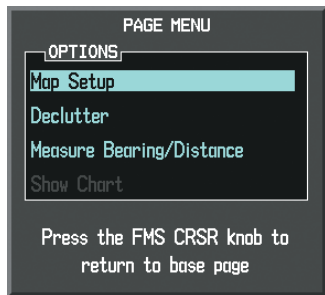

Figure 6-72 Navigation Map Page Menu



Figure 6-73 Navigation Map Page Setup Menu

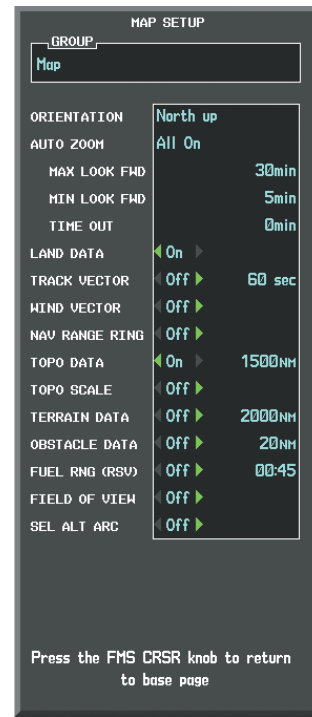

Figure 6-74 Navigation Map Page Setup Menu, Map Group

## TAWS-B PAGE

---

The Map - TAWS-B Page is specialized to show terrain, obstacle, and potential impact point data in relation to the aircraft's current altitude, without clutter from the basemap. It is the principal map page for viewing TAWS-B information. Aviation data (airports, VORs, and other NAVAIDs) can be displayed for reference. If an obstacle and the projected flight path of the aircraft intersect, the display automatically zooms in to the closest potential point of impact on the TAWS-B Page.

Aircraft orientation on this map is always heading up unless there is no valid heading. Two views are available relative to the position of the aircraft: the 360° default display and the radar-like ARC (120°) display. Map range is adjustable with the **RANGE** Knob from 1 to 200 nm, as indicated by the map range rings (or arcs).

### Displaying the TAWS-B Page:

- 1) Turn the large **FMS** Knob to select the Map Page Group.
- 2) Turn the small **FMS** Knob to select the TAWS-B Page.

### Changing the TAWS-B Page view:

- 1) Select the **VIEW** Softkey.
- 2) Select the **360** or **ARC** Softkey to select the desired view.

**Or:**

- 1) Press the **MENU** Key.
- 2) Select 'View Arc' or 'View 360°' (choice dependent on current state) and press the **ENT** Key to change the view

### Showing/hiding aviation information on the TAWS-B Page:

- 1) Press the **MENU** Key.
- 2) Select 'Show Aviation Data' or 'Hide Aviation Data' (choice dependent on current state) and press the **ENT** Key.

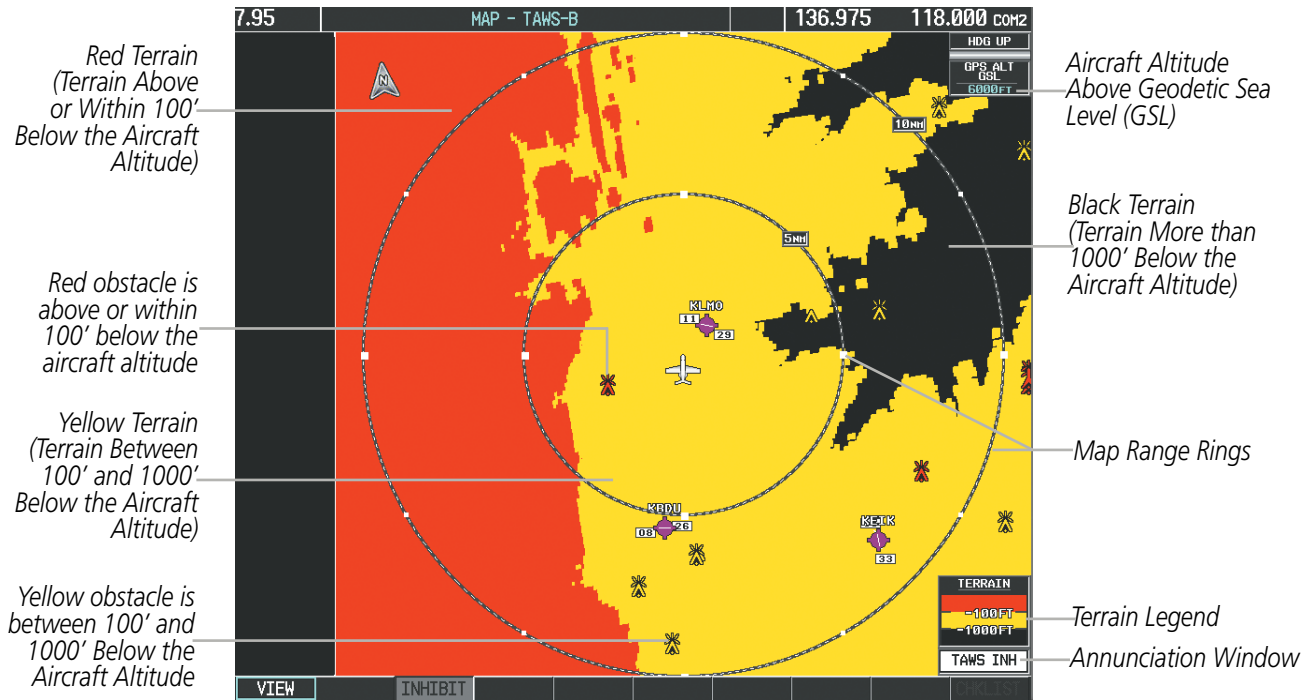

Figure 6-75 TAWS-B Page

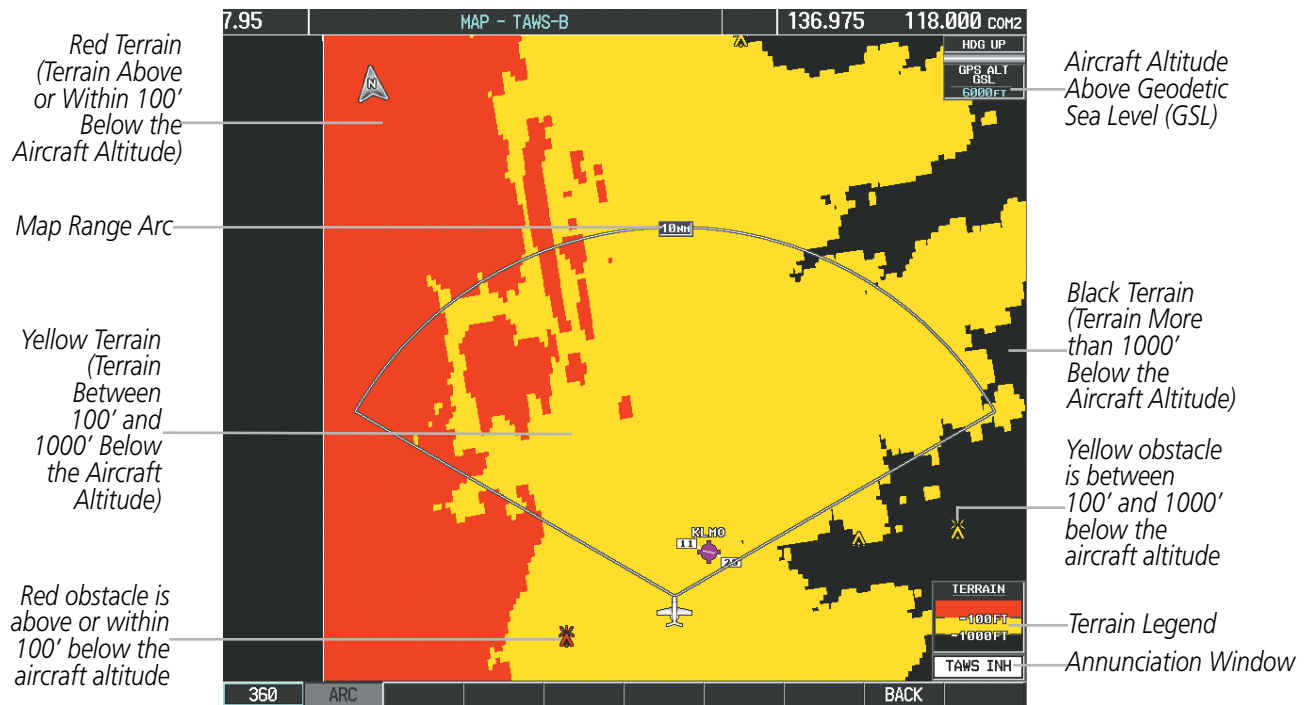

Figure 6-76 TAWS-B Page (ARC View)



## TAWS-B ALERTS

Alerts are issued when flight conditions meet parameters that are set within TAWS-B software algorithms. TAWS-B alerts typically employ a CAUTION or a WARNING alert severity level, or both. When an alert is issued, visual annunciations are displayed and aural alerts are simultaneously issued. Table 6-10 shows TAWS-B alert types with corresponding annunciations and aural messages.

When an alert is issued, annunciations appear on the PFD and MFD. The TAWS-B Alert Annunciation is shown to the upper left of the Altimeter on the PFD and below the Terrain Legend on the MFD. If the TAWS-B Page is not displayed at the time, a pop-up alert appears on the MFD. To acknowledge the pop-up alert:

- Press the **CLR** Key (returns to the currently viewed page), or
- Press the **ENT** Key (accesses the TAWS-B Page)



Figure 6-77 TAWS-B PFD Alert Annunciation

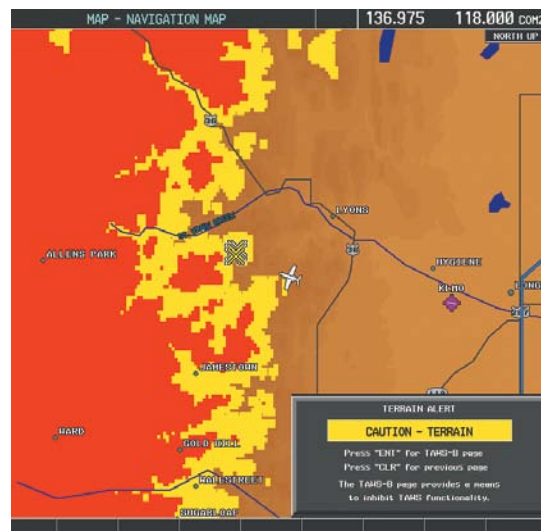

Figure 6-78 Navigation Map Page TAWS-B Pop-up Alert

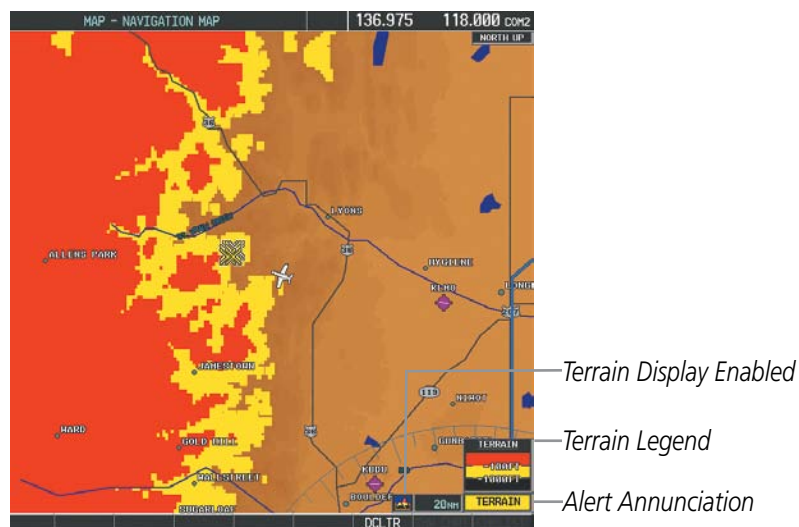

Figure 6-79 Navigation Map Page (After TAWS-B Pop-up Alert Acknowledgment)

Alert Type	PFD/MFD TAWS-B Page Annunciation	MFD Map Page Pop-Up Alert (except TAWS-B Page)	Aural Message
Reduced Required Terrain Clearance Warning (RTC)	<b>PULL UP</b>	<b>TERRAIN - PULL-UP</b>	"Terrain, Terrain; Pull Up, Pull Up"
Imminent Terrain Impact Warning (ITI)	<b>PULL UP</b>	<b>TERRAIN - PULL-UP</b>	"Terrain, Terrain; Pull Up, Pull Up"
Reduced Required Obstacle Clearance Warning (ROC)	<b>PULL UP</b>	<b>OBSTACLE - PULL-UP</b>	"Obstacle, Obstacle; Pull Up, Pull Up"
Imminent Obstacle Impact Warning (IOI)	<b>PULL UP</b>	<b>OBSTACLE - PULL-UP</b>	"Obstacle, Obstacle; Pull Up, Pull Up"
Reduced Required Terrain Clearance Caution (RTC)	<b>TERRAIN</b>	<b>CAUTION - TERRAIN</b>	"Caution, Terrain; Caution, Terrain"
Imminent Terrain Impact Caution (ITI)	<b>TERRAIN</b>	<b>CAUTION - TERRAIN</b>	"Caution, Terrain; Caution, Terrain"
Reduced Required Obstacle Clearance Caution (ROC)	<b>TERRAIN</b>	<b>CAUTION - OBSTACLE</b>	"Caution, Obstacle; Caution, Obstacle"
Imminent Obstacle Impact Caution (IOI)	<b>TERRAIN</b>	<b>CAUTION - OBSTACLE</b>	"Caution, Obstacle; Caution, Obstacle"
Premature Descent Alert Caution (PDA)	<b>TERRAIN</b>	<b>TOO LOW - TERRAIN</b>	"Too Low, Terrain"
Negative Climb Rate Caution (NCR)	<b>TERRAIN</b>	<b>DON'T SINK</b> *	"Don't Sink"
Altitude Voice Callout (VCO)	None	None	"Five-Hundred"

**Table 6-10 TAWS-B Alerts**

## EXCESSIVE DESCENT RATE ALERT

The purpose of the **Excessive Descent Rate (EDR)** alert is to provide suitable notification when the aircraft is determined to be closing (descending) upon terrain at an excessive speed. Figure 6-80 shows the parameters for the alert as defined by TSO-C151b.

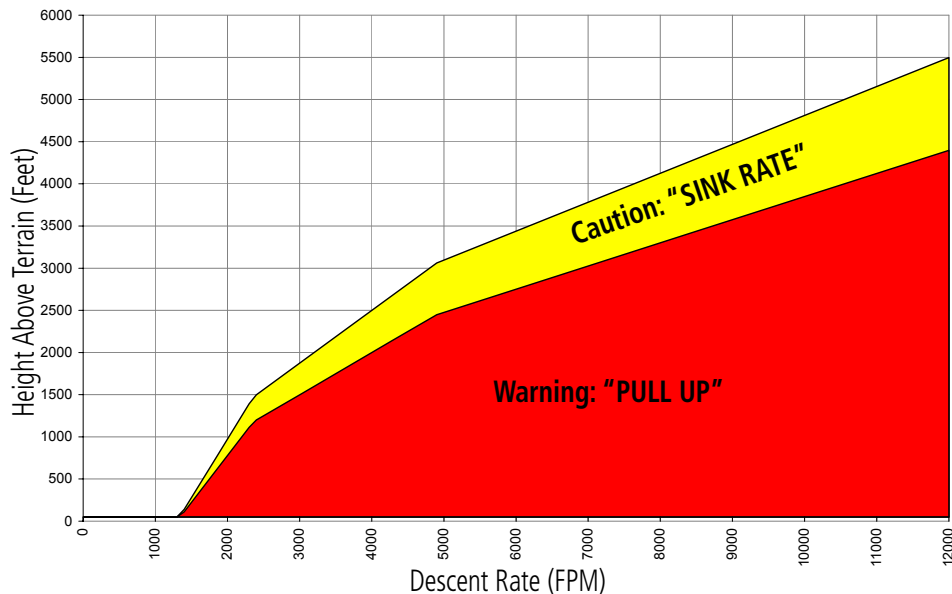

Figure 6-80 Excessive Descent Rate Alert Criteria

## FORWARD LOOKING TERRAIN AVOIDANCE (FLTA)

The Forward Looking Terrain Avoidance feature of TAWS-B compares the aircraft's projected flight path with known terrain and obstacles in their respective databases and issues four types of alerts as either a caution or a warning:

**Reduced Required Terrain Clearance (RTC)** and **Reduced Required Obstacle Clearance (ROC)** alerts are issued when the aircraft flight path is above terrain, yet is projected to come within the minimum clearance values in Figure 6-81. When an RTC alert is issued, a potential impact point is displayed on the TAWS-B Page.

**Imminent Terrain Impact (ITI)** and **Imminent Obstacle Impact (IOI)** alerts are issued when the aircraft is below the elevation of a terrain or obstacle cell in the aircraft's projected path. ITI and IOI alerts are accompanied by a potential impact point displayed on the TAWS-B Page. The alert is annunciated when the projected vertical flight path is calculated to come within minimum clearance altitudes in Figure 6-81.

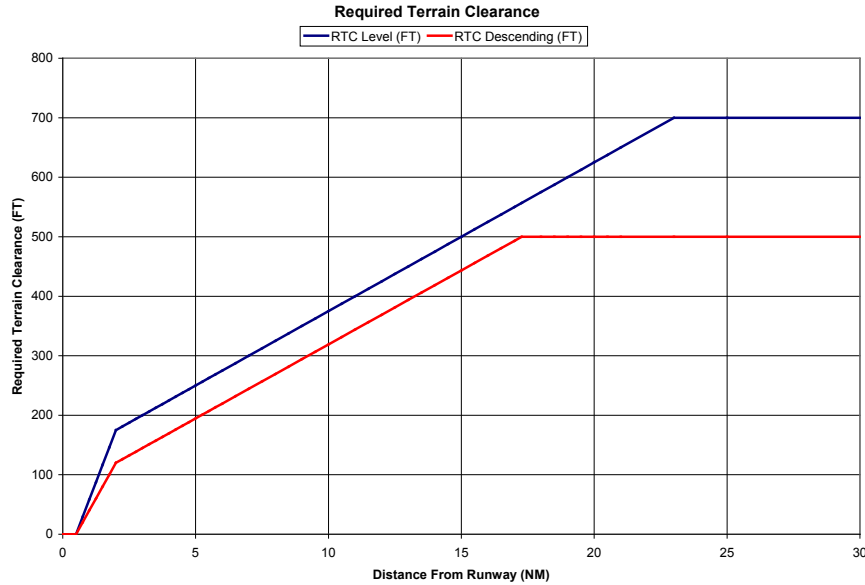

Figure 6-81 FLTA Minimum Terrain and Obstacle Values

FLTA alerts are automatically inhibited when the aircraft is less than 200 feet above the destination runway elevation while within 0.5 nm of the approach runway or the aircraft is between runway ends.

**PREMATURE DESCENT ALERTING**

A **Premature Descent Alert (PDA)** is issued when the system detects that the aircraft is significantly below the normal approach path to a runway (Figure 6-82).

PDA alerting begins when the aircraft is below 700 feet AGL within 15 nm of the destination airport and ends when the aircraft is 0.5 nm from the runway threshold.

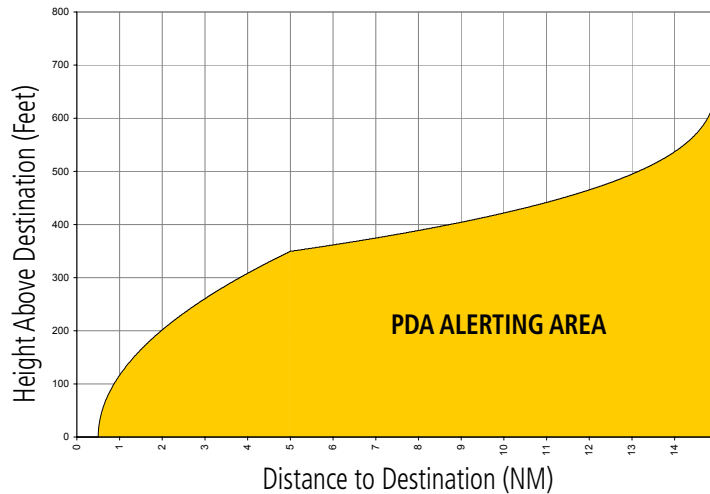

Figure 6-82 PDA Alerting Threshold

PDA and FLTA aural and visual alerts can be manually inhibited. Discretion should be used when inhibiting these alerts, and the system should be enabled when appropriate. When PDA and FLTA alerts are inhibited, the alert annunciation ‘TAWS INH’ is shown on the PFD and MFD (Figure 6-83).

**TAWS INH**

**Figure 6-83 TAWS Alerting Disabled  
(TAWS-B Inhibited) Annunciation**

**Inhibiting/enabling TAWS-B PDA and FLTA alerting:**

- 1) Select the TAWS-B Page.
- 2) Select the **INHIBIT** Softkey to inhibit or enable TAWS (choice dependent on current state).

**Or:**

- a) Press the **MENU** Key.
- b) Select 'Inhibit TAWS' or 'Enable TAWS' (choice dependent on current state) and press the **ENT** Key.

If TAWS-B alerts are inhibited when the Final Approach Fix is the active waypoint in a GPS SBAS approach, a 'LOW ALT' annunciation may appear on the PFD next to the Altimeter if the current aircraft altitude is at least 164 feet below the prescribed altitude at the Final Approach Fix. See the Flight Instruments Section for details.

**FIVE-HUNDRED AURAL ALERT**

The purpose of the aural alert message **"Five-hundred"** is to provide an advisory alert of when the aircraft descends to within 500 feet above the terrain or runway threshold. When the aircraft is within 5 nm of an airport, the **"Five Hundred"** aural alert is based on the nearest runway threshold elevation. When the aircraft is more than 5 nm of the nearest airport, the **"Five Hundred"** aural alert is based on the height above terrain.

There are no display annunciations or pop-up alerts that accompany the **"Five Hundred"** aural alert.

**NEGATIVE CLIMB RATE AFTER TAKEOFF ALERT**

The **Negative Climb Rate (NCR) After Takeoff** alert (also referred to as "Altitude Loss After Takeoff") provides alerts when the system determines the aircraft is losing altitude (closing upon terrain) after takeoff. The aural message "Don't Sink" is given for NCR alerts, accompanied by an annunciation and a pop-up terrain alert on the display. NCR alerting is only active when departing from an airport and when the following conditions are met:

- Height above the terrain is less than 700 feet
- Distance from the departure airport is 2 nm or less
- Heading change from the departure heading is less than 110 degrees

Figures 6-84 and 6-85 shows the NCR alerting parameters based on altitude loss and sink rate, respectively, as defined by TSO-C151b.

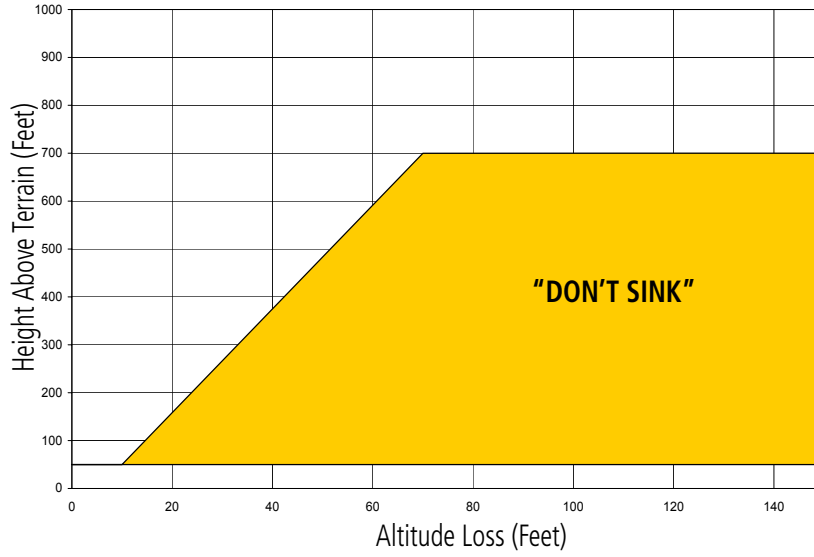

**Figure 6-84 Negative Climb Rate (NCR) Altitude Loss**

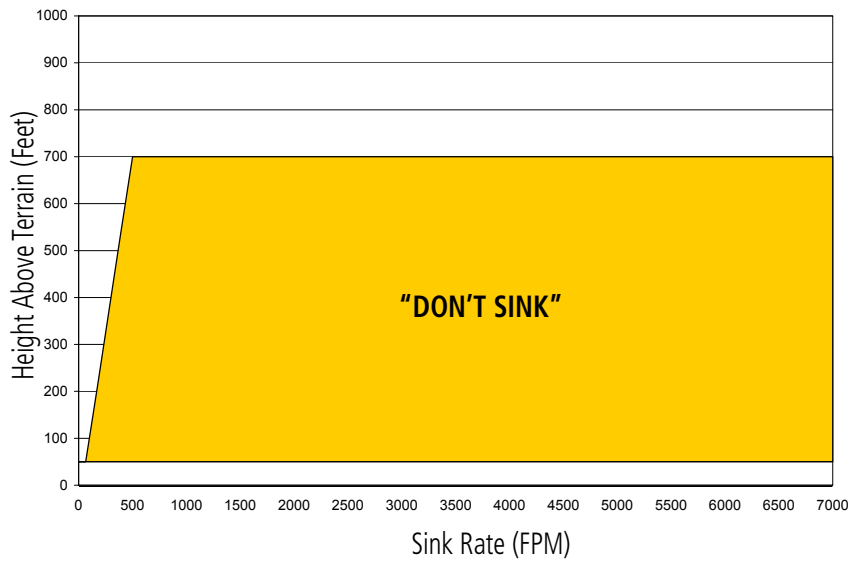

**Figure 6-85 Negative Climb Rate (NCR) Sink Rate**

## SYSTEM STATUS

During power-up, TAWS-B conducts a self-test of its aural and visual annunciations. The system test can also be manually initiated. The system issues an aural alert when the test has completed. TAWS-B System Testing is disabled when ground speed exceeds 30 knots.

Alert Type	PFD/MFD Alert Annunciation	TAWS-B Page Center Annunciation	Aural Message
System Test in Progress	TAWS TEST	TAWS TEST	None
System Test Pass	None	None	"TAWS System Test OK"
TAWS-B System Test Fail	TAWS FAIL	TAWS FAIL	"TAWS System Failure"

Table 6-11 TAWS-B System Test Status Annunciations

### Manually testing the TAWS-B System:

- 1) Select the TAWS-B Page.
- 2) Press the **MENU** Key (Figure 6-86).
- 3) Select 'Test TAWS System' and press the **ENT** Key to confirm the selection.

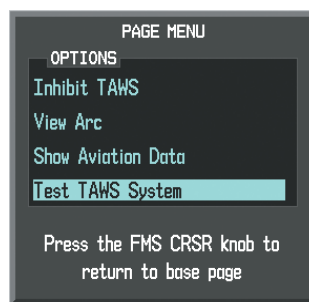

Figure 6-86 TAWS-B Page Menu

TAWS-B continually monitors several system-critical items such as database validity, hardware status, and GPS status. If the terrain/obstacle database is not available, the aural message "**TAWS System Failure**" is generated along with the 'TAWS FAIL' alert annunciation.

TAWS-B requires a 3-D GPS navigation solution along with specific vertical accuracy minimums. Should the navigation solution become degraded or if the aircraft is out of the database coverage area, the annunciation 'TAWS N/A' is generated in the annunciation window and on the TAWS-B Page. The aural message "**TAWS Not Available**" is generated. When sufficient GPS signal is received and the aircraft is within the terrain database coverage area, the aural message "**TAWS Available**" is generated.



Alert Cause	PFD/MFD* Annunciation	TAWS-B Page Center Banner Annunciation	Aural Message
MFD Terrain or Obstacle database unavailable or invalid. TAWS operating with PFD Terrain or Obstacle databases	None	<b>TERRAIN DATABASE FAILURE</b>	None
Terrain or Obstacle database unavailable or invalid on all displays, invalid software configuration, TAWS audio fault	<b>TAWS FAIL</b>	<b>TAWS FAIL</b>	"TAWS System Failure"
No GPS position	<b>TAWS N/A</b>	<b>NO GPS POSITION</b>	"TAWS Not Available"
Excessively degraded GPS signal, aircraft outside of terrain database coverage area	<b>TAWS N/A</b>	None	"TAWS Not Available"

\*Annunciation appears on MFD pages when terrain is displayed.

**Table 6-12 TAWS-B Abnormal Conditions**

## 6.4 TAWS-A



---

**WARNING:** Do not use TAWS information for primary terrain avoidance. TAWS-A is intended only to enhance situational awareness.

---



---

**NOTE:** Terrain data is not displayed when the aircraft is outside of the installed terrain database coverage area.

---



---

**NOTE:** The data contained in the TAWS databases comes from government agencies. Garmin accurately processes and cross-validates the data but cannot guarantee the accuracy and completeness of the data.

---

TAWS-A (Terrain Awareness and Warning System - Class A) is an optional feature designed to increase situational awareness and aid in reducing controlled flight into terrain (CFIT). TAWS-A provides visual and aural annunciations when terrain and obstacles are within the given altitude threshold from the aircraft. The displayed alerts and warnings are advisory in nature only. When TAWS-A is installed, it supersedes the TAWS-B feature.

TAWS-A satisfies TSO-C151b Class A and TSO-92c requirements for certification.

Class A TAWS requires the following components:

- A valid terrain/obstacle/airport terrain database
- A valid 3-D GPS position solution
- Valid flap and landing gear status inputs
- A valid radar altimeter

TAWS-A uses terrain and obstacle information supplied by government sources. Terrain information is based on terrain elevation information in a database that may contain inaccuracies. Individual obstructions may be shown if available in the database. The data undergoes verification by Garmin to confirm accuracy of the content, per TSO-C151b. However, the displayed information should never be understood as being all-inclusive and data may be inaccurate.

TAWS-A uses information from the GPS receiver to provide a horizontal position and altitude, along with additional altitude input from the radar altimeter. GPS altitude is derived from satellite measurements. GPS altitude is then converted to the height above geodetic sea level (GSL), which is the height above mean sea level (MSL) calculated geometrically. GSL altitude is used in part to determine TAWS-A alerts. GSL altitude accuracy is affected by satellite geometry, but is not subject to variations in pressure and temperature that normally affect pressure altitude sensors. GSL altitude does not require local altimeter settings to determine MSL altitude. It is a widely-used MSL altitude source. Therefore, GSL altitude provides a highly accurate and reliable MSL altitude source to calculate terrain and obstacle alerts.

The terrain and obstacle databases used by TAWS-A are referenced to mean sea level (MSL). Using the GPS position and GPS-GSL altitude, TAWS-A displays a 2-D picture of the surrounding terrain and obstacles relative to the position and altitude of the aircraft. Furthermore, the GPS position and GPS-GSL altitude are used to calculate and “predict” the aircraft’s flight path in relation to the surrounding terrain and obstacles. In this manner, TAWS-A can provide advanced alerts of predicted dangerous terrain conditions.

Class A TAWS incorporates radar altimeter input with the GPS-GSL altitude to provide a more accurate position reference when at lower altitudes for certain alert types, and to retain a level of ground proximity warning capability in the unlikely event of an airport, terrain or obstacle database failure.

Baro-corrected altitude (or indicated altitude) is derived by adjusting the altimeter setting for local atmospheric conditions. The most accurate baro-corrected altitude can be achieved by frequently updating the altimeter setting to the nearest reporting station along the flight path. However, because actual atmospheric conditions seldom match the standard conditions defined by the International Standard Atmosphere (ISA) model (where pressure, temperature, and lapse rates have fixed values), it is common for the baro-corrected altitude (as read from the altimeter) to differ from the GPS-MSL altitude. This variation results in the aircraft's true altitude differing from the baro-corrected altitude.

TAWS-A provides the following alert types:

- Forward Looking Terrain Avoidance (FLTA) Alerting, which consists of:
  - Required Terrain Clearance (RTC) / Required Obstacle Clearance (ROC) Alerting
  - Imminent Terrain Impact (ITI) / Imminent Obstacle Impact (IOI) Alerting
- Premature Descent Alerting (PDA)
- Ground Proximity Warning System (GPWS) Alerting, which consists of:
  - Excessive Descent Rate (EDR) Alerting
  - Excessive Closure Rate (ECR) to Terrain Alerting
  - Flight Into Terrain (FIT) Alerting
  - Negative Climb Rate (NCR) after takeoff Alerting
  - Excessive below Glideslope/Glidepath Deviation (GSD) Alerting
  - Altitude Voice Call Out (VCO) Alerting

**DISPLAYING TAWS-A DATA**

TAWS-A uses yellow (caution) and red (warning) to depict terrain and obstacles (with heights greater than 200 feet above ground level, AGL) alerts relative to aircraft altitude. Colors are adjusted automatically as the aircraft altitude changes. The colors and symbols in Figure 6-87 and Tables 6-13 and 6-14 are used to represent terrain, obstacles, and potential impact points.

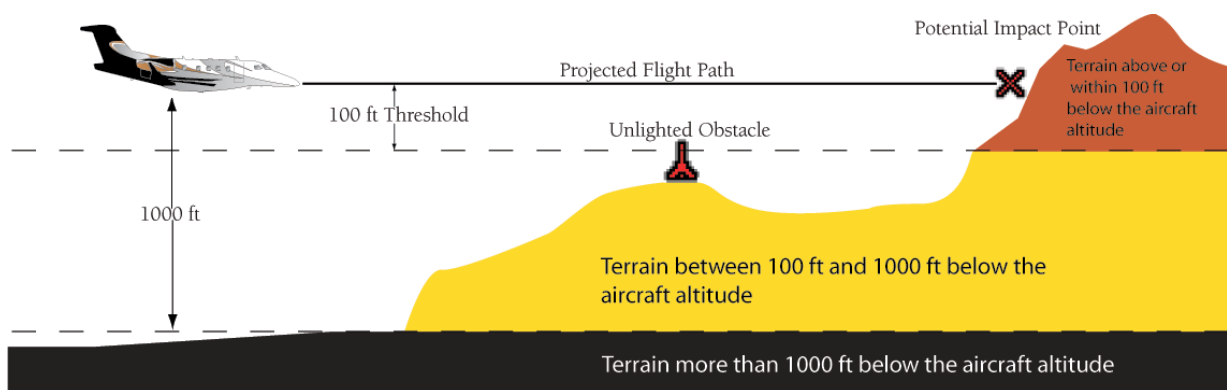

**Figure 6-87 Terrain Altitude/Color Correlation for TAWS-A**









Unlighted Obstacle		Lighted Obstacle		Obstacle Location
< 1000' AGL	> 1000' AGL	< 1000' AGL	> 1000' AGL	
				Red obstacle is above or within 100 ft below the aircraft altitude
				Yellow obstacle is between 100 ft and 1000 ft below the aircraft altitude

Table 6-13 TAWS-B Obstacle Colors and Symbology





Potential Impact Point Symbol	Alert Type	Example Annunciation
	Warning	
	Caution	

Table 6-14 TAWS-B Potential Impact Point Symbols with Alert Types

## TAWS-A PAGE

The Map - TAWS-A Page shows terrain, obstacle, and potential impact point data in relation to the aircraft's current altitude, without clutter from the basemap. It is the principal map page for viewing TAWS-A information. Aviation data (airports, VORs, and other NAVAIDs) can be displayed for reference. If an obstacle and the projected flight path of the aircraft intersect, the display automatically zooms in to the closest potential point of impact on the TAWS-A Page.

Aircraft orientation on this map is always heading up unless there is no valid heading. Two views are available relative to the position of the aircraft: the 360° default display and the radar-like ARC (120°) display. Map range is adjustable with the **RANGE** Knob from 1 to 200 nm, as indicated by the map range rings (or arcs).

### Displaying the TAWS-A Page:

- 1) Turn the large **FMS** Knob to select the Map Page Group.
- 2) Turn the small **FMS** Knob to select the TAWS-A Page.

### Changing the TAWS-A Page view:

- 1) Select the **VIEW** Softkey.
- 2) Select the **360** or **ARC** Softkey to select the desired view.

Or:

- 1) Press the **MENU** Key.
- 2) Select 'View Arc' or 'View 360°' (choice dependent on current state) and press the **ENT** Key to change the view

**Showing/hiding aviation information on the TAWS-A Page:**

- 1) Press the **MENU** Key.
- 2) Select 'Show Aviation Data' or 'Hide Aviation Data' (choice dependent on current state) and press the **ENT** Key.

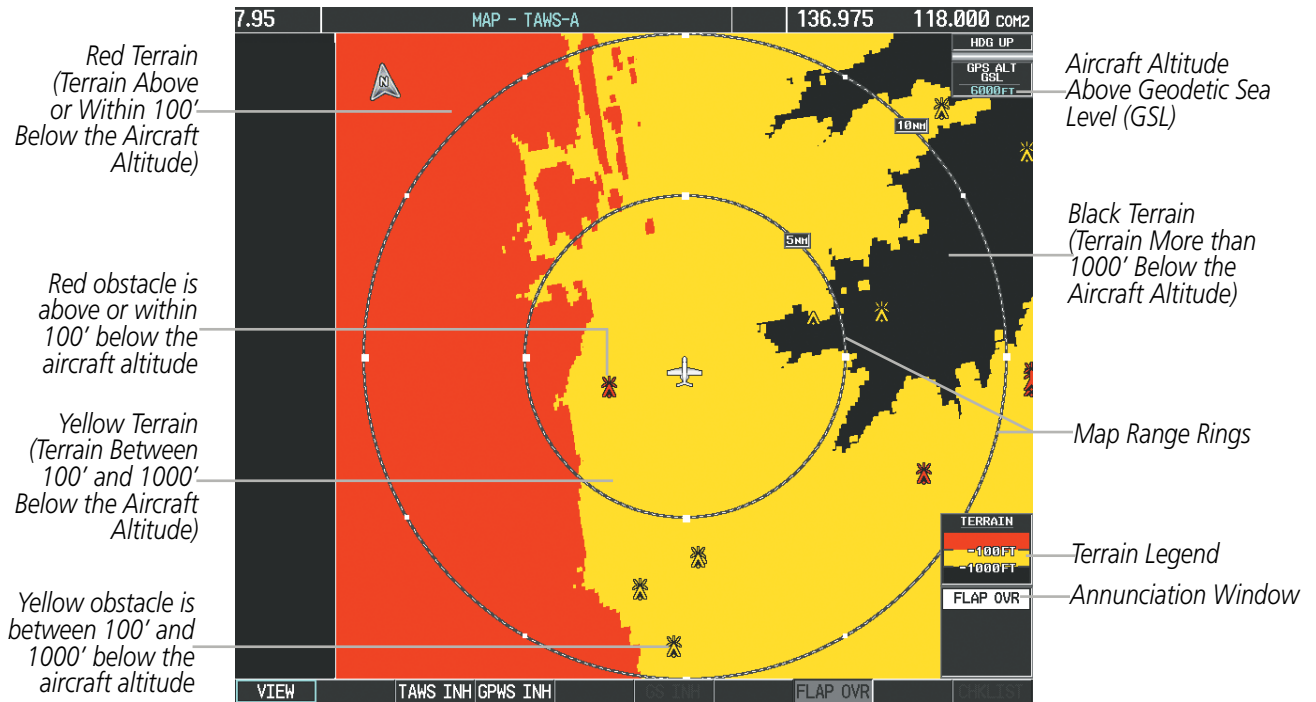

**Figure 6-88 TAWS-A Page (360 View)**

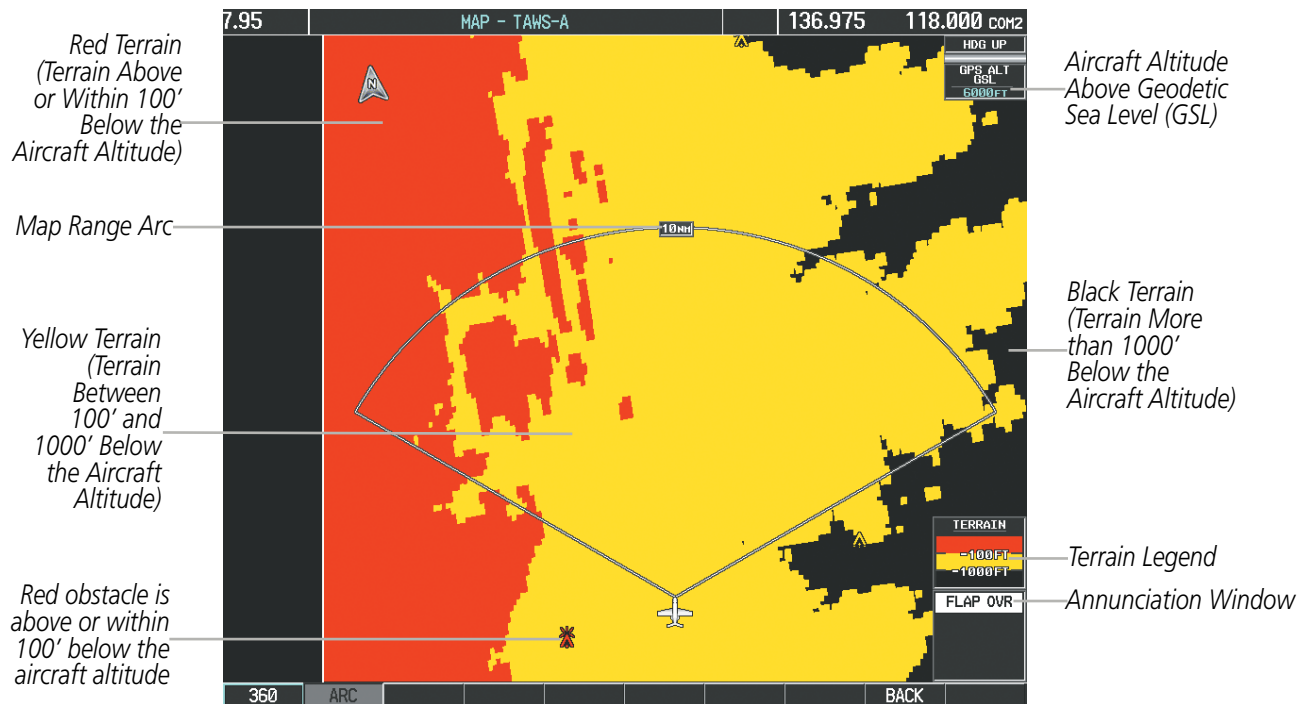

**Figure 6-89 TAWS-A Page (Arc View)**

## TAWS-A ALERTS

Alerts are issued when flight conditions meet parameters that are set within TAWS-A software algorithms. TAWS-A alerts typically employ a CAUTION or a WARNING alert severity level, or both. When an alert is issued, visual annunciations are displayed and aural alerts are simultaneously issued. Table 6-15 shows TAWS-A alert types with corresponding annunciations and aural messages.

When an alert is issued, annunciations appear on the PFD and MFD. The TAWS-A Alert Annunciation is shown to the upper left of the Altimeter or upper right of the Airspeed indicator on the PFD and below the Terrain Legend on the MFD. If the TAWS-A Page is not already displayed on the MFD, a pop-up alert appears on the MFD while an alert is active. To acknowledge the pop-up alert:

- Press the **CLR** Key (returns to the currently viewed page), or
- Press the **ENT** Key (accesses the TAWS-A Page)



PFD with TAWS-A Annunciations

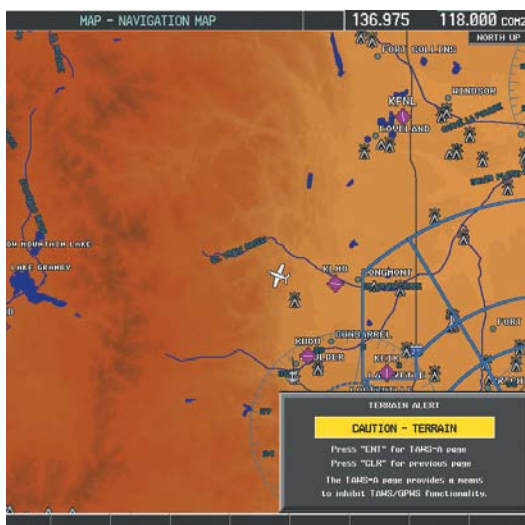

MFD Pop-Up Alert (except TAWS-A Page)

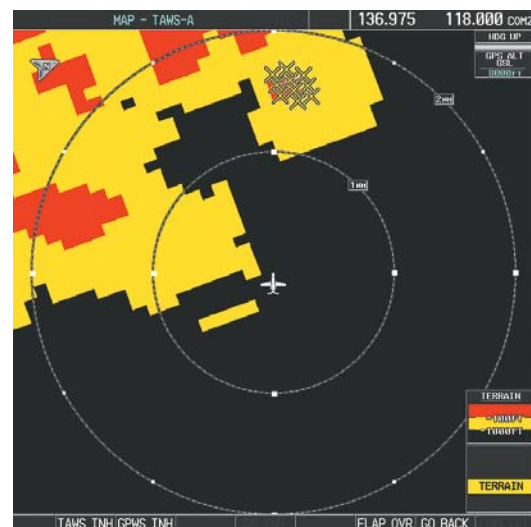

MFD TAWS-A Page with Alert Annunciation

Figure 6-90 TAWS-A Annunciations



Alert Type	PFD/MFD TAWS-A Page Annunciation	MFD Map Page Pop-Up Alert (except TAWS-A Page)	Aural Message
Reduced Required Terrain Clearance Warning (RTC)	<b>PULL UP</b>	<b>TERRAIN - PULL-UP</b>	"Terrain, Terrain; Pull Up, Pull Up"
Imminent Terrain Impact Warning (ITI)	<b>PULL UP</b>	<b>TERRAIN - PULL-UP</b>	"Terrain, Terrain; Pull Up, Pull Up"
Reduced Required Obstacle Clearance Warning (ROC)	<b>PULL UP</b>	<b>OBSTACLE - PULL-UP</b>	"Obstacle, Obstacle; Pull Up, Pull Up"
Imminent Obstacle Impact Warning (IOI)	<b>PULL UP</b>	<b>OBSTACLE - PULL-UP</b>	"Obstacle, Obstacle; Pull Up, Pull Up"
Excessive Descent Rate Warning (EDR)	<b>PULL UP</b>	<b>PULL-UP</b>	"<whoop> <whoop> Pull Up"
Excessive Closure Rate Warning (ECR)	<b>PULL UP</b>	<b>PULL-UP</b>	"<whoop> <whoop> Pull Up"
Reduced Required Terrain Clearance Caution (RTC)	<b>TERRAIN</b>	<b>CAUTION - TERRAIN</b>	"Caution, Terrain; Caution, Terrain"
Imminent Terrain Impact Caution (ITI)	<b>TERRAIN</b>	<b>CAUTION - TERRAIN</b>	"Caution, Terrain; Caution, Terrain"
Reduced Required Obstacle Clearance Caution (ROC)	<b>TERRAIN</b>	<b>CAUTION - OBSTACLE</b>	"Caution, Obstacle; Caution, Obstacle"
Imminent Obstacle Impact Caution (IOI)	<b>TERRAIN</b>	<b>CAUTION - OBSTACLE</b>	"Caution, Obstacle; Caution, Obstacle"
Premature Descent Alert Caution (PDA)	<b>TERRAIN</b>	<b>TOO LOW - TERRAIN</b>	"Too Low, Terrain"
Excessive Descent Rate Caution (EDR)	<b>TERRAIN</b>	<b>SINK RATE</b>	"Sink Rate"
Excessive Closure Rate Caution (ECR)	<b>TERRAIN</b>	<b>TERRAIN</b>	"Terrain, Terrain"
Negative Climb Rate Caution (NCR)	<b>TERRAIN</b>	<b>DON'T SINK</b> *	"Don't Sink"
Flight Into Terrain High Speed Caution (FIT)	<b>TERRAIN</b>	<b>TOO LOW - TERRAIN</b>	"Too Low, Terrain"
Flight Into Terrain Gear Caution (FIT)	<b>TERRAIN</b>	<b>TOO LOW - GEAR</b>	"Too Low, Gear"
Flight Into Terrain Flaps Caution (FIT)	<b>TERRAIN</b>	<b>TOO LOW - FLAPS</b>	"Too Low, Flaps"
Flight Into Terrain Takeoff Caution (FIT)	<b>TERRAIN</b>	<b>TOO LOW - TERRAIN</b>	"Too Low, Terrain"
Glide Slope/Glide Path Deviation Caution (GSD) (depends on approach type)	<b>GLIDESLOPE</b> or <b>GLIDEPATH</b>	<b>GLIDESLOPE</b> or <b>GLIDEPATH</b>	"Glide Slope" or "Glide Path"
Altitude Voice Callout (VCO)	None	None	"Five-Hundred", "Four-Hundred", "Three-Hundred"*, "Two-Hundred", "One-Hundred"

**Table 6-15 TAWS-A Alerts**



## FORWARD LOOKING TERRAIN AVOIDANCE

The Forward Looking Terrain Avoidance feature of TAWS-A compares the aircraft's projected flight path with known terrain and obstacles in their respective databases and issues four types of alerts as either a caution or a warning:

**Reduced Required Terrain Clearance (RTC)** and **Reduced Required Obstacle Clearance (ROC)** alerts are issued when the aircraft flight path is above terrain, yet is projected to come within the minimum clearance values in Figure 6-91. When an RTC alert is issued, a potential impact point is displayed on the TAWS-A Page.

**Imminent Terrain Impact (ITI)** and **Imminent Obstacle Impact (IOI)** alerts are issued when the aircraft is below the elevation of a terrain or obstacle cell in the aircraft's projected path. ITI and IOI alerts are accompanied by a potential impact point displayed on the TAWS-A Page. The alert is annunciated when the projected vertical flight path is calculated to come within minimum clearance altitudes in Figure 6-91.



Figure 6-91 FLTA Alert Minimum Terrain and Obstacle Clearance Values

FLTA alerts are automatically inhibited when the aircraft is less than 200 feet above the destination runway elevation while within 0.5 nm of the approach runway or the aircraft is between runway ends.

### PREMATURE DESCENT ALERTING

A **Premature Descent Alert (PDA)** is issued when the system detects that the aircraft is significantly below the normal approach path to a runway (Figure 6-92).

PDA alerting begins when the aircraft is below 700 feet AGL within 15 nm of the destination airport and ends when the aircraft is 0.5 nm from the runway threshold.

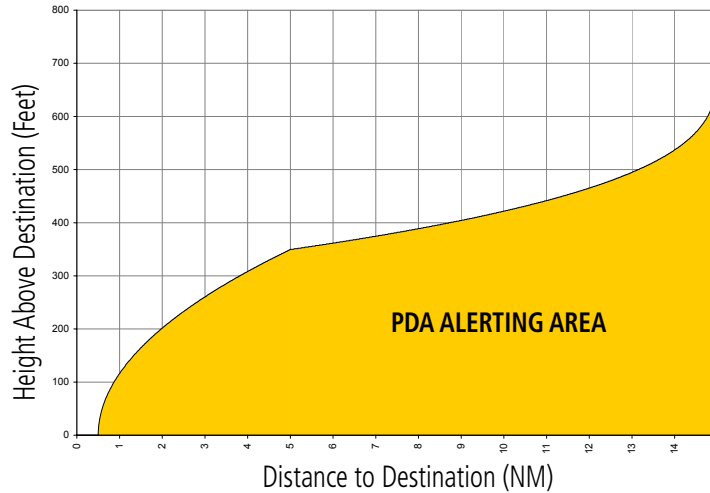

Figure 6-92 PDA Alerting Threshold

### INHIBITING FLTA AND PDA ALERTS



**NOTE:** The 'Inhibit TAWS' function only inhibits FLTA and PDA alerts. Alerting for GPWS alerts (EDR, ECR, NCR, FIT) and GSD is controlled independently from FLTA and PDA alerts.

FLTA and PDA aural and visual alerts can be manually inhibited. Discretion should be used when inhibiting alerts and the system should be enabled when appropriate. When PDA and FLTA alerts are inhibited, the alert annunciation 'TAWS INH' is shown on the PFD and on the TAWS-A Page annunciation window of the MFD (Figure 6-93).



Figure 6-93 TAWS-A Page Menu and Inhibit Annunciation

**Inhibiting/enabling FLTA and PDA alerting:**

- 1) Select the TAWS-A Page.
- 2) Select the **TAWS INH** Softkey to inhibit or enable TAWS-A (choice dependent on current state).

**Or:**

- 1) Press the **MENU** Key. (Figure 6-93)
- 2) Select 'Inhibit TAWS' or 'Enable TAWS' (choice dependent on current state) and press the **ENT** Key.

If PDA and FLTA alerts are inhibited when the Final Approach Fix is the active waypoint in a GPS SBAS approach, a 'LOW ALT' annunciation may appear on the PFD next to the Altimeter if the current aircraft altitude is at least 164 feet below the prescribed altitude at the Final Approach Fix. See the Flight Instruments Section for details.

**EXCESSIVE DESCENT RATE ALERT**

The purpose of the **Excessive Descent Rate (EDR)** alert is to provide suitable notification when the aircraft is determined to be closing (descending) upon terrain at an excessive speed. Figure 6-94 shows the parameters for the alert as defined by TSO-C151b.

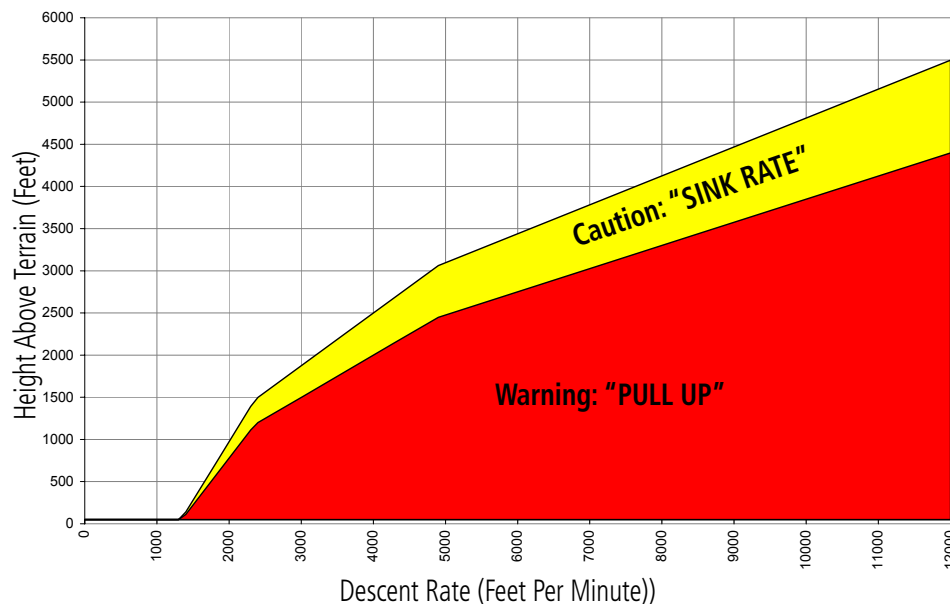

Figure 6-94 Excessive Descent Rate Alert Criteria

**EXCESSIVE CLOSURE RATE ALERT**

The **Excessive Closure Rate (ECR)** alert provides suitable notification when the aircraft is determined to be closing upon terrain at an excessive speed for a given aircraft gear and flap configuration.

Figures 6-95 and 6-96 show the ECR alerting criteria for flaps in the landing configuration and for all other flight phases respectively.

ECR alerts are automatically inhibited when the aircraft is 5 nm from the nearest airport, except when FLTA is not available (causing the TAWS N/A or TAWS FAIL annunciation), in which case ECR alerting will remain active until landing.

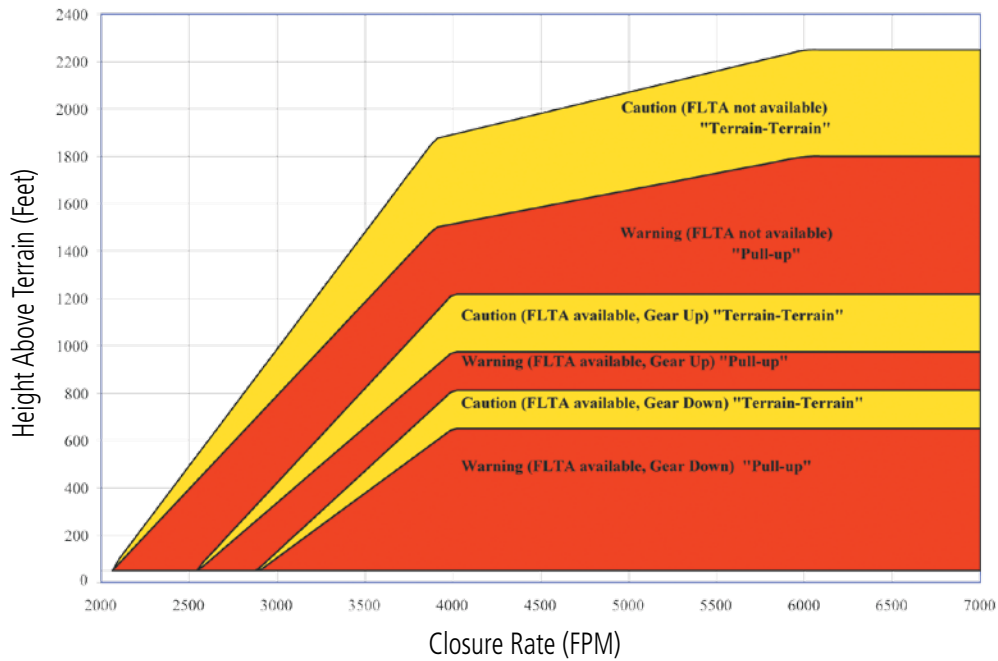

**Figure 6-95 Excessive Closure Rate Alert Criteria (Flaps Up or Takeoff Configuration)**

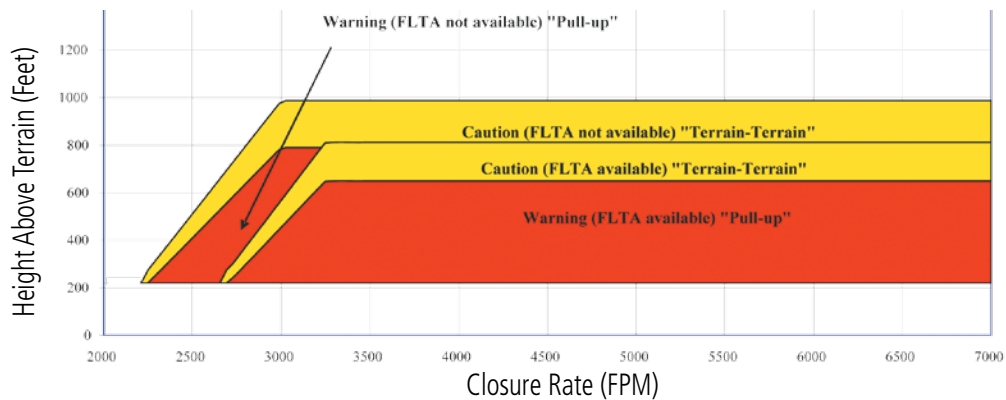

**Figure 6-96 Excessive Closure Rate Alert Criteria (Flaps in Landing Configuration)**

**FLIGHT INTO TERRAIN ALERT**

**Flight Into Terrain (FIT)** caution alerts occur when the aircraft is too low with respect to terrain and the gear or flaps are not configured for landing. The aircraft may also be above or below the recommended approach speed. FIT alerts are issued when flight conditions meet the criteria shown in Figure 6-97.

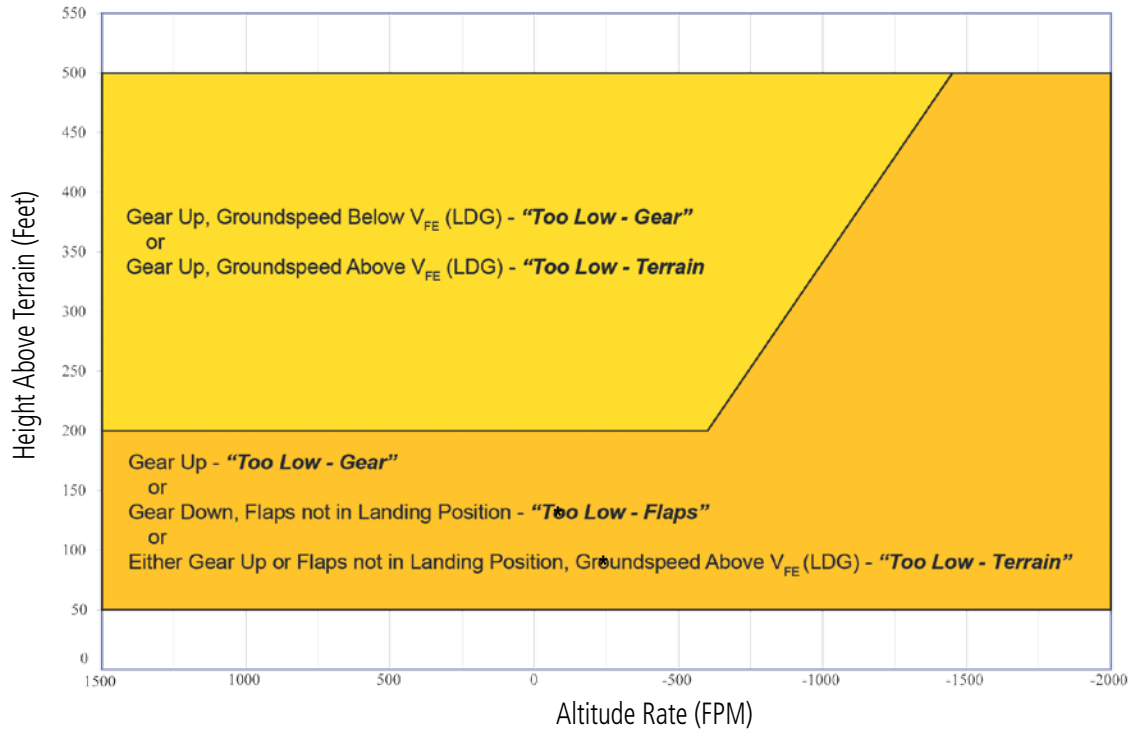

\* Flap position will not trigger alert if Flap Override option is enabled; see discussion below.

Figure 6-97 Flight Into Terrain Alert Criteria (Aircraft Configuration)

To reduce nuisance FIT alerts on approaches where flap extension is not desired (or is intentionally delayed), the pilot may override FIT alerting based on the flap position, while all other FIT alerting remains in effect.

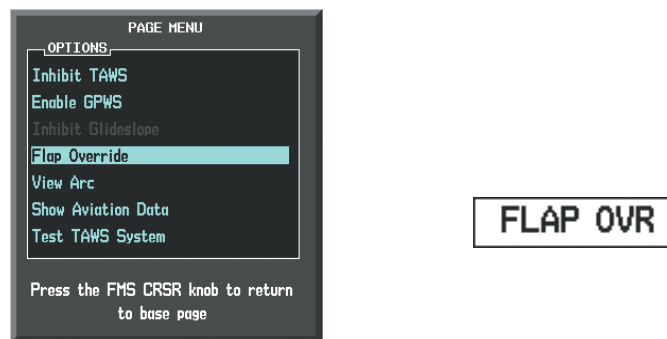

Figure 6-98 TAWS-A Page Menu and FIT Flap Override Annunciation

### Overriding Flaps-based FIT alerting:

- 1) Select the TAWS-A Page
- 2) Select the **FLAP OVR** Softkey

**Or:**

- 1) Press the **MENU** Key. (Figure 6-98)
- 2) Select 'Flap Override' or 'Disable Flap Override' (choice dependent on current state) and press the **ENT** Key.

When the Flaps Override option is enabled, the annunciation ‘FLAP OVR’ is annunciated on the PFD and on the TAWS-A Page of the MFD (Figure 6-98). If GPWS alerts are also inhibited (which include FIT), the ‘FLAP OVR’ annunciation is not shown.

FIT alerts also occur during takeoff or go-around if the aircraft’s height above ground level (as determined by the radar altimeter) is too close to rising terrain. TAWS-A will issue the aural message “**Too Low - Terrain**” and visual annunciations when conditions enter the caution alert area (Figure 6-99).

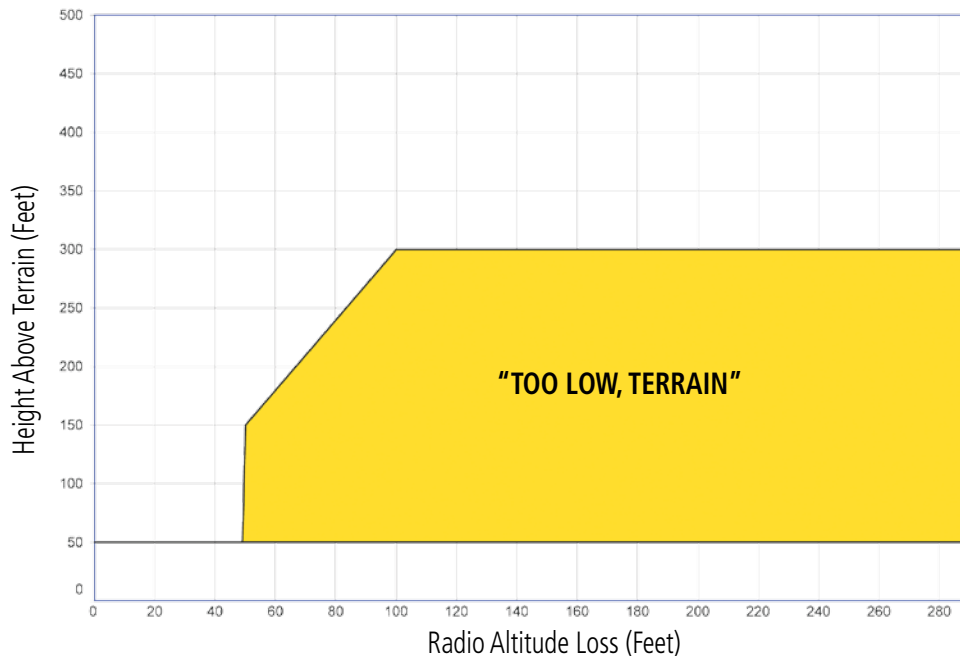

Figure 6-99 FIT Alerting After Takeoff

**NEGATIVE CLIMB RATE AFTER TAKEOFF ALERT**

The **Negative Climb Rate (NCR) After Takeoff** alert (also referred to as “Altitude Loss After Takeoff”) provides alerts when the system determines the aircraft is losing altitude (closing upon terrain) after takeoff. The aural message “Don’t Sink” is given for NCR alerts, accompanied by an annunciation and a pop-up terrain alert on the MFD if the TAWS-A Page is not already displayed. NCR alerting for TAWS-A is only active when departing from an airport and when the following conditions are met:

- Height above the terrain is less than 700 feet
- Distance from the departure airport is 5 nm or less
- Heading change from the departure heading is less than 110 degrees
- Landing gear or flaps are configured for takeoff

Figures 6-100 and 6-101 show the NCR alerting parameters based on altitude loss and sink rate, respectively, as defined by TSO-C151b

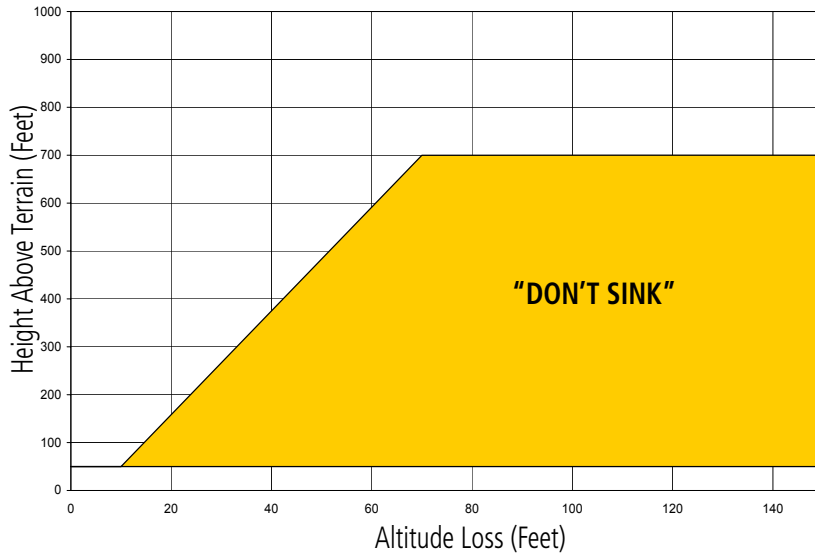

Figure 6-100 Negative Climb Rate (NCR) Altitude Loss

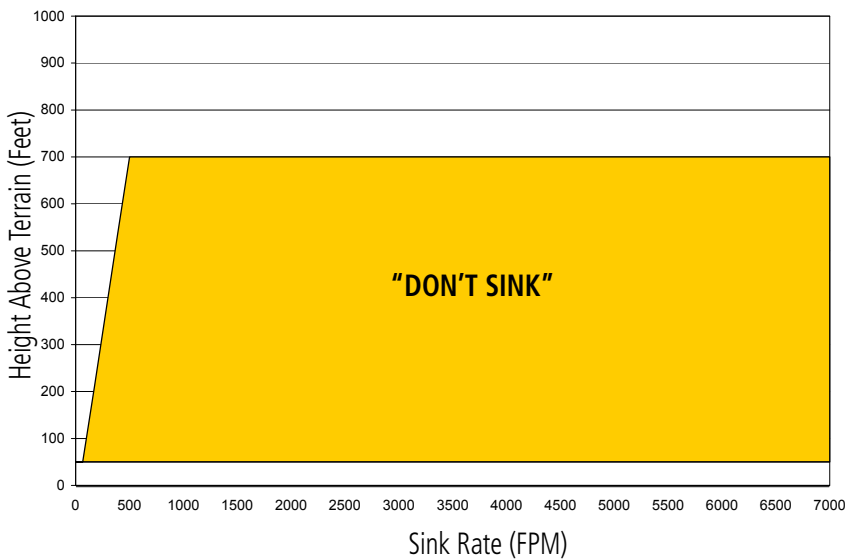

Figure 6-101 Negative Climb Rate (NCR) Sink Rate



**INHIBITING GPWS ALERTS (EDR, ECR, FIT, AND NCR)**



**NOTE:** The 'Inhibit GPWS' function only affects GPWS alerts (EDR, ECR, NCR, and FIT). Alerting for FLTA, PDA, and GSD is controlled independently from the GPWS alerts listed below.

EDR, ECR, FIT, and NCR aural and visual alerts can be manually inhibited as a group. Discretion should be used when inhibiting alerts and the GPWS system should be enabled when appropriate. When these alerts are inhibited, the alert annunciation 'GPWS INH' is shown on the PFD and on the TAWS-A Page annunciation window of the MFD (Figure 6-102).



Figure 6-102 TAWS-A Page Menu and GPWS Inhibit Annunciation

**Inhibiting/enabling GPWS alerting:**

- 1) Select the TAWS-A Page.
  - 2) Select the **GPWS INH** Softkey to inhibit or enable GPWS alerts (choice dependent on current state).
- Or:**
- a) Press the **MENU** Key. (Figure 6-102)
  - b) Select 'Inhibit GPWS' or 'Enable GPWS' (choice dependent on current state) and press the **ENT** Key.

## EXCESSIVE BELOW GLIDESLOPE/GLIDEPATH DEVIATION ALERT

A **Glideslope Deviation** or **Glidepath Deviation (GSD)** caution alert is issued when the system detects that the aircraft is significantly below the glidepath for the selected approach in relation to the aircraft's height above terrain (Figure 6-103).

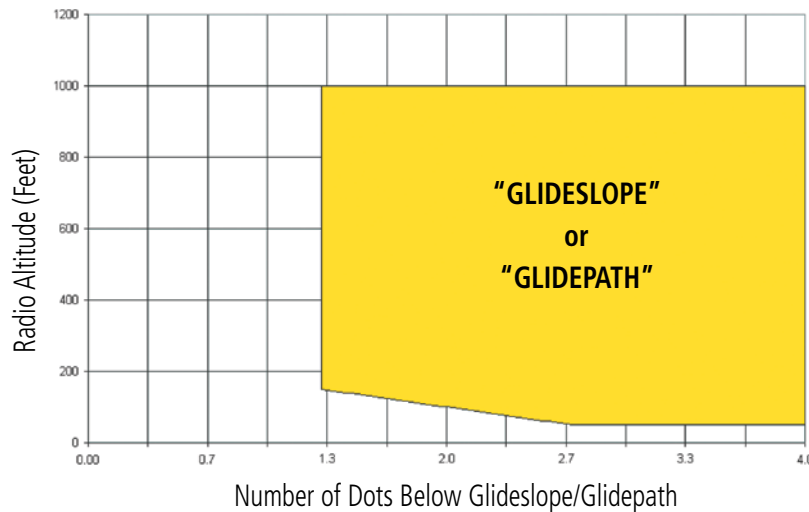

Figure 6-103 Excessive Below Glideslope/Glidepath Deviation Alert Criteria

GSD alerting is available as the aircraft approaches a runway and the following conditions are met:

- An ILS, LPV, or LNAV/VNAV approach is active and vertical navigation indications are being displayed.
- Aircraft altitude is below 1000 feet AGL.
- Aircraft distance is within 5 nm of the runway, but greater than 1000 feet from the runway (if GPS position is available).
- Gear is configured for landing.

When a GSD caution alert occurs on an ILS approach, the aural and visual annunciation 'GLIDESLOPE' is issued. If a GSD caution alert occurs on an LPV or LNAV/VNAV approach, the aural and visual annunciation 'GLIDEPATH' is issued (Figure 6-104).

### INHIBITING GSD ALERTS



**NOTE:** GSD alerting may only be inhibited while a GSD alert is occurring. GSD alerts are inhibited independently from all other FLTA, PDA, and GPWS alerts.

During a GSD alert, the PFD Softkeys are displayed as shown in Figure 6-104 to provide an option to inhibit the alert. A 'GLIDESLOPE' alert will display a **GS INH** Softkey to inhibit the alert. A 'GLIDEPATH' alert will display a **GP INH** Softkey to inhibit the alert. When an inhibit Softkey is pressed, the PFD Softkeys return to the top-level display. Press the **BACK** Softkey to return to the top level of the PFD Softkeys without inhibiting the GSD alert.



Figure 6-104 GSD Alert and PFD Softkeys

GSD alerts may also be inhibited on the TAWS-A Page while a GSD alert is occurring.

**Inhibiting/Enabling GSD alerting (only available during a GSD alert):**

- 1) Select the TAWS-A Page.
- 2) Select the **GS INH** or **GP INH** Softkey to inhibit or enable GSD alerts (softkey choice dependent on present GSD alert type).

Or:

- 1) Press the **MENU** Key. (Figure 6-105)
- 2) Select the option to inhibit or enable the glideslope or glidepath alerting (choice dependent on present GSD alert type) and press the **ENT** Key.

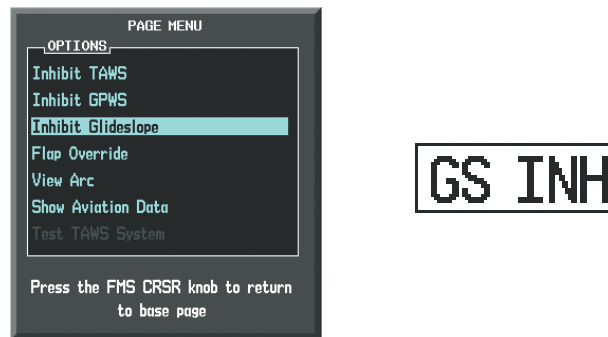

Figure 6-105 TAWS-A Page Menu and Glideslope Alerting Inhibited Annunciation

The annunciation 'GS INH' or 'GP INH' is displayed on the PFD and TAWS-A Page when GSD Alerting is inhibited. Discretion should be used when inhibiting GSD alerts. Inhibiting GSD alerts has no effect on the vertical guidance provided by the flight instruments.

## ALTITUDE VOICE CALLOUT (VCO)

TAWS-A provides aural altitude advisory alerts as the aircraft descends. VCO alerts are based on the height above terrain when the aircraft is more than 5 nm from an airport, or the height above the nearest runway threshold elevation if within 5 nm of an airport.

VCO alerts begin at 500 feet with the aural message **“Five Hundred”**. Maintenance personnel may configure additional VCO alerts to occur at 400, 300, 200 and 100 feet during descent.

There are no display annunciations or pop-up alerts that accompany the aural VCO alert(s).

## SYSTEM STATUS

During power-up, TAWS-A conducts a self-test of its aural and visual annunciations. The system test can also be manually initiated. A single chime is issued at test completion. TAWS-A System Testing is disabled when ground speed exceeds 30 knots. TAWS-A terrain alerts will not be issued while a test is in progress.

Alert Type	PFD/MFD TAWS-A Page Status Annunciation	Additional TAWS-A Page Annunciation	Aural Message
TAWS System Fail	<b>TAWS FAIL</b>	<b>TAWS FAIL</b>	“TAWS System Failure”
GPWS System Fail	<b>GPWS FAIL</b>	None	“GPWS System Failure”
System Test in progress	<b>TAWS TEST</b>	<b>TAWS TEST</b>	None
System Test pass	None	None	“TAWS System Test OK”

Table 6-16 TAWS-A System Test Status Annunciations

### Manually testing the TAWS-A System:

- 1) Select the TAWS-A Page.
- 2) Press the **MENU** Key.
- 3) Select 'Test TAWS System' and press the **ENT** Key to confirm the selection. (Figure 6-106)

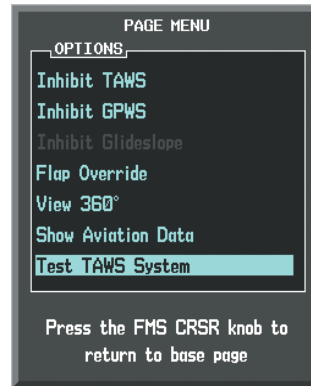

Figure 6-106 TAWS-A Page Menu

## TAWS-A ABNORMAL OPERATIONS

TAWS-A continually monitors several system-critical items such as database validity, flap and landing gear position, radar altimeter input, and GPS status.

If no GDU contains Terrain, Airport Terrain, and Obstacle databases (or the databases are invalid), the aural message **“TAWS System Failure”** is generated along with the ‘TAWS FAIL’ alert annunciation.

TAWS-A requires a 3-D GPS navigation solution along with specific vertical accuracy minimums. Should the navigation solution become degraded or if the aircraft is out of the database coverage area, the annunciation ‘TAWS N/A’ is generated in the annunciation window and on the TAWS-A Page. The aural message **“TAWS Not Available”** is also generated if airborne, and some TAWS-A terrain alerts will not be issued (Table 6-17), while GPWS alerting (which are not dependent on GPS position) will continue to operate. When the GPS signal is restored and the aircraft is within the database coverage area, the aural message “TAWS Available” is generated.

TAWS-A also requires radar altimeter input. Should the radar altimeter input fail or become degraded, the annunciation ‘GPWS FAIL’ is generated in the annunciation window and on the TAWS-A Page. The aural message **“GPWS System Failure”** is also generated. The ‘GPWS FAIL’ annunciation will also occur if both GPS altitude and barometric altitude are unavailable. If only the GPWS system has failed, GPWS-based alerts will not be available (Table 6-17), while other TAWS-A alerting remains unaffected.

Alert Type	PFD/MFD TAWS-A Page Annunciation	TAWS-A Page Center Banner Annunciation	Aural Message	TAWS Alert Types Not Available
TAWS System Test Fail; Terrain, Airport Terrain or Obstacle database unavailable or invalid on all GDUs; software mismatch among GDUs; TAWS audio fault	<b>TAWS FAIL</b> †	<b>TAWS FAIL</b>	"TAWS System Failure"	FLTA, PDA
MFD Terrain or Obstacle database unavailable or invalid. TAWS operating with PFD Terrain or Obstacle databases	None	<b>TERRAIN DATABASE FAILURE</b>	None	
No GPS position	<b>TAWS N/A</b>	<b>NO GPS POSITION</b>	"TAWS Not Available"	FLTA, PDA, GSD* VCO †
Excessively degraded GPS signal, or out of database coverage area	<b>TAWS N/A</b>	None	"TAWS Not Available"	FLTA, PDA
Sufficient GPS signal reception restored	None	None	"TAWS Available" (aural message only in flight)	
Radar Altimeter invalid, Vertical Speed Invalid, GPS and Baro Altitude invalid, Software mismatch among GDUs, TAWS configuration mismatch among GDUs, TAWS audio fault	<b>GPWS FAIL</b> †	None	"GPWS System Failure"	EDR, ECR, NCR, FIT, GSD

\* GSD alert will be available if a valid ILS is being used for navigation, even if no valid GPS signal is being received.

† VCO alerts are not issued if both TAWS and GPWS systems have failed or are not available.

**Table 6-17 TAWS-A Abnormal Status Alerts**

If the aircraft bank angle exceeds 30°, TAWS-A will disable ECR alerts. ECR alert availability returns when the bank angle is reduced for at least eight seconds.

On an ILS, LPV, or LNAV/VNAV approach, GSD alerting will not be available if the glidepath exceeds ten degrees.

## 6.5 TRAFFIC INFORMATION SERVICE (TIS)



**WARNING:** The Traffic Information Service (TIS) is intended for advisory use only. TIS is intended to help the pilot locate traffic visually. It is the responsibility of the pilot to see and maneuver to avoid traffic.



**NOTE:** TIS is available only when the aircraft is within the service volume of a TIS-capable terminal radar site. Aircraft without an operating transponder will not be displayed. Aircraft without altitude reporting capability are shown without altitude separation data or climb descent indication.



**NOTE:** TIS is disabled when a Traffic Alert and Collision Avoidance System II (TCAS II) is installed.

Traffic Information Service (TIS) is designed to help in detection and avoidance of other aircraft. TIS uses the Mode S transponder for the traffic data link. TIS receives traffic information from ground stations, and is updated every 5 seconds. The system displays up to eight traffic targets within a 7.5-nm radius, from 3000 feet below to 3500 feet above the requesting aircraft. Traffic is displayed with the following symbology:



TIS Symbol	Description
	Non-Threat Traffic
	Traffic Advisory (TA)
	Traffic Advisory Off Scale

Table 6-18 TIS Traffic Symbols

A Traffic Advisory (TA) indicates that the current track of the intruder could result in a collision. When traffic meets the advisory criteria for the TA, a solid yellow circle symbol is generated. A TA which is detected, but is outside the range of the map, is indicated with a message in the lower left corner of the map and a half TA symbol at the relative bearing of the intruder.

TIS also provides a vector line showing the direction in which the traffic is moving, to the nearest 45°. Traffic information for which TIS is unable to determine the bearing (non-bearing traffic) is displayed in the center of the Traffic Map Page (Figure 6-111) or in a banner at the lower left corner of maps other than the Traffic Map Page on which traffic can be displayed.

The altitude difference between the requesting aircraft and other intruder aircraft is displayed above/below the traffic symbol in hundreds of feet. If the other aircraft is above the requesting aircraft, the altitude separation appears above the traffic symbol; if below, the altitude separation appears below. Altitude trend is displayed as an up/down arrow (for vertical speeds at least 500 feet per minute in either direction) to the right of the target symbol. Traffic symbols for aircraft without altitude reporting capability appear without altitude separation or climb/descent information.



## DISPLAYING TRAFFIC DATA

Traffic information can be displayed on the following maps (when TIS is operating):

- PFD Inset Map
- Navigation Map Page
- Traffic Map Page
- Trip Planning Page
- Nearest Pages
- Active Flight Plan Page

Traffic information can also be displayed on the PFD when the Synthetic Vision System (SVS) option is installed and enabled. See the Additional Features Section for details.

### Displaying traffic information (maps other than the Traffic Map Page):

- 1) Select the **MAP** Softkey.
- 2) Select the **TRAFFIC** Softkey to display traffic data.

When traffic is selected on maps other than the Traffic Map Page, an the system displays a status icon to indicate the feature is enabled for display.

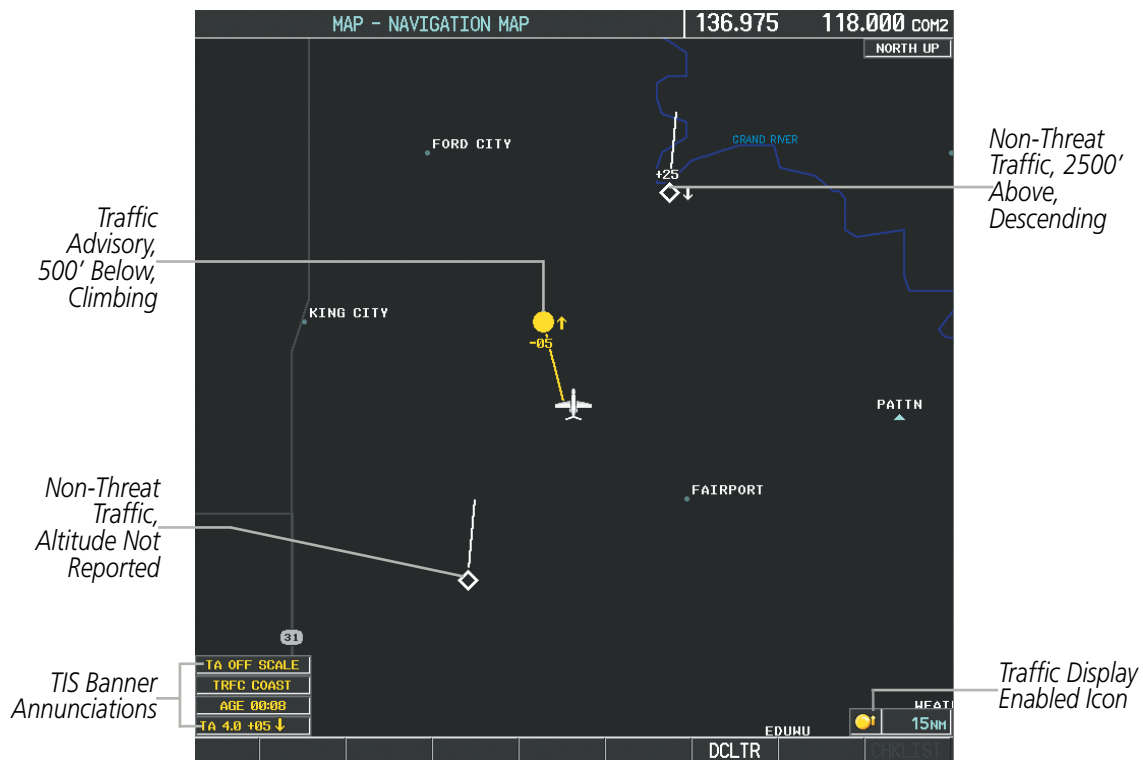

Figure 6-107 TIS Traffic on the Navigation Map Page

**Displaying traffic information (PFD Inset Map):**

- 1) Press the **INSET** Softkey.
- 2) Press the **TRAFFIC** Softkey to display traffic data on the inset map (TRFC-1).
- 3) Press the softkey again to display the traffic-only inset (TRFC-2).
- 4) Press the softkey again to remove traffic data.

The Navigation Map Page Setup Menu provides a means in addition to the softkey for enabling/disabling display of traffic. The setup menu also controls the map range settings above which traffic data (symbols and labels) are decluttered from the display. If a map range larger than the map range setting is selected, the data is removed from the map. Maps besides the Traffic Map Page use settings based on those selected for the Navigation Map Page.

**Customizing traffic display on the Navigation Map Page:**

- 1) Select the Navigation Map Page.
- 2) Press the **MENU** Key.
- 3) With 'Map Setup' highlighted, press the **ENT** Key (Figure 6-108).
- 4) Turn the small **FMS** Knob to select the 'Traffic' Group and press the **ENT** Key (Figure 6-109).
- 5) Turn the large **FMS** Knob or press the **ENT** Key to scroll through product selections (Figure 6-110).
  - **TRAFFIC** – Turns the display of traffic data on or off
  - **TRAFFIC MODE** – Selects the traffic mode for display; select from:
    - All Traffic - Displays all traffic
    - TA ONLY - Displays Traffic Advisories only
  - **TRAFFIC SMBL** – Selects the maximum range at which traffic symbols are shown
  - **TRAFFIC LBL** – Selects the maximum range at which traffic labels are shown (with the option to turn off)
- 6) Turn the small **FMS** Knob to scroll through options for each product (ON/OFF, range settings, etc.).
- 7) Press the **ENT** Key to select an option.
- 8) Press the **FMS** Knob or **CLR** Key to return to the Navigation Map Page with the changed settings.

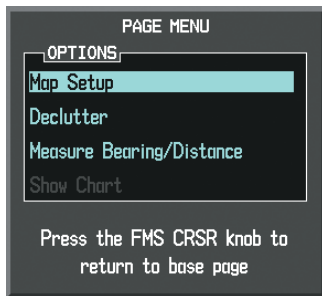

Figure 6-108 Navigation Map Page Menu



Figure 6-109 Navigation Map Page Setup Menu

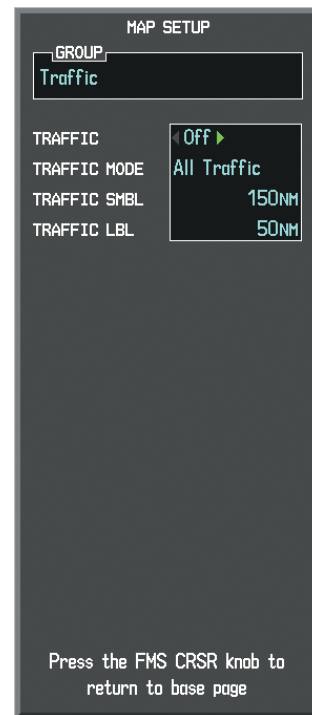

Figure 6-110 Navigation Map Page Setup Menu, Traffic Group

## TRAFFIC MAP PAGE

The Traffic Map Page is specialized to show surrounding TIS traffic data in relation to the aircraft's current position and altitude, without clutter from the basemap. It is the principal map page for viewing TIS traffic information. Aircraft orientation on this map is always heading up unless there is no valid heading. Map range is adjustable with the **RANGE** Knob from 2 to 12 nm, as indicated by the map range rings.

The traffic mode is annunciated in the upper left corner of the Traffic Map Page. When the aircraft is on the ground, TIS automatically enters Standby Mode. Once the aircraft is airborne, TIS switches from Standby to Operating Mode and the system begins to display traffic information. Refer to the System Status discussion for more information.

### Displaying traffic on the Traffic Map Page:

- 1) Turn the large **FMS** Knob to select the Map Page Group.
- 2) Turn the small **FMS** Knob to select the Traffic Map Page.
- 3) Confirm TIS is in Operating Mode:  
Select the **OPERATE** Softkey to begin displaying traffic.  
**Or:**
  - a) Press the **MENU** Key.
  - b) Select 'Operate Mode' (shown if TIS is in Standby Mode) and press the **ENT** Key.

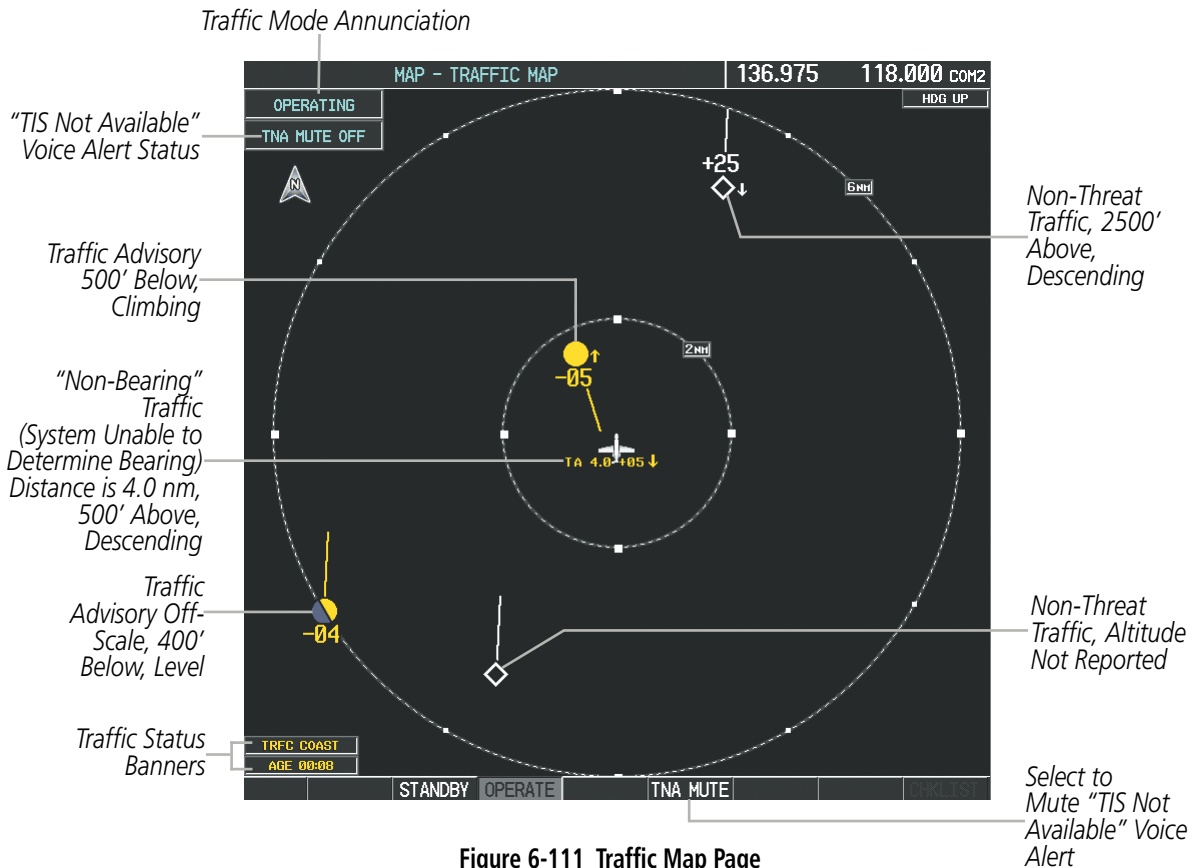

Figure 6-111 Traffic Map Page

## TIS ALERTS

When the number of TAs on the Traffic Map Page increases from one scan to the next, the following occur:

- A single **“Traffic”** voice alert is generated.
- A ‘TRAFFIC’ Annunciation appears to the top left of the Attitude Indicator on the PFD, flashing for 5 seconds and remaining displayed until no TAs are detected in the area.
- The PFD Inset Map is automatically displayed with traffic.

To reduce the number of nuisance alerts due to proximate aircraft, the **“Traffic”** voice alert is generated only when the number of TAs increases. For example, when the first TA is displayed, a voice and visual annunciation are generated. As long as a single TA remains on the display, no additional voice alerts are generated. If a second TA appears on the display or if the number of TAs initially decreases and then subsequently increases, another voice alert is generated.

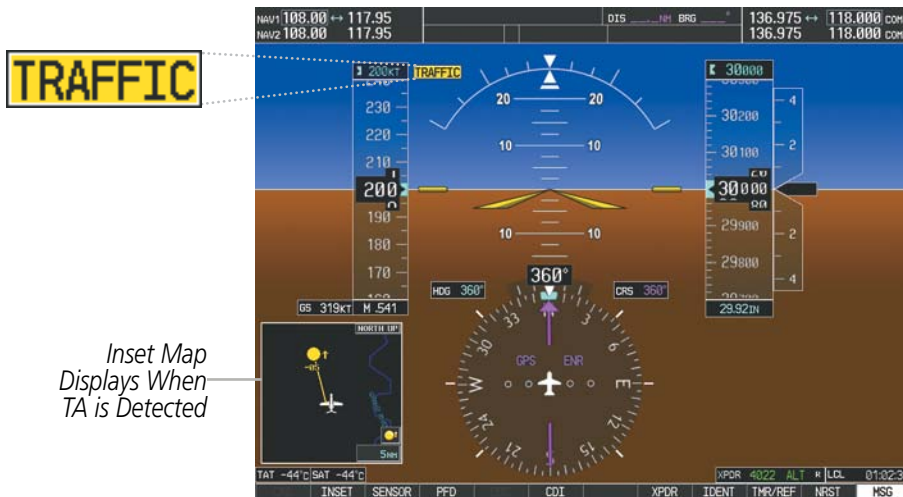

Figure 6-112 Traffic Annunciation (PFD)

A “**TIS Not Available**” (TNA) voice alert is generated when the TIS service becomes unavailable or is out of range. TIS may be unavailable in the radar coverage area due to the following:

- Radar site TIS Mode S sensor is not operational or is out of service
- Traffic or requesting aircraft is beyond the maximum range of the TIS-capable Mode S radar site.
- Traffic or requesting aircraft is above the radar site in the cone of silence and out of range of an adjacent site.
- Traffic or requesting aircraft is below radar coverage. In flat terrain, the coverage extends from about 3000 feet upward at 55 miles. Terrain and obstacles around the radar site can further decrease radar coverage in all directions.
- Traffic does not have an operating transponder.

The “**TIS Not Available**” (TNA) voice alert can be manually muted to reduce nuisance alerting. TNA muting status is shown in the upper left corner of the Traffic Map Page.

#### Muting the “TIS Not Available” voice alert:

- 1) Select the Traffic Map Page.
- 2) Select the **TNA MUTE** Softkey. The status is displayed in the upper left corner of the Traffic Map Page.

Or:

- a) Press the **MENU** Key.
- b) Select “Not Available” Mute On’ (shown if TNA muting is currently off) and press the **ENT** Key.

**SYSTEM STATUS**

The system performs an automatic test of TIS during power-up. If TIS passes the test, TIS enters Standby Mode (on the ground) or Operating Mode (in the air). If TIS fails the power up test, the system displays an annunciation in the center of the Traffic Map Page.

Traffic Map Page Center Banner Annunciation	Description
<b>NO DATA</b>	Data is not being received from the transponder*
<b>DATA FAILED</b>	Data is being received from the transponder, but a failure is detected in the data stream*
<b>FAILED</b>	The transponder has failed*
<b>UNAVAILABLE</b>	TIS is unavailable or out of range

\* Contact a service center or Garmin dealer for corrective action

**Table 6-19 TIS Failure Annunciations**

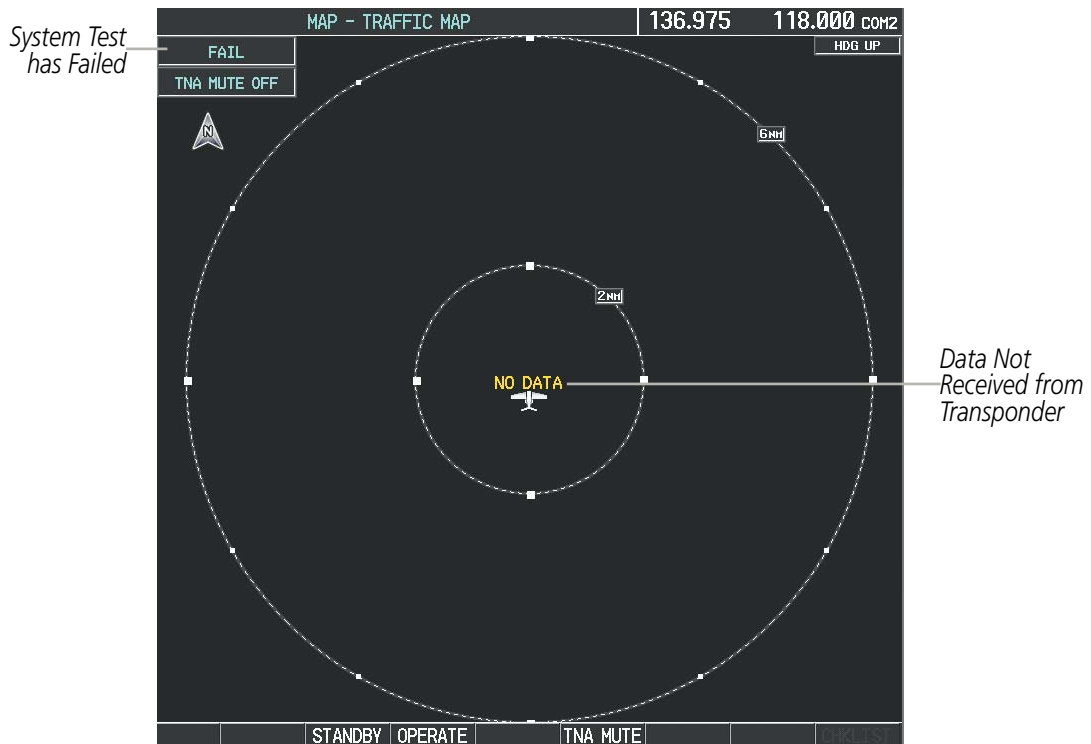

**Figure 6-113 TIS Power-up Test Failure**

The traffic mode is annunciated in the upper left corner of the Traffic Map Page. When the aircraft is on the ground, TIS automatically enters Standby Mode. If traffic is selected for display on another map while Standby Mode is selected, the traffic display enabled icon is crossed out (also the case whenever TIS has failed). Once the aircraft is airborne, TIS switches to Operating Mode and traffic information is displayed. The mode can be changed manually using softkeys or the page menu.



Mode	Traffic Mode Annunciation (Traffic Map Page)	Traffic Display Status Icon (Other Maps)
TIS Operating	<b>OPERATING</b>	
TIS Standby	<b>STANDBY</b> (also shown in white in center of page)	
TIS Failed	<b>FAIL</b>	

Table 6-20 TIS Modes

### Switching between TIS modes:

- 1) Select the Traffic Map Page.
- 2) Select the **STANDBY** or **OPERATE** Softkey to switch between modes. The mode is displayed in the upper left corner of the Traffic Map Page.

Or:

- a) Press the **MENU** Key.
- b) Select 'Operate Mode' or 'Standby Mode' (choice dependent on current state) and press the **ENT** Key. The annunciations to indicate the status of traffic information appear in a banner at the lower left corner of maps on which traffic can be displayed (Table 6-21).

Traffic Status Banner Annunciation	Description
<b>TA OFF SCALE</b>	A Traffic Advisory is outside the selected display range* Annunciation is removed when traffic comes within the selected display range
<b>TA X.X ± XX ↓</b>	System cannot determine bearing of Traffic Advisory** Annunciation indicates distance in nm, altitude separation in hundreds of feet, and altitude trend arrow (climbing/descending)
<b>AGE MM:SS</b>	Appears if traffic data is not refreshed within 6 seconds If after another 6 seconds data is not received, traffic is removed from the display The quality of displayed traffic information is reduced as the age increases
<b>TRFC COAST</b>	The displayed data is not current (6 to 12 seconds since last message) The quality of displayed traffic information is reduced when this message is displayed
<b>TRFC RMVD</b>	Traffic is removed because it is too old for coasting (12 to 60 seconds since last message) Traffic may exist within the selected display range, but it is not displayed
<b>TRFC FAIL</b>	Traffic data has failed
<b>NO TRFC DATA</b>	Traffic has not been detected
<b>TRFC UNAVAIL</b>	The traffic service is unavailable or out of range

\*Shown as symbol on Traffic Map Page

\*\*Shown in center of Traffic Map Page

Table 6-21 TIS Traffic Status Annunciations

## 6.6 TCAS II TRAFFIC



**WARNING:** Traffic information shown on system displays is provided to aid in visually acquiring traffic. Traffic avoidance maneuvers are based upon TCAS II Resolution Advisories, ATC guidance, or positive visual acquisition of conflicting traffic.



**NOTE:** TIS is disabled when TCAS II is installed.



**NOTE:** Refer to the TCAS II documentation for a detailed discussion of the TCAS II system.

### TCAS II SYMBOLOGY

The optional TCAS II system is designed to help in detection and avoidance of other aircraft. TCAS II uses an on-board interrogator-processor and the Mode S transponder for the air-to-air traffic data link. Traffic is displayed according to the TCAS II symbology shown in Table 6-22.







TCAS Symbol	Description
	Non-Threat Traffic
	Proximity Advisory (PA)
	Traffic Advisory (TA)
	Traffic Advisory Off Scale
	Resolution Advisory (RA)
	Resolution Advisory Off Scale

Table 6-22 TCAS II Symbol Description

A Non-threat Proximity Advisory, shown as an open white diamond, indicates that an intruding aircraft is at greater than  $\pm 1200$  feet relative altitude or the distance is beyond 5 nm.

A Proximity Advisory indicates that the intruding aircraft is within  $\pm 1200$  feet and is within 6 nm range, but is still not considered a threat.

A Traffic Advisory (TA) alerts the crew to a potentially hazardous intruding aircraft closing to within 20-48 seconds of a potential collision area. A Traffic Advisory that is beyond the selected display range is indicated by a half TA symbol at the edge of the screen at the relative bearing of the intruder.

A Resolution Advisory (RA) alerts the crew to intruding aircraft that are closing to within 15 to 35 seconds of a potential collision area. RAs include vertical guidance maneuvers designed to increase or maintain vertical



separation from intruding aircraft. An RA that is beyond the selected display range is indicated by a half RA symbol at the edge of the screen at the relative bearing of the intruder.

## TCAS II ALERTS



**NOTE:** Refer to the TCAS II documentation for information on alerts generated by the TCAS II equipment.

When the TCAS II unit issues a TA or RA, the following occur:

- A voice alert is generated when a TA or RA is displayed.
- A 'TRAFFIC' annunciation appears at the top right of the airspeed indicator on the PFD, flashes for 5 seconds and remains displayed until no TAs or RAs are detected in the area. RA 'TRAFFIC' annunciations are white text with red backgrounds; TA 'TRAFFIC' annunciations are black text with yellow backgrounds. If a TA and RA occur simultaneously, only the red and white RA 'TRAFFIC' annunciation is shown.
- The PFD Inset Map is automatically displayed with TA or RA traffic.
- During an RA only, voice alert(s) provide vertical guidance to resolve the traffic conflict while the PFD displays pitch and vertical speed cues (Figure 6-114). Additional voice alerts occur to denote changes in the RA status.

RA Annunciation

**TRAFFIC**

TA Annunciation

**TRAFFIC**

Fly-To Pitch Cue

No-Fly Pitch Cue

Inset Map  
Displays When TA  
or RA is Detected

Traffic/Map Inset  
Softkey



Fly-To Vertical  
Speed

No-Fly Vertical  
Speed Range

Figure 6-114 Traffic Annunciation with Resolution Advisory (PFD)

## RESOLUTION ADVISORIES

During an RA, vertical guidance indications appear on the Attitude Indicator and Vertical Speed indicators of the PFD to provide visual pitch cues for the flight crew to use to achieve (or maintain) vertical separation from intruding traffic (Figure 6-115).

The Attitude Indicator will depict a range of pitch attitudes to avoid using no-fly pitch cues positioned on the pitch ladder. The no-fly pitch cues are indicated by red open trapezoid-shaped areas encompassing the range of pitch attitudes to be avoided during an RA. If an RA requires a change in existing pitch attitude, a green rectangular fly-to pitch cue will appear above or below the no-fly pitch cue to indicate a recommended pitch attitude. If multiple intruding aircraft limit available pitch travel in both directions, two no-fly pitch cues will appear on the pitch ladder, indicating flight should occur between the two no-fly pitch cues.

While an RA is occurring, the Vertical Speed Indicator (VSI) will show vertical speeds required to resolve the traffic conflict. A red vertical bar appears on the VSI scale to indicate the range of vertical speeds to be avoided during the RA. If the current aircraft vertical speed is within this red range, the pointer on the VSI also turns red. When an RA directs the flight crew to fly to (or maintain) a vertical speed, a green vertical bar will appear on the VSI scale at the recommended vertical speed range.

Pitch cues on the Attitude Indicator and vertical bars on the Vertical Speed Indicator are removed when the RA condition has been resolved. The TCAS II system will also issue an aural annunciation when the aircraft is clear of the RA conflict.



*Climb*



*Descend*



*Maintain, Don't Climb*



*Maintain, Don't Descend*



*Maintain, Don't Climb and Don't Descend*



*Adjust Vertical Speed*

Figure 6-115 Example Resolution Advisory Visual Cues

## SYSTEM TEST

---



**NOTE:** Refer to the TCAS II documentation for information on specific aural alerts issued during system tests.

---

The TCAS II system can be tested on either the PFD or MFD.

**On the PFD:**

- 1) Press the **XPDR/TFC** Softkey.
- 2) Press the **TCAS** Softkey.
- 3) Press the **TEST** Softkey.

**On the MFD:**

- 1) Turn the large **FMS** Knob to select the Map Page Group.
- 2) Turn the small **FMS** Knob to select the Traffic Map Page.
- 3) Turn the **Range** knob to set the range to 2/6 nm to allow for full traffic test pattern display.
- 4) Select the **TEST** Softkey.

**Or:**

- 1) Press the **MENU** Key and turn the small **FMS** knob to select 'Test Mode'.
- 2) Press the **ENT** Key.

When initiating the system test, the TCAS II unit issues the aural annunciation “**TCAS Test**”. A traffic test pattern is displayed on the Traffic Map Page of the MFD, and on the Inset Map on the PFD (which appears if not already displayed.) A Resolution Advisory (RA) alert annunciation is shown on the PFD, and pitch cues appear on the attitude indicator and vertical speed indicator indicating not to descend, and not to climb greater than 2000 feet per minute. The system test takes approximately eight seconds to complete. An aural announcement indicates whether the test has passed or failed. Visual annunciations will also indicate a system test has failed (Tables 6-25, 6-26, and 6-27).

## OPERATION

---



**NOTE:** The traffic system automatically changes modes based on certain flight parameters. Refer to the TCAS II unit's documentation for information on automatic mode selection.

---

To display TCAS II Traffic, the system must be in TA ONLY or TA/RA Mode. These modes can be accessed on the PFD or on the Traffic Map Page of the MFD.

### Switching from standby mode to TA only or TA/RA mode:

#### On the MFD:

- 1) Turn the large **FMS** Knob to select the Map Page Group.
- 2) Turn the small **FMS** Knob to select the Traffic Map Page.
- 3) Select the **TA ONLY** or **TA/RA** Softkey

#### Or:

- 1) Press the **MENU** Key and turn the small **FMS** knob to select 'TA Only Mode' or 'TA/RA Mode'.
- 2) Press the **ENT** Key. The unit switches from Standby Mode to TA Only or TA/RA Mode as necessary.

#### On the PFD:

- 1) Press the **XPDR/TFC** Softkey.
- 2) Press the **MODE** Softkey.
- 3) Press the **TA ONLY** or **TA/RA** Softkey to select an operating mode.

### Switching from TA ONLY or TA/RA mode to Standby Mode:

#### On the MFD:

- 1) Turn the large **FMS** Knob to select the Map Page Group.
- 2) Turn the small **FMS** Knob to select the Traffic Map Page.
- 3) Select the **TFC STBY** Softkey

#### Or:

- 1) Press the **MENU** Key and turn the small **FMS** knob to select 'Traffic Standby Mode'.
- 2) Press the **ENT** Key.

### TRAFFIC MAP PAGE

The Map - Traffic Map Page shows surrounding TCAS II traffic data in relation to the aircraft's current position and altitude, without basemap clutter. It is the principal MFD map page for viewing TCAS II traffic. Aircraft orientation is always heading up unless there is no valid heading. Map range is adjustable with the **RANGE** Knob from 2 to 40 nm, as indicated by the map range rings.

The traffic mode and altitude display mode are annunciated in the upper left corner.



Figure 6-116 Traffic Map Page

**Displaying traffic on the Traffic Map Page:**

- 1) Turn the large **FMS** Knob to select the Map Page Group.
- 2) Turn the small **FMS** Knob to select the Traffic Map Page.
- 3) Select the **TA ONLY** or **TA/RA** Softkey to begin displaying traffic. 'TA ONLY' or 'TA/RA' is displayed in the Traffic mode field.
- 4) Select the **REL** or **ABS** Softkey to display the relative or absolute altitude of other aircraft.
- 5) Select the **TFC STBY** Softkey to place the system in the Standby Mode. 'STANDBY' is displayed in the Traffic mode field.
- 6) Turn the **RANGE** Knob clockwise to display a larger area or counter-clockwise to display a smaller area.

**ALTITUDE DISPLAY**

The Pilot can select the volume of airspace in which non-threat and proximity traffic is displayed. Traffic Advisories (TAs) and Resolution Advisories (RAs) outside of these limits will always be shown.

**Changing the altitude range:****On the PFD:**

- 1) Press the **XPDR/TFC** Softkey.
- 2) Press the **TCAS** Softkey
- 3) Press the **ALT RNG** Softkey
- 4) Press one of the following altitude range Softkeys:
  - **ABOVE:** Displays non-threat and proximity traffic from 9900 feet above the aircraft to 2700 feet below the aircraft. Typically used during climb phase of flight.
  - **NORMAL:** Displays non-threat and proximity traffic from 2700 feet above the aircraft to 2700 feet below the aircraft. Typically used during enroute phase of flight.
  - **BELOW:** Displays non-threat and proximity traffic from 2700 feet above the aircraft to 9900 feet below the aircraft. Typically used during descent phase of flight.
  - **UNREST** (unrestricted): All traffic is displayed
- 5) Press the **BACK** Softkey.

**On the MFD:**

- 1) On the Traffic Map Page, select the **ALT RNG** Softkey.
- 2) Select one of the following Softkeys (see softkey description in step 4 above):
  - ABOVE
  - NORMAL
  - BELOW
  - UNRESTRICTED
- 3) To return to the Traffic Page, select the **BACK** Softkey.

Or:

- 1) Press the **MENU** Key.
- 2) Turn the small **FMS** Knob to select one of the following (see softkey description in step 4 above):
  - ABOVE
  - NORMAL
  - BELOW
  - UNRESTRICTED
- 3) Select the **ENT** Softkey.

### TRAFFIC MAP PAGE DISPLAY RANGE

The display range on the Traffic Map Page can be changed at any time. Map range is adjustable with the **RANGE** Knob from 2 to 40 nm, as indicated by the map range rings.

#### Changing the display range on the Traffic Map Page:

- 1) Turn the **RANGE** Knob.
- 2) The following range options are available:
  - 2 nm
  - 2 and 6 nm
  - 6 and 12 nm
  - 12 and 24 nm
  - 24 and 40 nm

### ADDITIONAL TRAFFIC DISPLAYS

Traffic information can be displayed on the following maps on the MFD when the unit is operating:

- Navigation Map Page
- Traffic Map Page
- Trip Planning Page
- Nearest Pages
- Active Flight Plan Page

Traffic information can also be displayed on the PFD when the Synthetic Vision System (SVS) option is installed and enabled. See the Additional Features Section for details.

#### Displaying traffic information (MFD maps other than the Traffic Map Page):

- 1) Select the **MAP** Softkey.
- 2) Select the **TRAFFIC** Softkey. Traffic is now displayed on the map.

When traffic is selected on maps other than the Traffic Map Page, the system displays a traffic status icon to indicate traffic is enabled for display (Figure 6-117).



## Displaying traffic on the Navigation Map

- 1) Ensure the TCAS II system is operating. With the Navigation Map displayed, select the **MAP** Softkey.
- 2) Select the **TRAFFIC** Softkey. Traffic is now displayed on the map as shown in the figure.

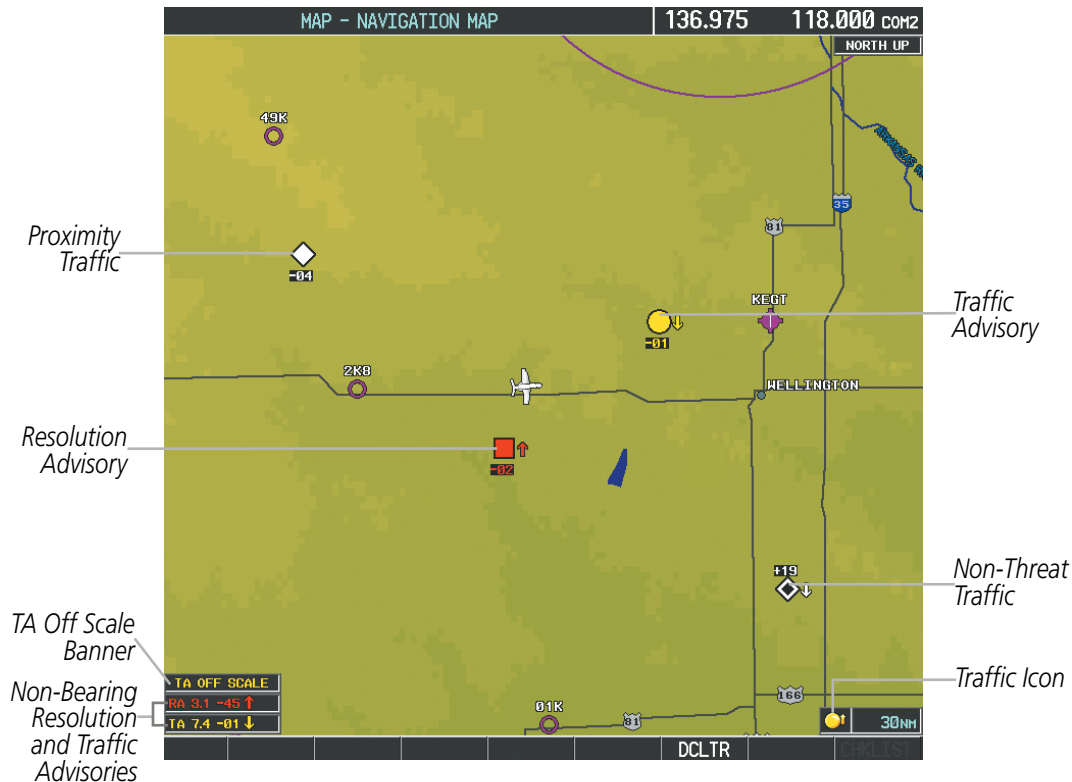

Figure 6-117 TCAS II Traffic on Navigation Map

## Customizing the traffic display on the Navigation Map Page:

- 1) Select the Navigation Map Page.
- 2) Press the **MENU** Key.
- 3) With Map Setup highlighted, press the **ENT** Key (Figure 6-118).
- 4) Turn the small **FMS** Knob to select the Traffic Group and press the **ENT** Key (Figure 6-119).
- 5) Turn the large **FMS** Knob or press the **ENT** Key to scroll through the selections (Figure 6-120).
  - **TRAFFIC** – Turns the display of traffic data on or off
  - **TRAFFIC MODE** – Selects the traffic mode for display; select from:
    - All Traffic - Displays all traffic
    - TA/RA/PA - Displays Traffic Advisories, Resolution Advisories, and Proximity Advisories
    - TA/RA ONLY - Displays Traffic Advisories and Resolution Advisories only
  - **TRAFFIC SMBL** – Selects the maximum range at which traffic symbols are shown
  - **TRAFFIC LBL** – Selects the maximum range at which traffic labels are shown with the option to turn off

- 6) Turn the small **FMS** Knob to scroll through options (ON/OFF, range settings, etc.).
- 7) Press the **ENT** Key to select an option.
- 8) Press the **FMS** Knob or **CLR** Key to return to the Navigation Map Page.

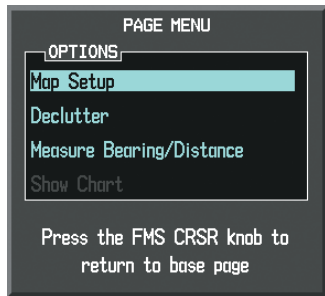

Figure 6-118 Navigation Map Page Menu

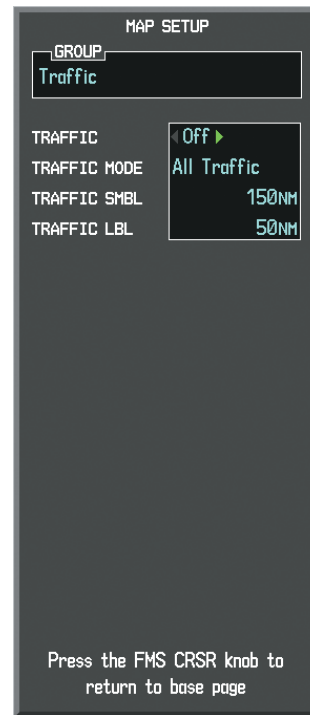

Figure 6-120 Navigation Map Page Setup Menu, Traffic Group

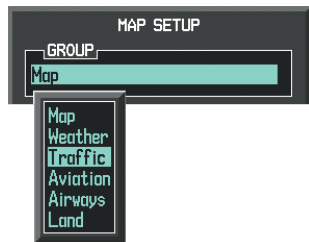

Figure 6-119 Navigation Map Page Setup Menu

The Navigation Map Page Setup Menu also controls the display of traffic. The setup menu controls the map range settings. Traffic data symbols and labels can be decluttered from the display. If a map range larger than the map range setting is selected, the data is removed from the map. Maps besides the Traffic Map Page use settings based on those selected for the Navigation Map Page.

Traffic information can also be displayed on the PFD Inset Map by pressing the **TRFC/MAP** Softkey. A traffic map will appear in heading up orientation. Traffic information can also be overlaid with navigation, topographic and optional SiriusXM Weather data.

**Displaying additional information with Traffic on the PFD Inset Map.**

- 1) Press the **TRFC/MAP** Softkey. Traffic map (TRFC-2) is displayed heading up.
- 2) Press the **TRFC-2** Softkey.
- 3) Press the softkey(s) for the item(s) to be included on the PFD Inset Map (TRAFFIC, TOPO, NEXRAD, XM LTNG)
- 4) Press the **BACK** Softkey.

## SYSTEM STATUS

The traffic mode is annunciated in the upper left corner of the Traffic Map Page.

Traffic Mode	PFD Traffic Mode Annunciation	MFD Traffic Map Page Mode Annunciation	Traffic Display Status Icon (Other Maps)
TCAS II Self-test Initiated (TEST)	None	<b>TEST</b> (‘TEST MODE’ also shown in white on top center of page)	
Traffic Advisory and Resolution Advisory (TA/RA)	None	<b>TA/RA</b>	
Traffic Advisory Only (TA ONLY)	<b>TA ONLY</b>	<b>TA ONLY</b>	
TCAS II Standby (TFC STBY)	<b>TCAS STBY</b> Or: <b>TCAS STBY</b> *	<b>STANDBY</b> (also shown in white in center of page on ground, yellow in the air)	
TCAS II Failed**	<b>TCAS FAIL</b>	<b>FAIL</b>	

\* Annunciation appears in yellow while in the air.

\*\* See Table 6-24 for additional failure annunciations.

Table 6-23 TCAS II Modes

If the traffic unit fails, an annunciation as to the cause of the failure is shown in the center of the Traffic Map Page.

Traffic Map Page Annunciation	Description
<b>NO DATA</b>	Data is not being received from the TCAS II unit
<b>DATA FAILED</b>	Data is being received from the TCAS II unit, but the unit is self-reporting a failure
<b>FAILED</b>	Incorrect data format received from the TCAS II unit

Table 6-24 TCAS II Failure Annunciations

The annunciations to indicate the status of traffic information appear in a banner at the lower left corner of maps on which traffic can be displayed.

Traffic Status Banner Annunciation	Description
<b>RA OFF SCALE</b>	A Resolution Advisory is outside the selected display range*. Annunciation is removed when traffic comes within the selected display range
<b>TA OFF SCALE</b>	A Traffic Advisory is outside the selected display range*. Annunciation is removed when traffic comes within the selected display range.
<b>RA X.X ± XX ↓</b>	System cannot determine bearing of Resolution Advisory**. Annunciation indicates distance in nm, altitude separation in hundreds of feet, and altitude trend arrow (climbing/ descending).
<b>TA X.X ± XX ↓</b>	System cannot determine bearing of Traffic Advisory**. Annunciation indicates distance in nm, altitude separation in hundreds of feet, and altitude trend arrow (climbing/ descending).
<b>TRFC FAIL</b>	TCAS II unit has failed (unit is self-reporting a failure or sending incorrectly formatted data)
<b>NO TCAS DATA</b>	Data is not being received from the TCAS II unit

\*Shown as symbol on Traffic Map Page  
 \*\*Shown in center of Traffic Map Page

**Table 6-25 TCAS II Traffic Status Annunciations**

**BLANK PAGE**

## SECTION 7 AUTOMATIC FLIGHT CONTROL SYSTEM



**NOTE:** *The approved Airplane Flight Manual (AFM) always supersedes this Pilot's Guide.*

The GFC 700 is a digital Automatic Flight Control System (AFCS), fully integrated within the avionics architecture. The System Overview section provides a block diagram to support this system description. GFC 700 AFCS functionality is distributed across the following Line Replaceable Units (LRUs):

- GDU 1240A Primary Flight Displays (PFDs) (2)
- GMC 715 AFCS Control Unit
- GIA 63W Integrated Avionics Units (IAUs) (2)
- GSA 81 AFCS Servos (3)
- GSM 85A Servo Gearboxes (3)
- GSA 80 AFCS Servo (1)

The GFC 700 AFCS can be divided into these main operating functions:

- **Flight Director (FD)** — The GFC 700 flight director function can be coupled to either the pilot-side or copilot-side PFD data. The **CPL** Key selects the PFD source for the Flight Director. Commands for the selected flight director source are displayed on both PFDs. The flight director provides:
  - Vertical/lateral mode selection and processing
  - Command Bars showing pitch/roll guidance
  - Pitch and roll commands to the autopilot
- **Autopilot (AP)** — Autopilot operation occurs within the pitch and roll servos. It provides automatic flight control in response to flight director steering commands, Attitude and Heading Reference System (AHRS) attitude and rate information, and airspeed.
- **Yaw Damper (YD)** — The yaw servo provides Dutch roll damping and turn coordination in response to yaw rate, roll angle, lateral acceleration, and airspeed.
- **Manual Electric Pitch Trim (MEPT)** — The pitch trim system provides manual electric pitch trim capability.
- **Automatic Pitch Trim (APT)/Mach Trim (MT)** — The pitch trim system provides automatic pitch trim when the autopilot is engaged and Mach trim when the autopilot is not engaged.

## 7.1 AFCS CONTROLS

The AFCS Control Unit is positioned above the MFD, and has the following controls:

- ① ⑩ **FD Keys**      Activate/deactivate the selected flight director (pilot- or copilot-side) in default vertical and lateral modes  
Press the other **FD** Key to toggle the corresponding PFD's Command Bars off/on
- ② **NAV Key**      Selects/deselects Navigation Mode
- ③ **HDG Key**      Selects/deselects Heading Select Mode
- ④ **AP Key**      Engages/disengages the autopilot
- ⑤ **YD Key**      Engages/disengages the yaw damper
- ⑥ **ALT Key**      Selects/deselects Altitude Hold Mode
- ⑦ **VNV Key**      Selects/deselects Vertical Path Tracking Mode for Vertical Navigation flight control
- ⑧ **VS Key**      Selects/deselects Vertical Speed Mode
- ⑨ **FLC Key**      Selects/deselects Flight Level Change Mode
- ⑪ ⑲ **CRS Knobs**      Adjust the Selected Course (while in VOR, LOC, or OBS Mode) in 1° increments on the Horizontal Situation Indicator (HSI) of the corresponding PFD  
Press to re-center the Course Deviation Indicator (CDI) and return course pointer directly TO the bearing of the active waypoint/station
- ⑫ **SPD SEL Knob**      Adjusts the Airspeed Reference and bug in 1-kt (0.01 M) increments  
Press to toggle the Airspeed Reference units from IAS to Mach
- ⑬ **UP/DN Wheel**      Adjusts the Vertical Speed Reference and bug in 100-fpm increments
- ⑭ **ALT SEL Knob**      Adjusts the Selected Altitude and bug in 100-ft increments (a finer resolution of 10 feet is available under approach conditions)
- ⑮ **CSC Key**      Selects/deselects Current Speed Control (if available) when Altitude Hold Mode is active
- ⑯ **CPL Key**      Selects the PFD data source (pilot-side or copilot-side) for the Flight Director.  
When the flight director source is switched, the modes revert to default. An arrow in the AFCS Status Box indicates the active FD source (pilot- or copilot-side).
- ⑰ **HDG SEL Knob**      Adjusts the Selected Heading and bug in 1° increments on the HSI (both PFDs)  
Press to synchronize the Selected Heading to the current heading on the pilot-side PFD
- ⑱ **APR Key**      Selects/deselects Approach Mode
- ⑲ **BANK Key**      Manually selects/deselects Low Bank Mode



Figure 7-1 GMC 715 AFCS Control Unit

The following AFCS controls are located separately from the AFCS Control Unit:

**AP DISC Switch (Autopilot Disconnect)** Disengages the autopilot, yaw damper, and flight director and interrupts pitch trim operation  
 An **AP DISC** Switch is located on each control wheel.

This switch may be used to acknowledge an autopilot disconnect alert and mute the associated aural alert.

**CWS Button (Control Wheel Steering)** While pressed, allows manual control of the aircraft while the autopilot is engaged and synchronizes the flight director's Command Bars with the current aircraft pitch (if not in Glideslope or Glidepath Mode) and roll (if in Roll Hold Mode)

A **CWS** Button is located on each control wheel.

Upon release of the **CWS** Button, the flight director may establish new pitch and roll references, depending on the current vertical and lateral modes. CWS operation details are discussed in the respective mode sections of this manual.

**GA Switch (Go Around)** Disengages the autopilot, if engaged, and selects flight director Takeoff Mode (on ground) or Go Around Mode (in air)

This switch also activates the missed approach when the selected navigation source is GPS or when the navigation source is VOR/LOC and a valid frequency has been tuned.

The **GA** Switch is located on the throttle handle.

**MEPT Switch (Manual Electric Pitch Trim)** Used to command manual electric pitch trim  
 An **MEPT** Switch is located on each control wheel.

The pilot side **MEPT** Switch has priority over the copilot side **MEPT** Switch.

This composite switch is split into left and right sides. The left switch is the ARM contact and the right switch controls the DN (forward) and UP (rearward) contacts. Manual trim commands are generated only when both sides of the switch are operated simultaneously. Pushing either **MEPT** Switch disengages the autopilot, if engaged, but does not affect yaw damper operation.



## 7.2 FLIGHT DIRECTOR OPERATION

The flight director function provides pitch and roll commands to the AFCS and displays them on the PFDs. With the flight director active, the aircraft can be hand-flown to follow the path shown by the Command Bars. Maximum commanded pitch ( $\pm 20^\circ$ ) and roll ( $25^\circ$ ) angles, vertical acceleration, and roll rate are limited to values established during AFCS certification. The flight director also provides commands to the autopilot.

### ACTIVATING THE FLIGHT DIRECTOR

An initial press of a key listed in Table 7-1 activates the flight director in the listed modes.

Control Pressed	FD PFD Data Source	Modes Selected			
		Lateral		Vertical	
<b>FD Key</b> (pilot-side)*	Pilot-side	Roll Hold (default)	ROL	Pitch Hold (default)	PIT
<b>FD Key</b> (copilot-side)*	Pilot-side	Roll Hold (default)	ROL	Pitch Hold (default)	PIT
<b>AP Key</b>	Pilot-side	Roll Hold (default)	ROL	Pitch Hold (default)	PIT
<b>CWS Button</b>	Pilot-side	Roll Hold (default)	ROL	Pitch Hold (default)	PIT
<b>GA Switch</b>	Pilot-side	Roll Hold (default)	ROL	Takeoff (on ground)	TO
		Roll Hold (default)	ROL	Go Around (in air)	GA
<b>ALT Key</b>	Pilot-side	Roll Hold (default)	ROL	Altitude Hold	ALT
<b>VS Key</b>	Pilot-side	Roll Hold (default)	ROL	Vertical Speed	VS
<b>VNV Key</b>	Pilot-side	Roll Hold (default)	ROL	Vertical Path Tracking**	VPTH
<b>NAV Key</b>	Pilot-side	Navigation***		GPS VOR LOC BC	Pitch Hold (default) PIT
<b>APR Key</b>	Pilot-side	Approach***		GPS VOR LOC	Pitch Hold (default) PIT
<b>HDG Key</b>	Pilot-side	Heading Select	HDG	Pitch Hold (default)	PIT

\*Subsequent presses of the **FD Key** will toggle the flight director on/off on its respective side. However, pressing the **FD Key** for the inactive flight director only removes the Command Bars from the corresponding display. The **FD Keys** are disabled when the autopilot is engaged.

\*\* Valid **VNV** flight plan must be entered before **VNV Key** press activates flight director.

\*\*\*The selected navigation receiver must have a valid **VOR** or **LOC** signal or active **GPS** course before **NAV** or **APR Key** press activates flight director.

**Table 7-1 Flight Director Activation**

**AFCS STATUS BOX**

Flight director mode annunciations are displayed on the PFDs when the flight director is active. Flight director selection and autopilot and yaw damper statuses are shown in the center of the AFCS Status Box. Lateral flight director modes are displayed on the left and vertical on the right. Armed modes are displayed in white and active in green or magenta (if the mode reference is provided by the GPS navigation function).

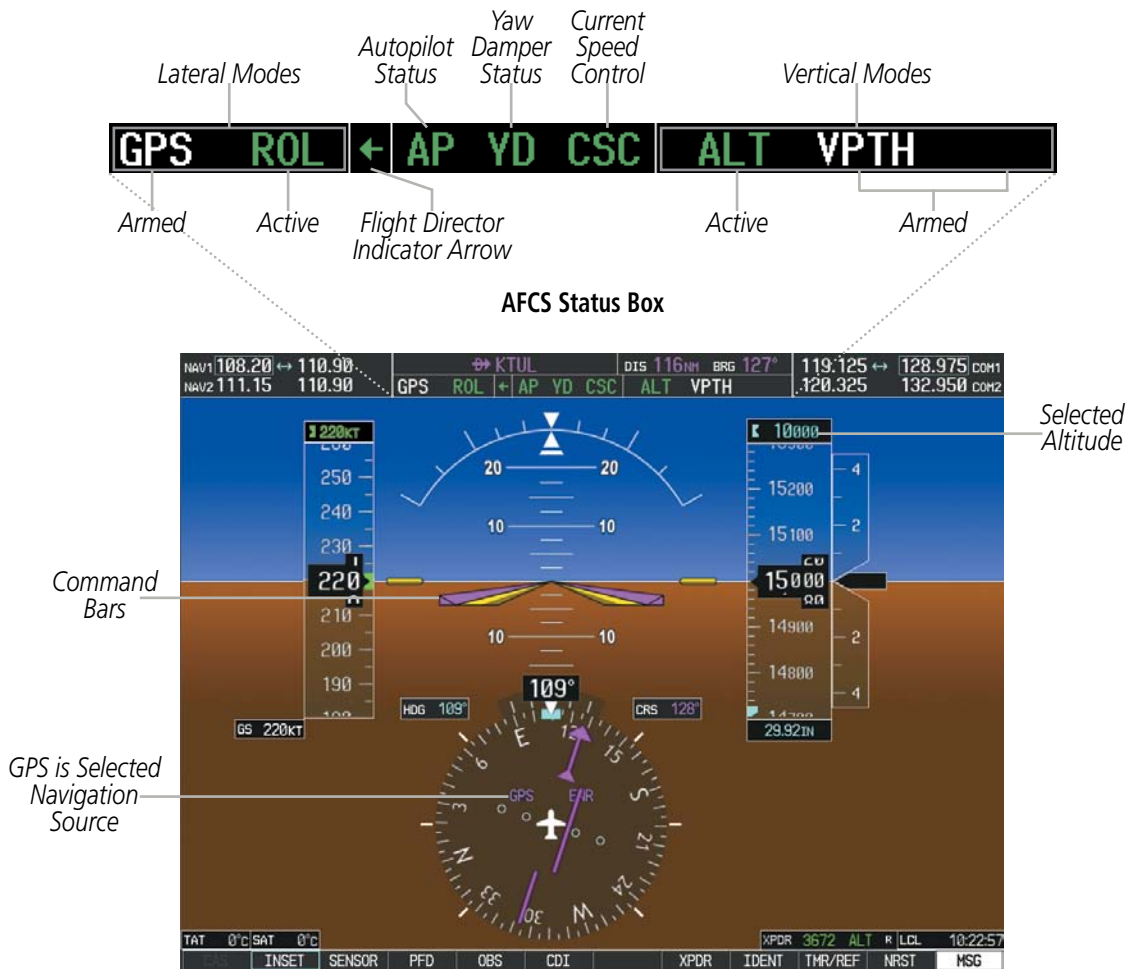

Figure 7-2 PFD AFCS Display

**FLIGHT DIRECTOR MODES**

Flight director modes are normally selected independently for the pitch and roll axes. Unless otherwise specified, all mode keys are alternate action (i.e., press on, press off). In the absence of specific mode selection, the flight director reverts to the default pitch and/or roll modes(s).

Armed modes are annunciated in white and active in green or magenta (if the mode reference is provided by the GPS navigation function) in the AFCS Status Box. Under normal operation, when the control for the active flight director mode is pressed, the flight director reverts to the default mode(s) for the axis(es). Automatic transition from armed to active mode is indicated by the white armed mode annunciation moving to the active mode field and flashing for 5 seconds.

If the information required to compute a flight director mode becomes invalid or unavailable, the flight director automatically reverts to the default mode for that axis. A flashing yellow mode annunciation indicates loss of sensor (ADC) or navigation data (VOR, LOC, GPS, VNV, SBAS) required to compute commands. When such a loss occurs, the system automatically begins to roll the wings level (enters Roll Hold Mode) or maintain the pitch angle (enters Pitch Hold Mode), depending on the affected axis. The flashing annunciation stops when the affected mode key is pressed or another mode for the axis is selected. After 5 seconds, if no action is taken, the flashing annunciation stops and the flight director enters the default mode for the affected axis.



**Figure 7-3 Loss of VOR Signal**

The flight director is automatically disabled if the attitude information required to compute the default flight director modes becomes invalid or unavailable.

**FLIGHT DIRECTOR SELECTION**

The GFC 700 flight director can be coupled to either the pilot-side or copilot-side PFD data using the **CPL** Key. When the pilot-side or copilot-side data source is changed, the vertical and lateral modes revert to default. The autopilot follows the selected flight director only, indicated by an arrow pointing toward either the pilot or copilot side, in the center of the AFCS Status Box.

The currently active flight director may be turned off and the Command Bars removed from the displays by pressing the active **FD** Key again. Pressing the **FD** Key for the inactive flight director only removes the Command Bars from the corresponding display. The **FD** key for the selected flight director is disabled when the autopilot is engaged.

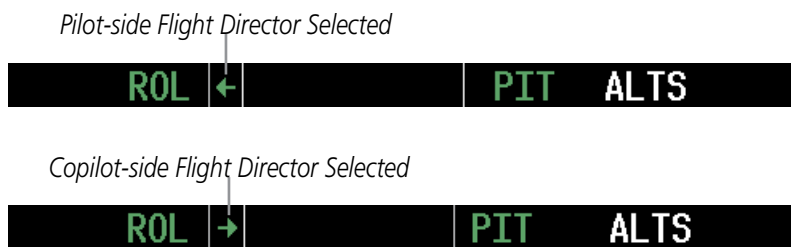

**Figure 7-4 Flight Director Selection Indications**

## COMMAND BARS

Upon activation of the flight director, Command Bars are displayed in magenta on the PFDs as single cues or cross pointers. The aircraft symbol (in yellow) changes to accommodate the Command Bar format; the Command Bars do not override the aircraft symbol. The single-cue Command Bars (Figure 7-5) move together vertically to indicate pitch commands and bank left or right to indicate roll commands. Command Bars displayed as a cross pointer (Figure 7-6) move independently to indicate pitch (horizontal bar) and roll (vertical bar) commands. Both PFDs show the same Command Bar format.



**NOTE:** The split-cue aircraft symbol and cross pointer command bars are not available when SVS is installed.

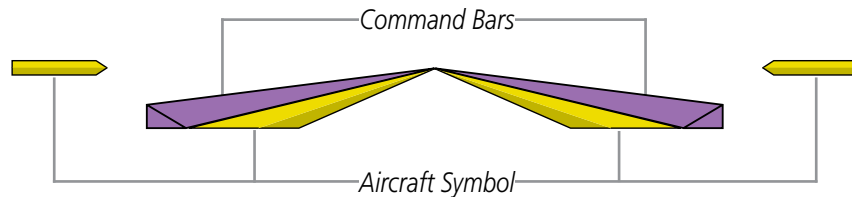

Figure 7-5 Single-cue Command Bars

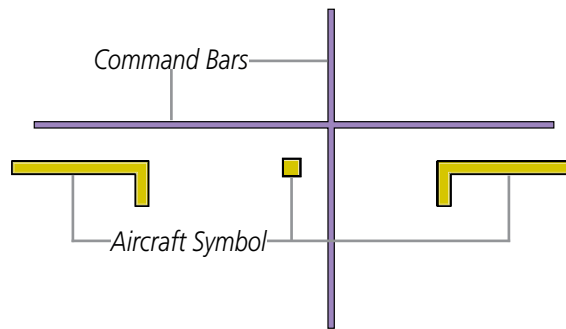

Figure 7-6 Cross-pointer Command Bars

### Changing Command Bar format:

- 1) Use the **FMS** Knob to select the AUX - System Setup Page on the MFD.
- 2) Press the **FMS** Knob to activate the cursor.
- 3) Turn the large **FMS** Knob to highlight 'Format Active' in the 'Flight Director' box.
- 4) Turn the small **FMS** Knob to highlight the desired format.

'SNGL CUE' to display Command Bars as a single cue (Aircraft Symbol in figure 7-5).

**Or:**

'X-POINTER' to display Command Bars as a cross pointer (Aircraft Symbol in Figure 7-6).

If the attitude information being sent to the flight director becomes invalid or unavailable, the Command Bars are removed from the display. The flight director Command Bars also disappear if the pitch exceeds +30°/-20° or bank exceeds 65°.

### 7.3 VERTICAL MODES

Table 7-2 lists the GFC 700's vertical modes with their corresponding controls and annunciations. The mode reference is displayed next to the active mode annunciation for Altitude Hold, Vertical Speed, and Flight Level Change modes. The **UP/DN** Wheel can be used to change the vertical mode reference while operating under Vertical Speed Mode.

Vertical Mode	Description	Control	Annunciation	Reference Range
Pitch Hold	Holds the current aircraft pitch attitude; may be used to climb/descend to the Selected Altitude	(default)	PIT	±20°
Selected Altitude Capture	Captures the Selected Altitude	*	ALTS	
Altitude Hold	Holds the current altitude reference	<b>ALT</b> Key	ALT	
Vertical Speed	Maintains the current aircraft vertical speed; may be used to climb/descend to the Selected Altitude	<b>VS</b> Key	VS	±6000 fpm
Flight Level Change	Maintains the current aircraft airspeed (in IAS or Mach) while the aircraft is climbing/descending to the Selected Altitude	<b>FLC</b> Key	FLC	80 – 320 kt
				0.4 – 0.78 M
Vertical Path Tracking	Captures and tracks descent legs of an active vertical profile	<b>VNV</b> Key	VPTH	
VNV Target Altitude Capture	Captures the Vertical Navigation (VNV) Target Altitude	**	ALTV	
Glidepath	Captures and tracks the SBAS glidepath on approach	<b>APR</b> Key	GP	
Glideslope	Captures and tracks the ILS glideslope on approach		GS	
Takeoff	Commands a constant pitch angle and wings level on the ground in preparation for takeoff	<b>GA</b> Switch	TO	8 – 10.5°
Go Around	Disengages the autopilot and commands a constant pitch angle and wings level while in the air		GA	6 – 8°

\* *ALTS is armed automatically when PIT, VS, FLC, TO, or GA is active, and under VPTH when the Selected Altitude is to be captured instead of the VNV Target Altitude.*

\*\* *ALTV is armed automatically under VPTH when the VNV Target Altitude is to be captured instead of the Selected Altitude.*

**Table 7-2 Flight Director Vertical Modes**

**PITCH HOLD MODE (PIT)**

When the flight director is activated (with the **FD** Key) or switched, Pitch Hold Mode is selected by default. Pitch Hold Mode is indicated as the active vertical mode by the ‘PIT’ annunciation. This mode may be used for climb or descent to the Selected Altitude (shown above the Altimeter), since Selected Altitude Capture Mode is automatically armed when Pitch Hold Mode is activated.

In Pitch Hold Mode, the flight director maintains a constant pitch attitude, the pitch reference. The pitch reference is set to the aircraft pitch attitude at the moment of mode selection. If the aircraft pitch attitude exceeds the flight director pitch command limitations, the flight director commands a pitch angle equal to the nose-up/down limit.

**CHANGING THE PITCH REFERENCE**

When operating in Pitch Hold Mode, the pitch reference can be adjusted by pressing the **CWS** Button, hand-flying the aircraft to establish a new pitch reference, then releasing the **CWS** Button.

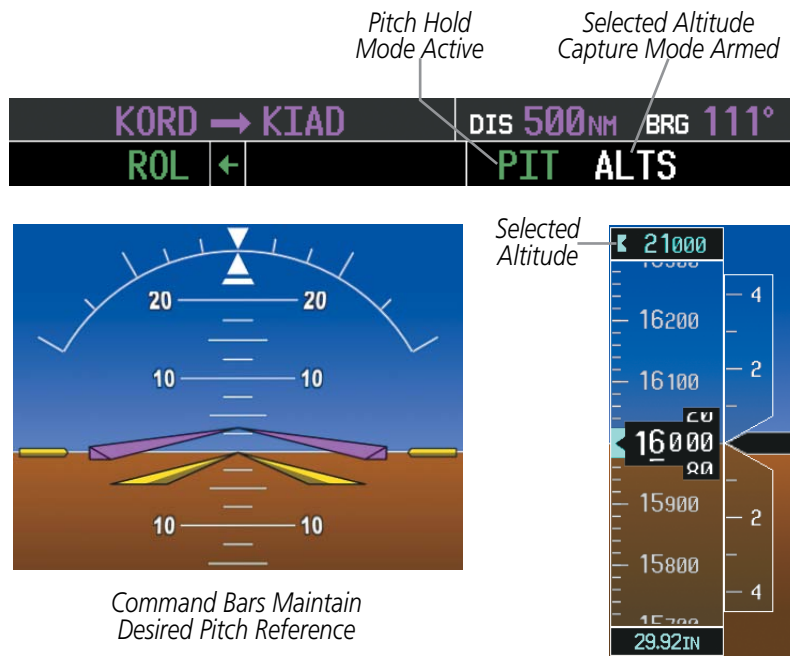

Figure 7-7 Pitch Hold Mode

## SELECTED ALTITUDE CAPTURE MODE (ALTS)

Selected Altitude Capture Mode is automatically armed with activation of the following modes:

- Pitch Hold
- Vertical Speed
- Flight Level Change
- Takeoff/Go Around (if the Selected Altitude is at least 400 feet above the current aircraft altitude)
- Vertical Path Tracking (if the Selected Altitude is to be captured instead of the VNAV Target Altitude)

The white 'ALTS' annunciation indicates Selected Altitude Capture Mode is armed (see Figure 7-7 for example). The **ALT SEL** Knob is used to set the Selected Altitude (shown above the Altimeter) until Selected Altitude Capture Mode becomes active.

As the aircraft nears the Selected Altitude, the flight director automatically transitions to Selected Altitude Capture Mode with Altitude Hold Mode armed (Figure 7-8). This automatic transition is indicated by the green 'ALTS' annunciation flashing for up to 5 seconds and the appearance of the white 'ALT' annunciation.

At 50 feet from the Selected Altitude, the flight director automatically transitions from Selected Altitude Capture to Altitude Hold Mode and holds the Selected Altitude. As Altitude Hold Mode becomes active, the white 'ALT' annunciation moves to the active vertical mode field and flashes green for 5 seconds to indicate the automatic transition.

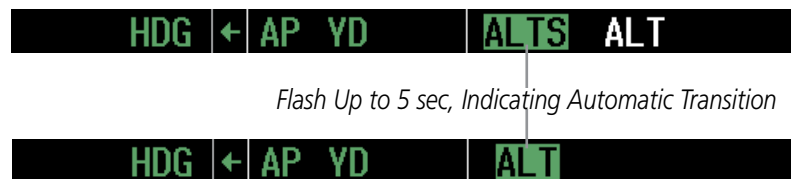

Figure 7-8 Automatic Mode Transitions During Altitude Capture

## CHANGING THE SELECTED ALTITUDE



**NOTE:** Pressing the **CWS** Button while in Selected Altitude Capture Mode does not cancel the mode.

Use of the **ALT SEL** Knob to change the Selected Altitude while Selected Altitude Capture Mode is active causes the flight director to revert to Pitch Hold Mode with Selected Altitude Capture Mode armed for the new Selected Altitude.

## ALTITUDE HOLD MODE (ALT)

If Altitude Hold Mode is activated by pressing the **ALT** Key; the flight director maintains the current aircraft altitude (to the nearest 10 feet). Altitude Hold Mode active is indicated by an 'ALT' annunciation in the AFCS Status Box.

Altitude Hold Mode is automatically armed when the flight director is in either of the following modes:

- Selected Altitude Capture (see Figure 7-8)
- VNV Target Altitude Capture (see Figure 7-17)

The transition to Altitude Hold Mode automatically occurs when the altitude error is less than 50 feet. In this case, the Selected or VNV Target Altitude becomes the flight director's altitude reference. The active mode annunciation 'ALT' appears in magenta if the transition was made from VNV Target Altitude Capture Mode.

### CHANGING THE ALTITUDE REFERENCE

**NOTE:** Turning the **ALT SEL Knob** while in Altitude Hold Mode changes the Selected Altitude, but not the flight director's altitude reference, and does not cancel the mode.

With the **CWS Button** pressed, the aircraft can be hand-flown to a new altitude reference. When the **CWS Button** is released at the desired altitude, the new altitude is established as the altitude reference.

### CURRENT SPEED CONTROL (IF AVAILABLE)

Current Speed Control (if available) can be engaged if the autopilot is engaged and Altitude Hold Mode (ALT) or VNV Target Altitude Capture (ALTV) Mode is active. When the **CSC Key** is pressed, the Full Authority Digital Engine Control (FADEC) varies engine thrust to maintain the desired Airspeed Reference (green Airspeed Reference Bug), within a certain control range.

**NOTE:** For CSC engagement and disengagement detailed conditions, see the approved Pilot's Operating Handbook (POH).

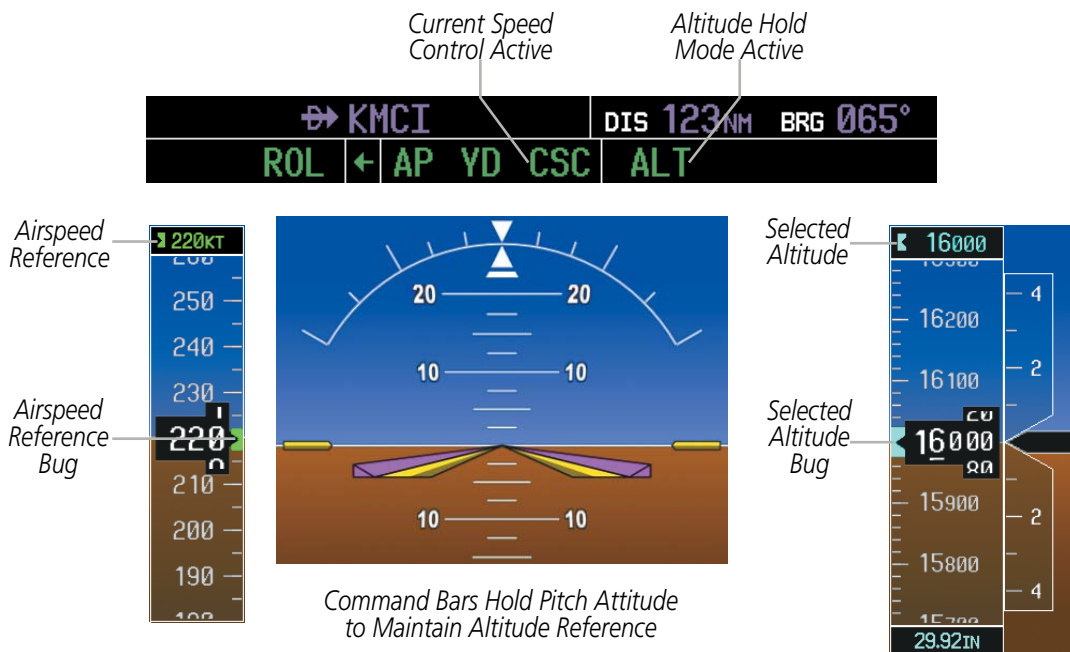

Figure 7-9 Altitude Hold Mode



**VERTICAL SPEED MODE (VS)**

In Vertical Speed Mode, the flight director acquires and maintains a Vertical Speed Reference (shown above the Vertical Speed Indicator). Current aircraft vertical speed (to the nearest 100 fpm) becomes the Vertical Speed Reference at the moment of Vertical Speed Mode activation. This mode may be used for climb or descent to the Selected Altitude (shown above the Altimeter) since Selected Altitude Capture Mode is automatically armed when Vertical Speed Mode is selected.

When Vertical Speed Mode is activated by pressing the **VS** Key, 'VS' is annunciated in green in the AFCS Status Box. The Vertical Speed Reference is displayed above the Vertical Speed Indicator. A Vertical Speed Reference Bug corresponding to the Vertical Speed Reference is shown on the indicator.

**CHANGING THE VERTICAL SPEED REFERENCE**

The Vertical Speed Reference (shown above the Vertical Speed Indicator) may be changed by:

- Using the **UP/DN** Wheel
- Pressing the **CWS** Button, hand-flying the aircraft to attain a new Vertical Speed Reference, then releasing the **CWS** Button

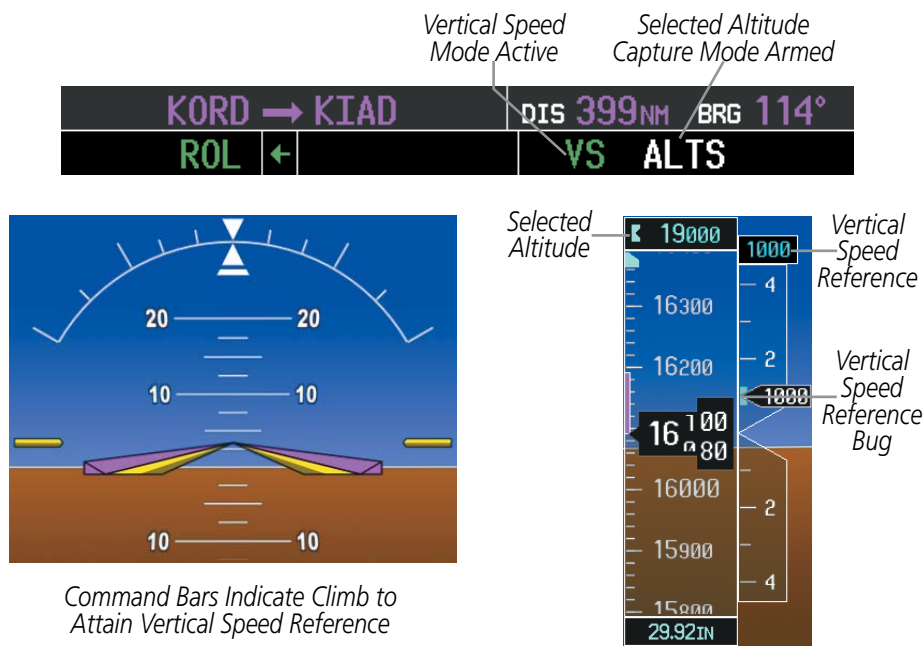

**Figure 7-10 Vertical Speed Hold Mode**

**FLIGHT LEVEL CHANGE MODE (FLC)**

**NOTE:** The Selected Altitude should be set before selecting Flight Level Change Mode.

Flight Level Change Mode is selected by pressing the **FLC** Key. This mode acquires and maintains the Airspeed Reference (in IAS or Mach) while climbing or descending to the Selected Altitude (shown above the Altimeter). When Flight Level Change Mode is active, the flight director continuously monitors Selected Altitude, airspeed, Mach, and altitude.

The Airspeed Reference is set to the current airspeed upon mode activation. Flight Level Change Mode is indicated by a green 'FLC' annunciation in the AFCS Status Box. The Airspeed Reference is displayed directly above the Airspeed Indicator, along with a cyan Airspeed Reference Bug corresponding to the Airspeed Reference along the tape.

Engine power must be adjusted to allow the autopilot to fly the aircraft at a pitch attitude corresponding to the desired flight profile (climb or descent) while maintaining the Airspeed Reference. The flight director maintains the current altitude until either engine power or the Airspeed Reference are adjusted and does not allow the aircraft to climb or descend away from the Selected Altitude.

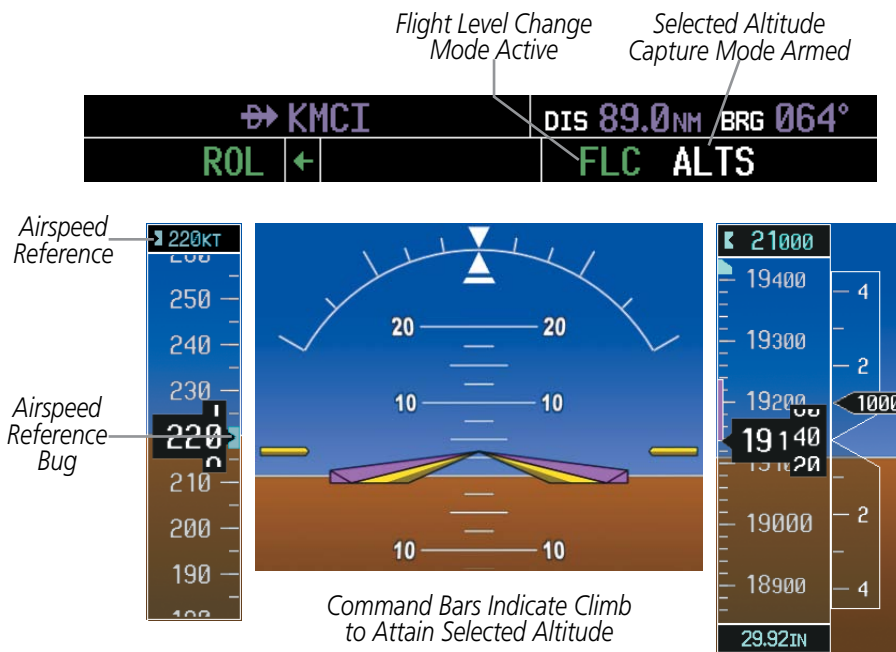

**Figure 7-11 Flight Level Change Mode (IAS)**

### CHANGING THE AIRSPEED REFERENCE (FLC MODE)

The Airspeed Reference (shown above the Airspeed Indicator) may be adjusted by:

- Using the **SPD SEL** Knob
- Pressing the **CWS** Button, hand-flying the aircraft to attain a new Airspeed Reference, then releasing the **CWS** Button

During climb, the Airspeed Reference units automatically change from IAS to Mach when either the altitude or the airspeed listed in Table 7-3 are attained. For descent, the units switch back at the specified altitude or airspeed. The system determines aircraft climb or descent by the relationship between the current and Selected altitudes.

	Airspeed Reference Units		Unit Type Changes At:	
	Default Units	Change To:	Altitude	Airspeed
<b>Climb</b>	IAS	Mach	> 31,500 ft	> M 0.55
<b>Descent</b>	Mach	IAS	< 30,500 ft	< 250 kt

**Table 7-3 FLC Mode Unit Changes**

Airspeed Reference units can be manually toggled between IAS and Mach units by pressing the **SPD SEL** Knob. When the FLC Airspeed Reference is displayed in Mach, the Airspeed Reference Bug is displayed on the Airspeed Indicator at the IAS corresponding to the selected Mach target speed and the current Mach number is shown below the Airspeed Indicator.

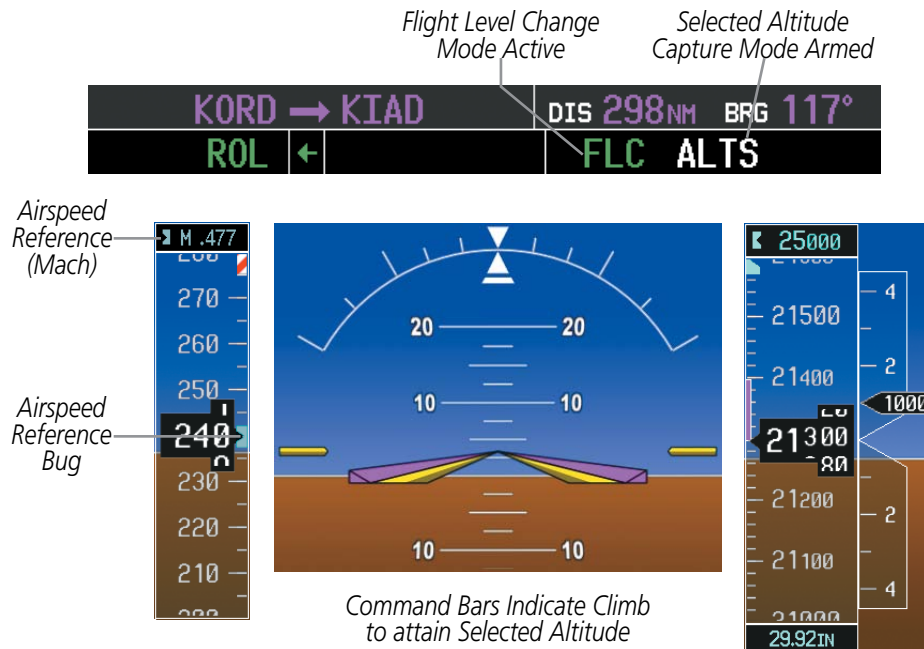

**Figure 7-12 Flight Level Change Mode (Mach)**

The Airspeed Reference Bug can be set at all times (to be used as a visual reference) except when CSC is engaged. In CSC mode the Airspeed Reference Bug is fixed and set at the airspeed existing at the time of CSC engagement. While the bug can be set during these modes it is only being controlled when in FLC mode, when CSC is engaged, etc.

## VERTICAL NAVIGATION MODES (VPTH, ALTV)

 **NOTE:** VNV is disabled when parallel track or Dead Reckoning Mode is active. Refer to the flight Management Section for more information on VNV flight plans.

 **NOTE:** The Selected Altitude takes precedence over any other vertical constraints.

Vertical Navigation (VNV) flight control is available for enroute/terminal cruise and descent operations when VNV flight planning is available. Conditions for availability include, but are not limited to:

- The selected navigation source is GPS.
- A VNV flight plan (with at least one altitude-constrained waypoint) or direct-to (with vertical constraint) is active.
- VNV is enabled (**VNV ENBL** Softkey pressed on the MFD).
- Crosstrack error is valid and within certain limits.
- Desired/actual track are valid or track angle error is within certain limits.
- The VNV Target Altitude of the active waypoint is no more than 250 ft above the current aircraft altitude.
- Parallel track is not active.

The flight director may be armed for VNV at any time, but no target altitudes are captured during a climb. The Command Bars provide vertical profile guidance based on specified altitudes (entered manually or loaded from the database) at waypoints in the active flight plan or direct-to (with vertical constraint). The appropriate VNV flight control modes are sequenced by the flight director to follow the path defined by the vertical profile. Upon reaching the last waypoint in the VNV flight plan, the flight director transitions to Altitude Hold Mode and cancels any armed VNV modes.

## VERTICAL PATH TRACKING MODE (VPTH)

 **NOTE:** If another vertical mode key is pressed while Vertical Path Tracking Mode is selected, Vertical Path Tracking Mode reverts to armed.

 **NOTE:** Pressing the **CWS** Button while Vertical Path Tracking Mode is active does not cancel the mode. The autopilot guides the aircraft back to the descent path upon release of the **CWS** Button.

When a vertical profile (VNV flight plan) is active and the **VNV** Key is pressed, Vertical Path Tracking Mode is armed in preparation for descent path capture. 'VPTH' (or 'V' when Glidepath or Glideslope Mode is concurrently armed) is annunciated in white in addition to previously armed modes. If applicable, the appropriate altitude capture mode is armed for capture of the next VNV Target Altitude (ALTV) or the Selected Altitude (ALTS), whichever is greater.



Figure 7-13 Vertical Path Tracking Armed Annunciations

Prior to descent path interception, the Selected Altitude must be set below the current aircraft altitude by at least 75 feet. For the flight director to transition from Altitude Hold to Vertical Path Tracking Mode, acknowledgment is required within five minutes of descent path interception by:

- Pressing the **VNV** Key
- Adjusting the Selected Altitude

If acknowledgment is not received within one minute of descent path interception, the white ‘VPTH’ annunciation starts to flash. Flashing continues until acknowledged or the descent path is intercepted. If the descent is not confirmed by the time of interception, Vertical Path Tracking Mode remains armed and the descent is not captured.

In conjunction with the “TOD [top of descent] within 1 minute” annunciation in the PFD Navigation Status Box and the “Vertical track” voice message, VNV indications (VNV Target Altitude, vertical deviation, and vertical speed required) appear on the PFDs in magenta (Figure 7-14).

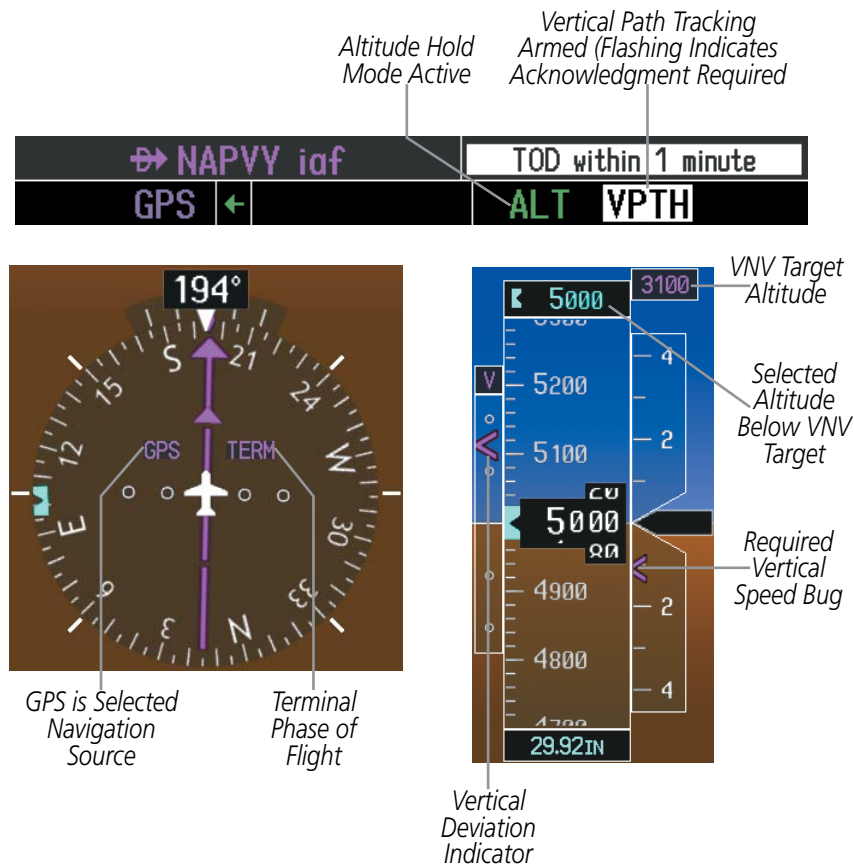

**Figure 7-14 Vertical Path Capture**

When a descent leg is captured (Figure 7-15), Vertical Path Tracking becomes active (magenta 'VPTH' annunciation shown) and tracks the descent profile. An altitude capture mode ('ALTS' or 'ALTV') is armed as appropriate.

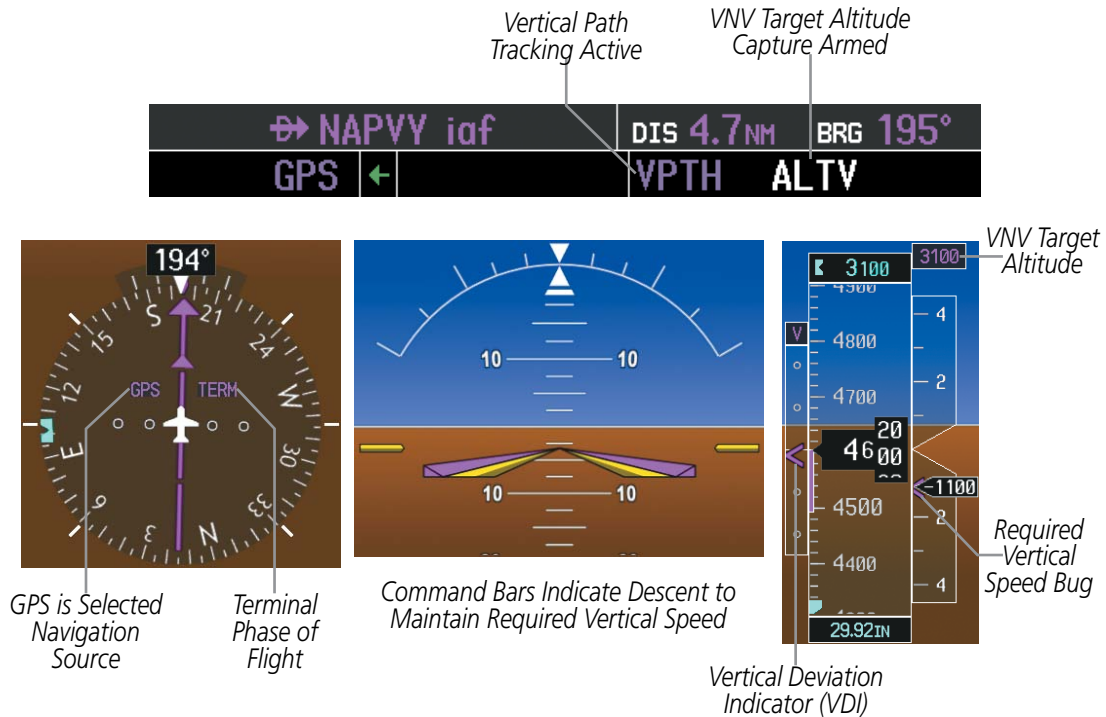

Figure 7-15 Vertical Path Tracking Mode

If the altimeter barometric setting is adjusted while Vertical Path Tracking is active, the flight director increases/decreases the descent rate by up to 500 fpm to re-establish the aircraft on the descent path (without commanding a climb). Adjusting the altimeter barometric setting creates discontinuities in VNV vertical deviation, moving the descent path. For large adjustments, it may take several minutes for the aircraft to re-establish on the descent path. If the change is made while nearing a waypoint with a VNV Target Altitude, the aircraft may not re-establish on the descent path in time to meet the vertical constraint.

## AUTOMATIC REVERSION TO PITCH HOLD MODE

Several situations can occur while Vertical Path Tracking Mode is active which cause the flight director to revert to Pitch Hold Mode:

- Vertical deviation exceeds 200 feet during an overspeed condition.
- Vertical deviation experiences a discontinuity (not due to an altimeter barometric setting adjustment) that both exceeds 200 feet in magnitude and results in the vertical deviation exceeding 200 feet in magnitude. Such discontinuities are usually caused by flight plan changes that affect the vertical profile.
- Vertical deviation becomes invalid (the Vertical Deviation Indicator is removed from the PFD).
- A display enters Reversionary Mode (this does not apply to an active direct-to with vertical constraint).

Unless VNV is disabled, Vertical Path Tracking Mode and the appropriate altitude capture mode become armed following the reversion to Pitch Hold Mode to allow for possible profile recapture.

## NON-PATH DESCENTS

Pitch Hold, Vertical Speed, and Flight Level Change modes can also be used to fly non-path descents while VNV flight control is selected. If the **VS** or **FLC** Key is pressed while Vertical Path Tracking Mode is selected, Vertical Path Tracking Mode reverts to armed along with the appropriate altitude capture mode to allow profile re-capture.



Figure 7-16 Flight Level Change VNV Non-Path Descent

To prevent immediate profile re-capture, the following must be satisfied:

- At least 10 seconds have passed since the non-path transition was initiated
- Vertical deviation from the profile has exceeded 250 feet, but is now less than 200 feet

Pressing the **VNV** Key twice re-arms Vertical Path Tracking for immediate profile re-capture.

**VNV TARGET ALTITUDE CAPTURE MODE (ALTV)**

VNV Target Altitude Capture is analogous to Selected Altitude Capture Mode and is armed automatically after the **VNV** Key is pressed and the next VNV Target Altitude is to be intercepted before the Selected Altitude. The annunciation ‘ALTV’ indicates that the VNV Target Altitude is to be captured. VNV Target Altitudes are shown in the active flight plan or direct-to (with vertical constraint), and can be entered manually or loaded from a database (see the Flight Management Section for details). At the same time as “TOD within 1 minute” is annunciated in the Navigation Status Box, the active VNV Target Altitude is displayed above the Vertical Speed Indicator (see Figure 7-14).

As the aircraft nears the VNV Target Altitude, the flight director automatically transitions to VNV Target Altitude Capture Mode with Altitude Hold Mode armed. This automatic transition is indicated by the magenta ‘ALTV’ annunciation flashing for up to 5 seconds and the appearance of the white ‘ALT’ annunciation. The active VNV Target Altitude is shown in magenta above the Vertical Speed Indicator.

At 50 feet from the VNV Target Altitude, the flight director automatically transitions from VNV Target Altitude Capture to Altitude Hold Mode and tracks the level leg. As Altitude Hold Mode becomes active, the white ‘ALT’ annunciation moves to the active vertical mode field and flashes magenta for 5 seconds to indicate the automatic transition. The flight director automatically arms Vertical Path Tracking, allowing upcoming descent legs to be captured and subsequently tracked.

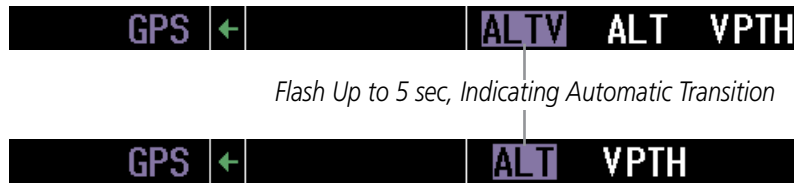

Figure 7-17 VNV Altitude Capture

**CHANGING THE VNV TARGET ALTITUDE**



**NOTE:** Pressing the **CWS** Button while in VNV Target Altitude Capture Mode does not cancel the mode.

Changing the current VNV Target Altitude while VNV Target Altitude Capture Mode is active causes the flight director to revert to Pitch Hold Mode. Vertical Path Tracking and the appropriate altitude capture mode are armed in preparation to capture the new VNV Target Altitude or the Selected Altitude, depending on which altitude is to be intercepted first.

VNV target altitudes can be changed while editing the active flight plan (see the Flight Management Section for details).

**CURRENT SPEED CONTROL (IF AVAILABLE)**

Current Speed Control (if available) can be engaged if the autopilot is engaged and Altitude Hold Mode (ALT) or VNV Target Altitude Capture (ALTV) Mode is active. When the **CSC** Key is pressed, the Full Authority Digital Engine Control (FADEC) varies engine thrust to maintain the desired Airspeed Reference (green Airspeed Reference Bug), within a certain control range.



**NOTE:** For CSC engagement and disengagement detailed conditions, see the approved Pilot’s Operating Handbook (POH).



## GLIDEPATH MODE (GP) (SBAS ONLY)



**NOTE:** Pressing the **CWS** Button while Glidepath Mode is active does not cancel the mode. The autopilot guides the aircraft back to the glidepath upon release of the **CWS** Button.

Glidepath Mode is used to track the SBAS-based glidepath. When Glidepath Mode is armed, 'GP' is annunciated in white in the AFCS Status Box.

### Selecting Glidepath Mode:

- 1) Ensure a GPS approach with vertical guidance (LPV, LNAV/VNAV, LNAV+V) is loaded into the active flight plan. The active waypoint must be part of the flight plan (cannot be a direct-to a waypoint not in the flight plan).
- 2) Ensure that GPS is the selected navigation source (use the **CDI** Softkey to cycle through navigation sources if necessary).
- 3) Press the **APR** Key.



**NOTE:** Some RNAV (GPS) approaches provide a vertical descent angle as an aid in flying a stabilized approach. These approaches are **NOT** considered Approaches with Vertical Guidance (APV). Approaches that are annunciated on the HSI as LNAV or LNAV+V are considered Nonprecision Approaches (NPA) and are flown to an MDA even though vertical glidepath (GP) information may be provided.



**WARNING:** When flying an LNAV approach (with vertical descent angle) with the autopilot coupled, the aircraft will not level off at the MDA even if the MDA is set in the altitude preselect.

Upon reaching the glidepath, the flight director transitions to Glidepath Mode and begins to capture and track the glidepath.



Figure 7-18 Glidepath Mode Armed

Once the following conditions have been met, the glidepath can be captured (magenta 'GP' annunciation):

- The active waypoint is at or after the final approach fix (FAF)
- Vertical deviation is valid
- The CDI is at less than full scale deviation
- Automatic sequencing of waypoints has not been suspended (no 'SUSP' annunciation on the HSI)

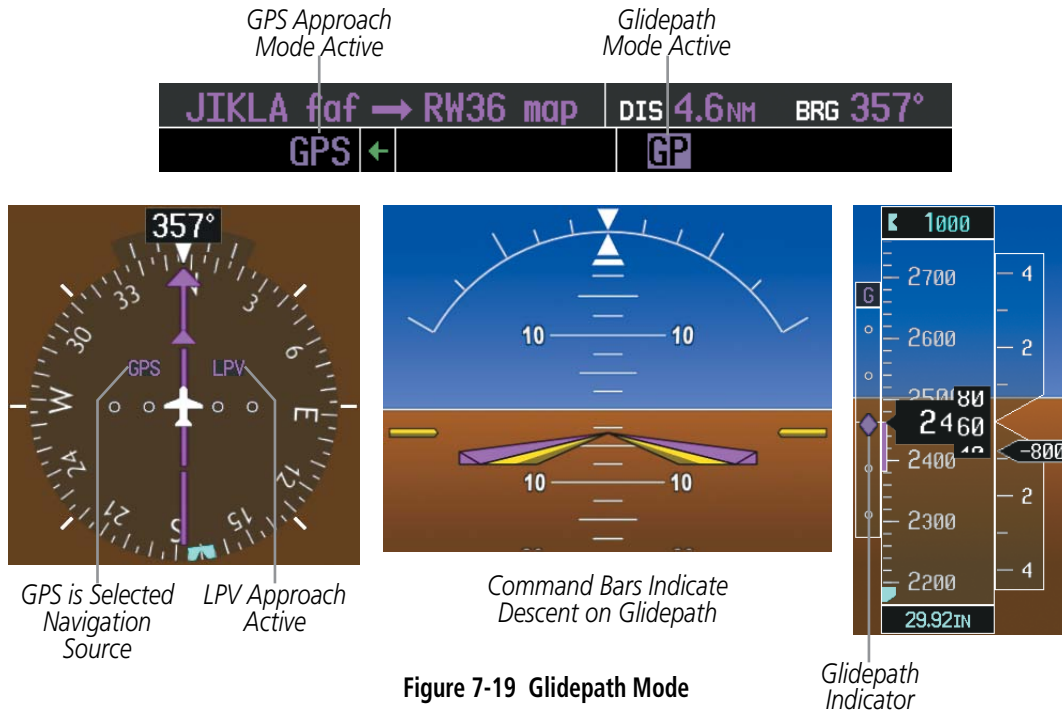

Figure 7-19 Glidepath Mode

## GLIDESLOPE MODE (GS)

**NOTE:** Pressing the **CWS** Button while Glideslope Mode is active does not cancel the mode. The autopilot guides the aircraft back to the glideslope upon release of the **CWS** Button.

Glideslope Mode is available for LOC/ILS approaches to capture and track the glideslope. When Glideslope Mode is armed, LOC Approach Mode is armed as the lateral flight director mode.

### Selecting Glideslope Mode:

- 1) Ensure a valid localizer frequency is tuned.
- 2) Ensure that LOC is the selected navigation source (use the **CDI** Softkey to cycle through navigation sources if necessary).
- 3) Press the **APR** Key.

**Or:**

- 1) Ensure that GPS is the selected navigation source (use the **CDI** Softkey to cycle through navigation sources if necessary).
- 2) Ensure a LOC/ILS approach is loaded into the active flight plan.
- 3) Ensure the corresponding LOC frequency is tuned.
- 4) Press the **APR** Key.



Figure 7-20 Glideslope Mode Armed

Once LOC is the navigation source, the localizer and glideslope can be captured. Upon reaching the glideslope, the flight director transitions to Glideslope Mode and begins to capture and track the glideslope.

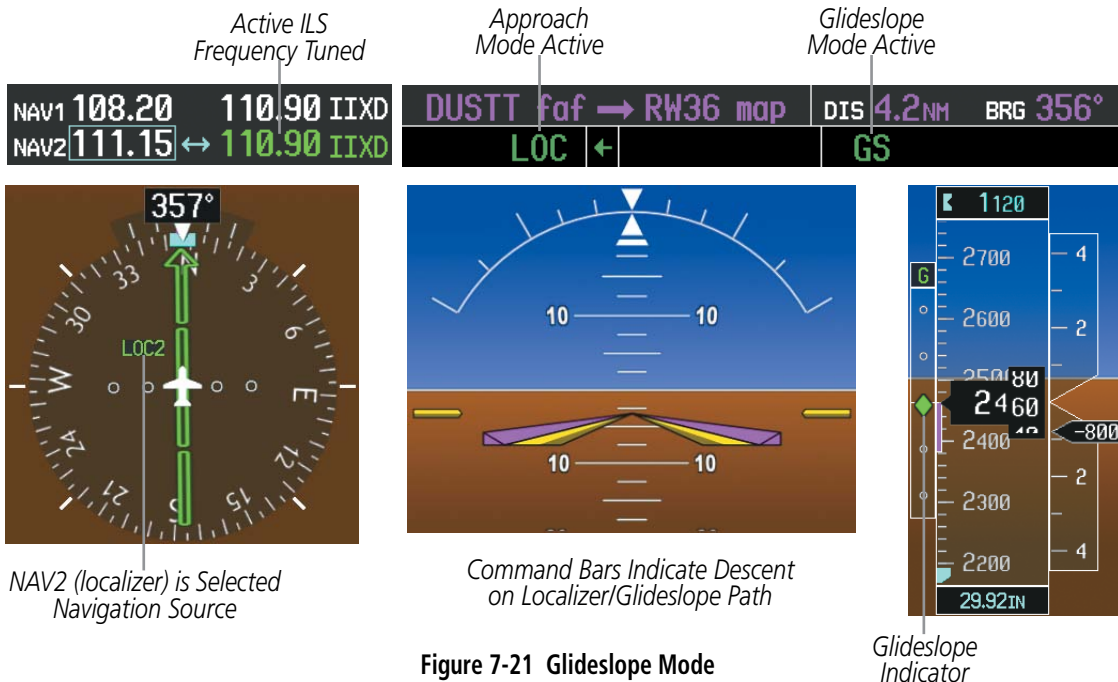

Figure 7-21 Glideslope Mode

**TAKEOFF (TO) AND GO AROUND (GA) MODES**

In Go Around and Takeoff modes, the flight director commands a constant set pitch attitude. The **TO/GA** Switch is used to select both modes. The mode entered by the flight director depends on whether the aircraft is on the ground. Selected Altitude Capture Mode is automatically armed when the aircraft is at least 400 feet below the Selected Altitude at the time Takeoff or Go Around Mode is selected. When Takeoff or Go Around mode is activated, the lateral mode is annunciated as ‘ROL’.

Takeoff Mode provides an attitude reference during rotation and takeoff. This mode can be selected only while on the ground by pushing the **TO/GA** Switch. The flight director Command Bars assume a wings-level, pitch-up attitude. Autopilot engagement while Takeoff Mode is active is inhibited while the aircraft is on the ground.

Pressing the **TO/GA** Switch while in the air activates the flight director in a wings-level, pitch-up attitude, allowing the execution of a missed approach or a go around. Selecting Go Around Mode disengages the autopilot; however, subsequent autopilot engagement is allowed. Attempts to modify the aircraft attitude (i.e., with the **CWS** Button) result in reversion to Pitch Hold Mode.

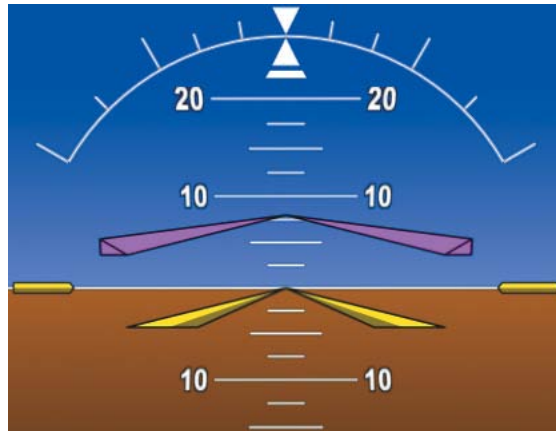
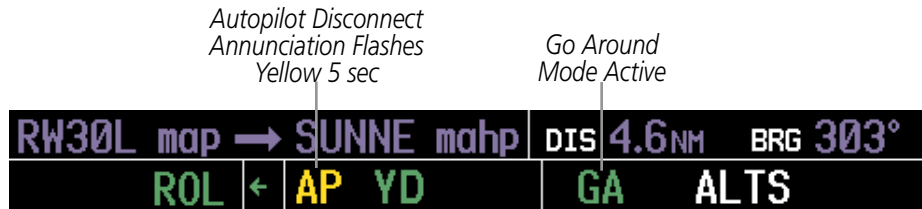

Command Bars Indicate Climb



Figure 7-22 Takeoff and Go Around Modes

## 7.4 LATERAL MODES

The following table relates each GFC 700 lateral mode to its respective control and annunciation. Refer to the vertical modes section for information regarding Takeoff and Go Around mode.

Lateral Mode	Description	Control	Annunciation	Maximum Roll Command Limit
Roll Hold	Holds the current aircraft roll attitude or rolls the wings level, depending on the commanded bank angle	(default)	ROL	30°
Low Bank	Limits the maximum commanded roll angle	<b>BANK</b> Key	*	15°
Heading Select **	Captures and tracks the Selected Heading	<b>HDG</b> Key	HDG	30°
Navigation, GPS **	Captures and tracks the selected navigation source (GPS, VOR, LOC)	<b>NAV</b> Key	GPS	30°
Navigation, VOR Enroute Capture/Track **			VOR	25° Capture 10° Track
Navigation, LOC Capture/Track (No Glideslope)			LOC	25° Capture 10° Track
Navigation, Backcourse Arm/Capture/Track			BC	25° Capture 10° Track
Approach, GPS	Captures and tracks the selected navigation source (GPS, VOR, LOC)	<b>APR</b> Key	GPS	30°
Approach, VOR Capture/Track			VAPP	25° Capture 10° Track
Approach, LOC Capture/Track (Glideslope Mode automatically armed)			LOC	25° Capture 10° Track

\* No annunciation appears in the AFCS Status Box. The acceptable bank angle range is indicated in green along the Roll Scale of the Attitude Indicator.

\*\* The Heading, Navigation GPS and Navigation VOR mode maximum roll command limit will be limited to the Low Bank mode value if it is engaged.

The GFC 700 limits turn rate to 3 degrees per second (standard rate turn).

**Table 7-4 Flight Director Lateral Modes**

The **CWS** Button does not change lateral references for Heading Select, Navigation, Backcourse, or Approach Mode. The autopilot guides the aircraft back to the Selected Heading/Course upon release of the **CWS** Button.

**ROLL HOLD MODE (ROL)**



**NOTE:** If Roll Hold Mode is activated as a result of a mode reversion, the flight director rolls wings level.

When the flight director is activated or switched, Roll Hold Mode is selected by default. This mode is announced as ‘ROL’ in the AFCS Status Box. The current aircraft bank angle is held, subject to the bank angle condition.



Figure 7-23 Roll Hold Mode Annunciation

Bank Angle	Flight Director Response
< 6°	Rolls wings level
6 to 30°	Maintains current aircraft roll attitude
> 30°	Limits bank to 30°

Table 7-5 Roll Hold Mode Responses

**CHANGING THE ROLL REFERENCE**

The roll reference can be changed by pressing the **CWS** Button, establishing the desired bank angle, then releasing the **CWS** Button.

**LOW BANK MODE**

When in Low Bank Mode, the flight director limits the maximum commanded roll angle to 15°. Low bank arc limits are displayed in green along the Roll Scale. Low Bank Mode can be manually selected/deselected by pressing the **BANK** Key while in Heading Select or Navigation Modes (GPS and VOR).



Figure 7-24 Low Bank Mode Limits

## HEADING SELECT MODE (HDG)

Heading Select Mode is activated by pressing the **HDG** Key. Heading Select Mode acquires and maintains the Selected Heading. The Selected Heading is shown by a light blue bug on the HSI and in the box to the upper left of the HSI.

### CHANGING THE SELECTED HEADING



**NOTE:** Pressing the **HDG SEL** Knob synchronizes the Selected Heading to the current heading.

The Selected Heading is adjusted using the **HDG SEL** Knob. Pressing the **CWS** Button and hand-flying the aircraft does not change the Selected Heading. The autopilot guides the aircraft back to the Selected Heading upon release of the **CWS** Button.

Turns are commanded in the same direction as Selected Heading Bug movement, even if the bug is turned more than 180° from the present heading (e.g., a 270° turn to the right). However, Selected Heading changes of more than 330° at a time result in turn reversals.

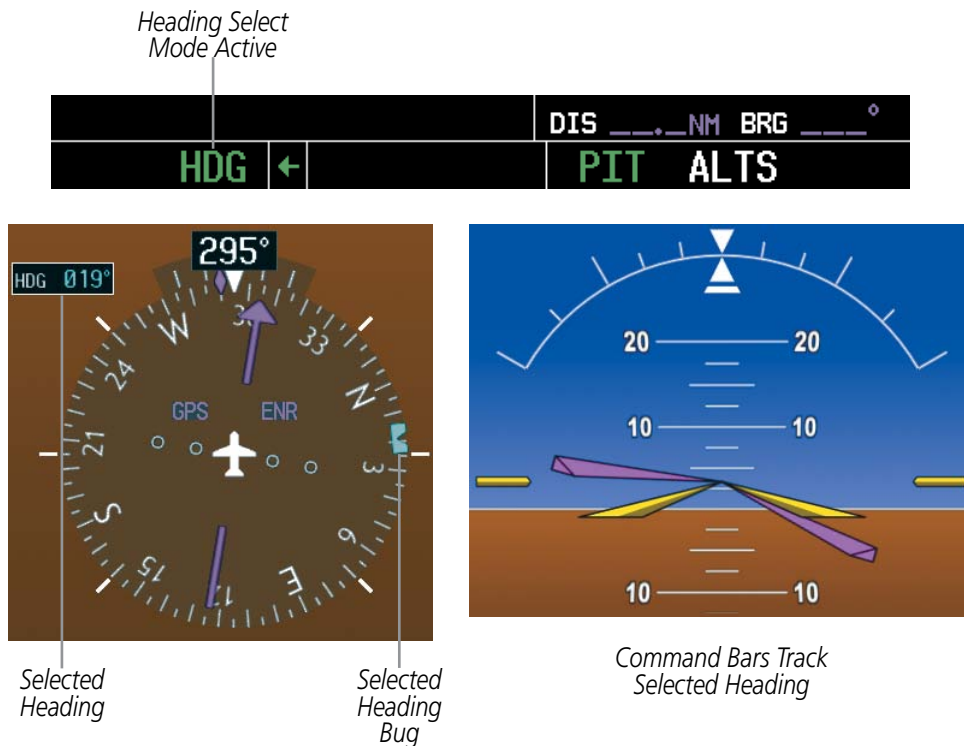



Figure 7-25 Heading Select Mode

**NAVIGATION MODES (GPS, VOR, LOC, BC)**

 **NOTE:** The selected navigation receiver must have a valid VOR or LOC signal or active GPS course for the flight director to enter Navigation Mode.

Pressing the **NAV** Key selects Navigation Mode. Navigation Mode acquires and tracks the selected navigation source (GPS, VOR, LOC). The flight director follows GPS roll steering commands when GPS is the selected navigation source. When the navigation source is VOR or LOC, the flight director creates roll steering commands from the Selected Course and deviation. Navigation Mode can also be used to fly non-precision GPS and LOC approaches where vertical guidance is not required.

Backcourse Mode captures and tracks a localizer signal in the backcourse direction. The mode may be selected by pressing the **NAV** Key. When making a backcourse approach, set the Selected Course to the localizer front course. The flight director creates roll steering commands from the Selected Course and deviation.

If the Course Deviation Indicator (CDI) shows greater than one dot when the **NAV** Key is pressed, the selected mode is armed. If the CDI is less than one dot, Navigation Mode is automatically captured when the **NAV** Key is pressed. The armed annunciation appears in white to the left of the active lateral mode.



**Figure 7-26 GPS Navigation Mode Armed**

When the CDI has automatically switched from GPS to LOC during a LOC/ILS approach, GPS Navigation Mode remains active, providing GPS steering guidance until the localizer signal is captured. LOC Navigation Mode is armed automatically when the navigation source switch takes place if the **APR** Key is not pressed prior to the automatic source switch.

If Navigation Mode is active and either of the following occur, the flight director reverts to Roll Hold Mode (wings rolled level):

- Different VOR tuned while in VOR Navigation Mode (VOR Navigation Mode reverts to armed)
- Navigation source manually switched (with the **CDI** Softkey)
- During a LOC/ILS approach, the FAF crossed while in GPS Navigation Mode after the automatic navigation source switch from GPS to LOC

**CHANGING THE SELECTED COURSE**

If the navigation source is VOR or localizer or OBS Mode has been enabled when using GPS, the Selected Course is controlled using the **CRS** Knob corresponding to the selected flight director (**CRS1** for the pilot side, **CRS2** for the copilot side).

Pressing the **CWS** Button and hand-flying the aircraft does not change the Selected Course while in Navigation Mode. The autopilot guides the aircraft back to the Selected Course (or GPS flight plan) when the **CWS** Button is released.



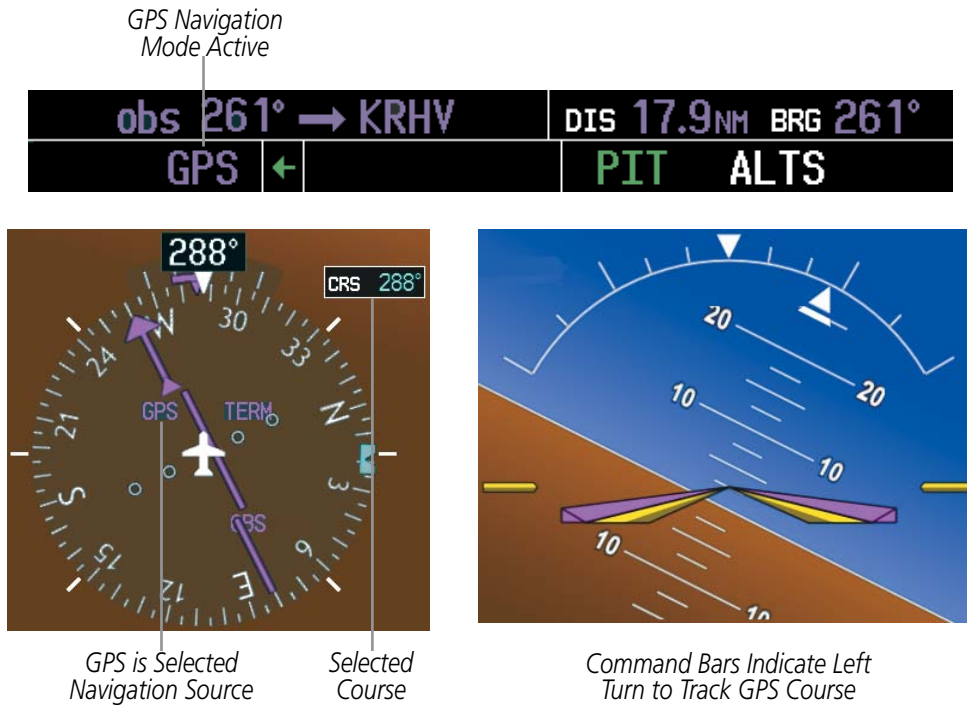

**Figure 7-27 Navigation Mode**

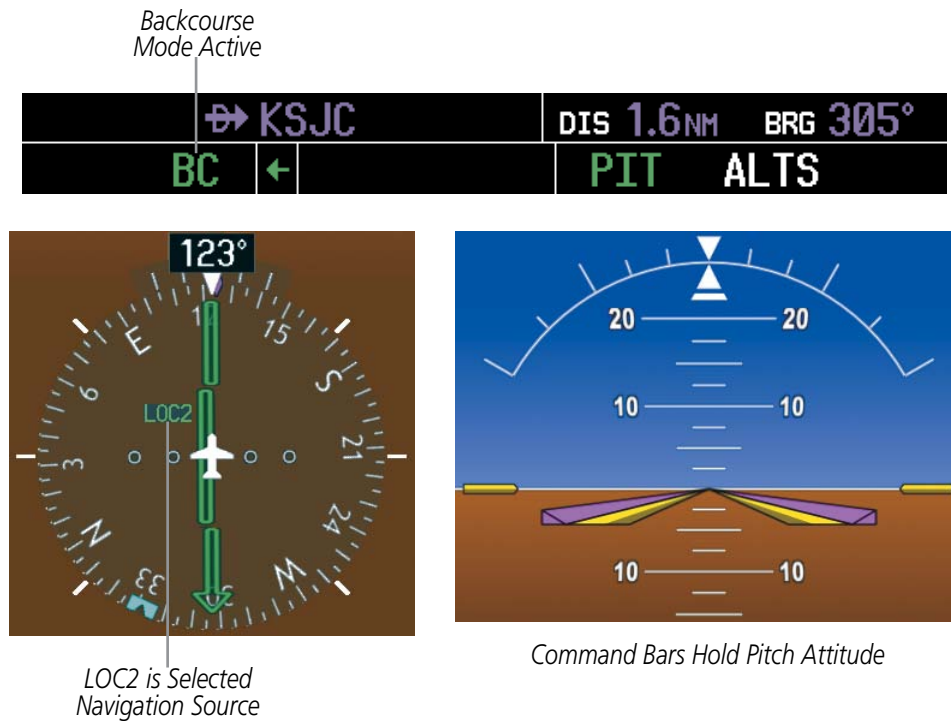

**Figure 7-28 Backcourse Mode**

**APPROACH MODES (GPS, VAPP, LOC)**



**NOTE:** *The selected navigation receiver must have a valid VOR or LOC signal or active GPS course for the flight director to enter Approach Mode.*

Approach Mode is activated when the **APR** Key is pressed. Approach Mode acquires and tracks the selected navigation source (GPS, VOR, or LOC), depending on loaded approach. This mode uses the selected navigation receiver deviation and desired course inputs to fly the approach. Pressing the **APR** Key when the CDI is greater than one dot arms the selected approach mode (annunciated in white to the left of the active lateral mode). If the CDI is less than one dot, the LOC is automatically captured when the **APR** Key is pressed.

VOR Approach Mode (VAPP) provides greater sensitivity for signal tracking than VOR Navigation Mode.

**Selecting VOR Approach Mode:**

- 1) Ensure a valid VOR frequency is tuned.
- 2) Ensure that VOR is the selected navigation source (use the **CDI** Softkey to cycle through navigation sources if necessary).
- 3) Press the **APR** Key.

When GPS Approach Mode is armed, Glidepath Mode is also armed.

**Selecting GPS Approach Mode:**

- 1) Ensure a GPS approach is loaded into the active flight plan. The active waypoint must be part of the flight plan (cannot be a direct-to a waypoint not in the flight plan).
- 2) Ensure that GPS is the selected navigation source (use the **CDI** Softkey to cycle through navigation sources if necessary).
- 3) Press the **APR** Key.



Figure 7-29 GPS Approach Mode Armed

LOC Approach Mode allows the autopilot to fly a LOC/ILS approach with a glideslope. When LOC Approach Mode is armed, Glideslope Mode is also armed automatically. LOC captures are inhibited if the difference between aircraft heading and localizer course exceeds 105°.

### Selecting LOC Approach Mode:

- 1) Ensure a valid localizer frequency is tuned.
- 2) Ensure that LOC is the selected navigation source (use the **CDI** Softkey to cycle through navigation sources if necessary).
- 3) Press the **APR** Key.

**Or:**

- 1) Ensure that GPS is the selected navigation source (use the **CDI** Softkey to cycle through navigation sources if necessary).
- 2) Ensure a LOC/ILS approach is loaded into the active flight plan.
- 3) Ensure the corresponding LOC frequency is tuned.
- 4) Press the **APR** Key.

If the following occurs, the flight director reverts to Roll Hold Mode (wings rolled level):

- Vectors-to-Final is activated
- Navigation source is manually switched
- During a LOC/ILS approach, GPS Navigation Mode is active and the FAF is crossed after the automatic navigation source switch from GPS to LOC

## CHANGING THE SELECTED COURSE

If the navigation source is VOR or localizer or OBS Mode has been enabled when using GPS, the Selected Course is controlled using the **CRS** Knob corresponding to the selected flight director (**CRS1** for the pilot side, **CRS2** for the copilot side).

Pressing the **CWS** Button and hand-flying the aircraft does not change the Selected Course while in Approach Mode. The autopilot guides the aircraft back to the Selected Course (or GPS flight plan) when the **CWS** Button is released.

## INTERCEPTING AND FLYING A DME ARC

The AFCS will intercept and track a DME arc that is part of the active flight plan provided that GPS Navigation Mode is engaged, GPS is the active navigation source on the CDI, and the DME arc segment is the active flight plan leg. It is important to note that automatic navigation of DME arcs is based on GPS. Thus, even if the APR key is pressed and LOC or VOR Approach Mode is armed prior to reaching the Initial Approach Fix (IAF), Approach Mode will not activate until the arc segment is completed.

If the pilot decides to intercept the arc at a location other than the published IAF (i.e. ATC provides vectors to intercept the arc) and subsequently selects Heading Mode or Roll Mode, the AFCS will not automatically intercept or track the arc unless the pilot activates the arc leg of the flight plan and arms GPS Navigation Mode. The AFCS will not intercept and fly a DME arc before reaching an IAF that defines the beginning of the arc segment. Likewise, if at any point while established on the DME arc the pilot deselects GPS Navigation Mode, the AFCS will no longer track the arc.

## 7.5 AUTOPILOT AND YAW DAMPER OPERATION



**NOTE:** Refer to the Airplane Flight Manual (AFM) for specific instructions regarding emergency procedures.

The autopilot and yaw damper operate the flight control surface servos to provide automatic flight control. The autopilot controls the aircraft pitch and roll attitudes following commands received from the flight director. Pitch autotrim provides trim commands to the pitch trim actuator to relieve any sustained effort required by the pitch servo.

The yaw damper reduces Dutch roll tendencies and coordinates turns. It can operate independently of the autopilot and may be used during normal hand-flight maneuvers. Yaw rate commands are limited by the yaw damper.

### FLIGHT CONTROL

Pitch and roll commands are provided to the servos based on the active flight director modes. Yaw damping is provided by the yaw servo. Servo motor control limits the maximum servo speed and torque. The servo gearboxes are equipped with slip-clutches that allow the servos to be overridden in case of an emergency.

### PITCH AXIS AND TRIM

The autopilot pitch axis uses pitch rate to stabilize the aircraft pitch attitude during upsets and flight director maneuvers. Flight director pitch commands are rate- and attitude-limited, combined with pitch damper control, and sent to the pitch servo motor.

When the autopilot is engaged, the automatic pitch trim (APT) function commands the pitch trim actuator to reduce the average pitch servo effort. When the autopilot is not engaged and airspeed is within a certain range, the pitch trim system provides Mach trim (MT).

Manual electric pitch trim (MEPT) functionality is available at any time via the pilot and copilot **MEPT** Switches. Manual trim commands are generated only when both halves of the **MEPT** Switch are operated simultaneously. Operating the **MEPT** Switches when the autopilot is engaged will cause the autopilot to disconnect. Trim speeds are scheduled with airspeed to provide more consistent response.

The pilot side **MEPT** Switch has priority over the copilot side **MEPT** Switch.

### ROLL AXIS

The autopilot roll axis uses roll rate to stabilize aircraft roll attitude during upsets and flight director maneuvers. The flight director roll commands are rate- and attitude-limited, combined with roll damper control, and sent to the roll servo motor.

### YAW AXIS

The yaw damper uses yaw rate and roll attitude to dampen the aircraft's natural Dutch roll response. It also uses lateral acceleration to coordinate turns. Yaw damper operation is independent of autopilot engagement.

## ENGAGING THE AUTOPILOT AND YAW DAMPER



**NOTE:** Autopilot engagement/disengagement is not equivalent to servo engagement/disengagement. Use the **CWS** Button to disengage the pitch and roll servos while the autopilot remains active.

When the **AP** Key is pressed, the autopilot, yaw damper, and flight director (if not already active) are activated. The flight director engages in Pitch and Roll Hold Modes when initially activated. When the **YD** Key is pressed, the system engages the yaw damper independently of the autopilot. Autopilot and yaw damper status are displayed in the center of the AFCS Status Box. Engagement is indicated by green ‘AP’ and ‘YD’ annunciations, respectively.



Figure 7-30 Autopilot and Yaw Damper Engaged

## CONTROL WHEEL STEERING

During autopilot operation, the aircraft may be hand-flown without disengaging the autopilot. Pressing and holding the **CWS** Button disengages the pitch and roll servos from the flight control surfaces and allows the aircraft to be hand-flown. At the same time, the flight director is synchronized to the aircraft attitude during the maneuver. Pitch trim operation is interrupted during CWS activity; yaw damper engagement is unaffected.

The ‘AP’ annunciation is temporarily replaced by ‘CWS’ in white for the duration of CWS maneuvers.



Figure 7-31 CWS Annunciation

In most scenarios, releasing the **CWS** Button re-engages the autopilot with a new reference. Refer to flight director mode descriptions for specific CWS behavior in each mode.

**DISENGAGING THE AUTOPILOT AND YAW DAMPER**

 **NOTE:** Pressing the **AP** Key does not disengage the yaw damper.

Manual autopilot disengagement is indicated by a five-second flashing red ‘AP’ annunciation and an autopilot disconnect aural alert, “Autopilot”. The autopilot is manually disengaged by pushing the **AP** Key on the AFCS Control Unit, the **GA** Switch, the **MEPT** Switches, or the **AP DISC** Switch (also disengages the yaw damper, if engaged). Pressing the **YD** Key disengages the yaw damper independently of the autopilot. The ‘YD’ annunciation is removed upon disengagement.

After manual disengagement, the autopilot disconnect aural alert and flashing ‘AP’ annunciation may be cancelled by pushing the **AP DISC** Switch.



**Figure 7-32 Manual Autopilot Disengagement**

Automatic autopilot disengagement is indicated by a flashing red and white ‘AP’ annunciation and the autopilot disconnect aural alert, which continue until acknowledged by pushing the **AP DISC** Switch. Automatic autopilot disengagement occurs due to:

- System failure
- Invalid sensor data
- Stall warning (YD also disengages)
- Inability to compute default flight director modes (FD also disengages automatically)

Automatic yaw damper disengagement is indicated by a five-second flashing yellow ‘YD’ annunciation. The yaw damper automatically disengages when autopilot disengagement is caused by failure in a parameter also affecting the yaw damper. This means the yaw damper can remain operational in some cases where the autopilot automatically disengages. A localized failure in the yaw damper system or invalid sensor data also cause yaw damper disengagement.



**Figure 7-33 Automatic Autopilot and Yaw Damper Disengagement**

## 7.6 EXAMPLE FLIGHT PLAN



**NOTE:** The following example flight plan and diagrams (not to be used for navigation) in this section are for instructional purposes only and should be considered not current. Numbered portions of accompanying diagrams correspond to numbered procedure steps.

This scenario-based set of procedures (based on the example flight plan found in the Flight Management Section) shows various GFC 700 AFCS modes used during a flight. In this scenario, the aircraft departs Charles B. Wheeler Downtown Airport (KMKC), enroute to Colorado Springs Airport (KCOS). After departure, the aircraft climbs to 12,000 ft and airway V4 is intercepted, following ATC vectors.

Airway V4 is flown to Salina VOR (SLN) using VOR navigation, then airway V244 is flown using a GPS flight plan. The ILS approach for runway 35L and LPV (WAAS) approach for runway 35R are shown and a missed approach is executed.

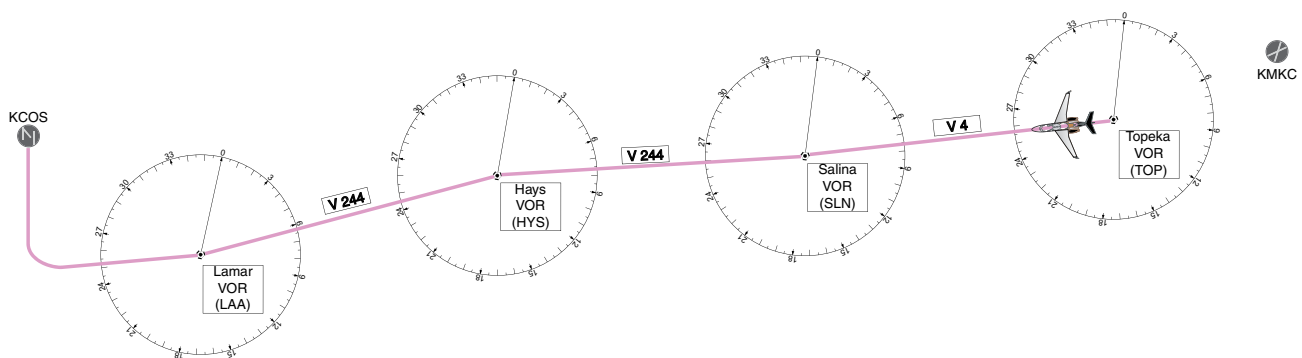

Figure 7-34 Flight Plan Overview

**DEPARTURE**

**Climbing to the Selected Altitude and flying an assigned heading:**

- 1) Before takeoff:
  - a) Use the **ALT SEL** Knob to set the Selected Altitude to 12,000 feet.
  - b) Push the **GA** Switch to activate Takeoff Mode. The flight director Command Bars establish a pitch up attitude to follow.



- c) Press the **AP** Key to engage the autopilot in a climb, holding the pitch angle commanded in Takeoff Mode and wings level.



- 2) In this example, Vertical Speed Mode is used to capture the Selected Altitude (Pitch Hold, Vertical Speed, or Flight Level Change Mode may be used).
  - a) Press the **VS** Key to activate Vertical Speed and Roll Hold modes and arm Selected Altitude Capture Mode. The Vertical Speed Reference may be adjusted after Vertical Speed Mode is selected using the **UP/DN** Wheel or pushing the **CWS** Button while hand-flying the aircraft to establish a new Vertical Speed Reference.



- 3) Use the **HDG SEL** Knob to set the Selected Heading, complying with ATC vectors to intercept Airway V4. Press the **HDG** Key to activate Heading Select Mode while the autopilot is engaged in the climb. The autopilot follows the Selected Heading Bug on the HSI and turns the aircraft to the desired heading.



- 4) As the aircraft nears the Selected Altitude, the flight director transitions to Selected Altitude Capture Mode, indicated by the green 'ALTS' annunciation flashing for up to 5 seconds.



At 50 feet from the Selected Altitude, the green 'ALT' annunciation flashes for up to 5 seconds; the autopilot transitions to Altitude Hold Mode and levels the aircraft.





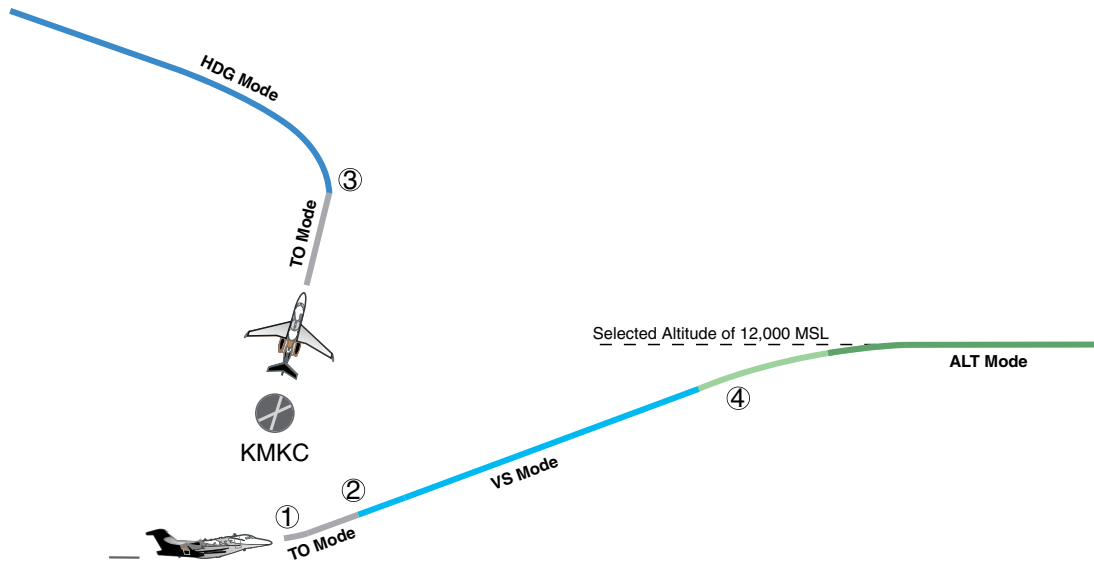

**Figure 7-35 Departure**

## INTERCEPTING A VOR RADIAL

During climb-out, the autopilot continues to fly the aircraft in Heading Select Mode. Airway V4 to Salina VOR (SLN) should now be intercepted. Since the enroute flight plan waypoints correspond to VORs, flight director Navigation Mode using either VOR or GPS as the navigation source may be used. In this scenario, VOR Navigation Mode is used for navigation to the first VOR waypoint in the flight plan.

### Intercepting a VOR radial:

- 1) Arm VOR Navigation Mode:
  - a) Tune the VOR frequency.
  - b) Press the **CDI** Softkey to set the navigation source to VOR.
  - c) Use the **CRS1** or **CRS2** Knob to set the Selected Course to the desired value, 255°. Note that at this point, the flight director is still in Heading Select Mode and the autopilot continues to fly the Selected Heading, 290°.
  - d) Press the **NAV** Key. This arms VOR Navigation Mode and the white 'VOR' annunciation appears to the left of the active lateral mode.



- 2) As the aircraft nears the Selected Course, the flight director transitions from Heading Select to VOR Navigation Mode and the 'VOR' annunciation flashes green. The autopilot begins turning to intercept the Selected Course.



- 3) The autopilot continues the turn until the aircraft is established on the Selected Course.

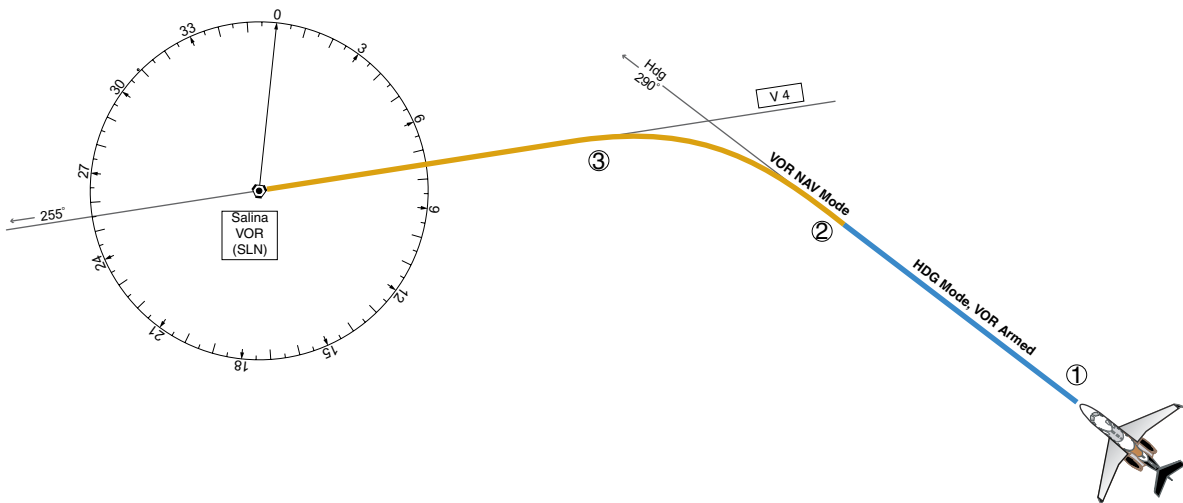

Figure 7-36 Intercepting a VOR Radial

**FLYING A FLIGHT PLAN/GPS COURSE**

**NOTE:** Changing the navigation source cancels the Navigation Mode and causes the flight director to revert back to Roll Hold Mode (wings rolled level).

As the aircraft closes on Salina VOR, GPS is used to navigate the next leg, airway V244. The aircraft is currently tracking inbound on Airway V4.

**Flying a GPS flight plan:**

- 1) Transition from VOR to GPS Navigation Mode:
  - a) Press the **CDI** Softkey until GPS is the selected navigation source.
  - b) Press the **NAV** Key to activate GPS Navigation Mode. The autopilot steers the aircraft toward the active flight plan leg.



- 2) Following the flight plan, the autopilot continues to steer the aircraft under GPS guidance. Note that in GPS Navigation Mode, course changes defined by the flight plan are automatically made without pilot action required.

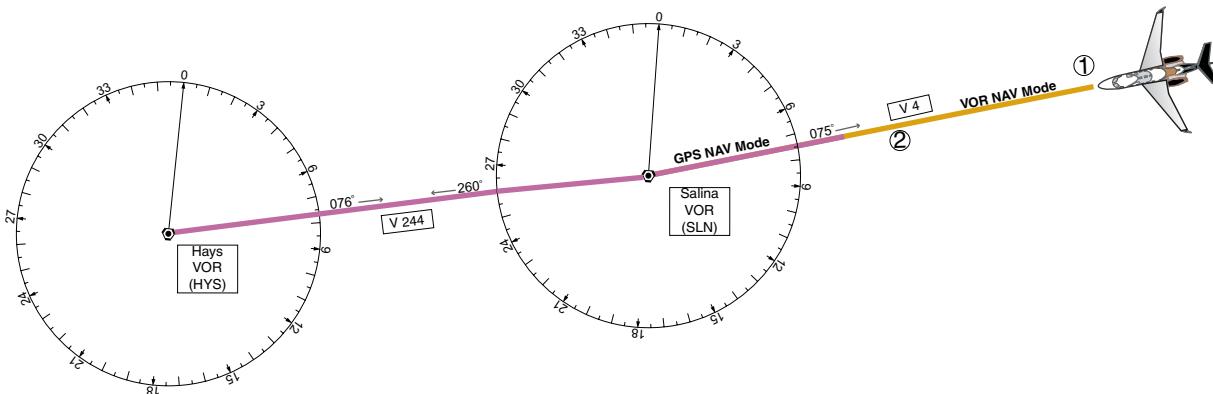

**Figure 7-37 Transition to GPS Flight Plan**

**DESCENT**

While flying the arrival procedure, the aircraft is cleared for descent in preparation for the approach to KCOS. Three methods are presented for descent:

- Flight Level Change descent – Flight Level Change Mode can be used to descend to the Selected Altitude at a constant airspeed. This descent method does not account for flight plan waypoint altitude constraints.
- Vertical Path Tracking descent – Vertical Path Tracking Mode is used to follow the vertical descent path defined in the GPS flight plan. Altitude constraints correspond to waypoints in the flight plan. Before VNV flight control can provide vertical profile guidance, a VNV flight plan must be entered and enabled.
- Non-path descent in a VNV scenario – A VNV flight plan is entered and enabled however, Pitch Hold, Vertical Speed, or Flight Level Change Mode can be used to descend to the VNV Target Altitude prior to reaching the planned TOD. Flight Level Change Mode is used in the example.

**Flight Level Change descent:**

- 1) Select Flight Level Change Mode:
  - a) Using the **ALT SEL** Knob, set the Selected Altitude to 10,000 feet.
  - b) Press the **FLC** Key to activate Flight Level Change Mode. The annunciation 'FLC' appears in the AFCS Status Box and the Airspeed Reference (above the Airspeed Indicator) defaults to the current aircraft airspeed. Selected Altitude Capture Mode is armed automatically.



- c) If desired press the **SPD SEL** Knob to change the Airspeed Reference units to Mach.
- 2) Use the **SPD SEL** Knob or push the **CWS** Button while hand-flying the aircraft to adjust the commanded airspeed while maintaining the same power, or reduce power to allow descent in Flight Level Change Mode while the autopilot maintains the current airspeed.
  - 3) As the aircraft nears the Selected Altitude, the flight director transitions to Selected Altitude Capture Mode, indicated by the green 'ALTS' annunciation flashing for up to 5 seconds.



The green 'ALT' annunciation flashes for up to 5 seconds upon reaching 50 feet from the Selected Altitude; the autopilot transitions to Altitude Hold Mode and levels the aircraft.

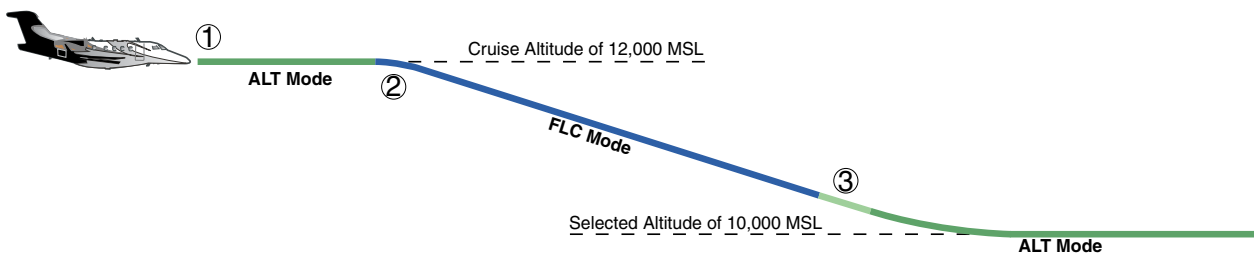

Figure 7-38 FLC Descent

**Vertical Path Tracking descent to VNV Target Altitude:**

1) Select VNV flight control:

a) Press the **VNV** Key to arm Vertical Path Tracking Mode. The white annunciation 'VPTH' appears.



b) Using the **ALT SEL** Knob, set the Selected Altitude below the flight plan's VNV Target Altitude of 10,000 feet.

If the Selected Altitude is not at least 75 ft below the VNV Target Altitude, the flight director commands descent to the Selected Altitude rather than the VNV Target Altitude once Vertical Path Tracking Mode becomes active (ALTS is armed rather than ALTV).

c) If Vertical Path Tracking Mode is armed more than 5 minutes prior to descent path capture, acknowledgment is required for the flight director to transition from Altitude Hold to Vertical Path Tracking Mode. To proceed with descent path capture if the white 'VPTH' annunciation begins flashing, do one of the following

- Press the **VNV** Key
- Turn the **ALT SEL** Knob to adjust the Selected Altitude

If the descent is not confirmed by the time of interception, Vertical Path Tracking Mode remains armed and the descent is not captured.

2) When the top of descent (TOD) is reached, the flight director transitions to Vertical Path Tracking Mode and begins the descent to the VNV Target Altitude. Intention to capture the VNV Target Altitude is indicated by the white 'ALTV' annunciation.



3) As the aircraft nears the VNV Target Altitude, the flight director transitions to VNV Target Altitude Capture Mode, indicated by the magenta 'ALTV' annunciation flashing for up to 5 seconds.



The magenta 'ALT' annunciation flashes for up to 5 seconds upon reaching 50 feet from the VNV Target Altitude; the autopilot transitions to Altitude Hold Mode and levels the aircraft at the vertical waypoint.

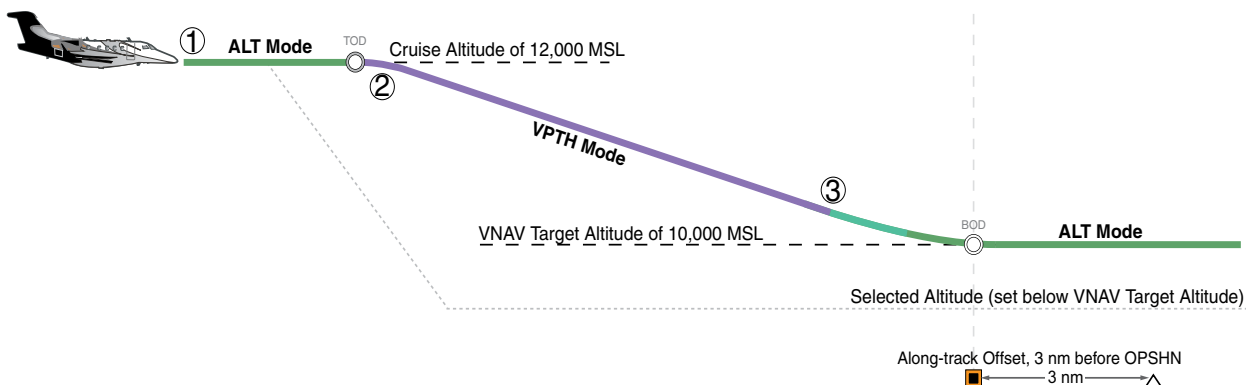

**Figure 7-39 VPTH Descent**

**Non-path descent using Flight Level Change Mode:**

- 1) Using Flight Level Change Mode, command a non-path descent to an intermediate altitude above the next VNV flight plan altitude:
  - a) Using the **ALT SEL** Knob, set the Selected Altitude below the current aircraft altitude to an altitude (in this case, 9,400 feet) at which to level off between VNV flight plan altitudes.
  - b) Press the **FLC** Key before the planned TOD during an altitude hold while VPTH is armed. The Airspeed Reference defaults to the current aircraft airspeed. Vertical Path Tracking and Selected Altitude Capture Mode are armed automatically.

GPS | ← AP YD | FLC ALTS VPTH

- 2) Reduce power to allow descent in Flight Level Change Mode. The autopilot maintains the Airspeed Reference.
- 3) As the aircraft nears the Selected Altitude, the flight director transitions to Selected Altitude Capture Mode, indicated by the green 'ALTS' annunciation flashing for up to 5 seconds.

GPS | ← AP YD | ALTS ALT VPTH

The green 'ALT' annunciation flashes for up to 5 seconds upon reaching 50 feet from the Selected Altitude; the autopilot transitions to Altitude Hold Mode and levels the aircraft. After leveling off reset Selected Altitude at or below 9,000 ft.

GPS | ← AP YD | ALT VPTH

- 4) When the next TOD is reached, Vertical Path Tracking becomes active (may require acknowledgment to allow descent path capture).

GPS | ← AP YD | VPTH ALTV

- 5) As the aircraft nears the VNV Target Altitude, the flight director transitions to VNV Target Altitude Capture Mode, indicated by the magenta 'ALTV' annunciation flashing for up to 5 seconds.

GPS | ← AP YD | ALTV ALT

The magenta 'ALT' annunciation flashes for up to 5 seconds upon reaching 50 feet from the VNV Target Altitude; the autopilot transitions to Altitude Hold Mode and levels the aircraft at the vertical waypoint.

GPS | ← AP YD | ALT

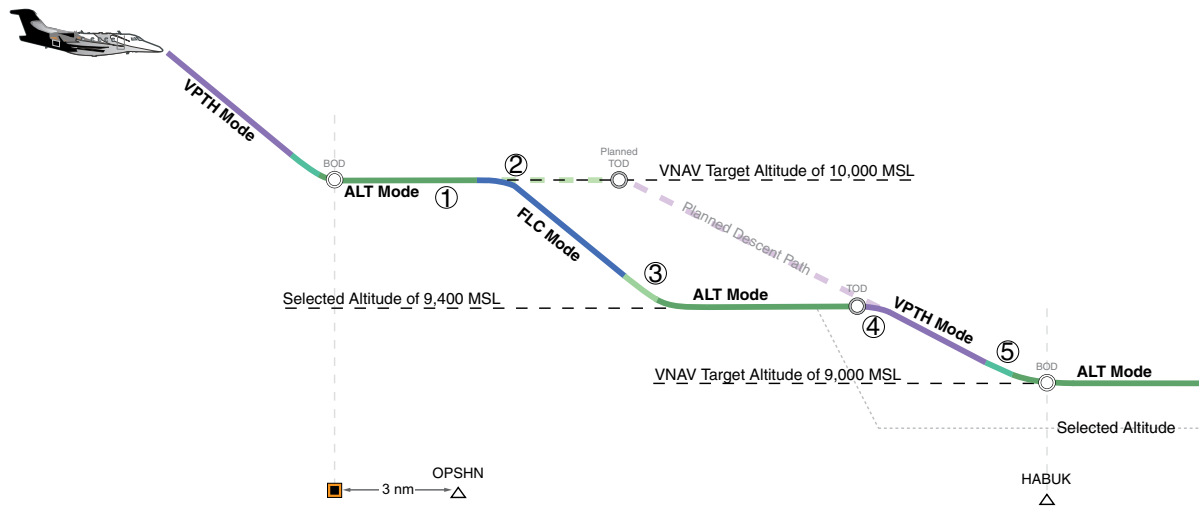

**Figure 7-40 Non-path Descent**

**APPROACH**

**Flying an ILS approach:**

- 1) Transition from GPS Navigation Mode to Heading Select Mode.
  - a) Select the Runway 35L ILS approach for KCOS and select 'VECTORS' for the transition. Load and activate the approach into the flight plan.
  - b) Use the **HDG SEL** Knob to set the Selected Heading after getting vectors from ATC.
  - c) Press the **HDG** Key. The autopilot turns the aircraft to the desired heading.
  - d) Use Heading Select Mode to comply with ATC vectors as requested.



- 2) Arm LOC Approach and Glideslope modes.
  - a) Ensure the appropriate localizer frequency is tuned.
  - b) Press the **APR** Key when cleared for approach to arm Approach and Glideslope modes. 'LOC' and 'GS' appear in white as armed mode annunciations.



- c) The navigation source automatically switches to LOC. After this switch occurs, the localizer signal can be captured and the flight director determines when to begin the turn to intercept the final approach course. The flight director now provides guidance to the missed approach point.
- 3) There are two options available at this point, as the autopilot flies the ILS approach:
  - Push the **AP DISC** Switch at the decision height and land the aircraft.
  - Use the **GA** Switch to execute a missed approach.

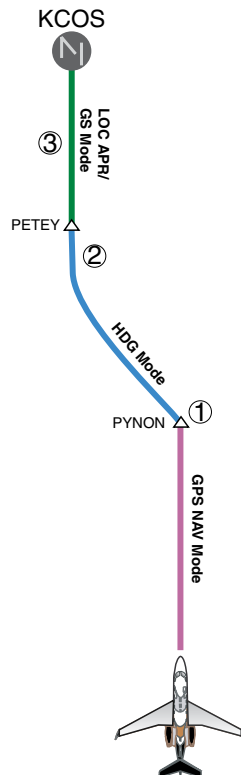

Figure 7-41 ILS Approach to KCOS



**Flying a RNAV GPS approach with vertical guidance:**

- 1) Arm flight director modes for a RNAV GPS approach with vertical guidance:
  - a) Make sure the navigation source is set to GPS (use **CDI** Softkey to change navigation source).
  - b) Select the Runway 35R LPV approach for KCOS. Load and activate approach into the flight plan.
- 2) Press the **APR** Key once clearance for approach has been received. GPS Approach Mode is activated and Glidepath Mode is armed.



- 3) Once the glidepath is captured, Glidepath Mode becomes active. The flight director now provides guidance to the missed approach point.



- 4) There are two options available at this point, as the autopilot flies the approach:
  - Push the **AP DISC** Switch at the decision height and land the aircraft.
  - Use the **GA** Switch to execute a missed approach.

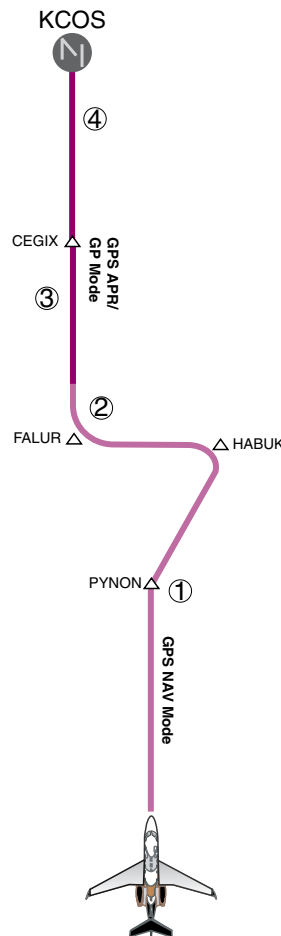

**Figure 7-42 LPV Approach to KCOS**

**GO AROUND/MISSED APPROACH**

**NOTE:** As a result of calculations performed by the system while flying the holding pattern, the display may re-size automatically and the aircraft may not precisely track the holding pattern as depicted on the PFD and MFD.

**Flying a missed approach:**

- 1) Push the **GA** Switch at the decision height and apply go around power to execute a missed approach. The flight director Command Bars establish a nose-up climb to follow. If flying an ILS or LOC approach, the CDI also switches to GPS as the navigation source.

Note that when the **GA** Switch is pushed, the missed approach is activated and the autopilot disconnects, indicated by the 'AP' annunciation flashing yellow for 5 seconds.



- 2) Start the climb to the prescribed altitude in the published Missed Approach Procedure (in this case, 10,000 ft).
  - a) Press the **AP** Key to re-engage the autopilot.
  - b) Press the **NAV** Key to have the autopilot fly to the hold.



- 3) Use the **ALT SEL** Knob to set a Selected Altitude to hold.

To hold the current airspeed during the climb, press the **FLC** Key.



As the aircraft nears the Selected Altitude, the flight director transitions to Selected Altitude Capture Mode, indicated by the green 'ALTS' annunciation flashing for up to 5 seconds.



The green 'ALT' annunciation flashes for up to 5 seconds upon reaching 50 feet from the Selected Altitude; the autopilot transitions to Altitude Hold Mode and levels the aircraft.



- 4) The autopilot flies the holding pattern after the missed approach is activated. Annunciations are displayed in the Navigation Status Box, above the AFCS Status Box.



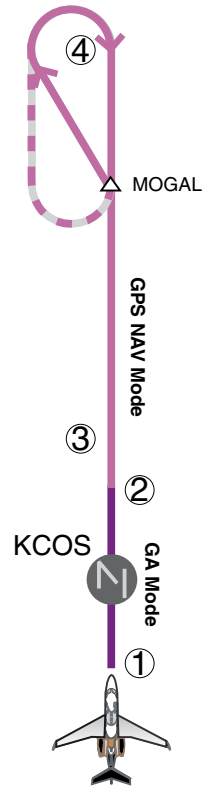

Figure 7-43 Go Around/Missed Approach

## 7.7 AFCS ANNUNCIATIONS AND ALERTS

### AFCS CAS MESSAGES

Crew Alerting System (CAS) messages related to the AFCS are listed in Table 7-6. CAS messages appear on the PFDs in the window to the right of the Altimeter (see Figure 7-44). Refer to the EAS Section for details.

CAS Message	Description
<b>AP FAIL</b>	Loss of AP function
<b>AUTO PTRIM FAIL</b>	Auto pitch trim failure; other pitch trim functions still available
<b>AP PITCH MISTRIM</b>	Airplane mistrimmed in pitch axis when AP is engaged
<b>AP ROLL MISTRIM</b>	Airplane mistrimmed in roll axis when AP is engaged
<b>YD FAIL</b>	Loss of yaw damper function
<b>YD MISTRIM</b>	Airplane mistrimmed in yaw axis when YD is engaged
<b>PTRIM NML FAIL</b>	Loss of normally-operating pitch trim actuator
<b>PTRIM BKP FAIL</b>	Loss of backup pitch trim actuator
<b>PTRIM SW1 FAIL</b>	Failure of pilot pitch trim switch
<b>PTRIM SW2 FAIL</b>	Failure of copilot pitch trim switch

Table 7-6 AFCS CAS Messages



Figure 7-44 CAS Display

**AFCS VOICE ALERTS**

The voice alerts listed in Table 7-7 relate to the AFCS; for a complete list of voice alerts, see Appendix A.

Voice Alert	Description
"Autopilot"	Warning – Autopilot is disengaged Single alert for manual AP disengagement Continuous alert for automatic AP disengagement; cancelled with <b>AP DISC</b> Switch
"Flight Director"	Single warning – Flight director has reverted to a default mode
"Trim, Trim, Trim"	Continuous advisory (stops after 6 seconds) – <b>MEPT</b> Switch malfunction

**Table 7-7 AFCS Voice Alerts**

**OVERSPEED PROTECTION**

While Pitch Hold, Vertical Speed, Flight Level Change, Vertical Path Tracking, or an altitude capture mode is active, airspeed is monitored by the flight director and pitch commands are limited for overspeed protection. Overspeed protection is provided in situations where the flight director cannot acquire and maintain the mode reference for the selected vertical mode without exceeding the certified maximum autopilot airspeed.

When an autopilot overspeed condition occurs, a flashing yellow 'MAXSPD' annunciation appears above the Airspeed Indicator and the voice alert "High Speed" is generated. Engine power should be reduced and/or the pitch reference adjusted to slow the aircraft. The annunciation disappears when the overspeed condition is resolved.



**Figure 7-45 Overspeed Annunciation**

## SECTION 8 ADDITIONAL FEATURES



**NOTE:** *With the availability of SafeTaxi®, ChartView, or FliteCharts®, it may be necessary to carry another source of charts on-board the aircraft.*

Additional features of the system include the following:

- Synthetic Vision System (SVS)
- SafeTaxi® diagrams
- ChartView and FliteCharts® electronic charts
- AOPA or AC-U-KWIK Airport Directory
- Data Link Services
- Satellite telephone and SMS messaging services
- SiriusXM Satellite Radio entertainment
- Scheduler

The optional Synthetic Vision System (SVS) provides a three-dimensional forward view of terrain features on the PFD. SVS imagery shows the pilot's view of relevant features in relation to the aircraft attitude, as well as the flight path pertaining to the active flight plan.

SafeTaxi diagrams provide detailed taxiway, runway, and ramp information at more than 700 airports in the United States. By decreasing range on an airport that has a SafeTaxi diagram available, a close up view of the airport layout can be seen.

The FliteCharts and optional ChartView provide on-board electronic terminal procedures charts. Electronic charts offer the convenience of rapid access to essential information. Either ChartView or FliteCharts may be configured in the system, but not both.

The AOPA and AC-U-KWIK Airport Directories offer detailed information for a selected airport, such as available services, hours of operation, and lodging options.

Telephone and Data Link Services are optional subscription services offered through Garmin Flight Data Services and Iridium Satellite LLC. Voice and SMS messaging communications are through the Iridium Satellite Network. Data communications are through Iridium Data Services, or a wireless network (Wi-Fi) when the aircraft is on the ground. Incorporated in this feature set is a System Data Logging function which records aircraft system parameters specified by the aircraft manufacturer. This data is then uploaded to Garmin Flight Data Services through one of the data communications options.

The optional SiriusXM Satellite Radio entertainment audio feature of the GDL 69A Data Link Receiver handles more than 170 channels of music, news, and sports. SiriusXM Satellite Radio offers more entertainment choices and longer range coverage than commercial broadcast stations.

The Scheduler feature can be used to enter and display short term or long term reminder messages such as Switch fuel tanks, Phase 1 inspection, or Altimeter/Transponder Check in the Messages Window on the PFD.

## 8.1 SYNTHETIC VISION SYSTEM (SVS)



**WARNING:** Use appropriate primary systems for navigation, and for terrain, obstacle, and traffic avoidance. SVS is intended as an aid to situational awareness only and may not provide either the accuracy or reliability upon which to solely base decisions and/or plan maneuvers to avoid terrain, obstacles, or traffic.

The optional Synthetic Vision System (SVS) is a visual enhancement to the Prodigy® Flight Deck 300. SVS depicts a forward-looking attitude display of the topography immediately in front of the aircraft. The field of view is 30 degrees to the left and 35 degrees to the right. SVS information is shown on the Primary Flight Display (PFD), or on the Multifunction Display (MFD) in Reversionary Mode (Figure 8-132). The depicted imagery is derived from the aircraft attitude, heading, GPS three-dimensional position, and a nine arc-second database of terrain, obstacles, and other relevant features. The terrain data resolution of nine arc-seconds, meaning that the terrain elevation contours are stored in squares measuring nine arc-seconds on each side, is required for the operation of SVS. Loss of any of the required data, including temporary loss of the GPS signal, will cause SVS to be disabled until the required data is restored.

The SVS terrain display shows land contours (colors are consistent with those of the topographical map display), large water features, towers, and other obstacles over 200' AGL that are included in the obstacle database. Cultural features on the ground such as roads, highways, railroad tracks, cities, and state boundaries are not displayed even if those features are found on the MFD map. The terrain display also includes a north–south east–west grid with lines oriented with true north and spaced at one arc-minute intervals to assist in orientation relative to the terrain.

The Terrain Awareness and Warning System (TAWS) is integrated within SVS to provide visual and auditory alerts to indicate the presence of terrain and obstacle threats relevant to the projected flight path. Terrain alerts are displayed in red and yellow shading on the PFD.

The terrain display is intended for situational awareness only. It may not provide the accuracy or fidelity on which to base decisions and plan maneuvers to avoid terrain or obstacles. Navigation must not be predicated solely upon the use of the TAWS terrain or obstacle data displayed by the SVS.

The following SVS enhancements appear on the PFD:

- Pathways
- Flight Path Marker
- Horizon Heading Marks
- Traffic Display
- Airport Signs
- Runway Display
- Terrain Alerting
- Obstacle Alerting



Figure 8-1 Synthetic Vision Imagery

## SVS OPERATION

SVS is activated from the PFD using the softkeys located along the bottom edge of the display. Pressing the softkeys turns the related function on or off. When SVS is enabled, the pitch scale increments are reduced to 10 degrees up and 7.5 degrees down.

SVS functions are displayed on three levels of softkeys. The **PFD** Softkey leads into the PFD function Softkeys, including synthetic vision. Pressing the **SYN VIS** Softkey displays the SVS feature softkeys. The softkeys are labeled **PATHWAY**, **SYN TERR**, **HRZN HDG**, and **APTSIGNS**. The **BACK** Softkey returns to the previous level of softkeys. Synthetic Terrain must be active before any other SVS feature may be activated.

**HRZN HDG**, **APTSIGNS**, and **PATHWAY** Softkeys are only available when the **SYN TERR** Softkey is activated (gray with black characters). After activating the **SYN TERR** Softkey, the **HRZN HDG**, **APTSIGNS**, and **PATHWAY** softkeys may be activated in any combination to display desired features. When system power is cycled, the last selected state (on or off) of the **SYN TERR**, **HRZN HDG**, **APTSIGNS**, and **PATHWAY** softkeys is remembered by the system.

- **PATHWAY** Softkey enables display of rectangular boxes that represent course guidance.
- **SYN TERR** Softkey enables synthetic terrain depiction.
- **HRZN HDG** Softkey enables horizon heading marks and digits.
- **APTSIGNS** Softkey enables airport signposts.



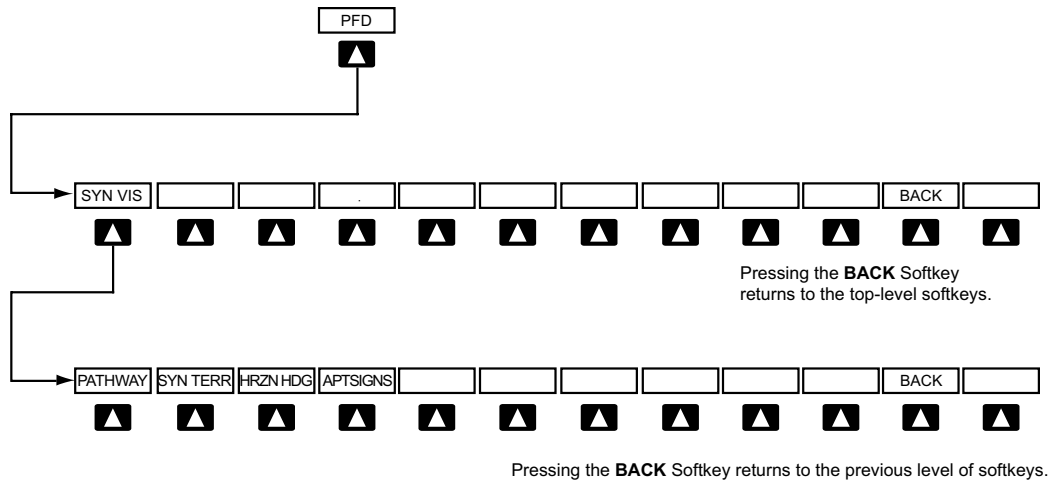

Figure 8-2 SVS Softkeys

**Activating and deactivating SVS:**

- 1) Press the **PFD** Softkey.
- 2) Press the **SYN VIS** Softkey.
- 3) Press the **SYN TERR** Softkey. The SVS display will cycle on or off with the **SYN TERR** Softkey.

**Activating and deactivating Pathways:**

- 1) Press the **PFD** Softkey.
- 2) Press the **SYN VIS** Softkey.
- 3) Press the **PATHWAY** Softkey. The Pathway feature will cycle on or off with the **PATHWAY** Softkey.

**Activating and deactivating Horizon Headings:**

- 1) Press the **PFD** Softkey.
- 2) Press the **SYN VIS** Softkey.
- 3) Press the **HRZN HDG** Softkey. The horizon heading display will cycle on or off with the **HRZN HDG** Softkey.

**Activating and deactivating Airport Signs:**

- 1) Press the **PFD** Softkey.
- 2) Press the **SYN VIS** Softkey.
- 3) Press the **APTSIGNS** Softkey. Display of airport signs will cycle on or off with the **APTSIGNS** Softkey.

SVS FEATURES



Figure 8-3 SVS on the Primary Flight Display

**NOTE:** Pathways and terrain features are not a substitute for standard course and altitude deviation information provided by the altimeter, CDI, and VDI.

**NOTE:** Pathways are not available when the cross-pointer (X-Pointer) flight director format is selected.

PATHWAYS

Pathways provide a three-dimensional perspective view of the selected route of flight shown as colored rectangular boxes representing the horizontal and vertical flight path of the active flight plan. The box size represents 700 feet wide by 200 feet tall during enroute, oceanic, and terminal flight phases. During an approach, the box width is 700 feet or one half full scale deviation on the HSI, whichever is less. The height is 200 feet or one half full scale deviation on the VDI, whichever is less. The altitude at which the pathway boxes are displayed is determined by the selected altitude during climb, cruise, and when the active leg is the final approach course prior to intercepting the glidepath/glide slope. During a descent (except while on the approach glidepath/glide slope), the pathway boxes are displayed at the selected altitude, or the VNAV altitude programmed for the active leg in the flight plan, or the published altitude constraint, whichever is higher (Figure 8-4). Just prior to intercepting the glidepath/glide slope, the pathway boxes are displayed on the glidepath/glide slope, or the selected altitude, whichever is lower.

The color of the rectangular boxes may be magenta, green, or white depending on the route of flight and navigation source selected. The active GPS or GPS overlay flight plan leg is represented by magenta boxes that correspond to the Magenta CDI. A localizer course is represented by green boxes that correspond to a green CDI. An inactive leg of an active flight plan is represented by white boxes corresponding to a white line drawn on the Inset map or MFD map indicating an inactive leg.

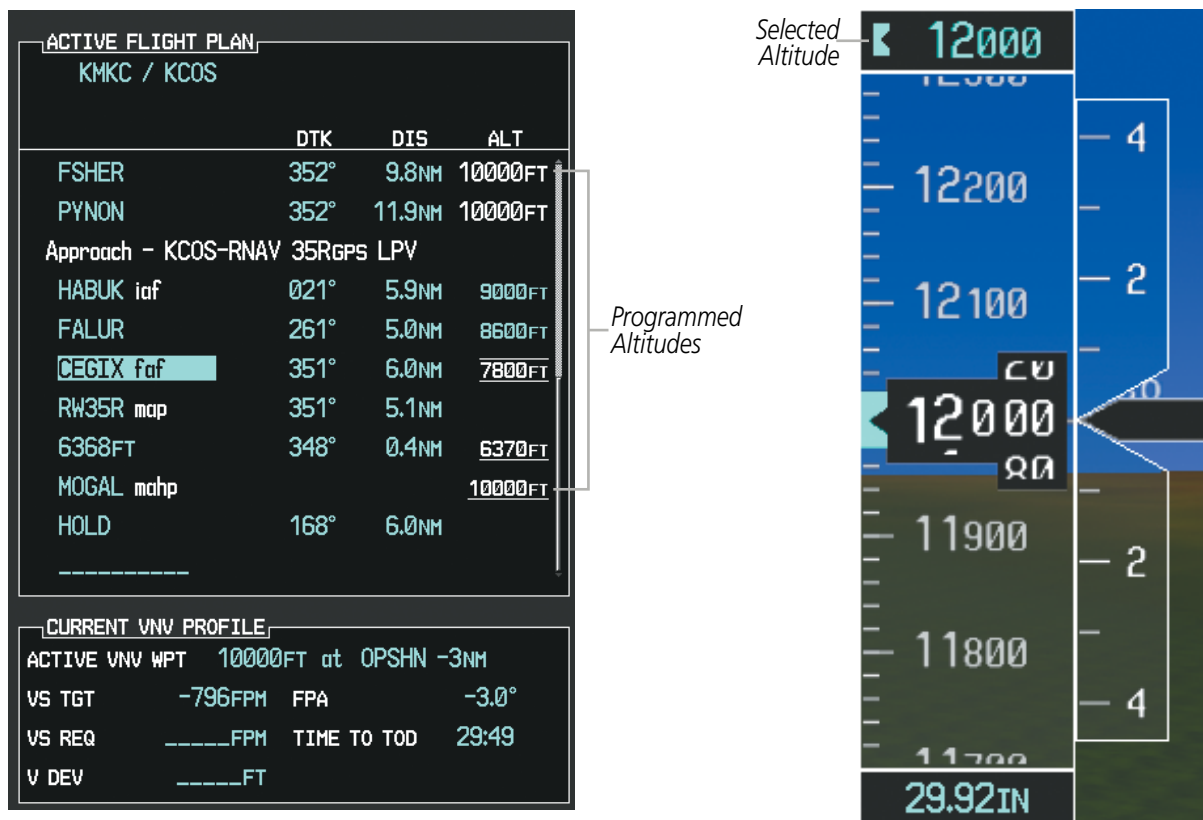

Figure 8-4 Programmed and Selected Altitude

Pathways provide supplemental glidepath/glideslope information on an active ILS, LPV, LNAV/VNAV, and some LNAV approaches. Pathways are intended as an aid to situational awareness and should not be used independent of the CDI, VDI, glide path indicator, and glide slope indicator. They are removed from the display when the selected navigation information is not available. Pathways are not displayed beyond the active leg when leg sequencing is suspended and are not displayed on any portion of the flight plan leg that would lead to intercepting a leg in the wrong direction. Pathways are also automatically removed from the display in the event a Resolution Advisory (RA) is issued by the optional TCAS II system. Pathways may then be re-displayed by pressing the **PATHWAY** Softkey.

### DEPARTURE AND ENROUTE

Prior to intercepting an active flight plan leg, pathways are displayed as a series of boxes with pointers at each corner that point in the direction of the active waypoint. Pathways are not displayed for the first leg of the flight plan if that segment is a Heading-to-Altitude leg. The first segment displaying pathways is the first active GPS leg or active leg with a GPS overlay. If this leg of the flight plan route is outside the SVS field of view, pathways will not be visible until the aircraft has turned toward this leg. While approaching the center of the active leg and prescribed altitude, the number of pathway boxes decreases to a minimum of four.

Climb profiles cannot be displayed due to the variables associated with aircraft performance. Flight plan legs requiring a climb are indicated by pathways displayed at a level above the aircraft at the altitude selected or programmed.

**DESCENT AND APPROACH**

Pathways are shown descending only for a programmed descent (Figures 8-5, 8-6). When the flight plan includes programmed descent segments, pathways are displayed along the descent path provided that the selected altitude is lower than the programmed altitude.

When an approach providing vertical guidance is activated, Pathways are shown level at the selected altitude up to the point along the final approach course where the altitude intercepts the extended vertical descent path, glidepath, or glideslope. From the vertical path descent, glidepath, or glideslope intercept point, the pathways are shown inbound to the Missed Approach Point (MAP) along the published lateral and vertical descent path, or at the selected altitude, whichever is lower.

During an ILS approach, the initial approach segment is displayed in magenta at the segment altitudes if GPS is selected as the navigation source on the CDI. When switching to localizer inbound with LOC selected as the navigation source on the CDI, pathways are displayed in green along the localizer and glide slope.

VOR, LOC BC, and ADF approach segments that are approved to be flown using GPS are displayed in magenta boxes. Segments that are flown using other than GPS or ILS, such as heading legs or VOR final approach courses are not displayed.

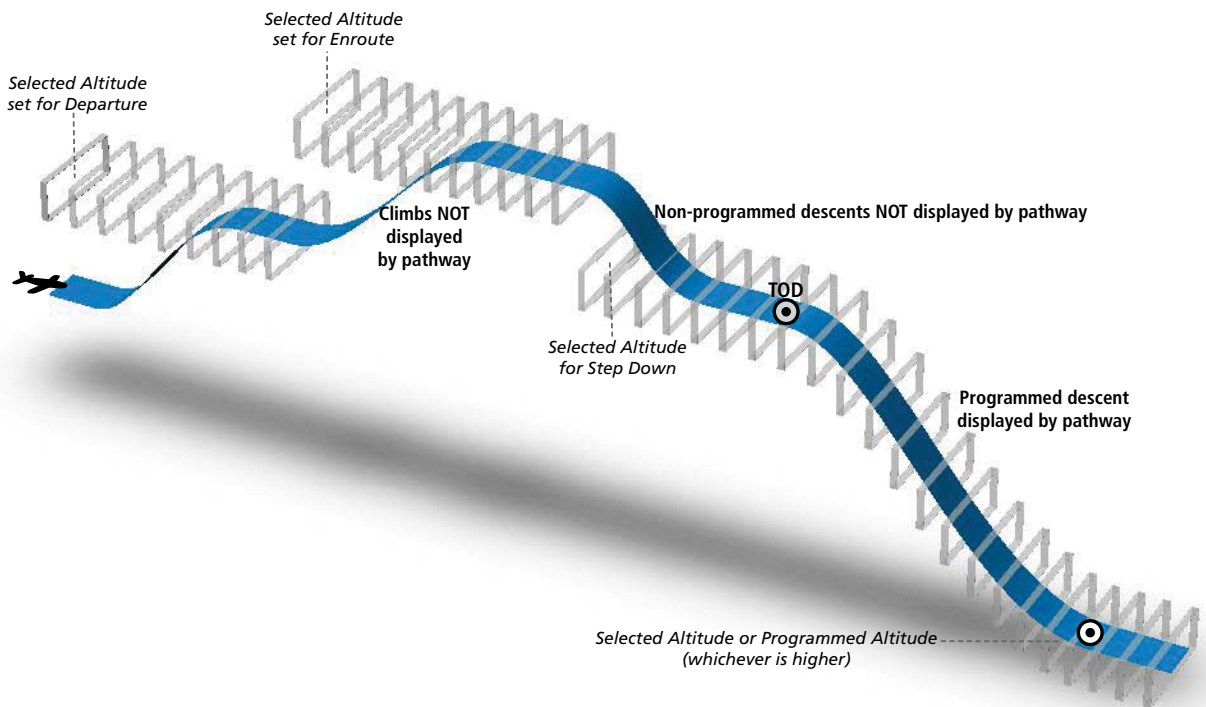

Figure 8-5 SVS Pathways, Enroute and Descent

**MISSED APPROACH**

Upon activating the missed approach, pathways lead to the Missed Approach Holding Point (MAHP) and are displayed as a level path at the published altitude for the MAHP, or the selected altitude, whichever is the highest. If the initial missed approach leg is a Course-to-Altitude (CA) leg, the pathways boxes will be displayed level at the altitude published for the MAHP. If the initial missed approach leg is defined by a course using other than GPS, pathways are not displayed for that segment. In this case, the pathways displayed for the next leg may be outside the field of view and will be visible when the aircraft has turned in the direction of that leg.

Pathways are displayed along each segment including the path required to track course reversals that are part of a procedure, such as holding patterns. Pathways boxes will not indicate a turn to a MAHP unless a defined geographical waypoint exists between the MAP and MAHP.

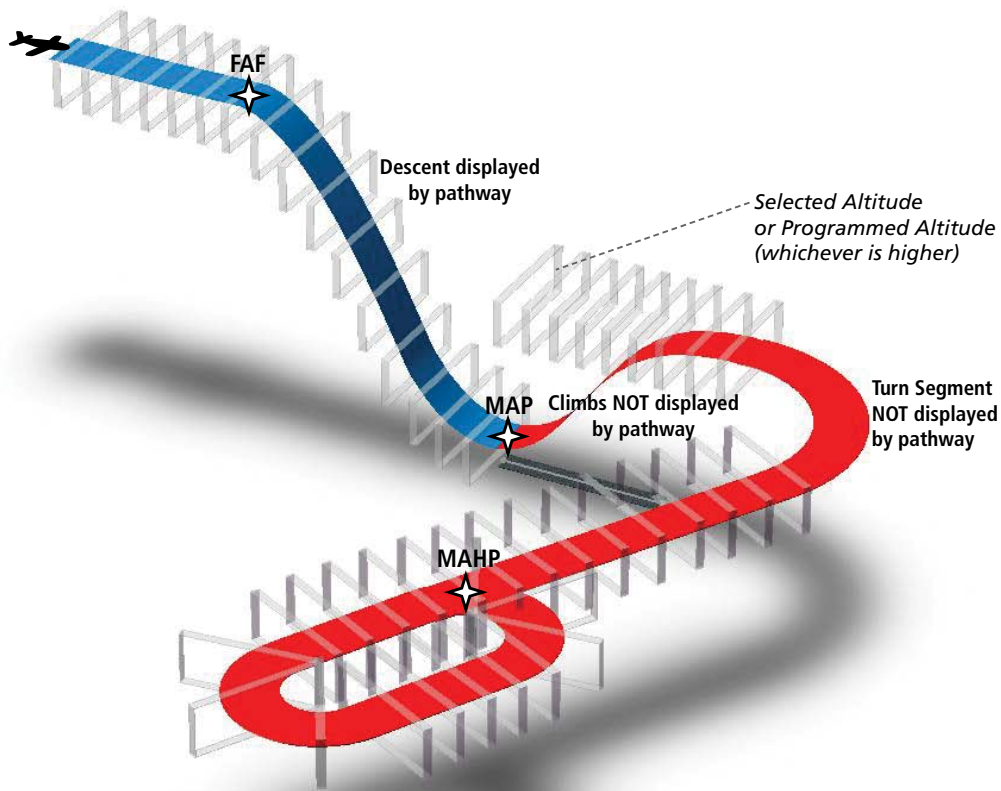

Figure 8-6 SVS Pathways, Approach, Missed Approach, and Holding



**FLIGHT PATH MARKER**

The Flight Path Marker (FPM), also known as a Velocity Vector, is displayed on the PFD at groundspeeds above 30 knots. The FPM depicts the approximate projected path of the aircraft accounting for wind speed and direction relative to the three-dimensional terrain display.

The FPM is always available when the Synthetic Terrain feature is in operation. The FPM represents the direction of the flight path as it relates to the terrain and obstacles on the display, while the airplane symbol represents the aircraft heading.

The FPM works in conjunction with the Pathways feature to assist the pilot in maintaining desired altitudes and direction when navigating a flight plan. When on course and altitude the FPM is aligned inside the pathway boxes as shown (Figure 8-7).

The FPM may also be used to identify a possible conflict with the aircraft flight path and distant terrain or obstacles. Displayed terrain or obstacles in the aircraft's flight path extending above the FPM could indicate a potential conflict, even before an alert is issued by TAWS. However, decisions regarding terrain and/or obstacle avoidance should not be made using only the FPM.



**Figure 8-7 Flight Path Marker and Pathways**

**ZERO PITCH LINE**

The Zero Pitch Line is drawn completely across the display and represents the aircraft attitude with respect to the horizon. It may not align with the terrain horizon, particularly when the terrain is mountainous or when the aircraft is flown at high altitudes.

## HORIZON HEADING

The Horizon Heading is synchronized with the HSI and shows approximately 60 degrees of compass heading in 30-degree increments on the Zero Pitch Line. Horizon Heading tick marks and digits appearing on the zero pitch line are not visible behind either the airspeed or altitude display. Horizon Heading is used for general heading awareness, and is activated and deactivated by pressing the **HRZN HDG** Softkey.

## TRAFFIC



**WARNING:** Intruder aircraft at or below 500 ft. AGL may not appear on the SVS display or may appear as a partial symbol.

Traffic symbols are displayed in their approximate locations as determined by the related traffic systems. Traffic symbols are displayed in three dimensions, appearing larger as they are getting closer, and smaller when they are further away. Traffic within 250 feet laterally of the aircraft will not be displayed on the SVS display. Traffic symbols and coloring are consistent with that used for traffic displayed in the Inset map or MFD traffic page. If the traffic altitude is unknown, the traffic will not be displayed on the SVS display. For more details refer to the traffic system discussion in the Hazard Avoidance section.

## AIRPORT SIGNS

Airport Signs provide a visual representation of airport location and identification on the synthetic terrain display. When activated, the signs appear on the display when the aircraft is approximately 15 nm from an airport and disappear at approximately 4.5 nm. Airport signs are shown without the identifier until the aircraft is approximately eight nautical miles from the airport. Airport signs are activated and deactivated by pressing the **APTSIGNS** Softkey.



Figure 8-8 Airport Signs

RUNWAYS



**WARNING:** Do not use SVS runway depiction as the sole means for determining the proximity of the aircraft to the runway or for maintaining the proper approach path angle during landing.



**NOTE:** Not all airports have runways with endpoint data in the database, therefore, these runways are not displayed.

Runway data provides improved awareness of runway location with respect to the surrounding terrain. All runway thresholds are depicted at their respective elevations as defined in the database. In some situations, where threshold elevations differ significantly, crossing runways may appear to be layered. As runways are displayed, those within 45 degrees of the aircraft heading are displayed in white. Other runways will be gray in color. When an approach for a specific runway is active, that runway will appear brighter and be outlined with a white box, regardless of the runway orientation as related to aircraft heading. As the aircraft gets closer to the runway, more detail such as runway numbers and centerlines will be displayed.



Figure 8-9 Airport Runways



### TAWS ALERTING

Terrain alerting on the synthetic terrain display is triggered by Forward-looking Terrain Avoidance (FLTA) alerts. In addition to the yellow terrain shading for a caution alert and the red shading for a warning alert, TAWS-B alerting will also indicate potential impact points. These potential impact points correspond to red and/or yellow X symbols on the PFD Inset Map (as shown in Figure 8-10), MFD map displays, and TAWS-B Page on the MFD. Terrain shading will only occur on the synthetic terrain display on the PFD and TAWS-A Page on the MFD when using the optional TAWS-A system. No terrain shading nor potential impact points will be displayed on the PFD inset map or the MFD map display. For more detailed information regarding TAWS, refer to the Hazard Avoidance Section.

In some instances, a terrain or obstacle alert may be issued with no conflict shading displayed on the synthetic terrain. In these cases, the conflict is outside the SVS field of view to the left or right of the aircraft.



Figure 8-10 Terrain Alert

Obstacles are represented on the synthetic terrain display by standard two-dimensional tower symbols found on the Inset map and MFD maps and charts. Obstacle symbols appear in the perspective view with relative height above terrain and distance from the aircraft. When employing a TAWS-B system, unlike the Inset map and MFD moving map display, obstacles on the synthetic terrain display do not change colors to warn of potential conflict with the aircraft's flight path until the obstacle is associated with an actual FLTA alert. Obstacles greater than 1000 feet below the aircraft altitude are not shown. Obstacles are shown behind the airspeed and altitude displays.

As with terrain alerting on a TAWS-A system, obstacle alerting is limited to the synthetic terrain display on the PFD and the TAWS-A Page on the MFD.



Figure 8-11 Obstacle

## FIELD OF VIEW

The PFD field of view can be represented on the MFD Navigation Map Page. Two dashed lines forming a V-shape in front of the aircraft symbol on the map, represent the forward viewing area shown on the PFD.

### Configuring field of view:

- 1) While viewing the Navigation Map Page, press the **MENU** Key to display the PAGE MENU.
- 2) Turn the large **FMS** Knob to highlight Map Setup and press the **ENT** Key.



Navigation Map Page OPTIONS Menu      Map Setup Menu, Map Group, Field of View Option

Figure 8-12 Option Menus

- 3) Turn the **FMS** Knob to select the Map Group and press the **ENT** Key.
- 4) Turn the large **FMS** Knob to scroll through the Map Group options to FIELD OF VIEW.
- 5) Turn the small **FMS** Knob to select On or Off.
- 6) Press the **FMS** Knob to return to the Navigation Map Page.

The following figure compares the PFD forward looking depiction with the MFD plan view and FIELD OF VIEW turned on.



SVS View on the PFD      Field of View on the MFD

Figure 8-13 PFD and MFD Field of View Comparison

## 8.2 SAFETAXI

The SafeTaxi feature gives greater map detail when viewing airports at close range. The maximum map ranges for enhanced detail are pilot configurable. When viewing at ranges close enough to show the airport detail, the map reveals taxiways with identifying letters/numbers, airport Hot Spots, and airport landmarks including ramps, buildings, control towers, and other prominent features. Resolution is greater at lower map ranges. When the MFD display is within the SafeTaxi ranges, the airplane symbol on the airport provides enhanced position awareness.

Designated Hot Spots are recognized at airports with many intersecting taxiways and runways, and/or complex ramp areas. Airport Hot Spots are outlined to caution pilots of areas on an airport surface where positional awareness confusion or runway incursions happen most often. Hot Spots are defined with a magenta circle or outline around the region of possible confusion.

Any map page that displays the navigation view can also show the SafeTaxi airport layout within the maximum configured range. The following is a list of pages where the SafeTaxi feature can be seen:

- Navigation Map Page
- Inset Map (PFD)
- Weather Datalink Page
- Airport Information Page
- Intersection Information Page
- NDB Information Page
- VOR Information Page
- User Waypoint Information Page
- Trip Planning Page
- Nearest Pages
- Active and Stored Flight Plan Pages

During ground operations the aircraft's position is displayed in reference to taxiways, runways, and airport features. In the example shown, the aircraft is on taxiway Bravo inside the High Alert Intersection boundary on KSFO airport. Airport Hot Spots are outlined in magenta. When panning over the airport, features such as runway holding lines and taxiways are shown at the cursor.



Figure 8-14 SafeTaxi Depiction on the Navigation Map Page

The **DCLTR** Softkey (declutter) label advances to DCLTR-1, DCLTR -2, and DCLTR-3 each time the softkey is selected for easy recognition of decluttering level. Selecting the **DCLTR** Softkey removes the taxiway markings and airport feature labels. Selecting the **DCLTR-1** Softkey removes VOR station ID, the VOR symbol, and intersection names if within the airport plan view. Selecting the **DCLTR-2** Softkey removes the airport runway layout, unless the airport in view is part of an active route structure. Selecting the **DCLTR-3** Softkey cycles back to the original map detail. Refer to Map Declutter Levels in the Flight Management Section.



**Configuring SafeTaxi range:**

- 1) While viewing the Navigation Map Page, press the **MENU** Key to display the PAGE MENU.
- 2) Turn the large **FMS** Knob to highlight the Map Setup Menu Option and press the **ENT** Key.

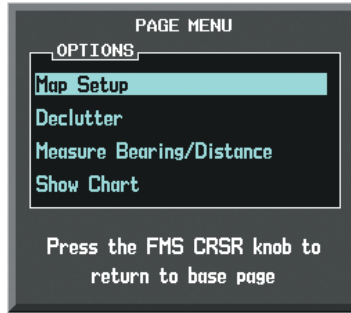

Figure 8-15 Navigation Map PAGE MENU, Map Setup Option

- 3) Turn the **FMS** Knob to select the Aviation Group and press the **ENT** Key.
- 4) Turn the large **FMS** Knob to scroll through the Aviation Group options to SAFETAXI.
- 5) Turn the small **FMS** Knob to display the range of distances.
- 6) Turn either **FMS** Knob to select the desired distance for maximum SafeTaxi display range.
- 7) Press the **ENT** Key to complete the selection.
- 8) Press the **FMS** Knob to return to the Navigation Map Page.

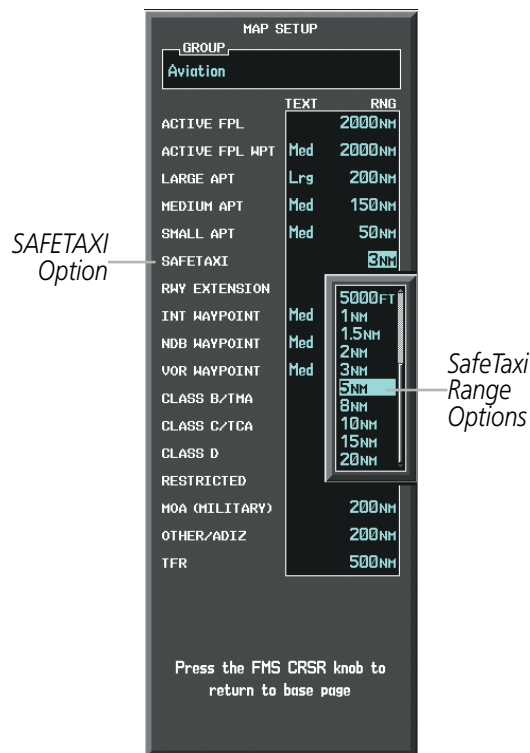

Figure 8-16 MAP SETUP Menu, Aviation Group, SAFETAXI Range Options

## SAFETAXI DATABASE CYCLE NUMBER AND REVISION

SafeTaxi database is revised every 56 days. SafeTaxi is always available for use after the expiration date. When turning on the system, the Power-up Page indicates whether the databases are current, out of date, or not available.

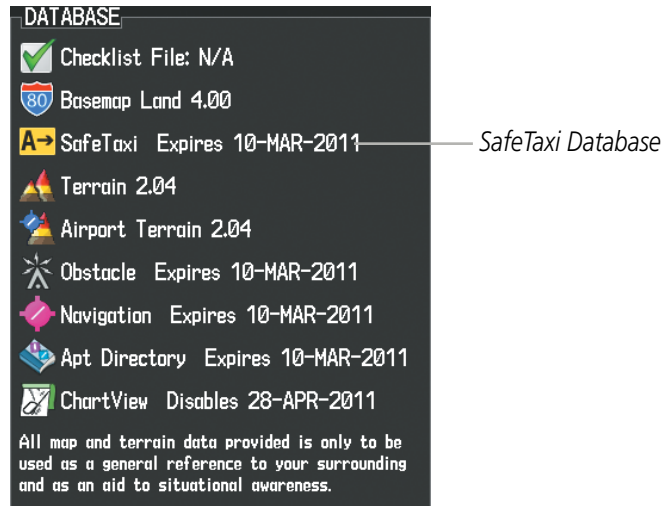

Figure 8-17 Power-up Page, SafeTaxi Database

Power-up Page Display	Definition
<b>A→ SafeTaxi Expires 10-MAR-2011</b>	Normal operation. SafeTaxi database is valid and within current cycle.
<b>A→ SafeTaxi Expires 10-MAR-2011</b>	SafeTaxi database has expired.
<b>A→ SafeTaxi: N/A</b>	Database card contains no SafeTaxi data.

Table 8-1 SafeTaxi Annunciation Definitions

The SafeTaxi Region, Version, Cycle, Effective date and Expires date of the database cycle can also be found on the AUX - System Status page, as seen in Figure 8-18.

Select the **MF D1 DB** Softkey to place the cursor in the DATABASE window. Scroll through the listed information by turning the **FMS** Knob or pressing the **ENT** Key until the SafeTaxi database information is shown.

The SafeTaxi database cycle number shown in Figure 8-18, 11S3, is deciphered as follows:

- 11 – Indicates the year 2011
- S – Indicates the data is for SafeTaxi
- 3 – Indicates the third issue of the SafeTaxi database for the year

The SafeTaxi EFFECTIVE date 07–MAY–11 is the beginning date for the current database cycle. SafeTaxi EXPIRES date 02–JUL–11 is the revision date for the next database cycle.

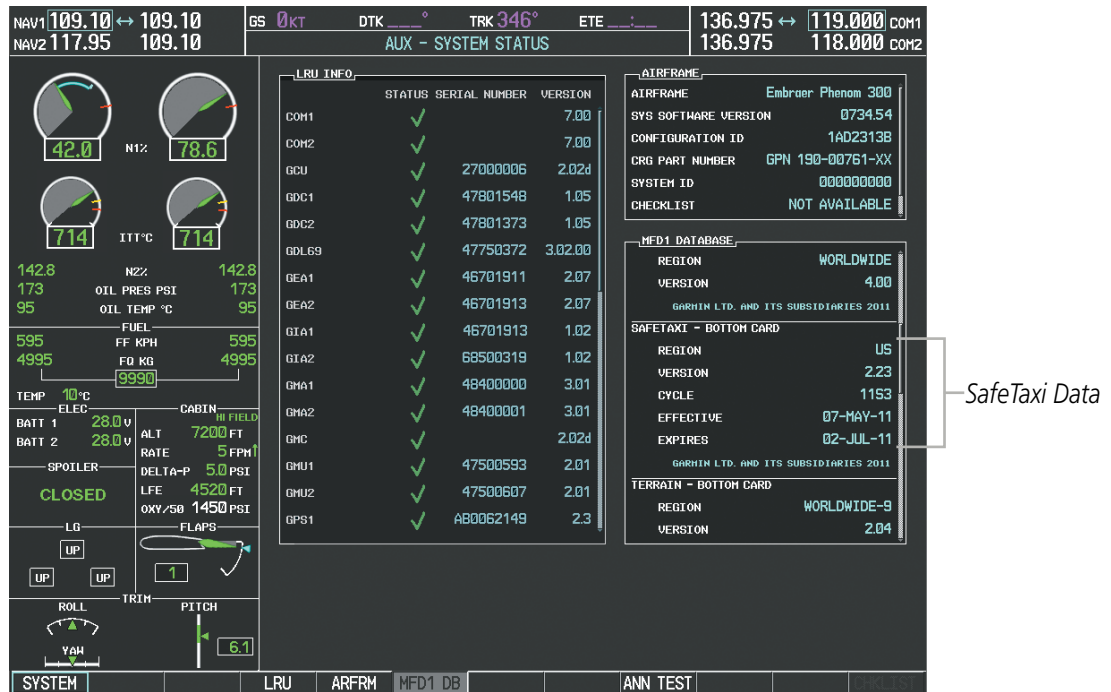

**Figure 8-18 AUX – System Status Page, SafeTaxi Current Information**

SafeTaxi information appears in blue and yellow text. The EFFECTIVE date appears in blue when data is current and in yellow when the current date is before the effective date. The EXPIRES date appears in blue when data is current and in yellow when expired (Figures 8-18 and 8-19). NOT AVAILABLE appears in blue in the REGION field if SafeTaxi data is not available on the database card (Figure 8-19). An expired SafeTaxi database is not disabled and will continue to function indefinitely.

Select the **MFD1 DB** Softkey a second time. The softkey label will change to **PFD1 DB**. The DATABASE window will now be displaying database information for PFD1. As before, scroll through the listed information by turning the **FMS** Knob or pressing the **ENT** Key until the SafeTaxi database information is shown.

Select the **PFD1 DB** Softkey. The softkey label will change to **PFD2 DB**. The DATABASE window will now display database information for PFD2. Again, scroll through the listed information by turning the **FMS** Knob or pressing the **ENT** Key until the SafeTaxi database information is shown.

Refer to Updating Garmin Databases in Appendix B for instructions on revising the SafeTaxi database.



Figure 8-19 illustrates possible SafeTaxi database conditions that may appear on the AUX - System Status Page. The EFFECTIVE date is the beginning date for this database cycle. If the present date is before the effective date, the EFFECTIVE date appears in yellow and the EXPIRES date appears in blue. The EXPIRES date is the revision date for the next database cycle. NOT AVAILABLE indicates that SafeTaxi is not available on the database card or no database card is inserted.

MFD1 DATABASE	MFD1 DATABASE	MFD1 DATABASE
REGION WORLDWIDE	REGION WORLDWIDE	REGION WORLDWIDE
VERSION 4.00	VERSION 4.00	VERSION 4.00
GARMIN LTD. AND ITS SUBSIDIARIES 2010	GARMIN LTD. AND ITS SUBSIDIARIES 2010	GARMIN LTD. AND ITS SUBSIDIARIES 2010
SAFETAXI - BOTTOM CARD	SAFETAXI - BOTTOM CARD	SAFETAXI - UNKNOWN
REGION US	REGION US	REGION NOT AVAILABLE
VERSION 2.34	VERSION 2.34	VERSION
CYCLE 11S1	CYCLE 11S1	CYCLE
EFFECTIVE 13-JAN-11	EFFECTIVE 13-JAN-11	EFFECTIVE -- -- --
EXPIRES 10-MAR-11	EXPIRES 10-MAR-11	EXPIRES -- -- --
GARMIN LTD. AND ITS SUBSIDIARIES 2010	GARMIN LTD. AND ITS SUBSIDIARIES 2010	
TERRAIN - BOTTOM CARD	TERRAIN - BOTTOM CARD	TERRAIN - BOTTOM CARD
REGION WORLDWIDE-9	REGION WORLDWIDE-9	REGION WORLDWIDE-9
VERSION 2.04	VERSION 2.04	VERSION 2.04

Current Date is before Effective Date

SafeTaxi Database has Expired

SafeTaxi Database Not Installed

Figure 8-19 AUX – System Status Page, SafeTaxi Database Status

### 8.3 CHARTVIEW

ChartView resembles the paper version of Jeppesen terminal procedures charts. The charts are displayed in full color with high-resolution. The MFD depiction shows the aircraft position on the moving map in the plan view of approach charts and on airport diagrams. Airport Hot Spots are outlined in magenta.

The ChartView database subscription is available from Jeppesen, Inc. Available data includes:

- Arrivals (STAR)
- Departure Procedures (DP)
- Approaches
- Airport Diagrams
- NOTAMs

#### CHARTVIEW SOFTKEYS

ChartView functions are displayed on three levels of softkeys. While on the Navigation Map Page, Nearest Airports Page, or Flight Plan Page, selecting the **SHW CHRT** Softkey displays the available terminal chart and advances to the chart selection level of softkeys: **CHRT OPT**, **CHRT**, **INFO**, **DP**, **STAR**, **APR**, **WX**, **NOTAM**, and **GO BACK**. The chart selection softkeys shown below appear on the Airport Information Page.

Selecting the **GO BACK** Softkey reverts to the top level softkeys and previous page.

Selecting the **CHRT OPT** Softkey advances to the next level of softkeys: **ALL**, **HEADER**, **PLAN**, **PROFILE**, **MINIMUMS**, **FIT WDTN**, **FULL SCN**, and **BACK**.

While viewing the **CHRT OPT** Softkeys, after 45 seconds of softkey inactivity, the system reverts to the chart selection softkeys.

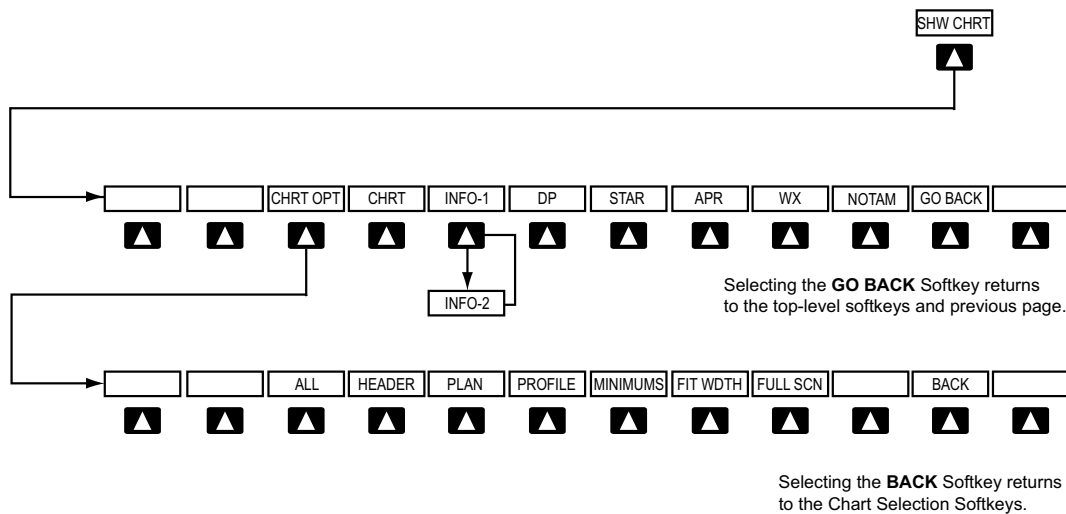

Figure 8-20 ChartView SHW CHRT, Chart Selection, and Chart Option Softkeys

## TERMINAL PROCEDURES CHARTS

### Selecting Terminal Procedures Charts:

While viewing the Navigation Map Page, Nearest Airport Page, or Flight Plan Page, select the **SHW CHRT** Softkey.

Or:

- 1) Press the **MENU** Key to display the PAGE MENU.
- 2) Turn the large **FMS** Knob to scroll through the OPTIONS Menu to Show Chart.
- 3) Press the **ENT** Key to display the chart.

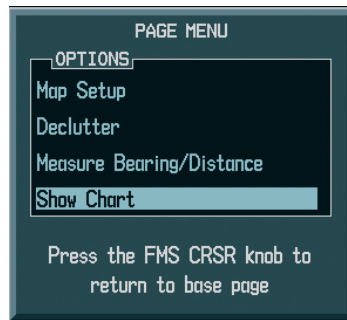

Navigation Map Page OPTIONS Menu



Waypoint Airport Information Page OPTIONS Menu

Figure 8-21 Option Menus

When no terminal procedure chart is available for the nearest airport or the selected airport, the banner **CHART NOT AVAILABLE** appears on the screen. The **CHART NOT AVAILABLE** banner does not refer to the Jeppesen subscription, but rather the availability of a particular airport chart selection or procedure for a selected airport.



Figure 8-22 Chart Not Available Banner

If there is a problem in rendering the data (such as a data error or a failure of an individual chart), the banner **UNABLE TO DISPLAY CHART** is then displayed.



Figure 8-23 Unable To Display Chart Banner

When a chart is not available by selecting the **SHW CHRT** Softkey or selecting a Page Menu Option, charts may be obtained for other airports from the WPT Pages or Flight Plan Pages.

If a chart is available for the destination airport, or the airport selected in the active flight plan, the chart appears on the screen. When no flight plan is active, or when not flying to a direct-to destination, selecting the **SHW CHRT** Softkey displays the chart for the nearest airport, if available.

The chart shown is the one associated with the WPT – Airport Information page. Usually this is the airport runway diagram. Where no runway diagram exists, but Take Off Minimums or Alternate Minimums are available, that page appears. If Airport Information pages are unavailable, the Approach Chart for the airport is shown.

**Selecting a chart:**

- 1) While viewing the Navigation Map Page, Flight Plan Page, or Nearest Airports Page, select the **SHW CHRT** Softkey. The airport diagram or approach chart is displayed on the Airport Information Page.
- 2) Press the **FMS** Knob to activate the cursor.
- 3) Turn the large **FMS** Knob to select either the Airport Identifier Box or the Approach Box. (Select the **APR** Softkey if the Approach Box is not currently shown).
- 4) Turn the small and large **FMS** Knob to enter the desired airport identifier.
- 5) Press the **ENT** Key to complete the airport selection.
- 6) Turn the large **FMS** Knob to select the Approach Box.
- 7) Turn the small **FMS** Knob to show the approach chart selection choices.
- 8) Turn either **FMS** Knob to scroll through the available charts.
- 9) Press the **ENT** Key to complete the chart selection.

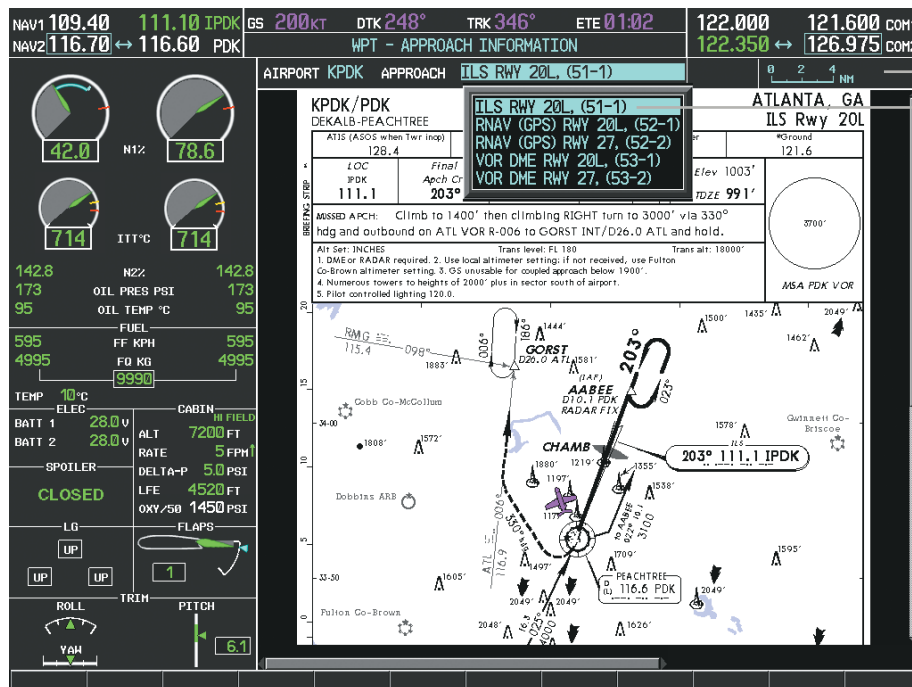

Chart Scale  
Select Desired  
Approach Chart  
from Menu

Scroll Through  
Entire Chart  
With the  
Joystick

Figure 8-24 Approach Information Page, Chart Selection

While the APPROACH Box is selected using the **FMS** Knob, the softkeys are blank. Once the desired chart is selected, the chart scale can be changed and the chart page can be scrolled using the **Joystick**. Pressing the **Joystick** centers the chart on the screen.

The aircraft symbol is shown on the chart only if the chart is to scale and the aircraft position is within the boundaries of the chart. The aircraft symbol is not displayed when the Aircraft Not Shown Icon appears (Figure 8-28). If the Chart Scale Box displays a banner NOT TO SCALE, the aircraft symbol is not shown. The Aircraft Not Shown Icon may appear at certain times, even if the chart is displayed to scale.

Selecting the **CHRT** Softkey switches between the ChartView diagram and the associated map in the WPT page group. In the example shown, the **CHRT** Softkey switches between the DeKalb Peachtree (KPKD) Airport Diagram and the navigation map on the WPT – Airport Information page.

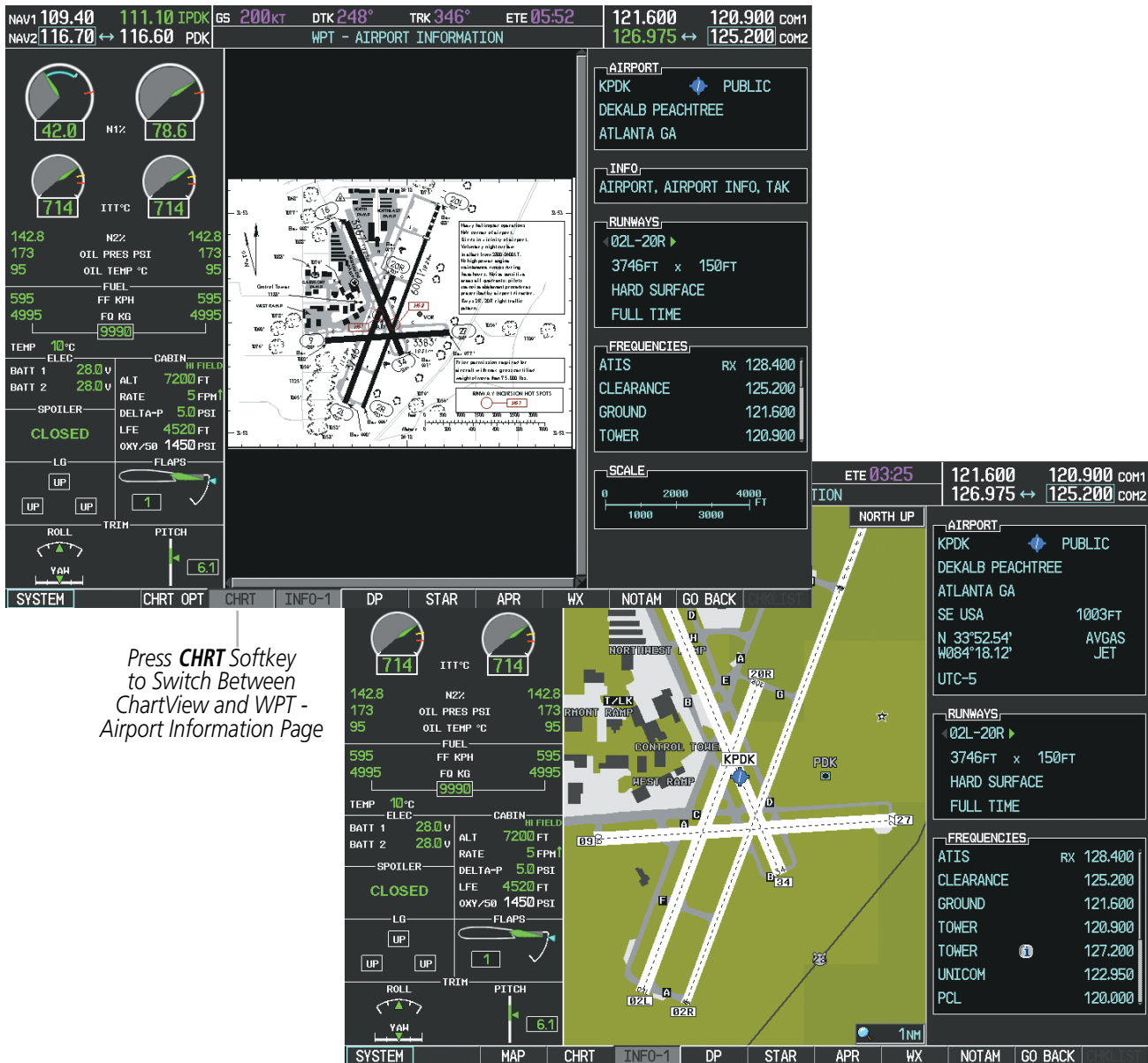

Figure 8-25 CHRT Softkey, Airport Information Page

Pressing the **INFO-1** or **INFO-2** Softkey returns to the airport diagram chart when the view is on a terminal procedure chart. If the displayed chart is the airport diagram chart, pressing the **INFO-1** or **INFO-2** Softkey returns to the Airport Information Page.

The aircraft position is shown in magenta on the ChartView diagrams when the location of the aircraft is within the chart boundaries. In the example shown, the aircraft is turning onto Taxiway Bravo on the Charlotte, NC (KCLT) airport.

Another source for additional airport information is from the INFO Box above the chart for certain airports. This information source is not related to the **INFO-1** or **INFO-2** Softkey. When the INFO Box is selected using the **FMS** Knob, the softkeys are blank. The Charlotte, NC airport has five additional charts offering information; the Airport Diagram, Take-off Minimums, Class B Airspace, Airline Parking Gate Coordinates, and Airline Parking Gate Location. (The numbers in parentheses after the chart name are Jeppesen designators.)



Figure 8-26 Airport Information Page, INFO View, Full Screen Width



In the example shown in Figure 8-26, the Class B Chart is selected. Pressing the **ENT** Key displays the Charlotte Class B Airspace Chart (Figure 8-27).

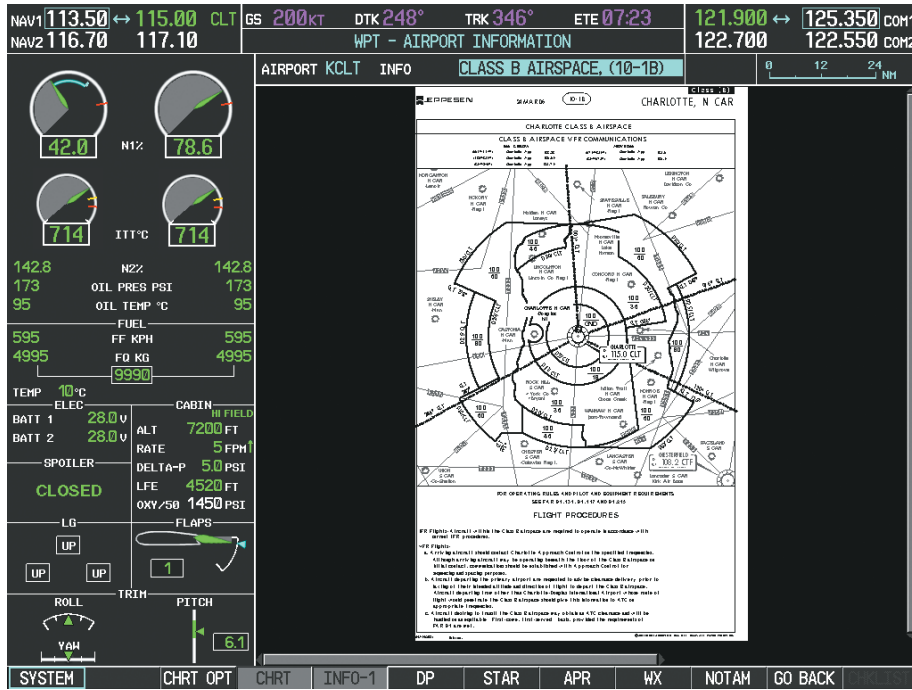

Figure 8-27 Airport Information Page, Class B Chart Selected from INFO View

Selecting the **DP** Softkey displays the Departure Procedure Chart if available.

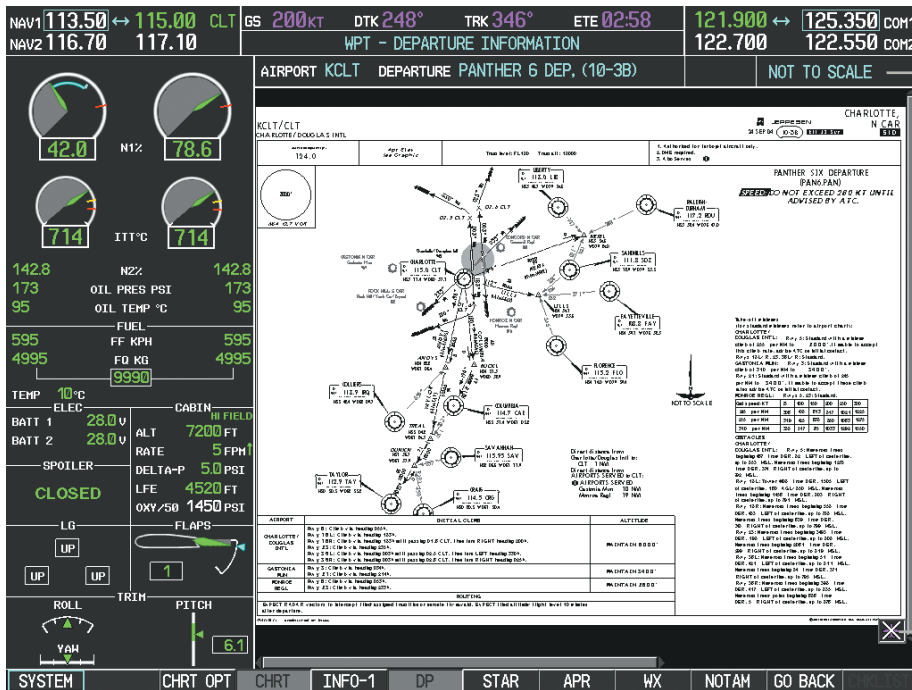

Figure 8-28 Departure Information Page

Selecting the **STAR** Softkey displays the Standard Terminal Arrival Chart if available.

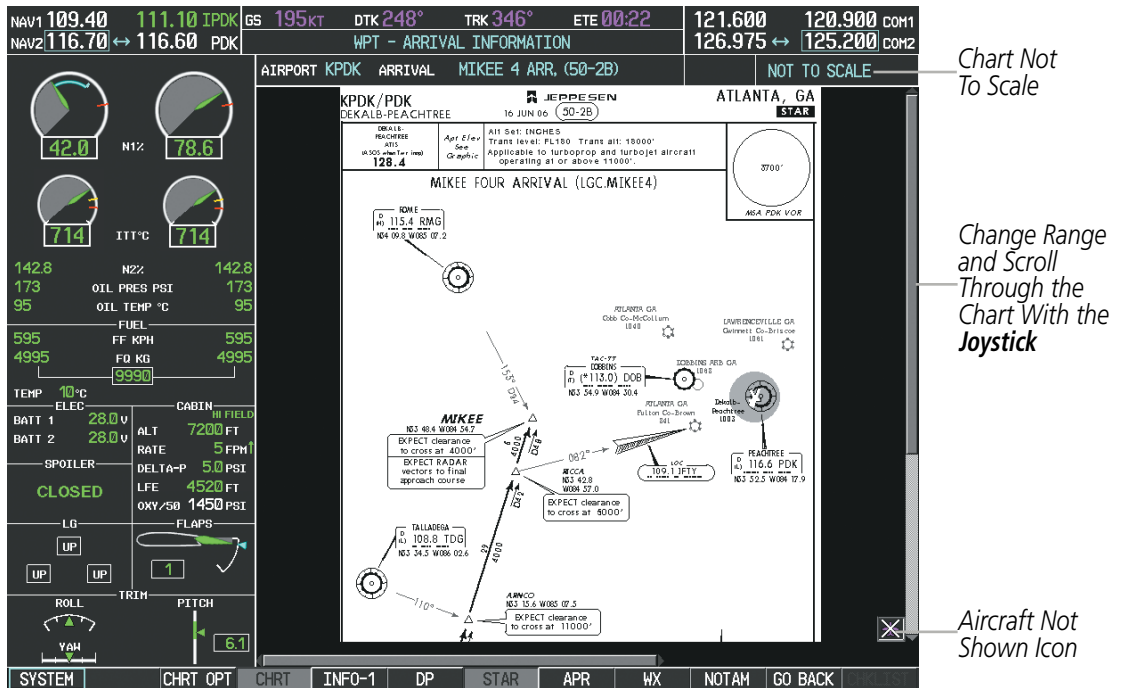

Figure 8-29 Arrival Information Page

Selecting the **APR** Softkey displays the approach chart for the airport if available.



Figure 8-30 Approach Information Page



Selecting the **WX** Softkey shows the airport weather frequency information, and includes weather data such as METAR and TAF from the XM Data Link Receiver, when available. Weather information is available only when an XM Data Link Receiver is installed and the SiriusXM Weather subscription is current.

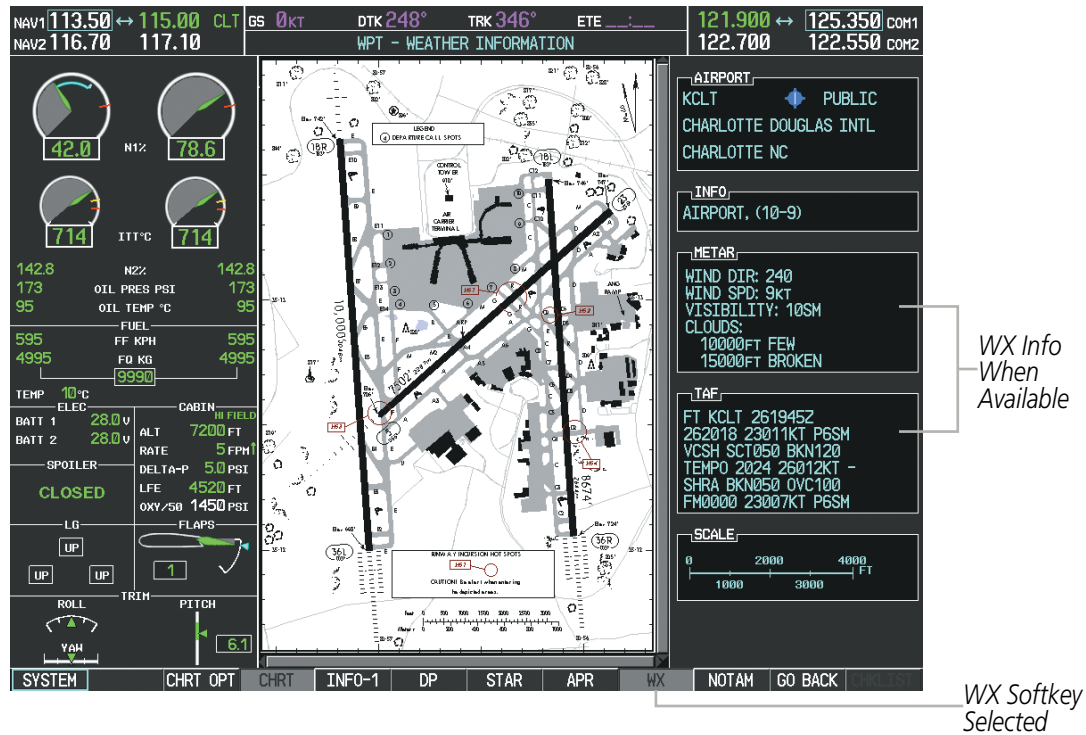

Figure 8-31 Weather Information Page



**NOTE:** A subdued softkey label indicates the function is disabled.

Recent NOTAMS applicable to the current ChartView cycle are included in the ChartView database. Selecting the **NOTAM** Softkey shows the local NOTAM information for selected airports, when available. When NOTAMS are not available, the **NOTAM** Softkey label appears subdued and is disabled. The **NOTAM** Softkey may appear on the Airport Information Page and all of the chart page selections.

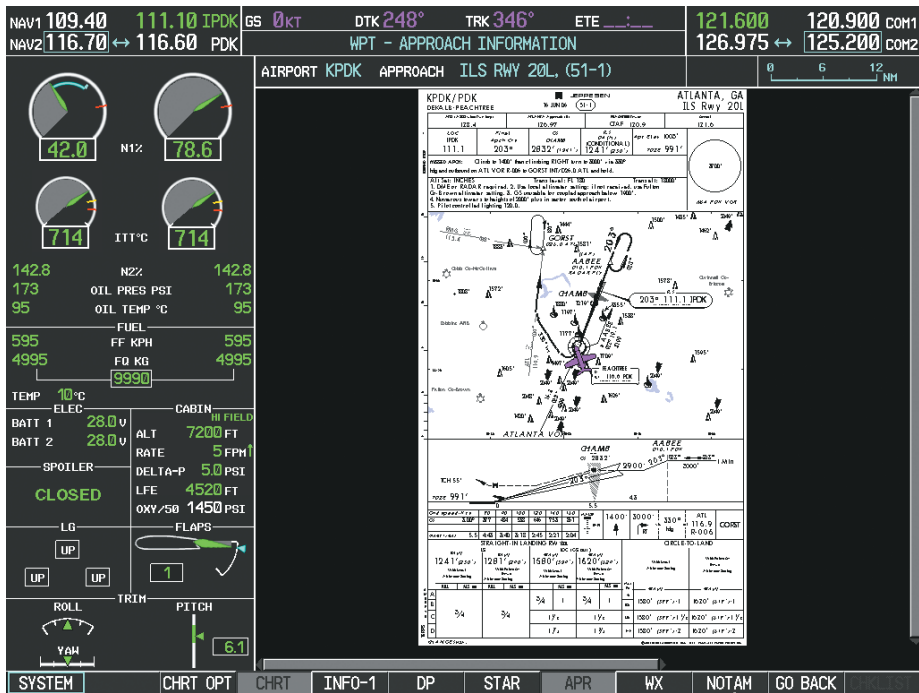

Figure 8-32 NOTAM Softkey Enabled

NOTAM Softkey Appears When NOTAMS are Available for Selected Airport

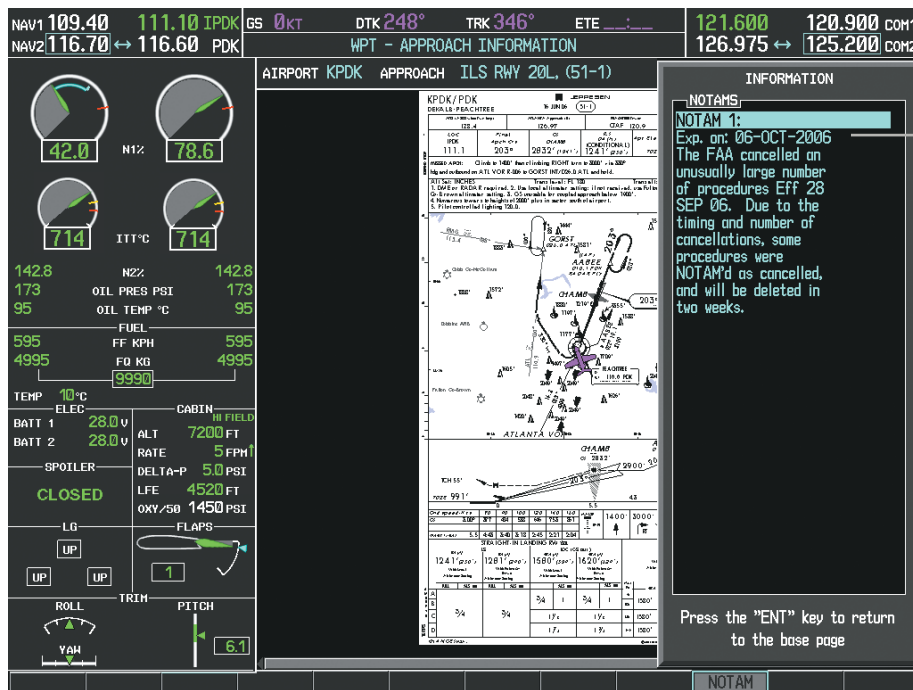

Figure 8-33 Airport Information Page, Local NOTAMS

Local NOTAM on Selected Airport

NOTAM Softkey Selected

Selecting the **NOTAM** Softkey again removes the NOTAMS information.

Selecting the **GO BACK** Softkey reverts to the previous page (Navigation Map Page, Nearest Pages, or Flight Plan Page).

### CHART OPTIONS

Selecting the **CHRT OPT** Softkey displays the next level of softkeys, the chart options level (Figure 8-20).  
 Selecting the **ALL** Softkey shows the entire approach chart on the screen.

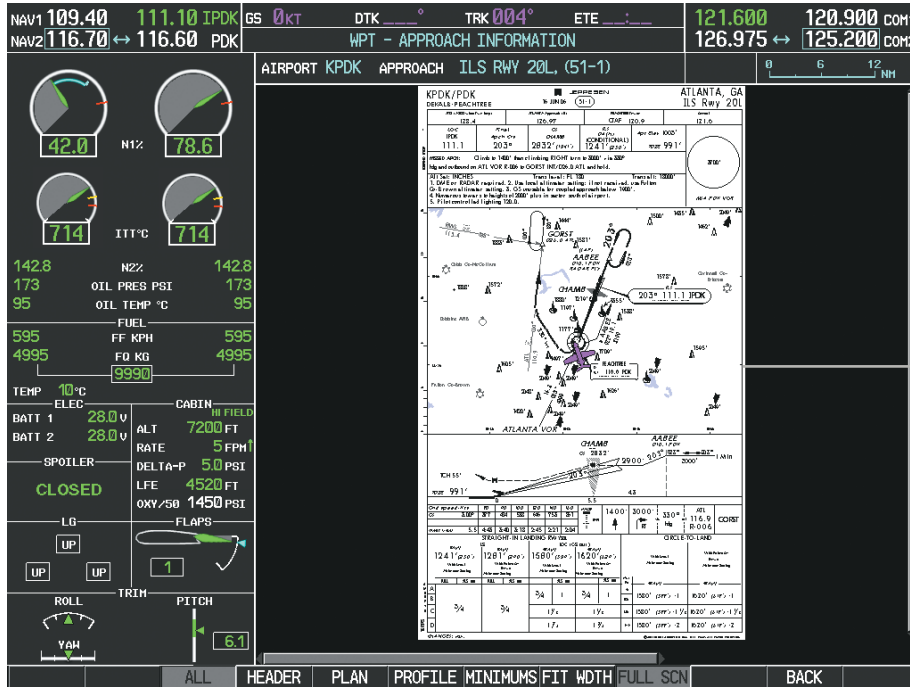

Entire Chart Shown

Figure 8-34 Approach Information Page, ALL View

Selecting the **HEADER** Softkey shows the header view (approach chart briefing strip) on the screen.

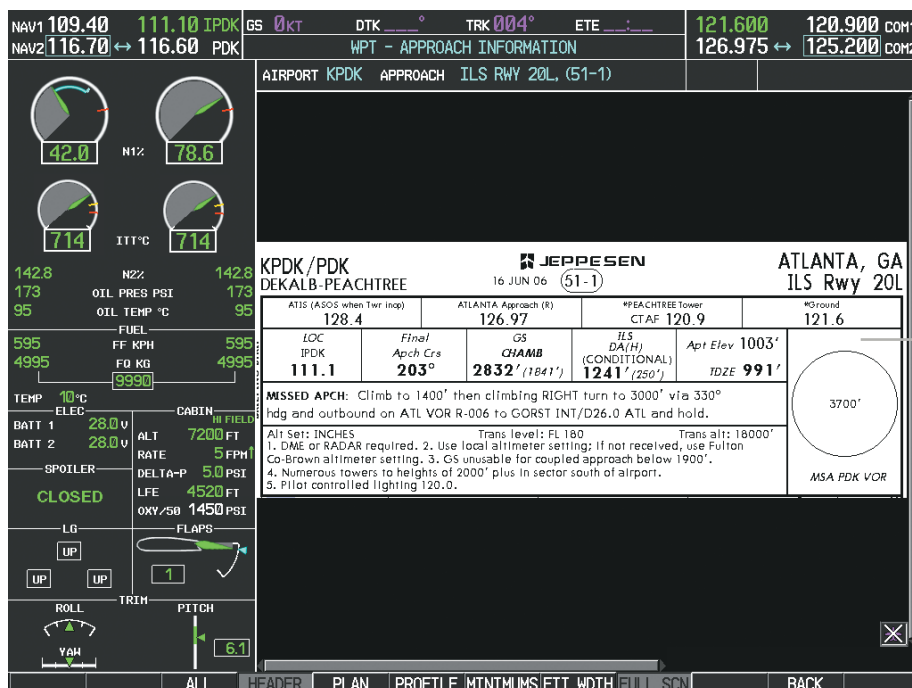

Approach Chart Briefing Strip

Figure 8-35 Approach Information Page, Header View

Selecting the **PLAN** Softkey shows the approach chart two dimensional plan view.

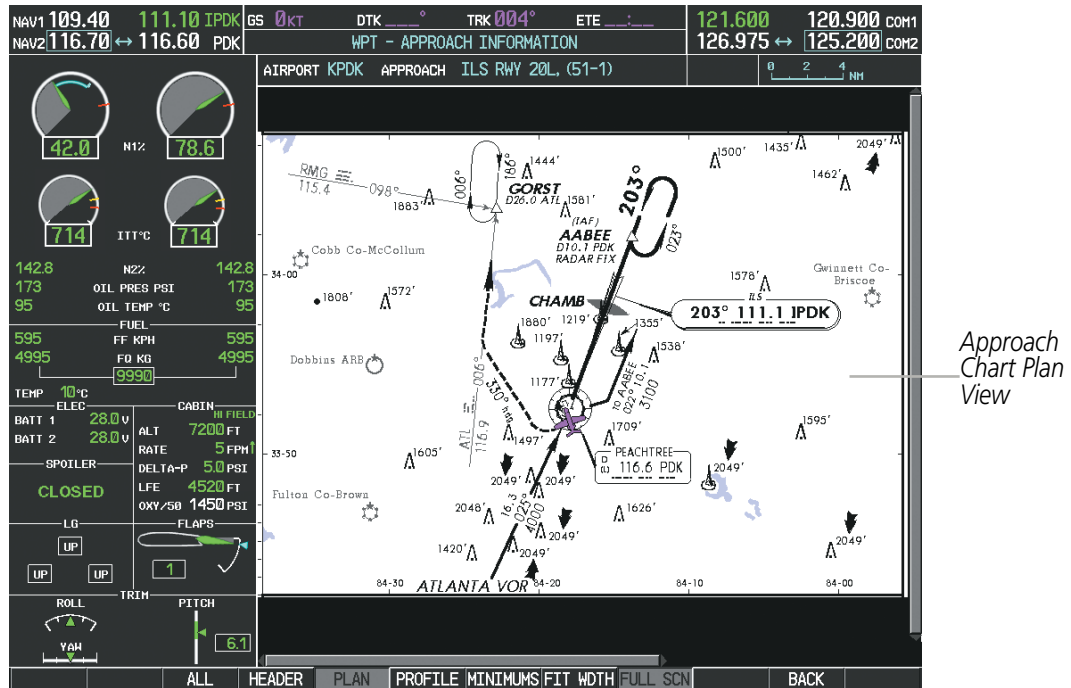

Figure 8-36 Approach Information Page, Plan View

Selecting the **PROFILE** Softkey displays the approach chart descent profile strip.

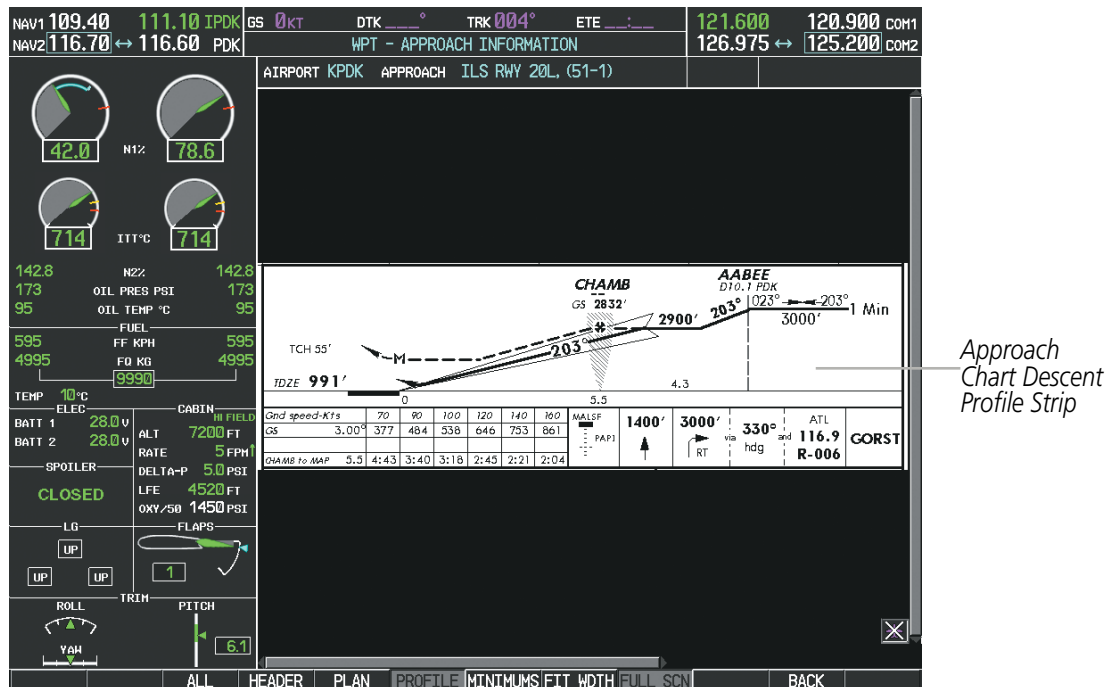
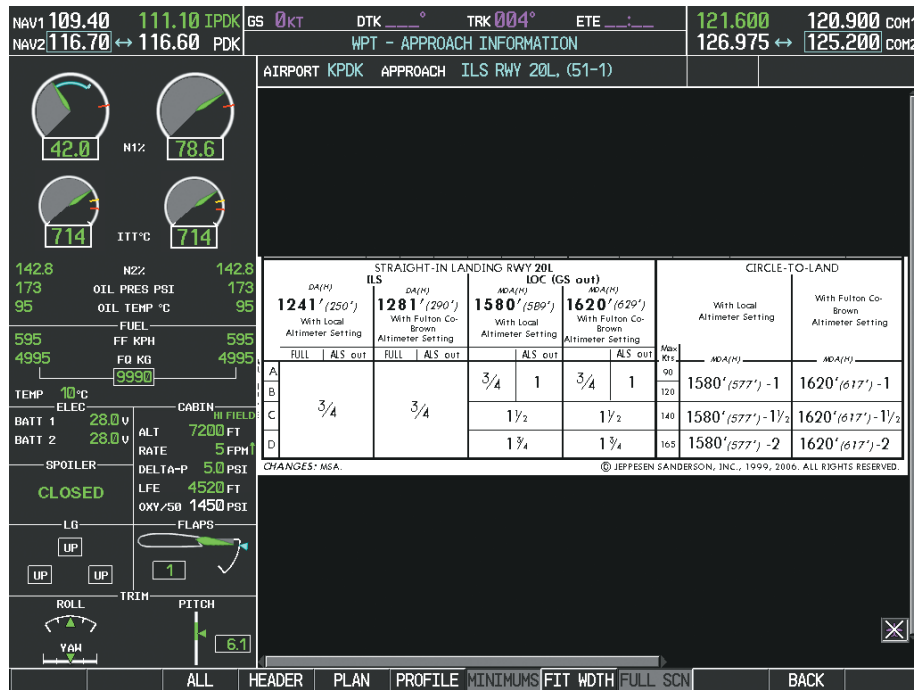

Figure 8-37 Approach Information Page, Profile View, Full Screen Width

Selecting the **MINIMUMS** Softkey displays the minimum descent altitude/visibility strip at the bottom of the approach chart.



*Minimum Descent Altitude/Visibility Strip*

Figure 8-38 Approach Information Page, Minimums View, Full Screen Width

If the chart scale has been adjusted to view a small area of the chart, selecting the **FIT WIDTH** Softkey changes the chart size to fit the available screen width.



Select **FIT WDTN** Softkey to Show Full Chart Width

Figure 8-39 Airport Information Page, FIT WDTN Softkey Selected



Selecting the **FULL SCN** Softkey alternates between removing and replacing the data window to the right.

**Selecting Additional Information:**

- 1) While viewing the Airport Taxi Diagram, select the **FULL SCN** Softkey to display the information windows (AIRPORT, INFO).
- 2) Press the **FMS** Knob to activate the cursor.
- 3) Turn the large **FMS** Knob to highlight the AIRPORT, INFO, RUNWAYS, or FREQUENCIES Box (INFO Box shown).
- 4) Turn the small **FMS** Knob to select the INFO Box choices. If multiple choices are available, scroll to the desired choice with the large **FMS** Knob and press the **ENT** Key to complete the selection.
- 5) Press the **FMS** Knob again to deactivate the cursor.

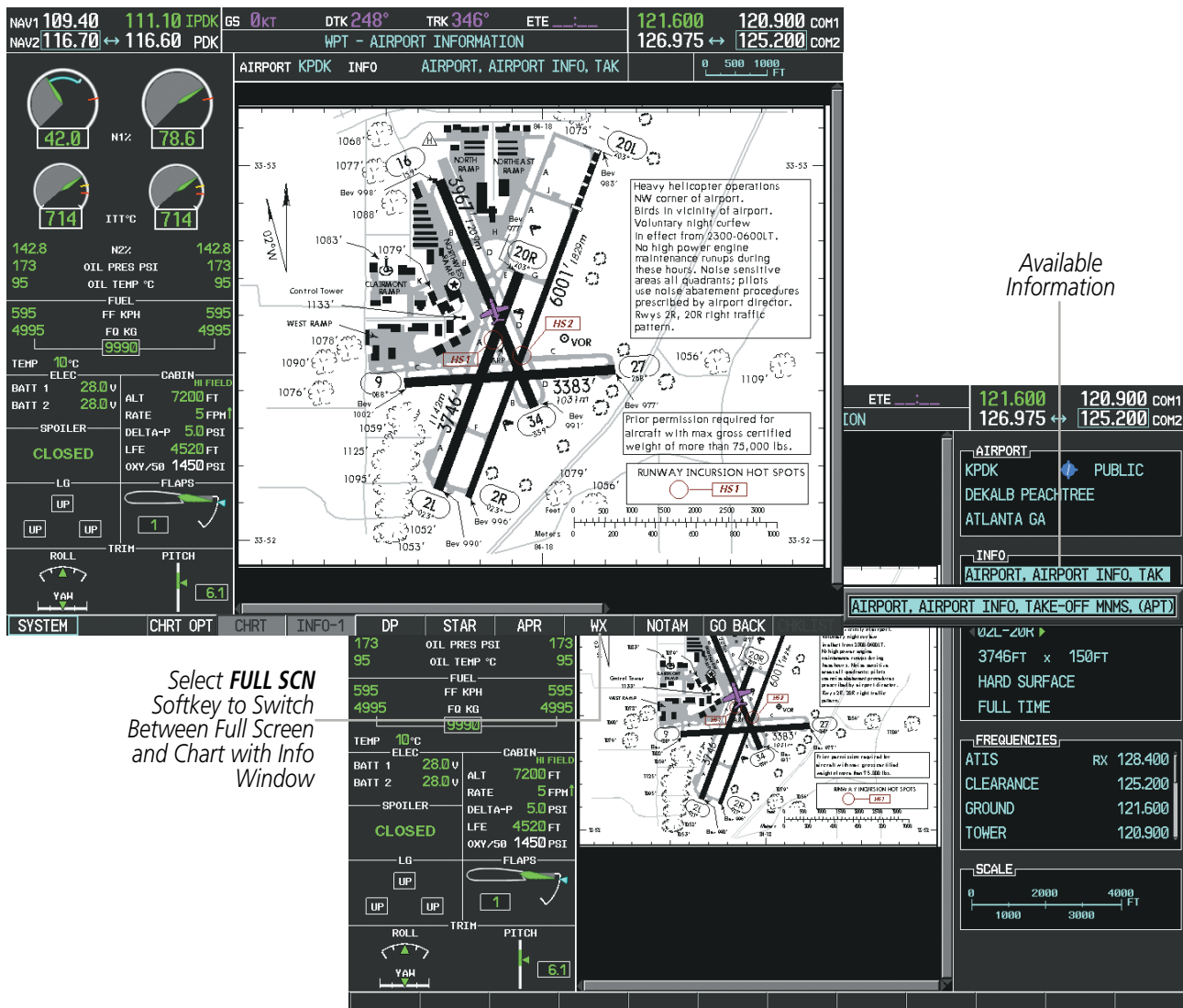

Figure 8-40 Airport Information Page, Full Screen and Info Window

Selecting the **BACK** Softkey, or waiting for 45 seconds reverts to the chart selection softkeys.



The full screen view can also be selected by using the page menu option.

**Selecting full screen On or Off:**

- 1) While viewing a terminal chart press the **MENU** Key to display the Page Menu OPTIONS.
- 2) Turn the large **FMS** Knob to highlight the Chart Setup Menu Option and press the **ENT** Key.
- 3) Turn the large **FMS** Knob to move between the FULL SCREEN and COLOR SCHEME Options.
- 4) Turn the small **FMS** Knob to choose between the On and Off Full Screen Options.

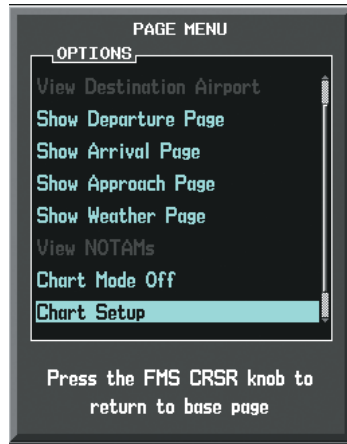

*Chart Setup Option*

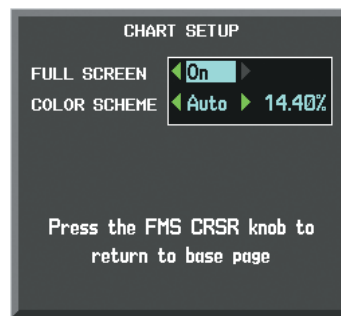

*Full Screen On/Off Selection*

**Figure 8-41 Page Menus**

## DAY/NIGHT VIEW

ChartView can be displayed on a white or black background for day or night viewing. The Day View offers a better presentation in a bright environment. The Night View gives a better presentation for viewing in a dark environment. When the CHART SETUP Box is selected the softkeys are blank.

### Selecting Day, Night, or Automatic View:

- 1) While viewing a terminal chart press the **MENU** Key to display the Page Menu OPTIONS.
- 2) Turn the large **FMS** Knob to highlight the Chart Setup Menu Option and press the **ENT** Key.

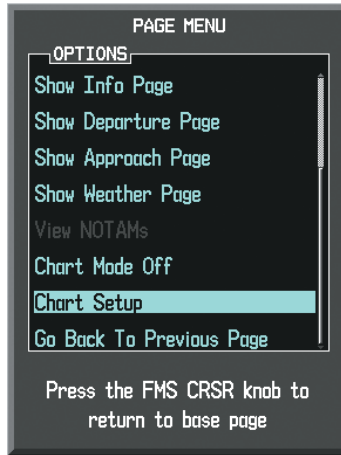

Figure 8-42 Waypoint Information Page, OPTIONS Menu

- 3) Turn the large **FMS** Knob to move to the COLOR SCHEME Option (Figure 8-43).
- 4) Turn the small **FMS** Knob to choose between Day, Auto, and Night Options.
- 5) If Auto Mode is selected, turn the large **FMS** Knob to select the percentage field. Use the small **FMS** Knob to change the percentage value. The percentage value is the day/night crossover point based on the percentage of backlighting intensity. For example, if the value is set to 15%, the day/night display changes when the display backlight reaches 15% of full brightness.

The display must be changed in order for the new setting to become active. This may be accomplished by selecting another page or changing the display range.

- 6) Press the **FMS** Knob when finished to remove the Chart Setup Menu.

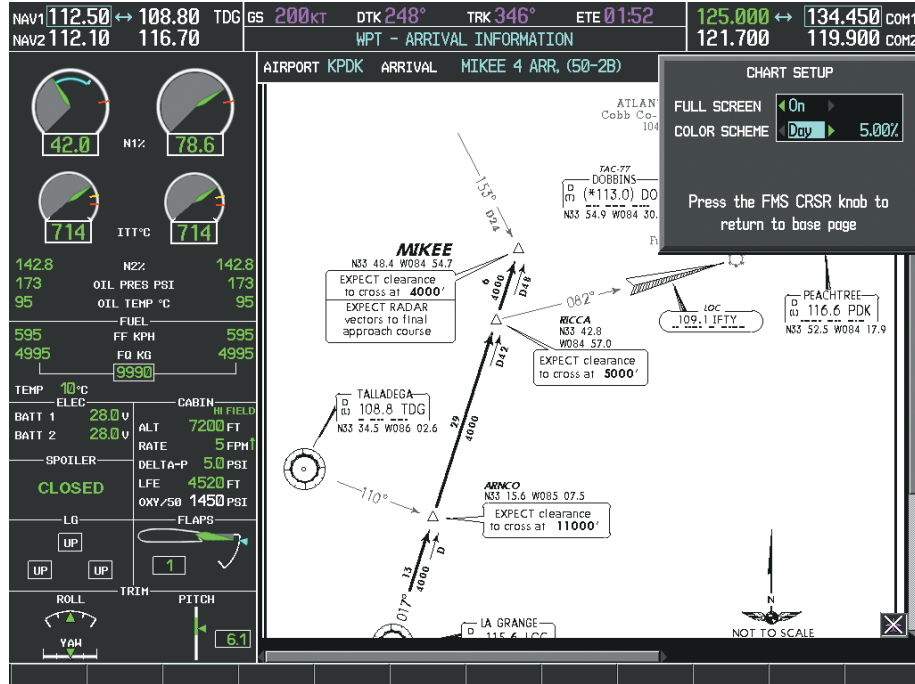

Figure 8-43 Arrival Information Page, Day View

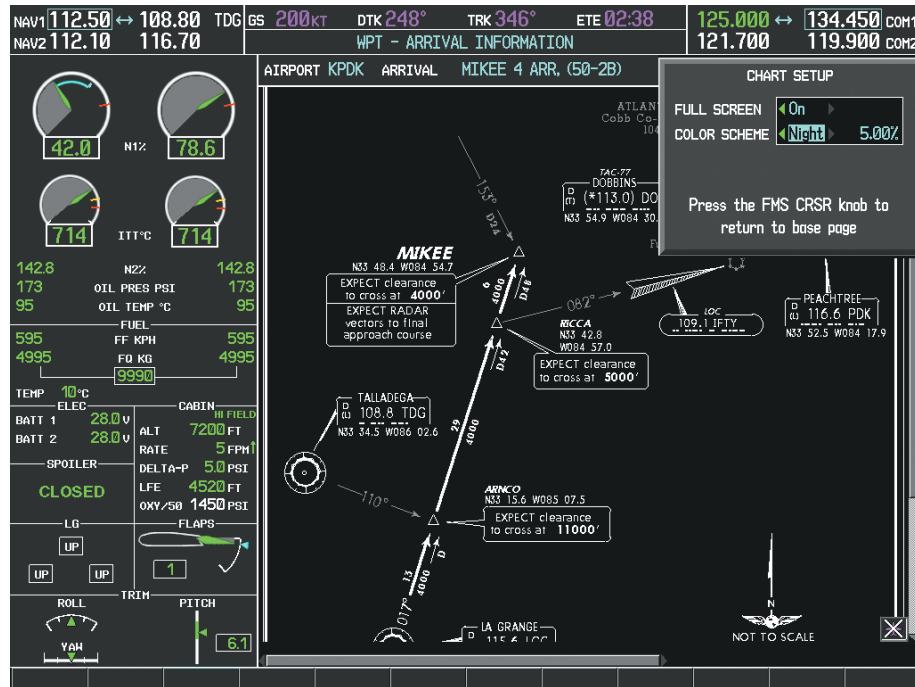

Figure 8-44 Arrival Information Page, Night View

## CHARTVIEW CYCLE NUMBER AND EXPIRATION DATE

The ChartView database is revised every 14 days. Charts are still viewable during a period that extends from the cycle expiration date to the disables date. ChartView is disabled 70 days after the expiration date and is no longer available for viewing. After the expiration date, the ChartView database is no longer current, however, data displayed on the actual charts may still be current. When viewing charts after the ChartView database has expired, ensure the displayed chart is current before using.

When turning on the system, the Power-up Page displays the current status of the ChartView database. See the table below for the various ChartView Power-up Page displays and the definition of each.

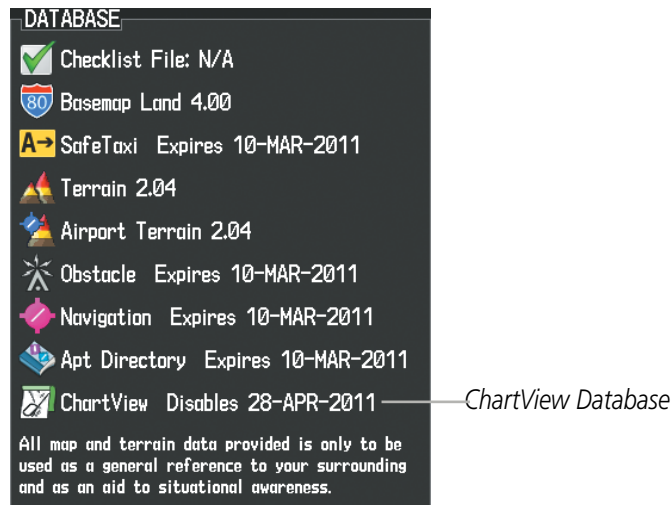



Figure 8-45 Power-up Page, ChartView Database

Power-up Page Display	Definition
[Blank Line]	Blank Line. system is not configured for ChartView. Contact a Garmin-authorized service center for configuration.
[Chart Data: N/A]	System is configured for ChartView but no chart database is installed. Contact Jeppesen for a ChartView database.
[ChartView Disables 28-APR-2011]	Normal operation. ChartView database is valid and within current cycle.
[Chart data update available.]	ChartView database is within 1 week after expiration date. A new cycle is available for update.
[Chart data is out of date!]	ChartView database is beyond 1 week after expiration date, but still within the 70 day viewing period.
[Chart data is disabled.]	ChartView database has timed out. Database is beyond 70 days after expiration date. ChartView database is no longer available for viewing.
[Verify chart database cycle.]	System time is not available. GPS satellite data is unknown or the system has not yet locked onto satellites. Check database cycle number for effectivity.
[Verifying Chart data]	System is verifying chart database when new cycle is installed for the first time.
[Chart Data is Corrupt!]	After verifying, chart database is found to be corrupt. ChartView is not available.

Table 8-2 ChartView Power-up Page Annunciations and Definitions

The ChartView time critical information can also be found on the AUX - System Status page. The database CYCLE number, EXPIRES, and DISABLES dates of the ChartView subscription appear in either blue or yellow text. When the ChartView EXPIRES date is reached, ChartView becomes inoperative 70 days later. This is shown as the DISABLES date. When the DISABLES date is reached, charts are no longer available for viewing. The **SHW CHRT** Softkey label then appears subdued and is disabled until a revised issue of ChartView is installed.

 **NOTE:** A subdued softkey label indicates the function is disabled.

Select the **MFD1 DB** Softkey to place the cursor in the DATABASE window. Scroll through the listed information by turning the **FMS** Knob or pressing the **ENT** Key until the ChartView database information is shown.

The ChartView database cycle number shown in the figure, 1104, is deciphered as follows:

11 – Indicates the year 2011

04 – Indicates the fourth issue of the ChartView database for the year

The EXPIRES date 06–MAR–11 is the date that this database should be replaced with the next issue.

The DISABLES date 15–MAY–11 is the date that this database becomes inoperative.

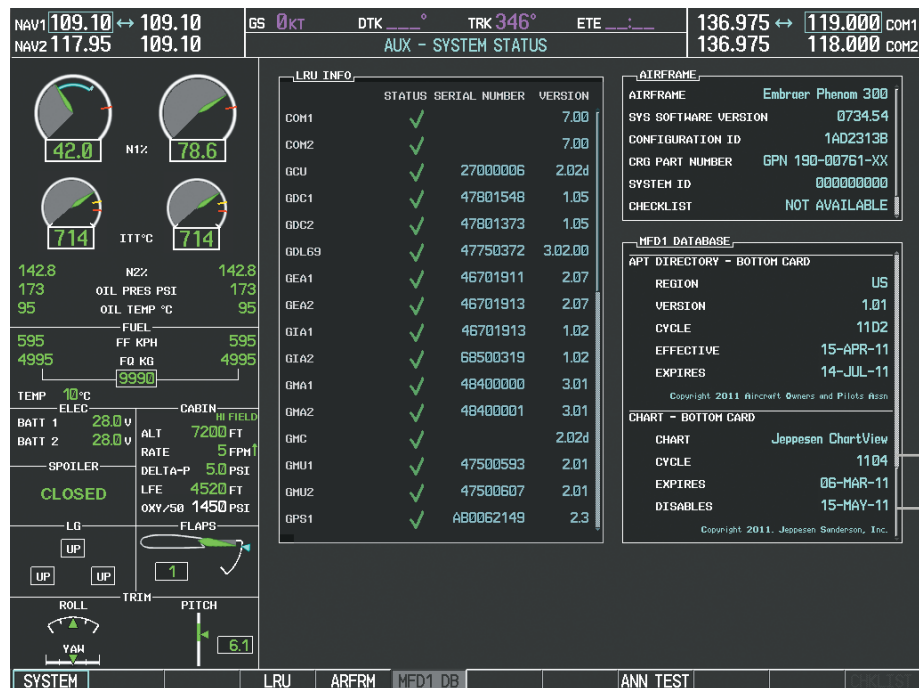

**Figure 8-46 AUX – System Status Page, ChartView Current and Available**

The ChartView database is obtained directly from Jeppesen. Refer to Updating Jeppesen Databases in Appendix B for instructions on revising the ChartView database.

Other possible AUX - System Status page conditions are shown in Figure 8-47. The EXPIRES date, in yellow, is the revision date for the next database cycle. The DISABLES date, in yellow, is the date that this database cycle is no longer viewable. CYCLE NOT AVAILABLE in blue, indicates no ChartView data is available on the database card or no database card is inserted.

<p>MFD1 DATABASE</p> <p>APT DIRECTORY - BOTTOM CARD</p> <p>REGION US</p> <p>VERSION 1.01</p> <p>CYCLE 11D1</p> <p>EFFECTIVE 13-JAN-11</p> <p>EXPIRES 10-MAR-11</p> <p>Copyright 2010 Aircraft Owners and Pilots Assn</p> <p>CHART - BOTTOM CARD</p> <p>CHART Jeppesen ChartView</p> <p>CYCLE 1103</p> <p>EXPIRES 17-FEB-11</p> <p>DISABLES 28-APR-11</p> <p>Copyright 2011. Jeppesen Sanderson, Inc.</p>	<p>MFD1 DATABASE</p> <p>APT DIRECTORY - BOTTOM CARD</p> <p>REGION US</p> <p>VERSION 1.01</p> <p>CYCLE 11D1</p> <p>EFFECTIVE 13-JAN-11</p> <p>EXPIRES 10-MAR-11</p> <p>Copyright 2010 Aircraft Owners and Pilots Assn</p> <p>CHART - BOTTOM CARD</p> <p>CHART Jeppesen ChartView</p> <p>CYCLE 1103</p> <p>EXPIRES 17-FEB-11</p> <p>DISABLES 28-APR-11</p> <p>Copyright 2011. Jeppesen Sanderson, Inc.</p>	<p>MFD1 DATABASE</p> <p>REGION US</p> <p>VERSION 1.01</p> <p>CYCLE 11D1</p> <p>EFFECTIVE 13-JAN-11</p> <p>EXPIRES 10-MAR-11</p> <p>Copyright 2010 Aircraft Owners and Pilots Assn</p> <p>CHART - UNKNOWN</p> <p>CHART Jeppesen ChartView</p> <p>REGION NOT AVAILABLE</p> <p>CYCLE NOT AVAILABLE</p> <p>EFFECTIVE -- -- -- --</p> <p>EXPIRES -- -- -- --</p> <p>DISABLES -- -- -- --</p>
--	--	---

*ChartView has Expired, but is not Disabled*

*ChartView Database is Disabled*

*ChartView Database is Not Available*

**Figure 8-47 AUX – System Status Page, ChartView Database Status**

## 8.4 FLITECHARTS

FliteCharts resemble the paper version of AeroNav Services terminal procedures charts. The charts are displayed with high-resolution and in color for applicable charts. FliteCharts database subscription is available from Garmin. Available data includes:

- Arrivals (STAR)
- Departure Procedures (DP)
- Approaches
- Airport Diagrams

### FLITECHARTS SOFTKEYS

FliteCharts functions are displayed on three levels of softkeys. While on the Navigation Map Page, Nearest Airports Page, or Flight Plan Page, selecting the **SHW CHRT** Softkey displays the available terminal chart and advances to the chart selection level of softkeys: **CHRT OPT**, **CHRT**, **INFO**, **DP**, **STAR**, **APR**, **WX**, and **GO BACK**. The chart selection softkeys appear on the Airport Information Page.

Selecting the **GO BACK** Softkey reverts to the top level softkeys and previous page.

Selecting the **CHRT OPT** Softkey displays the available terminal chart and advances to the next level of softkeys: **ALL**, **FIT WDTN**, **FULL SCN**, and **BACK**.

While viewing the **CHRT OPT** Softkeys, after 45 seconds of softkey inactivity, the system reverts to the chart selection softkeys.

NOTAMs are not available with FliteCharts. The NOTAM Softkey label appears subdued and is disabled.

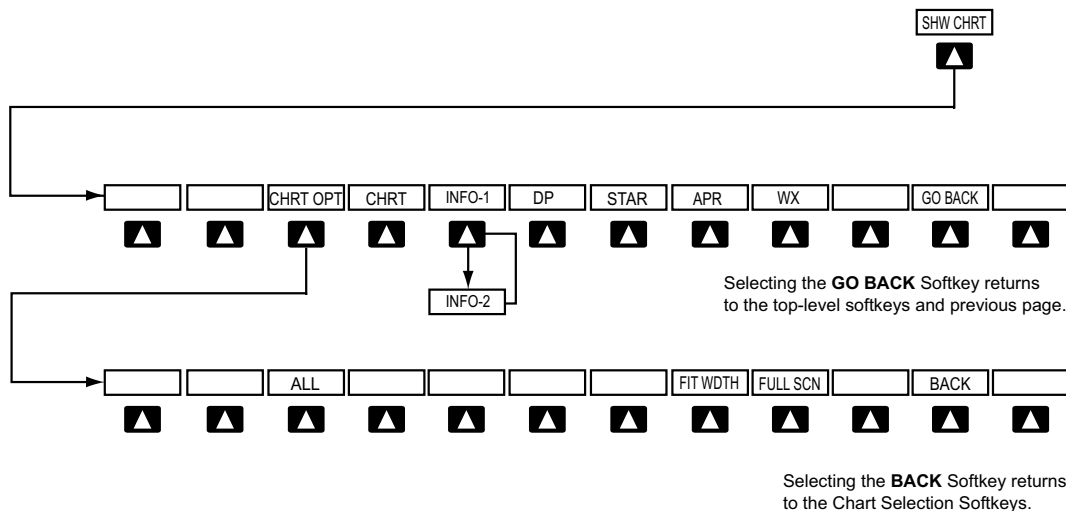

Figure 8-48 FliteCharts SHW CHRT, Chart Selection, and Chart Option Softkeys



## TERMINAL PROCEDURES CHARTS

### Selecting Terminal Procedures Charts:

While viewing the Navigation Map Page, Nearest Airport Page, or Flight Plan Page, select the **SHW CHRT** Softkey.

Or:

- 1) Press the **MENU** Key to display the PAGE MENU.
- 2) Turn the large **FMS** Knob to scroll through the OPTIONS Menu to Show Chart.
- 3) Press the **ENT** Key to display the chart.

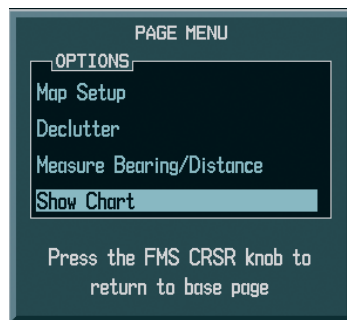

Navigation Map Page OPTIONS Menu



Waypoint Airport Information Page OPTIONS Menu

Figure 8-49 Option Menus

When no terminal procedure chart is available, the banner **CHART NOT AVAILABLE** appears on the screen. The **CHART NOT AVAILABLE** banner does not refer to the FliteCharts subscription, but rather the availability of a particular airport chart selection or procedure for a selected airport.



Figure 8-50 Chart Not Available Banner

If there is a problem in rendering the data (such as a data error or a failure of an individual chart), the banner **UNABLE TO DISPLAY CHART** is then displayed.



Figure 8-51 Unable To Display Chart Banner

When a chart is not available by selecting the **SHW CHRT** Softkey or selecting a Page Menu Option, charts may be obtained for other airports from the WPT Pages or Flight Plan Pages.

If a chart is available for the destination airport, or the airport selected in the active flight plan, the chart appears on the screen. When no flight plan is active, or when not flying to a direct-to destination, selecting the **SHW CHRT** Softkey displays the chart for the nearest airport, if available.

The chart shown is one associated with the WPT – Airport Information page. Usually this is the airport runway diagram. Where no runway diagram exists, but Take Off Minimums or Alternate Minimums are available, that page appears. If Airport Information pages are unavailable, the Approach Chart for the airport is shown.

**Selecting a chart:**

- 1) While viewing the Navigation Map Page, Flight Plan Page, or Nearest Airports Page, select the **SHW CHRT** Softkey. The airport diagram or approach chart is displayed on the Airport Information Page.
- 2) Press the **FMS** Knob to activate the cursor.
- 3) Turn the large **FMS** Knob to select either the Airport Identifier Box or the Approach Box. (Select the **APR** Softkey if the Approach Box is not currently shown).
- 4) Turn the small and large **FMS** Knob to enter the desired airport identifier.
- 5) Press the **ENT** Key to complete the airport selection.
- 6) Turn the large **FMS** Knob to select the Approach Box.
- 7) Turn the small **FMS** Knob to show the approach chart selection choices.
- 8) Turn either **FMS** Knob to scroll through the available charts.
- 9) Press the **ENT** Key to complete the chart selection.

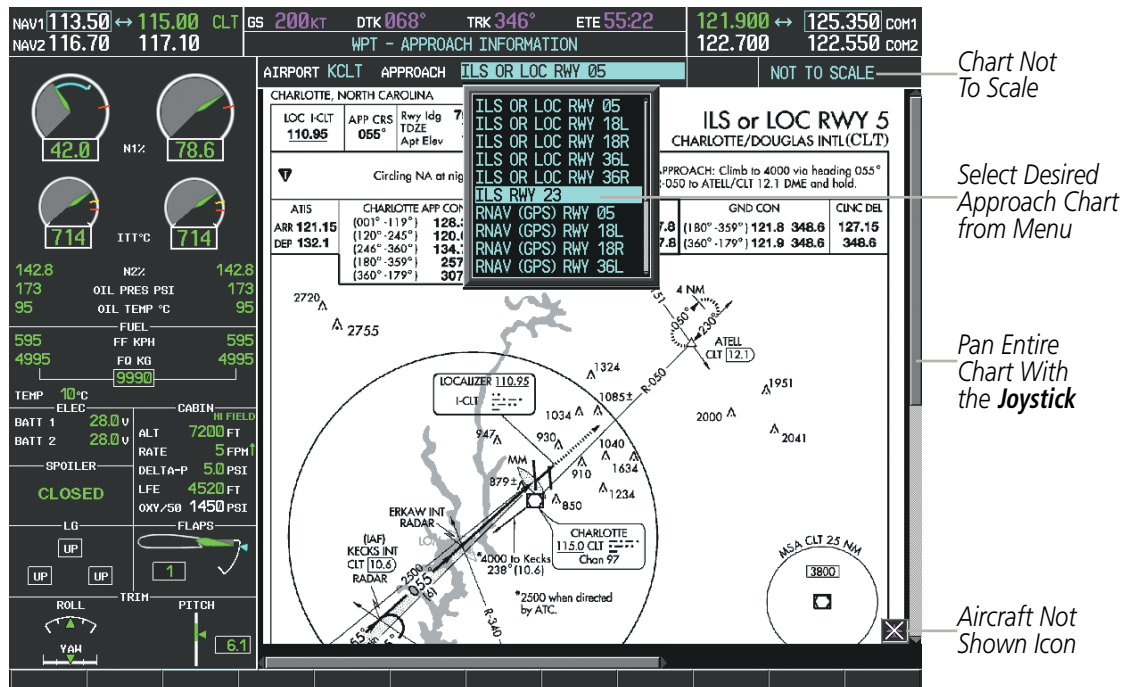
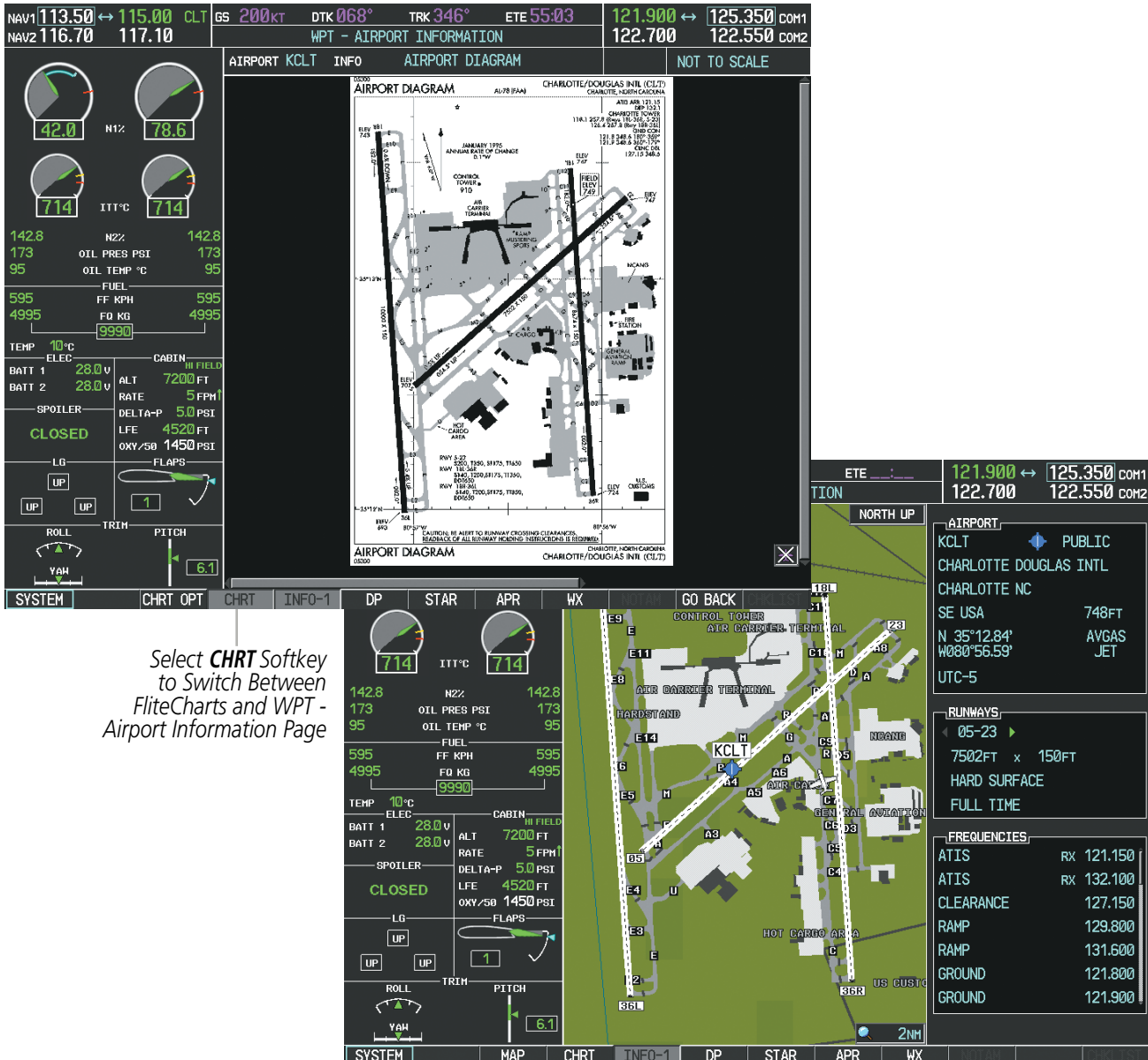

**Figure 8-52 Approach Information Page, Chart Selection**

While the APPROACH Box is selected using the **FMS** Knob, the softkeys are blank. Once the desired chart is selected, the chart scale can be changed and the chart can be panned using the **Joystick**. Pressing the **Joystick** centers the chart on the screen.

The aircraft symbol is not shown on FliteCharts. The Chart Scale Box displays a banner NOT TO SCALE, and the Aircraft Not Shown Icon is displayed in the lower right corner of the screen.

Selecting the **CHRT** Softkey switches between the FliteCharts diagram and the associated map in the WPT page group. In the example shown, the **CHRT** Softkey switches between the Charlotte, NC (KCLT) Airport Diagram and the navigation map on the WPT – Airport Information page.



Select **CHRT** Softkey to Switch Between FliteCharts and WPT - Airport Information Page

Figure 8-53 CHRT Softkey, Airport Information Page

Pressing the **INFO-1** or **INFO-2** Softkey returns to the airport diagram chart when the view is on a terminal procedure chart. If the displayed chart is the airport diagram chart, pressing the **INFO-1** or **INFO-2** Softkey returns to the Airport Information Page.

Another source for additional airport information is from the INFO Box above the chart (Figure 8-53) or to the right of the chart (Figure 8-54) for certain airports. This information source is not related to the **INFO-1** or **INFO-2** Softkey. When the INFO Box is selected using the **FMS** Knob, the softkeys are blank. The Charlotte, NC airport has three additional charts offering information; the Airport Diagram, Alternate Minimums, and Take-off Minimums.

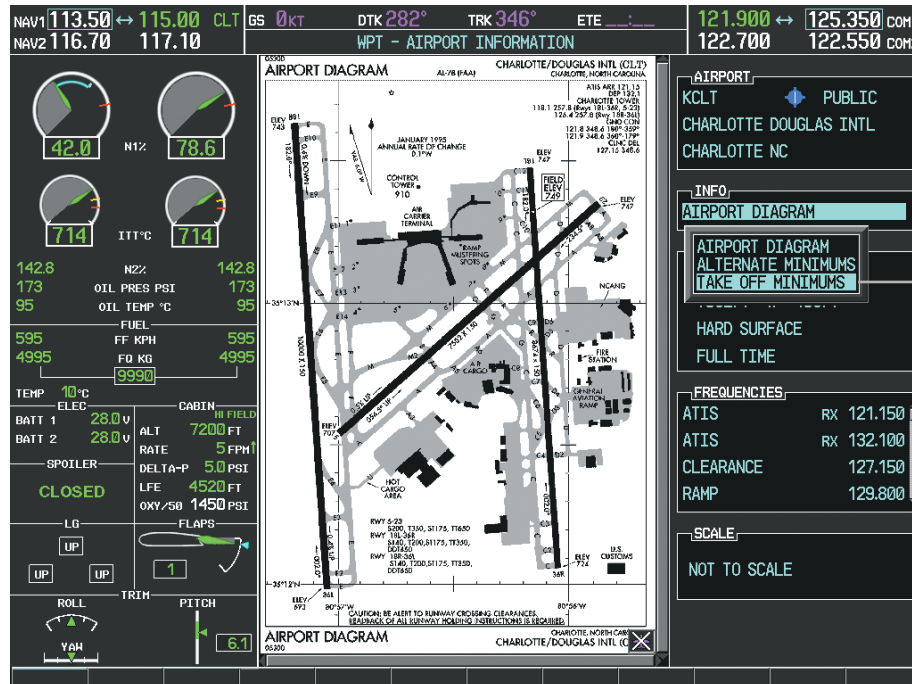

Info Box Selected

Figure 8-54 Airport Information Page, INFO View with Airport Information

In the example shown in Figure 8-54, TAKE OFF MINIMUMS is selected. Pressing the ENT Key displays the IFR Alternate Minimums Chart (Figure 8-55).



Figure 8-55 Airport Information Page, ALTERNATE MINIMUMS Selected from INFO View

Selecting the DP Softkey displays the Departure Procedure Chart if available.

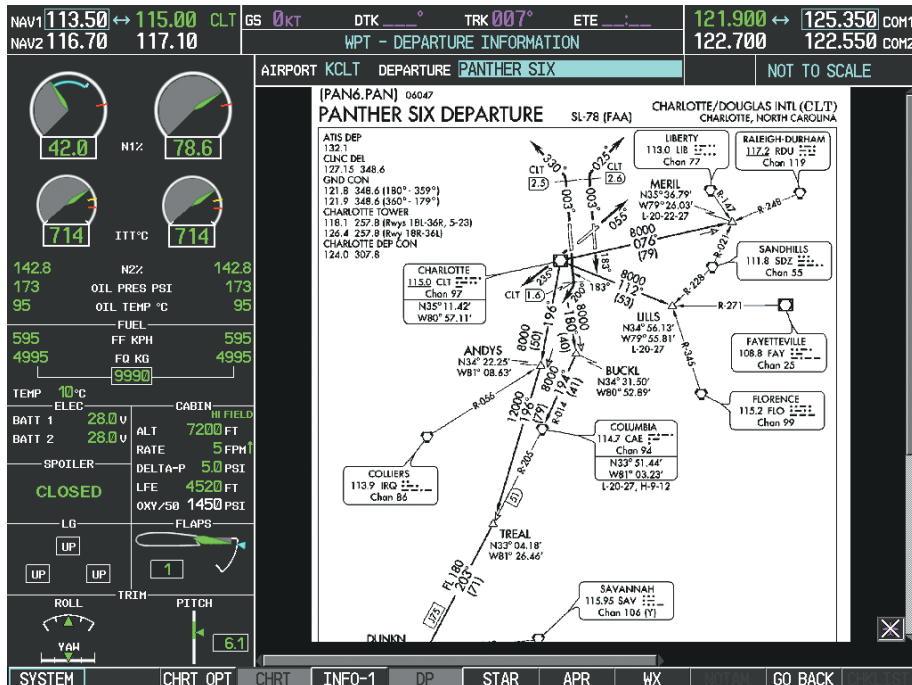

Figure 8-56 Departure Information Page



Selecting the **STAR** Softkey displays the Standard Terminal Arrival Chart if available.



Figure 8-57 Arrival Information Page

Selecting the **APR** Softkey displays the approach chart for the airport if available.

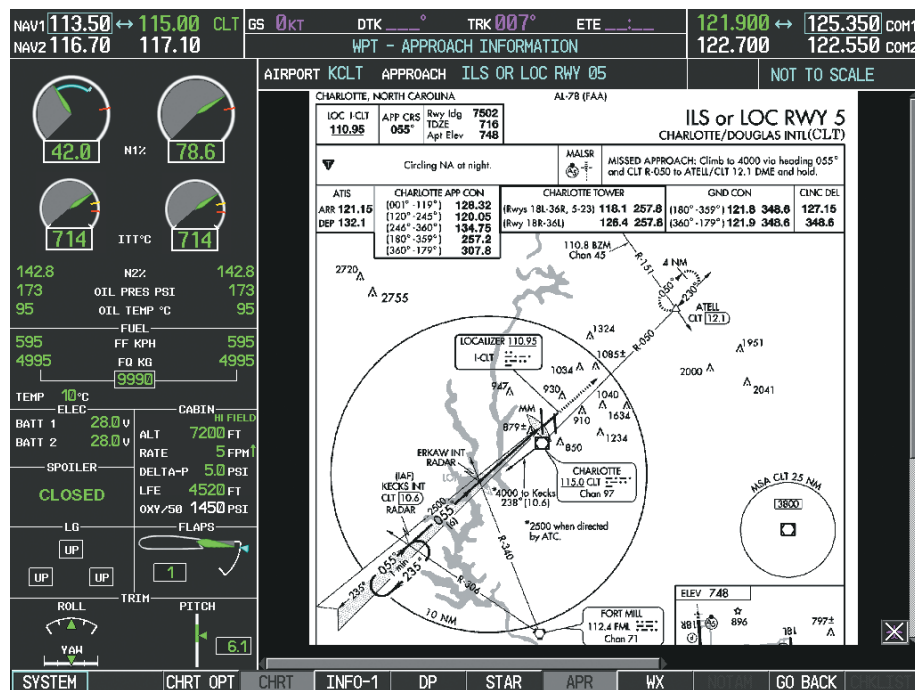

Figure 8-58 Approach Information Page

Selecting the **WX** Softkey shows the airport weather frequency information, when available, and includes weather data such as METAR and TAF from the XM Data Link Receiver. Weather information is available only when an XM Data Link Receiver is installed and the SiriusXM Weather subscription is current.

**Selecting Additional Information:**

- 1) While viewing the Airport Taxi Diagram, select the **WX** Softkey to display the information windows (AIRPORT, INFO).
- 2) Press the **FMS** Knob to activate the cursor.
- 3) Turn the large **FMS** Knob to highlight the INFO Box.
- 4) Turn the small **FMS** Knob to select the INFO Box choices. When the INFO Box is selected the softkeys are blank. If multiple choices are available, scroll to the desired choice with the large **FMS** Knob and press the **ENT** Key to complete the selection.
- 5) Press the **FMS** Knob again to deactivate the cursor.

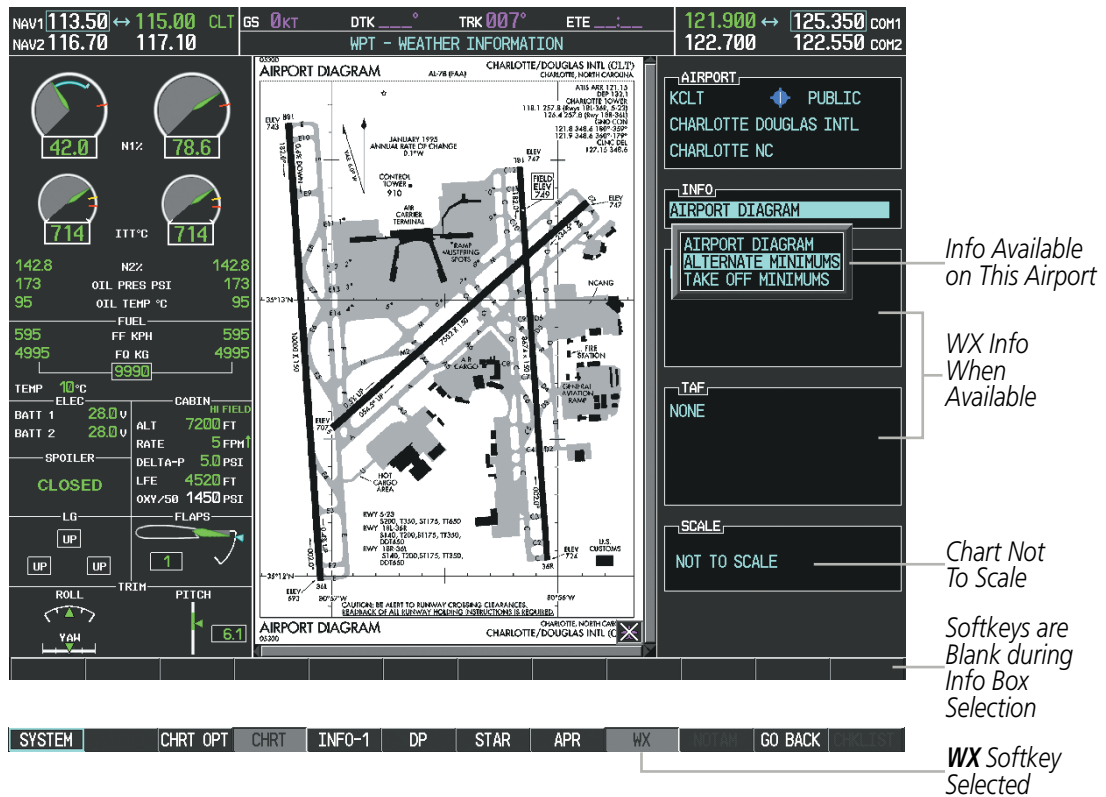

Figure 8-59 Weather Information Page, WX Softkey Selected

Selecting the **GO BACK** Softkey reverts to the previous page (Navigation Map Page or Flight Plan Page).



**CHART OPTIONS**

Selecting the **CHRT OPT** Softkey displays the next level of softkeys, the chart options level (Figure 8-48).  
 Selecting the **ALL** Softkey shows the entire chart on the screen.

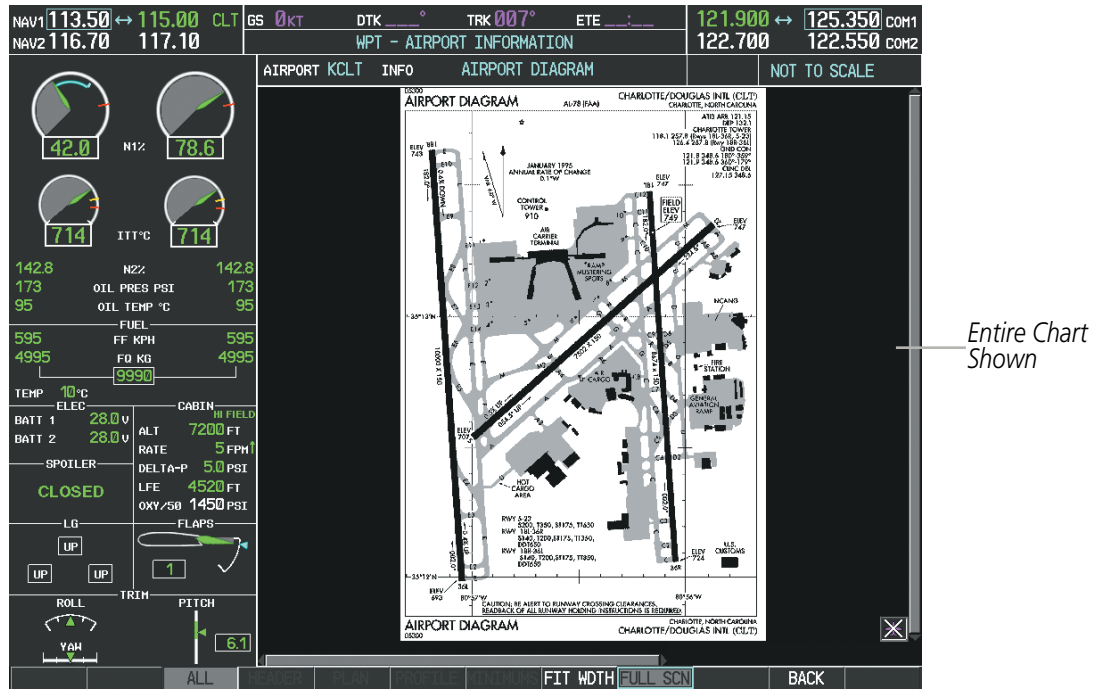

**Figure 8-60 Airport Information Page, ALL View Selected**

Selecting the **FIT WIDTH** Softkey fits the width of the chart in the display viewing area. In the example shown, the chart at close range is replaced with the full width chart.

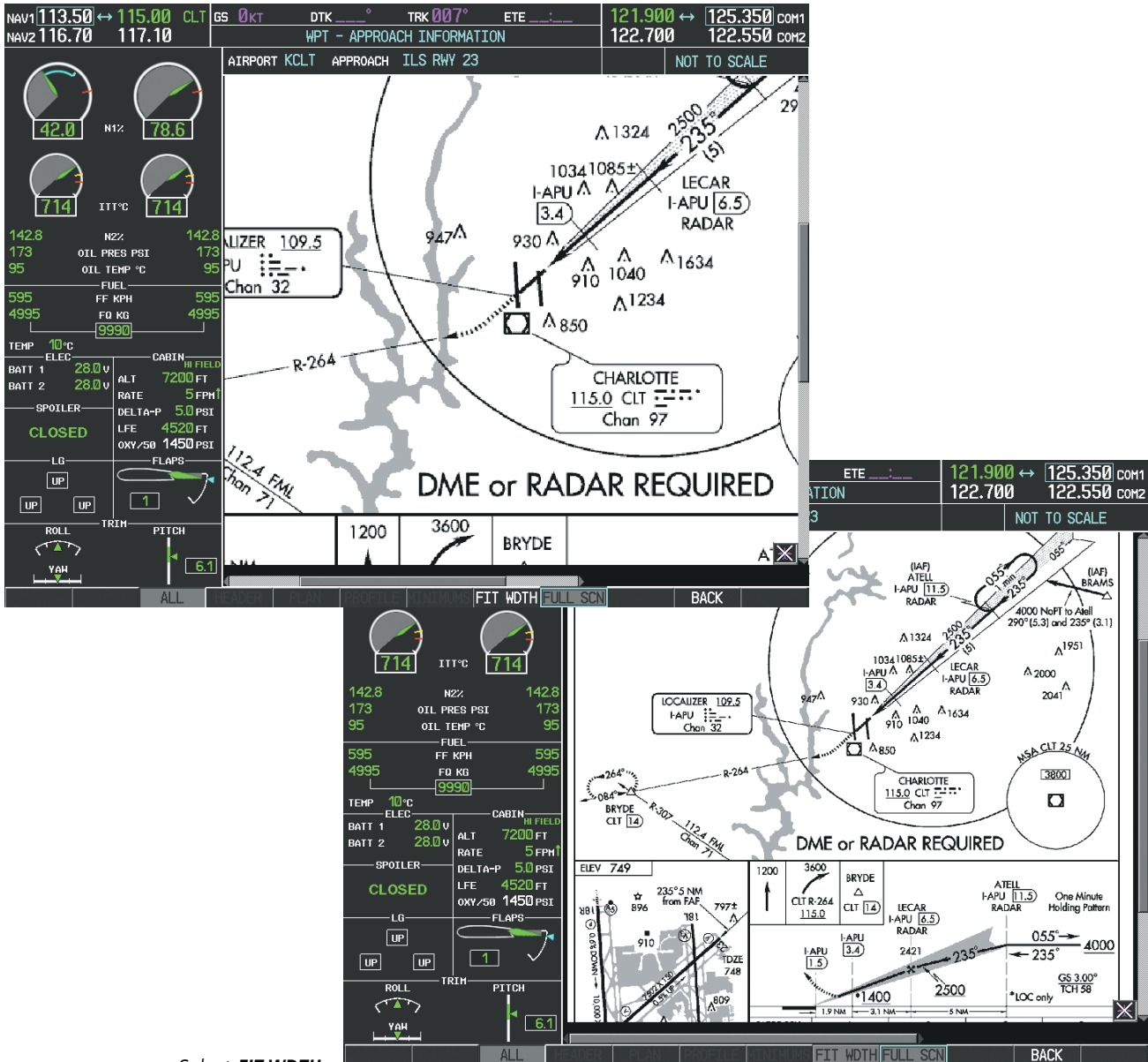

Select **FIT WIDTH** Softkey to Show Full Chart Width

Figure 8-61 Approach Information Page, FIT WIDTH Softkey Selected

Selecting the **FULL SCN** Softkey alternates between removing and replacing the data window to the right.

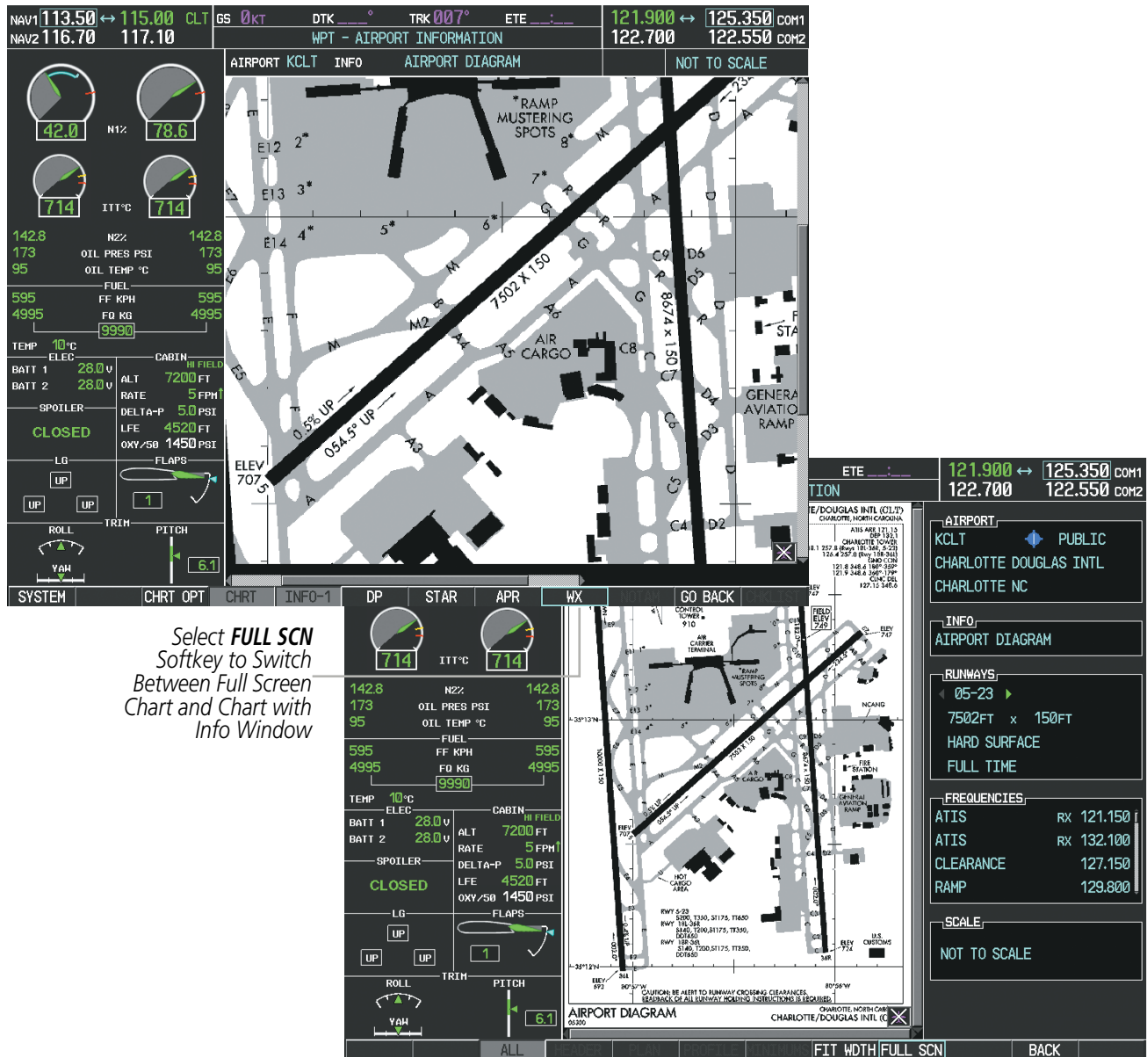

Figure 8-62 Airport Information Page, Full Screen and Info Window

Selecting the **BACK** Softkey, or waiting for 45 seconds reverts to the chart selection softkeys.

The full screen view can also be selected by using the page menu option.

**Selecting full screen On or Off:**

- 1) While viewing a terminal chart press the **MENU** Key to display the Page Menu OPTIONS.
- 2) Turn the large **FMS** Knob to highlight the Chart Setup Menu Option and press the **ENT** Key.
- 3) Turn the large **FMS** Knob to move between the FULL SCREEN and COLOR SCHEME Options.
- 4) Turn the small **FMS** Knob to choose between the On and Off Full Screen Options.

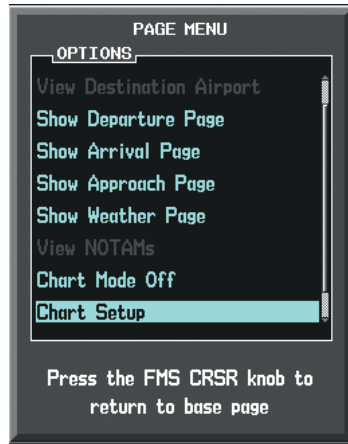

*Chart Setup Option*

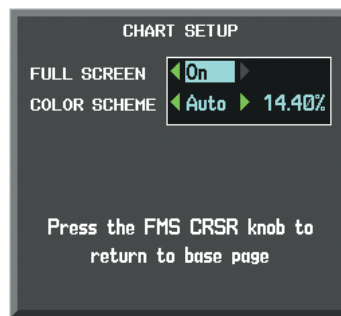

*Full Screen On/Off Selection*

**Figure 8-63 Page Menus**

## DAY/NIGHT VIEW

FliteCharts can be displayed on a white or black background for day or night viewing. The Day View offers a better presentation in a bright environment. The Night View gives a better presentation for viewing in a dark environment. When the CHART SETUP Box is selected the softkeys are blank.

### Selecting Day, Night, or Automatic View:

- 1) While viewing a terminal chart press the **MENU** Key to display the Page Menu OPTIONS.
- 2) Turn the large **FMS** Knob to highlight the Chart Setup Menu Option and press the **ENT** Key.

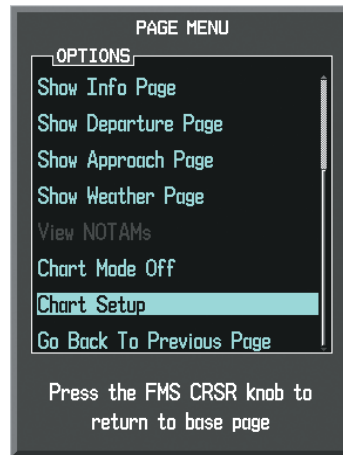

Figure 8-64 Waypoint Information Page, OPTIONS Menu

- 3) Turn the large **FMS** Knob to move to the COLOR SCHEME Option (Figure 8-65).
- 4) Turn the small **FMS** Knob to choose between Day, Auto, and Night Options.
- 5) If Auto Mode is selected, turn the large **FMS** Knob to select the percentage field. Use the small **FMS** Knob to change the percentage value. The percentage value is the day/night crossover point based on the percentage of backlighting intensity. For example, if the value is set to 15%, the day/night display changes when the display backlight reaches 15% of full brightness.

The display must be changed in order for the new setting to become active. This may be accomplished by selecting another page or changing the display range.

- 6) Press the **FMS** Knob when finished to remove the Chart Setup Menu.

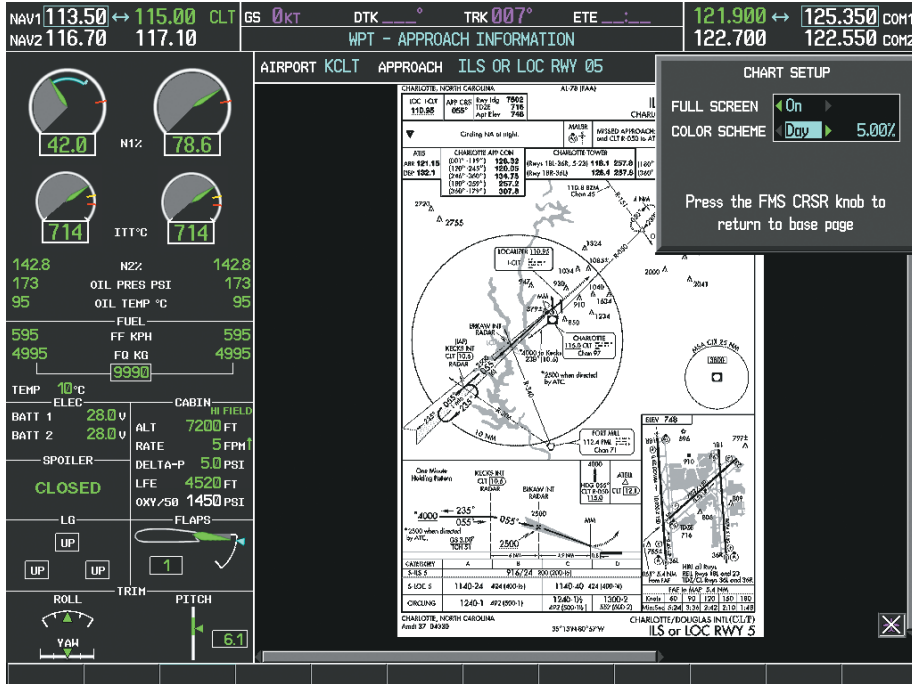

Figure 8-65 Approach Information Page, Day View

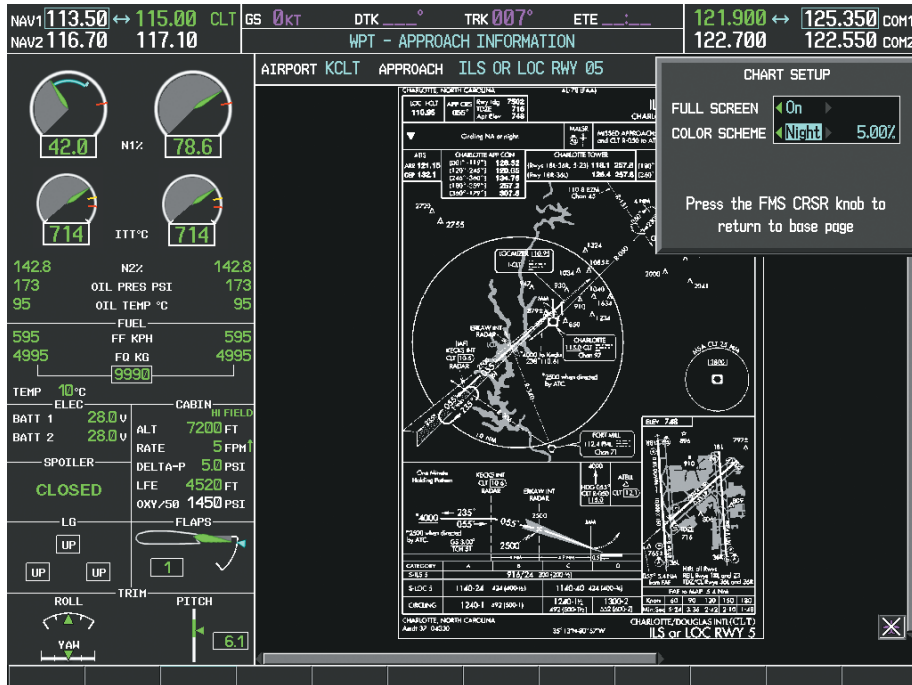
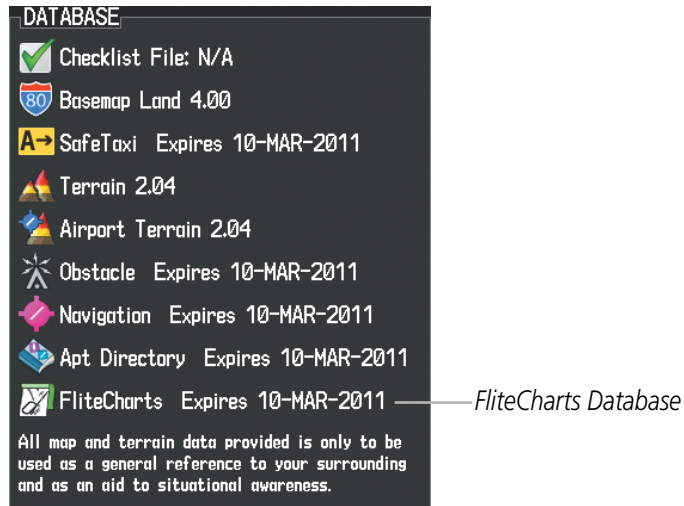

Figure 8-66 Approach Information Page, Night View

**FLITECHARTS CYCLE NUMBER AND EXPIRATION DATE**

FliteCharts data is revised every 28 days. Charts are still viewable during a period that extends from the cycle expiration date to the disables date. FliteCharts is disabled 180 days after the expiration date and are no longer available for viewing upon reaching the disables date. After the expiration date, the FliteCharts database is no longer current, however, data displayed on the actual charts may still be current. When viewing charts after the FliteCharts database has expired, ensure the displayed chart is current before using.

When turning on the system, the Power-up Page displays the current status of the FliteCharts database. See the table below for the various FliteCharts Power-up Page displays and the definition of each.



**Figure 8-67 Power-up Page, FliteCharts Database**

Power-up Page Display	Definition
	Blank Line. system is not configured for FliteCharts. Contact a Garmin-authorized service center for configuration.
Chart Data: N/A	System is configured for FliteCharts but no chart database is installed. Refer to Updating Garmin Databases in Appendix B for the FliteCharts database
FliteCharts Expires 10-MAR-2011	Normal operation. FliteCharts database is valid and within current cycle.
Chart data is out of date!	FliteCharts database is beyond the expiration date, but still within the 180 day viewing period.
Chart data is disabled.	FliteCharts database has timed out. Database is beyond 180 days after expiration date. FliteCharts database is no longer available for viewing.

**Table 8-3 FliteCharts Power-up Page Annunciations and Definitions**

Other possible AUX - System Status page conditions are shown in Figure 8-68. ‘FliteCharts Expires’ plus a date in white, indicates the chart database is current. ‘Chart data is out of date!’ in yellow, indicates charts are still viewable, but approaching the disable date.



When the 180 day grace period has expired, 'Chart data is disabled.' in yellow indicates that the FliteCharts database has expired and is no longer viewable. 'Chart Data: N/A' appears in white if no FliteCharts data is available on the database card or no database card is inserted.

FliteCharts time critical information can also be found on the AUX - System Status page. The FliteCharts database REGION, CYCLE number, EFFECTIVE, EXPIRES, and DISABLES dates of the subscription appear in either blue or yellow text. Dates shown in blue are current data. Dates shown in yellow indicate the data is not within the current subscription period.

FliteCharts becomes inoperative 180 days after the FliteCharts EXPIRES date is reached, and is no longer available for viewing. This date is shown as the DISABLES date. After the disable date the **SHW CHRT** Softkey label appears subdued and is unavailable until a revised issue of FliteCharts is installed.

**NOTE:** A subdued softkey label indicates the function is disabled.

Select the **MFD1 DB** Softkey to place the cursor in the DATABASE window. Scroll through the listed information by turning the **FMS** Knob or pressing the **ENT** Key until the FliteCharts database information is shown.

The FliteCharts database cycle number shown in the figure, 1105, is deciphered as follows:

11 – Indicates the year 2011

05 – Indicates the fifth issue of the FliteCharts database for the year

The FliteCharts EFFECTIVE date 07–MAY–11 is the first date that this database is current.

The FliteCharts EXPIRES date 04–JUN–11 is the last date that this database is current.

The DISABLES date 01–DEC–11 is the date that this database becomes inoperative.

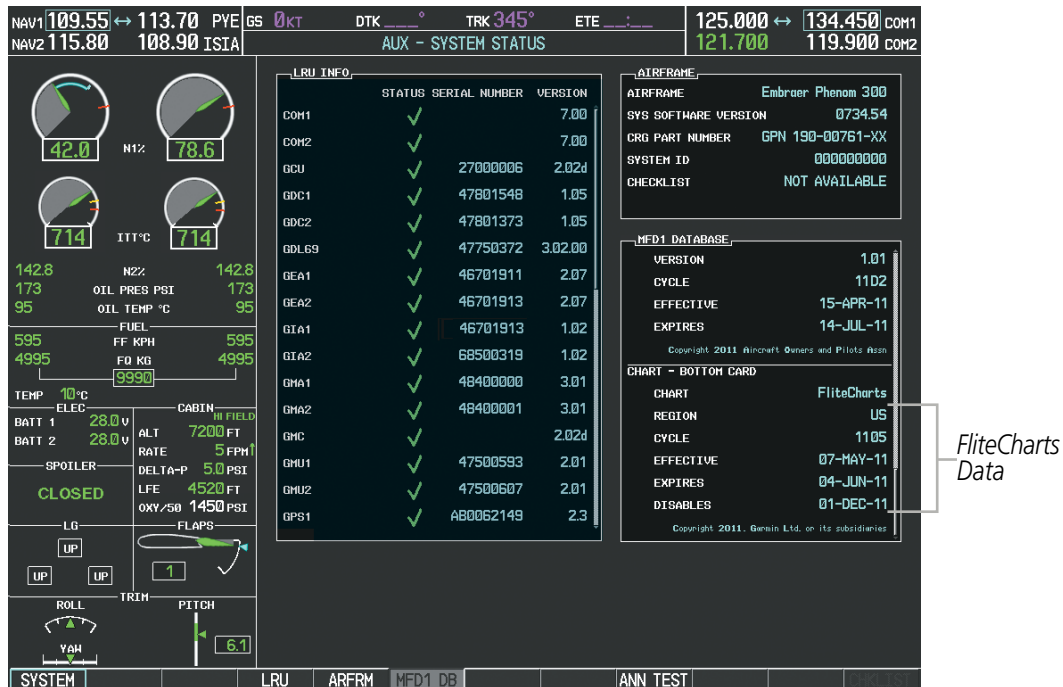

Figure 8-68 AUX – System Status Page, FliteCharts Current and Available

The FliteCharts database is provided from Garmin. Refer to Updating Garmin Databases in Appendix B for instructions on revising the FliteCharts database.

The other four possible AUX - System Status page conditions are shown here. The EFFECTIVE date, in yellow, indicates the current date precedes the date the FliteCharts database becomes effective. The EXPIRES date, in yellow, is the revision date for the next database cycle. The DISABLES date, in yellow, is the date that this database cycle is no longer viewable. NOT AVAILABLE in blue, indicate the FliteCharts database is not available on the database card or no database card is inserted.

MFD1 DATABASE	
VERSION	1.01
CYCLE	11D1
EFFECTIVE	13-JAN-11
EXPIRES	10-MAR-11
Copyright 2010 Aircraft Owners and Pilots Assn	
CHART - BOTTOM CARD	
CHART	FliteCharts
REGION	US
CYCLE	1102
EFFECTIVE	10-FEB-11
EXPIRES	10-MAR-11
DISABLES	06-SEP-11
Copyright 2011. Garmin Ltd. or its subsidiaries	

*Current Date is Before Effective Date*

MFD1 DATABASE	
VERSION	1.01
CYCLE	11D1
EFFECTIVE	13-JAN-11
EXPIRES	10-MAR-11
Copyright 2010 Aircraft Owners and Pilots Assn	
CHART - BOTTOM CARD	
CHART	FliteCharts
REGION	US
CYCLE	1102
EFFECTIVE	10-FEB-11
EXPIRES	10-MAR-11
DISABLES	06-SEP-11
Copyright 2011. Garmin Ltd. or its subsidiaries	

*FliteCharts Expired, but is not Disabled*

MFD1 DATABASE	
VERSION	1.01
CYCLE	11D1
EFFECTIVE	13-JAN-11
EXPIRES	10-MAR-11
Copyright 2010 Aircraft Owners and Pilots Assn	
CHART - BOTTOM CARD	
CHART	FliteCharts
REGION	US
CYCLE	1102
EFFECTIVE	10-FEB-11
EXPIRES	10-MAR-11
DISABLES	06-SEP-11
Copyright 2011. Garmin Ltd. or its subsidiaries	

*FliteCharts Database is Disabled*

MFD1 DATABASE	
VERSION	1.01
CYCLE	11D1
EFFECTIVE	13-JAN-11
EXPIRES	10-MAR-11
Copyright 2010 Aircraft Owners and Pilots Assn	
CHART - UNKNOWN	
CHART	FliteCharts
REGION	NOT AVAILABLE
CYCLE	NOT AVAILABLE
EFFECTIVE	-- -- --
EXPIRES	-- -- --
DISABLES	-- -- --

*FliteCharts Database is Not Available*

**Figure 8-69 AUX – System Status Page, FliteCharts Database Status**

8.5

Airport Directory

The Aircraft Owners and Pilots Association (AOPA) and AC-U-KWIK Airport Directory databases offer detailed information regarding services, hours of operation, lodging options, and more. This information is viewed on the Airport Information Page by selecting the INFO Softkey until **INFO-2** is displayed as shown in Figure 8-70.

Both Airport Directories are available for downloading at flygarmin.com. However, copy only one of the databases to the Supplemental Data Card. The system cannot recognize both databases simultaneously.



Figure 8-70 AOPA Information on the Airport Information Page

## AIRPORT DIRECTORY DATABASE CYCLE NUMBER AND REVISION

The Airport Directory databases are revised every 56 days. Check fly.garmin.com for the current database. The Airport Directory is always available for use after the expiration date. When turning on the system, the Power-up Page indicates whether the databases are current, out of date, or not available.

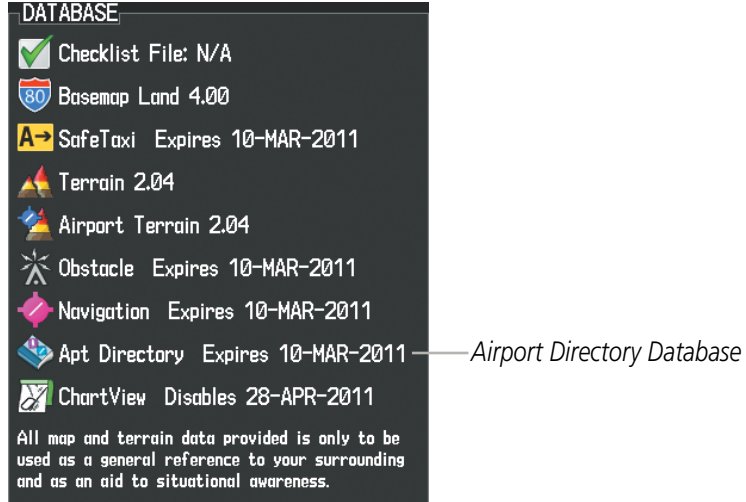

Figure 8-71 Power-up Page, Airport Directory Database

Power-up Page Display	Definition
Apt Directory Expires 10-MAR-2011	Normal operation. Airport Directory database is valid and within current cycle.
Apt Directory Expires 10-MAR-2011	Airport Directory database has expired.
Apt Directory N/A	Database card contains no Airport Directory data.

Table 8-4 Airport Directory Annunciation Definitions

The Airport Directory Region, Version, Cycle, Effective date and Expires date of the database cycle can also be found on the AUX - System Status page, as seen in Figure 8-72.

Select the **MFD1 DB** Softkey to place the cursor in the DATABASE window. Scroll through the listed information by turning the **FMS** Knob or pressing the **ENT** Key until the Airport Directory database information is shown.

The Airport Directory database cycle number shown in the figure, 11D2, is deciphered as follows:

11 – Indicates the year 2011

D – Indicates the data is for Airport Directory

2 – Indicates the second issue of the Airport Directory database for the year

The Airport Directory EFFECTIVE date 15-APR-11 is the beginning date for the current database cycle. The Airport Directory EXPIRES date 14-JUL-11 is the revision date for the next database cycle.



Figure 8-72 AUX – System Status Page, Airport Directory Current Information

Airport Directory information appears in blue and yellow text. The EFFECTIVE date appears in blue when data is current and in yellow when the current date is before the effective date. The EXPIRES date appears in blue when data is current and in yellow when expired (Table 8-4). NOT AVAILABLE appears in blue in the REGION field if Airport Directory data is not available on the database card. An expired Airport Directory database is not disabled and will continue to function indefinitely.

## 8.6 SATELLITE TELEPHONE AND DATA LINK SERVICES



**NOTE:** *Separate accounts must be established to access the Iridium satellite network for voice and Garmin Flight Data Services for data transmission of maintenance reports.*

The optional GDL 59 Data Link provides an aircraft systems data logger for communication of potential maintenance issues and, while the aircraft is on the ground, a high speed (IEEE 802.11g) Wi-Fi data link between the aircraft and a ground computer network. The GDL 59 can also be paired with up to two optional GSR 56 Iridium Transceivers providing an airborne low speed data link, Iridium Satellite Telephone service and SMS text messaging. Iridium telephone and text messaging are available to the flight crew through the Multi-function Display, audio panel and headset. The system provides a telephone handset interface to be used for voice communication between the aircraft cabin and the cockpit and for Iridium telephone service in the aircraft cabin.

Operation of these features in the cockpit is accomplished through the AUX-TELEPHONE, AUX-TEXT MESSAGING, AUX-REPORT STATUS, and AUX-WI-FI SETUP Pages. For operation using the cabin handset, consult the instructions provided with the handset.

### REGISTERING WITH GARMIN FLIGHT DATA SERVICES

A subscriber account must be established prior to using the Iridium Satellite System. Before setting up an Iridium account, obtain the serial number of the Iridium Transceiver (GSR1) and the System ID by selecting the AUX- SYSTEM STATUS Page as shown in Figure 8-72. Contact Garmin Flight Data Services at 1-866-739-5687 in the United States or 913-397-8200, ext. 1135.

#### Registering the system for data link services:

- 1) With the Prodigy® system connected to the Iridium or Wi-Fi network, turn the large **FMS** Knob on the MFD to select the AUX page group.
- 2) Turn the small **FMS** Knob to select SYSTEM STATUS. The AUX-SYSTEM STATUS Page is displayed. Note the System ID number in the AIRFRAME field as seen in Figure 8-72. This number will be needed when contacting Garmin Flight Data Services to establish the account.
- 3) Select the **LRU** Softkey to activate the cursor in the LRU INFO field. Scroll the view 'GSR1' and note the serial number, which will be needed when contacting Garmin Flight Data Services. When an optional second GSR 56 is installed, scroll to view the serial number for 'GSR2'.
- 4) Turn the small **FMS** Knob to select REPORTS/DATA LINK.

- 5) If necessary, select the **REPORTS** Softkey. The AUX-REPORT STATUS Page is now displayed as shown in Figure 8-73.

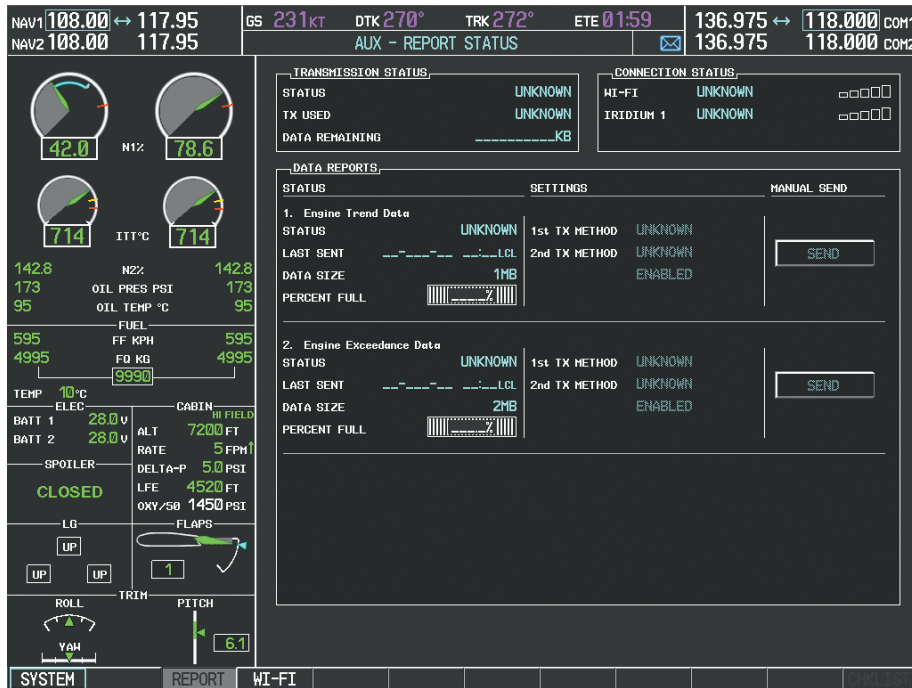

Figure 8-73 Report Status Page Selected Prior to System Registration

- 6) Press the **MENU** Key. The Page Menu window is now displayed as seen in Figure 8-74.
- 7) Select 'Register With GFDS' in the menu list.

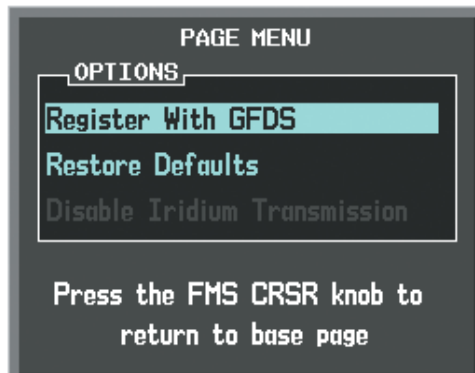

Figure 8-74 Select Register With GFDS



- 8) Press the **ENT** Key. The Garmin Flight Data Service Registration window is now displayed as shown in Figure 8-75.

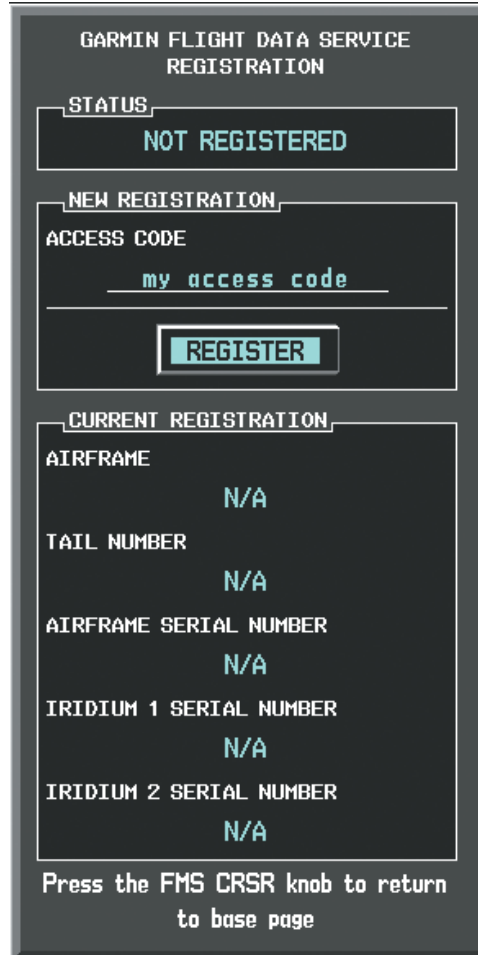

Figure 8-75 Enter Access Code

- 9) Enter the Access Code provided by Garmin Flight Data Services.
- 10) Press the **ENT** Key. REGISTER will now be highlighted as in Figure 8-75.
- 11) Press the **ENT** Key. System registration is complete when 'REGISTERED' is displayed in the STATUS field. Verify the information displayed in the CURRENT REGISTRATION window is correct.

## DISABLE/ENABLE IRIDIUM TRANSCIVER

Iridium telephone and data communications may be turned on or off by performing these simple steps.

### Disabling/enabling telephone and low speed data services:

- 1) Turn the large **FMS** Knob on the MFD to select the AUX page group.
- 2) Turn the small **FMS** Knob to select REPORTS/DATA LINK.
- 3) If necessary, select the **REPORTS** Softkey. The AUX-REPORT STATUS Page is now displayed as shown in Figure 8-76.

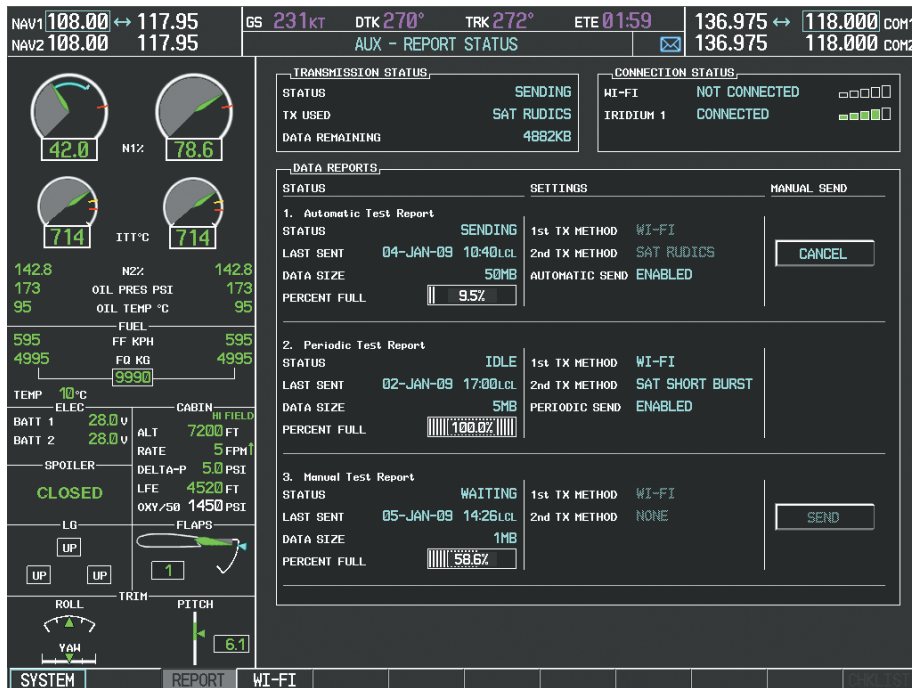

Figure 8-76 Report Status Page

- 4) Press the **MENU** Key. The Page Menu window is now displayed as seen in Figure 8-77.
- 5) Turn the **FMS** Knob to select 'Disable Iridium Transmission' in the menu list.

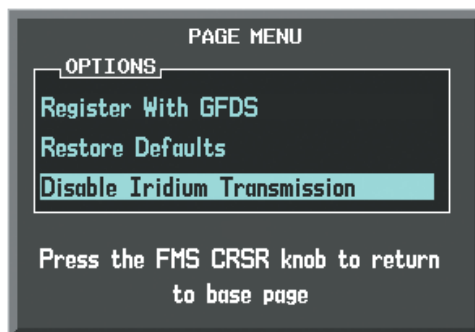

Figure 8-77 Select Disable Iridium Transmission

- 6) Press the **ENT** Key. The Iridium transceiver is now disabled.
- 7) To enable the Iridium transceiver, repeat steps 1 through 4, then select 'Enable Iridium Transceiver'.

**TELEPHONE COMMUNICATION**

The pilot or copilot can place and answer calls on the Iridium satellite network as well as to or from the telephone handset in the cabin. Calls can also be answered or made from the cabin phone, however, only actions initiated from the cockpit phone will be discussed here. See the cabin handset user guide for more information. Control and monitoring of telephone functions are accomplished through the AUX-TELEPHONE Page.

**Viewing the Telephone Page:**

- 1) Turn the large **FMS** Knob on the MFD to select the AUX page group.
- 2) Turn the small **FMS** Knob to select SATELLITE PHONE.
- 3) If necessary, select the **TEL** Softkey to display the AUX-TELEPHONE Page.

The PHONE STATUS display, as shown in Figure 8-78, gives a graphical representation of the current disposition of voice and/or data transmissions. Table 8-5 describes symbology used on Phone Status display.

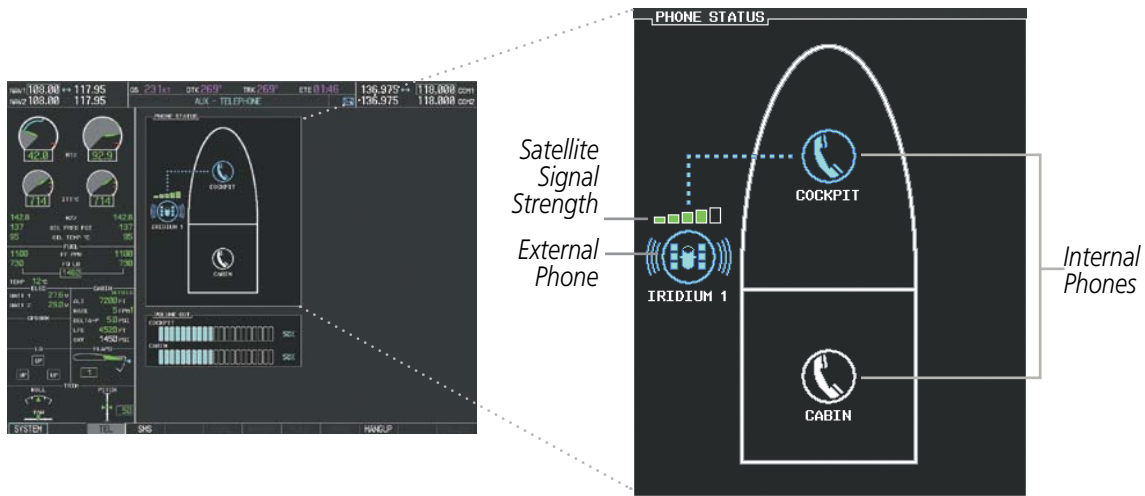

**Figure 8-78 Phone Status Display**



















Internal Phone	External Phone	Description
		Phone is Idle
		Phone is ringing
		Phone has a dial tone (off hook) or connected to another phone
		Phone dialed is busy
		Phone is dialing another phone
		Phone has failed
		Phone status not known
		Phone is disabled
		Phone is reserved for data transmission
		Calling other phone or incoming call from other phone
		Other phone is on hold
		Phones are connected

Table 8-5 Telephone Symbols

**INCOMING CALLS**

When viewing MFD pages other than the AUX-TELEPHONE Page, a pop-up alert similar to Figure 8-79 will be displayed and an aural alert “Incoming Call” will be heard. If the call is from the cabin, CABIN will be displayed as seen in Figure 8-79. If the incoming call is an Iridium network call, IRIDIUM will be displayed. The pop-up alert may be inhibited at times, such as during takeoff. In addition to the pop-up alert, a ringing phone symbol will be displayed to the right of the MFD page title as shown in Figure 8-79. Also, the voice alert “Incoming Call” will be heard on the selected cockpit audio.



**Figure 8-79 Incoming Call**

**Answering an incoming call in the cockpit:**

- 1) Press the **TEL** Key on the appropriate audio panel.
- 2) Select the **ANSWER** Softkey on the MFD.

**Or:**

While viewing the AUX-TELEPHONE Page:



**NOTE:** The Push-to-Talk switch is not utilized for telephone communication. The microphone is active after selecting the **ANSWER** Softkey, and stays active until the call is terminated.

- 1) Press the **TEL** Key on the appropriate audio panel.
- 2) Press the **MENU** Key to display the Page Menu.
- 3) Turn either **FMS** Knob to place the cursor on ‘Answer Incoming Call’.
- 4) Press the **ENT** Key.

Selecting the **IGNORE** Softkey will extinguish the pop-up window and leave the current call unanswered. Selecting the **IGNRE ALL** Softkey will extinguish the pop-up window for the current and all future incoming calls and leave the current call unanswered. Selecting the **TEL** Softkey will display the AUX-TELEPHONE Page allowing additional call information to be viewed before answering.

**Disabling incoming call alerts:**

- 1) With the AUX-TELEPHONE Page displayed, press the **MENU** Key on the MFD to display the Page Menu.
- 2) Turn either **FMS** Knob to place the cursor on ‘Disable Incoming Call Alerts’.
- 3) Press the **ENT** Key. The voice and pop-up alert will not be displayed now when an incoming call is received.

## OUTGOING CALLS

Voice calls can be made from the cockpit to the handset in the cabin, or to an external phone through the Iridium Satellite Network.

### Making a call to the cabin:

- 1) Press the **TEL** Key on the appropriate audio panel.
- 2) Select the **DIAL** Softkey on the MFD. A display similar to Figure 8-80 will be shown.

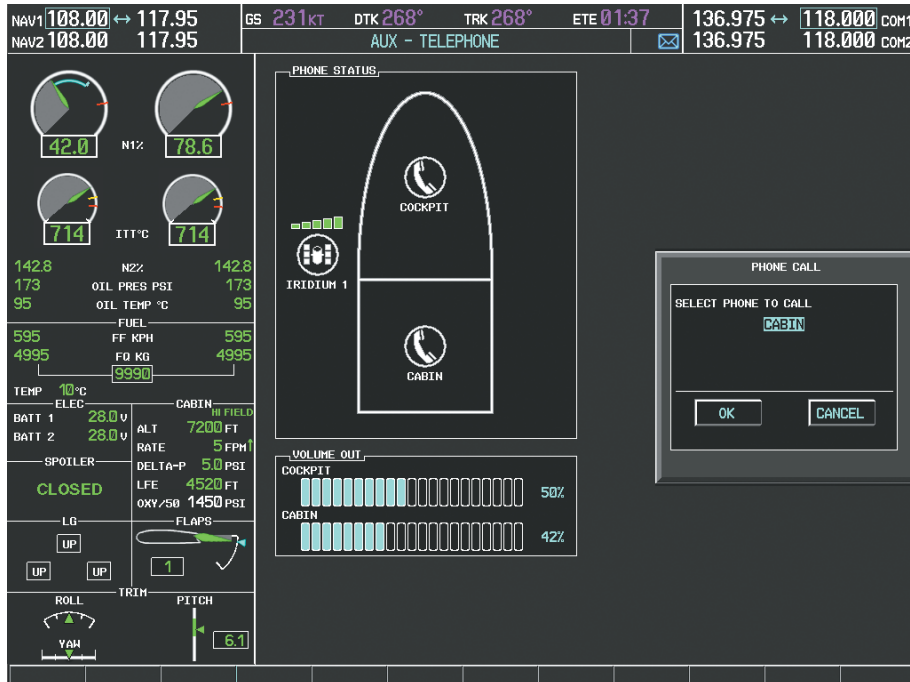
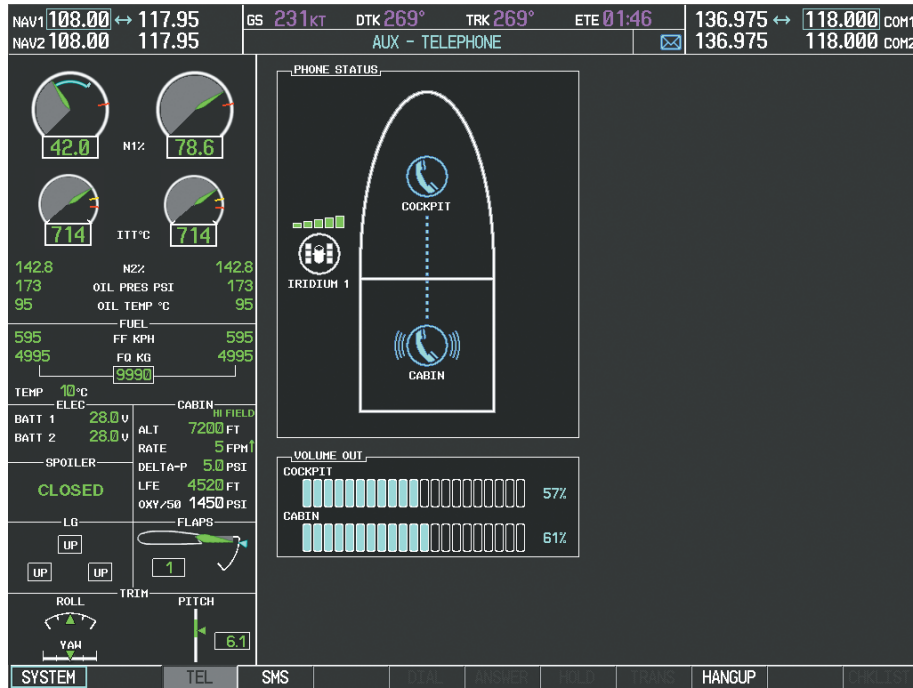

Figure 8-80 Initiating a Cabin Call

- 3) Press the **ENT** Key. The cursor will move from 'CABIN' to 'OK'.

4) Press the **ENT** Key again. The cabin phone will now ring as seen in Figure 8-81.



**Figure 8-81 Cabin Phone Ringing**

When the cabin phone is answered, the connection is established as shown in Figure 8-82. To exit the call, select the **HANGUP** Softkey.

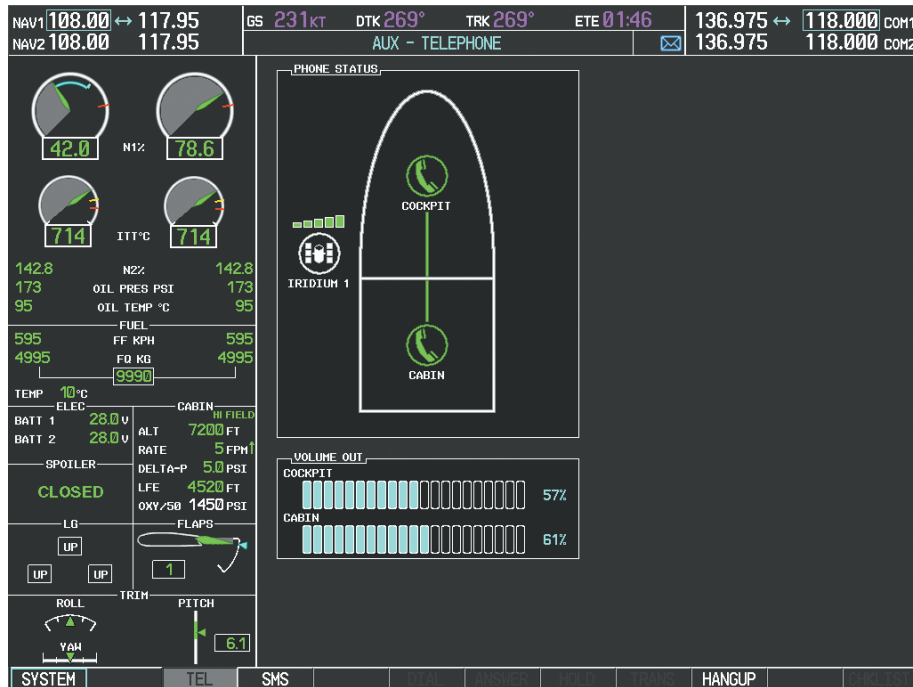

**Figure 8-82 Cabin Phone Answered**



Making an external call from the cockpit using the Iridium satellite network:

- 1) Press the **TEL** Key on the appropriate audio panel.
- 2) Select the **DIAL** Softkey on the MFD. A display similar to Figure 8-83 will be shown.

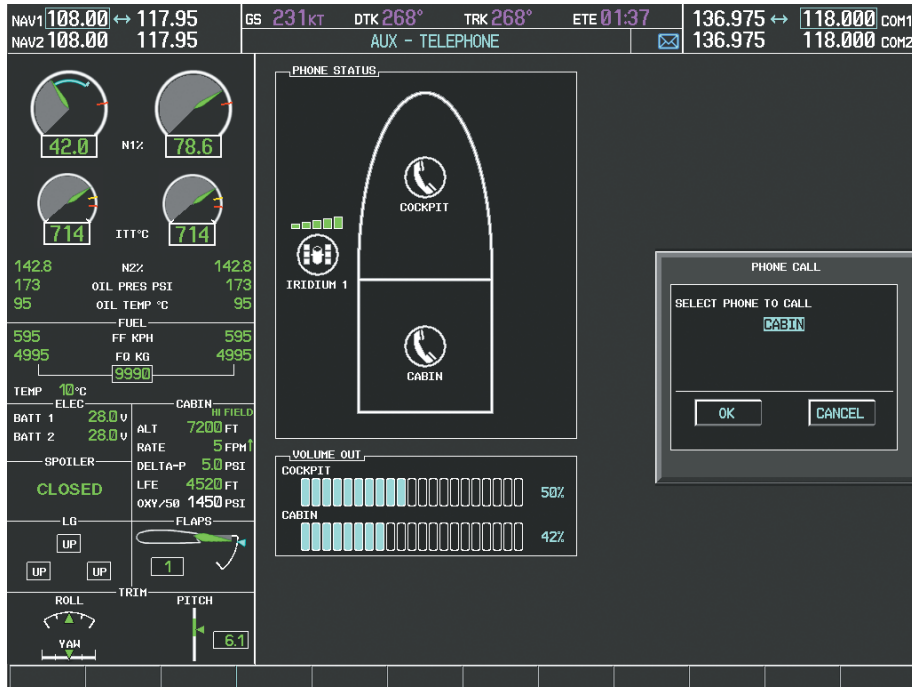

Figure 8-83 Initiating an External Call

- 3) Turn the small **FMS** Knob to select 'IRIDIUM' as seen in Figure 8-84.

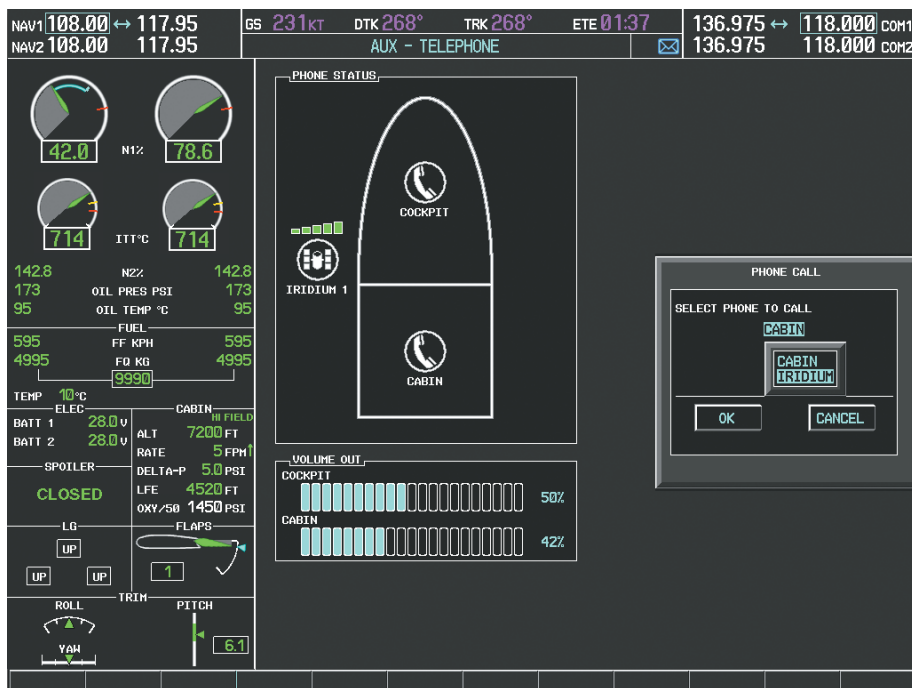
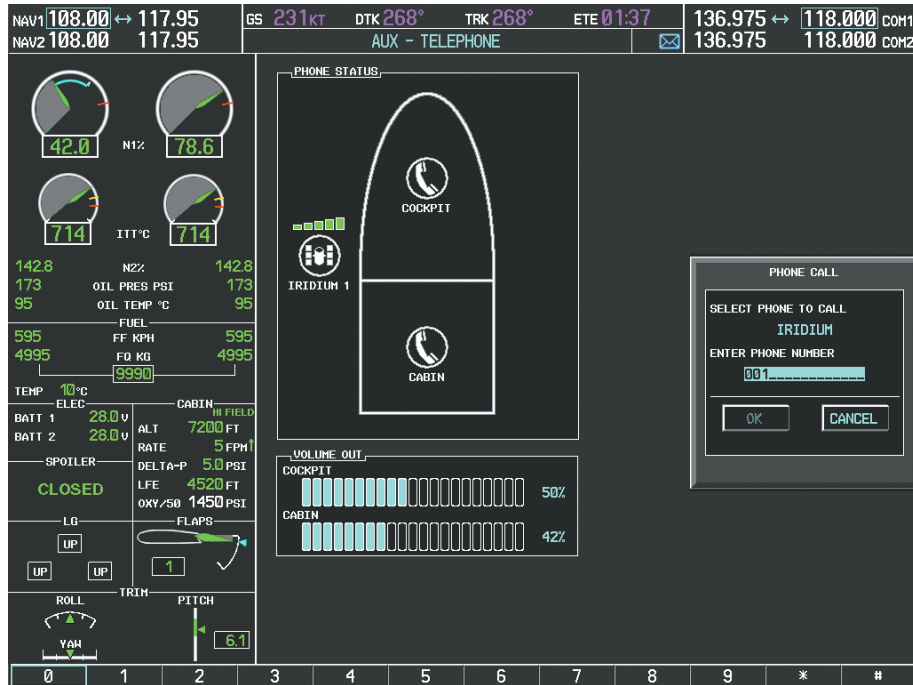

Figure 8-84 Selecting the Iridium Satellite System

- 4) Press the **ENT** Key. The cursor has now moved to the phone number entry field as shown in Figure 8-85.



**Figure 8-85 Enter Phone Number**

- 5) Enter the desired telephone number (country code first) by selecting the number softkeys on the MFD or by pressing the numeric keys on the MFD Control Unit.
- 6) Press the **ENT** Key. 'OK' is highlighted as in Figure 8-86.

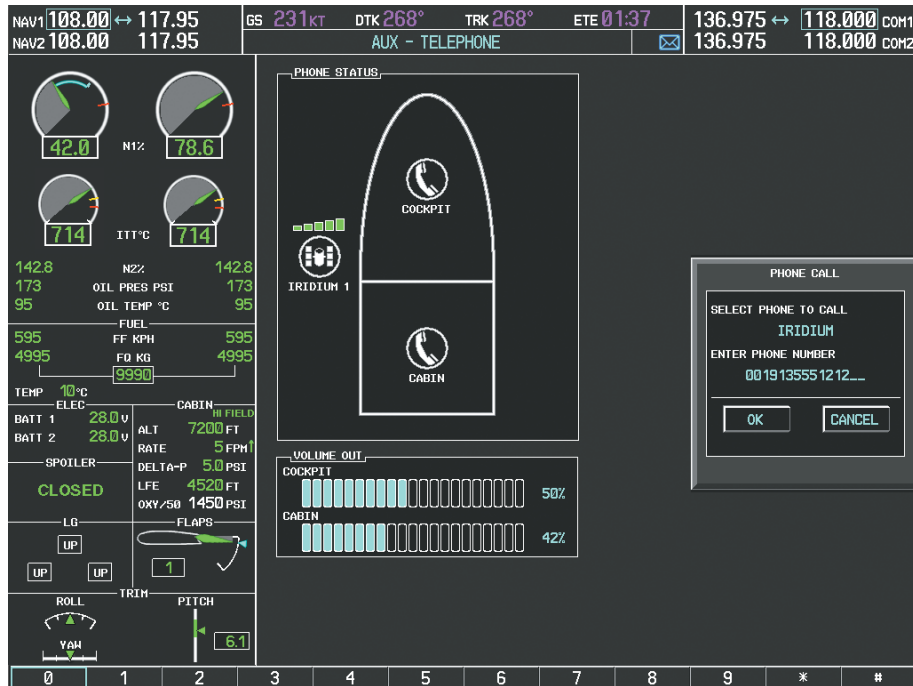

**Figure 8-86 Make the Call**

7) Press the **ENT** Key. The system will begin calling the number, as in Figure 8-87.

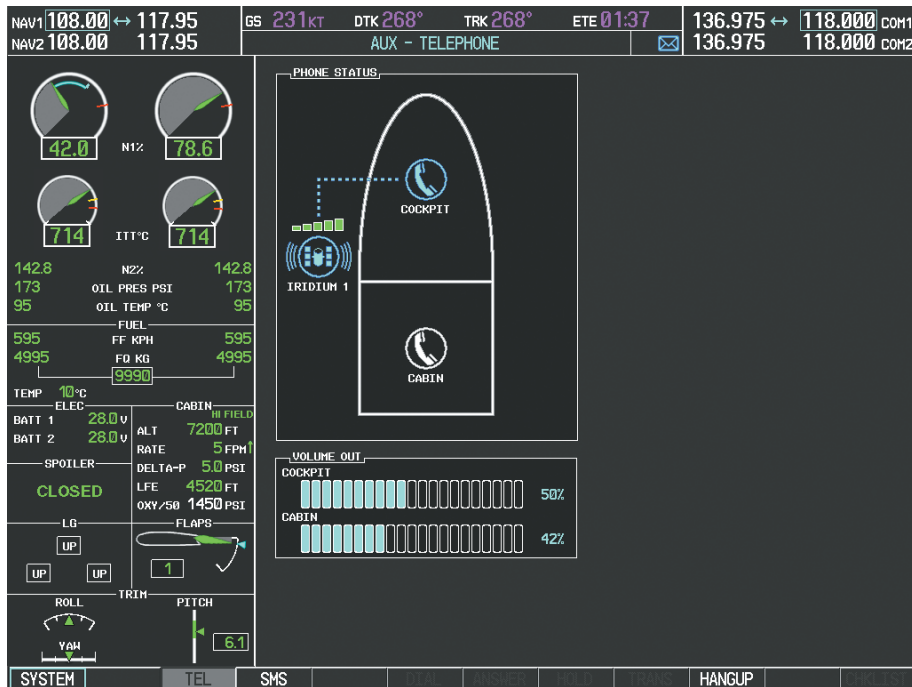

Figure 8-87 System is Making the Connection

When the phone is answered, the connection is established as shown in Figure 8-88. To exit the call, select the **HANGUP** Softkey.

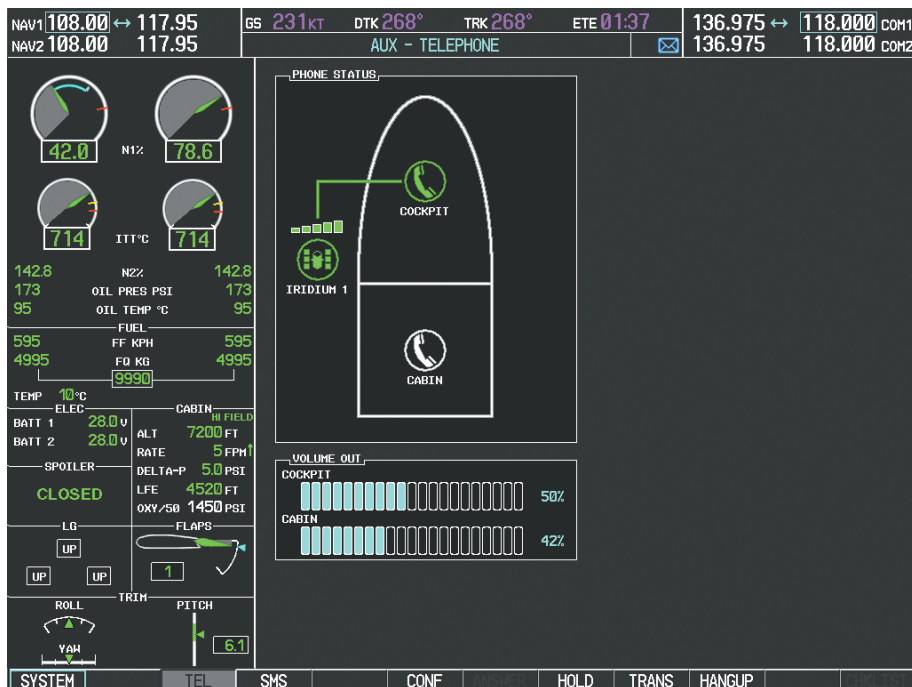

Figure 8-88 Phone is Answered, Connection Complete

## PLACING THE COCKPIT PHONE ON HOLD

### Placing a call on hold:

Select the **HOLD** Softkey on the MFD.

**Or:**

- 1) Press the **MENU** Key to display the Page Menu.
- 2) Turn either **FMS** Knob to place the cursor on 'Put Current Call On Hold'.
- 3) Press the **ENT** Key.

The cockpit phone is now isolated from the call as seen in Figure 8-89. This figure illustrates a conference call between the cockpit, cabin, and an external phone in which the cockpit phone has been put on hold. Select the **HOLD** Softkey again to resume the call.

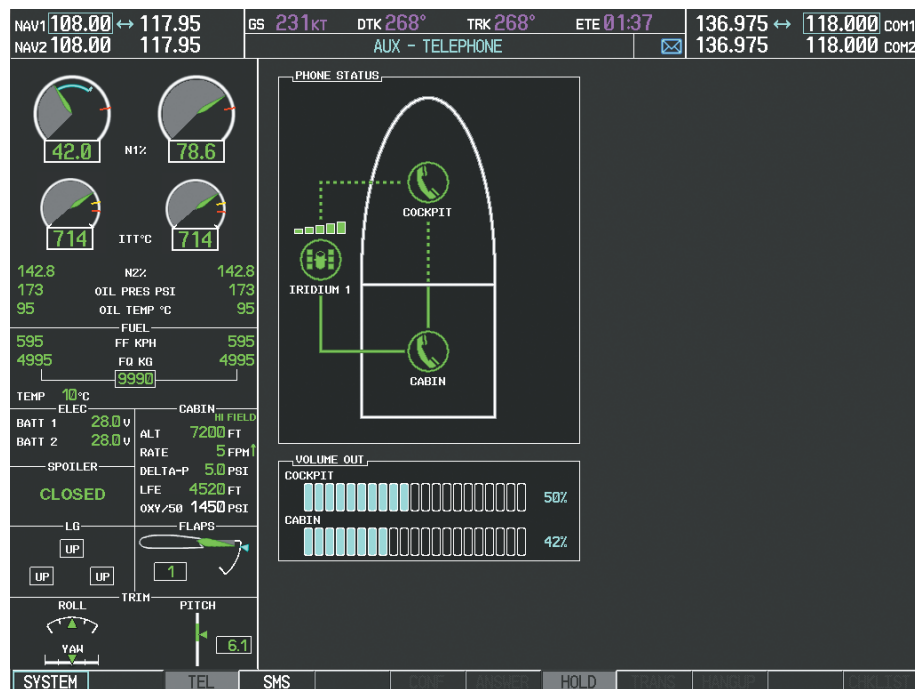

Figure 8-89 Cockpit Phone on Hold

## TRANSFERRING A CALL FROM THE COCKPIT

From the cockpit phone, an external call can be transferred to the cabin phone, or a call with the cabin phone can be transferred to an external phone, or (when two Iridium Transceivers are installed) an external call can be transferred to another external phone.

### Transferring a call:

- 1) Select the **TRANS** Softkey on the MFD.

Or:

- a) Press the **MENU** Key to display the Page Menu.
- b) Turn either **FMS** Knob to place the cursor on 'Transfer Current Call'.
- c) Press the **ENT** Key.

A window similar to that shown in Figure 8-90 will be displayed. In this example, an active call to the cabin is transferred to an external number. Therefore, the window shows the 'Iridium' option. If the active call is with an external phone, 'CABIN' would be the option.

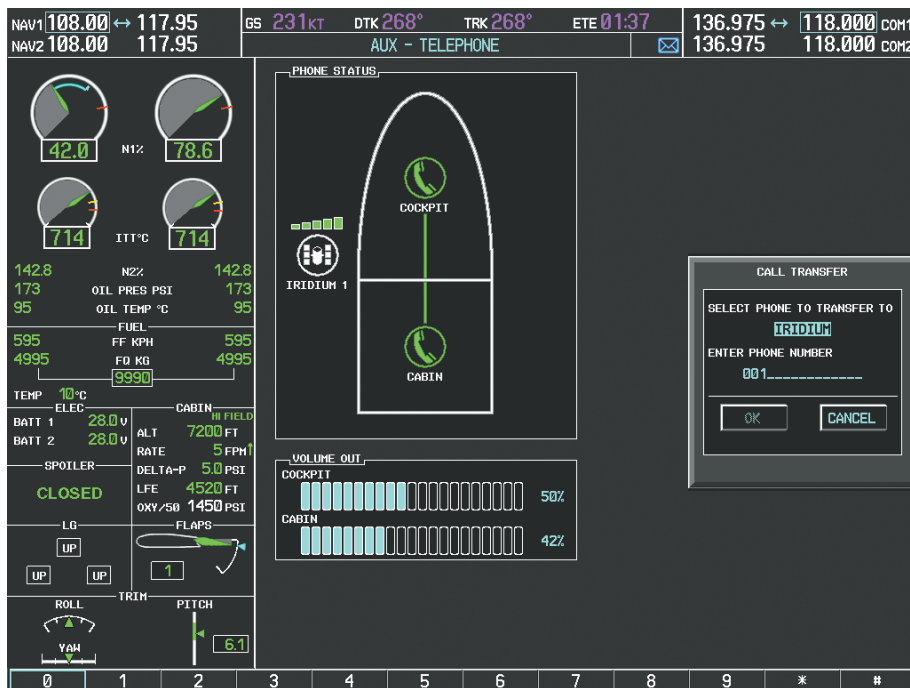
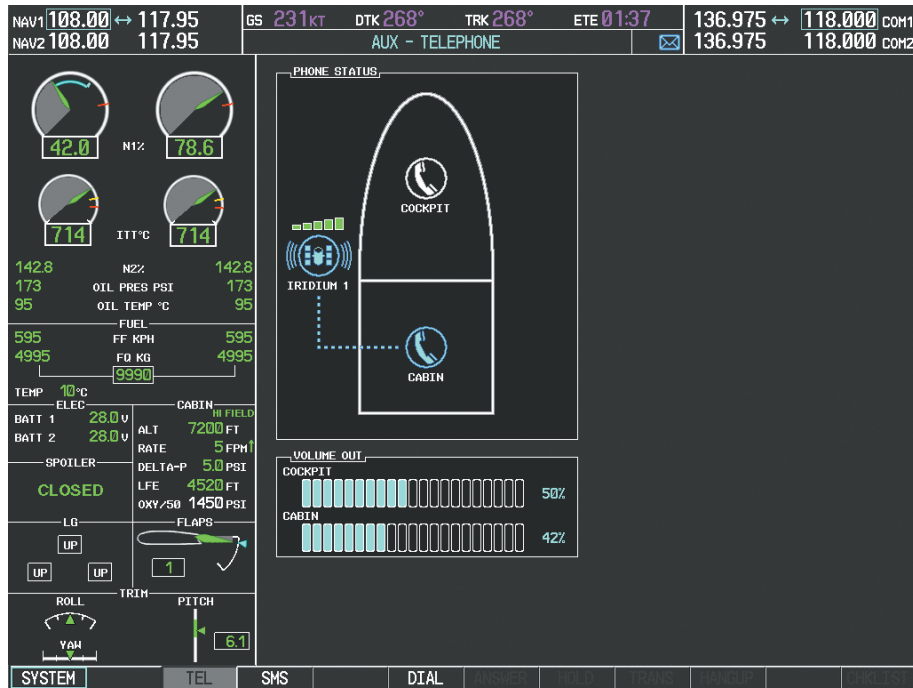

Figure 8-90 Enter Phone Number to Receive Transferred Call

- 2) Press the **ENT** Key. The cursor now highlights the phone number entry field.
- 3) Enter the phone number to which the call is being transferred, as discussed earlier for making an external call on the Iridium satellite network.
- 4) Press the **ENT** Key. 'OK' is now highlighted.



5) Press the **ENT** Key again to place the call as shown in Figure 8-91.



**Figure 8-91 Call Transfer to an External Phone**

When the external phone is answered, the call connection is indicated as in Figure 8-92.

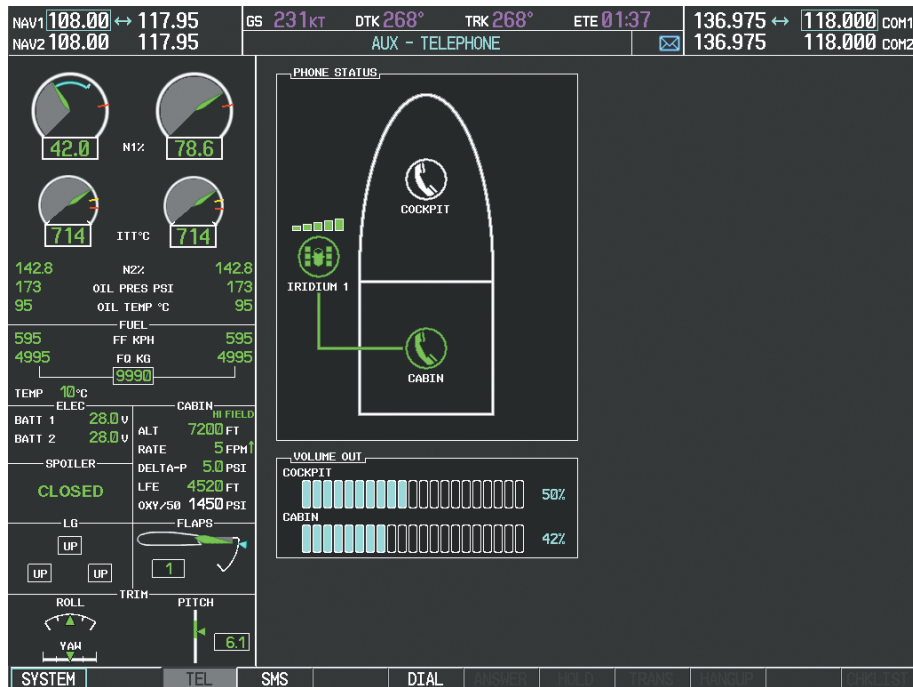

**Figure 8-92 Call Transfer Complete**

## MAKING A CONFERENCE CALL FROM THE COCKPIT

The cabin or an external phone (two external phones if two Iridium Transceivers are installed) can be added to a call already in progress.

### Adding another phone to an active call:

1) Select the **CONF** Softkey on the MFD.

Or:

a) Press the **MENU** Key to display the Page Menu.

b) Turn either **FMS** Knob to place the cursor on 'Conference Current Call'.

c) Press the **ENT** Key.

A window similar to that shown in Figure 8-93 will be displayed. In this example, an external phone will be added to an active call to the cabin. Therefore, the window shows the 'IRIDIUM' option. If the active call is with an external phone, 'CABIN' would be the option.

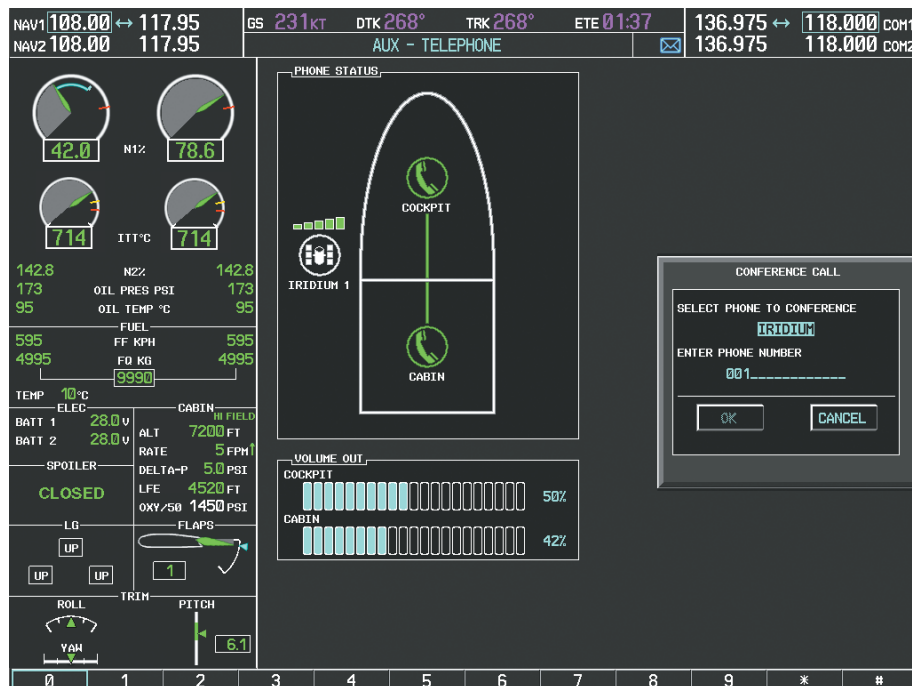
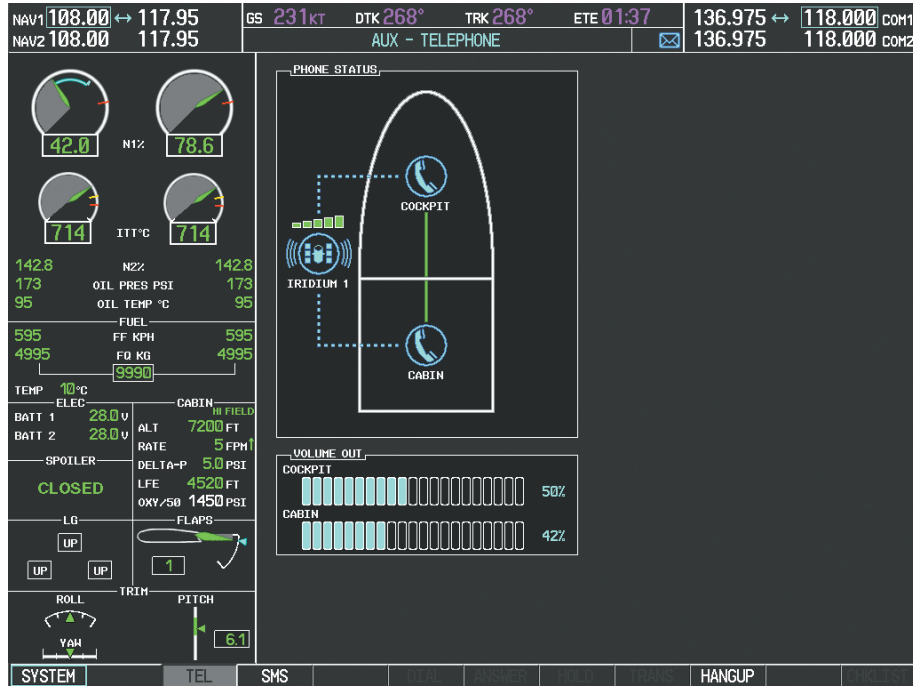

Figure 8-93 Initiate a Conference Call

- 2) Press the **ENT** Key. The cursor now highlights the phone number entry field.
- 3) Enter the phone number to be added to the call, as discussed earlier for making an external call on the Iridium satellite network.
- 4) Press the **ENT** Key. 'OK' is now highlighted.



5) Press the **ENT** Key again to place the call as shown in Figure 8-94.



**Figure 8-94 Conference in External Phone**

When the external phone is answered, the call connection is indicated as in Figure 8-95.

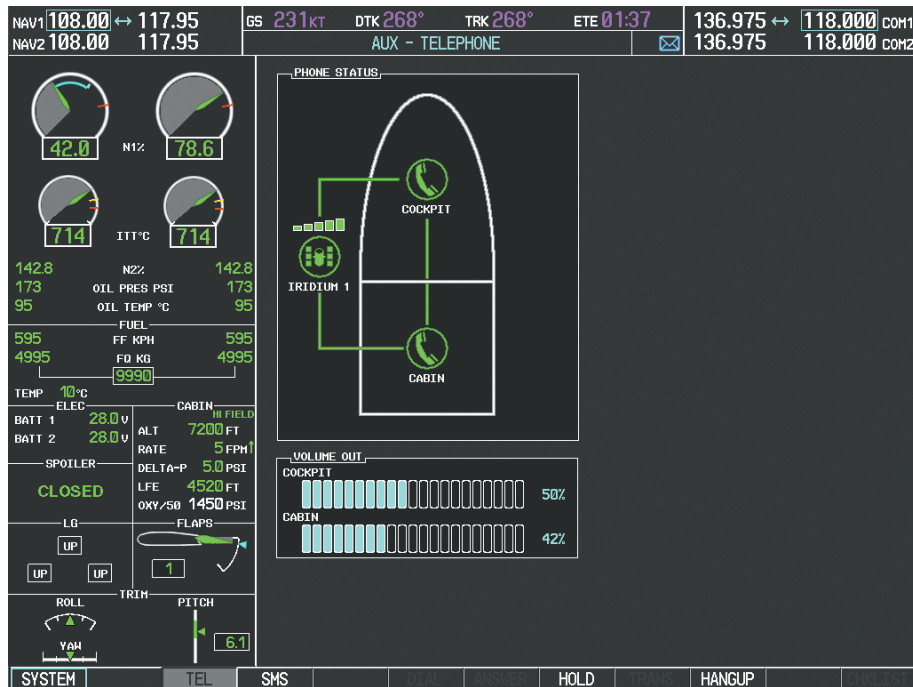

**Figure 8-95 External Phone Added**

## TEXT MESSAGING (SMS)

The pilot or copilot can send and receive text messages on the Iridium satellite network. Messages may be sent to an email address or text message capable cellular telephone. Message length is limited to 160 characters, including the email address.

The text messaging user interface is mainly through the AUX-TEXT MESSAGING Page.

### Viewing the Text Messaging Page:

- 1) Turn the large **FMS** Knob on the MFD to select the AUX page group.
- 2) Turn the small **FMS** Knob to select the SATELLITE PHONE.
- 3) If necessary, select the **SMS** Softkey to display the AUX-TEXT MESSAGING Page as shown in Figure 8-96.

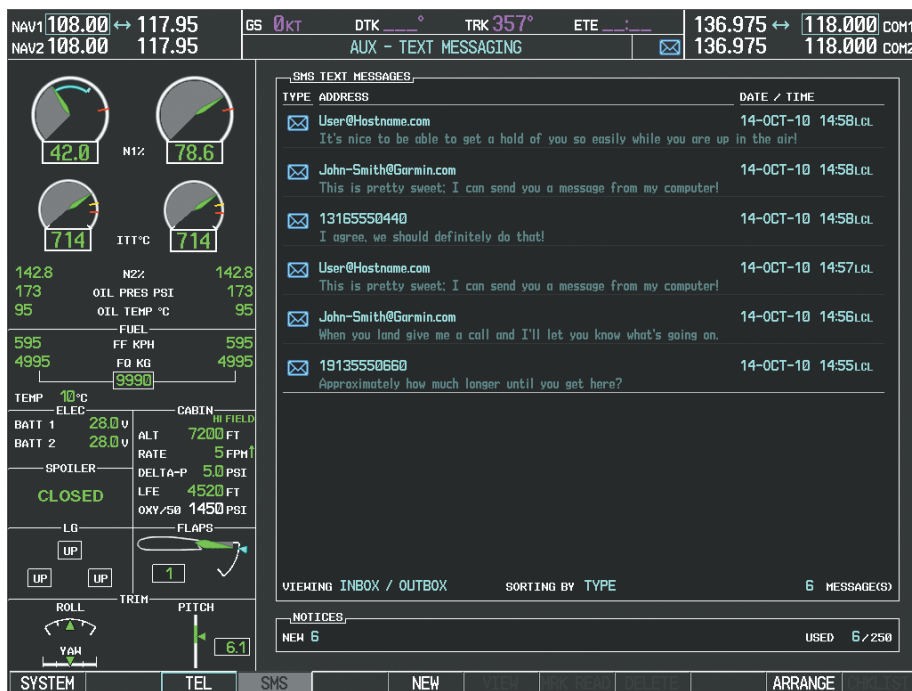

Figure 8-96 Text Messaging Page







Message Symbol	Description
	Received text message that has not been opened
	Received text message that has been opened
	Saved text message, draft not sent
	System is sending text message
	Text message has been sent
	System failed to send text message
	Predefined text message

Table 8-6 Text Message Symbols

### VIEWING A TEXT MESSAGE WHEN RECEIVED

When viewing MFD pages other than the AUX-TEXT MESSAGING Page, a pop-up alert similar to Figure 8-97 will be displayed when a new text message is received.



New Text Message Pop-up

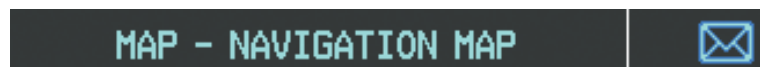

New Text Message Symbol on MFD Page

Figure 8-97 New Text Message Received

Select the **VIEW** Softkey to view the message (Figure 8-98). Selecting the **IGNORE** Softkey will extinguish the pop-up window and leave the text message unopened. Selecting the **IGNR ALL** Softkey will extinguish the pop-window and ignore all future incoming text messages. Selecting the **SMS** Softkey will display the AUX-TEXT MESSAGING Page.



Figure 8-98 Text Message Displayed from Pop-Up Alert

The pop-up alerts may be enabled or disabled through the Page Menu.

**Enabling/disabling incoming text message pop-up alerts:**

- 1) With the AUX-TEXT MESSAGING Page displayed, press the **MENU** Key on the MFD to display the Page Menu.
- 2) Turn either **FMS** Knob to place the cursor on 'Disable New Message Popups' or 'Enable New Message Popups'.
- 3) Press the **ENT** Key. The pop-up alert will not be displayed when an incoming text message is received.



Figure 8-99 Disabling New Text Message Pop-Ups

**REPLY TO A TEXT MESSAGE**

After reading a text message, a reply may be sent.

**Replying to a text message:**

While viewing the text message, select the **REPLY** Softkey.

**Or:**

- 1) Press the **MENU** Key to display the Page Menu.
- 2) Turn either **FMS** Knob to place the cursor on 'Reply To Message'.
- 3) Press the **ENT** Key.

## SENDING A TEXT MESSAGE

Text messages may be sent from the AUX-TEXT MESSAGING Page.

### Sending a new text message:

- 1) While viewing the AUX-TEXT MESSAGING Page, select the **NEW** Softkey.
- Or:
  - a) Press the **MENU** Key to display the Page Menu.
  - b) Turn either **FMS** Knob to place the cursor on 'Draft New Message'.
  - c) Press the **ENT** Key.

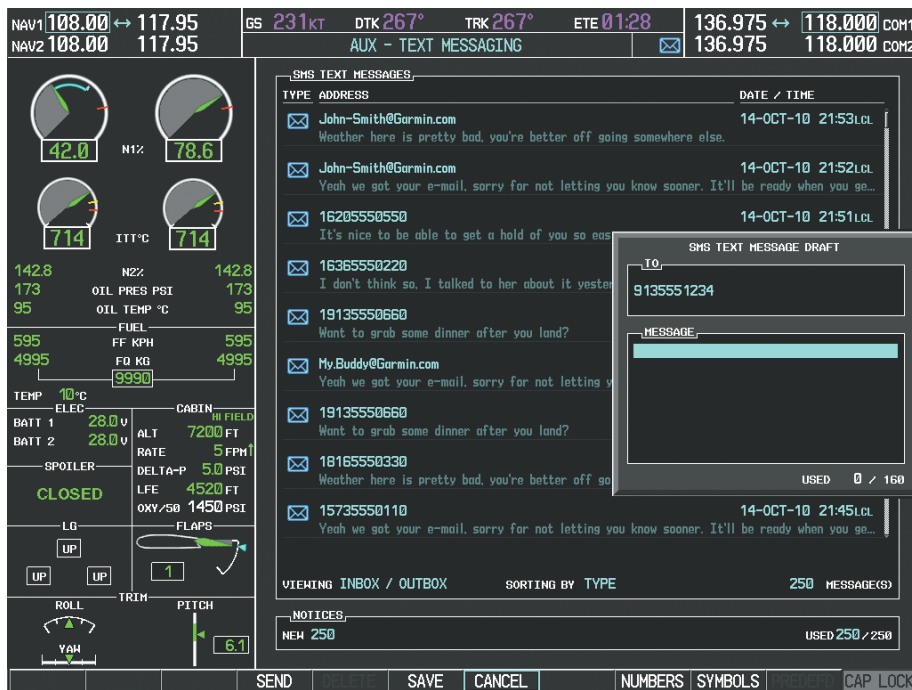

Figure 8-100 Composing a New Text Message

- 2) The TEXT MESSAGE DRAFT Window is now displayed with the cursor in the 'TO' field. Enter the desired telephone number or email address. Entry can be accomplished through the alphanumeric keys on the MFD Controller, or combination of the **FMS** Knob on the controller and softkeys on the MFD. The **FMS** Knob is used to enter letters and numbers, or numbers can be entered from the MFD by selecting the **NUMBERS** Softkey. Select the **CAP LOCK** Softkey to create upper and lower case alpha characters. Special characters can be accessed by selecting the **SYMBOLS** Softkey. See Figure 8-100.
- 3) Press the **ENT** Key. The cursor is now displayed in the 'MESSAGE' field.
- 4) Enter the desired message using any combination of entry methods as described in step 2.
- 5) Press the **ENT** Key.
- 6) Select the **SEND** Softkey to send the message immediately, or select the **SAVE** Softkey to save the message in Outbox for sending at a later time. Select the **CANCEL** Softkey to delete the message.

## PREDEFINED TEXT MESSAGES

Time and effort can be saved in typing text messages that are used repeatedly by saving these messages as a predefined message.

### Creating a predefined text message:

- 1) While viewing the AUX-TEXT MESSAGING Page, press the **MENU** Key to display the Page Menu.



Figure 8-101 Creating/Editing Predefined Messages

- 2) Turn either **FMS** Knob to select 'Edit Predefined Messages' as shown in Figure 8-101.
- 3) Press the **ENT** Key. The PREDEFINED MESSAGES view is now displayed.
- 4) Select the **NEW** Softkey.  
**Or:**
  - a) Press the **MENU** Key to display the Page Menu.
  - b) Turn either **FMS** Knob to place the cursor on 'Draft New Predefined Message'.



c) Press the **ENT** Key. The PREDEFINED SMS TEXT MESSAGE Window is now displayed as shown in Figure 8-102.

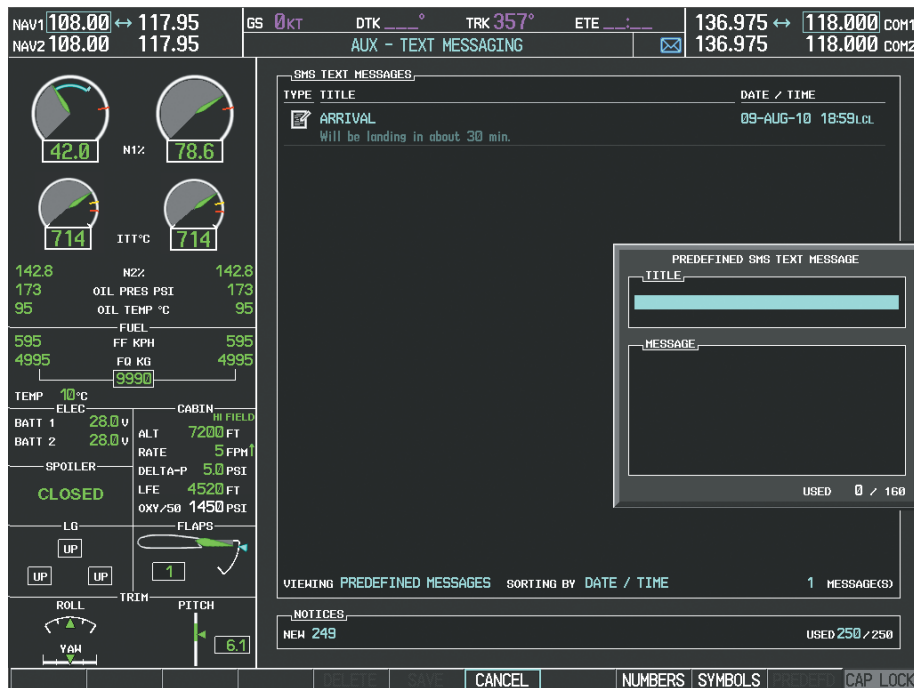

Figure 8-102 Composing a Predefined Message

- 5) The cursor is displayed in the 'TITLE' field. Enter the desired message title. Entry can be accomplished through the alphanumeric keys on the MFD Controller, or combination of the **FMS** Knob on the controller and softkeys on the MFD. The **FMS** Knob is used to enter letters and numbers, or numbers can be entered from the MFD by selecting the **NUMBERS** Softkey. Select the **CAP LOCK** Softkey to create upper and lower case alpha characters. Special characters can be accessed by selecting the **SYMBOLS** Softkey.
- 6) Press the **ENT** Key. The cursor is now displayed in the 'MESSAGE' field.
- 7) Enter the desired message using any combination of entry methods as described in step 5.
- 8) Press the **ENT** Key.
- 9) Select the **SAVE** Softkey. The new predefined message is now shown in the displayed list. Selecting the **CANCEL** Softkey will delete the message without saving.
- 10) Press the **MENU** Key to display the Page Menu.
- 11) Turn either **FMS** Knob to place the cursor on 'Stop Editing Predefined Message'.
- 12) Press the **ENT** Key.

**Sending a predefined text message:**

- 1) While viewing the AUX-TEXT MESSAGING Page, select the **NEW** Softkey.
- 2) The TEXT MESSAGE DRAFT Window is now displayed with the cursor in the 'TO' field. Enter the desired telephone number or email address. Entry can be accomplished through the alphanumeric keys on the MFD Controller, or combination of the **FMS** Knob on the controller and softkeys on the MFD. The **FMS** Knob is used to enter letters and numbers, or numbers can be entered from the MFD by selecting the **NUMBERS** Softkey. Select the **CAP LOCK** Softkey to create upper and lower case alpha characters. Special characters can be accessed by selecting the **SYMBOLS** Softkey. See Figure 8-103.

- 3) Press the **ENT** Key. The cursor is now displayed in the 'MESSAGE' field (Figure 8-103).

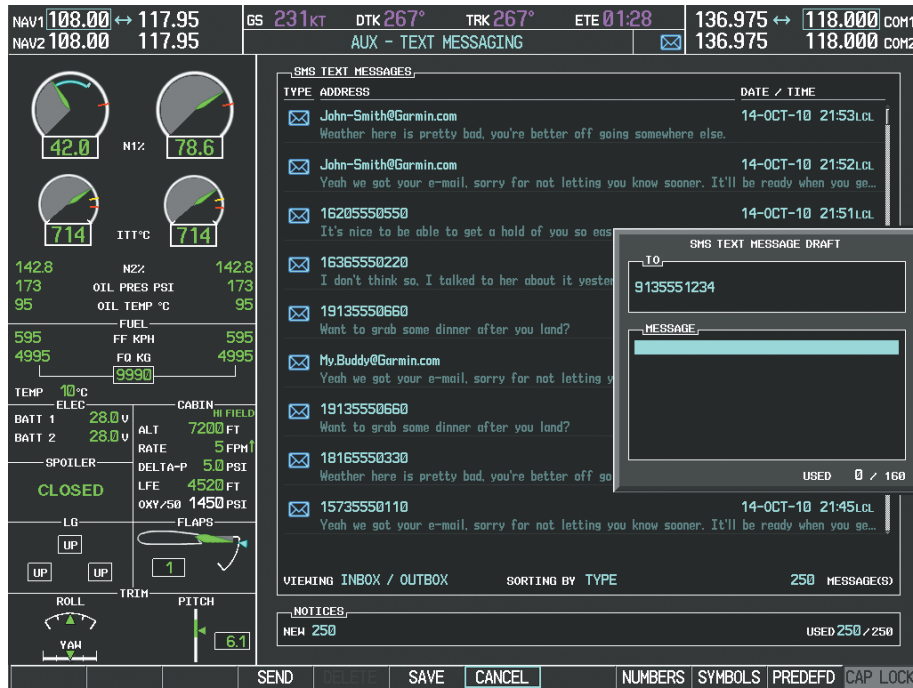

**Figure 8-103 Composing a New Text Message**

- 4) Select the **PREDEFD** Softkey. The PREDEFINED MESSAGE MENU Window is displayed as seen in Figure 8-104.

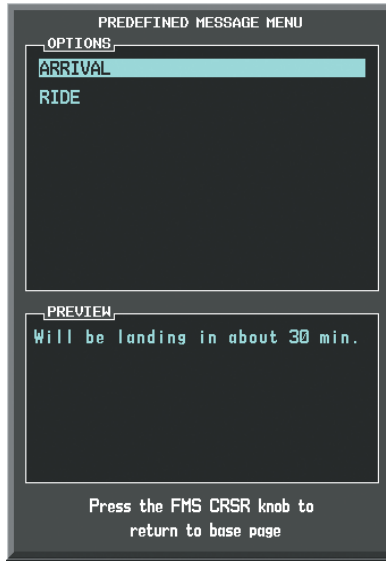

**Figure 8-104 Predefined Message List**

- 5) Turn either **FMS** Knob to select the desired predefined message.
- 6) Press the **ENT** Key. The predefined message text is inserted into the message field. If desired, the message can be edited by using the FMS Knobs.
- 7) Press the **ENT** Key.
- 8) Select the **SEND** Softkey to transmit the message.

## TEXT MESSAGE BOXES

Received text messages reside in the Inbox as 'Read' or 'Unread' messages. The Outbox contains 'Sent' and 'Unsent' text messages. Saved messages that are meant to be sent later are stored as Drafts. Each text message box may be viewed separately, or together in any combination.

### Show Inbox messages:

While viewing the AUX-TEXT MESSAGING Page, select the **ARRANGE** Softkey, then select the **INBOX** Softkey (Figure 8-105).

Or:

- 1) Press the **MENU** Key to display the Page Menu.
- 2) Turn either **FMS** Knob to place the cursor on 'Show Inbox Messages'.
- 3) Press the **ENT** Key. The message box selected for viewing is indicated at the bottom left of the list window.

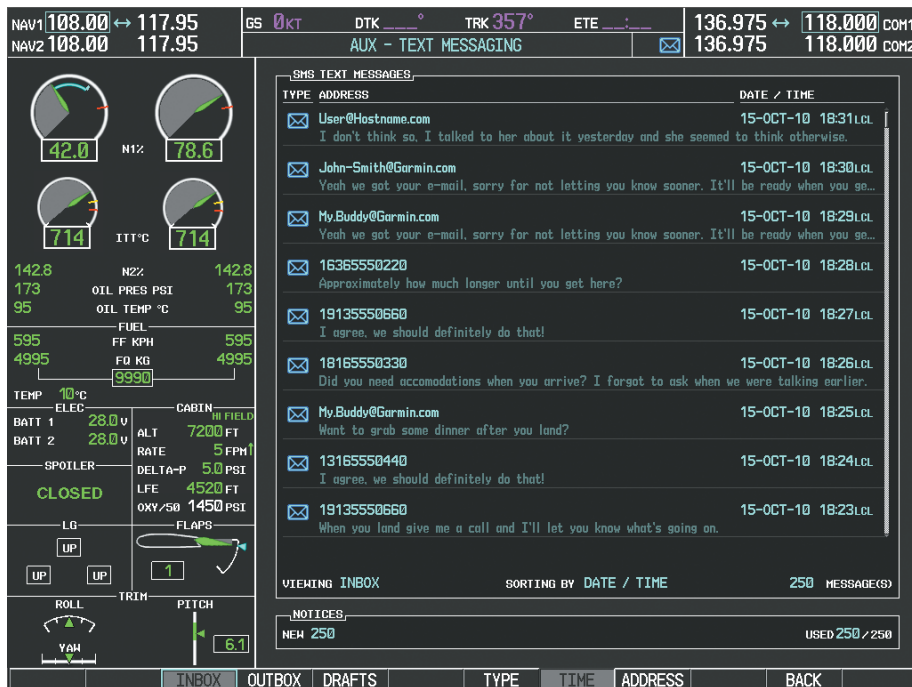

Figure 8-105 Text Message Inbox

### Show Outbox messages:

While viewing the AUX-TEXT MESSAGING Page, select the **ARRANGE** Softkey, then select the **OUTBOX** Softkey.

Or:

- 1) Press the **MENU** Key to display the Page Menu.
- 2) Turn either **FMS** Knob to place the cursor on 'Show Outbox Messages'.
- 3) Press the **ENT** Key. The message box selected for viewing is indicated at the bottom left of the list window.

**Show Draft messages:**

While viewing the AUX-TEXT MESSAGING Page, select the **ARRANGE** Softkey, then select the **DRAFTS** Softkey.

**Or:**

- 1) Press the **MENU** Key to display the Page Menu.
- 2) Turn either **FMS** Knob to place the cursor on 'Show Draft Messages'.
- 3) Press the **ENT** Key. The message box selected for viewing is indicated at the bottom left of the list window.

**MANAGING TEXT MESSAGES**

The viewed messages may be listed according to the date/time the message was sent or received, the type of message (read, unread, sent, unsent, etc.), or by message address.

**Viewing messages sorted by message date/time:**

While viewing the AUX-TEXT MESSAGING Page, select the **ARRANGE** Softkey, then select the **TIME** Softkey (Figure 8-105).

**Or:**

- 1) Press the **MENU** Key to display the Page Menu.
- 2) Turn either **FMS** Knob to place the cursor on 'Sort By Date/Time'.
- 3) Press the **ENT** Key. The sorting selection is indicated at the bottom center of the list window (Figure 8-105).

**Viewing messages sorted by message type:**

While viewing the AUX-TEXT MESSAGING Page, select the **ARRANGE** Softkey, then select the **TYPE** Softkey.

**Or:**

- 1) Press the **MENU** Key to display the Page Menu.
- 2) Turn either **FMS** Knob to place the cursor on 'Sort By Type'.
- 3) Press the **ENT** Key. The sorting selection is indicated at the bottom center of the list window.

**Viewing messages sorted by address:**

While viewing the AUX-TEXT MESSAGING Page, select the **ARRANGE** Softkey, then select the **ADDRESS** Softkey.

**Or:**

- 1) Press the **MENU** Key to display the Page Menu.
- 2) Turn either **FMS** Knob to place the cursor on 'Sort By Address'.
- 3) Press the **ENT** Key. The sorting selection is indicated at the bottom center of the list window.

**Viewing the content of a text message:**

- 1) While viewing the AUX-TEXT MESSAGING Page, select the desired message box.
- 2) Press the **FMS** Knob to activate the cursor.
- 3) Turn either **FMS** Knob to select the desired message.
- 4) Select the **VIEW** Softkey.

**Or:**

Press the **ENT** Key.

**Or:**

- a) Press the **MENU** Key to display the Page Menu.
- b) Turn either **FMS** Knob to place the cursor on 'View Selected Message'.
- c) Press the **ENT** Key.

Message content is displayed as shown in Figure 8-106.

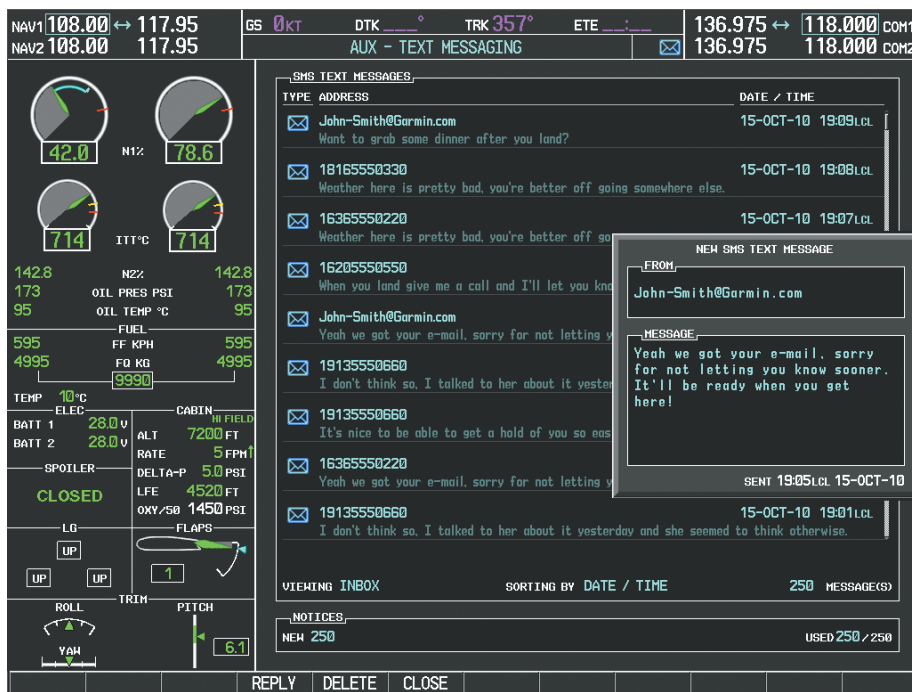

Figure 8-106 Viewing Message Content

- 5) To close the text message, select the **CLOSE** Softkey.

**Or:**

- a) Press the **MENU** Key to display the Page Menu.
- b) Turn either **FMS** Knob to place the cursor on 'Close Message'.
- c) Press the **ENT** Key.

**Marking selected message as read:**

- 1) While viewing the Inbox on the AUX-TEXT MESSAGING Page, press the **FMS** Knob to activate the cursor.
- 2) Turn either **FMS** Knob to select the desired message.
- 3) Select the **MRK READ** Softkey.

**Or:**

- a) Press the **MENU** Key to display the Page Menu.
- b) Turn either **FMS** Knob to place the cursor on 'Mark Selected Message As Read'.
- c) Press the **ENT** Key.

The message symbol now indicates the message has been opened.

**Marking all messages as read:**

- 1) While viewing the Inbox on the AUX-TEXT MESSAGING Page, press the **MENU** Key to display the Page Menu.
- 2) Turn either **FMS** Knob to place the cursor on 'Mark All New Messages As Read'.
- 3) Press the **ENT** Key. A confirmation window is displayed.
- 4) With cursor highlighting 'YES', press the **ENT** Key. The message symbols now indicate all the message have been opened.

**Delete a message:**

- 1) While viewing the Inbox on the AUX-TEXT MESSAGING Page, press the **FMS** Knob to activate the cursor.
- 2) Turn either **FMS** Knob to select the desired message.
- 3) Select the **DELETE** Softkey.

**Or:**

- a) Press the **MENU** Key to display the Page Menu.
- b) Turn either **FMS** Knob to place the cursor on 'Delete Selected Message'.
- c) Press the **ENT** Key.

## WI-FI CONNECTIONS

The system can connect to a IEEE 802.11g compatible network provided the aircraft is on the ground and located within range of the network. The system is capable of WEP64, WEP128, WPA-PSK, and WPA2-PSK encryption formats. WPA-Enterprise and WPA2-Enterprise are not supported. Connections that require web proxies, captive portals, or other elements that require user credentials, including a username and password or a redemption or access code; or require action such as accepting a user agreement, are not supported.

Control and monitoring of Wi-Fi functions are accomplished through the AUX-WI-FI SETUP Page.

### Viewing the Wi-Fi Setup Page:

- 1) Turn the large **FMS** Knob on the MFD to select the AUX page group.
- 2) Turn the small **FMS** Knob to select REPORTS/DATA LINK.
- 3) If necessary, select the **WI-FI** Softkey to display the AUX-WI-FI SETUP Page as shown in Figure 8-107.

### Setting up a new Wi-Fi connection:

- 1) Select the **AVAIL** Softkey on the MFD. A list of available networks will be displayed in the AVAILABLE NETWORKS window as shown in Figure 8-107. Signal strength is shown for each network, as well as security methods and whether the network has been saved in the system’s memory.



Figure 8-107 Available Wi-Fi Networks

- 2) If necessary, select the **RESCAN** Softkey to have the system scan again for available networks.

Or:

- a) Press the **MENU** Key to display the Page Menu.
- b) Turn either **FMS** Knob to place the cursor on 'Rescan Available Networks'.
- c) Press the **ENT** Key.



- 3) Press the **FMS** Knob to place the cursor in the list of networks.
- 4) Turn either **FMS** Knob to select the desired network. See Figure 8-108.



**Figure 8-108 Desired Network Selected**

- 5) Select the **CONNECT** Softkey.
  - Or:
  - a) Press the **MENU** Key to display the Page Menu.
  - b) Turn either **FMS** Knob to place the cursor on 'Connect To Selected Network'.
  - c) Press the **ENT** Key.
- 6) If the network is secured, a window similar to Figure 8-109 will be displayed in order to enter the necessary passcode. Use the **FMS** Knobs to enter the desired alpha numeric characters. Select the **CAP LOCK** Softkey to enter upper case letters. If there is no security associated with the network, proceed to step 9.



**Figure 8-109 Enter Security Code**

- 7) Press the **ENT** Key. 'OK' will be highlighted.
- 8) Press the **ENT** Key again.
- 9) The SAVE SETTINGS window is now displayed with the cursor highlighting 'SAVE CONNECTION'.

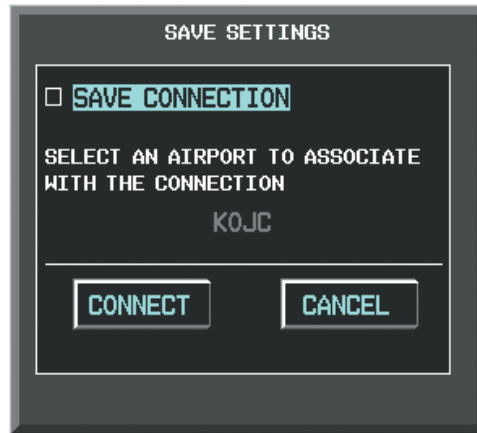

Figure 8-110 Save Option

- 10) The selected network can be saved to system memory to make re-connection easier at a later time.

Connecting the selected network without saving:

- a) Turn the large FMS Knob to move the cursor to highlight 'CONNECT'.
- b) Press the **ENT** Key.

Saving and connecting the selected network:

- a) Press the **ENT** Key. A checkmark is placed in the checkbox and the cursor moves to the airport field as shown in Figure 8-111.
- b) Using the **FMS** Knobs, enter an airport identifier to be associated with the saved network. This aids in identifying the network later in the event of duplicate network names.
- c) Press the **ENT** Key. The cursor moves to 'CONNECT'.
- d) Press the **ENT** Key again to connect to the selected network.

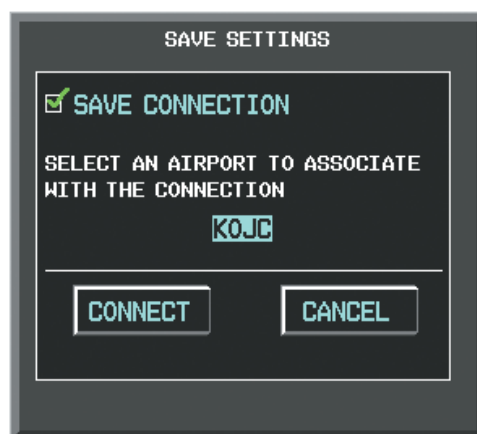

Figure 8-111 Save Connection

**Editing a saved network:**

- 1) While viewing list of saved networks, press the **FMS** Knob to activate the cursor as seen in Figure 8-112.
- 2) Turn either **FMS** Knob to highlight the network to be edited.
- 3) Pressing the **ENT** Key at this point will check or uncheck the AUTO CONNECT checkbox. When a checkmark is present, the system will automatically connect to the network when within range.



**Figure 8-112 Select Network to be Edited**

- 4) Select the **EDIT** Softkey. The cursor now appears in the CONNECTION SETTINGS window as shown in Figure 8-113.



**Figure 8-113 Select Attributes to Edit**

- 5) Turn the large **FMS** Knob to select the network attribute to be edited.
- 6) Turn the small **FMS** Knob to begin editing the field.
- 7) When the entry is complete, press the **ENT** Key.
- 8) Turn the large **FMS** Knob or press the **ENT** Key until 'SAVE' is highlighted.
- 9) Press the **ENT** Key.

### **Disconnecting a Wi-Fi network:**

Select the **DISCNCT** Softkey.

**Or:**

- 1) Press the **MENU** Key to display the Page Menu.
- 2) Turn either **FMS** Knob to place the cursor on 'Disconnect From Network'.
- 3) Press the **ENT** Key.

### **Deleting a saved Wi-Fi network:**

- 1) While viewing the list of saved networks, press the **FMS** Knob to activate the cursor.
- 2) Turn either **FMS** Knob to highlight the network to be deleted.
- 3) Select the **DELETE** Softkey. The selected network is removed from the list.

**SYSTEM DATA LOGGING**



**NOTE:** An account must be established with Garmin Flight Data Services to make full use of the System Data Logging feature.

The system provides recording of CAS and CMC messages that occur while the aircraft is on the ground or in flight, including engine trend and exceedance data, as well as aircraft position and flight phase transition logs. The logged data will include the message time and the message state (active, inactive or inhibited).

Additionally, the system is capable of logging data packets from the High Speed Data Bus.

The recorded data is then assembled into reports that can be transmitted to Garmin Flight Data Services using any of three data transmission methods (Wi-Fi, Iridium RUDICS, and Iridium Short Burst Data). The system selects the appropriate transmission method based on parameters set by the aircraft manufacturer and communication network availability. Data transmission may be initiated manually when the airplane is on the ground.

If report transmission is interrupted for some reason (e.g. networks unavailable, hardware failure, loss of power), the system will attempt to resume sending the reports at the next opportunity. The system ensures the complete data set is transmitted.

Transmitted reports remain in the system’s memory until they are overwritten by newer data.

Control and monitoring of report transmissions is accomplished through the AUX-REPORT STATUS Page as seen in Figure 8-114.

**Viewing the Report Status Page:**

- 1) Turn the large **FMS** Knob on the MFD to select the AUX page group.
- 2) Turn the small **FMS** Knob to select REPORTS/DATA LINK.
- 3) If necessary, select the **REPORT** Softkey to display the AUX-REPORT STATUS Page.

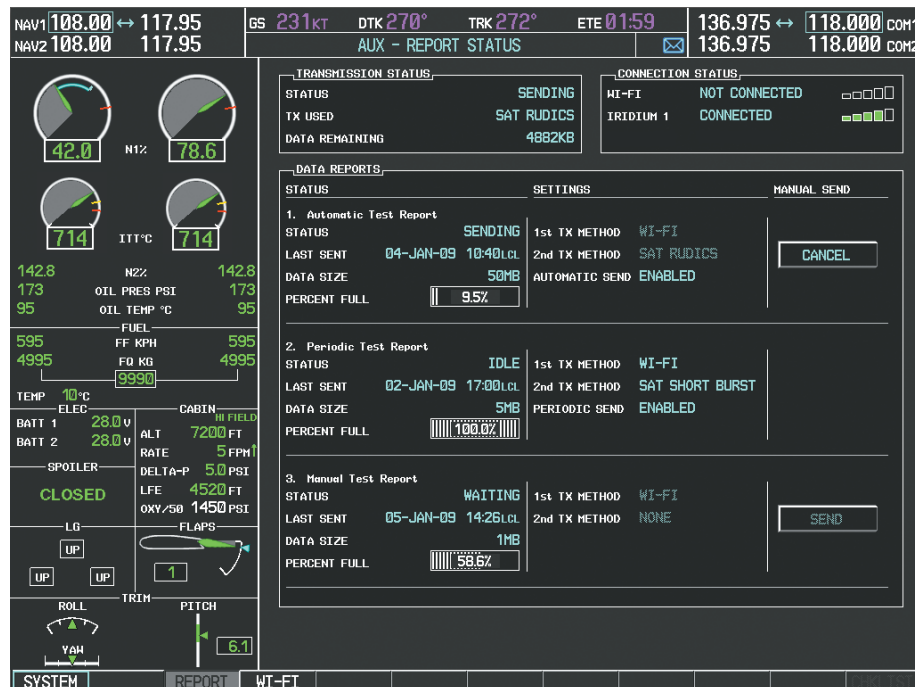

Figure 8-114 Report Status Page

**Changing transmission method:**

- 1) While viewing the Report Status Page, press the **FMS** Knob to activate the cursor.
- 2) Turn the large **FMS** Knob to move the cursor to the 1st or 2nd transmit method for the desired data report.
- 3) Turn the small **FMS** Knob to select the desired option (SAT SHORT BURST, SAT RUDICS, WI-FI, or NONE) as shown in Figure 8-115. Sat Short Burst is generally used for transmission of data packets less than 300 bytes. Wi-Fi is used only when the aircraft on the ground and the system is connected to a Wi-Fi network.
- 4) Press the **ENT** Key.

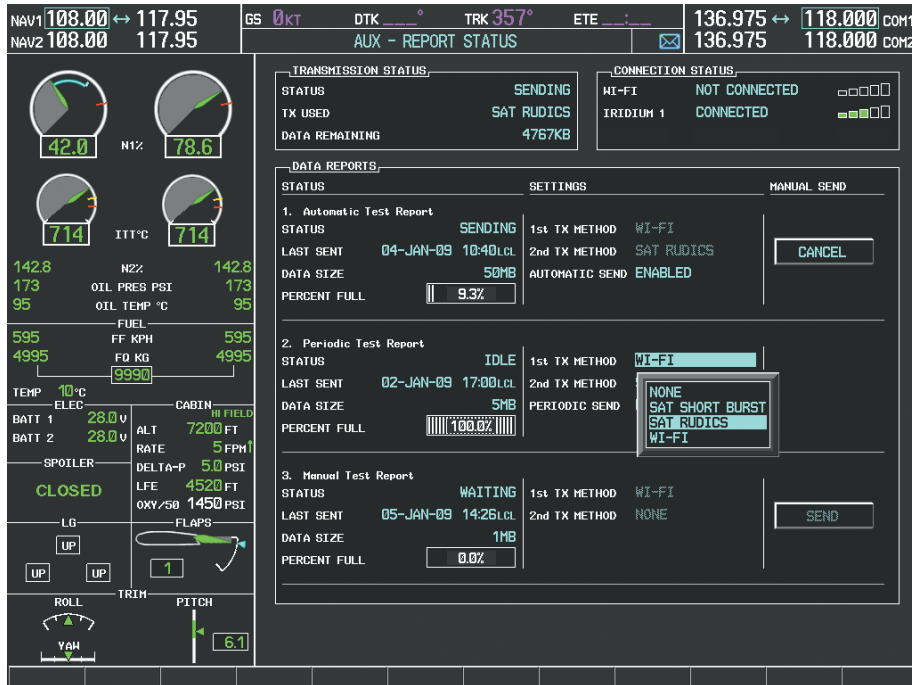

Figure 8-115 Select Transmission Method

**Enabling/disabling automatic send for Automatic Test Reports:**

- 1) While viewing the Report Status Page, press the **FMS** Knob to activate the cursor.
- 2) Turn the large **FMS** Knob to move the cursor to the AUTOMATIC SEND field.
- 3) Turn the small **FMS** Knob to select ENABLED or DISABLED.
- 4) Press the **ENT** Key.

**Enabling/disabling periodic send for Periodic Test Reports:**

- 1) While viewing the Report Status Page, press the **FMS** Knob to activate the cursor.
- 2) Turn the large **FMS** Knob to move the cursor to the PERIODIC SEND field.
- 3) Turn the small **FMS** Knob to select ENABLED or DISABLED.
- 4) Press the **ENT** Key.

**Sending a transmission manually:**



**NOTE:** Manual transmission of data can only be performed while the aircraft is on the ground.

- 1) While viewing the Report Status Page, press the **FMS** Knob to activate the cursor.
- 2) Turn the large **FMS** Knob to move the cursor to the SEND button on the desired data report.
- 3) Press the **ENT** Key.

**Sending all unsent data:**

- 1) While viewing the Report Status Page, press the **FMS** Knob to activate the cursor.
- 2) Turn the large **FMS** Knob to move the cursor to the SEND button on the desired data report.
- 3) Press the **ENT** Key. The Send Report window is displayed as shown in Figure 8-116.
- 4) Turn the large **FMS** Knob to highlight the 'SELECT DATA TO SEND' field.
- 5) Turn the small **FMS** Knob to select 'ALL UNSENT DATA'.
- 6) Press the **ENT** Key.

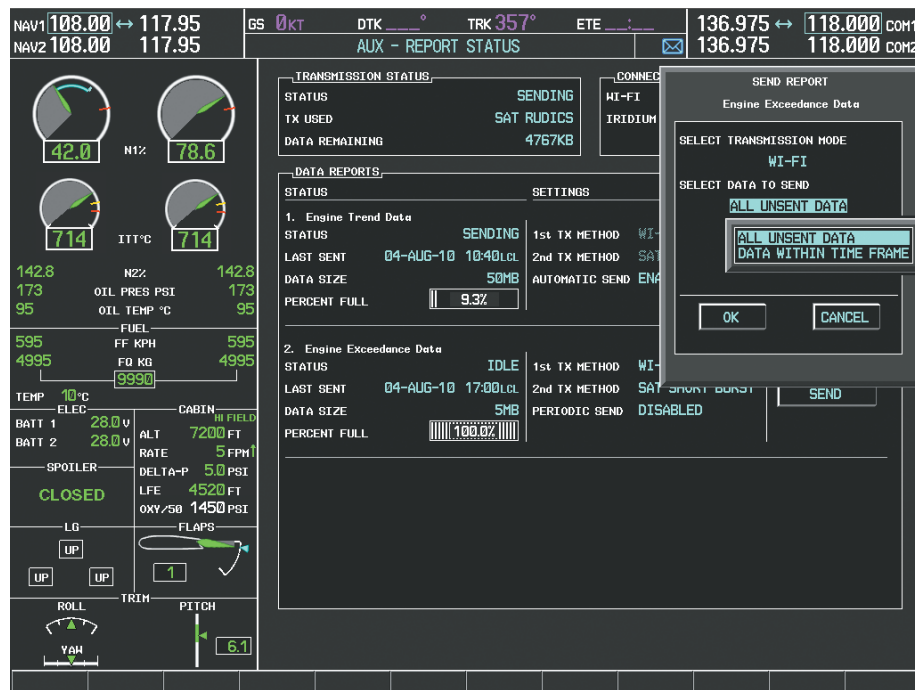

Figure 8-116 Select Data to Send



Re-sending data or sending data recorded in a specific time frame:

- 1) While viewing the Report Status Page, press the **FMS** Knob to activate the cursor.
- 2) Turn the large **FMS** Knob to move the cursor to the SEND button on the desired data report.
- 3) Press the **ENT** Key. The Send Report window is displayed as shown in Figure 8-117.
- 4) Turn the large **FMS** Knob to highlight the 'SELECT DATA TO SEND' field.
- 5) Turn the small **FMS** Knob to select 'DATA WITHIN TIME FRAME'.

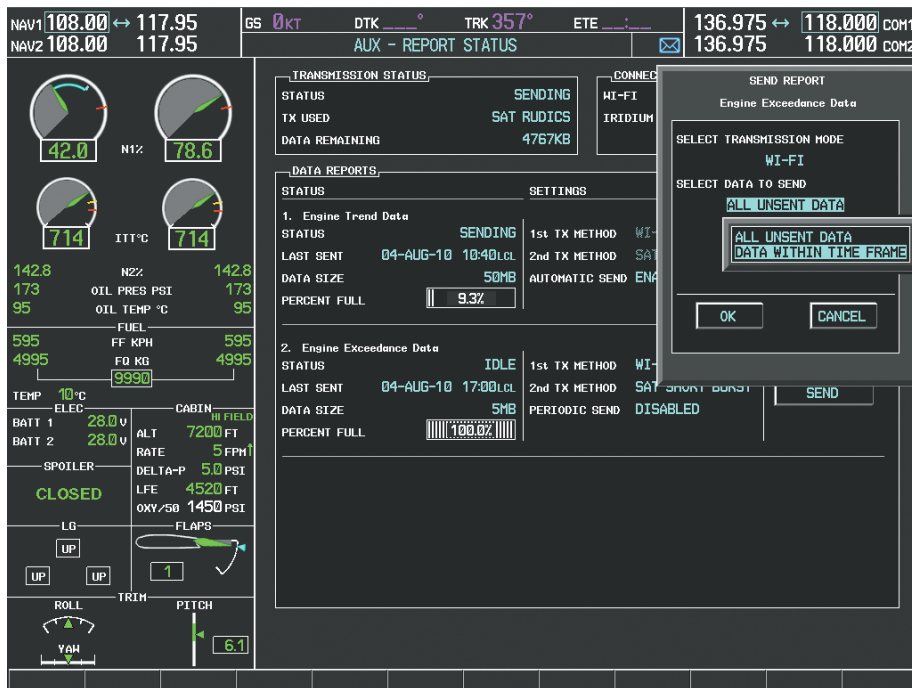
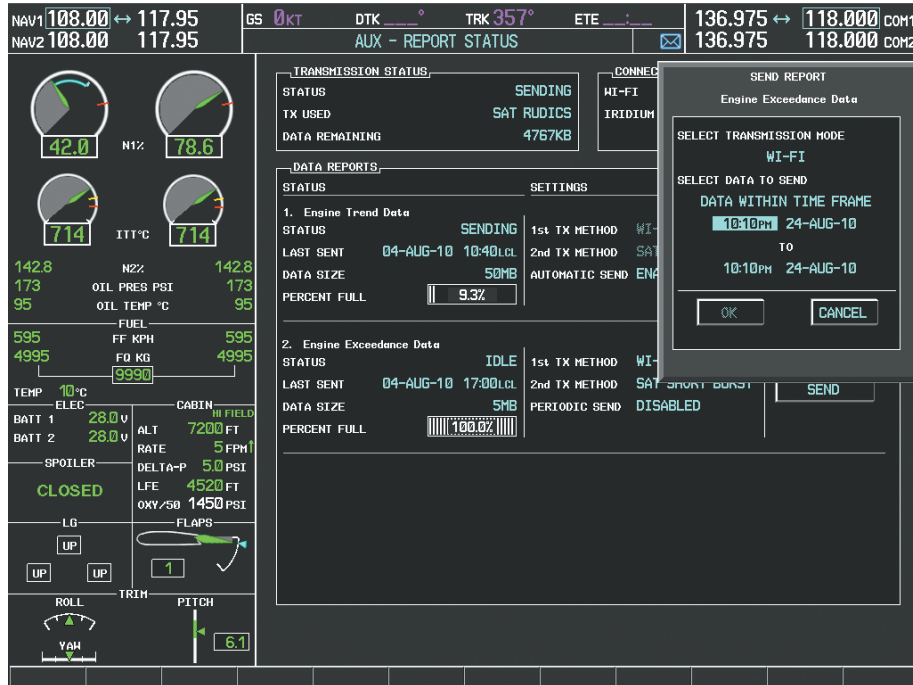

Figure 8-117 Select Data Within a Specific Time Frame

- 6) Press the **ENT** Key. The time frame selection fields are now displayed as shown in Figure 8-118.
- 7) Turn the large **FMS** Knob to select the starting time or date field.
- 8) Turn the small **FMS** Knob to select the desired starting time or date.



**Figure 8-118 Set Starting & Ending Time or Date for Time Frame**

- 9) Press the **ENT** Key. The cursor will move to the next field.
- 10) When the last field is addressed, 'OK' will be highlighted as seen in Figure 8-119. Press the **ENT** Key to send the selected data.

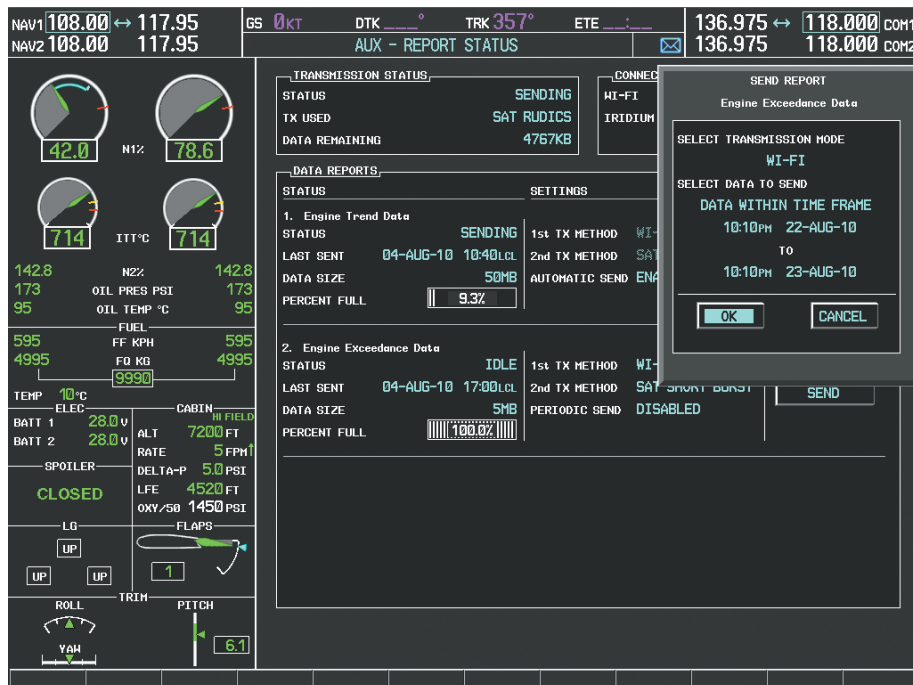

**Figure 8-119 Select OK to Send Data**

**Restoring Reports Page options to default settings:**

- 1) While viewing the Report Status Page, press the **MENU** Key.
- 2) Turn the **FMS** Knob to select 'Restore Defaults' in the menu list as shown in Figure 8-120.
- 3) Press the **ENT** Key.

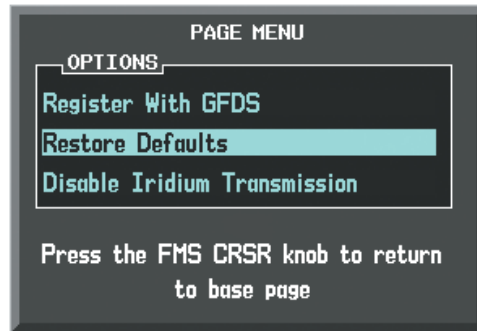

Figure 8-120 Restore Defaults

- 4) A confirmation window as shown in Figure 8-121 is now displayed.

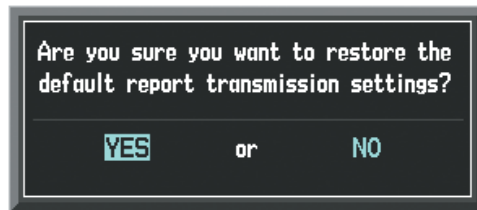

Figure 8-121 Restore Defaults Confirmation

- 5) Turn the large **FMS** Knob to select 'YES' or 'NO'.
- 6) With 'YES' highlighted, press the **ENT** Key.

## 8.7 SIRIUSXM SATELLITE RADIO ENTERTAINMENT



**NOTE:** Refer to the Hazard Avoidance Section for information about SiriusXM Weather products.

The optional SiriusXM Satellite Radio entertainment feature of the GDL 69A Data Link Receiver is available for the pilot's and passengers' enjoyment. The GDL 69A can receive SiriusXM Satellite Radio entertainment services at any altitude throughout the Continental U.S. Entertainment audio is not available on the GDL 69 Data Link Receiver.

SiriusXM Satellite Radio offers a variety of radio programming over long distances without having to constantly search for new stations. Based on signals from satellites, coverage far exceeds land-based transmissions. SiriusXM Satellite Radio services are subscription-based. For more information on specific service packages, visit [www.siriusxm.com](http://www.siriusxm.com).

### ACTIVATING SIRIUSXM SATELLITE RADIO SERVICES

The service is activated by providing SiriusXM Satellite Radio with either one or two coded IDs, depending on the equipment. Either the Audio Radio ID or the Data Radio ID, or both, must be provided to SiriusXM Satellite Radio to activate the entertainment subscription.

It is not required to activate both the entertainment and weather service subscriptions with the GDL 69A. Either or both services can be activated. SiriusXM Satellite Radio uses one or both of the coded IDs to send an activation signal that, when received by the GDL 69A, allows it to play entertainment programming.

These IDs are located:

- On the label on the back of the Data Link Receiver
- On the XM Information Page on the MFD (Figure 8-122)
- On the XM Satellite Radio Activation Instructions included with the unit (available at [www.garmin.com](http://www.garmin.com), P/N 190-00355-04)

Contact the installer if the Data Radio ID and the Audio Radio ID cannot be located.



**NOTE:** The **LOCK** Softkey on the XM Information Page (Auxiliary Page Group) is used to save GDL 69A activation data when the SiriusXM services are initially set up. It is not used during normal SiriusXM Satellite Radio operation, but there should be no adverse effects if inadvertently selected during flight. Refer to the GDL 69/69A XM Satellite Radio Activation Instructions (190-00355-04, Rev J or later) for further information.

**Activating the SiriusXM Satellite Radio services:**

- 1) Contact SiriusXM Satellite Radio. Follow the instructions provided by SiriusXM Satellite Radio services.
- 2) Turn the large **FMS** Knob to select the AUX Page Group.
- 3) Turn the small **FMS** Knob to select XM RADIO.
- 4) Select the **INFO** Softkey to display the XM Information Page.
- 5) Verify that the desired services are activated.
- 6) Select the **LOCK** Softkey.
- 7) Turn the large **FMS** Knob to highlight YES.
- 8) To complete activation, press the **ENT** Key.



Figure 8-122 XM Information Page

If SiriusXM Weather services have not been activated, the weather product boxes will appear empty on the XM Information Page and a yellow Activation Required message is displayed in the center of the Weather Data Link Page (Map Page Group). The Service Class refers to the groupings of weather products available for subscription.

## USING SIRIUSXM SATELLITE RADIO

The XM Radio Page provides information and control of the audio entertainment features of the SiriusXM Satellite Radio.

### Selecting the XM Radio Page:

- 1) Turn the large **FMS** Knob to select the AUX Page Group.
- 2) Turn the small **FMS** Knob to select XM RADIO.
- 3) Select the **RADIO** Softkey to show the XM Radio Page where audio entertainment is controlled.



Figure 8-123 XM Radio Page

## ACTIVE CHANNEL AND CHANNEL LIST

The Active Channel Box on the XM Radio Page displays the currently selected channel that the SiriusXM Radio is using.

The Channels List Box of the XM Radio Page shows a list of the available channels for the selected category. Channels can be stepped through one at a time or may be selected directly by channel number.

### Selecting a channel from the channel list:

- 1) While on the XM Radio Page, select the **CHNL** Softkey.
- 2) Select the **CH +** Softkey to go up through the list in the Channel Box, or move down the list with the **CH –** Softkey.

Or:

- 1) Press the **FMS** Knob to highlight the channel list and turn the large **FMS** Knob to scroll through the channels.
- 2) Press the **ENT** Key to activate the selected channel.

**Selecting a channel directly:**

- 1) While on the XM Radio Page, select the **CHNL** Softkey.
- 2) Select the **DIR CH** Softkey. The channel number in the Active Channel Box is highlighted.
- 3) Select the numbered softkeys located on the bottom of the display to directly select the desired channel number.
- 4) Press the **ENT** Key to activate the selected channel.

**CATEGORY**

The Category Box of the XM Radio Page displays the currently selected category of audio. Categories of channels such as jazz, rock, or news can be selected to list the available channels for a type of music or other contents. One of the optional categories is PRESETS to view channels that have been programmed.

**Selecting a category:**

- 1) Select the **CATGRY** Softkey on the XM Radio Page.
- 2) Select the **CAT +** and **CAT -** Softkeys to cycle through the categories.

**Or:**

Turn the small **FMS** Knob to display the Categories list. Highlight the desired category with the small **FMS** Knob and press the **ENT** Key. Selecting All Categories places all channels in the list.



**Figure 8-124 Categories List**

**PRESETS**

Up to 15 channels from any category can be assigned a preset number. The preset channels are selected by selecting the **PRESETS** and **MORE** Softkeys. Then the preset channel can be selected directly and added to the channel list for the Presets category.



**Setting a preset channel number:**

- 1) On the XM Radio Page, while listening to an Active Channel that is wanted for a preset, select the **PRESETS** Softkey to access the first five preset channels (**PS1 - PS5**).
- 2) Select the **MORE** Softkey to access the next five channels (**PS6 – PS10**), and again to access the last five channels (**PS11 – PS15**). Selecting the **MORE** Softkey repeatedly cycles through the preset channels.
- 3) Select any one of the (**PS1 - PS15**) softkeys to assign a number to the active channel.
- 4) Select the **SET** Softkey on the desired channel number to save the channel as a preset.

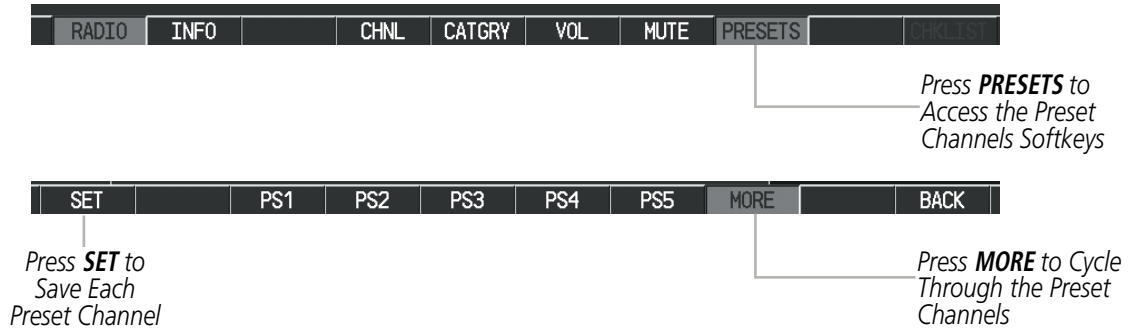

**Figure 8-125 Accessing and Selecting Preset SiriusXM Channels**

Selecting the **BACK** Softkey, or 45 seconds of softkey inactivity, returns the system to the top level softkeys.

**VOLUME**

Radio volume is shown as a percentage. Volume level is controlled by selecting the **VOL** Softkey, which brings up the **MUTE** Softkey and the volume increase and decrease softkeys.

**Adjusting the volume:**

- 1) With the XM Radio Page displayed, press the **VOL** Softkey.
- 2) Press the **VOL –** Softkey to reduce volume or press the **VOL +** Softkey to increase volume. (Once the **VOL** Softkey is pressed, the volume can also be adjusted using the small **FMS** Knob.)

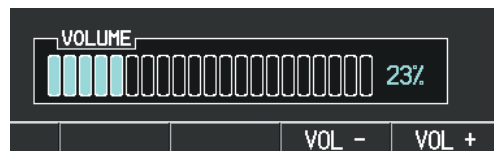

**Figure 8-126 Volume Control**

Radio volume may also be adjusted at each passenger station.

**Mute SiriusXM audio:**

- 1) Select the XM Radio Page or XM Information Page.
- 2) Press the **MUTE** Softkey to mute the audio. Press the **MUTE** Softkey again to unmute the audio.

## 8.8 SCHEDULER

The Scheduler feature can be used to enter and display reminder messages (e.g., Hot Section Inspection or Phase 1 Maintenance Check) in the Messages Window on the PFD. Messages can be set to display based on a specific date and time (event), once the message timer reaches zero (one-time; default setting), or recurrently whenever the message timer reaches zero (periodic). Message timers set to periodic alerting automatically reset to the original timer value once the message is displayed. When power is cycled, all messages are retained until deleted, and message timer countdown is resumed.

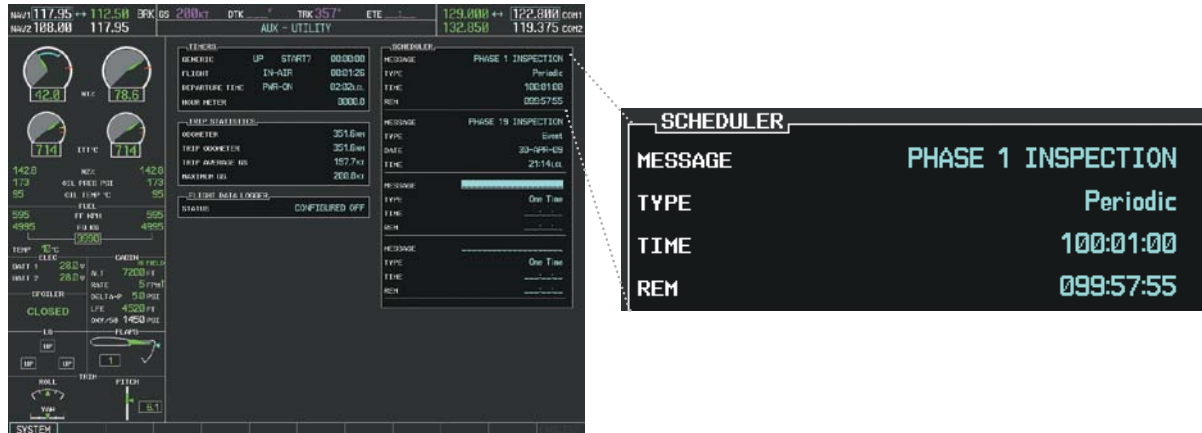

Figure 8-127 Scheduler (Utility Page)

### Entering a scheduler message:

- 1) Select the AUX - Utility Page.
- 2) Press the **FMS** Knob momentarily to activate the flashing cursor.
- 3) Turn the large **FMS** Knob to highlight the first empty scheduler message naming field.
- 4) Use the **FMS** Knob to enter the message text to be displayed in the Messages Window and press the **ENT** Key.
- 5) Press the **ENT** Key again or use the large **FMS** Knob to move the cursor to the field next to Type.
- 6) Turn the small **FMS** Knob to select the message type:
  - Event—Message issued at the specified date/time
  - One-time—Message issued when the message timer reaches zero (default setting)
  - Periodic—Message issued each time the message timer reaches zero

- 7) Press the **ENT** Key again or use the large **FMS** Knob to move the cursor to the next field.
- 8) For periodic and one-time message, use the **FMS** Knob to enter the timer value (HH:MM:SS) from which to countdown and press the **ENT** Key.
- 9) For event-based messages:
  - a) Use the **FMS** Knob to enter the desired date (DD-MM-YY) and press the **ENT** Key.
  - b) Press the **ENT** Key again or use the large **FMS** Knob to move the cursor to the next field.
  - c) Use the **FMS** Knob to enter the desired time (HH:MM) and press the **ENT** Key.
- 10) Press the **ENT** Key again or use the large **FMS** Knob to move the cursor to enter the next message.

**Deleting a scheduler message:**

- 1) Select the AUX - Utility Page.
- 2) Press the **FMS** Knob momentarily to activate the flashing cursor.
- 3) Turn the large **FMS** Knob to highlight the name field of the scheduler message to be deleted.
- 4) Press the **CLR** Key to clear the message text. If the **CLR** Key is pressed again, the message is restored.
- 5) Press the **ENT** Key while the message line is cleared to clear the message text.

Scheduler messages appear in the Messages Window on the PFD. When a scheduler message is waiting, the **MSG** Softkey label flashes. Selecting the **MSG** Softkey opens the Messages Window and acknowledges the scheduler message. Selecting the **MSG** Softkey again removes the Messages Window from the display, and the scheduler message is deleted from the message queue.



**Figure 8-128 PFD Messages Window**

## 8.9 ELECTRONIC CHECKLISTS

**NOTE:** The optional checklists presented here are for example only and may differ from checklists available for the Phenom 300. The information described in this section is not intended to replace the checklist information described in the POH.

**NOTE:** Garmin is not responsible for the content of checklists. Checklists are created by the aircraft manufacturer. Modifications or updates to the checklists are coordinated through the aircraft manufacturer. The user cannot edit these checklists.

The optional checklist functions are displayed on two levels of softkeys that are available on any MFD page.

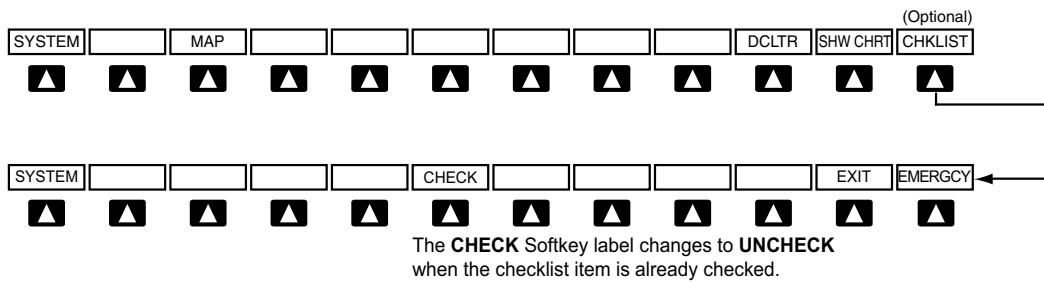

Figure 8-129 Checklist Softkeys

The MFD is able to display optional electronic checklists which allow the pilot to quickly find the proper procedure on the ground and during each phase of flight. The system accesses the checklists from an SD card inserted into the top card slot of the MFD. If the SD card contains an invalid checklist file or no checklist, the Power-up Page messages display ‘Checklist File: Invalid’ or ‘Checklist File: N/A’ (not available) and the **CHKLIST** Softkey is not available.

The following colors are used for checklist items:

- Light Blue - Items not selected or checked
- White - Item is selected
- Green - Item has been checked
- Gray - General notes
- Yellow - Caution notes
- Red - Warning notes

### Accessing and navigating checklists:

- 1) From any page on the MFD, select the **CHKLIST** Softkey or turn the large **FMS** Knob to select the Checklist Page.
- 2) Turn the large **FMS** Knob to select the ‘GROUP’ field.
- 3) Turn the small **FMS** Knob to select the desired procedure and press the **ENT** Key.
- 4) Turn the large **FMS** Knob to select the ‘CHECKLIST’ field.
- 5) Turn the small **FMS** Knob to select the desired checklist and press the **ENT** Key. The selected checklist item is indicated with white text surrounded by a white box.
- 6) Press the **ENT** Key or select the **CHECK** Softkey to check the selected checklist item. The line item turns green and a checkmark is placed in the associated box. The next line item is automatically selected for checking.

Either **FMS** Knob can be used to scroll through the checklist and select the desired checklist item.

Press the **CLR** Key or select the **UNCHECK** Softkey to remove a check mark from an item.

- 7) When all checklist items have been checked, '\*Checklist Finished\*' is displayed in green text at the bottom left of the checklist window and 'GO TO NEXT CHECKLIST?' is highlighted. If 'GO TO NEXT CHECKLIST?' is selected prior to checking all the checklist items, '\*CHECKLIST NOT FINISHED\*' will be displayed in yellow text.
- 8) Press the **ENT** Key. If 'GO TO NEXT CHECKLIST?' is displayed when pressing the **ENT** Key, the next checklist in the group will be displayed. If 'EXIT CHECKLISTS?' is displayed when pressing the **ENT** Key, the system will exit the Checklist Page.
- 9) Select the **EXIT** Softkey to exit the Checklist Page and return to the page last viewed. When returning to the Checklist Page after pressing the **EXIT** Softkey, the system will return to the last selected checklist item.

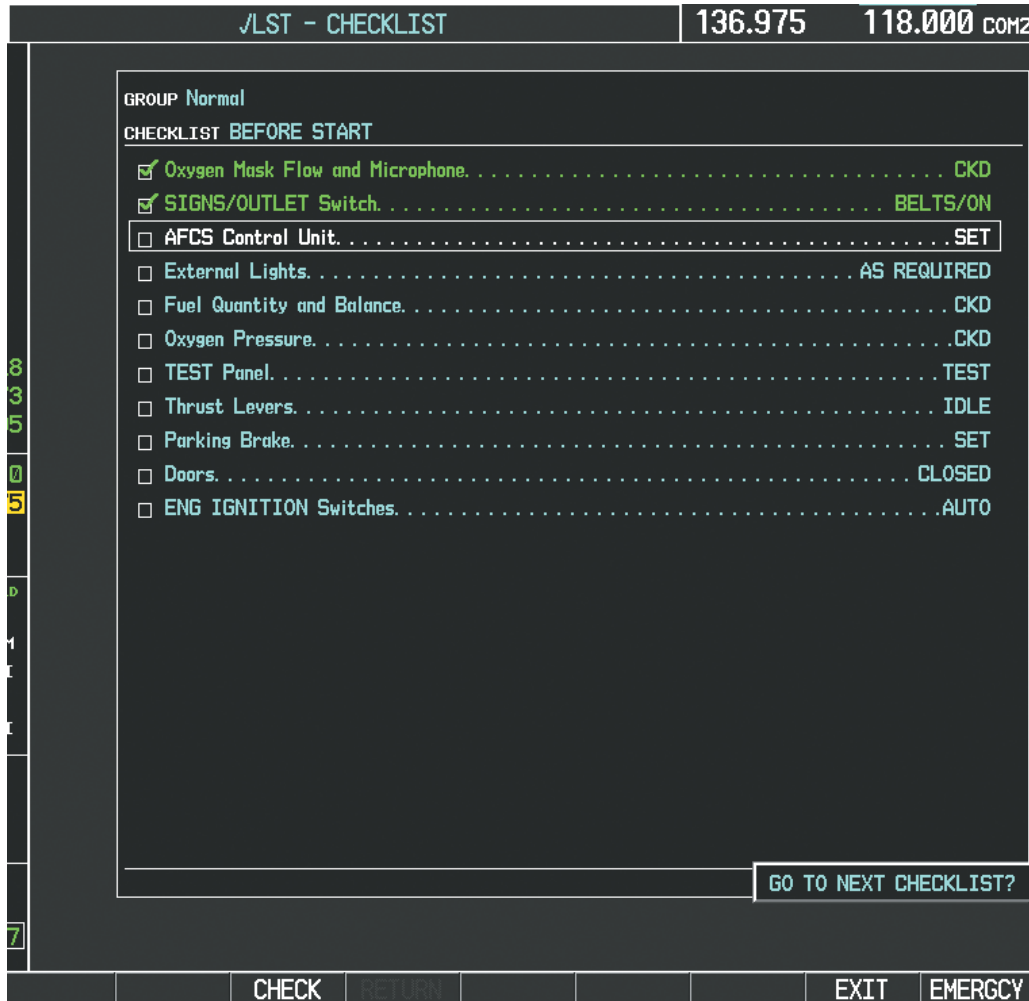

Figure 8-130 Sample Checklist

**Accessing emergency procedures:**

- 1) From any page on the MFD, select the **CHKLIST** Softkey or turn the large **FMS** Knob to select the Checklist Page.
- 2) Select the **EMERGCY** Softkey.
- 3) Turn the **FMS** Knob to select the desired emergency checklist and press the **ENT** Key.

- 4) Press the **ENT** Key or select the **CHECK** Softkey to check the selected emergency checklist item. The line item turns green and a checkmark is placed in the box next to it. The next line item is automatically highlighted for checking.

Either **FMS** Knob can be used to scroll through the checklist and select the desired checklist item.

Press the **CLR** Key or select the **UNCHECK** Softkey to remove a check mark from an item.

- 5) When all checklist items have been checked, ‘\*Checklist Finished\*’ is displayed in green text at the bottom left of the checklist window and ‘GO TO NEXT CHECKLIST?’ is highlighted. If ‘GO TO NEXT CHECKLIST?’ is selected prior to checking all the checklist items, ‘\*CHECKLIST NOT FINISHED\*’ will be displayed in yellow text.
- 6) Press the **ENT** Key to advance to the next checklist.
- 7) Select the **RETURN** Softkey to return to the previous checklist.
- 8) Select the **EXIT** Softkey to exit the Checklist Page and return to the page last viewed.

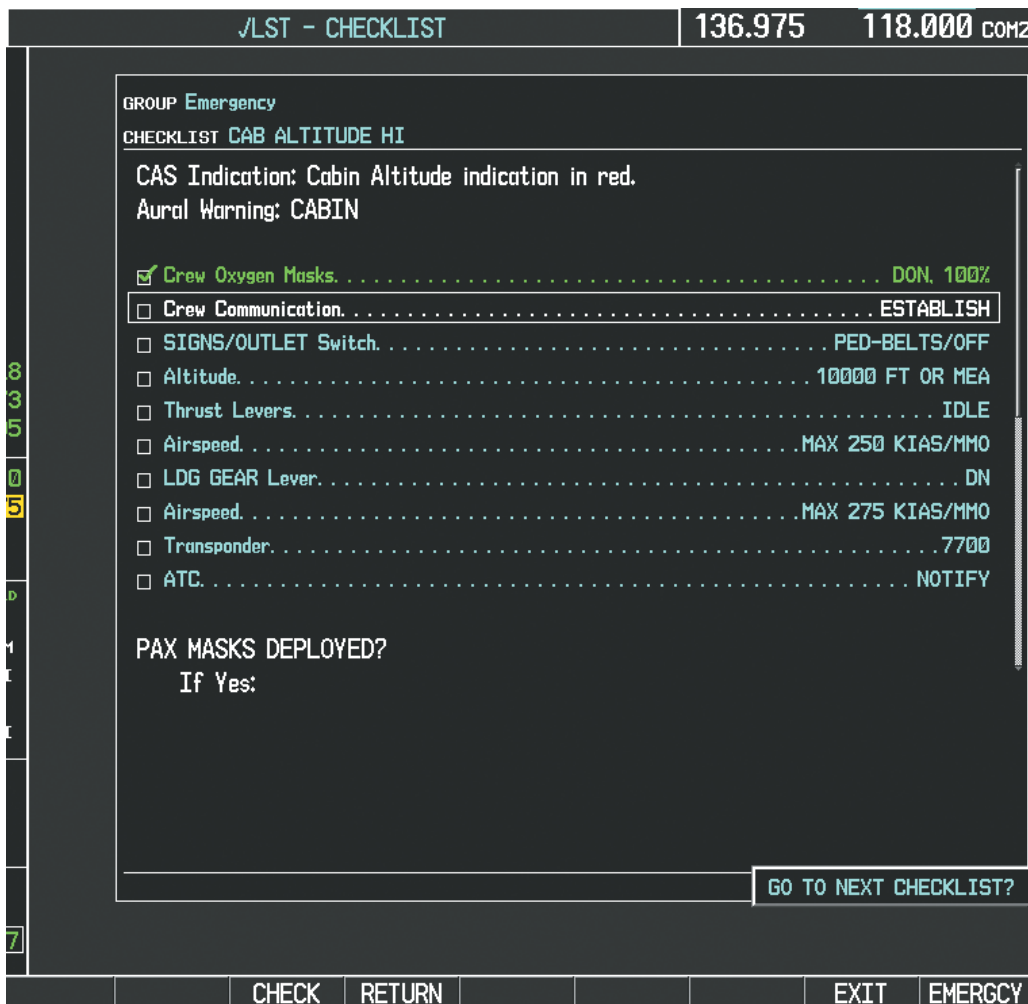

Figure 8-131 Emergency Checklist Page Example



## 8.10 ABNORMAL OPERATION

### SVS TROUBLESHOOTING

SVS is intended to be used with traditional attitude, heading, obstacle, terrain, and traffic inputs. SVS is disabled when valid attitude or heading data is not available for the display. In case of invalid SVS data, the PFD display reverts to the standard blue-over-brown attitude display.

SVS becomes disabled without the following data resources:

- Attitude data
- Heading data
- GPS position data
- 9 Arc-second Terrain data
- Obstacle data
- TAWS function is not available, in test mode, or failed
- The position of the aircraft exceeds the range of the terrain database.

### REVERSIONARY MODE

SVS can be displayed on the Multifunction Display (MFD) in Reversionary Mode. If it is enabled when switching to Reversionary Mode, SVS will take up to 30 seconds to be displayed. The standard, non-SVS PFD display will be shown in the interim.



Figure 8-132 SVS Reversionary Mode



### UNUSUAL ATTITUDES

Unusual attitudes are displayed with red chevrons overlaid on the display indicating the direction to fly to correct the unusual attitude condition. The display shows either a brown or blue colored bar at the top or bottom of the screen to represent earth or sky. This is intended to prevent losing sight of the horizon during extreme pitch attitudes.

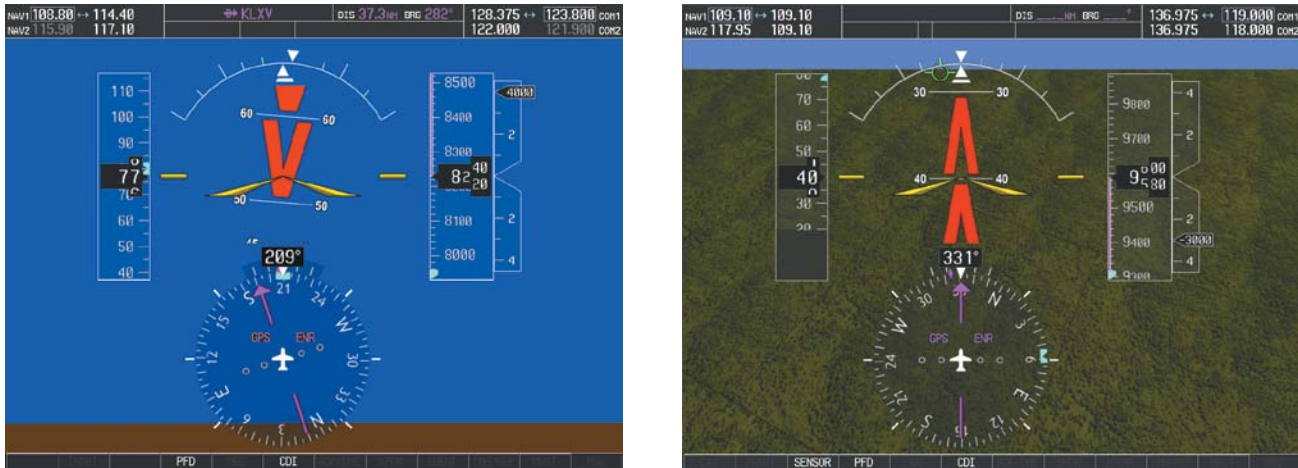

Figure 8-133 Unusual Attitude Display

The blue colored bar is also displayed when terrain gradient is great enough to completely fill the display.



Figure 8-134 Blue Sky Bar with Full Display Terrain

## GDL 69/69A DATA LINK RECEIVER TROUBLESHOOTING

Some quick troubleshooting steps listed below can be performed to find the possible cause of a failure.

- Ensure the owner/operator of the aircraft in which the Data Link Receiver is installed has subscribed to SiriusXM Satellite Radio
- Ensure the SiriusXM subscription has been activated
- Perform a quick check of the circuit breakers to ensure that power is applied to the Data Link Receiver
- Ensure that nothing is plugged into the Music jack(s) because this would prevent SiriusXM Satellite Radio from being heard

For troubleshooting purposes, check the LRU Information Box on the AUX - System Status Page for Data Link Receiver (GDL 69/69A) status, serial number, and software version number. If a failure has been detected in the GDL 69/69A the status is marked with a red X.

### Selecting the System Status Page:

- 1) Turn the large **FMS** Knob to select the AUX Page Group.
- 2) Turn the small **FMS** Knob to select the System Status Page (the last page in the AUX Page Group).

LRU INFO	STATUS	SERIAL NUMBER	VERSION
COM1	✓		7.00
COM2	✓		7.00
GCU	✓	27000006	2.02d
GDC1	✓	47801548	1.05
GDC2	✓	47801373	1.05
GDL69	✓	47750372	3.02.00
GEA1	✓	46701911	2.07
GEA2	✓	46701913	2.07
GEA3	✓	46701913	1.02
GIA1	✓	68500319	1.02
GIA2	✓	48400000	3.01
GMA1	✓	48400001	3.01
GMA2	✓		2.02d
GMC	✓	47500593	2.01
GMU1	✓	47500607	2.01
GMU2	✓	AB0062149	2.3

Figure 8-135 LRU Information Window on System Status Page

If a failure still exists, the following messages may provide insight as to the possible problem:

Message	Message Location	Description
<b>CHECK ANTENNA</b>	XM Radio Page - active channel field	Data Link Receiver antenna error; service required
<b>UPDATING</b>	XM Radio Page - active channel field	Data Link Receiver updating encryption code
<b>NO SIGNAL</b>	XM Radio Page - active channel field Weather Datalink Page - center of page	Loss of signal; signal strength too low for receiver
<b>LOADING</b>	XM Radio Page - active channel field	Acquiring channel audio or information
<b>OFF AIR</b>	XM Radio Page - active channel field	Channel not in service
<b>---</b>	XM Radio Page - active channel field	Missing channel information
<b>WEATHER DATA LINK FAILURE</b>	Weather Datalink Page - center of page	No communication from Data Link Receiver within last 5 minutes
<b>ACTIVATION REQUIRED</b>	Weather Datalink Page - center of page	SiriusXM subscription is not activated

**Table 8-7 GDL 69/69A Data Link Receiver Error Messages**

# ANNUNCIATIONS AND ALERTS

## CAS MESSAGES

### WARNING MESSAGES

See the Airplane Flight Manual (AFM) for recommended pilot actions. Accompanied by a triple chime tone which repeats until acknowledged.

Message	Description
<b>BAG SMK</b>	Smoke detected in baggage compartment
<b>CAB ALTITUDE HI</b>	Cabin altitude pressure altitude high
<b>DOOR EMER OPEN</b>	Emergency door open
<b>DOOR PAX OPEN</b>	Passenger door open
<b>E1 FIRE</b>	Fire in engine 1
<b>E2 FIRE</b>	Fire in engine 2
<b>E1 OIL LO PRES</b>	Low oil pressure in engine 1
<b>E2 OIL LO PRES</b>	Low oil pressure in engine 2
<b>ELEC EMERGENCY</b>	Generators offline
<b>ELEC XFR FAIL</b>	Generators offline and electrical emergency transfer has failed
<b>LG LEVER DISAG</b>	Landing gear position and control lever disagreement
<b>NO TO CONFIG</b>	No takeoff configuration

### CAUTION MESSAGES

See the Airplane Flight Manual (AFM) for recommended pilot actions. Accompanied by a single chime tone which repeats until acknowledged.

Message	Description
<b>ADS 1 FAIL</b>	ADS 1 offline or failed
<b>ADS 2 FAIL</b>	ADS 2 offline or failed
<b>ADS 1 HTR FAIL</b>	Pitot heater 1 offline or heater element failed
<b>ADS 2 HTR FAIL</b>	Pitot heater 2 offline or heater element failed
<b>AHRS 1 FAIL</b>	AHRS 1 failure
<b>AHRS 2 FAIL</b>	AHRS 2 failure
<b>A-I E1 FAIL</b>	Anti-ice system failure in engine 1
<b>A-I E2 FAIL</b>	Anti-ice system failure in engine 2
<b>A-I LO CAPACITY</b>	Not enough thermal energy available for WHSAIS (Wing and Horizontal Stabilizer Anti-ice System) operation
<b>A-I WINGSTB FAIL</b>	Component failure (AIV, pressure transducers, AMS Controller, other)
<b>A-I WINGSTB INHB</b>	WHSAIS switched ON outside the icing envelope. Or, aircraft is in single bleed configuration and above the 15,000 ft. icing envelope when WHSAIS is switched on.
<b>A-I WINGSTB LEAK</b>	Bleed hot air leakage at WHSAIS pneumatic ducting
<b>AMS CTRL FAIL</b>	Pneumatic sources and icing protection are not available
<b>ANTI-SKID FAIL</b>	Anti-skid function lost; main brake still available
<b>AP FAIL</b>	Loss of AP function
<b>AP PITCH MISTRIM</b>	Airplane mistrimmed in pitch axis when AP is engaged
<b>AP ROLL MISTRIM</b>	Airplane mistrimmed in roll axis when AP is engaged
<b>AUDIO PNL 1 FAIL</b>	Audio panel 1 is offline
<b>AUDIO PNL 2 FAIL</b>	Audio panel 2 is offline
<b>AURAL WRN FAIL</b>	Aural warning system failure due to non-communicating LRUs
<b>AUTO PTRIM FAIL</b>	Auto pitch trim failure; other pitch trim functions still available

Message	Description
<b>BAG SMK FAIL</b>	Baggage compartment smoke detector has failed
<b>BATT DISCHARGE</b>	Battery discharging under normal operation
<b>BATT 1 OFF BUS</b>	Battery 1 offline
<b>BATT 2 OFF BUS</b>	Battery 2 offline
<b>BATT EXCEEDANCE</b>	Battery voltage has exceeded 29 VDC
<b>BLEED 1 FAIL</b>	Bleed 1 system not under control.
<b>BLEED 2 FAIL</b>	Bleed 2 system not under control.
<b>BLEED 1 LEAK</b>	Bleed 1 hot air leakage at some region of the ducting
<b>BLEED 2 LEAK</b>	Bleed 2 hot air leakage at some region of the ducting
<b>BLEED 1 OVERPRES</b>	Pressure in bleed ducting is higher than an acceptable value chosen to not compromise ECS and Anti-ice components integrity
<b>BLEED 2 OVERPRES</b>	Pressure in bleed ducting is higher than an acceptable value chosen to not compromise ECS and Anti-ice components integrity
<b>BRK FAIL</b>	Main brake system lost
<b>CAB DELTA-P FAIL</b>	Excessive cabin pressure differential
<b>CLUTCH PIT FAIL</b>	Slip clutch maintenance test failed
<b>CLUTCH ROL FAIL</b>	Slip clutch maintenance test failed
<b>CLUTCH YAW FAIL</b>	Slip clutch maintenance test failed
<b>CONFIG MDL FAIL</b>	Master Configuration Module failed or non-communicative
<b>DOORBAG AFT OPEN</b>	Crew baggage door open
<b>DOORBAG LH OPEN</b>	Forward left-hand baggage door open
<b>DOORBAG RH OPEN</b>	Forward right-hand baggage door open
<b>DUCT 1 OVERTEMP</b>	Duct 1 temperature over specified safe value
<b>DUCT 2 OVERTEMP</b>	Duct 2 temperature over specified safe value
<b>E1 CTRL FAULT</b>	Engine 1 responds slowly or not at all to thrust commands
<b>E2 CTRL FAULT</b>	Engine 2 responds slowly or not at all to thrust commands
<b>E1 FAIL</b>	Uncommanded shutdown detected for engine 1
<b>E2 FAIL</b>	Uncommanded shutdown detected for engine 2
<b>E1 FIRE DET FAIL</b>	Fire detection system failure in engine 1
<b>E2 FIRE DET FAIL</b>	Fire detection system failure in engine 2
<b>E1 FIREX FAIL</b>	Fire extinguisher failure in engine 1
<b>E2 FIREX FAIL</b>	Fire extinguisher failure in engine 2
<b>E1 FUEL IMP BYP</b>	Fuel filter impending bypass condition for engine 1
<b>E2 FUEL IMP BYP</b>	Fuel filter impending bypass condition for engine 2
<b>E1 TLA FAIL</b>	Thrust Lever Angle failure for engine 1
<b>E2 TLA FAIL</b>	Thrust Lever Angle failure for engine 2
<b>E1 TTO HTR FAIL</b>	Heater failure in engine 1
<b>E2 TTO HTR FAIL</b>	Heater failure in engine 2
<b>EBAY LEAK</b>	Leak inside E-Bay
<b>EBAY OVHT</b>	Electrical bay over temperature
<b>ECS 1 VALVE FAIL</b>	Flow control valve monitor for ECS 1 detected improper valve operation
<b>ECS 2 VALVE FAIL</b>	Flow control valve monitor for ECS 2 detected improper valve operation
<b>EMER BRK LO PRES</b>	Few emergency brake functions available
<b>EMER LT NOT ARM</b>	Emergency lights switch not in ARMED position
<b>ENG EXCEEDANCE</b>	Limit exceeded in engine(s) during flight
<b>ENG NO DISPATCH</b>	FADEC detected no dispatch fault condition in engine(s)
<b>ENG NO TO DATA</b>	No takeoff data entered
<b>FLAP FAIL</b>	Loss of flaps deployment or retraction
<b>FUEL 1 LO LEVEL</b>	Low fuel level in tank 1

Message	Description
<b>FUEL 2 LO LEVEL</b>	Low fuel level in tank 2
<b>FUEL 1 LO PRES</b>	Fuel pressure low in engine 1 feed line
<b>FUEL 2 LO PRES</b>	Fuel pressure low in engine 2 feed line
<b>FUEL 1 SOV FAIL</b>	Fuel feed SOV 1 closed or unavailable
<b>FUEL 2 SOV FAIL</b>	Fuel feed SOV 2 closed or unavailable
<b>FUEL IMBALANCE</b>	Fuel is imbalanced between the tanks
<b>FUEL XFEED FAIL</b>	Disagreement between valve command and its feedback
<b>GEN 1 OFF BUS</b>	Generator 1 offline
<b>GEN 2 OFF BUS</b>	Generator 2 offline
<b>GEN OVLD</b>	Generator(s) overload
<b>GEN START FAULT</b>	Generator start fault
<b>GIA 1 FAIL</b>	Failure of GIA 1
<b>GIA 2 FAIL</b>	Failure of GIA 2
<b>GIA 1 OVHT</b>	GIA 1 over temperature
<b>GIA 2 OVHT</b>	GIA 2 over temperature
<b>GND SPLR FAIL</b>	Loss of ground spoilers
<b>HYD HI TEMP</b>	Hydraulic temperature high
<b>HYD LO PRES</b>	Hydraulic pressure low
<b>HYD SOV 1 FAIL</b>	EDP 1 Fire Shutoff valve was commanded to close, but failed to close
<b>HYD SOV 2 FAIL</b>	EDP 2 Fire Shutoff valve was commanded to close, but failed to close
<b>ICE CONDITION*</b>	Aircraft is flying in icing conditions
<b>LG WOW SYS FAIL</b>	Landing gear weight-on-wheels system failure
<b>MFD CONFIG</b>	MFD configuration error
<b>MFD FAULT</b>	Fault with the MFD
<b>MFD OVHT</b>	MFD over temperature
<b>OXY LO PRES</b>	Oxygen system pressure low
<b>PARK BRK NOT REL</b>	Parking brake not released
<b>PAX OXY NO PRES</b>	Cabin altitude high and passenger oxygen system pressure low
<b>PFD 1 CONFIG</b>	PFD 1 configuration error
<b>PFD 2 CONFIG</b>	PFD 2 configuration error
<b>PFD 1 FAULT</b>	Fault with PFD 1
<b>PFD 2 FAULT</b>	Fault with PFD 2
<b>PFD 1 OVHT</b>	PFD 1 over temperature
<b>PFD 2 OVHT</b>	PFD 2 over temperature
<b>PRESN AUTO FAIL</b>	Pressurization controller failure
<b>PTRIM BKP FAIL</b>	Loss of backup pitch trim actuator
<b>PTRIM NML FAIL</b>	Loss of normally-operating pitch trim actuator
<b>PUSHER FAIL</b>	Stall Warning & Protection System pusher has failed
<b>PUSHER OFF</b>	Stall Warning Pusher is off
<b>RUD OVERBOOST</b>	SLRB (Spring Loaded Rudder Booster) uncommanded actuation
<b>STBY HTR FAIL</b>	Failure of standby heater
<b>SWPS FAIL</b>	Stall Warning & Protection System inoperative
<b>SWPS FAULT</b>	Stall Warning & Protection System activation angles anticipated to conservative settings
<b>SWPS UNTESTED</b>	Stall Warning & Protection System has not been tested
<b>TCAS FAIL*</b>	Traffic & Collision Avoidance System failure. TCASII installations only.
<b>WSHLD 1 HTR FAIL</b>	Windshield 1 heater failure
<b>WSHLD 2 HTR FAIL</b>	Windshield 2 heater failure
<b>YD FAIL</b>	Loss of yaw damper function
<b>YD MISTRIM</b>	Airplane mistrimmed in yaw axis when YD is engaged

\* Optional

## ADVISORY MESSAGES

See the Airplane Flight Manual (AFM) for recommended pilot actions.

Message	Description
A-I E1 FAULT	Engine 1 Anti-ice system valve failed when commanded to close
A-I E2 FAULT	Engine 2 Anti-ice system valve failed when commanded to close
A-I E1 ON	Anti-ice system on in engine 1
A-I E2 ON	Anti-ice system on in engine 2
A-I WINGSTB ARM	WINGSTAB toggle switch has been armed prior to takeoff
A-I WINGSTB ON	WHSAIS is operating
ADS 1 SLIP FAIL	ADS 1 side-slip compensation is off
ADS 2 SLIP FAIL	ADS 2 side-slip compensation is off
ADS HTR SW ON	ADS Probe switch is on
AHRS 1 FAULT	Fault with AHRS 1
AHRS 2 FAULT	Fault with AHRS 2
AMS CTRL FAULT	One pneumatic and Anti-ice controller channel is inoperative
AUDIO PNL 1 FAULT	Fault with audio panel 1
AUDIO PNL 2 FAULT	Fault with audio panel 2
AURAL WRN FAULT	Partial loss of aural warning function
AVNX FAN FAIL	Avionics fan failure
BAG SMK FAULT	Two baggage compartment smoke detectors have failed
BLEED 1 OFF	Bleed pressure regulator 1 and shut-off valve closed
BLEED 2 OFF	Bleed pressure regulator 2 and shut-off valve closed
BRK CTRL 1 FAIL*	Brake control channel #1 is not available (failed or powered off)
BRK CTRL 2 FAIL*	Brake control channel #2 is not available (failed or powered off)
BRK FAULT*	Active channel of brake control system has failure(s) which reduce safety margins without adversely affect the aircraft operation. Non-dispatchable.
CLUTCH PIT PASS	Pitch slip clutch maintenance test passed
CLUTCH PIT PROG	Pitch slip clutch maintenance test in progress
CLUTCH ROLL PASS	Roll slip clutch maintenance test passed
CLUTCH ROLL PROG	Roll slip clutch maintenance test in progress
CLUTCH YAW PASS	Yaw slip clutch maintenance test passed
CLUTCH YAW PROG	Yaw slip clutch maintenance test in progress
DC BUS 1 OFF	DC bus 1 offline
DC BUS 2 OFF	DC bus 2 offline
DOOR REFUEL OPEN	Refueling door is open
E1 CHIP DETECTED	Chip detected by engine 1 oil chip detector
E2 CHIP DETECTED	Chip detected by engine 2 oil chip detector
E1 FADEC FAULT	FADEC fault in engine 1
E2 FADEC FAULT	FADEC fault in engine 2
E1 OIL IMP BYP	Engine 1 oil filter impending bypass set
E2 OIL IMP BYP	Engine 2 oil filter impending bypass set
ECS 1 OFF	Flow control valve monitor detected improper valve operation
ECS 2 OFF	Flow control valve monitor detected improper valve operation
ELEC SYS FAULT	Electrical system fault
EMER BUS OFF	Emergency bus OFF
ENG FIREX DISCH	Engine fire extinguisher discharge
FLAP NOT AVAIL	Flaps not available
FUEL EQUAL	Fuel quantity asymmetry corrected; XFEED SOV is open
FUEL 1 FEED FAULT	DC pump on due to low fuel pressure



Message	Description
<b>FUEL 2 FEED FAULT</b>	DC pump on due to low fuel pressure
<b>FUEL 1 PSW FAIL</b>	Fuel pressure switch stuck in "high" position
<b>FUEL 2 PSW FAIL</b>	Fuel pressure switch stuck in "high" position
<b>FUEL PUMP 1 FAIL</b>	Fuel pump 1 failure
<b>FUEL PUMP 2 FAIL</b>	Fuel pump 2 failure
<b>GEA 1 FAIL</b>	Failure of GEA 1
<b>GEA 2 FAIL</b>	Failure of GEA 2
<b>GEA 3 FAIL</b>	Failure of GEA 3
<b>GPU CONNECTED</b>	Ground power unit connected to the aircraft
<b>GSD 1 FAIL</b>	GSD 1 non-communicative
<b>GSD 2 FAIL</b>	GSD 2 non-communicative
<b>HSDB FAULT</b>	An LRU has stopped communicating over an HSDB
<b>HSDB SW REV POS</b>	HSDB switch in reversionary position
<b>HYD SYS FAULT</b>	Degradation of hydraulic system available power
<b>ICE DET FAIL *</b>	Ice Detector failure
<b>MFD FAN FAIL</b>	Failure of MFD fan
<b>OXY SW NOT AUTO</b>	Oxygen system switch in manual mode
<b>PFD 1 FAN FAIL</b>	Failure of PFD 1 fan
<b>PFD 2 FAN FAIL</b>	Failure of PFD 2 fan
<b>PTRIM LO RATE</b>	Pitch trim is being actuated in low rate
<b>PTRIM SW1 FAIL</b>	Failure of pilot pitch trim switch
<b>PTRIM SW2 FAIL</b>	Failure of copilot pitch trim switch
<b>RALT FAIL *</b>	Radar altitude failure
<b>RAM AIR FAIL</b>	Ram air valve failure
<b>RUD BOOST FAIL</b>	Loss of SLRB (Spring Loaded Rudder Booster) force assistance in case of thrust asymmetry
<b>SHED BUS OFF</b>	Shed bus off
<b>SPDBRK SW DISAG</b>	Speed brake switch position is in disagreement with the spoiler surfaces position
<b>SPOILER FAULT</b>	Ground Spoiler arm logic failed Ground Spoiler command disagree Spoiler position disagree Ground Spoiler Control Valve failed Speed brake command failed Speed brake command inhibit failed
<b>SWPS ICE SPEED</b>	Stall Warning System activation angles anticipated due to icing conditions
<b>VENTRAL RUD FAIL</b>	Ventral rudder has failed
<b>XBLEED FAIL</b>	Cross bleed valve has failed closed or open
<b>XBLEED SW OFF</b>	Cross bleed switch is in the OFF position

\* Optional

## COMPARATOR ANNUNCIATIONS

The Comparator monitors critical values generated by redundant sensors. If differences in the sensors exceed a specified amount, this discrepancy will be annunciated in the Comparator Window as a ‘MISCOMP’ (miscompare) as seen in Figure A-1. Note that operating the system in the vicinity of metal buildings or other metal structures can cause sensor differences that may result in nuisance miscompare annunciations during start up, shut down, or while taxiing. If one or both of the sensed values are unavailable, it will be annunciated as a ‘NO COMP’ (no compare). The following is a list of the possible annunciations:



Figure A-1 Sensor Comparator Window

Comparator Window Text	Condition
<b>ALT MISCOMP</b>	Difference in altitude sensors is $\geq 200$ ft.
<b>IAS MISCOMP</b>	If both airspeed sensors detect $< 35$ kts, this is inhibited. If either airspeed sensor detects $\geq 35$ kts, and the difference in sensors is $> 15$ kts. If either airspeed sensor detects $\geq 80$ kts, and the difference in sensors is $> 10$ kts.
<b>HDG MISCOMP</b>	Difference in heading sensors is $> 10^\circ$ .
<b>PIT MISCOMP</b>	Difference in pitch sensors is $> 5^\circ$ .
<b>ROL MISCOMP</b>	Difference in roll sensors is $> 6^\circ$ .
<b>ALT NO COMP</b>	No data from one or both altitude sensors.
<b>IAS NO COMP</b>	No data from one or both airspeed sensors.
<b>HDG NO COMP</b>	No data from one or both heading sensors.
<b>PIT NO COMP</b>	No data from one or both pitch sensors.
<b>ROL NO COMP</b>	No data from one or both roll sensors..

## REVERSIONARY SENSOR ANNUNCIATIONS

Reversionary sensor selection is annunciated in the Reversionary Sensor Window, as shown in Figure A-2. These annunciations reflect reversionary sensors selected on one or both PFDs. Pressing the **SENSOR** Softkey gives access to **ADC1**, **ADC2**, **ADCSTBY**, **AHRS1**, **AHRS2**, and **ATTSTBY** Softkeys. These softkeys allow manual switching of sensors. In the case of certain types of sensor failures, the system may make some sensor selections automatically. The GPS sensor cannot be switched manually.



Figure A-2 Reversionary Sensor Windows

Reversionary Sensor Window Text	Condition
<b>BOTH ON ADC1</b>	Both PFDs are displaying data from the #1 Air Data Computer.
<b>BOTH ON ADC2</b>	Both PFDs are displaying data from the #2 Air Data Computer.
<b>BOTH ON ADCSTBY</b>	Both PFDs are displaying data from the standby air data input.
<b>BOTH ON AHRS1</b>	Both PFDs are displaying data from the #1 AHRS.
<b>BOTH ON AHRS2</b>	Both PFDs are displaying data from the #2 AHRS.
<b>BOTH ON ATTSTBY</b>	Both PFDs are displaying data from the standby attitude and heading reference input.
<b>BOTH ON GPS1</b>	Both PFDs are displaying data from the #1 GPS receiver.
<b>BOTH ON GPS2</b>	Both PFDs are displaying data from the #2 GPS receiver.
<b>USING ADC1</b>	PFD2 is displaying data from the #1 Air Data Computer.
<b>USING ADC2</b>	PFD1 is displaying data from the #2 Air Data Computer.
<b>USING ADCSTBY</b>	PFD1 or PFD2 is displaying data from the standby air data input.
<b>USING AHRS1</b>	PFD2 is displaying data from the #1 AHRS.
<b>USING AHRS2</b>	PFD1 is displaying data from the #2 AHRS.
<b>USING ATTSTBY</b>	PFD1 or PFD2 is displaying data from the standby attitude and heading reference input.
<b>USING GPS1</b>	PFD2 is displaying data from the #1 GPS.
<b>USING GPS2</b>	PFD1 is displaying data from the #2 GPS.

## PRODIGY® SYSTEM ANNUNCIATIONS

When a new message is issued, the **MSG** Softkey will flash to alert the flight crew of a new message. It will continue to flash until acknowledged by pressing the softkey. Active messages are displayed in white text. Messages that have become inactive will change to gray text. The **MSG** Softkey will flash if the state of a displayed message changes or a new message is displayed. The inactive messages can be removed from the Message Window by pressing the flashing **MSG** Softkey.

Messages are conveyed to the flight crew regarding problems with the system. Typically, a large red “X” appears in a window when a related LRU fails or detects invalid data.

When an LRU or an LRU function fails, a large red “X” is typically displayed on windows associated with the failed data. The following section describes various system annunciations. Refer to the AFM for additional information regarding pilot responses to these annunciations.



**NOTE:** Upon power-up of the system, certain windows remain invalid as equipment begins to initialize. All windows should be operational within one minute of power-up. Should any window continue to remain flagged, the system should be serviced by a Garmin-authorized repair facility.

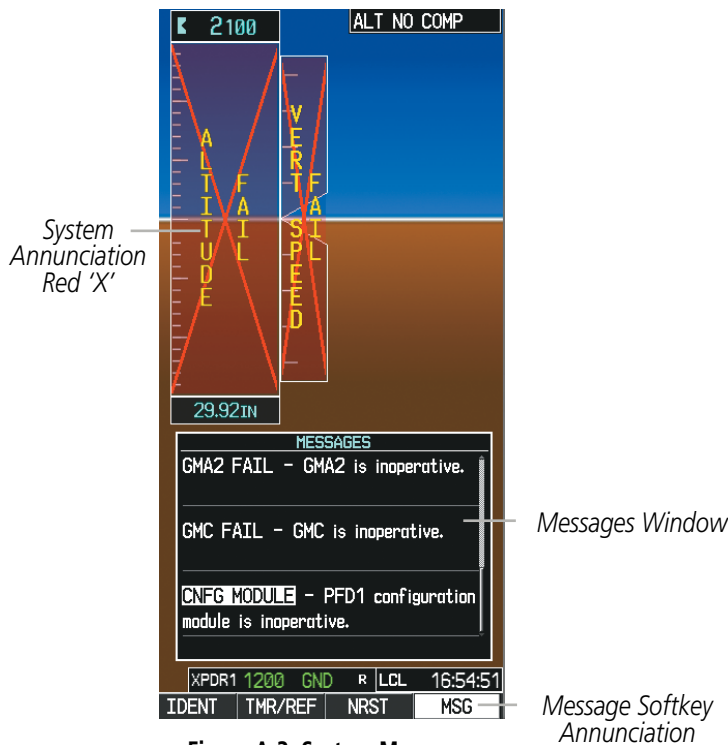
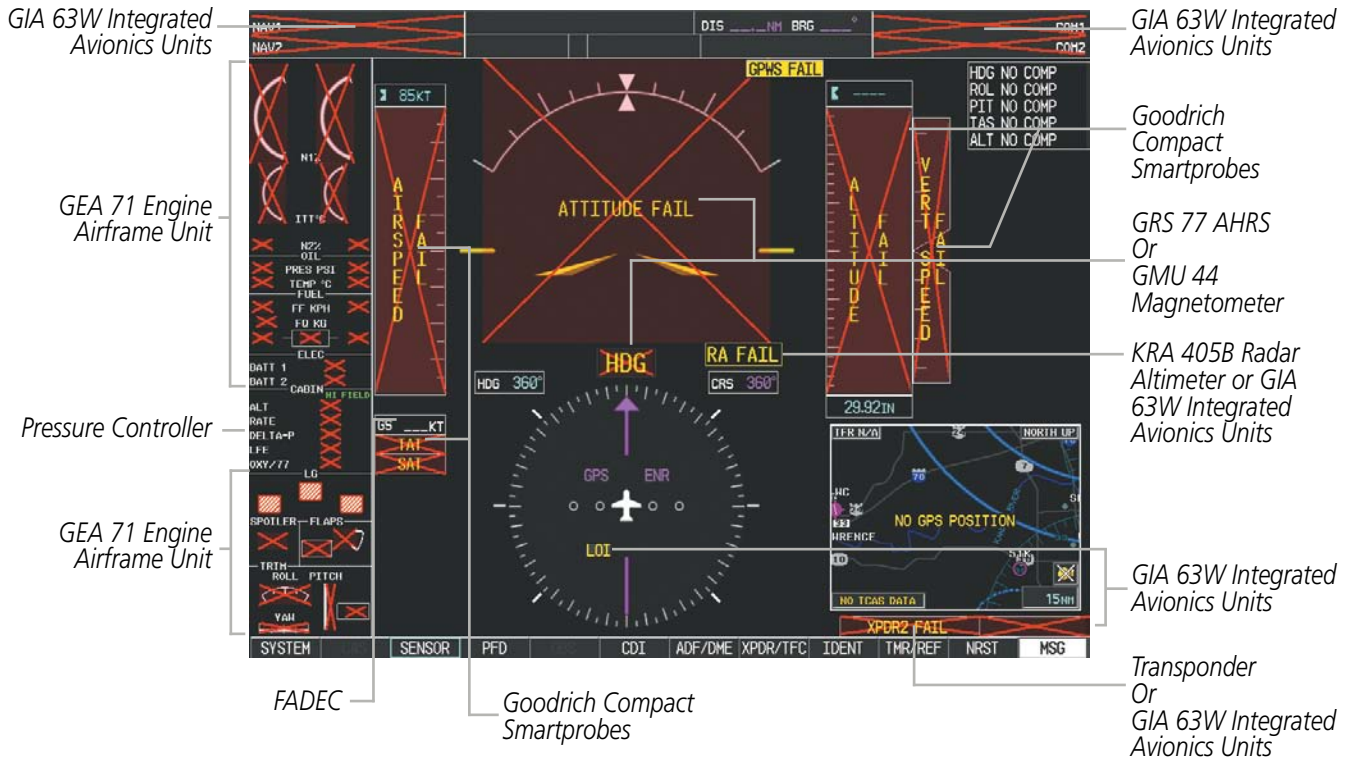











Figure A-3 System Messages



**Figure A-4 System Failure Annunciations**

System Annunciation	Comment
	Attitude and Heading Reference System is aligning.
	Display system is not receiving attitude information from the AHRS.
	Indicates a configuration module failure.
	Display system is not receiving airspeed input from air data computer.

System Annunciation	Comment
	Display system is not receiving valid heading input from AHRS.
	Display system is not receiving altitude input from the air data computer.
	Display system is not receiving vertical speed input from the air data computer.
	Display system is not receiving valid transponder information.
	GPS information is either not present or is invalid for navigation use. Note that AHRS utilizes GPS inputs during normal operation. AHRS operation may be degraded if GPS signals are not present (see AFM).
Other Various Red X Indications	A red "X" through any other display field (such as engine instrumentation display) indicates that the field is not receiving valid data.

### PRODIGY® SYSTEM MESSAGE ADVISORIES



**NOTE:** This Section provides information regarding message advisories that may be displayed by the system. Knowledge of the aircraft, systems, flight conditions, and other existing operational priorities must be considered when responding to a message. Always use sound pilot judgment. The Phenom 300 Airplane Flight Manual (AFM) takes precedence over any conflicting guidance found in this section.

This section describes various system message advisories. Certain messages are issued due to an LRU or an LRU function failure. Such messages are normally accompanied by a corresponding red "X" annunciation as shown previously in the Prodigy® System Annunciation section.

**MFD & PFD MESSAGE ADVISORIES**

Message	Comments
<b>DATA LOST</b> – Pilot stored data was lost. Recheck settings.	The pilot profile data was lost. System reverts to default pilot profile and settings. The pilot may reconfigure the MFD & PFDs with preferred settings, if desired.
<b>XTALK ERROR</b> – A flight display crosstalk error has occurred.	The MFD and PFDs are not communicating with each other. The system should be serviced.
<b>PFD1 SERVICE</b> – PFD1 needs service. Return unit for repair.	The PFD and/or MFD self-test has detected a problem. The system should be serviced.
<b>PFD2 SERVICE</b> – PFD2 needs service. Return unit for repair.	
<b>MFD1 SERVICE</b> – MFD1 needs service. Return unit for repair.	
<b>MANIFEST</b> – PFD1 software mismatch, communication halted.	The PFD and/or MFD has incorrect software installed. The system should be serviced.
<b>MANIFEST</b> – PFD2 software mismatch, communication halted.	
<b>MANIFEST</b> – MFD1 software mismatch, communication halted.	
<b>PFD1 CONFIG</b> – PFD1 config error. Config service req'd.	The PFD configuration settings do not match backup configuration memory. The system should be serviced.
<b>PFD2 CONFIG</b> – PFD2 config error. Config service req'd.	
<b>MFD1 CONFIG</b> – MFD1 config error. Config service req'd.	The MFD configuration settings do not match backup configuration memory. The system should be serviced.
<b>SW MISMATCH</b> – GDU software version mismatch. Xtalk is off.	The MFD and PFDs have different software versions installed. The system should be serviced.
<b>PFD1 COOLING</b> – PFD1 has poor cooling. Reducing power usage.	The PFD and/or MFD is overheating and is reducing power consumption by dimming the display. If problem persists, the system should be serviced.
<b>PFD2 COOLING</b> – PFD2 has poor cooling. Reducing power usage.	
<b>MFD1 COOLING</b> – MFD1 has poor cooling. Reducing power usage.	
<b>PFD1 KEYSTK</b> – PFD1 [key name] Key is stuck.	A key is stuck on the PFD and/or MFD bezel. Attempt to free the stuck key by pressing it several times. The system should be serviced if the problem persists.
<b>PFD2 KEYSTK</b> – PFD2 [key name] Key is stuck.	
<b>MFD1 KEYSTK</b> – MFD [key name] Key is stuck.	
<b>CNFG MODULE</b> – PFD1 configuration module is inoperative.	The PFD1 configuration module backup memory has failed. The system should be serviced.
<b>PFD1 VOLTAGE</b> – PFD1 has low voltage. Reducing power usage	The PFD1 voltage is low. The system should be serviced.



### MFD & PFD MESSAGE ADVISORIES (CONT.)

Message	Comments
<b>PFD2 VOLTAGE</b> – PFD2 has low voltage. Reducing power usage	The PFD2 voltage is low. The system should be serviced.
<b>MFD1 VOLTAGE</b> – MFD1 has low voltage. Reducing power usage	The MFD voltage is low. The system should be serviced.

### DATABASE MESSAGE ADVISORIES

Message	Comments
<b>MFD1 DB ERR</b> – MFD1 navigation database error exists.	The MFD and/or PFD detected a failure in the navigation database. Attempt to reload the navigation database. If problem persists, the system should be serviced.
<b>PFD1 DB ERR</b> – PFD1 navigation database error exists.	
<b>PFD2 DB ERR</b> – PFD2 navigation database error exists.	
<b>MFD1 DB ERR</b> – MFD1 basemap database error exists.	The MFD and/or PFD detected a failure in the basemap database.
<b>PFD1 DB ERR</b> – PFD1 basemap database error exists.	
<b>PFD2 DB ERR</b> – PFD2 basemap database error exists.	
<b>MFD1 DB ERR</b> – MFD1 terrain database error exists.	The MFD and/or PFD detected a failure in the terrain database. Ensure that the terrain card is properly inserted in display. Replace terrain card. If problem persists, the system should be serviced.
<b>PFD1 DB ERR</b> – PFD1 terrain database error exists.	
<b>PFD2 DB ERR</b> – PFD2 terrain database error exists.	
<b>MFD1 DB ERR</b> – MFD1 terrain database missing.	The terrain database is present on another LRU, but is missing on the specified LRU.
<b>PFD1 DB ERR</b> – PFD1 terrain database missing.	
<b>PFD2 DB ERR</b> – PFD2 terrain database missing.	
<b>MFD1 DB ERR</b> – MFD1 obstacle database error exists.	The MFD and/or PFD detected a failure in the obstacle database. Ensure that the data card is properly inserted. Replace data card. If problem persists, the system should be serviced.
<b>PFD1 DB ERR</b> – PFD1 obstacle database error exists.	
<b>PFD2 DB ERR</b> – PFD2 obstacle database error exists.	

**DATABASE MESSAGE ADVISORIES (CONT.)**

Message	Comments
<b>MFD1 DB ERR</b> – MFD1 obstacle database missing.	The obstacle database is present on another LRU, but is missing on the specified LRU.
<b>PFD1 DB ERR</b> – PFD1 obstacle database missing.	
<b>PFD2 DB ERR</b> – PFD2 obstacle database missing.	
<b>MFD1 DB ERR</b> – MFD1 airport terrain database error exists.	The MFD and/or PFD detected a failure in the airport terrain database. Ensure that the data card is properly inserted. Replace data card. If problem persists, the system should be serviced.
<b>PFD1 DB ERR</b> – PFD1 airport terrain database error exists.	
<b>PFD2 DB ERR</b> – PFD2 airport terrain database error exists.	
<b>MFD1 DB ERR</b> – MFD1 airport terrain database missing.	The airport terrain database is present on another LRU, but is missing on the specified LRU.
<b>PFD1 DB ERR</b> – PFD1 airport terrain database missing.	
<b>PFD2 DB ERR</b> – PFD2 airport terrain database missing.	
<b>MFD1 DB ERR</b> – MFD1 Safe Taxi database error exists.	The MFD and/or PFD detected a failure in the Safe Taxi database. Ensure that the data card is properly inserted. Replace data card. If problem persists, the system should be serviced.
<b>PFD1 DB ERR</b> – PFD1 Safe Taxi database error exists.	
<b>PFD2 DB ERR</b> – PFD2 Safe Taxi database error exists.	
<b>MFD1 DB ERR</b> – MFD1 Chartview database error exists.	The MFD detected a failure in the ChartView database (optional feature). Ensure the data card is properly inserted. Replace data card. If problem persists, system should be serviced.
<b>MFD1 DB ERR</b> – MFD1 FliteCharts database error exists.	The MFD detected a failure in the FliteCharts database (optional feature). Ensure the data card is properly inserted. Replace data card. If problem persists, system should be serviced.
<b>MFD1 DB ERR</b> – MFD1 Airport Directory database error exists.	The MFD detected a failure in the Airport Directory database. Ensure that the data card is properly inserted. Replace data card. If problem persists, the system should be serviced.
<b>DB MISMATCH</b> – Navigation database mismatch. Xtalk is off.	The PFDs and MFD have different navigation database versions or types (Americas, European, etc.) installed. Crossfill is off. Install correct navigation database version or type in all displays.
<b>DB MISMATCH</b> – Standby Navigation database mismatch.	The PFDs and MFD have different standby navigation database versions or types (Americas, European, etc.) installed. Install correct standby navigation database version or type in all displays.
<b>DB MISMATCH</b> – Terrain database mismatch.	The PFDs and MFD have different terrain database versions or types installed. Install correct terrain database version or type in all displays.
<b>DB MISMATCH</b> – Obstacle database mismatch.	The PFDs and MFD have different obstacle database installed. Install correct obstacle database in all displays.
<b>DB MISMATCH</b> – Airport Terrain database mismatch.	The PFDs and MFD have different airport terrain databases installed. Install correct airport terrain database in all displays.

### DATABASE MESSAGE ADVISORIES (CONT.)

Message	Comments
<b>NAV DB UPDATED</b> – Active navigation database updated.	System has updated the active navigation database from the standby navigation database.
<b>TERRAIN DSP</b> – [PFD1, PFD2 or MFD1] Terrain awareness display unavailable.	One of the terrain, airport terrain, or obstacle databases required for TAWS in the specified PFD or MFD is missing or invalid.

### GMA 1347D MESSAGE ADVISORIES

Message	Comments
<b>GMA1 FAIL</b> – GMA1 is inoperative.	The audio panel self-test has detected a failure. The audio panel is unavailable. The system should be serviced.
<b>GMA2 FAIL</b> – GMA2 is inoperative.	
<b>GMA XTALK</b> – GMA crosstalk error has occurred.	An error has occurred in transferring data between the two GMAs. The system should be serviced.
<b>GMA1 CONFIG</b> – GMA1 config error. Config service req'd.	The audio panel configuration settings do not match backup configuration memory. The system should be serviced.
<b>GMA2 CONFIG</b> – GMA2 config error. Config service req'd.	
<b>MANIFEST</b> – GMA1 software mismatch, communication halted.	The audio panel has incorrect software installed. The system should be serviced.
<b>MANIFEST</b> – GMA2 software mismatch, communication halted.	
<b>GMA1 SERVICE</b> – GMA1 needs service. Return unit for repair.	The audio panel self-test has detected a problem in the unit. Certain audio functions may still be available, and the audio panel may still be usable. The system should be serviced when possible.
<b>GMA2 SERVICE</b> – GMA2 needs service. Return unit for repair.	

### GIA 63W MESSAGE ADVISORIES

Message	Comments
<b>GIA1 CONFIG</b> – GIA1 config error. Config service req'd.	The GIA1 and/or GIA2 configuration settings do not match backup configuration memory. The system should be serviced.
<b>GIA2 CONFIG</b> – GIA2 config error. Config service req'd.	
<b>GIA1 CONFIG</b> – GIA1 audio config error. Config service req'd.	The GIA1 and/or GIA2 have an error in the audio configuration. The system should be serviced.
<b>GIA2 CONFIG</b> – GIA2 audio config error. Config service req'd.	
<b>GIA1 COOLING</b> – GIA1 temperature too low.	The GIA1 and/or GIA2 temperature is too low to operate correctly. Allow units to warm up to operating temperature.
<b>GIA2 COOLING</b> – GIA2 temperature too low.	
<b>GIA1 COOLING</b> – GIA1 over temperature.	The GIA1 and/or GIA2 temperature is too high. If problem persists, the system should be serviced.
<b>GIA2 COOLING</b> – GIA2 over temperature.	

**GIA 63W MESSAGE ADVISORIES (CONT.)**

Message	Comments
<b>GIA1 SERVICE</b> – GIA1 needs service. Return the unit for repair.	The GIA1 and/or GIA2 self-test has detected a problem in the unit. The system should be serviced.
<b>GIA2 SERVICE</b> – GIA2 needs service. Return the unit for repair.	
<b>HW MISMATCH</b> – GIA hardware mismatch. GIA1 communication halted.	A GIA mismatch has been detected, where only one is SBAS capable.
<b>HW MISMATCH</b> – GIA hardware mismatch. GIA2 communication halted.	
<b>MANIFEST</b> – GIA1 software mismatch, communication halted.	The GIA1 and/or GIA 2 has incorrect software installed. The system should be serviced.
<b>MANIFEST</b> – GIA2 software mismatch, communication halted.	
<b>MANIFEST</b> – GFC software mismatch, communication halted.	Incorrect servo software is installed, or gain settings are incorrect.
<b>COM1 TEMP</b> – COM1 over temp. Reducing transmitter power.	The system has detected an over temperature condition in COM1 and/or COM2. The transmitter is operating at reduced power. If the problem persists, the system should be serviced.
<b>COM2 TEMP</b> – COM2 over temp. Reducing transmitter power.	
<b>COM1 SERVICE</b> – COM1 needs service. Return unit for repair.	The system has detected a failure in COM1 and/or COM2. COM1 and/or COM2 may still be usable. The system should be serviced when possible.
<b>COM2 SERVICE</b> – COM2 needs service. Return unit for repair.	
<b>COM1 PTT</b> – COM1 push-to-talk key is stuck.	The COM1 and/or COM2 external push-to-talk switch is stuck in the enable (or “pressed”) position. Press the PTT switch again to cycle its operation. If the problem persists, the system should be serviced.
<b>COM2 PTT</b> – COM2 push-to-talk key is stuck.	
<b>COM1 RMT XFR</b> – COM1 remote transfer key is stuck.	The COM1 and/or COM2 transfer switch is stuck in the enabled (or “pressed”) position. Press the transfer switch again to cycle its operation. If the problem persists, the system should be serviced.
<b>COM2 RMT XFR</b> – COM2 remote transfer key is stuck.	
<b>LOI</b> – GPS integrity lost. Crosscheck with other NAVS.	GPS integrity is insufficient for the current phase of flight.
<b>GPS NAV LOST</b> – Loss of GPS navigation. Insufficient satellites.	Loss of GPS navigation due to insufficient satellites.
<b>GPS NAV LOST</b> – Loss of GPS navigation. Position error.	Loss of GPS navigation due to position error.
<b>GPS NAV LOST</b> – Loss of GPS navigation. GPS fail.	Loss of GPS navigation due to GPS failure.
<b>ABORT APR</b> – Loss of GPS navigation. Abort approach.	Abort approach due to loss of GPS navigation.

**GIA 63W MESSAGE ADVISORIES (CONT.)**

Message	Comments
<b>APR DWNGRADE</b> – Approach downgraded.	Vertical guidance generated by SBAS is unavailable, use LNAV only minimums.
<b>TRUE APR</b> – True north approach. Change HDG reference to TRUE.	Displayed after passing the first waypoint of a true north approach when the nav angle is set to 'AUTO'.
<b>GPS1 SERVICE</b> – GPS1 needs service. Return unit for repair.	A failure has been detected in the GPS1 and/or GPS2 receiver. The receiver may still be available. The system should be serviced.
<b>GPS2 SERVICE</b> – GPS2 needs service. Return unit for repair.	
<b>NAV1 SERVICE</b> – NAV1 needs service. Return unit for repair.	A failure has been detected in the NAV1 and/or NAV2 receiver. The receiver may still be available. The system should be serviced.
<b>NAV2 SERVICE</b> – NAV2 needs service. Return unit for repair.	
<b>NAV1 RMT XFR</b> – NAV1 remote transfer key is stuck.	The remote NAV1 and/or NAV2 transfer switch is stuck in the enabled (or “pressed”) state. Press the transfer switch again to cycle its operation. If the problem persists, the system should be serviced.
<b>NAV2 RMT XFR</b> – NAV2 remote transfer key is stuck.	
<b>G/S1 FAIL</b> – G/S1 is inoperative.	A failure has been detected in glideslope receiver 1 and/or receiver 2. The system should be serviced.
<b>G/S2 FAIL</b> – G/S2 is inoperative.	
<b>G/S1 SERVICE</b> – G/S1 needs service. Return unit for repair.	A failure has been detected in glideslope receiver 1 and/or receiver 2. The receiver may still be available. The system should be serviced when possible.
<b>G/S2 SERVICE</b> – G/S2 needs service. Return unit for repair.	

**GSD 41 MESSAGE ADVISORIES**

Message	Comments
<b>GSD1 CONFIG</b> – GSD1 config error. Config service req'd.	GSD1 and the CDU have different copies of the GSD1 configuration.
<b>GSD2 CONFIG</b> – GSD2 config error. Config service req'd.	GSD2 and the CDU have different copies of the GSD2 configuration.
<b>GSD1 COOLING</b> – GSD1 temperature too low.	GSD1 is reporting a low temperature condition.
<b>GSD2 COOLING</b> – GSD2 temperature too low.	GSD2 is reporting a low temperature condition.
<b>GSD1 COOLING</b> – GSD1 over temperature.	GSD1 is reporting an over-temperature condition.
<b>GSD2 COOLING</b> – GSD2 over temperature.	GSD2 is reporting an over-temperature condition.
<b>GSD1 SERVICE</b> – GSD1 needs service. Return unit for repair.	GSD1 is reporting an internal error condition. The GSD may still be usable.

**GSD 41 MESSAGE ADVISORIES (CONT.)**

Message	Comments
<b>GSD2 SERVICE</b> – GSD2 needs service. Return unit for repair.	GSD2 is reporting an internal error condition. The GSD may still be usable.
<b>MANIFEST</b> – GSD1 software mismatch. Communication halted.	GSD1 has incorrect software installed. The system should be serviced.
<b>MANIFEST</b> – GSD2 software mismatch. Communication halted.	GSD2 has incorrect software installed. The system should be serviced.

**GEA 71 MESSAGE ADVISORIES**

Message	Comments
<b>GEA1 CONFIG</b> – GEA1 config error. Config service req'd.	The GEA1 configuration settings do not match those of backup configuration memory. The system should be serviced.
<b>GEA2 CONFIG</b> – GEA2 config error. Config service req'd.	The GEA2 configuration settings do not match those of backup configuration memory. The system should be serviced.
<b>GEA3 CONFIG</b> – GEA3 config error. Config service req'd.	The GEA3 configuration settings do not match those of backup configuration memory. The system should be serviced.
<b>MANIFEST</b> – GEA1 software mismatch, communication halted.	The #1 GEA 71 has incorrect software installed. The system should be serviced.
<b>MANIFEST</b> – GEA2 software mismatch, communication halted.	The #2 GEA 71 has incorrect software installed. The system should be serviced.
<b>MANIFEST</b> – GEA3 software mismatch, communication halted.	The #3 GEA 71 has incorrect software installed. The system should be serviced.

**GTX 33 MESSAGE ADVISORIES**

Message	Comments
<b>XPDR1 CONFIG</b> – XPDR1 config error. Config service req'd.	The transponder configuration settings do not match those of backup configuration memory. The system should be serviced.
<b>XPDR2 CONFIG</b> – XPDR2 config error. Config service req'd.	The transponder configuration settings do not match those of backup configuration memory. The system should be serviced.
<b>MANIFEST</b> – GTX1 software mismatch, communication halted.	The transponder has incorrect software installed. The system should be serviced.
<b>MANIFEST</b> – GTX2 software mismatch, communication halted.	The transponder has incorrect software installed. The system should be serviced.
<b>XPDR1 SRVC</b> – XPDR1 needs service. Return unit for repair.	The #1 transponder should be serviced when possible.
<b>XPDR2 SRVC</b> – XPDR2 needs service. Return unit for repair.	The #2 transponder should be serviced when possible.
<b>XPDR1 FAIL</b> – XPDR1 is inoperative.	There is no communication with the #1 transponder.
<b>XPDR2 FAIL</b> – XPDR2 is inoperative.	There is no communication with the #2 transponder.

## GRS 77 MESSAGE ADVISORIES

Message	Comments
<b>AHRS1 TAS</b> – AHRS1 not receiving airspeed.	The #1 AHRS is not receiving true airspeed from the air data computer. The AHRS relies on GPS information to augment the lack of airspeed. The system should be serviced.
<b>AHRS2 TAS</b> – AHRS2 not receiving airspeed.	The #2 AHRS is not receiving true airspeed from the air data computer. The AHRS relies on GPS information to augment the lack of airspeed. The system should be serviced.
<b>AHRS1 GPS</b> – AHRS1 using backup GPS source.	The #1 AHRS is using the backup GPS path. Primary GPS path has failed. The system should be serviced when possible.
<b>AHRS2 GPS</b> – AHRS2 using backup GPS source.	The #2 AHRS is using the backup GPS path. Primary GPS path has failed. The system should be serviced when possible.
<b>AHRS1 GPS</b> – AHRS1 not receiving any GPS information.	The #1 AHRS is not receiving any or any useful GPS information. Check AFMS limitations. The system should be serviced.
<b>AHRS2 GPS</b> – AHRS2 not receiving any GPS information.	The #2 AHRS is not receiving any or any useful GPS information. Check AFMS limitations. The system should be serviced.
<b>AHRS1 GPS</b> – AHRS1 not receiving backup GPS information.	The #1 AHRS is not receiving backup GPS information. The system should be serviced.
<b>AHRS2 GPS</b> – AHRS2 not receiving backup GPS information.	The #2 AHRS is not receiving backup GPS information. The system should be serviced.
<b>AHRS1 GPS</b> – AHRS1 operating exclusively in no-GPS mode.	The #1 AHRS is operating exclusively in no-GPS mode. The system should be serviced.
<b>AHRS2 GPS</b> – AHRS2 operating exclusively in no-GPS mode.	The #2 AHRS is operating exclusively in no-GPS mode. The system should be serviced.
<b>AHRS MAG DB</b> – AHRS magnetic model database version mismatch.	The #1 AHRS and #2 AHRS magnetic model database versions do not match.
<b>AHRS1 SRVC</b> – AHRS1 Magnetic-field model needs update.	The #1 AHRS earth magnetic field model is out of date. Update magnetic field model when practical.
<b>AHRS2 SRVC</b> – AHRS2 Magnetic-field model needs update.	The #2 AHRS earth magnetic field model is out of date. Update magnetic field model when practical.
<b>GEO LIMITS</b> – AHRS1 too far North/South, no magnetic compass.	The aircraft is outside geographical limits for approved AHRS operation. Heading is flagged as invalid.
<b>GEO LIMITS</b> – AHRS2 too far North/South, no magnetic compass.	
<b>MANIFEST</b> – GRS1 software mismatch, communication halted.	The #1 AHRS has incorrect software installed. The system should be serviced.
<b>MANIFEST</b> – GRS2 software mismatch, communication halted.	The #2 AHRS has incorrect software installed. The system should be serviced.



**GMU 44 MESSAGE ADVISORIES**

Message	Comments
<b>HDG FAULT</b> – AHRS1 magnetometer fault has occurred.	A fault has occurred in the #1 GMU 44. Heading is flagged as invalid. The AHRS uses GPS for backup mode operation. The system should be serviced.
<b>HDG FAULT</b> – AHRS2 magnetometer fault has occurred.	A fault has occurred in the #2 GMU 44. Heading is flagged as invalid. The AHRS uses GPS for backup mode operation. The system should be serviced.
<b>MANIFEST</b> – GMU1 software mismatch, communication halted.	The GMU 44 has incorrect software installed. The system should be serviced.
<b>MANIFEST</b> – GMU2 software mismatch, communication halted.	

**GSR 56 MESSAGE ADVISORIES**

Message	Comments
<b>GSR1 FAIL</b> – GSR1 has failed.	A failure has been detected in the #1 GSR 56. The system should be serviced.
<b>GSR2 FAIL</b> – GSR2 has failed.	A failure has been detected in the #2 GSR 56. The system should be serviced.

**GDL 59 MESSAGE ADVISORIES**

Message	Comments
<b>GDL59 CONFIG</b> – GDL 59 config error. Config service req'd.	GDL 59 configuration settings do not match those of backup configuration memory. The system should be serviced.
<b>GDL59 FAIL</b> – GDL 59 has failed.	A failure has been detected in the GDL 59. The receiver is unavailable. The system should be serviced.
<b>GDL59 SERVICE</b> – GDL 59 needs service. Return unit for repair.	A failure has been detected in the GDL 59. The system should be serviced.
<b>GDL59 RTR FAIL</b> – The GDL 59 router has failed.	A failure has been detected in the GDL 59 router. The system should be serviced.
<b>REGISTER GFDS</b> – Data services are inoperative, register w/GFDS.	The GDL 59 is not registered with Garmin Flight Data Services, or its current registration data has failed authentication.
<b>MANIFEST</b> – GDL software mismatch, communication halted.	The GDL 59 has incorrect software installed. The system should be serviced.

**GDL 69A MESSAGE ADVISORIES**

Message	Comments
<b>GDL69 CONFIG</b> – GDL 69 config error. Config service req'd.	GDL 69 configuration settings do not match those of backup configuration memory. The system should be serviced.
<b>GDL69 FAIL</b> – GDL 69 has failed.	A failure has been detected in the GDL 69. The receiver is unavailable. The system should be serviced.
<b>MANIFEST</b> – GDL software mismatch, communication halted.	The GDL 69 has incorrect software installed. The system should be serviced.

### GWX 68 ALERT MESSAGES

Message	Comments
<b>GWX CONFIG</b> – GWX config error. Config service req'd.	GWX 68 configuration settings do not match those of the GDU configuration. The system should be serviced.
<b>GWX FAIL</b> – GWX is inoperative.	The GDU is not receiving status packet from the GWX 68 or the GWX 68 is reporting a fault. The GWX 68 radar system should be serviced.
<b>GWX SERVICE</b> – GWX needs service. Return unit for repair.	A failure has been detected in the GWX 68. The GWX 68 may still be usable.
<b>MANIFEST</b> – GWX software mismatch, communication halted.	The GWX 68 has incorrect software installed. The system should be serviced.
<b>WX ALERT</b> – Possible severe weather ahead.	Possible severe weather detected within +/- 10 degrees of the aircraft heading at a range of 80 to 320 nm.

### GCU 477 MESSAGE ADVISORIES

Message	Comments
<b>GCU CNFG</b> – GCU Config error. Config service req'd.	GCU 477 configuration settings do not match those of backup configuration memory. The system should be serviced.
<b>GCU FAIL</b> – GCU is inoperative.	A failure has been detected in the GCU 477. The GCU 477 is unavailable.
<b>MANIFEST</b> – GCU software mismatch, communication halted.	The GCU 477 has incorrect software installed. The system should be serviced.
<b>GCU KEYSTK</b> – GCU [key name] Key is stuck.	A key is stuck on the GCU 477 bezel. Attempt to free the stuck key by pressing it several times. The system should be serviced if the problem persists.

### GMC 715 MESSAGE ADVISORIES

Message	Comments
<b>GMC CONFIG</b> – GMC Config error. Config service req'd.	Error in the configuration of the GMC 715.
<b>GMC FAIL</b> – GMC is inoperative.	A failure has been detected in the GMC 715. The GMC 715 is unavailable.
<b>MANIFEST</b> – GMC software mismatch. Communication halted.	The GMC 715 has incorrect software installed. The system should be serviced.
<b>GMC KEYSTK</b> – GMC [key name] Key is stuck.	A key is stuck on the GMC 715 bezel. Attempt to free the stuck key by pressing it several times. The system should be serviced if the problem persists.

### MISCELLANEOUS MESSAGE ADVISORIES

Message	Comments
<b>FPL WPT LOCK</b> – Flight plan waypoint is locked.	<p>Upon power-up, the system detects that a stored flight plan waypoint is locked. This occurs when a navigation database update eliminates an obsolete waypoint. The flight plan cannot find the specified waypoint and flags this message. This can also occur with user waypoints in a flight plan that is deleted.</p> <p>Remove the waypoint from the flight plan if it no longer exists in any database, Or update the waypoint name/identifier to reflect the new information.</p>

**MISCELLANEOUS MESSAGE ADVISORIES (CONT.)**

Message	Comments
<b>FPL WPT MOVE</b> – Flight plan waypoint moved.	The system has detected that a waypoint coordinate has changed due to a new navigation database update. Verify that stored flight plans contain correct waypoint locations.
<b>TIMER EXPIRD</b> – Timer has expired.	The system notifies the pilot that the timer has expired.
<b>DB CHANGE</b> – Database changed. Verify user modified procedures.	This occurs when a stored flight plan contains procedures that have been manually edited. This alert is issued only after an navigation database update. Verify that the user-modified procedures in stored flight plans are correct and up to date.
<b>DB CHANGE</b> – Database changed. Verify stored airways.	This occurs when a stored flight plan contains an airway that is no longer consistent with the navigation database. This alert is issued only after an navigation database update. Verify use of airways in stored flight plans and reload airways as needed.
<b>FPL TRUNC</b> – Flight plan has been truncated.	This occurs when a newly installed navigation database eliminates an obsolete approach or arrival used by a stored flight plan. The obsolete procedure is removed from the flight plan. Update flight plan with current arrival or approach.
<b>LOCKED FPL</b> – Cannot navigate locked flight plan.	This occurs when the pilot attempts to activate a stored flight plan that contains locked waypoint. Remove locked waypoint from flight plan. Update flight plan with current waypoint.
<b>WPT ARRIVAL</b> – Arriving at waypoint -[xxxx]	Arriving at waypoint [xxxx], where [xxxx] is the waypoint name.
<b>STEEP TURN</b> – Steep turn ahead.	A steep turn is 15 seconds ahead. Prepare to turn.
<b>INSIDE ARSPC</b> – Inside airspace.	The aircraft is inside the airspace.
<b>ARSPC AHEAD</b> – Airspace ahead less than 10 minutes.	Special use airspace is ahead of aircraft. The aircraft will penetrate the airspace within 10 minutes.
<b>ARSPC NEAR</b> – Airspace near and ahead.	Special use airspace is near and ahead of the aircraft position.
<b>ARSPC NEAR</b> – Airspace near – less than 2 nm.	Special use airspace is within 2 nm of the aircraft position.
<b>APR INACTV</b> – Approach is not active.	The system notifies the pilot that the loaded approach is not active. Activate approach when required.
<b>SLCT FREQ</b> – Select appropriate frequency for approach.	The system notifies the pilot to load the approach frequency for the appropriate NAV receiver. Select the correct frequency for the approach.
<b>SLCT NAV</b> – Select NAV on CDI for approach.	The system notifies the pilot to set the CDI to the correct NAV receiver. Set the CDI to the correct NAV receiver.
<b>PTK FAIL</b> – Parallel track unavailable: bad geometry.	Bad parallel track geometry.
<b>PTK FAIL</b> – Parallel track unavailable: past IAF.	IAF waypoint for parallel offset has been passed.
<b>PTK FAIL</b> – Parallel track unavailable: past IAF.	IAF waypoint for parallel offset has been passed.
<b>UNABLE V WPT</b> – Can't reach current vertical waypoint.	The current vertical waypoint can not be reached within the maximum flight path angle and vertical speed constraints. The system automatically transitions to the next vertical waypoint.

## MISCELLANEOUS MESSAGE ADVISORIES (CONT.)

Message	Comments
<b>VNV</b> – Unavailable. Unsupported leg type in flight plan.	The lateral flight plan contains a procedure turn, vector, or other unsupported leg type prior to the active vertical waypoint. This prevents vertical guidance to the active vertical waypoint.
<b>VNV</b> – Unavailable. Excessive track angle error.	The current track angle error exceeds the limit, causing the vertical deviation to go invalid.
<b>VNV</b> – Unavailable. Excessive crosstrack error.	The current crosstrack exceeds the limit, causing vertical deviation to go invalid.
<b>VNV</b> – Unavailable. Parallel course selected.	A parallel course has been selected, causing the vertical deviation to go invalid.
<b>NON WGS84 WPT</b> – Do not use GPS navigation to [xxxx].	The position of the selected waypoint [xxxx] is not calculated based on the WGS84 map reference datum and may be positioned in error as displayed. Do not use GPS to navigate to the selected non-WGS84 waypoint.
<b>TRAFFIC FAIL</b> – Traffic device has failed.	The system is no longer receiving data from the traffic system. The traffic device should be serviced.
<b>FAILED PATH</b> – A data path has failed.	A data path connected to the GDU, GSD 41, or the GIA 63/W has failed.
<b>MAG VAR WARN</b> – Large magnetic variance. Verify all course angles.	The GDU's internal model cannot determine the exact magnetic variance for geographic locations near the magnetic poles. Displayed magnetic course angles may differ from the actual magnetic heading by more than 2°.
<b>SVS</b> – SVS DISABLED: Out of available terrain region.	Synthetic Vision is disabled because the aircraft is not within the boundaries of the installed terrain database.
<b>SVS</b> – SVS DISABLED: Terrain DB resolution too low.	Synthetic Vision is disabled because a terrain database of sufficient resolution (9 arc-second or better) is not currently installed.
<b>SCHEDULER [#]</b> – <message>.	Message criteria entered by the user.
<b>CHECK CRS</b> – Database course for LOC1 / [LOC ID] is [CRS]°.	Selected course for LOC1 differs from published localizer course by more than 10 degrees.
<b>CHECK CRS</b> – Database course for LOC2 / [LOC ID] is [CRS]°.	Selected course for LOC2 differs from published localizer course by more than 10 degrees.
<b>[PFD1, PFD2, or MFD1] CARD 1 REM</b> – Card 1 was removed. Reinsert card.	The SD card was removed from the top card slot of the specified PFD or MFD. The SD card needs to be reinserted.
<b>[PFD1, PFD2, or MFD1] CARD 2 REM</b> – Card 2 was removed. Reinsert card.	The SD card was removed from the bottom card slot of the specified PFD or MFD. The SD card needs to be reinserted.
<b>[PFD1, PFD2, or MFD1] CARD 1 ERR</b> – Card 1 is invalid.	The SD card in the top card slot of the specified PFD or MFD contains invalid data.
<b>[PFD1, PFD2, or MFD1] CARD 2 ERR</b> – Card 2 is invalid.	The SD card in the bottom card slot of the specified PFD or MFD contains invalid data.

**TAWS-A ALERTS**

Alert Type	PFD/MFD TAWS-A Page Annunciation	MFD Map Page Pop-Up Alert	Aural Message
Reduced Required Terrain Clearance Warning (RTC)	<b>PULL UP</b>	<b>TERRAIN - PULL-UP</b>	"Terrain, Terrain; Pull Up, Pull Up"
Imminent Terrain Impact Warning (ITI)	<b>PULL UP</b>	<b>TERRAIN - PULL-UP</b>	"Terrain, Terrain; Pull Up, Pull Up"
Reduced Required Obstacle Clearance Warning (ROC)	<b>PULL UP</b>	<b>OBSTACLE - PULL-UP</b>	"Obstacle, Obstacle; Pull Up, Pull Up"
Imminent Obstacle Impact Warning (IOI)	<b>PULL UP</b>	<b>OBSTACLE - PULL-UP</b>	"Obstacle, Obstacle; Pull Up, Pull Up"
Excessive Descent Rate Warning (EDR)	<b>PULL UP</b>	<b>PULL-UP</b>	"<whoop><whoop> Pull Up"
Excessive Closure Rate Warning (ECR)	<b>PULL UP</b>	<b>PULL-UP</b>	"<whoop><whoop> Pull Up"
Reduced Required Terrain Clearance Caution (RTC)	<b>TERRAIN</b>	<b>CAUTION - TERRAIN</b>	"Caution, Terrain; Caution, Terrain"
Imminent Terrain Impact Caution (ITI)	<b>TERRAIN</b>	<b>CAUTION - TERRAIN</b>	"Caution, Terrain; Caution, Terrain"
Reduced Required Obstacle Clearance Caution (ROC)	<b>TERRAIN</b>	<b>CAUTION - OBSTACLE</b>	"Caution, Obstacle; Caution, Obstacle"
Imminent Obstacle Impact Caution (IOI)	<b>TERRAIN</b>	<b>CAUTION - OBSTACLE</b>	"Caution, Obstacle; Caution, Obstacle"
Premature Descent Alert Caution (PDA)	<b>TERRAIN</b>	<b>TOO LOW - TERRAIN</b>	"Too Low, Terrain"
Excessive Descent Rate Caution (EDR)	<b>TERRAIN</b>	<b>SINK RATE</b>	"Sink Rate"
Excessive Closure Rate Caution (ECR)	<b>TERRAIN</b>	<b>TERRAIN</b>	"Terrain, Terrain"
Negative Climb Rate Caution (NCR)	<b>TERRAIN</b>	<b>DON'T SINK</b>	"Don't Sink"
Flight Into Terrain High Speed Caution (FIT)	<b>TERRAIN</b>	<b>TOO LOW - TERRAIN</b>	"Too Low, Terrain"
Flight Into Terrain Gear Caution (FIT)	<b>TERRAIN</b>	<b>TOO LOW - GEAR</b>	"Too Low, Gear"
Flight Into Terrain Flaps Caution (FIT)	<b>TERRAIN</b>	<b>TOO LOW - FLAPS</b>	"Too Low, Flaps"
Flight Into Terrain Takeoff Caution (FIT)	<b>TERRAIN</b>	<b>TOO LOW - TERRAIN</b>	"Too Low, Terrain"
Glide Slope/Glide Path Deviation Caution (GSD) (depends on approach type)	<b>GLIDESLOPE</b> or <b>GLIDEPATH</b>	<b>GLIDESLOPE</b> or <b>GLIDEPATH</b>	"Glide Slope" or "Glide Path"
Altitude Voice Callout (VCO)	None	None	"Five-Hundred" "Four-Hundred" "Three-Hundred" "Two-Hundred" "One-Hundred"

### TAWS-A SYSTEM STATUS ANNUNCIATIONS

Alert Type	PFD/MFD TAWS-A Page Annunciation	Additional TAWS-A Page Annunciation	Aural Message
TAWS System Fail, Terrain or Obstacle database unavailable or invalid, invalid software configuration, system audio fault	<b>TAWS FAIL</b>	<b>TAWS FAIL</b>	"TAWS System Failure"
GPWS System Fail	<b>GPWS FAIL</b>	None	"GPWS System Failure"
System Test in progress	<b>TAWS TEST</b>	<b>TAWS TEST</b>	None
System Test pass	None	None	"TAWS System Test OK"
MFD Terrain or Obstacle database unavailable or invalid. TAWS operating with PFD Terrain or Obstacle databases	None	<b>TERRAIN DATABASE FAILURE</b>	None
GPWS System Fail, Radar Altimeter invalid, Altitude or Vertical Speed unavailable	<b>GPWS FAIL</b>	None	"GPWS System Failure"
No GPS position	<b>TAWS N/A</b>	<b>NO GPS POSITION</b>	"TAWS Not Available"
Excessively degraded GPS signal, Out of database coverage area	<b>TAWS N/A</b>	None	"TAWS Not Available"
Out of database coverage area	<b>TAWS N/A</b>	None	"TAWS Not Available" "TAWS Available" when aircraft enters database coverage area.

### TAWS-A ALERT AVAILABILITY

TAWS-A Status Annunciation Displayed	TAWS-A Alert Type Available										
	RTC	ITI	ROC	IOI	PDA	EDR	ECR	NCR	FIT	GSD	VCO
<b>TAWS TEST</b>	No	No	No	No	No	No	No	No	No	No	No
<b>TAWS N/A</b>	No	No	No	No	No	Yes	Yes	Yes	Yes	*No	**Yes
<b>TAWS FAIL</b>	No	No	No	No	No	Yes	Yes	Yes	Yes	Yes	**Yes
<b>TAWS INH</b>	No	No	No	No	No	Yes	Yes	Yes	Yes	Yes	Yes
<b>GPWS FAIL</b>	Yes	Yes	Yes	Yes	Yes	No	No	No	No	No	**Yes
<b>GS INH</b>	Yes	Yes	Yes	Yes	Yes	Yes	Yes	Yes	Yes	No	Yes
<b>GP INH</b>	Yes	Yes	Yes	Yes	Yes	Yes	Yes	Yes	Yes	No	Yes
<b>FLAP OVR</b>	Yes	Yes	Yes	Yes	Yes	Yes	Yes	Yes	#Yes	Yes	Yes

- \* GSD alert will be available if a valid ILS is being used for navigation, even if no valid GPS signal is being received.
- \*\* VCO alerts are not issued if both TAWS and GPWS systems have failed or are not available.
- # Only the portions of FIT Alerting based on flap position are disabled when FLAP OVR annunciation is displayed.

## TAWS-B ALERTS

Annunciations appear on the PFD and MFD. Pop-up alerts appear only on the MFD.

Alert Type	PFD/MFD TAWS Page Annunciation	MFD Map Page Pop-Up Alert	Aural Message
Excessive Descent Rate Warning (EDR)	<b>PULL UP</b>	<b>PULL-UP</b>	"Pull Up"
Reduced Required Terrain Clearance Warning (RTC)	<b>PULL UP</b>	<b>TERRAIN - PULL-UP</b>	"Terrain, Terrain; Pull Up, Pull Up"
Imminent Terrain Impact Warning (ITI)	<b>PULL UP</b>	<b>TERRAIN - PULL-UP</b>	"Terrain, Terrain; Pull Up, Pull Up"
Reduced Required Obstacle Clearance Warning (ROC)	<b>PULL UP</b>	<b>OBSTACLE - PULL-UP</b>	"Obstacle, Obstacle; Pull Up, Pull Up"
Imminent Obstacle Impact Warning (IOI)	<b>PULL UP</b>	<b>OBSTACLE - PULL-UP</b>	"Obstacle, Obstacle; Pull Up, Pull Up"
Reduced Required Terrain Clearance Caution (RTC)	<b>TERRAIN</b>	<b>CAUTION - TERRAIN</b>	"Caution, Terrain; Caution, Terrain"
Imminent Terrain Impact Caution (ITI)	<b>TERRAIN</b>	<b>CAUTION - TERRAIN</b>	"Caution, Terrain; Caution, Terrain"
Reduced Required Obstacle Clearance Caution (ROC)	<b>TERRAIN</b>	<b>CAUTION - OBSTACLE</b>	"Caution, Obstacle; Caution, Obstacle"
Imminent Obstacle Impact Caution (IOI)	<b>TERRAIN</b>	<b>CAUTION - OBSTACLE</b>	"Caution, Obstacle; Caution, Obstacle"
Premature Descent Alert Caution (PDA)	<b>TERRAIN</b>	<b>TOO LOW - TERRAIN</b>	"Too Low, Terrain"
Altitude Callout "500"	None	None	"Five-Hundred"
Excessive Descent Rate Caution (EDR)	<b>TERRAIN</b>	<b>SINK RATE</b>	"Sink Rate"
Negative Climb Rate Caution (NCR)	<b>TERRAIN</b>	<b>DON'T SINK</b>	"Don't Sink"

## TAWS-B SYSTEM STATUS ANNUNCIATIONS

Alert Type	PFD/MFD Alert Annunciation	TAWS-B Page Annunciation	Aural Message
System Test in Progress	<b>TAWS TEST</b>	<b>TAWS TEST</b>	None
System Test Pass	None	None	"TAWS System Test OK"
TAWS Alerting is disabled	<b>TAWS INH</b>	None	None
MFD Terrain or Obstacle database unavailable or invalid. TAWS operating with PFD Terrain or Obstacle databases	None	<b>TERRAIN DATABASE FAILURE</b>	None
TAWS-B System Test Fail, Terrain or Obstacle database unavailable or invalid, invalid software configuration, system audio fault	<b>TAWS FAIL</b>	<b>TAWS FAIL</b>	"TAWS System Failure"
No GPS position	<b>TAWS N/A</b>	<b>NO GPS POSITION</b>	"TAWS Not Available"
Excessively degraded GPS signal, Out of database coverage area	<b>TAWS N/A</b>	None	"TAWS Not Available"
Sufficient GPS signal received after loss	None	None	"TAWS Available"



## TCAS II ALERTS AND ANNUNCIATIONS

Mode	PFD Mode Annunciation	MFD Traffic Map Page Mode Annunciation	Traffic Display Status Icon (Other Maps)
TCAS II Self-test Initiated (TEST)	None	<b>TEST</b> (‘TEST MODE’ also shown in white on top center of page)	
Traffic Advisory and Resolution Advisory (TA/RA)	None	<b>TA/RA</b>	
Traffic Advisory Only (TA ONLY)	<b>TA ONLY</b>	<b>TA ONLY</b>	
TCAS II Standby (TFC STBY)	<b>TCAS STBY</b> <b>TCAS STBY</b> *	<b>STANDBY</b> (also shown in white in center of page when aircraft on ground, yellow in air)	
TCAS II Failed	<b>TCAS FAIL</b>	<b>FAIL</b>	

\* Annunciation appears white when aircraft is on the ground and yellow while in the air.

### TCAS II Modes

Traffic Map Page Annunciation	Description
<b>NO DATA</b>	Data is not being received from the TCAS II unit
<b>DATA FAILED</b>	Data is being received from the TCAS II unit, but the unit is self-reporting a failure
<b>FAILED</b>	Incorrect data format received from the TCAS II unit

### TCAS II Failure Annunciations

Traffic Status Banner Annunciation	Description
<b>RA OFF SCALE</b>	A Resolution Advisory is outside the selected display range*. Annunciation is removed when traffic comes within the selected display range
<b>TA OFF SCALE</b>	A Traffic Advisory is outside the selected display range*. Annunciation is removed when traffic comes within the selected display range.
<b>RA X.X ± XX ↓</b>	System cannot determine bearing of Resolution Advisory**. Annunciation indicates distance in nm, altitude separation in hundreds of feet, and altitude trend arrow (climbing/descending).
<b>TA X.X ± XX ↓</b>	System cannot determine bearing of Traffic Advisory**. Annunciation indicates distance in nm, altitude separation in hundreds of feet, and altitude trend arrow (climbing/descending).
<b>TRFC FAIL</b>	TCAS II unit has failed (unit is self-reporting a failure or sending incorrectly formatted data)
<b>NO TCAS DATA</b>	Data is not being received from the TCAS II unit

\*Shown as symbol on Traffic Map Page

\*\*Shown in center of Traffic Map Page

### TCAS II Traffic Status Annunciations

## OTHER PRODIGY® AURAL ALERTS

Message	Priority	Description
"Autopilot"	Warning	Warning – Autopilot is disengaged Single alert for manual AP disengagement Continuous alert for automatic AP disengagement; cancelled with <b>AP DISC</b> Switch
"Cabin"		High cabin altitude
"Fire, Fire"		Engine fire
"Flight Director"		Flight director has reverted to pitch or roll default mode
"High Speed"		Maximum operating speed exceeded
"Landing Gear"		Gear up in landing condition
"Minimums, minimums"		The aircraft has descended below the preset barometric minimum descent altitude.
"No Takeoff Brake"		No Takeoff Configuration due to brake status
"No Takeoff Flaps"		No Takeoff Configuration due to flap status
"No Takeoff Trim"		No Takeoff Configuration due to trim status
"Stall, Stall"		Airplane in stall condition
"Timer Expired"		Countdown timer on the PFD has reached zero
"Speed Control"		CSC (if available) disengaged abnormally
"Altitude"		Advisory
"Traffic"	The Traffic Information Service (TIS) has issued a Traffic Advisory alert.	
"Trim Trim Trim"	Trim switch malfunction	
"Vertical track"	The aircraft is one minute from Top of Descent. Issued only when vertical navigation is enabled.	
"Aural Warning OK"	Status	Aural warning system test passes
"Aural Warning One Channel"		Aural warning system test detects failure in one channel
"Incoming Call"		Satellite telephone is receiving a call
"SelCal"		Incoming communication through the HF radio
"Takeoff OK"		Takeoff configuration test passed
"TIS not available"		The aircraft is outside the Traffic Information Service (TIS) coverage area.

## FLIGHT PLAN IMPORT/EXPORT MESSAGES

In some circumstances, some messages may appear in conjunction with others.

Flight Plan Import/Export Results	Description
'Flight plan successfully imported.'	A flight plan file stored on the SD card was successfully imported as a stored flight plan.
'File contained user waypoints only. User waypoints imported successfully. No stored flight plan data was modified.'	The file stored on the SD card did not contain a flight plan, only user waypoints. These waypoints have been saved to the system user waypoints. No flight plans stored in the system have been modified.
'No flight plan files found to import.'	The SD card contains no flight plan data.
'Flight plan import failed.'	Flight plan data was not successfully imported from the SD card.
'Flight plan partially imported.'	Some flight plan waypoints were successfully imported from the SD card, however others had errors and were not imported. A partial stored flight plan now exists in the system.
'File contained user waypoints only.'	The file stored on the SD card did not contain a flight plan, only user waypoints. One or more of these waypoints did not import successfully.
'Too many points. Flight plan truncated.'	The flight plan on the SD card contains more waypoints than the system can support. The flight plan was imported with as many waypoints as possible.

Flight Plan Import/Export Results	Description
'Some waypoints not loaded. Waypoints locked.'	The flight plan on the SD card contains one or more waypoints that the system cannot find in the navigation database. The flight plan has been imported, but must be edited within the system before it can be activated for use.
'User waypoint database full. Not all loaded.'	The flight plan file on the SD card contains user waypoints. The quantity of stored user waypoints has exceeded system capacity, therefore not all the user waypoints on the SD card have been imported. Any flight plan user waypoints that were not imported are locked in the flight plan. The flight plan must be edited within the system before it can be activated for use.
'One or more user waypoints renamed.'	One or more imported user waypoints were renamed when imported due to naming conflicts with waypoints already existing in the system.
'Flight plan successfully exported.'	The stored flight plan was successfully exported to the SD card.
'Flight plan export failed.'	The stored flight plan was not successfully exported to the SD card. The SD card may not have sufficient available memory or the card may have been removed prematurely.

## PILOT PROFILE IMPORT/EXPORT MESSAGES

The following messages may be displayed when importing and exporting Pilot Profiles.

Pilot Profile Import/Export Results	Description
'No pilot profile plan files found to import.'	Displayed if the SD card does not have one or more valid pilot profile filenames.
'Overwrite existing profile?'	Displayed if the profile name matches the name of existing profile.
'Profile name invalid. Enter a different profile name.'	Displayed if the profile name is invalid.
'All available pilot profiles in use. Delete a profile before importing another.'	Displayed if the maximum number for pilot profiles has been reached.
'Pilot profile import failed.'	Displayed if the importing operation fails for any other reason.
'Pilot profile import succeeded.'	Displayed if the importing operation succeeds.
'Overwrite existing file?'	Displayed if the filename matches the name of an existing file on the SD card.
'Pilot profile export failed.'	Displayed if the export operation fails.
'Pilot profile export succeeded.'	Displayed if the export operation succeeds.

## DATABASE MANAGEMENT



**CAUTION:** Never disconnect power to the system when loading a database. Power interruption during the database loading process could result in maintenance being required to reboot the system.

The system uses Secure Digital (SD) cards to load and store various types of data. For basic flight operations, SD cards are required for database storage as well as Jeppesen navigation and ChartView database updates. Not all SD cards are compatible with the Prodigy® system. Use only SD cards supplied by Garmin or the aircraft manufacturer.



**CAUTION:** When downloading updates to the Jeppesen Navigation Database, copy the data to an SD card other than a Garmin Supplemental Data Card. Otherwise, data corruption can occur.



**NOTE:** When loading database updates, the 'DB Mismatch' message will be displayed until database synchronization is complete, followed by turning system power off, then on. Synchronization can be monitored on the AUX-SYSTEM STATUS Page.



**NOTE:** Loading a database in the system prior to its effective date will result in the expiration date on the power-up screen and the effective date on the AUX-System Status Page being displayed in yellow.



**NOTE:** Garmin requests the flight crew report any observed discrepancies related to database information. These discrepancies could come in the form of an incorrect procedure; incorrectly identified terrain, obstacles and fixes; or any other displayed item used for navigation or communication in the air or on the ground. Go to [FlyGarmin.com](http://FlyGarmin.com) and select "Aviation Data Error Report".

## JEPPESEN DATABASES

The Jeppesen navigation database is updated on a 28-day cycle. The ChartView database is updated on a 14-day cycle. If the ChartView database is not updated within 70 days of the expiration date, ChartView will no longer function. Both of these databases are provided directly from Jeppesen.



**NOTE:** The Jeppesen aviation navigation database is now referred to as the 'navigation database'. Previously this database had been referred to as the 'aviation database'.

The ChartView database should be copied to the Garmin supplied Supplemental Data Card which will reside in the bottom card slot on the MFD. The navigation database must be installed from the Jeppesen or user supplied SD data card. Contact Jeppesen ([www.jeppesen.com](http://www.jeppesen.com)) for subscription and update information.



**NOTE:** After the navigation database is installed, the card may be removed.

### Updating the active Jeppesen navigation database (not using the Dual Navigation Database or Automatic Database Synchronization Features):

- 1) With the system OFF, insert the SD card containing the new navigation database version into the top card slot of the display (PFD1, PFD2 or MFD) to be updated (label of SD card facing left).

- 2) Turn the system ON. A prompt similar to the following is displayed in the upper left corner of the display:

```
DO YOU WANT TO UPDATE THE STANDBY NAVIGATION DATABASE ON THE BOTTOM CARD?
THE STANDBY DATABASE WILL BE ACTIVATED UPON THE FIRST ON-GROUND POWER CYCLE ON OR
AFTER 00:00 SYSTEM TIME ON THE EFFECTIVE DATE.
FROM TO
REGION: WORLDWIDE WORLDWIDE
CYCLE: 0904 0905
EFFECTIVE: 09-APR-2009 07-MAY-2009
EXPIRES: 07-MAY-2009 04-JUN-2009
NO WILL BE ASSUMED IN 21 SECONDS.
```

Figure B-1 Standby Navigation Database Prompt

- 3) Press the **NO** Softkey to proceed to loading the active database.  
 4) A prompt similar to the following is displayed, press the **YES** Softkey to update the active navigation database.

```
DO YOU WANT TO UPDATE THE ACTIVE NAVIGATION DATABASE?
SELECTING YES WILL OVERWRITE THE ACTIVE NAVIGATION DATABASE.
FROM TO
REGION: WORLDWIDE WORLDWIDE
CYCLE: 0904 0905
EFFECTIVE: 09-APR-2009 07-MAY-2009
EXPIRES: 07-MAY-2009 04-JUN-2009
NO WILL BE ASSUMED IN 8 SECONDS.
UPDATING THE ACTIVE NAVIGATION DATABASE, PLEASE WAIT.
.
UPDATED 1 FILES SUCCESSFULLY!
PRESS ANY KEY TO CONTINUE.
CONTINUING IN 8 SECONDS.
```

Figure B-2 Database Update Confirmation

- 5) After the update completes, the display starts in normal mode. Do not remove power while the display is starting.  
 6) Turn the system OFF and remove the SD card from the top card slot.  
 7) Repeat steps 1 through 6 for the other displays (PFD1, PFD2 or MFD). Remove the SD card when finished.  
 8) Apply power to the system and press the **ENT** Key to acknowledge the startup screen.  
 9) Turn the large **FMS** Knob to select the AUX Page group on the MFD.  
 10) Turn the small **FMS** Knob to select the System Status Page.  
 11) Press the Display Database Selection Softkey to show active navigation database information for each display (**MFD1 DB, PFD1 DB, PFD2 DB**). Verify the correct active navigation database cycle information is shown for each display.

## DUAL NAVIGATION DATABASE FEATURE

The dual navigation database feature allows each display to store an upcoming navigation database on the bottom SD card so that the system can automatically load it to replace the active database when the new database becomes effective (the next cycle becomes available seven days prior to its effective date).

If a navigation database loader card is inserted into the top SD card slot of a display, and an SD card is in the bottom slot, the system will prompt the user (upon on-ground power up) as to whether the database should be stored on the bottom SD card as the standby database. If the user responds affirmatively, the system will copy the navigation database from the top SD card to the bottom SD card. As long as the bottom SD card remains in the card slot, this standby navigation database will be available for the system to use as the active database as soon as it becomes effective.

The system checks the active and standby databases upon (on-ground only) power-up. If the standby database is current and the active database is out of date, the display will upload the standby database into the active internal database location. Loading the standby database to the active location takes approximately 45-55 seconds. During the loading process ‘Please Wait. Navigation Database Update in Progress. Do Not Remove Power from Displays’ will be displayed on screen. After startup is complete, the pilot is alerted that the update is complete by a system alert message, ‘NAV DB UPDATED’.

**Loading a standby navigation database:**

- 1) With the system OFF, insert the SD card containing the new navigation database version into the top card slot of the MFD.
- 2) Verify that an SD card is inserted in the bottom slot of each PFD and the MFD.
- 3) Turn the system ON. A prompt similar to the following is displayed.

```
DO YOU WANT TO UPDATE THE STANDBY NAVIGATION DATABASE ON THE BOTTOM CARD?
THE STANDBY DATABASE WILL BE ACTIVATED UPON THE FIRST ON-GROUND POWER CYCLE ON OR
AFTER 00:00 SYSTEM TIME ON THE EFFECTIVE DATE.
FROM TO
REGION: WORLDWIDE WORLDWIDE
CYCLE: 0904 0905
EFFECTIVE: 09-APR-2009 07-MAY-2009
EXPIRES: 07-MAY-2009 04-JUN-2009
NO WILL BE ASSUMED IN 21 SECONDS.
```

**Figure B-3 Standby Navigation Database Prompt**

- 4) Press the **YES** Softkey. The navigation database is copied to the SD card in the bottom card slot of the MFD.
- 5) After the navigation database files are copied to the bottom SD card, the display will appear as shown in Figure B-4.

```
INITIALIZING SYSTEM
DO YOU WANT TO UPDATE THE STANDBY NAVIGATION DATABASE ON THE BOTTOM CARD?
THE STANDBY DATABASE WILL BE ACTIVATED UPON THE FIRST ON-GROUND POWER CYCLE ON OR
AFTER 00:00 SYSTEM TIME ON THE EFFECTIVE DATE.
FROM TO
REGION: WORLDWIDE WORLDWIDE
CYCLE: 1009 1012
EFFECTIVE: 26-AUG-2010 18-NOV-2010
EXPIRES: 23-SEP-2010 16-DEC-2010
NO WILL BE ASSUMED IN 18 SECONDS.
UPDATING STANDBY NAVIGATION DATABASE, PLEASE WAIT.
.
UPDATED STANDBY NAVIGATION DATABASE SUCCESSFULLY.
PRESS ANY KEY TO CONTINUE.
CONTINUING IN 9 SECONDS.
```

**Figure B-4 Standby Navigation Database Update Complete**

- 6) As instructed on the display, press any key to continue. The display will now appear as shown in Figure B-5.

```

DATABASE NAVIGATION WILL BE VERIFIED BEFORE USE.
DATABASE STANDBY NAV WILL BE VERIFIED BEFORE USE.
PRESS ANY KEY TO CONTINUE.
CONTINUING IN 6 SECONDS.

```

Figure B-5 Navigation Database Verification Prompt

- 7) Press any key to continue. The display will now appear as shown in Figure B-6.

```

*
DO YOU WANT TO UPDATE THE ACTIVE NAVIGATION DATABASE?
SELECTING YES WILL OVERWRITE THE ACTIVE NAVIGATION DATABASE.
REGION:      FROM          TO
CYCLE:       0904           0905
EFFECTIVE:   09-APR-2009     07-MAY-2009
EXPIRES:     07-MAY-2009     04-JUN-2009
NO WILL BE ASSUMED IN 8 SECONDS.

```

Figure B-6 Active Navigation Database Prompt

- 8) Press the **NO** Softkey. The display now starts in normal mode. Since the database effective date is not yet valid, it should not be loaded as the active database. The display now starts in normal mode. Do not remove power while the display is starting.
- 9) Press the **ENT** Key to acknowledge the startup screen.
- 10) Turn the large **FMS** Knob to select the AUX Page group on the MFD.
- 11) Turn the small **FMS** Knob to select the System Status Page.
- 12) The new database is copied to the SD card in the bottom card slot of each PFD. Progress can be monitored in the SYNC STATUS field. When copying is finished, 'Complete' is displayed.
- 13) Turn system power OFF.
- 14) Remove the SD card from the top card slot of the MFD.
- 15) Turn system power ON.
- 16) Press the **ENT** Key to acknowledge the startup screen.
- 17) Turn the large **FMS** Knob to select the AUX Page group on the MFD.
- 18) Turn the small **FMS** Knob to select the System Status Page.
- 19) Press the Display Database Selection Softkey to show standby navigation database information for each display (**MFD1 DB, PFD1 DB, PFD2 DB**). Verify the correct standby navigation database cycle information is shown for each display.



## GARMIN DATABASES

The following databases are stored on Supplemental Data Cards provided by Garmin:

- Expanded basemap
- Terrain
- Airport terrain
- Obstacle
- SafeTaxi
- FliteCharts
- Airport Directory (AOPA or AC-U-KWIK)

After subscribing to the desired database product, these database products will be downloaded and ultimately stored on three Supplemental Data Cards (with the exception of FliteCharts, which is loaded on only one card). Each Supplemental Data Card resides in the bottom card of each display as shown in Figure B-7. These cards must not be removed except to update the databases stored on each card.

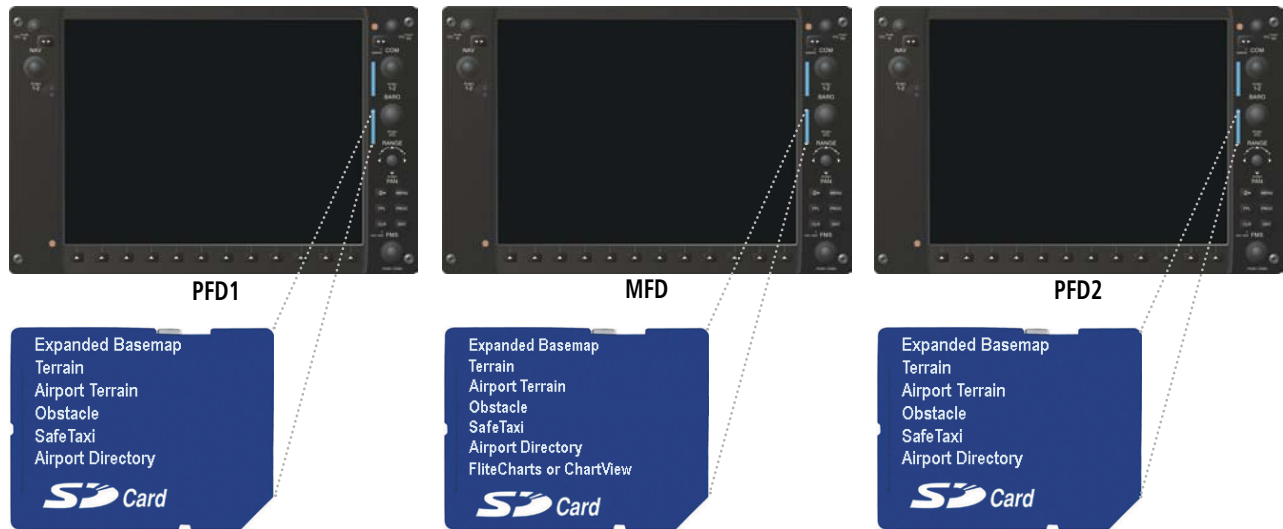

Figure B-7 Correct Database Locations

Since these databases are not stored internally in the displays, a Supplemental Data Card containing identical database versions must be kept in each display unit.

The basemap database contains data for the topography and land features, such as rivers, lakes, and towns. It is updated only periodically, with no set schedule. There is no expiration date.

The terrain database contains the terrain mapping data. The airport terrain database contains increased resolution terrain data around airports. These databases are updated periodically and have no expiration date.

The obstacle database contains data for obstacles, such as towers, that pose a potential hazard to aircraft. Obstacles 200 feet and higher are included in the obstacle database. It is very important to note that not all obstacles are necessarily charted and therefore may not be contained in the obstacle database. This database is updated on a 56-day cycle.



**NOTE:** The data contained in the terrain and obstacle databases comes from government agencies. Garmin accurately processes and cross-validates the data, but cannot guarantee the accuracy and completeness of the data.

The AOPA or AC-U-KWIK Airport Directory provides data on airports and heliports throughout the U.S., and offers detailed information for over 5,300 U. S. airports, along with the names and phone numbers of thousands of FBOs. This database is updated four times per year.

The SafeTaxi database contains detailed airport diagrams for selected airports. These diagrams aid in following ground control instructions by accurately displaying the aircraft position on the map in relation to taxiways, ramps, runways, terminals, and services. This database is updated on a 56-day cycle.

The FliteCharts database contains procedure charts for the United States only. This database is updated on a 28-day cycle. If not updated within 180 days of the expiration date, FliteCharts will no longer function.

## AUTOMATIC DATABASE SYNCHRONIZATION FEATURE

The automatic database synchronization feature automatically transfers the database from a single SD database card to the SD cards on each PFD and the MFD to ensure that all databases are synchronized throughout the system. After power-up, the system compares all copies of each applicable database. If similar databases do not match, the most recent valid database is automatically copied to each card in the system that does not already contain that database.

The following databases are checked and synchronized: Basemap, Safetaxi, Airport Terrain, Obstacle, Airport Directory (AOPA or AC-U-KWIK), and Terrain. This feature applies only to databases that are stored on the SD card that resides in the bottom slot of each display. This feature does not apply to the navigation database which is stored internally in each display, or to the charts databases (FliteCharts and ChartView) which are only required to be present on the MFD. The typical procedure would be to download new databases to the MFD card, then synchronize the data to the PFD(s).



**NOTE:** The 9-arc second terrain database may take as long as 100 minutes to synchronize using this method. Therefore the user may want to transfer the data using a PC, or connect the system to a ground power source while performing the database synchronization.

The synchronization progress may be monitored on the AUX-System Status Page in the Sync Status section of the Database Window (Figure B-8). This section shows the synchronization status of each applicable database, including the percent complete, time remaining, and to which displays the databases are being copied. When the synchronization is complete, the status is listed as 'Complete', followed by the displays to which the databases were copied. This sub-section is only present when a sync is occurring or has occurred on the current power-up.

An indication of 'Complete' still requires a power cycle before the synchronized databases will be used by the system.

MFD1 DATABASE	
SYNC STATUS	
BASEMAP	Complete PFD1.PFD2
SAFETAXI	Complete PFD1.PFD2
TERRAIN	34% 0:14 PFD1.PFD2
NAVIGATION - INTERNAL	
REGION	WORLDWIDE
CYCLE	0905
EFFECTIVE	07-MAY-09
EXPIRES	04-JUN-09
Copyright 2009, Jeppesen Sanderson, Inc.	
BASEMAP - BOTTOM CARD	
REGION	WORLDWIDE
VERSION	3.00

Figure B-8 AUX-System Status Page, Database Window

The Display Database Softkey (Figure B-11) is used to place the cursor in the Database Window. Upon first press of the Display Database Softkey, the softkey will change to a selected state (black text on gray background) and the cursor will appear in the Database Window. At this point the user can scroll through all databases in the Database Window to view status information. If the Display Database Softkey is pressed repeatedly, the softkey will cycle through PFD1, PFD2, and MFD. Database status information in the Database Window will reflect the database of the selected PFD or MFD. After a successful sync and restart, verify that the proper databases are now in use on the AUX–System Status Page (Figure B-8).

If an error occurs during the synchronization, an error message will be displayed, followed by the affected display in the Sync Status section of the Database Window (Figure B-9). If a synchronization completes on one display, but an error occurs on another, the error message will be displayed with the affected display listed after it. When an error message (Table B-1) is displayed, the problem must be corrected before the synchronization can be completed. A power cycle is required to restart synchronization when ‘Card Full’ or ‘Err’ is shown.

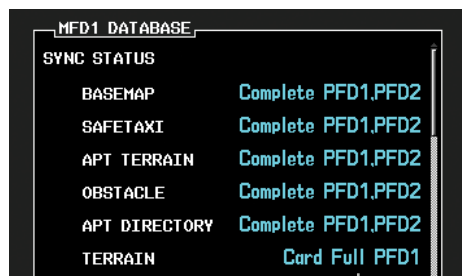

Database Synchronization Error Message  
**Figure B-9 Synchronization Error Message**

Error Message	Description
Canceled	Database synchronization has been canceled by removing the bottom SD card in display being updated
Card Full	SD card does not contain sufficient memory
Err	Displayed for all other errors that may cause the synchronization process to be halted
Timeout	System timed-out prior to the database transfer completing

**Table B-1 Database Synchronization Error Messages**

**UPDATING GARMIN DATABASES**

The Garmin database updates can be obtained by following the instructions detailed in the ‘Aviation Databases’ section of the Garmin website (fly.garmin.com). Once the updated files have been downloaded from the website, a PC equipped with an appropriate SD card reader is used to unpack and program the new databases onto an existing Supplemental Data Card. Equipment required to perform the update is as follows:

- Windows-compatible PC computer (running Windows XP, Vista, or Windows 7)
- SD Card Reader: SanDisk SDDR-93, SanDisk SDDR-99, Verbatim #96504, or equivalent
- Updated database obtained from the Garmin website
- Existing Supplemental Database SD Cards (010-00330-42, or -43) from both PFDs and MFD

In some cases it may be necessary to obtain an unlock code from Garmin in order to make the database product functional. It may also be necessary to have the system configured by a Garmin authorized service facility in order to use some database features.

After the data has been copied to the appropriate data card, perform the following steps:

- 1) With system power OFF, remove the MFD database card from the bottom card slot of the MFD.
- 2) Update the Garmin databases on the MFD card.
- 3) Insert the MFD database card into the bottom card slot of the MFD.
- 4) Apply power to the system, check that the databases are initialized and displayed on the power-up screen (Figure B-10). When updating the terrain and FliteCharts databases, a 'Verifying' message may be seen. If this message is present, wait for the system to finish loading before proceeding to step 5.

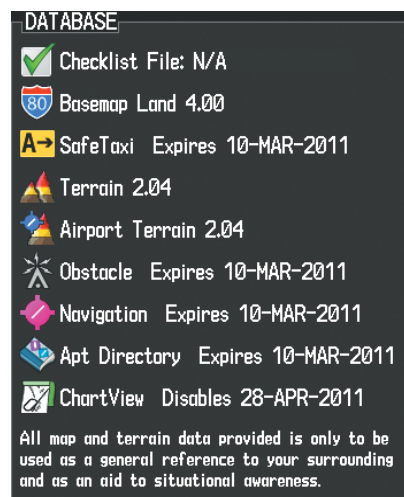

Figure B-10 Database Information on the Power-up Screen

- 5) Acknowledge the Power-up Page agreement by pressing the **ENT** Key or the right most softkey.
- 6) Turn the large **FMS** Knob to select the AUX Page group on the MFD.
- 7) Turn the small **FMS** Knob to select the System Status Page.
- 8) Monitor the Sync Status in the Database Window. Wait for all databases to complete syncing, indicated by 'Complete' being displayed as seen in Figure B-9.
- 9) Remove and reapply power to the system.
- 10) Turn the large **FMS** Knob to select the AUX Page group on the MFD.
- 11) Turn the small **FMS** Knob to select the System Status Page.
- 12) Press the Display Database Selection Softkey to show database information for each display (**MFD1 DB**, **PFD1 DB**, **PFD2 DB**). Verify the correct database cycle information is shown for each database for each display.



Figure B-11 Display Database Softkey

## MAGNETIC FIELD VARIATION DATABASE UPDATE

A copy of the current magnetic field variation database (MV DB) is included with the navigation database. At startup, the system compares this version of the MV DB with that presently being used by each AHRS (GRS1 and GRS2). If the system determines the MV DB needs to be updated, a prompt is displayed on the Navigation Map Page, as shown in Figure B-12. Note, in the following example, GRS1 is the first AHRS to indicate an update is available. In actuality, this is dependent on which AHRS is the first to report status to the system. GRS2 may be displayed before GRS1. The order is not important, only that both AHRS be updated.

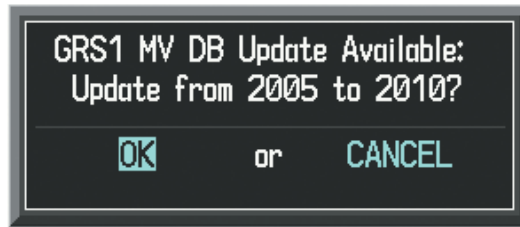

Figure B-12 GRS1 Magnetic Field Variation Database Update Prompt

### Loading the magnetic field variation database update:

- 1) With 'OK' highlighted, as seen in Figure B-12, press the **ENT** Key on the MFD. A progress monitor is displayed as shown in Figure B-13.

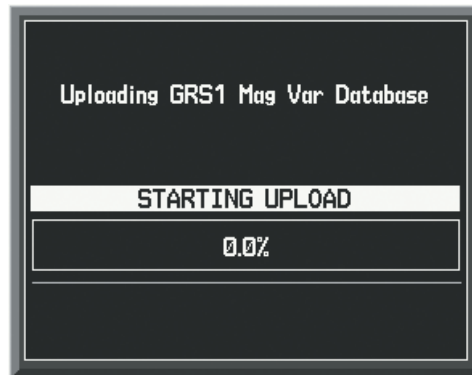

Figure B-13 Uploading Database to GRS1

- 2) When the upload is complete, the prompt for the next GRS upload is displayed, as seen in Figure B-14.

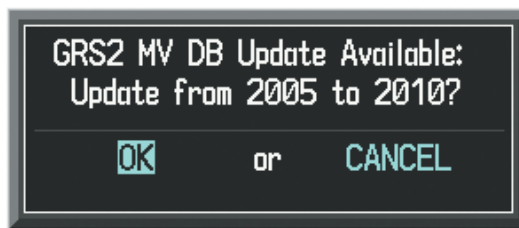

Figure B-14 GRS2 Magnetic Field Variation Database Update Prompt

- 3) With 'OK' highlighted, press the **ENT** Key on the MFD. A progress monitor is displayed as shown in Figure B-15. When the upload is complete, the system is ready for use.

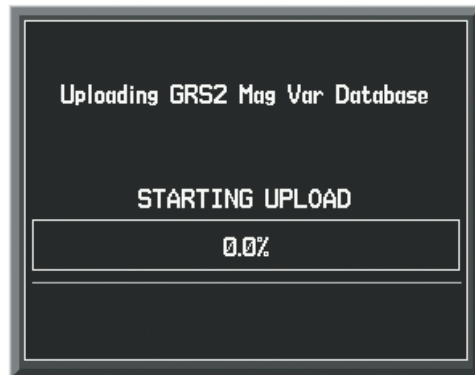

Figure B-15 Uploading Database to GRS2

## GLOSSARY

ACC	accuracy	BRG	bearing
ACT, ACTV	active, activate	C	center runway
ADC	air data computer	°C	degrees Celsius
ADF	Automatic Direction Finder	CA	Course to Altitude
ADI	Attitude Direction Indicator	CALC	calculator
AF	Arc to fix	Calibrated Airspeed	Indicated airspeed corrected for installation and instrument errors.
AFCS	Automatic Flight Control System	CD	Course to DME distance
AFM	Airplane Flight Manual	CDI	Course Deviation Indicator
AFMS	Airplane Flight Manual Supplement	CDU	Control Display Unit
AFRM	airframe	CF	Course to Fix
AGL	Above Ground Level	CHT	Cylinder Head Temperature
AHRS	Attitude and Heading Reference System	CHKLIST	checklist
AIM	Aeronautical Information Manual	CHNL	channel
AIRMET	Airman's Meteorological Information	CI	Course to Intercept
ALRT	alert	CLD	cloud
ALT	altitude	CLR	clear
ALT, ALTN	alternator	cm	centimeter
AMPS	amperes	CNS	Communication, Navigation, & Surveillance
ANNUNC	annunciation	CO	carbon monoxide
ANT	antenna	COM	communication radio
AOPA	Aircraft Owners & Pilots Association	CONFIG	configuration
AP	autopilot	COOL	coolant
AP DISC	autopilot disconnect	COPLT	co-pilot
APR	approach	Course	The line between two points to be followed by the aircraft.
APT	airport, aerodrome	Course to Steer	The recommended direction to steer in order to reduce course error or stay on course. Provides the most efficient heading to get back to the desired course and proceed along the flight plan.
ARINC	Aeronautical Radio Incorporated	CR	Course to Radial
ARSPC	airspace	CRG	Cockpit Reference Guide
ARTCC	Air Route Traffic Control Center	CRNT	current
ARV	arrival	Crosstrack Error	The distance the aircraft is off a desired course in either direction, left or right.
AS	airspeed	CRS	course
ASB	Aviation Support Branch	CRS	Course to Steer
ASOS	Automated Surface Observing System	CRSR	cursor
ATC	Air Traffic Control	CTA	Control Area
ATCRBS	ATC Radar Beacon System	CTRL	control
ATIS	Automatic Terminal Information Service	Cumulative	The total of all legs in a flight plan.
ATK	along-track	CVR	Cockpit Voice Recorder
AUTOSEQ	automatic sequence	CVRG	coverage
AUX	auxiliary	CWS	control wheel steering
AWOS	Automated Weather Observing System	CYL	cylinder
B ALT	barometric altitude	D ALT	density altitude
BARO	barometric setting		
BATT	battery		
BC	backcourse		
Bearing	The compass direction from the present position to a destination waypoint.		
BFO	beat frequency oscillator		
BKSP	backspace		



DB, DBASE	database	Enroute Safe Altitude	The recommended minimum altitude within ten miles left or right of the desired course on an active flight plan or direct-to.
dBZ	decibels 'Z' (radar return)	ENT	enter
DCLTR, DECLTR	declutter	EPE	Estimated Position Error
DEC FUEL	decrease fuel	EPU	Estimated Position Uncertainty
deg	degree	ERR	error
DEIC, DEICE	de-icing	ESA	Enroute Safe Altitude
DEP	departure	Estimated Position Error	A measure of horizontal GPS position error derived by satellite geometry conditions and other factors.
Desired Track	The desired course between the active "from" and "to" waypoints.	Estimated Time of Arrival	The estimated time at which the aircraft should reach the destination waypoint, based upon current speed and track.
DEST	destination	Estimated Time Enroute	The estimated time it takes to reach the destination waypoint from the present position, based upon current ground speed.
DF	Direct to Fix	ETA	Estimated Time of Arrival
DFLT	default	ETE	Estimated Time Enroute
DGRD	degrade	EXPIRD	expired
DH	decision height	°F	degrees Fahrenheit
Dilution of Precision	A measure of GPS satellite geometry quality on a scale of one to ten (lower numbers equal better geometry, where higher numbers equal poorer geometry).	FA	Course From Fix to Altitude
DIR	direction	FAA	Federal Aviation Administration
DIS	distance	FADEC	Full Authority Digital Engine Control
Distance	The 'great circle' distance from the present position to a destination waypoint.	FAF	Final Approach Fix
DME	Distance Measuring Equipment	FAIL	failure
DOP	Dilution of Precision	FC	Course From Fix to Distance
DP	Departure Procedure	FCC	Federal Communication Commission
DPRT	departure	FCST	forecast
DR	dead reckoning	FD	Course From Fix to DME Distance
DSBL	disabled	FD	flight director
DTK	Desired Track	FDE	Fault Detection and Exclusion
E	empty, east	FFLOW	fuel flow
ECU	Engine Control Unit	FIS-B	Flight Information Services-Broadcast
Efficiency	A measure of fuel consumption, expressed in distance per unit of fuel.	FISDL	Flight Information Service Data Link
EGT	Exhaust Gas Temperature	FL	flight level
EIS	Engine Indication System	FLC	Flight Level Change
EGNOS	European Geostationary Navigation Overlay Service	FM	Course From Fix to Manual Termination
ELEV	elevation	FMS	Flight Management System
ELEV	elevator	FOB	Fuel On Board
EMERGCY	emergency	FPL	flight plan
EMI	Electromagnetic Interference	fpm	feet per minute
ENDUR	endurance	FREQ	frequency
Endurance	Flight endurance, or total possible flight time based on available fuel on board.	FRZ	freezing
ENG	engine	FSS	Flight Service Station
ENGD	engaged	ft	foot/feet
ENR	enroute		

Fuel Flow	The fuel flow rate, expressed in units of fuel per hour.	hPa	hectopascal
Fuel On Board	The total amount of usable fuel on board the aircraft.	HPL	Horizontal Protection Level
		hr	hour
		HSDB	High-Speed Data Bus
G/S, GS	glideslope	HSI	Horizontal Situation Indicator
GA	go-around	HT	heat
gal, gl	gallon(s)	HUL	Horizontal Uncertainty Level
GBOX	gearbox	Hz	Hertz
GDC	Garmin Air Data Computer	I	Inner Marker
GDL	Garmin Satellite Data Link	IAF	Initial Approach Fix
GDU	Garmin Display Unit	IAT	Indicated Air Temperature
GEA	Garmin Engine/Airframe Unit	ICAO	International Civil Aviation Organization
GEO	geographic	ICS	Intercom System
GFC	Garmin Flight Control	ID	Identification/Morse Code Identifier
GIA	Garmin Integrated Avionics Unit	IDENT, IDNT	identification
GLS	Global Navigation Satellite Landing System	IF	Initial Fix
GMA	Garmin Audio Panel System	IFR	Instrument Flight Rules
GMC	Garmin Mode Controller	IG	Imperial gallon
GMT	Greenwich Mean Time	ILS	Instrument Landing System
GMU	Garmin Magnetometer Unit	IMC	Instrument Meteorological Conditions
GND	ground	in	inch
gph	gallons per hour	INACTV	inactive
GPS	Global Positioning System	INC FUEL	increase fuel
Grid MORA	Grid Minimum Off-Route Altitude; one degree latitude by one degree longitude in size and clears the highest elevation reference point in the grid by 1000 feet for all areas of the grid	IND	indicated
		Indicated	Information provided by properly calibrated and set instrumentation on the aircraft panel.
Groundspeed	The velocity that the aircraft is travelling relative to a ground position.	INFO	information
		in HG	inches of mercury
		INT	intersection(s)
Ground Track	<i>see Track</i>	INTEG	integrity (RAIM unavailable)
GRS	Garmin Reference System	IrDA, IRDA	Infrared Data Association
GS	Ground speed	KEYSTK	key stuck
GTX	Garmin Transponder	kg	kilogram
		kHz	kilohertz
HA	Hold Terminating at Altitude	km	kilometer
HDG	heading	kt	knot
Heading	The direction an aircraft is pointed, based upon indications from a magnetic compass or a properly set directional gyro.	L	left, left runway
		LAT	latitude
		LBL	label
HF	Hold Terminating at Fix	lb	pound
HFOM	Horizontal Figure of Merit	LCD	Liquid Crystal Display
Hg	mercury	LCL	local
HI	high	LED	Light Emitting Diode
HI SENS	High Sensitivity	Left Over Fuel On Board	The amount of fuel remaining on board after the completion of one or more legs of a flight plan or direct-to.
HM	Hold with Manual Termination		
Horizontal Figure of Merit	A measure of the uncertainty in the aircraft's horizontal position.		

Left Over Fuel Reserve	The amount of flight time remaining, based on the amount of fuel on board after the completion of one or more legs of a flight plan or direct-to, and a known consumption rate.	MSG	message
		MSL	Mean Sea Level
		MT	meter
		mV	millivolt(s)
		MVFR	Marginal Visual Flight Rules
Leg	The portion of a flight plan between two waypoints.	N	north
LIFR	Low Instrument Flight Rules	NAV	navigation
LNAV	Lateral Navigation	NAVAID	NAVigation AID
LO	low	NDB	Non-directional Beacon
LOC	localizer	NEXRAD	Next Generation Radar
LOI	loss of integrity (GPS)	nm	nautical mile(s)
LON	longitude	NoPT	No Procedure Turn Required (procedure shall not be executed without ATC clearance)
LPV	Localizer Performance with Vertical guidance	NRST	nearest
LRU	Line Replacement Unit		
LT	left	O	Outer Marker
LTNG	lightning	OAT	Outside Air Temperature
LVL	level	OBS	Omni Bearing Selector
M	Middle Marker	OFST	offset
m	meter	OXY	oxygen
MAG	Magnetic		
MAG VAR	Magnetic Variation	P ALT	pressure altitude
MAHP	Missed Approach Hold Point	PA	Passenger Address
MAN IN	manifold pressure (inches Hg)	PA	Proximity Advisory
MAN SQ	Manual Squelch	PASS	passenger(s)
MAP	Missed Approach Point	PC	personal computer
MASQ	Master Avionics Squelch	PFD	Primary Flight Display
MAX	maximum	PI	Procedure Turn to Course Intercept
MAXSPD	maximum speed (overspeed)	PIT, PTCH	pitch
MDA	barometric minimum descent altitude	POSN	position
MET	manual electric trim	PPM	parts per million
METAR	Meteorological Aviation Routine	P. POS	Present Position
MEPT	manual electric pitch trim	PRES, PRESS	pressure
MFD	Multi Function Display	PROC	procedure(s), procedure turn
MGRS	Military Grid Reference System	psi	pounds per square inch
MHz	megahertz	PT	Procedure Turn
MIC	microphone	PTK	parallel track
MIN	minimum	PTT	Push-to-Talk
Minimum Safe Altitude	Uses Grid MORAs to determine a safe altitude within ten miles of the aircraft present position.	PWR	power
MKR	marker beacon	QTY	quantity
MOA	Military Operations Area	R	right, right runway
MOV	movement	RAD	radial
mpm	meters per minute	RAIM	Receiver Autonomous Integrity Monitoring
MSA	Minimum Safe Altitude	RAM	random access memory
MSAS	Multi-functional Satellite Augmentation System	REF	reference

REM	remaining (fuel remaining above Reserve)	T	true
REQ	required	TA	Traffic Advisory
RES	reserve (fuel reserve entered by pilot)	TACAN	Tactical Air Navigation System
REV	reverse, revision, revise	TAF	Terminal Aerodrome Forecast
RF	Constant Radius Turn to Fix	TAS	True Airspeed
RMI	Radio Magnetic Indicator	TAS	Traffic Advisory System, true airspeed
RMT	remote	TAT	Total Air Temperature
RNG	range	TAWS	Terrain Awareness and Warning System
RNWX	runway	TCA	Terminal Control Area
ROL	roll	TCAS	Traffic Collision Avoidance System
ROM	read only memory	TEL	telephone
rpm	revolutions per minute	TEMP	temperature
RST FUEL	reset fuel	TERM	terminal
RSV	reserve (fuel reserve entered by pilot)	TF	Track Between Two Fixes
RT	right	TFR	Temporary Flight Restriction
RVRSNRY	reversionary	T HDG	True Heading
RX	receive	TIS	Traffic Information System
		TIT	Turbine Inlet Temperature
S	south	TKE	Track Angle Error
SA	Selective Availability	TMA	Terminal Maneuvering Area
SAT	Static Air Temperature	TMR/REF	Timer/Reference
SBAS	Satellite-Based Augmentation System	Topo	topographic
SCIT	Storm Cell Identification and Tracking	Track	Direction of aircraft movement relative to a ground position; also 'Ground Track'
SD	Secure Digital		
sec	second(s)		
SEL, SLCT	select	Track Angle Error	The angle difference between the desired track and the current track.
SFC	surface		
SIAP	Standard Instrument Approach Procedures	TRG	target
		TRK	track
SID	Standard Instrument Departure	TRSA	Terminal Radar Service Area
SIGMET	Significant Meteorological Information	TRUNC	truncated
Sim	simulator	TTL	total
SLP/SKD	slip/skid	TURN	procedure turn
SMBL	symbol	TX	transmit
SPD	speed		
SPI	Special Position Identification	UNAVAIL	unavailable
SPKR	speaker	USR	user
SQ	squelch	UTC	Coordinated Universal Time
SRVC, SVC	service	UTM/UPS	Universal Transverse Mercator / Universal Polar Stereographic Grid
STAL	stall		
STAR	Standard Terminal Arrival Route		
STATS	statistics	V, Vspeed	velocity (airspeed)
STBY	standby	VA	Heading Vector to Altitude
STD	standard	VAPP	VOR approach
SUA	Special Use Airspace	VAR	variation
SUSP	suspend	VD	Heading Vector to DME Distance
SVS	Synthetic Vision System	Vdc	volts, direct current
SW	software	VERT	vertical
SYS	system		

Vertical Figure of Merit	A measure of the uncertainty in the aircraft's vertical position.
Vertical Speed Required	The vertical speed necessary to descend/ climb from a current position and altitude to a defined target position and altitude, based upon current groundspeed.
VFOM	Vertical Figure of Merit
VFR	Visual Flight Rules
VHF	Very High Frequency
VI	Heading Vector to Intercept
VLOC	VOR/Localizer Receiver
VM	Heading Vector to Manual Termination
VMC	Visual Meteorological Conditions
VNAV, VNV	vertical navigation
VOL	volume
VOR	VHF Omni-directional Range
VORTAC	very high frequency omnidirectional range station and tactical air navigation
VPL	Vertical Protection Level
VPROF	VNV profile, vertical profile
VPTH	VNV path, vertical path
VR	Heading Vector to Radial
VS	vertical speed
VSI	Vertical Speed Indicator
VSR	Vertical Speed Required
VTF	vector to final
W	watt(s), west
WAAS	Wide Area Augmentation System
WARN	warning (GPS position error)
WGS-84	World Geodetic System - 1984
WPT	waypoint(s)
WW	world wide
WX	weather
XFER, XFR	transfer
XPDR	transponder
XTALK	cross-talk
XTK	cross-track

## FREQUENTLY ASKED QUESTIONS

If a particular aspect of system operational capability is not addressed by these commonly asked questions or in the index, contact Garmin (see the copyright page or back cover for contact information) or a Garmin-authorized dealer. Garmin is dedicated to supporting its products and customers.

### WHAT IS SBAS?

The Satellite Based Augmentation System (SBAS) uses a system of ground stations to correct any GPS signal errors. These ground stations correct for errors caused by ionospheric disturbances, timing, and satellite orbit errors. It also provides vital integrity information regarding the health of each GPS satellite. The signal correction is then broadcast through geostationary satellites. This correction information can then be received by any SBAS-enabled GPS receiver.

SBAS is designed to provide the additional accuracy, availability, and integrity necessary to enable users to rely on GPS for all phases of flight.

There are several SBAS systems serving different parts of the world. The Wide Area Augmentation System (WAAS) is currently available in the United States, including Alaska and Hawaii. The European Geostationary Navigation Overlay Service (EGNOS) offers coverage of Europe, parts of the middle east and northern Africa. The Multi-functional Satellite Augmentation System (MSAS) covers mainly Japan and parts of northern Australia.

### HOW DOES SBAS AFFECT APPROACH OPERATIONS?

Both LNAV/VNAV and LPV approaches use the accuracy of SBAS to include vertical (glide path) guidance capability. The additional accuracy and vertical guidance capability allows improved instrument approaches to an expanded number of airports throughout the U.S.

The implementation of LPV approaches further improves precision approach capabilities. LPV approaches are designed to make full use of the improved GPS signal from the SBAS. This approach combines the LNAV/VNAV vertical accuracy with lateral guidance similar to the typical Instrument Landing System (ILS). LPV approaches allow lower approach minimums.

### WHAT IS RAIM AND HOW DOES IT AFFECT APPROACH OPERATIONS?

RAIM is an acronym for Receiver Autonomous Integrity Monitoring. RAIM is a GPS receiver function that performs the following functions:

- Monitors and verifies integrity and geometry of tracked GPS satellites
- Notifies the pilot when satellite conditions do not provide the necessary coverage to support a certain phase of flight
- Predicts satellite coverage of a destination area to determine whether the number of available satellites is sufficient to satisfy requirements



---

**NOTE:** *If RAIM is not predicted to be available for the final approach course, the approach does not become active, as indicated by the "RAIM not available from FAF to MAP" message and the LOI annunciation flagging on the HSI.*

---

For RAIM to work correctly, the GPS receiver must track at least five satellites. A minimum of six satellites is required to allow RAIM to eliminate a single corrupt satellite from the navigation solution.

RAIM ensures that satellite geometry allows for a navigation solution calculation within a specified protection limit (2.0 nm for oceanic and en route, 1.0 nm for terminal, and 0.3 nm for non-precision approaches). The system monitors RAIM and issues an alert message when RAIM is not available (see Appendix A). Without RAIM, GPS position accuracy cannot be monitored. If RAIM is not available when crossing the FAF, the pilot must fly the missed approach procedure.

### **WHY ARE THERE NOT ANY APPROACHES AVAILABLE FOR A FLIGHT PLAN?**

Approaches are available for the final destination airport in a flight plan or as a direct-to (keep in mind that some VOR/VORTAC identifiers are similar to airport identifiers). If a destination airport does not have a published approach, the system indicates “NONE” for the available procedures.

### **WHAT HAPPENS WHEN AN APPROACH IS SELECTED? CAN A FLIGHT PLAN WITH AN APPROACH, A DEPARTURE, OR AN ARRIVAL BE STORED?**

When an approach, departure, or arrival is loaded into the active flight plan, a set of approach, departure, or arrival waypoints is inserted into the flight plan, along with a header line showing the title of the selected instrument procedure. The original en route portion of the flight plan remains active, unless the instrument procedure is activated. This may be done either when the procedure is loaded or at a later time.

Flight plans can also be stored with an approach, a departure, or an arrival. Note that the active flight plan is erased when the system is turned off. Also, the active flight plan is overwritten when another flight plan is activated. When storing flight plans with an approach, a departure, or an arrival, the system uses the waypoint information from the current database to define the waypoints. If the database is changed or updated, the system automatically updates the information, provided the procedure has not been modified. Should an approach, departure, or arrival procedure no longer be available, the flight plan becomes locked until the procedure is deleted from the flight plan.

### **CAN “SLANT GOLF” (“/G”) BE FILED USING THE PRODIGY® SYSTEM?**

“/G” may be filed for a flight plan. The Prodigy® System meets the requirements of TSO-C145a Class 3 and ETSO C145 Class 3 installations. GPS approaches are not to be flown with an expired database. See the approved Pilot’s Operating Handbook (POH) as well as the Aeronautical Information Manual (AIM) for more information.

### **WHAT DOES THE OBS SOFTKEY DO?**

The **OBS** Softkey is used to select manual sequencing of waypoints. Activating OBS mode sets the current active-to waypoint as the primary navigation reference and prevents the system from sequencing to the next waypoint in a flight plan. When OBS mode is cancelled, automatic waypoint sequencing is continued, and the system automatically activates the next waypoint in the flight plan once the aircraft has crossed the present active waypoint.



**Normal (OBS not activated)**

- Automatic sequencing of waypoints
- Manual course change on HSI not possible
- Always navigates ‘TO’ the active waypoint
- Must be in this mode for final approach course

**OBS**

- Manual sequencing - ‘holds’ on selected waypoint
- Manually select course to waypoint from HSI
- Indicates ‘TO’ or ‘FROM’ waypoint
- Cannot be set for final approach course or published holding patterns

When OBS mode is active, the system allows the pilot to set a desired course to/from a waypoint using the **CRS/BARO** Knob and HSI (much like a VOR).

The most common application for using the **OBS** Softkey is the missed approach. The system suspends automatic waypoint sequencing (indicated by a ‘SUSP’ annunciation placed on the HSI) when the missed approach point (MAP) is crossed. This prevents the system from automatically sequencing to the missed approach holding point (MAHP). During this time, the **OBS** Softkey designation changes to **SUSP**. Pressing the **SUSP** Softkey reactivates automatic waypoint sequencing. The **OBS** Softkey then resumes its normal functionality.

**WHY DOES THE SYSTEM NOT AUTOMATICALLY SEQUENCE TO THE NEXT WAYPOINT?**

The system only sequences flight plan waypoints when automatic sequencing is enabled (i.e., no “OBS” or “SUSP” annunciation). For automatic sequencing to occur, the aircraft must also cross the “bisector” of the turn being navigated. The bisector is a line passing through the waypoint common to two flight plan legs at an equal angle from each leg.

**HOW CAN A WAYPOINT BE SKIPPED IN AN APPROACH, A DEPARTURE, OR AN ARRIVAL?**

The system allows the pilot to manually select any approach, departure, or arrival leg as the active leg of the flight plan. This procedure is performed on the MFD from the Active Flight Plan Page by highlighting the desired waypoint and selecting the **ACT LEG** Softkey then the **ENT** Key to approve the selection. The GPS then provides navigation along the selected flight plan leg.

**WHEN DOES TURN ANTICIPATION BEGIN?**

The system smooths adjacent leg transitions based on a normal 15° bank angle (with the ability to roll up to 30°) and provides three pilot cues for turn anticipation:

- A waypoint alert (‘Next DTK ###° in # seconds’ or ‘Next HDG ###° in # seconds’) appears on the PFD 10 seconds before the turn point and flashes as it counts down to zero.
- A flashing turn advisory (‘Turn [right/left] to ###° in # seconds’) appears on the PFD 10 seconds before the turn and flashes as it counts down to zero. ‘Turn [right/left] to ###° now’ or ‘Next [DTK/HDG] to ###° now’ is displayed when the pilot is to begin the turn and the HSI (GPS mode) automatically sequences to the next DTK or HDG value.
- The To/From indicator on the HSI flips momentarily to indicate that the midpoint of the turn has been crossed.

## WHEN DOES THE CDI SCALE CHANGE?

Once a departure is activated, the Prodigy® Course Deviation Indicator (CDI) full scale deflection is set to 0.3 nm. The CDI scale changes to 1.0 nm (terminal mode) then ramps up to 2.0 nm (enroute mode) at 30 nm from the departure airport. When 31 nm from the destination, the CDI scale smoothly transition from 2.0 nm back to 1.0 nm (terminal mode). At 2.0 nm before the FAF during an active approach, the CDI scale transitions down further based on the type of approach activated (LNAV, LNAV/VNAV, LPV). When a missed approach is activated, the CDI is set to 0.3 nm. See the Flight Instruments Section for more details on CDI scaling.

## WHY DOES THE HSI NOT RESPOND LIKE A VOR WHEN OBS MODE IS ACTIVE?

Unlike a VOR, the CDI scale used on GPS equipment is based on the crosstrack distance to the desired course, not on the angular relationship to the destination. Therefore, the CDI deflection on the GPS is constant regardless of the distance to the destination and does not become less sensitive when further away from the destination.

## WHAT IS THE CORRECT MISSED APPROACH PROCEDURE? HOW IS THE MISSED APPROACH HOLDING POINT SELECTED?

To comply with TSO specifications, the system does not automatically sequence past the MAP. The first waypoint in the missed approach procedure becomes the active waypoint when the **SUSP** Softkey is selected *after* crossing the MAP, or the go-around button is pressed. All published missed approach procedures must be followed, as indicated on the approach plate.

To execute the missed approach procedure prior to the MAP (not recommended), select the Active Flight Plan Page and use the **ACT LEG** Softkey to activate the missed approach portion of the procedure.

## AFTER A MISSED APPROACH, HOW CAN THE SAME APPROACH BE RE-SELECTED? HOW CAN A NEW APPROACH BE ACTIVATED?



---

**NOTE:** Do not attempt to reactivate the current approach prior to crossing the missed approach point (MAP). If an attempt to do so is made, an alert message "Are you sure you want to discontinue the current approach?" appears. The system directs the pilot back to the transition waypoint and does not take into consideration any missed approach procedures, if the current approach is reactivated.

---

After flying the missed approach procedure, the pilot may reactivate the same approach for another attempt by pressing the **PROC** Key. Once the clearance is given for another attempt, activate the approach by highlighting 'ACTIVATE APPROACH' using the large **FMS** Knob and pressing the **ENT** Key. The system provides navigation along the desired course to the waypoint and rejoins the approach in sequence from that point.

To activate a new approach for the same airport, select the new procedure by pressing the **PROC** Key. Choose 'SELECT APPROACH', select the desired approach from the list shown, and press the **ENT** Key. Select the desired transition, then activate the approach using the **ENT** Key.

To activate a new approach to a different airport, press the **Direct-to** Key and select the desired airport using the **FMS** Knobs. Press the **ENT** Key to accept the selected airport, then follow the steps in the preceding paragraph to select an approach for the new airport.

## GENERAL TIS INFORMATION

### INTRODUCTION

---



**NOTE:** Aircraft without an operating transponder are invisible to TIS.

---

The Traffic Information Service (TIS) provides traffic advisory information to non-TAS/TCAS-equipped aircraft. TIS is a ground-based service providing the relative locations of all ATCRBS Mode-A and Mode-C transponder equipped aircraft within a specified service volume. The TIS ground sensor uses real-time track reports to generate traffic notification. The system displays TIS traffic information on the Traffic Map Page of the MFD. TIS information may also be displayed for overlay on the MFD Navigation Map Page, as well as on the PFD Inset Map. Surveillance data includes all transponder-equipped aircraft within the coverage volume. The system displays up to eight traffic targets within a 7.5 nm radius, from 3,000 feet below, to 3,500 feet above the requesting aircraft.

### TIS VS. TAS/TCAS

---

The Traffic Information System (TIS) is a ground-based service that requires contact with a ground station through a datalink radio in order to receive traffic information. Traffic Advisory (TAS) and Traffic Collision Avoidance Systems (TCAS) are self-contained. TAS/TCAS uses an airborne interrogator with a half-second update rate, while TIS utilizes the terminal Mode-S ground interrogator and accompanying data link to provide a five-second update rate. TIS and TAS/TCAS have similar ranges.

### TIS LIMITATIONS

---



**NOTE:** TIS is not intended to be used as a collision avoidance system and does not relieve the pilot of the responsibility to “see and avoid” other aircraft. TIS shall not be used for avoidance maneuvers during instrument meteorological conditions (IMC) or when there is no visual contact with the intruder aircraft.

---



**NOTE:** Refer to the TIS Limitations section of the Aeronautical Information Manual (AIM) for a more comprehensive explanation.

---

TIS relies on surveillance of the Mode-S radar system, which is a “secondary surveillance” radar system similar to that used by ATCRBS. Many limitations are inherent in secondary radar surveillance. Information provided by TIS is neither better nor more accurate than the information used by ATC. TIS is intended only to assist in visual acquisition of other aircraft in visual meteorological conditions (VMC). While TIS is a useful aid for visual traffic avoidance, system limitations must be considered to ensure proper use. No recommended avoidance maneuvers are given, nor authorized, as a direct result of a TIS intruder display or TIS advisory.

- TIS operation may be intermittent during turns or other maneuvering.
- TIS is dependent on two-way, line-of-sight communications between the aircraft and the Mode-S radar antenna. Whenever the structure of the aircraft comes between the transponder antenna and the ground-based radar antenna, the signal may be temporarily interrupted.
- Other limitations and anomalies associated with TIS are described in the AIM.



---

**WARNING:** Garmin is not responsible for Mode S geographical coverage. Operation of the ground stations is the responsibility of the FAA. Refer to the AIM for a Terminal Mode S radar site map.

---



---

**NOTE:** TIS is unavailable at low altitudes in many areas of the United States. This is often the case in mountainous regions.

---

TIS information is collected during a single radar sweep. Collected information is then sent through the Mode S uplink on the next radar sweep. Because of this, the surveillance information is approximately five seconds old. TIS ground station tracking software uses prediction algorithms to compensate for this delay. These algorithms use track history data to calculate expected intruder positions consistent with the time of display. Occasionally, aircraft maneuvering may cause variations in this calculation and create slight errors on the Traffic Map Page. Errors affect relative bearing information and target track vector. This can cause a delay in the displayed intruder information. However, intruder distance and altitude typically remain relatively accurate and may be used to assist in spotting traffic.

The following errors are common examples:

- When the client or intruder aircraft maneuvers excessively or abruptly, the tracking algorithm may report incorrect horizontal position until the maneuvering aircraft stabilizes.
- When a rapidly closing intruder is on a course that intercepts the client aircraft course at a shallow angle (either overtaking or head-on) and either aircraft abruptly changes course within 0.25 nm, TIS may display the intruder aircraft on the incorrect side of the client aircraft.

These are rare occurrences and are typically resolved within a few radar sweeps once the client/intruder aircraft course stabilizes.

Pilots using TIS can provide valuable assistance in the correction of malfunctions by reporting observations of undesirable performance. Reports should identify the time of observation, location, type and identity of the aircraft, and describe the condition observed. Reports should also include the type of transponder and transponder software version. Since TIS performance is monitored by maintenance personnel, not ATC, malfunctions should be reported in the following ways:

- By telephone to the nearest Flight Service Station (FSS) facility
- By FAA Form 8000-7, Safety Improvement Report (postage-paid card can be obtained at FAA FSSs, General Aviation District Offices, Flight Standards District Offices, and General Aviation Fixed Base Operators)

## DISPLAY SYMBOLS



**NOTE:** Refer to the GPS Navigation Section for the topography legend and the Hazard Avoidance Section for XM Weather Product legends.

### AIRPORT

Item	Symbol
Unknown Airport	
Non-towered, Non-serviced Airport	
Towered, Non-serviced Airport	
Non-towered, Serviced Airport	
Towered, Serviced Airport	
Restricted (Private) Airport	
Heliport	















### NAVAIDS

Item	Symbol
Intersection	
LOM (compass locator at outer marker)	
NDB (non-directional radio beacon)	
VOR	
VOR/DME	
VOR/ILS	
VORTAC	
TACAN	







### LINE SYMBOLS

Item	Symbol
ICAO Control Area Class B Airspace	
Mode C Tower Area	
Warning Area Prohibited Area Alert Area Restricted Area Caution Area Training Area Danger Area Unknown Area	
Class C Terminal Radar Service Area Mode C Area	
Military Operations Area (MOA)	
State or Province Border	
International Border	
Road	
Railroad	
Latitude/Longitude	

MISCELLANEOUS

Item	Symbol
ARTCC Frequency or FSS Frequency	
Default Map Pointer	
Elevation Pointer	
Wind Vector	
Measuring Pointer	
Overzoom Indicator	
Terrain Proximity or TAWS Enabled	
Traffic Enabled	
User Waypoint	
Vertical Navigation Along Track Waypoint	
Parallel Track Waypoint	
Unanchored Flight Path Waypoint	
Top of Descent (TOD)	
Bottom of Descent (BOD)	
Navigating using Dead Reckoning	

TRAFFIC

Traffic Symbol	Description
	Non-Threat Traffic
	Proximity Advisory (PA) (Not available with TIS)
	Traffic Advisory (TA)
	Traffic Advisory Off Scale
	Resolution Advisory (RA) (TCAS II only)
	Resolution Advisory Off Scale (TCAS II only)

TERRAIN AVOIDANCE COLORS AND SYMBOLS

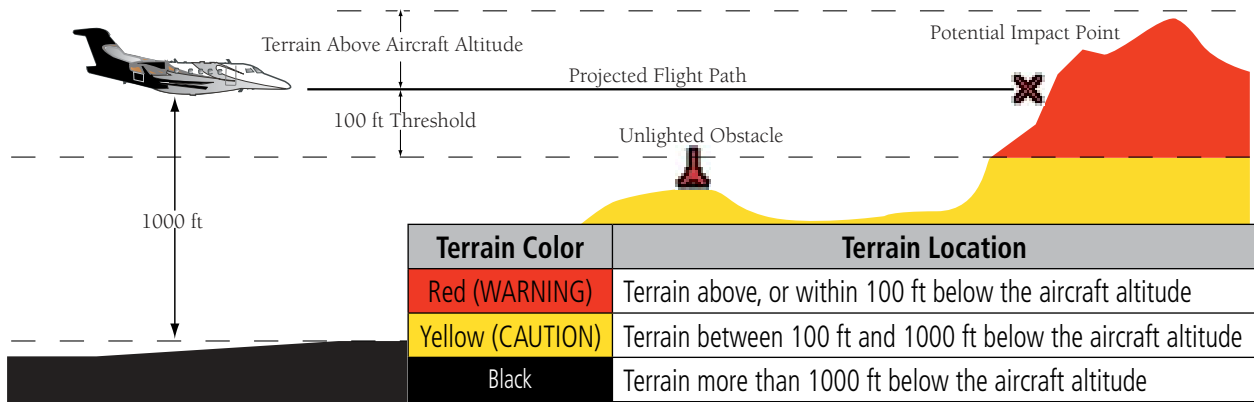

TAWS Color Chart























Figure E-3 TAWS Potential Impact Points

Height	Unlighted Obstacle		Lighted Obstacle		Obstacle Color	Obstacle Location
	< 1000 ft AGL	> 1000 ft AGL	< 1000 ft AGL	> 1000 ft AGL		
Obstacle Symbol					Red (WARNING)	Obstacle within 100 ft of or above aircraft altitude
					Yellow (CAUTION)	Obstacle within 1000 ft of aircraft altitude
					Gray	Obstacle more than 1000 ft below aircraft altitude

Obstacle Symbols and Colors



HAZARD AVOIDANCE FEATURES

Feature	Symbol
Terrain Proximity/TAWS display enabled	
Traffic display enabled	
NEXRAD display enabled	
Cloud Top display enabled	
Echo Top display enabled	
XM Lightning display enabled	
Cell Movement display enabled	
SIGMETs/AIRMETs display enabled	
METARs display enabled	
City Forecast display enabled	
Surface Analysis display enabled	
Freezing Levels display enabled	
Winds Aloft display enabled	
County Warnings display enabled	
Cyclone Warnings display enabled	
Icing Potential (CIP and SLD) (ICNG)	
Pilot Weather Report (PIREPs)	
Air Report (AIREPs)	
Turbulence (TURB)	
Loss of hazard avoidance feature (due to loss of GPS position)	

**A**

AAirport Directory	633
Abnormal engine operations	122
Access code	549
Activate a Flight Plan	257
Active database	630, 631
Active frequency	132, 142
ADF	152
AC-U-KWIK	487, 544, 633, 634
ADF	
ADF mode	152, 154
ANT mode	154
ADF/BFO	154
ADF/DME tuning	155
Advisories, CAS	119–120, 604–605
AFCS status box	60
AHRS	28, 30, 609, 618, 619, 620
Airborne Color Weather Radar	363
Aircraft symbol	66
Air Data Computer	1, 30, 607, 609
AIREP	359
Airport	
Information	215
Nearest	51
Airport Directory	487, 544, 545, 546, 633
Airspace alerts	231
Airspace Alerts	231
Airspeed bug	449, 457
Airspeed Indicator	62
Airspeed Reference	60, 63, 451–452
Airspeed Reference Bug	60
Airways	22
Collapsed	270
Expanded	270
Alert messages	620
Alerts	
Airspace	48
Alerts, Aircraft	601
Along Track Offset	262
ALT	323
Altimeter	60, 67
Altitude alerting	90
Altitude buffer	48
Altitude constraints	273, 310
Altitude Hold Mode	448
Altitude trend vector	67
Annunciations	
Test tone	52
Annunciations, Prodigy System	30
Annunciator lights	167
ANT/BFO	154
Antenna stabilization	380
Antenna tilt	377

AOPA	487, 544, 633, 634
Approach	646
Activating	286
ILS	481
Loading	254, 283, 285
Missed	483
Removing	286
WAAS	482
Approach Mode	467, 481
Approach Mode, AFCS	482
APR softkey	285, 291
Arrival procedure	238, 252, 280, 282, 308, 310, 319
Attitude	1
Attitude & Heading Reference System	607
Attitude indicator	60, 65, 65–66
Attitude Indicator	427
Audio Panel Fail-Safe Operation	176
Aural alerts	627
Automatic Flight Control System (AFCS)	439–445
Alerts and annunciations	485–486
Controls	440–441
Status Box	443
Automatic squelch	141
Automatic Thrust Reserve (ATR)	101–102
Autopilot	439, 469–471
Autopilot Disconnect	441, 461
Auto-tuning	150
Auto-tuning, COM	136
Auto-tuning, NAV	146
Auto Zoom	183
Auxiliary Pages (AUX)	39
AUX - system status page	504, 506, 525, 526, 541, 542, 543, 546
Aviation Symbols	195, 238

**B**

Backlighting	57, 58
Barometric Altimeter Setting	60
Barometric setting	68–69
Baro Transition Alert	70
Basic Empty Weight	292
Basic Operating Weight	292
Battery indications	100, 104
Bearing/distance, measuring	190
Bearing information windows	61
Bearing line	375, 379
Bearing pointer	75
Bearing source	76

**C**

Cabin speaker	167
Calibrated Airspeed	288
Cargo	293

CAS Window	61
Cautions, CAS	117–119, 601–603
CDI	282, 299, 310, 318, 325, 621
CELL MOV Softkey	347
Chart Not Available	508, 528
Chart options	516, 535
CHART SETUP box	522, 539
ChartView	487, 507, 525
Checklists	594–595
Checklist softkeys	594
City Forecast	352
CLD TOP Softkey	345
Clearance Recorder and Player	170
Closest Point	270
CLR Key	166
Code selection softkeys	163
COM channel spacing	140
COM Frequency Box	60, 132
Command Bars	445
Comparator window	61, 88
COM radio	
Channel spacing	51
COM Tuning Failure	174
Controls	
Softkeys	14–17
Control Wheel Steering (CWS)	441, 470
Copy a Flight Plan	257
County Warnings	355
Course deviation indicator (CDI)	60, 77
Course Deviation Indicator (CDI)	50
Course To Altitude	287
Crew Alerting System (CAS)	115–121
Messages	115–120
Cruise Speed Control (CSC)	104
Cyclone	356
<b>D</b>	
Data Bar fields, MFD	49
Database	25
Databases	629
Database synchronization	52
Database Synchronization	629, 634, 635
Data link	1
Data Link Receiver troubleshooting	599
Data report	39
Data reports	581, 582, 583, 584
Date and time	46
Day/Night Views	522, 539
Day View	523, 540
DB Mismatch	629
Dead reckoning	95
Decision Height	61
Declutter	22
Declutter, display	96
Delete Flight Plans	258
Deleting an entire airway	259, 260
Deleting an entire procedure	259, 260
Deleting an individual waypoint	259, 260
Deleting Flight Plan Items	259
Density Altitude	290
Departure	
Select	277, 280, 283, 286
Timer	54
Departure procedure	250, 264, 277, 279
Departure Time	288
Digital audio entertainment	4
Dilution of Precision (DOP)	32
Direct-to208, 232, 233, 234, 235, 236, 271, 272, 308, 310, 325	
Display backup	27, 129
Diversity transponder	156
DME	
HOLD mode	155
NAV1 mode	155
NAV2 mode	155
Tuning mode	152, 155
DME audio	143
DME information	76
DME information windows	61
Dual navigation database	630
<b>E</b>	
ECHO TOP Softkey	344
Electrical indications	104, 110
Electronic checklists	594, 595, 596
Emergency checklist	595
Emergency frequency	174
Engine failure	122
Engine fire	122
Engine Indication System (EIS)	100–107
Engine maintenance	114
Engine rotation speeds	100, 102
Entering Flight ID	156
Entertainment Inputs	171
Environmental Control System (ECS)	108–109
Estimated Landing Fuel	294
Estimated Position Error (EPE)	32
Ethernet	26
Excess Fuel Weight	294
Export Flight Plan	627
<b>F</b>	
Failure	
Input	29
Field of View (SVS)	206
Flap Indicator	100, 106

Flight director	439, 442–443
Modes, lateral	462–486
Modes, vertical	446–460
Switching	444
Flight ID	166
Flight instruments	59–74
Flight Level Change Mode	451, 477
Flight plan	
Closest point to reference	270
Storing	646
Flight Plan Window	61
Flight timer	54
FliteCharts	487, 527
FliteCharts®	487
FliteCharts cycle	542
FliteCharts expiration	542
FliteCharts functions	527
FPA	273, 315
Freezing Levels	353
Frequency	
Nearest	228
Frequency spacing	140
Frequency transfer arrow	133
Frequently asked questions	645
Fuel	
Efficiency	290
Endurance	290
Remaining	290
Required	290
Fuel indications	100, 104, 111
Fuel on Board	290, 293, 294
Fuel Statistics	290

## G

Gain	378
Garmin Flight Data Services	487, 581
GDC 74A	1
GDL 69/69A	1
GDU 1040	1
GEA 71	1
geodetic sea level	384, 398
GFC 700	439
GIA 63	1
Glidepath	323
Glidepath indicator	61, 71
Glidepath Mode	458, 467
Glidepath Mode (GP)	482
Glideslope	323
Glideslope indicator	71
Glideslope Mode	460, 481

Global Positioning System (GPS)	
Navigation	232–328
Receiver information	31–33
GMA 1347	1, 25, 57
GMU 44	1
Go Around Mode	461, 483–484
GPS Window	635
Ground mapping	382
Groundspeed	55
GRS 77	1
GSL	384, 398
GTX 33	1
GTX 33/33D Transponder	156

## H

Heading bug	60, 72
Heading Bug	60
Heading indicator	60
Heading Select Mode	464
HI SENS	151
Horizontal scan	373, 374, 375, 376, 377, 381, 382
Horizontal situation indicator	72–74
Horizontal situation indicator (HSI)	60
HSI double green arrow	142
HSI magenta arrow	142
HSI single green arrow	142
hurricane	356

## I

Icing	357
IDENT function	166
ID indicator	145
ILS approach	481
Import Flight Plan	627
Indicated airspeed	62
Indicated Altitude	288
Initialization (system)	25
Inset map	61
Intercom	168
Intersection	
Information	216–217
Interstage Turbine Temperature (ITT)	100, 122
Inverting a flight plan	257
IOI	391, 403, 623, 625
Iridium	547
Iridium satellite network	547, 551, 556, 560, 562, 564

## J

Jeppesen aviation database	629
----------------------------	-----

**K**

Key(s) ----- 8, 9

**L**

Landing Field Elevation (LFE) ----- 105

Landing gear status ----- 100, 106

Land Symbols ----- 194

Lateral modes, flight director ----- 462–486

LNAV ----- 299

LO SENS ----- 151

Low altitude annunciation ----- 91

Low speed data ----- 547, 550

LPV ----- 299, 325, 472

**M**

Mach number ----- 62

Mach number indicator ----- 60

Magnetometer ----- 1, 29

Map pages ----- 38

Map Panning ----- 185

Marker beacon ----- 89, 151

MASQ processing ----- 125

Measurement units, changing displayed ----- 47

Menus ----- 36

Message advisories 611, 612, 613, 614, 616, 618, 619, 620, 621, 622

Messages  
Reminder ----- 55

Messages window ----- 593

MFD Data Bar fields ----- 49

Minimum Anti-Ice N1 Bug ----- 102, 103, 113

Minimum descent altitude ----- 92

Minimum Descent Altitude ----- 61

MISCOMP ----- 606

Missed approach ----- 483

Missed Approach ----- 238, 287, 295, 299, 325

MKR/MUTE ----- 151

Mode S ----- 17, 156, 158, 159, 162

Mode selection softkeys -- 157, 158, 159, 160, 161, 163

Mode S Transponder

GTX 33/33D Controls ----- 157

GTX 33/33D Mode Selection ----- 158

TCAS II Transponder Controls ----- 160

TCAS II Transponder Mode Selection ----- 161

Morse code identifier ----- 145

Multi Function Display (MFD)

Softkeys ----- 21

Music 1 ----- 171

Music 2 ----- 171

**N**

N1 gauge ----- 102–103, 122

N1 Transient Limit ----- 102

N2 indications ----- 102

National Weather Service ----- 355

NAV1 audio ----- 143

NAV2 audio ----- 143

Navigation database ----- 273, 274, 613

Navigation Map ----- 235

Navigation Mode ----- 465–466, 475–476

Navigation mode selection ----- 142

Navigation (NAV) frequency box ----- 60

Navigation source ----- 77–79

Nav radio selection ----- 142

Nearest

Airports ----- 51, 228–231

VOR ----- 228–229

nearest airport ----- 212, 213, 214

Nearest Airport ----- 212, 213, 214, 215, 285

Minimum Runway Length ----- 215

Surface Matching ----- 215

Nearest airports, frequency tuning ----- 136

Nearest Airports Page ----- 213, 214, 215

Nearest Pages (NRST) ----- 41

NEXRAD ----- 22

NEXRAD Softkey ----- 339

Night view ----- 523, 540

NO COMP ----- 606

Non-path descent ----- 456, 479–480

Normal operating mode ----- 26

**O**

Obstacles ----- 613, 615

Odometer ----- 55

Oil, engine ----- 100, 102

Omni-bearing selector (OBS) ----- 83

Omni Bearing Selector (OBS) ----- 646–647

Other Statistics ----- 288, 290

Outside Air Temperature (OAT) ----- 101

Overspeed protection, autopilot ----- 446

Overview ----- 1

**P**

Page groups ----- 37–40

Parallel Track ----- 263, 264

Passenger ----- 293

Passenger Address (PA) System ----- 169

Passengers ----- 292, 293

PFD failure ----- 175

Pilot and Stores Weight ----- 292

Pilot profiles ----- 43–44  
 PIREP ----- 359  
 Pitch Hold Mode ----- 447  
 Pitch indication ----- 65  
 Power ON settings ----- 167  
 Power-up page ----- 594  
 Predefined message ----- 569, 570, 571  
 Pressure, oil ----- 100, 102  
 Pressurization ----- 105  
 Primary Flight Display (PFD)  
   Softkeys ----- 14–16  
 Procedures  
   GFC 700 ----- 472–484

**Q**

Quick tuning 121.500 MHz ----- 135

**R**

RA ----- 426  
 Radar Altimeter ----- 61  
 Radar altitude ----- 93  
 RAIM ----- 282, 295, 296, 297, 298  
 Range ----- 204  
 Receiver Autonomous Integrity Monitoring (RAIM) 3 3 – 3 4,  
 295, 645  
 Register ----- 549  
 Reminder messages ----- 55  
 Report transmissions ----- 581  
 Required Vertical Speed ----- 316  
 Required Vertical Speed Indicator ----- 316  
 Resolution advisory ----- 427  
 Reversionary Mode ----- 176  
 Reversionary sensor ----- 607  
 Reversionary sensor window ----- 88  
 Reversionary Sensor Window ----- 61  
 ROC ----- 391, 403, 623, 625  
 Roll Hold Mode ----- 463  
 RS-232 ----- 2, 4  
 RS-485 ----- 3, 4  
 Runway  
   Minimum length ----- 51  
   Surface ----- 51  
 RVSI ----- 316, 317  
 RX indicator ----- 133

**S**

SafeTaxi ----- 487, 501, 504  
 SafeTaxi® ----- 487  
 SafeTaxi database ----- 505  
 SBAS ----- 295, 297, 298, 615, 616, 643, 645  
 Scheduler ----- 55–56, 487–488, 592  
 SD card ----- 24

Sector scan ----- 379  
 Secure Digital (SD) card ----- 594, 629  
 Selected altitude ----- 67  
 Selected Altitude ----- 60, 447, 448, 450, 451, 453, 457  
 Selected altitude bug ----- 60  
 Selected Altitude Capture Mode ----- 447, 448, 450, 453  
 Selected Altitude Intercept Arc ----- 207  
 Selected course ----- 61, 73  
 Selected Course ----- 465, 468  
 Selected heading ----- 61, 73  
 Selected Heading ----- 11, 440, 464  
 Selecting a COM radio ----- 132  
 Sensor ----- 606, 607  
 Sequencing, automatic ----- 647  
 Service Class ----- 588  
 Servos, AFCS ----- 439  
 SIGMET ----- 348  
 Simultaneous COM Operation ----- 169  
 SiriusXM  
   radio ----- 330, 587  
   Receiver troubleshooting ----- 599  
   XM Satellite Weather ----- 330  
 SiriusXM active channel ----- 589  
 SiriusXM channel list ----- 589  
 SiriusXM lightning ----- 22  
 SiriusXM presets ----- 590  
 SiriusXM radio volume ----- 591  
 SiriusXM Satellite Radio ----- 587  
 SiriusXM Satellite Weather  
   AIRMETs ----- 348  
   SIGMETs ----- 348  
 SiriusXM weather/radio ----- 4  
 Slip/Skid indicator ----- 60, 65  
 SMS ----- 487  
 Softkeys ----- 14–17, 60  
   LTNG ----- 346  
 Speaker ----- 167  
 Speed brake status ----- 100, 106  
 STAB ----- 380  
 Standby frequency ----- 132, 136, 142  
   ADF ----- 152  
 Standby frequency field ----- 132  
 Standby Navigation Database ----- 631, 632  
 Static air temperature (SAT) ----- 60, 85  
 Stereo headsets ----- 167  
 Stuck microphone ----- 174  
 Stuck Microphone ----- 174  
 Sunrise ----- 289  
 Sunset ----- 289  
 Surface Analysis ----- 352  
 SVS ----- 622  
 SVS troubleshooting ----- 597  
 Symbols, map ----- 651

Synoptics	107–114
Synthetic vision (SVS)	487, 488
System alerting	88
System annunciations	30, 608
System ID	547
System message advisories	610
System Setup Page	42
System Status Page	52
System time	47, 60
<b>T</b>	
TA	426
TAF	349
Takeoff Mode	461
TAS	618
TAWS 90, 384, 391, 397, 403, 414, 416, 623, 624, 625	
TAWS-A	90, 398, 624
TAWS-A Alerts	
Excessive below Glideslope/Glidepath	412
Excessive Closure Rate Alert	406
Excessive Descent Rate Alert	406
Flap Override Annunciation	408
Flight Into Terrain Alert	407
Forward Looking Terrain Avoidance	404
Inhibiting FLTA and PDA Alerts	405
Inhibiting GPWS Alerts	411
Negative Climb Rate After Takeoff Alert	409
Premature Descent Alerting	405
TAWS Annunciation	61
TAWS-A Page	400
TAWS-B	384
System Status	396
TAWS-B Alerts	390
Excessive Descent Rate Alert	392
Five-Hundred Aural Alert	394
Forward Looking Terrain Avoidance (FLTA)	392
Negative Climb Rate After Takeoff Alert	394
Premature Descent Alerting	393
TAWS-B Page	388
TCAS II Traffic	425
Operation	430
Resolution advisories	427
Symbology	425
System Status	436
System Test	429
TCAS II Alerts	426
Telephone	5, 39, 487, 547, 551, 552
Temperature, oil	100, 102
Temperature, Outside Air (OAT)	101
Terminal procedures charts	508, 528
Terrain	22, 391, 403, 613, 623
Color indications	653
Terrain Awareness and Warning System	90, 384, 398
Text message	564, 566, 569, 572
Text messaging	564
Thrust rating	103
Tilt	376, 377
Tilt line	377
Timer	621
Departure	54
Flight	54
Timer, PFD generic	53
Time, system	46
TIS	417
TOD	315, 316, 322
Toggling ADF frequencies	153
TOPO DATA	191, 192, 201
Top of Descent	315, 316
Topographical data	22
TOPO SCALE	193
Total air temperature (TAT)	60, 85
Track indicator	60
Traffic	22
Voice alerts	89
Traffic advisory	373
Traffic annunciation	61, 89
Traffic Information Service (TIS)	649–650
Transponder	17, 18
Transponder code entry	163
Transponder data box	125
Transponder ground mode	159
Transponder mode field	125, 158, 159, 161, 162
Transponder standby mode	158, 161
Transponder status box	60
Trend vector, airspeed	63
Trend vector, altitude	67
Trend vector, turn rate	75
Trim Indicator	100, 106, 123
Trip Planning	288, 289, 290
Trip statistics	55
Trip Statistics	289, 290
True Airspeed	290
True airspeed (TAS)	60
Tuning ADF frequencies	153
Turbulence	358
Turn anticipation	647
Turn rate indicator	60, 75
Turn Rate Indicator	60
TX indicator	133
<b>U</b>	
Unable to display chart	508, 528
Updating Garmin databases	505
Using XM Radio	589



**V**

VDI	316, 317
Vertical deviation	68, 455
Vertical deviation guidance	274
Vertical Deviation Indicator	316
Vertical navigation	273
Direct-to	272, 273
Vertical Navigation flight control	453–457
Vertical Path Tracking Mode	453–454, 478
Vertical scan	376, 377
Vertical speed guidance	274
Vertical Speed Indicator	60, 61, 427
Vertical speed indicator (VSI)	71
Vertical Speed Mode	450
VFR code	165
VNAV	237
VNAV Target Altitude	453–456
VNAV Target Altitude Capture Mode	457
VNV	315, 622, 644
VNV guidance	
Disabling	272
Enabling	271
VNV indications, PFD	87
VNV target altitude	71
Voice alerts, TIS Traffic	421
Voltmeter, battery	100, 104
Volume	591
VOR	
Nearest	228–229
VOR selection	142
VSI	317
Vspeeds	61, 63–64
VS TGT	273, 315

**W**

WAAS	299, 472, 644, 645
WAAS precision approach	482
WATCH	380, 381, 382
Waypoint	
Automatic sequencing	647
Skipping	647
Waypoint Pages (WPT)	38
Waypoint Selection Submenu	233, 241, 245, 295
Weather Attenuated Color Highlight	380
Wi-Fi	4, 39, 487, 547, 576, 580, 581
Wind	180, 203
Wind data	61, 86
Winds Aloft	354
WIND Softkey	354

**X**

XM Radio Entertainment	171
XPDR softkey	158, 161, 163, 165

**Z**

Zoom	
Auto	183

**BLANK PAGE**







# GARMIN®



Garmin International, Inc.  
1200 East 151st Street  
Olathe, KS 66062, U.S.A.  
p:913.397.8200  
f:913.397.8282

Garmin AT, Inc.  
2345 Turner Road SE  
Salem, OR 97302, U.S.A.  
p:503.391.3411  
f:503.364.2138

Garmin (Europe) Ltd.  
Liberty House, Bulls Copse Road  
Houndsdown Business Park  
Southampton, SO40 9RB, U.K.  
p:44/0870.8501241  
f:44/0870.8501251

Garmin Corporation  
No. 68, Jangshu 2nd Road  
Shijr, Taipei County, Taiwan  
p:886/02.2642.9199  
f:886/02.2642.9099

[www.garmin.com](http://www.garmin.com)

