

# æra™

models: 500, 510, 550, 560



Pilot's Guide



**OVERVIEW**

**GPS NAVIGATION**

**FLIGHT PLANNING**

**HAZARD AVOIDANCE**

**ADDITIONAL FEATURES**

**APPENDICES**

**INDEX**



Copyright © 2009, 2010, 2012 Garmin Ltd. or its subsidiaries. All rights reserved.

This manual reflects the operation of System Software version 4.00 or later. Some differences in operation may be observed when comparing the information in this manual to earlier or later software versions.

Garmin International, Inc., 1200 East 151st Street, Olathe, Kansas 66062, U.S.A.  
Tel: 913/397.8200 Fax: 913/397.8282

Garmin AT, Inc., 2345 Turner Road SE, Salem, OR 97302, U.S.A.  
Tel: 503/391.3411 Fax 503/364.2138

Garmin (Europe) Ltd, Liberty House, Bulls Copse Road, Hounslow Business Park,  
Southampton, SO40 9RB, U.K.  
Tel: 44/0870.8501241 Fax: 44/0870.8501251

Garmin Corporation, No. 68, Jangshu 2nd Road, Shijr, Taipei County, Taiwan  
Tel: 886/02.2642.9199 Fax: 886/02.2642.9099

Web Site Address: [www.garmin.com](http://www.garmin.com)

Except as expressly provided herein, no part of this manual may be reproduced, copied, transmitted, disseminated, downloaded or stored in any storage medium, for any purpose without the express written permission of Garmin. Garmin hereby grants permission to download a single copy of this manual and of any revision to this manual onto a hard drive or other electronic storage medium to be viewed for personal use, provided that such electronic or printed copy of this manual or revision must contain the complete text of this copyright notice and provided further that any unauthorized commercial distribution of this manual or any revision hereto is strictly prohibited.

Garmin® and SafeTaxi® are registered trademarks of Garmin Ltd. or its subsidiaries. aera™ is a trademark of Garmin Ltd. or its subsidiaries. These trademarks may not be used without the express permission of Garmin.

Jeppesen® is a registered trademark of Jeppesen, Inc.

XM® is a registered trademark of XM Satellite Radio, Inc.

AC-U-KWIK® is a registered trademark of Penton Business Media, Inc.





**WARNING:** When installing the aera™, place the unit so it does not obstruct the field of view or interfere with operating controls.

---



**WARNING:** The indicators represented on the Panel are based on GPS-derived data and may differ from the instruments in the aircraft.

---



**WARNING:** Navigation and terrain separation must NOT be predicated upon the use of the terrain function. The aera Terrain Proximity feature is NOT intended to be used as a primary reference for terrain avoidance and does not relieve the pilot from the responsibility of being aware of surroundings during flight. The Terrain Proximity feature is only to be used as an aid for terrain avoidance and is not certified for use in applications requiring a certified terrain awareness system. Terrain data is obtained from third party sources. Garmin is not able to independently verify the accuracy of the terrain data.

---



**WARNING:** The displayed minimum safe altitudes (MSAs) are only advisory in nature and should not be relied upon as the sole source of obstacle and terrain avoidance information. Always refer to current aeronautical charts for appropriate minimum clearance altitudes.

---



**WARNING:** The altitude calculated by aera GPS receivers is geometric height above Mean Sea Level and could vary significantly from the altitude displayed by pressure altimeters. Always use pressure altitude displayed by the aircraft altimeter when determining or selecting aircraft altitude.

---



**WARNING:** Do not use outdated database information. Databases used in the aera system must be updated regularly in order to ensure that the information remains current. Pilots using any outdated database do so entirely at their own risk.

---



**WARNING:** Do not use data link weather information for maneuvering in, near, or around areas of hazardous weather. Information contained within data link weather products may not accurately depict current weather conditions.

---



---

**WARNING:** Do not use the indicated data link weather product age to determine the age of the weather information shown by the data link weather product. Due to time delays inherent in gathering and processing weather data for data link transmission, the weather information shown by the data link weather product may be significantly older than the indicated weather product age.

---



---

**WARNING:** To reduce the risk of unsafe operation, carefully review and understand all aspects of the aera Pilot's Guide documentation and the Pilot's Operating Handbook of the aircraft. Thoroughly practice basic operation prior to actual use. During flight operations, carefully compare indications from the aera to all available navigation sources, including the information from other NAVAIDs, visual sightings, charts, etc. For safety purposes, always resolve any discrepancies before continuing navigation.

---



---

**WARNING:** The Garmin aera has a very high degree of functional integrity. However, the pilot must recognize that providing monitoring and/or self-test capability for all conceivable system failures is not practical. Although unlikely, it may be possible for erroneous operation to occur without a fault indication shown by the aera. It is thus the responsibility of the pilot to detect such an occurrence by means of cross-checking with all redundant or correlated information available in the cockpit.

---



---

**WARNING:** For safety reasons, aera operational procedures must be learned on the ground.

---



---

**WARNING:** The United States government operates the Global Positioning System and is solely responsible for its accuracy and maintenance. The GPS system is subject to changes which could affect the accuracy and performance of all GPS equipment. Portions of the Garmin aera utilize GPS as a precision electronic NAVigation AID (NAVAID). Therefore, as with all NAVAIDs, information presented by the aera can be misused or misinterpreted and, therefore, become unsafe.

---



---

**WARNING:** The data contained in the terrain and obstacle databases comes from government agencies. Garmin accurately processes and cross-validates the data, but cannot guarantee the accuracy and completeness of the data.

---



---

**WARNING:** Do not use basemap (land and water data) information for primary navigation. Basemap data is intended only to supplement other approved navigation data sources and should be considered as an aid to enhance situational awareness.

---



---

**WARNING:** Do not rely solely upon the display of traffic information for collision avoidance maneuvering. The traffic display does not provide collision avoidance resolution advisories and does not, under any circumstances or conditions, relieve the pilot's responsibility to see and avoid other aircraft.

---



---

**WARNING:** Do not rely solely upon the display of traffic information to accurately depict all of the traffic within range of the aircraft. Due to lack of equipment, poor signal reception, and/or inaccurate information from aircraft or ground stations, traffic may be present that is not represented on the display.

---



---

**CAUTION:** Avoid using any chemical or abrasive cleaners on the touchscreen and/or plastic casing. Clean the touchscreen with a soft, clean, lint-free cloth. Use water, isopropyl alcohol, or eyeglass cleaner, if needed.

---



---

**CAUTION:** The Garmin aera does not contain any user-serviceable parts. Repairs should only be made by an authorized Garmin service center. Unauthorized repairs or modifications could void both the warranty and the pilot's authority to operate this device under FAA/FCC regulations.

---



---

**NOTE:** All visual depictions contained within this document, including screen images of the aera panel and displays, are subject to change and may not reflect the most current aera system and aviation databases. Depictions of equipment may differ slightly from the actual equipment.

---



---

**NOTE:** This product, its packaging, and its components contain chemicals known to the State of California to cause cancer, birth defects, or reproductive harm. This notice is being provided in accordance with California's Proposition 65. If you have any questions or would like additional information, please refer to our web site at [www.garmin.com/prop65](http://www.garmin.com/prop65).

---





---

**NOTE:** Use of polarized eyewear may cause the display to appear dim or blank.

---



---

**NOTE:** Temporary Flight Restriction (TFR) data is provided by the FAA and may not be updated outside of normal business hours. Confirm data currency through alternate sources and contact your local FSS for interpretation of TFR data.

---

Blank Page

| <b>Part Number</b> | <b>Change Summary</b> |
|--------------------|-----------------------|
| 190-01194-00       | Initial release       |

| <b>Rev</b> | <b>Date</b>   | <b>Description</b>   |
|------------|---------------|----------------------|
| A          | October, 2009 | Production Release   |
| B          | August, 2012  | Added GDL 39 Support |

Blank Page

|  |           |
|--|-----------|
| <b>SECTION 1 OVERVIEW.....</b>                     | <b>1</b>  |
| <b>1.1 Unit Overview.....</b>                      | <b>1</b>  |
| <b>1.2 Getting Started .....</b>                   | <b>2</b>  |
| Battery Installation .....                         | 2         |
| Charging the Battery .....                         | 3         |
| Mounting the aera in the Aircraft.....             | 3         |
| Turning the Unit On/Off.....                       | 4         |
| Changing Modes.....                                | 4         |
| GPS Receiver Status .....                          | 5         |
| <b>1.3 Operation.....</b>                          | <b>7</b>  |
| Basic Navigation Controls.....                     | 7         |
| ‘Home’ Screen.....                                 | 8         |
| Selecting a Function .....                         | 15        |
| Scrolling.....                                     | 15        |
| <b>1.4 Accessing System Functionality.....</b>     | <b>16</b> |
| Option Menus .....                                 | 16        |
| Data Entry.....                                    | 16        |
| Waypoint Information Tabs .....                    | 18        |
| <b>1.5 Using Map Displays.....</b>                 | <b>18</b> |
| Map Range .....                                    | 19        |
| Map Panning .....                                  | 20        |
| Map Overlays.....                                  | 22        |
| Map Symbols .....                                  | 23        |
| <b>1.6 System Settings .....</b>                   | <b>24</b> |
| Display.....                                       | 24        |
| Sound.....   | 25        |
| Additional Settings.....                           | 26        |
| <b>1.7 Nearest Airport Criteria Settings .....</b> | <b>28</b> |
| <b>1.8 Present Position .....</b>                  | <b>29</b> |
| Position.....                                      | 29        |
| New Location.....                                  | 29        |
| Simulator Mode .....                               | 30        |
| <b>SECTION 2 GPS NAVIGATION .....</b>              | <b>31</b> |
| <b>2.1 Introduction.....</b>                       | <b>31</b> |
| Data Fields.....                                   | 32        |
| Numeric Flight Data .....                          | 35        |
| Compass Arc.....                                   | 36        |
| <b>2.2 HSI/Panel.....</b>                          | <b>37</b> |
| Changing the CDI Scale.....                        | 38        |
| Setting the Bug Indicator.....                     | 38        |
| Manually Setting a Course.....                     | 39        |

|   |            |
|---|------------|
| <b>2.3 Vertical Navigation (VNAV)</b> .....       | <b>40</b>  |
| Using the VNAV Feature .....                      | 41         |
| <b>2.4 Map Display Setup</b> .....                | <b>43</b>  |
| Map Orientation .....                             | 43         |
| Airports, Nav aids, Cities & Roads .....          | 44         |
| Airways .....                                     | 45         |
| <b>2.5 Waypoints</b> .....                        | <b>46</b>  |
| Nearest Information .....                         | 49         |
| Weather and NOTAM Information (Optional) .....    | 51         |
| Accessing Additional information .....            | 52         |
| <b>2.6 Direct-to Navigation</b> .....             | <b>64</b>  |
| <b>SECTION 3 FLIGHT PLANNING</b> .....            | <b>67</b>  |
| <b>3.1 Introduction</b> .....                     | <b>67</b>  |
| Data Fields .....                                 | 67         |
| <b>3.2 Flight Plan Creation</b> .....             | <b>68</b>  |
| Adding Waypoints to an Existing Flight Plan ..... | 70         |
| <b>3.3 Flight Plan Storage</b> .....              | <b>71</b>  |
| <b>3.4 Flight Plan Activation</b> .....           | <b>72</b>  |
| Editing Speed and Fuel Flow .....                 | 72         |
| Copying Flight Plans .....                        | 73         |
| Deleting Flight Plans .....                       | 73         |
| Inverting a Flight Plan .....                     | 74         |
| <b>3.5 Approaches</b> .....                       | <b>75</b>  |
| Selecting an Approach .....                       | 76         |
| Activating Vectors-to-Final .....                 | 78         |
| <b>SECTION 4 HAZARD AVOIDANCE</b> .....           | <b>79</b>  |
| <b>4.1 Weather</b> .....                          | <b>79</b>  |
| XM® Weather (aera 510 & 560) .....                | 79         |
| XM Satellite Weather Products .....               | 81         |
| Using XM Satellite Weather Products .....         | 91         |
| Data Link weather (FIS-B) (all models) .....      | 94         |
| <b>4.2 Terrain</b> .....                          | <b>106</b> |
| Terrain Information .....                         | 107        |
| Obstacle Information .....                        | 107        |
| Terrain and Obstacle Color Code .....             | 108        |
| Terrain Views .....                               | 108        |
| Terrain Alerts & Setup .....                      | 110        |
| <b>4.3 Traffic</b> .....                          | <b>112</b> |
| Traffic Information Service (TIS-A) .....         | 112        |
| Traffic Ground Track .....                        | 113        |
| Displaying Traffic Data .....                     | 113        |
| Data Link Traffic (GDL 39) .....                  | 115        |

|  |            |
|--|------------|
| <b>SECTION 5 ADDITIONAL FEATURES.....</b>                          | <b>125</b> |
| <b>5.1 SafeTaxi.....</b>   | <b>125</b> |
| SafeTaxi Cycle Number and Revision .....                           | 126        |
| <b>5.2 Airport Directory Data.....</b>                             | <b>127</b> |
| <b>5.3 XM® Radio (aera 510 &amp; 560).....</b>                     | <b>129</b> |
| Activating XM Satellite Radio Services .....                       | 130        |
| Using XM Radio .....   | 131        |
| <br>   |            |
| <b>SECTION 6 APPENDICES .....</b>                                  | <b>139</b> |
| <b>Appendix A: Messages, Alerts &amp; Data Field Options .....</b> | <b>139</b> |
| Miscellaneous Message Advisories.....                              | 139        |
| Airspace Messages.....   | 141        |
| Data Field & Numeric Data Options .....                            | 141        |
| Aural Alerts.....  | 143        |
| <b>Appendix B: Abnormal Operation.....</b>                         | <b>145</b> |
| Loss of GPS Position.....  | 145        |
| Hazard Display with Loss of GPS Position.....                      | 145        |
| <b>Appendix C: Managing Files and Databases.....</b>               | <b>147</b> |
| Connecting to a Computer .....                                     | 147        |
| Managing Files .....   | 148        |
| MicroSD™ Card Use (Optional) .....                                 | 150        |
| Databases.....   | 151        |
| <b>Appendix D: Installation and Interfacing .....</b>              | <b>155</b> |
| Mounting the aera in the Aircraft.....                             | 155        |
| Connecting to a Garmin VHF Comm Radio.....                         | 159        |
| Information about USB Drivers .....                                | 161        |
| Connecting the GXM 40 Antenna (aera 510 & 560).....                | 161        |
| Connecting to a GTX 330 Mode S Transponder .....                   | 162        |
| Connecting to a GDL 39.....  | 163        |
| Interfacing .....  | 165        |
| Using an external GPS Antenna (Optional).....                      | 167        |
| <b>Appendix E: Battery and Care Information .....</b>              | <b>169</b> |
| Battery Information.....   | 169        |
| Changing the Fuse .....  | 169        |
| Cleaning the Casing.....   | 170        |
| Cleaning the Touchscreen.....                                      | 170        |
| Protecting the Unit.....   | 170        |
| Avoiding Theft.....  | 171        |
| Registering the Unit .....   | 171        |
| <b>Appendix F: General TIS-A Information .....</b>                 | <b>173</b> |
| TIS-A vs. TAS/TCAS .....   | 173        |
| TIS-A Limitations.....   | 173        |

**Appendix G: Utilities.....177**

- Flight Log..... 177
- Track Log..... 178
- Heading Line..... 181
- E6B Calculator..... 182
- Aircraft Profile..... 184
- Weight & Balance..... 185
- EPE Circle..... 186
- Proximity Waypoints..... 187

**Appendix H: Display Symbols .....189**

- VFR Symbols..... 189
- IFR Symbols..... 190
- Airspace Symbols..... 192

**Appendix I: Map Datum and Location Formats.....195**

- Map Datums..... 195
- Location Formats..... 195

**Appendix J: Glossary.....197**

**Appendix K: License Agreement and Warranty.....203**

- Contact Garmin..... 203
- Software License Agreement..... 203
- Limited Warranty..... 203
- AOPA Airport Directory Notice..... 204
- AC-U-KWIK LICENSE AGREEMENT..... 204
- XM Satellite Radio Service Agreement..... 205
- Weather Data Warranty..... 205
- FCC Compliance..... 206
- Industry Canada Compliance..... 206

**Index..... Index-1**



# SECTION 1 OVERVIEW

## 1.1 UNIT OVERVIEW

In aviation mode the aera presents GPS-derived analog flight instrumentation, position, navigation, and hazard avoidance information to the pilot using a 4.3" QWVGA color display with Touch Screen.



## 1.2 GETTING STARTED

### BATTERY INSTALLATION



**NOTE:** Refer to Appendix E for additional battery information.



**CAUTION:** Always keep the battery installed when the unit is on.



**WARNING:** The product contains a lithium-ion battery. To prevent damage, remove the unit from the aircraft or vehicle when exiting or store it out of direct sunlight.

#### Installing the battery:

- 1) Locate the lithium-ion battery that came in the product box.
- 2) Slide the release key until the battery cover on the back of the aera opens up.
- 3) Remove the battery cover.
- 4) Locate the metal contacts on the end of the lithium-ion battery.
- 5) Insert the battery so that the metal contacts on the battery line-up with the metal contacts inside the battery compartment.
- 6) Slide the top of the battery cover into the groove on the inside of the battery compartment, and press down.



Installing the Battery

## CHARGING THE BATTERY



**NOTE:** While in Charge Mode, the unit draws a current from the aircraft. To avoid discharging the aircraft's battery, disconnect the external power cable from the unit when not in use for several days.

Charge the aera for at least 4 hours before using on battery power. Charge the battery by connecting the vehicle or aviation power cable, the USB cable, an AC adapter (optional accessory), or use a battery charger (optional accessory).

Plug the unit into a 12-Volt or 24-Volt connector to charge. The unit can be used while it is charging. Charge the unit within the following temperature range: 32° to 104°F (0° to 40°C).

### Charging the unit's battery using the aircraft's power outlet:

- 1) Mount the aera in the aircraft (refer to Appendix D 'Installation and Interfacing'), and connect the power cable to the aircraft power outlet (cigarette lighter receptacle).
- 2) Route the power cable so that it does not interfere with aircraft operation. The unit begins charging as soon as external power is applied.

## USING CHARGE MODE

Applying external power to the aera automatically turns on the unit for full operation. If the battery is present and needs to be charged, the external power source charges the battery while the unit is in use.

If you do not want to use the unit, but you would like to charge the battery, you can put the unit into Charge Mode. Connect the unit to an external power supply. Press and hold the  **POWER** Button. Instead of completely turning off, the unit now goes into Charge Mode.

The unit will run cooler and may allow more current to be available while in Charge Mode, when XM is unplugged, the backlight is turned down, etc.

## MOUNTING THE aera IN THE AIRCRAFT

Refer to Appendix D 'Installation & Interfacing' for information on mounting the aera in the aircraft.

## TURNING THE UNIT ON/OFF

Press and hold the  **POWER** Button to turn the unit on or off.

The first time the unit is turned on, the receiver must collect satellite data and establish its present location. To ensure proper initialization, the aera is shipped from the factory in AutoLocate mode, which allows the receiver to “find itself” anywhere in the world.

During initialization, current database information is displayed. Database information includes valid operating dates, cycle number, and database type. When this information has been reviewed for currency (to ensure that no databases have expired), the pilot is prompted to continue.

Touching the **Press To Accept** Button acknowledges this information, and the 'Home' Screen is displayed.

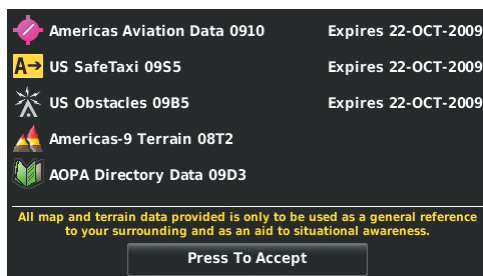

Database Initialization

## CHANGING MODES

The aera offers two modes for transportation: automotive and aviation.

### Changing modes:

- 1) Touch the automotive or aviation icon at the top of the 'Home' Screen.
- 2) Touch **Yes**.



Aviation



Automotive

### Or:

- 1) From the 'Home' Screen, touch **Tools** > **Automotive** or **Aviation** (from automotive mode).
- 2) Touch **Yes**.

## GPS RECEIVER STATUS

The receiver status displays one of the following conditions:

- Autolocate—Receiver is looking for any satellite whose almanac has been collected, which can take up to 5 minutes
- Searching the Sky—Receiver is looking for satellites
- Acquiring Satellites—Receiver is looking for and collecting data from satellites visible at its last known or initialized location, but has not acquired a fix
- 2D GPS Location—At least three satellites have been acquired and a two-dimensional location fix has been calculated. “2D Differential” appears when you are receiving DGPS corrections in 2D mode
- 3D GPS Location—At least four satellites have been acquired and a three-dimensional fix has been calculated. “3D Differential” appears when you are receiving DGPS corrections in 3D mode
- Lost Satellite Reception—the receiver is no longer tracking enough satellites for a 2D or 3D fix

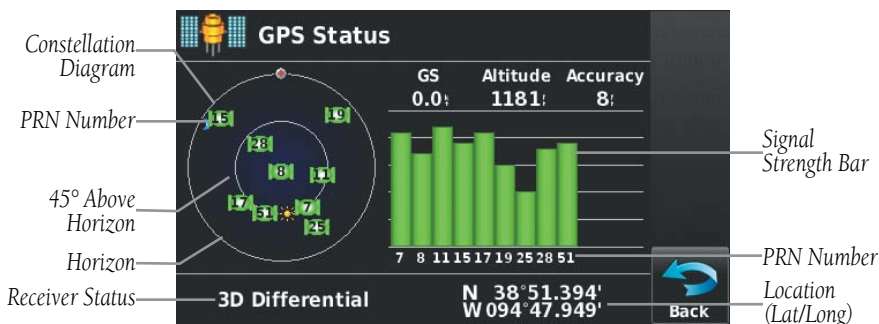

GPS Status

### Viewing the GPS status:

From the 'Home' Screen, touch **Tools > GPS Status**.

## ACQUIRING SATELLITES

The  bars on the 'Home' Screen indicate the GPS signal strength.

When the receiver is in the process of acquiring enough satellite signals for navigation, the receiver uses satellite orbital data (collected continuously from the satellites) and last known position to determine the satellites that should be in view. 'Acquiring Satellites' is indicated as the solution until a sufficient number of satellites have been acquired for computing a solution.

When the receiver is in the process of acquiring a 3D differential GPS solution, '3D GPS Location' is indicated as the solution until the 3D differential fix has finished acquisition.

## SATELLITE INFORMATION

Satellites currently in view are shown at their respective positions on a satellite constellation diagram. The outer circle of the constellation diagram represents the horizon, the inner circle represents 45° above the horizon, and the center point shows the position directly overhead. Each satellite is represented by a square containing the Pseudo-Random Noise (PRN) number (i.e., satellite identification number).

**GPS Status** can be helpful in troubleshooting weak (or missing) signal levels due to poor satellite coverage or installation problems. As the GPS receiver locks onto satellites, a signal strength bar is displayed for each satellite in view, with the appropriate satellite PRN number (01-32 or 33-64 for WAAS) below each bar. The progress of satellite acquisition is shown in three stages, as indicated by signal bar appearance:











- No bar—Receiver is looking for the indicated satellite
- Gray bar—Receiver has collected the necessary data and the satellite signal can be used
- Green bar—Satellite is being used for the GPS solution

# 1.3 OPERATION





## BASIC NAVIGATION CONTROLS

The controls on the touchscreen change dynamically depending on the function displayed.

Touch the following icons to perform the associated function:

|   |                   |   |
|---|-------------------|---|
|   | <b>Home</b>       | Returns to the ' <b>Home</b> ' screen.                                      |
|   | <b>Back</b>       | Displays the previous page; Returns ' <b>Home</b> ' (touch and hold).       |
|   | <b>OK</b>         | Commits a value edited or selected.   |
|   | <b>Menu</b>       | Displays the context sensitive option menu.                                 |
|   | <b>Menu/Enter</b> | Displays the menu; Displays the <b>Direct-to</b> function (touch and hold). |
|   | <b>Up</b>         | Scrolls up.   |
|   | <b>Down</b>       | Scrolls down.   |
|   | <b>Direct-to</b>  | Displays the <b>Direct-to</b> function.                                     |
|   | <b>Out</b>        | Zooms out.  |
|  | <b>In</b>         | Zooms in.   |

## KEYPAD CONTROLS

|  |                |  |
|--|----------------|--|
|  | <b>OK</b>      | Exits the keypad function and accepts the changes. |
|  | <b>BKSP</b>    | Erases the current data.                           |
|  | <b>Numeric</b> | Displays the numeric only keypad.                  |
|  | <b>Alpha</b>   | Displays the alpha and numeric keypads.            |
|  | <b>Cancel</b>  | Cancels a value that has been edited.              |













# 'HOME' SCREEN

Touch the  icon at any time to access the 'Home' Screen.

## 'HOME' SCREEN ICONS



Touch the following icons to perform the associated function:

-  **Map** Displays the Navigation Map.
-  **Terrain** Displays the Terrain Map.
-  **HSI/Panel** Displays the Panel Mode.
-  **Nearest** Displays the second-level Nearest Icons.
-  **Traffic** Displays Traffic Page.
-  **Active FPL** Displays the Active Flight Plan.
-  **WPT Info** Displays the Waypoint Information.
-  **Direct To** Displays the 'Direct To' function.
-  **Position** Displays the aircraft's Present Position.
-  **Weather** Displays second-level Weather Icons (aera 510 & 560) or All models with a GDL 39.
-  **XM Radio** Displays XM Radio (aera 510 & 560).
-  **Tools** Displays second-level Tools Icons.







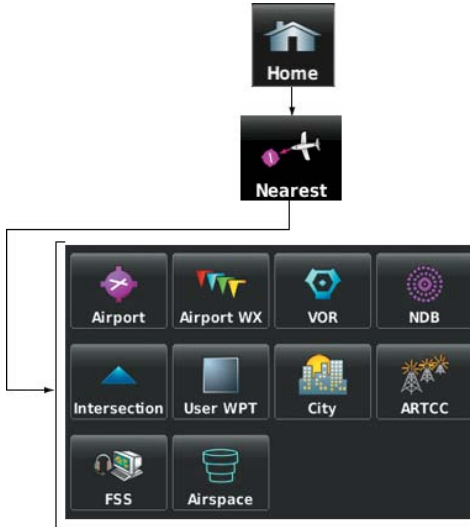





## NEAREST ICONS

From the 'Home' Screen, touch the **Nearest** Icon to access the second-level Nearest Icons.



Touch the following icons to perform the associated function:





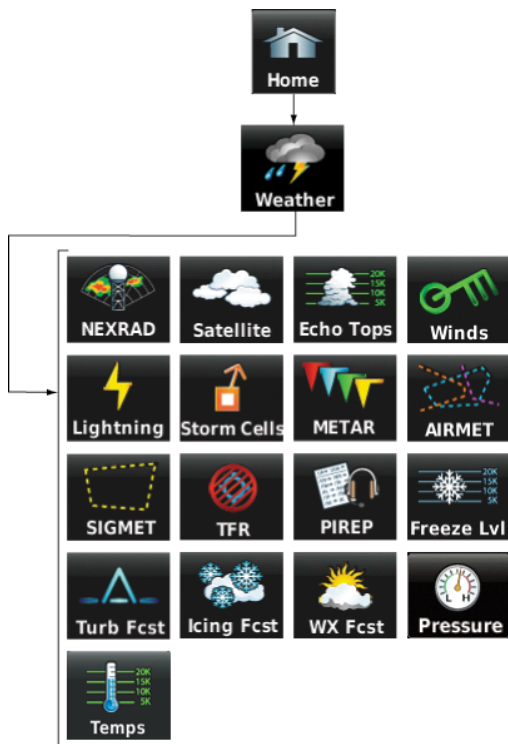

-  **Airport** Displays nearest airports.
-  **Airport WX** Displays nearest airport weather.
-  **VOR** Displays nearest VORs.
-  **NDB** Displays nearest NDBs.
-  **Intersection** Displays nearest intersections.
-  **VRP** Displays nearest Visual Reporting Point (VRP) (Atlantic).
-  **User WPT** Displays nearest user waypoints.
-  **City** Displays nearest cities.
-  **ARTCC** Displays nearest ARTCCs.
-  **FSS** Displays nearest Flight Service Stations (FSS).
-  **Airspace** Displays nearest airspace.

## WEATHER ICONS (aera 510 & 560 XM) (ALL MODELS WITH A GDL 39)

From the 'Home' Screen, touch the **Weather** Icon to access the second-level Weather Icons.



Touch the following second-level Weather Icons to display the weather product on the Weather Map:

-  **NEXRAD** Displays NEXRAD (NEXT-generation RADar) (XM or GDL 39).
-  **Satellite** Displays Satellite Mosaic cloud cover (XM only).
-  **Echo Tops** Displays Echo Tops (XM only).
-  **Winds** Displays Winds Aloft. (XM or GDL 39).
-  **Lightning** Displays Lightning (XM only).
-  **Storm Cells** Displays Storm Cells (XM only).
-  **METAR** Displays METARs. (XM or GDL 39).



- AIRMET**      Displays AIRMETs. (XM or GDL 39).
- SIGMET**      Displays SIGMETs. (XM or GDL 39).
- TFR**            Displays TFRs (XM or GDL 39).
- PIREP**         Displays PIREPs. (XM or GDL 39).
- Freeze Lvl**    Displays Freezing Levels (XM only)
- Turb Fcst**     Displays the Turbulence Forecast (XM only)
- Icing Fcst**     Displays the Icing Forecast (XM only)
- WX Frst**       Displays Forecast Information (current, 12, 24, 36, & 48).
- Pressure**     Displays Surface Pressure (XM only)
- Temps**         Displays Temperatures Aloft (GDL 39 only).

## TOOLS



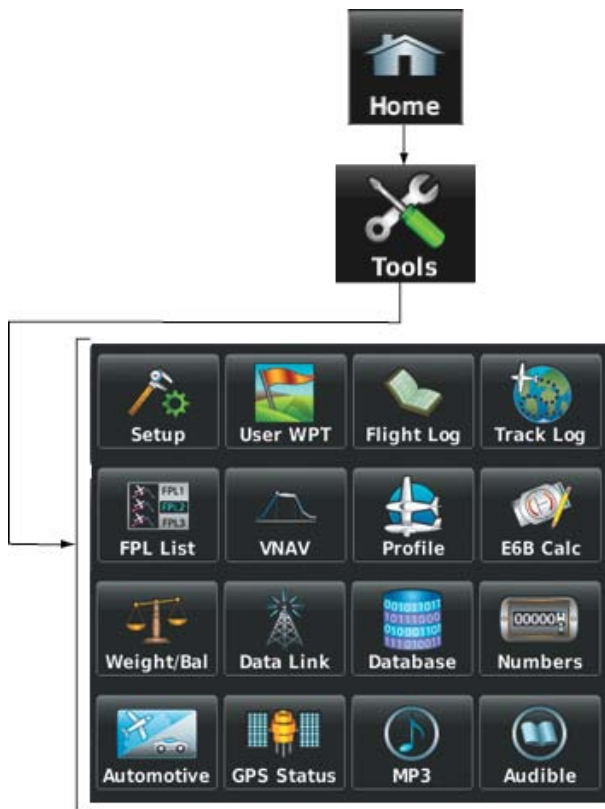







From the 'Home' Screen, touch the **Tools** Icon to access the second-level Tools Icons.



Touch the following second-level icons to perform the associated function:



- Setup** Displays third-level Setup Icons.
- User WPT** Displays User Waypoints and Proximity Waypoints.
- Flight Log** Displays Flight Logs.
- Track Log** Displays Track Logs.
- FPL List** Displays the Flight Plan List.
- VNAV** Displays Vertical Navigation.







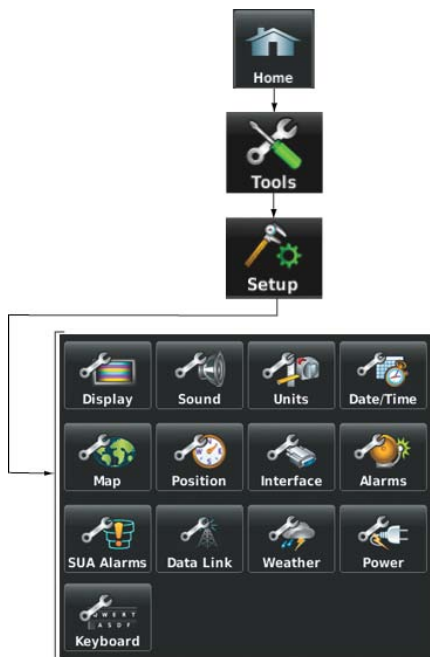

|  |                   |   |
|--|-------------------|---|
|  | <b>Profile</b>    | Displays Aircraft Profiles.                         |
|  | <b>E6B Calc</b>   | Displays the E6B Calculator.                        |
|  | <b>Weight/Bal</b> | Displays the Weight & Balance.                      |
|  | <b>Data Link</b>  | Displays Data Link Information.                     |
|  | <b>Database</b>   | Displays database and software version information. |
|  | <b>Numbers</b>    | Displays flight data.                               |
|  | <b>Automotive</b> | Activates automotive mode.                          |
|  | <b>GPS Status</b> | Displays GPS status information.                    |
|  | <b>MP3</b>        | Displays Music Player.                              |
|  | <b>Audible</b>    | Displays Audible Books.                             |



## SETUP ICONS

From the 'Home' Screen, touch the **Tools** > **Setup** to access the third-level Setup icons.



Touch the following third-level icons to perform the associated function:

-  **Display** Displays backlight intensity/timeout and color mode settings.
-  **Sound** Displays sound settings.
-  **Units** Displays unit settings.
-  **Date/Time** Displays date & time settings.
-  **Map** Displays Navigation Map settings.
-  **Position** Displays position settings.
-  **Interface** Displays interface settings.
-  **Alarms** Displays alarm settings.
-  **SUA Alarms** Displays Special Use Airspace alarm settings.

|  |                  |   |
|--|------------------|---|
|  | <b>Data Link</b> | Displays Data Link setup information.                         |
|  | <b>Weather</b>   | Displays Weather setup information (510 and 560 Models only). |
|  | <b>Power</b>     | Displays power settings                                       |

## SELECTING A FUNCTION

### Selecting a function:

Touch the desired icon. The icon will momentarily turn blue when selected.

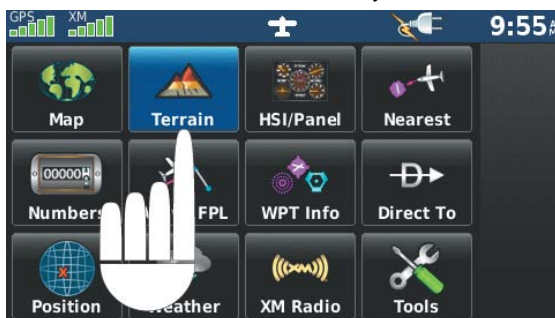

Terrain Icon Selected ('Home' Screen)

## SCROLLING

### Scrolling up/down on the touchscreen:

Touch the **Up** or **Down** Arrow Icons (if available).

**Or:**

If the arrow icons are present, touch and drag your finger up or down.



Scrolling (Weather Icons)

## 1.4 ACCESSING SYSTEM FUNCTIONALITY

### OPTION MENUS

The aera has a dedicated **Menu** Icon that displays a context-sensitive list of options for the function displayed.

The Option Menu allows the user to access additional features or make setting changes which specifically relate to the currently displayed function.

#### Navigating the option menu:

- 1 If available, touch the **Menu** or **Menu/▶** Icon
- 2 Touch the **Up/Down** Icons if necessary to scroll through the Option Menu.
- 3 Touch the desired menu option.



### DATA ENTRY

Alphanumeric data can be entered using the keypad. In some instances, such as when entering an identifier, the aera tries to predict the desired identifier based on the characters being entered. In this case, if the desired identifier appears, use the **OK** Icon to confirm the entry without entering the rest of the identifier manually. This can save the pilot from having to enter all the characters of the identifier.

Predetermined data options are entered by touching the **◀▶** to cycle through a horizontal list, or by touching the button to display a vertical list (if only two options are available, touching the button will toggle the two data options).

Besides character-by-character data entry using the keypad and predetermined data entry, the aera also provides a shortcut for entering 'Flight Plan', 'Nearest', and 'Recent' waypoint identifiers.



### Entering alphanumeric data:

- 1 When alphanumeric data can be entered, a keypad will appear after touching the desired button.
- 2 Touch the keypad to enter the desired data.
- 3 Touch **OK**.



Numeric data may also be entered using or '+/-' buttons (if applicable).



### Entering predetermined data options:

- 1 Touch the Data Option Button to display a vertical list of data options (if applicable), or to toggle two data options (i.e., On/Off).

**Or:**

Touch the buttons to cycle through a horizontal list (if more than two data options are available).

- 2 If using the vertical list, touch the desired data option from the list.

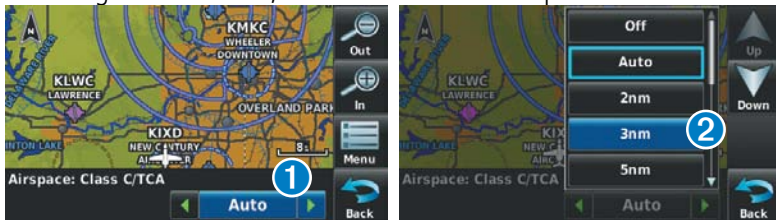

Data Option Button

## WAYPOINT INFORMATION TABS

Waypoint information is broken down into 5 tabs (**Info**, **Freq**, **Runway**, **WX** (aera 510 & 560 only), and **AOPA** (aera 550 & 560 Americas only)).

### Waypoint Information Tabs:

- 1 From the 'Home' Screen, touch the **WPT Info** Icon.
- 2 Touch the desired Tab (**Info**, **Freq**, **Runway**, **WX/NOTAM** (optional), **AOPA** (optional)).

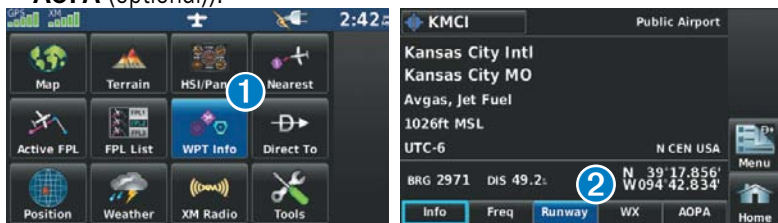

## 1.5 USING MAP DISPLAYS



**NOTE:** Refer to the GPS Navigation section for more information on Map Display Setup.

Map displays are used extensively in the aera to provide situational awareness in flight. Most aera maps can display the following information:

- Airports, NAVAIDs, airspaces, airways, land data (highways, cities, lakes, rivers, borders, etc.) with names
- Map Pointer information (distance and bearing to pointer, location of pointer, name, and other pertinent information)
- Map range
- Aircraft icon (representing present position)
- Flight plan legs
- User waypoints
- Track vector
- Topography data

## MAP RANGE

There are 23 different map ranges available, from 200 feet to 800 nm. The current map range is indicated in the lower right. The scale bar represents the map scale. To change the map range on any map, use the **Out** or **In** Icons to zoom 'out' (increasing), or zoom 'in' (decreasing).

### Adjusting the map range:

While viewing a Map Display, touch the **In** or **Out** Icons.

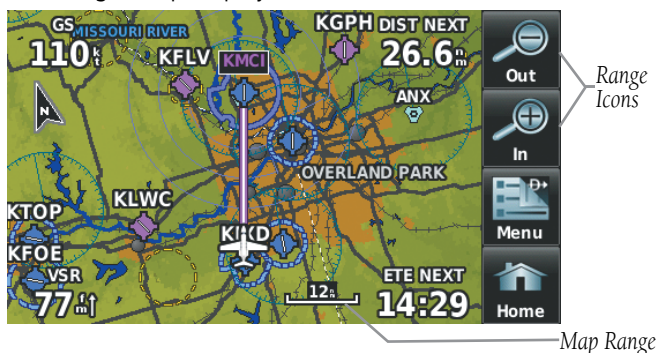

Navigation Map

When the selected range exceeds the resolution of the map data, 'overzoom' appears below the map range scale.





Scale Bar Representing a Map Scale of 3 nm Per Scale Width.

Map Range/Overzoom

## AUTO ZOOM

Auto Zoom allows the aera to change the map display range to the smallest range clearly showing the active waypoint. Auto Zoom can be overridden by adjusting the range and remains that way until the active waypoint changes, a terrain or traffic alert occurs, or the aircraft takes off.

### Enabling/disabling auto zoom:

- 1) From the 'Home' Screen, touch **Map** > **Menu** > **Set Up Map**.
- 2) Touch the   buttons to select the 'General' Category.

- 3) Touch '**Autozoom**'.
- 4) Touch the '**On/Off**' Data Option Button.

## MAP PANNING

Map panning allows the pilot to:

- View parts of the map outside the displayed range without adjusting the map range
- Highlight and select locations on the map
- Review information for a selected airport, NAVAID or user waypoint
- Designate locations for use in flight planning
- View airspace and airway information

When the panning function is selected by touching anywhere on the Map, the Map Pointer is displayed. An Information Window also appears at the bottom of the map display showing the bearing, distance and time to the pointer from the aircraft's present position, the elevation of the land at the position of the pointer, or the object's (airports, obstacles, etc) elevation, if known.

When the Map Pointer is over a map feature, the map feature is highlighted, an information box appears on the map, and the highlighted map feature is displayed on the Map Feature Button at the bottom of the screen (even if the name was not originally displayed on the map).

Touching the **Map Feature** Button displays additional information for the highlighted map feature. If multiple features are present at the Map Pointer position, green arrows will appear on the Map Feature Button. Touching the  will cycle through the list of map features present at that position.

### Activating the map pointer:

While viewing a Map Display, touch anywhere on the map to activate the map pointer. Touch the **Cancel** Icon to remove the map pointer.

### Panning the map:

While viewing a Map Display, touch anywhere on the map and drag. Touch the **Cancel** icon to remove the map pointer.

Map Pointer

Information Box

Map Feature Button

Green Arrow Indicating Multiple Features are Present at the Map Pointer Location.

Map Panning (Navigation Map)

Out

In

Menu

Cancel

KMCI

014<sup>h</sup>  
1026<sup>h</sup> MSL

16.3<sup>h</sup>  
00:08:54

- Bearing, Distance, and Time En Route to the Pointer from the Aircraft's Present Position.

- Elevation at the Pointer location.

1

2

3

4

Out

In

Menu

Cancel

KMCI

014<sup>h</sup>  
1026<sup>h</sup> MSL

16.3<sup>h</sup>  
00:08:54

Public Airport

Kansas City Intl  
Kansas City MO

Avgas, Jet Fuel

1026ft MSL

UTC-6

N CEN USA

BRG 013<sup>h</sup> DIS 23.6<sup>h</sup> N 39° 17.8' W 094° 42.8'

Info Freq Runway WX AOPA Back

## Reviewing information for a map feature:

- 1 While viewing a Map Display, touch anywhere on the map to activate the map pointer. When the Map Pointer is over a map feature, the map feature is highlighted, an information box appears on the map, and the highlighted map feature is displayed on the Map Feature Button at the bottom of the screen. If multiple features are present at the Map Pointer position, green arrows will appear on the Map Feature Button.
- 2 If necessary, touch the buttons to cycle through the list of map features present at that position.

- 3 Touch the Map Feature Button to review information for the Map Feature.
- 4 Touch the **Back** Icon to return to the map or touch and hold the **Menu/**► Icon to navigate to the map feature. Touch the **Cancel** Icon to remove the map pointer.

## MAP OVERLAYS

The 1 Weather, 2 Topography, 3 Terrain, and 4 Satellite Imagery map overlays can be displayed or removed.



### Displaying/removing map overlays:

- 1) From the 'Home' Screen, touch **Map** > **Menu** > **Show/Hide**.
- 2) Touch the '**Show/Hide**' Data Option Button for the desired overlay.

Satellite View only displays satellite imagery at and above the 20nm range. Below the 20nm range, 'no sat view' is displayed below the map range.

## MAP SYMBOLS

Refer to Appendix H for a list of map symbols.

### DECLUTTER

The map can be adjusted to declutter (remove unwanted items, such as highways) on the map.

#### Adjusting the declutter level of the navigation map:

- 1) From the 'Home' Screen, touch **Map > Menu > Declutter**.
- 2) Touch the desired level (**-1, -2, -3**) on the right side of the screen. The currently selected level is highlighted blue.
- 3) Touch the **Back** Icon to remove the detail options.

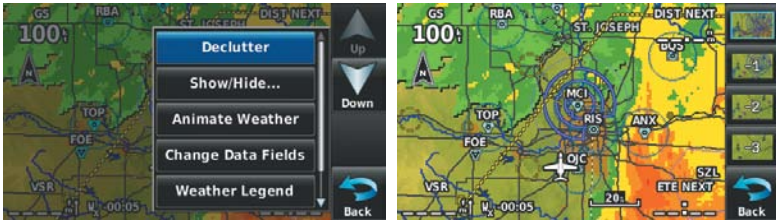

Declutter

### MAP DETAIL

The map detail can also be adjusted. Map detail changes the amount of detail with respect to the zoom scale.

#### Adjusting the map detail:

- 1) From the 'Home' Screen, touch **Map > Menu > Set Up Map**.
- 2) Touch the **◀▶** buttons to select the '**General**' Category.
- 3) Touch **Detail Level**.
- 4) Touch the Data Option Button, and touch the desired option from the list (**Least, Less, Normal, More, or Most**).

## 1.6 SYSTEM SETTINGS

The third-level **Setup** Icons allow management of the following system parameters:

- Display
- Sound
- Units
- Date & Time
- Map
- Position
- Interface
- Alarms
- SUA Alarms
- Power

### Restoring system setting defaults:

- 1) From the 'Home' Screen, touch **Tools** > **Setup**.
- 2) Touch the desired Setup Icon (**Display, Sound, Units, Date & Time, Map, Position, Interface, Alarms, SUA Alarms, or Power**).
- 3) Touch **Menu** > **Restore Default**.

**Or:**

From the 'Home' Screen, touch **Tools** > **Setup** > **Menu** > **Restore All Settings**.

## DISPLAY

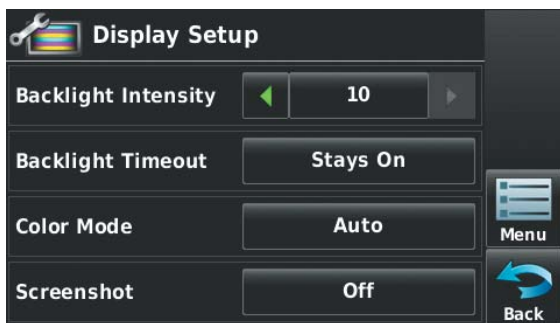

Display Setup



## BACKLIGHT INTENSITY

### Adjusting backlight intensity:

- 1) From the 'Home' Screen, touch **Tools > Setup > Display**.
- 2) Touch the  buttons to adjust the backlight intensity.

### Or:

Press the  **POWER** Button and enter the desired backlight intensity.

## BACKLIGHT TIMEOUT

After a specified period of inactivity the backlight will turn off to save battery power.

### Adjusting backlight timeout:

- 1) From the 'Home' Screen, touch **Tools > Setup > Display**.
- 2) Touch the '**Backlight Timeout**' Data Option Button, and touch the desired option from the list (**Stays On, 15 Seconds, 30 Seconds, 1 Minute, or 2 Minutes**).

## TOUCHSCREEN

### Calibrating the touchscreen:

- 1) From the 'Home' Screen, touch **Tools > Setup > Display > Menu > Calibrate**.
- 2) Follow the onscreen instructions, and touch **OK**. The unit will restart.

## SOUND

Sound is broken down into 'Master', 'Alerts', and 'Media'. 'Master' controls ALL sound. 'Alerts' and 'Media' are a percentage of the 'Master' sound. 'Alerts' refers to navigation phrases (e.g. "Pull Up"), and 'Media' refers to the XM radio volume. The Terrain Alerts, TIS Alerts, and Key Tones can also be toggled On/Off.

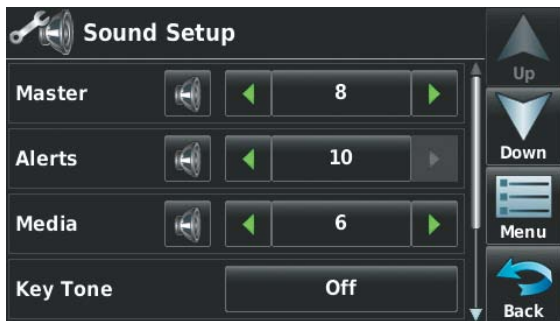

Sound Setup

### Adjusting the sound:

- 1) From the **'Home'** Screen, touch **Tools > Setup > Sound**.
- 2) Touch the buttons to adjust the sound.

**Or:**

Touch the icon to mute the **Master**, **Alerts**, or **Media** audio. A blue 'X' will appear over the icon.

**Or:**

Touch the **'On/Off'** Data Option Button to toggle Terrain Audio, TIS Audio, or Key Tones on or off.

**Or:**

- 1) Press the **POWER** Button to quickly access the **Master** volume/mute.
- 2) Touch **Menu > Sound Setup** to access ALL volume settings.

### Muting sound:

See the 'Adjusting the Sound' procedure above.

## ADDITIONAL SETTINGS

### Changing settings (Units, Date & Time, Position, Interface, Alarms, SUA Alarms, and Power):

- 1) From the **'Home'** Screen, touch **Tools > Setup**.
- 2) Touch the desired Settings Icon (**Units, Date/Time, Position, Interface, Alarms, SUA Alarms, or Power**).

- 3) Touch the desired setting to change. If only two options are available, touching the field will toggle the two settings. If more than two options are available, a vertical list is displayed with a blue outline around the current setting. Touch the '+' or '-' buttons to increase/decrease the numerical values (if necessary).
- 4) Touch and hold the **Back** Icon to return to the '**Home**' Screen.

| Icon              | Available Settings  |
|-------------------|---|
| <b>Display</b>    | Backlight Intensity, Backlight Timeout, Color Mode, Screenshot, Calibration (from Option Menu)    |
| <b>Sound</b>      | Master (0-10), Alerts (0-10), Media (0-10), Key Tone, Terrain Audio, TIS-A Audio                  |
| <b>Units</b>      | Distance, Speed, Direction Display, Temperature, Altitude, Vertical Speed, Pressure, Fluid Volume |
| <b>Date/Time</b>  | Time Format, Auto UTC Offset  |
| <b>Position</b>   | Location Format, Map Datum, Heading, Magnetic Variation   |
| <b>Interface</b>  | Serial Data Format  |
| <b>Alarms</b>     | Arrival, Next WPT, Proximity, Fuel Tank Reminder  |
| <b>SUA Alarms</b> | Class B/TMA, Class C/TCA, Class D, Restricted, MOA, Other/ADIZ, Parachute Area                    |
| <b>Power</b>      | Power Loss Warning  |

## 1.7 NEAREST AIRPORT CRITERIA SETTINGS

The Nearest Airports Option Menu allows the pilot to filter out airports that do not meet a defined criteria. Specific surface types and runway lengths can be defined, as well as the option to include private airports and/or heliports.

Runway Surface—allows you to set criteria for the type of surface on the runway:

- **Hard Only**—shows only runways with a concrete, asphalt, or similar sealed surface.
- **Hard or Soft**—shows all runways except water landing facilities.
- **Water Only**—shows only water landing facilities.
- **Any**—shows any runway, regardless of surface type, including water landing facilities.

Minimum Runway Length—allows the pilot to enter a specific length for the shortest runway allowed.

### Entering airport criteria:

- 1) From the **'Home'** Screen, touch **Nearest > Airport > Menu > Set Airport Criteria**.
- 2) Touch the desired setting to change (**'Runway Surface'**, **'Include Private Apts'**, **'Include Heliports'**) or touch the **'+'** or **'-'** buttons to increase/decrease the **Minimum Runway Length**.

**Or:**

To restore defaults, touch **Menu > Restore Default**.

### Restoring airport criteria defaults:

See the 'Entering Airport Criteria' procedure above.

## 1.8 PRESENT POSITION

### POSITION

The Present Position function displays latitude, longitude, GPS altitude, reference waypoint, type, distance, direction, and bearing. The reference waypoint is designed to display the current position in relation to a prominent landmark. The pilot can change the reference waypoint 'Nearest Type' using the 'Change Nearest Type' menu option. By default the Nearest Type is set to 'Automatic', which will display the nearest large airport, enroute VOR, or city (in that order).



Present Position

#### Changing the Nearest Type:

- 1) From the 'Home' Screen, touch **Position** > **Menu** > **Change Nearest Type**.
- 2) Touch the desired nearest type ('Automatic', 'Airport', 'VOR', 'NDB', 'Intersection', 'City', or 'Waypoint').

#### Viewing the present position:

From the 'Home' Screen, touch **Position**.

### NEW LOCATION

The 'New Location' menu option is used when the GPS Receiver is having trouble finding the satellites it expects to be there.

**Entering a new location:**

- 1) From the 'Home' Screen, touch **Position** > **Menu** > **New Location**.
- 2) Touch '**Use Map**', or '**Use Identifier**'.
- 3) After selecting your approximate position using the map pointer or entering an identifier, touch **OK**.
- 4) The GPS Receiver will begin a new search based on the location entered.

**SIMULATOR MODE**

Simulator Mode is helpful for practicing with the unit indoors or when no satellite or XM signals are available. All waypoints and routes created in Simulator Mode are retained in memory for future use.



**NOTE:** Do not attempt to navigate using Simulator Mode. When the unit is set to Simulator Mode, the GPS receiver is turned off. Any Satellite Signal Strength Bars shown are only simulations and do not represent the strength of actual satellite signals.

**Starting/Stopping Simulator Mode:**

From the 'Home' Screen, touch **Position** > **Menu** > **Start/Stop Simulator**.

**Adjusting the simulated altitude, track, speed, waypoint, & position:**

- 1) From the 'Home' Screen, touch **Position** > **Menu** > **Start Simulator**.
- 2) Touch the 'GPS simulator is on (for use indoors)' message to remove it.
- 3) Touch **Menu** > **Drive Simulator**.
- 4) Enter the desired data by touching the fields or using the +/- buttons. Refer to Section 1.4 'Data Entry' for more information.



Simulator Mode

# SECTION 2 GPS NAVIGATION

## 2.1 INTRODUCTION

The Navigation Map displays aviation data (e.g., airports, VORs, airways, airspaces), geographic data (e.g., cities, lakes, highways, borders), and topographic data (map shading indicating elevation). The Navigation Map can be oriented three different ways: North Up (NORTH UP), Track Up (TRK UP) or Desired Track Up (DTK UP).

An aircraft icon is placed on the Navigation Map at the location corresponding to the calculated present position. The aircraft position and the flight plan legs are accurately based on GPS calculations. The basemap upon which these are placed are from a source with less resolution, therefore the relative position of the aircraft to map features is not exact. The leg of the active flight plan currently being flown is shown as a magenta line on the navigation map. The other legs are shown in white.

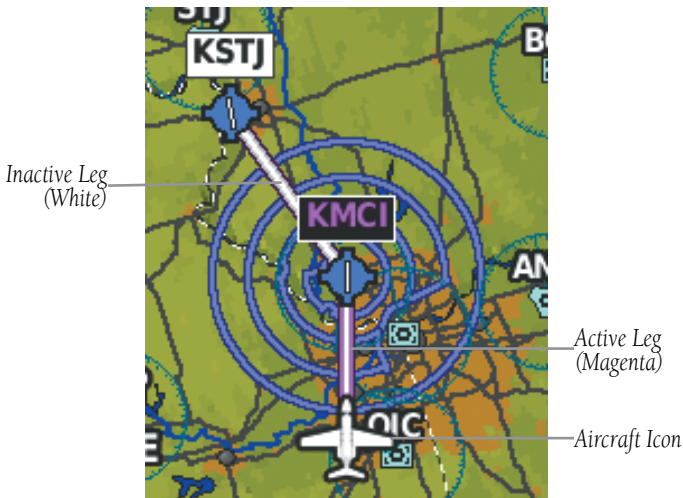

**Flight Plan Legs (Navigation Map)**

## DATA FIELDS

The data fields on the Navigation Map can be independently configured by the user.

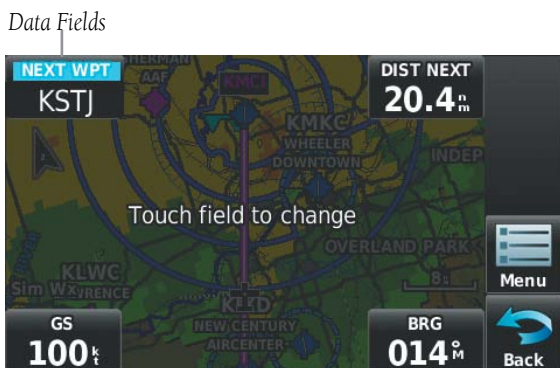

Data Fields (Navigation Map)

By default, the Data Bar Fields are set to display Ground Speed (GS), Distance - Next (DIST NEXT), Vertical Speed Required (VSR), and Time En Route - Next (ETE NEXT). These four data fields can be changed to display any of the Data Field Options.



### Changing the information shown in the data fields:

- 1 From the 'Home' Screen, touch the **Map** Icon.
- 2 Touch the **Menu** Icon.
- 3 Touch the '**Change Data Fields**' menu option.
- 4 Touch the desired Data Field to change. A list of available Data Field Options is displayed.
- 5 Touch the desired Data Field Option.
- 6 Touch the **OK** Icon.



## DATA FIELD OPTIONS

- Accuracy
- Altitude
- Bearing (BRG)
- Course to Steer (CTS)
- Crosstrack Error (XTK)
- Desired Track (DTK)
- Distance (Destination) (DIST DEST)
- Distance (Next) (DIST NEXT)
- En Route Safe Altitude (ESA)
- External Voltage (EXT VOLTS)
- Flight Timer (FLT TIMER)
- Fuel Timer
- Glide Ratio (G/R)
- Ground Speed (GS)
- Ground Track (TRK)
- Minimum Safe Altitude (MSA)
- Next Waypoint (NEXT WPT)
- Sunrise
- Sunset
- Time En Route (Destination) (ETE DEST)
- Time En Route (Next) (ETE NEXT)
- Time of Arrival (Destination) (ETA DEST)
- Time of Arrival (NEXT) (ETA NEXT)
- Time to VNAV (VNAV TIME)
- Time (Local)
- Time (UTC)
- Vertical Speed (VS)
- Vertical Speed Required (VSR)
- Wx (Altimeter) (WX ALTIM)
- Wx (Dew Point) (WX DEW PT)
- Wx (Rel. Humidity) (WX HUMIDITY)
- Wx (Temperature) (WX TEMP)
- Wx (Wind) (WX WIND)

## NUMERIC FLIGHT DATA

The numeric flight data can be independently configured by the user.

### Accessing numeric flight data:

From the 'Home' Screen, touch **Numbers**.

### Changing numeric flight data fields:

- 1) From the 'Home' Screen, touch **Numbers**.
- 2) Touch the desired data field to change. The available data fields are displayed.
- 3) Touch the desired data field.
- 4) Touch **OK**.

### Restoring default numeric flight data:

From the 'Home' Screen, touch **Numbers** > **Menu** > **Restore Default**.



Numeric Flight Data

## COMPASS ARC

A compass arc appears by default on the Navigation Map. The magenta bug indicator (similar to the bug indicator on the HSI) can be set to 'Bearing' (default), 'Course to Steer', a specific heading reference ('User Selected'), or 'Off'.

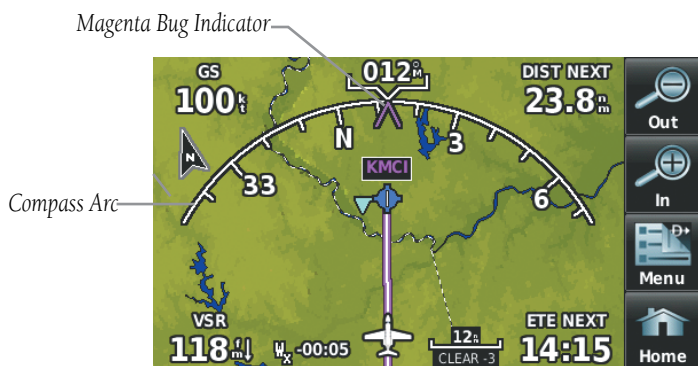

Compass Arc (Navigation Map)

### Displaying/Removing the Compass Arc from the Navigation Map:

- 1) From the 'Home' Screen, touch **Map** > **Menu** > **Set Up Map**
- 2) Touch the buttons to select the 'General' Category (if necessary).
- 3) Touch **Compass Arc**.
- 4) Touch the **On/Off** Button.

### Setting the Compass Arc Bug Indicator:

- 1) From the 'Home' Screen, touch **Map** > **Menu** > **Set Bug Indicator** (only available when the compass arc is displayed).
- 2) Touch the desired menu option ('User Selected', 'Bearing', 'Course to Steer', or 'Off').

## 2.2 HSI/PANEL

The HSI/Panel shows GPS-derived data in a graphical format. Keep in mind the differences between the GPS-derived panel and mechanical instruments, as mechanical panel instruments use sensors that provide information different from that derived using GPS.

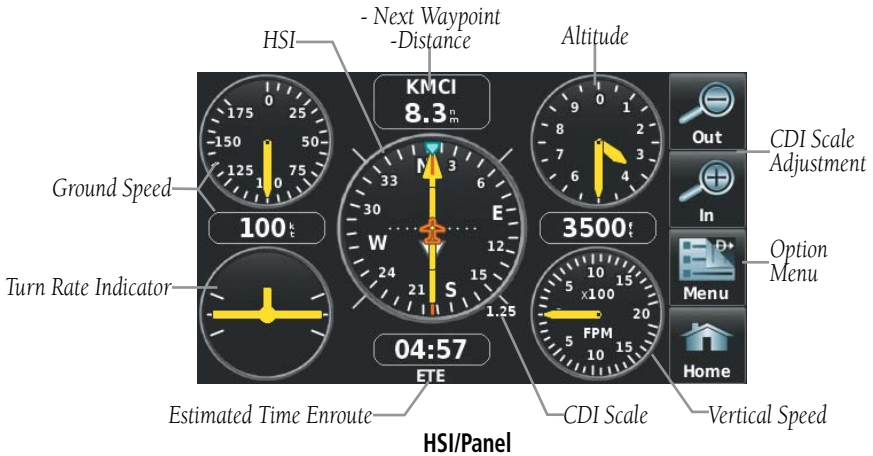

The Panel shows a graphic Horizontal Situation Indicator (HSI) surrounded by additional indicators.

The graphic HSI depicts the course to the destination or the next waypoint in a flight plan, current ground track, off course error, and a To/From indication. The rotating compass indicates your current ground track.

The course pointer and course deviation needle indicate the course and whether you are on the course. The Bug Indicator can be set to 'Bearing' (default), 'Course to Steer', a specific heading reference ('User Selected'), or 'Off'.

Bearing is the compass direction from the present position to a destination waypoint. Course to Steer is the recommended direction to steer in order to reduce cross-track error and return to the course line.

The Course Deviation Indicator, or needle, indicates how far off course, left or right, based on its placement along the course deviation scale.

The course deviation scale setting is adjustable for Auto,  $\pm 0.25$ , 1.25 or 5.0 (nautical mile, statute mile, or kilometer) full-scale deflection. The course deviation scale appears on the lower right corner of the HSI. The default setting is Auto, which uses three factors to determine the distance from the center of the CDI to full left or right limits:

- CDI scale = 1.25 - within 30 nm of any airport in the active route.
- CDI scale = 0.25 - on an approach leg or within 2 nm of the FAF or MAP.
- CDI scale = 5.0 - if the previous two conditions do not exist.

### Displaying the HSI/Panel:

From the 'Home' Screen, touch the **HSI/Panel** Icon.

## CHANGING THE CDI SCALE

The CDI scale can be set by touching the **In** or **Out** Icons from the **HSI/Panel** Screen (if the CDI scale is NOT set to 'Automatic') or from the HSI/Panel option menu.

### Changing the CDI scale:

- 1) From the 'Home' Screen, touch **HSI/Panel** > **Menu** > **Set CDI Scale**.
- 2) Touch the desired CDI Scale ('Automatic', '0.25 nm', '1.25 nm', or '5.00 nm').

## SETTING THE BUG INDICATOR

The Bug Indicator can be set from the HSI/Panel option menu.

### Setting the Bug Indicator:

- 1) From the 'Home' Screen, touch **HSI/Panel** > **Menu** > **Set Bug Indicator**.
- 2) Touch the desired menu option ('User Selected', 'Bearing', 'Course to Steer', or 'Off').

## MANUALLY SETTING A COURSE

Use the 'Set OBS and Hold' menu option to manually set your course to the destination.

### Manually setting a course to the destination waypoint:

- 1) From the 'Home' Screen, touch the **HSI/Panel** or the **Active FPL** Icon.
- 2) Touch the **Menu** Icon
- 3) Touch the '**Set OBS and Hold**' menu option (only available when navigating a Direct To or Flight Plan).
- 4) Touch the '+' or '-' Buttons to increase/decrease the value

**Or:**

Touch the Radial Button to enter the desired radial using the keypad and touch the **OK** Icon.



HSI/Panel Option Menu



Set OBS

Radial Button

### Returning to automatic sequencing of route waypoints:

- 1) From the 'Home' Screen, touch the **HSI/Panel** or the **Active FPL** Icon.
- 2) Touch the **Menu** Icon
- 3) Touch the '**Release Hold**' menu option (only available when navigating a Direct To or Flight Plan).

## 2.3 VERTICAL NAVIGATION (VNAV)

Overview

The VNAV function provides settings for the vertical navigation. These settings create a three-dimensional profile from the present location and altitude to a final (target) altitude at a specified location.

GPS Navigation

When the VNAV profile is defined, the pilot is informed of the progress by message alerts. The teal bar on the HSI (when displayed) shows the VNAV profile.

The Vertical Navigation feature is only available when navigating a Direct To or flight plan, and the ground speed is greater than 35 knots.

Flight Planning

The “Approaching VNAV Profile” message appears one minute prior to the initial descent point. The descent angle locks to prevent changes in speed from altering the profile. The VNAV feature does not take into account any changes in groundspeed that occur during the transition from level flight to descent or climb.

Hazard Avoidance

Approaching VNAV profile

Additional Features

At 500 ft above the target altitude, the “Approaching Target Altitude” message appears, the ‘Estimated Time To VNAV’ goes blank, and the VNAV indicator disappears from the HSI.

Appendices



**CAUTION:** The aera is a VFR navigation tool and should not be used to perform instrument approaches.



**CAUTION:** VNAV is only a VFR navigation aid and is not intended for instrument approaches.

Index

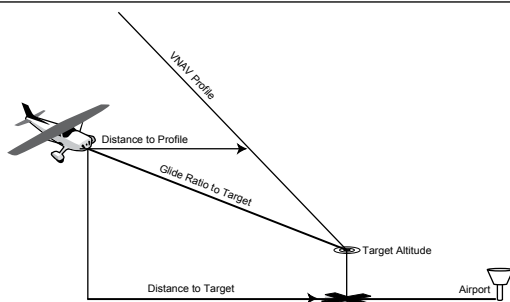

Visual Representation of VNAV



## USING THE VNAV FEATURE

Use the VNAV (Vertical Navigation) feature to ensure the aircraft is at the proper altitude. The VNAV Indicator appears on the HSI (when displayed) as a horizontal teal bar. A message appears when approaching the VNAV Profile. When the bar is in the vertical center of the HSI, the aircraft is at the proper altitude for the VNAV Profile.

### Enabling/disabling the VNAV indicator:

- 1) From the **'Home'** Screen, touch the **HSI/Panel** Icon.
- 2) Touch the **Menu** Icon
- 3) Touch the **'Enable VNAV Indicator'** or **'Disable VNAV Indicator'** menu option (only available when navigating a Direct To or Flight Plan).

### Capturing/cancelling VNAV profile:

- 1) Enter a valid VNAV profile (see 'Configuring a VNAV Profile' below) and begin navigation.
- 2) From the **'Home'** Screen, touch the **HSI/Panel** Icon.
- 3) Touch the **'Capture VNAV Profile'** or **'Cancel Capture'** menu option (only available when navigating a Direct To or Flight Plan).

VNAV Indicator



VNAV Indicator (Panel)

### Configuring a VNAV profile:

- 1) From the 'Home' Screen, touch **Tools** > **VNAV**
- 2) Touch the desired fields ('**Profile**', '**Altitude**', etc) to enter the VNAV profile.
- 3) Touch and hold the **Back** Icon to return to the 'Home' Screen.



Vertical Navigation

- **Waypoint**—Enter any waypoint along the currently active route as the reference waypoint. The reference waypoint defines the target location.
- **Profile**—Enter the descent rate.
- **Altitude**—Enter the desired reference waypoint altitude. Select 'Above Waypoint' to use field elevation for airports in the Jeppesen database or 'MSL' to specify an exact MSL altitude target.
- **By**—Enter the target location with settings of distance 'Before' or 'After' a reference waypoint. To set a target location at a reference waypoint, enter a distance of zero.
- **VNAV Messages**—Select 'On' or 'Off' to enable/disable VNAV alert messages.

## 2.4 MAP DISPLAY SETUP

Map displays are used extensively in the aera to provide situational awareness in flight. Most aera maps can display the following information:

- Airports, NAVAIDs, airspaces, airways, land data (highways, cities, lakes, rivers, borders, etc.) with names
- Map Pointer information (distance and bearing to pointer, location of pointer, name, and other pertinent information)
- Map range
- Aircraft icon (representing present position)
- Flight plan legs
- User waypoints
- Track vector
- Topography data

### MAP ORIENTATION

Maps are shown in one of three different orientation options, allowing flexibility in determining aircraft position relative to other items on the map (North Up) or for determining where map items are relative to where the aircraft is going (Track Up), or desired track up (DTK UP)).

- North Up aligns the top of the map display to north (default setting).
- Track Up aligns the top of the map display to the current ground track.
- Desired Track (DTK) Up aligns the top of the map display to the desired course.



**NOTE:** Map orientation can only be changed from the Navigation Map Option Menu. All other maps (except weather maps) that show navigation data reflect the orientation selected for the Navigation Map.

### Changing the Navigation Map orientation:

- 1) From the 'Home' Screen, touch **Map > Menu > Set Up Map**
- 2) Touch the ◀▶ buttons to select the 'General' Category (if necessary).
- 3) Touch **Orientation**.
- 4) Touch the ◀▶ buttons to select 'North Up', 'Track Up', or 'DTK Up'.

## AIRPORTS, NAVAIDS, CITIES & ROADS

### Setting up and customizing airports, NAVAIDs, cities & roads for the navigation map:

- 1) From the 'Home' Screen, touch **Map > Menu > Set Up Map**
- 2) Touch the ◀▶ buttons to select the 'Airport', 'Navaid', 'City', or 'Road' Category.
- 3) Touch the ◀▶ buttons to select the desired settings, or touch the Data Option Button to toggle the option **On/Off**.

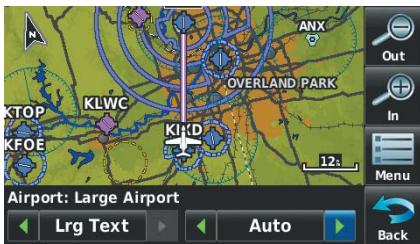
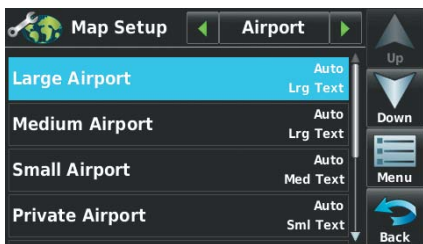

Map Setup (Airport Category Example)

—Data Option Button

## AIRWAYS



Low Altitude Airways (or Victor Airways) primarily serve smaller piston-engine, propeller-driven airplanes on shorter routes and at lower altitudes. Airways are eight nautical miles wide and start 1,200 feet above ground level (AGL) and extend up to but not including 18,000 feet mean sea level (MSL). Low Altitude Airways are designated with a "V" before the airway number (hence the name "Victor Airways") since they run primarily between VORs.

High Altitude Airways (or Jet Routes) primarily serve airliners, jets, turboprops, and turbocharged piston aircraft operating above 18,000 feet MSL. Jet Routes start at 18,000 feet MSL and extend upward to 45,000 feet MSL (altitudes above 18,000 feet are called "flight levels" and are described as FL450 for 45,000 feet MSL). Jet Routes are designated with a "J" before the route number.

Low Altitude Airways are drawn in gray. High Altitude Airways are drawn in green. When both types of airways are displayed, high altitude airways are drawn on top of Low Altitude Airways.

When airways are selected for display on the map, the airway waypoints (VORs, NDBs and Intersections) are also displayed.

### Displaying/removing airways:

- 1) From the 'Home' Screen, touch **Map > Menu > Set Up Map**
- 2) Touch the  buttons to select the 'Navaid' Category.
- 3) Touch **Airways**.
- 4) Touch the  buttons to select the desired setting ('Off', 'Low', 'High', or 'Both').

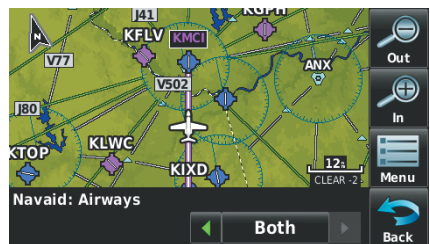
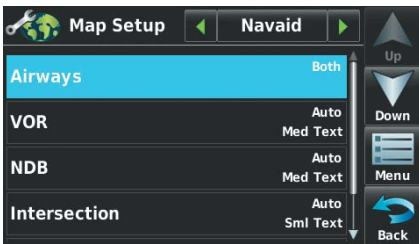

Airways

## 2.5 WAYPOINTS

Overview

The WPT INFO (Waypoint Information) function provides airport and waypoint information.

Waypoints are predetermined geographical positions (internal database) or pilot-entered positions, and are used for all phases of flight planning and navigation.

Waypoints can be selected by entering the ICAO identifier, entering the name of the facility, or by entering the city name. As a waypoint identifier, facility name, or location is entered, the aera's Spell'N'Find™ feature scrolls through the database, displaying those waypoints matching the characters which have been entered up to that point. A direct-to navigation leg to the selected waypoint can be initiated by pressing the **Menu/▶** Icon.

GPS Navigation

Flight Planning

The waypoint function allows the pilot to review airport information, runway information, frequencies, AOPA information (if available), and weather information (if available) by touching the desired tab. The pilot can manually enter the identifier or the aera will choose the most appropriate identifier based on the current position and phase of flight.

Hazard Avoidance

Additional Features

Appendices

Index

- Waypoint Identifier/Symbol/Type
- Facility Name
- City/State
- Fuel Available
- Elevation
- Time Zone (UTC Offset)
- Region

Waypoint Identifier Button: **KMCI** Public Airport

**Kansas City Intl**  
**Kansas City MO**  
 Avgas, Jet Fuel  
 1026ft MSL  
 UTC-6 (-5 DST) N CEN USA

Bearing/Distance: BRG 006<sup>m</sup> DIS 26.8<sup>m</sup> N 39°17.856' W 094°42.834'

Info Freq Runway WX/NOTAM AOPA

Option Menu: Menu

Back



Waypoint Information (Info Tab)

Lat/Long



The following descriptions and abbreviations are used:

- Usage type: Public, Military, or Private
- Runway surface type: Hard, Turf, Sealed, Gravel, Dirt, Soft, Unknown, or Water
- Runway lighting type: No Lights, Part Time, Full Time, Unknown, or PCL Freq (for pilot-controlled lighting)
- COM Availability: TX (transmit only), RX (receive only), PT (part time), \* (additional information available)



### Selecting an airport for review by identifier, facility name, or city:

- 1) From the **'Home'** Screen, touch **WPT Info** > **Info** Tab (if necessary).
- 2) Touch the Waypoint Identifier Button.
- 3) Enter the desired waypoint:
  - a) Touch the   buttons to **'Search by Identifier'**, **'Search by Facility Name'**, or **'Search by City'** using the keypad.
  - b) Enter the desired waypoint.
  - c) Touch the **OK** Icon.



**Or:**

  - a) Touch the   buttons to cycle through the waypoint categories (**'Flight Plan Waypoints'**, **'Nearest Airports'**, or **'Recent Waypoints'**.)
  - b) Touch the desired waypoint from the list.
- 4) If duplicate entries exist for the entered facility name or location, duplicate waypoints are displayed. Touch the desired waypoint from the list.

### Selecting a runway:

- 1) From the **'Home'** Screen, touch **WPT Info** > **Runway** Tab.
- 2) Touch the Waypoint Identifier Button.
- 3) Enter the desired waypoint:
  - a) Touch the   buttons to **'Search by Identifier'**, **'Search by Facility Name'**, or **'Search by City'** using the keypad.
  - b) Enter the desired waypoint.
  - c) Touch the **OK** Icon.

**Or:**



a) Touch the   buttons to cycle through the waypoint categories ('Flight Plan Waypoints', 'Nearest Airports', or 'Recent Waypoints').

b) Touch the desired waypoint from the list.

4) If duplicate entries exist for the entered facility name or location, duplicate waypoints are displayed. Touch the desired waypoint from the list.

5) If multiple runways exist, touch the Runway Button, and touch the desired runway from the vertical list.

Or:

Touch the   buttons to cycle through the runways.



Selecting additional information for a frequency:

- 1) From the 'Home' Screen, touch WPT Info > Freq Tab.
- 2) Touch the frequency denoted with an \*.

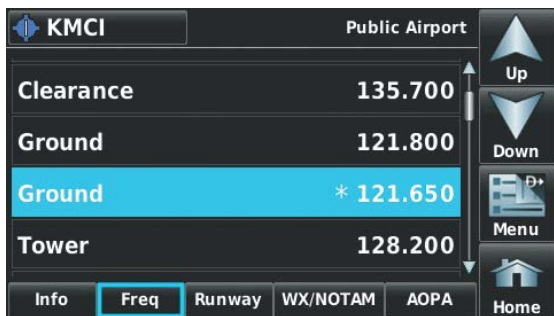



The Frequencies Box uses the descriptions and abbreviations listed in the following table:

| Communication Frequencies            |             |           | Navigation Frequencies |
|--------------------------------------|-------------|-----------|------------------------|
| Approach *                           | Control     | Pre-Taxi  | ILS                    |
| Arrival *                            | CTA *       | Radar     | LOC                    |
| ASOS                                 | Departure * | Ramp      |                        |
| ATIS                                 | Gate        | Terminal* |                        |
| AWOS                                 | Ground      | TMA *     |                        |
| Center                               | Helicopter  | Tower     |                        |
| Class B *                            | Multicom    | TRSA *    |                        |
| Class C *                            | Other       | Unicom    |                        |
| Clearance                            |             |           |                        |
| * May include Additional Information |             |           |                        |

**Frequency Abbreviations**

## NEAREST INFORMATION

The aera provides a Nearest function which gives the pilot quick access to nearest airport, weather, VOR, NDB, intersection, user waypoint, city, ARTCC, FSS, and airspace information. If there are none available, "None Within 200 NM" is displayed.

The Nearest functions contain the following information.

- Airport—identifier, bearing, distance, length of the longest runway, and common traffic advisory (CTAF) or tower frequency.
- Airport WX (Airport Weather)—identifier, bearing, distance, METAR text (aera 510 & 560 only), and ATIS, AWOS, or ASOS frequency.
- VOR (VHF Omnidirectional Radio Beacon)—identifier, facility type (symbol), bearing, distance, and frequency.
- NDB (Non Directional Beacons)—identifier, facility, type (symbol), bearing, distance, and frequency.
- Intersection—identifier, bearing, and distance.
- VRP (Visual Reporting Point) (Atlantic Unit Only)—identifier, bearing, and distance.

- USR WPT (User Waypoints)—name, bearing, and distance.
- City—name, bearing, and distance.
- ARTCC (Air Route Traffic Control Center)—bearing, distance, and frequency.
- FSS (Flight Service Station)—name, bearing, distance, frequency, and VOR (if applicable).
- Airspace—name, time to entry (when applicable), and status.

**Viewing nearest information:**

- 1) From the 'Home' Screen, touch the **Nearest** Icon to display the second level Nearest Icons.
- 2) Touch the desired Nearest Icon (**Airport, Airport WX, VOR, NDB, Intersection, User WPT, City, ARTCC, FSS, or Airspace**).
- 3) Touch the desired nearest option from the list for additional information.

**Or:**

If viewing Nearest ARTCCs or FSSs, touch the  buttons to cycle through the list.

- 4) If desired, touch **Menu > Show Map** (except for ARTCC, FSS, or Airspace).
- 5) Touch the **Back** Icon to return to the second level Nearest Icons.

**Or:**

Touch the **Direct** Icon (if applicable), then the Activate Button to navigate Direct-to the selected waypoint.

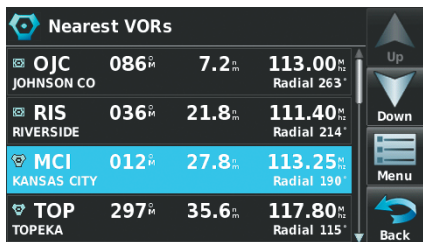

Nearest VORs List



Additional VOR Information

## NEAREST AIRPORT CRITERIA

The pilot can define the minimum runway length and surface type used when determining the 15 nearest airports to display. A minimum runway length and/or surface type can be entered to prevent airports with small runways or runways that are not appropriately surfaced from being displayed. Default settings are 0 feet (or meters) for runway length and "Any" for runway surface type. Private airports and Heliports can also be included.

The Nearest Airports Option Menu also allows the pilot to choose between displaying the facility names, city names, bearing, or direction arrows.

### Setting nearest airport criteria:

Refer to Section 1.4 'Airport Criteria Settings'.

## WEATHER AND NOTAM INFORMATION (OPTIONAL)

Textual weather and NOTAM information can be viewed several different ways.

### Viewing airport weather/NOTAM information:

- 1) From the **'Home'** Screen, touch the **WPT Info** Icon.
- 2) Enter the desired waypoint identifier.
- 3) Touch the **WX/NOTAM** Tab.

**Or:**

- 1) From the **'Home'** Screen, touch the **Nearest > Airport WX**.
- 2) Touch the desired Nearest Airport Weather from the list.

**Or:**

- 1) From the **'Home'** Screen, touch the **Weather > METAR**.
- 2) Touch the desired METAR flag.
- 3) Touch the Map Feature Button with the desired identifier displayed (refer to 'Map Panning' in the Overview Section for more information). The weather information is displayed.

**Or:**

- 1) From the 'Home' Screen, touch the **Map** Icon.
- 2) Touch the desired METAR Flag (If the METAR flags are not displayed, adjust the settings from the 'Set Up Map' menu option).
- 3) Touch the Map Feature Button with the desired identifier displayed (refer to 'Map Panning' in the Overview Section for more information). The weather information is displayed.

*METAR Selected*



*Map  
Feature  
Button*

**Weather Information**

## ACCESSING ADDITIONAL INFORMATION

In addition to airport and weather information, additional information for VORs, NDBs, Intersections, User Waypoints, Cities, ARTCCs, FSSs, and Airspace can be viewed using the Waypoint Information function, the Nearest function, or the Map Panning function.

| Additional Information |         |     |     |              |          |      |       |     |          |
|------------------------|---------|-----|-----|--------------|----------|------|-------|-----|----------|
|                        | Airport | VOR | NDB | Intersection | User Wpt | City | ARTCC | FSS | Airspace |
| Identifier             | +       | +   | +   | +            | +        |      |       |     |          |
| Frequency              | +       | +   | +   |              |          |      | +     | +   | +        |
| Name                   | +       | +   | +   | +            | +        |      |       |     | +        |
| City                   | +       | +   | +   |              |          | +    |       |     | +        |
| State                  | +       | +   | +   |              |          | +    |       |     |          |
| Type                   | +       | +   | +   |              |          |      |       |     |          |
| Morse Code             |         | +   | +   |              |          |      |       |     |          |
| Radial                 |         | +   |     |              |          |      |       |     |          |
| Region                 | +       | +   | +   | +            | +        |      |       |     |          |
| Bearing                | +       | +   | +   | +            | +        | +    | +     | +   |          |
| Distance               | +       | +   | +   | +            | +        | +    | +     | +   | +        |
| Lat/Long               | +       | +   | +   | +            | +        | +    |       |     |          |
| Elevation (MSL)        | +       |     |     |              | +        |      |       |     |          |
| Fuel Available         | +       |     |     |              |          |      |       |     |          |
| Time Zone (UTC Offset) | +       |     |     |              |          |      |       |     |          |
| Runway Information     | +       |     |     |              |          |      |       |     |          |
| AOPA                   | +       |     |     |              |          |      |       |     |          |
| Weather                | +       |     |     |              |          |      |       |     |          |
| Controlling Agency     |         |     |     |              |          |      |       |     | +        |
| Vertical Boundaries    |         |     |     |              |          |      |       |     | +        |
| Class                  |         |     |     |              |          |      |       |     | +        |

## INTERSECTIONS

Intersection information can be viewed using the Waypoint Information function, the Nearest function, or the Map Panning function.

The Nearest Intersection function can be used to quickly find an intersection close to the flight path. The list only includes Intersections that are within 200nm. If there are no Intersections within the range, text indicating that there are no nearest intersections is displayed.

### Select an intersection:

- 1) From the **'Home'** Screen, touch the **WPT Info** Icon.
- 2) Touch the Waypoint Identifier Field to begin entering the desired intersection. Refer to the Overview Section on 'Data Entry' for more information.

#### Or:

- 1) From the **'Home'** Screen, touch **Nearest > Intersection**.
- 2) Touch the desired Nearest Intersection from the list.
- 3) If desired, touch **Menu > Show Map**.

#### Or:

- 1) From the **'Home'** Screen, touch the **Map** Icon.
- 2) Touch the desired Intersection on the map.
- 3) Touch the Map Feature Button with the desired intersection displayed (refer to the Overview Section on 'Map Panning' for more information). The intersection information is displayed.

## NDBs

NDB information can be viewed using the Waypoint Information function, the Nearest function, or the Map Panning function.

The Nearest NDB function can be used to quickly find a NDB close to the flight path. The list only includes NDBs that are within 200nm. If there are no NDBs in the list, text indicating that there are no nearest NDBs is displayed.

### Select an NDB:

- 1) From the '**Home**' Screen, touch the **WPT Info** Icon.
- 2) Touch the Waypoint Identifier Field to begin entering the desired NDB. Refer to the Overview Section on 'Data Entry' for more information.

#### Or:

- 1) From the '**Home**' Screen, **Nearest** > **NDB**.
- 2) Touch the desired Nearest Intersection from the list.
- 3) If desired, touch **Menu** > **Show Map**.

#### Or:

- 1) From the '**Home**' Screen, touch the **Map** Icon.
- 2) Touch the desired NDB on the map.
- 3) Touch the Map Feature Button with the desired NDB displayed (refer to the Overview Section on 'Map Panning' for more information). The NDB information is displayed.

## VORs

VOR information can be viewed using the Waypoint Information function, the Nearest function, or the Map Panning function.

The Nearest VOR function can be used to quickly find a VOR close to the flight path. The list only includes VORs that are within 200nm. If there are no VORs in the list, text indicating that there are no nearest VORs is displayed.

Localizer information cannot be viewed for the VOR. If a VOR station is combined with a TACAN station it is listed as a VORTAC, and if it includes only DME it is displayed as VOR-DME.

### Select an VOR:

- 1) From the '**Home**' Screen, touch the **WPT Info** Icon.
- 2) Touch the Waypoint Identifier Field to begin entering the desired VOR. Refer to the Overview Section on 'Data Entry' for more information.

#### Or:

- 1) From the 'Home' Screen, touch **Nearest > VOR**.
- 2) Touch the desired Nearest VOR from the list.
- 3) If desired, touch **Menu > Show Map**.

**Or:**

- 1) From the 'Home' Screen, touch the **Map** Icon.
- 2) Touch the desired VOR on the map.
- 3) Touch the Map Feature Button with the desired VOR displayed (refer to the Overview Section on 'Map Panning' for more information). The VOR information is displayed.

## USER WAYPOINTS

The aera can create and store up to 3,000 user-defined waypoints. Once a waypoint has been created, it can be renamed, deleted, or moved.



User Waypoints

### Creating user waypoints:

- 1) To create a new user waypoint at the current location or using the Map Pointer:
  - a) From the 'Home' Screen, touch **Tools > User WPT > Menu**.
  - b) Touch '**Create Waypoint**'.

**Or:**

  - a) With a map displayed, touch an empty area without any map features.
  - b) Touch the Map Feature Button.
  - c) Touch '**Save**'.

**Or:**



- a) With a map displayed, touch a map feature.
  - b) Touch the **Menu** Icon.
  - c) Touch '**Create Waypoint**'.
- Or:**
- a) From the '**Home**' Screen, touch the **Position** Icon.
  - b) Touch the **Mark Waypoint** Button.
- 2) Enter the desired user waypoint name (up to 10 characters). Refer to the Overview Section on 'Data Entry' for more information.
  - 3) Touch the **OK** Icon. If changing the User Waypoint settings (symbol, altitude, location, or reference waypoints) continue with Step 4.
  - 4) If desired, touch the **Symbol** Field to change the symbol that will appear on the map.
    - a) Touch the desired symbol.
    - b) Touch the **OK** Icon.

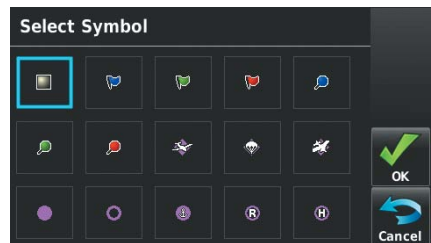

### User Waypoint Symbols

- 5) If desired, touch the **Altitude** Field
  - a) Enter the desired altitude using the keypad or the +/- buttons. Refer to the Overview Section on 'Data Entry' for more information.
  - b) Touch the **OK** Icon.
- 6) If desired, touch the **Location** Field.
  - a) Enter the desired latitude and longitude by touching the left/right arrows to move the cursor, and the up/down arrows to change the value.
  - b) Touch the **OK** Icon.

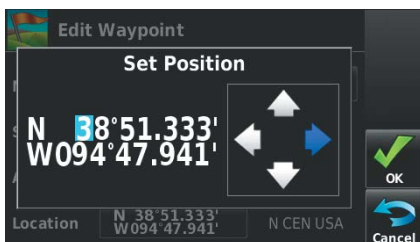
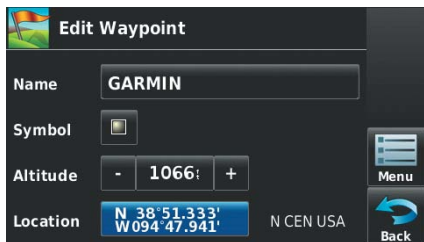

### User Waypoint Location

- 7) If desired, touch the **Menu** Icon and touch 'Reference Waypoints' to enter a bearing and distance from another waypoint or the bearing from two other waypoints to define a new waypoint location.
  - a) Touch the **Waypoint Field(s)** to enter the desired waypoint.
  - b) Touch the **Bearing** and/or **Distance** Fields to enter the desired values.
  - c) Touch the **OK** Icon.
- 8) Touch and hold the **Back** Icon to return to the 'Home' Screen.

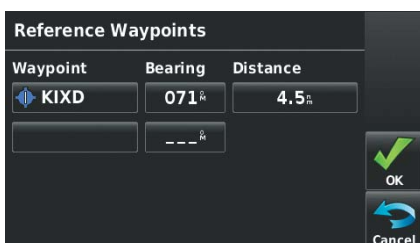

### Reference Waypoints

#### Selecting and viewing nearest user waypoints:

- 1) From the 'Home' Screen, touch **Nearest** > **User WPT**.
- 2) Touch the desired User Waypoint. The User Waypoint information is displayed.
- 3) If desired, touch the **Menu** Icon and the '**Show Map**' menu option to view the User Waypoint on the map.

#### Editing or renaming a user waypoint:

- 1) From the 'Home' Screen, touch **Tools** > **User WPT**.
- 2) Touch the desired User Waypoint. The option menu automatically displays.

- 3) Touch the '**Edit Waypoint**' menu option.
- 4) Touch the desired field to edit:
  - a) Touch the **Name** Button.
  - b) Enter the desired user waypoint name (up to 10 characters). Refer to the Overview Section on 'Data Entry' for more information.

**Or:**

- a) Touch the **Symbol** Button.
- b) Touch the desired symbol.

**Or:**

- a) Touch the **Altitude** Button.
- b) Enter the desired altitude. Refer to the Overview Section on 'Data Entry' for more information.

**Or:**

- a) Touch the **Location** Button.
- b) Enter the desired latitude and longitude by touching the left/right arrows to move the cursor, and the up/down arrows to change the value.

- 5) Touch the **OK** Icon.

**Deleting user waypoints:**

- 1) From the '**Home**' Screen, touch **Tools > User WPT**.
- 2) Delete a single waypoint, delete all waypoints, delete by symbol or delete by distance:
  - a) Touch the desired User Waypoint. The option menu automatically displays
  - b) Touch the '**Delete Waypoint**' menu option. The confirmation window will appear.

**Or:**

- a) Touch the **Menu** Icon.
- b) Touch the '**Delete All**' menu option. The confirmation window will appear.

**Or:**

- a) Touch the **Menu** Icon.
- b) Touch the '**Delete by Symbol**' menu option.
- c) Touch the desired symbol to delete. The symbol will be highlighted blue.
- d) Touch the **OK** icon. The confirmation window will appear.

**Or:**

- a) Touch the **Menu** Icon.
  - b) Touch the '**Delete by Distance**' menu option.
  - c) If desired, touch the **From** Field and touch '**Current Location**' (default), '**Use Identifier**', or '**Use Map**' from the option menu.
  - d) If desired, touch the '**Less Than/More Than**' Button, and touch the **Distance** Field to enter the desired distance.
  - e) Touch the **OK** icon. The confirmation window will appear.
- 3) Touch **Yes**.

## CITIES

City information can be viewed using the Waypoint Information function, the Nearest function, or the Map Panning function.

The Nearest City function can be used to quickly find a city close to the flight path. The list only includes cities that are within 200nm. If there are no cities in the list, text indicating that there are no nearest cities is displayed.

### Select a city:

- 1) From the '**Home**' Screen, touch **WPT Info** > **Info** Tab.
- 2) Touch the Waypoint Identifier Field.
- 3) Touch the  buttons until the '**Search by City**' option is displayed, and touch the button.
- 4) Enter the desired city using the keypad and touch **OK**. Refer to the Overview Section on 'Data Entry' for more information.

**Or:**

- 1) From the '**Home**' Screen, touch **Nearest** > **City**.
- 2) Touch the desired Nearest City from the list.
- 3) If desired, touch **Menu** > **Show Map**.

Or:



- 1) From the **'Home'** Screen, touch the **Map** Icon.
- 2) Touch the desired city symbol on the map.
- 3) Touch the Map Feature Button with the desired city displayed (refer to the Overview Section on 'Map Panning' for more information). The city information is displayed.

## ARTCC

ARTCC information can be viewed using the Nearest function.

The Nearest ARTCC function can be used to quickly find a ARTCC close to the flight path. The list only includes ARTCC that are within 200nm. If there are no ARTCCs in the list, text indicating that there are no nearest ARTCCs is displayed.

### Select an ARTCC:

- 1) From the **'Home'** Screen, touch **Nearest > ARTCC**.
- 2) Touch the   buttons to cycle through the list. The associated bearing, distance, and frequencies are displayed.



## FSS

FSS information can be viewed using the Nearest function.

The Nearest FSS function can be used to quickly find a FSS close to the flight path. The list only includes FSS that are within 200nm. If there are no FSSs in the list, text indicating that there are no nearest FSSs is displayed.

FSS frequencies and phone numbers can also be found using the **AOPA** Tab when reviewing information for an airport. Refer to the Additional Features Section on 'AOPA' for more information.

### Select an FSS:

- 1) From the **'Home'** Screen, touch **Nearest > FSS**.
- 2) Touch the   buttons to cycle through the list. The associated bearing, distance, and frequencies are displayed.

## AIRSPACE

The Nearest Airspace function and Airspace Alerts provide information about airspaces and the location of the aircraft in relationship to them. The Nearest Airspace function can be used to quickly find airspaces close to the flight path.

The Nearest Airspace function displays the class of airspace, controlling agency, vertical boundaries, and status.

### Selecting and viewing nearest airspaces:

- 1) From the 'Home' Screen, touch **Nearest > Airspace**.
- 2) Touch the desired airspace from the list. The airspace information is displayed.
- 3) If desired, touch '**Frequencies**' to view frequencies associated with that airspace.



Nearest Airspace

## AIRSPACE ALERT MESSAGES

If airspace alarms are set to 'On' (default is 'Off'), the aera will display a message which includes the airspace name, time to entry (if applicable), and status. Touch the message to acknowledge it.

There are four types of status information:

- Ahead—Projected to enter the airspace within the next 10 minutes or less
- Near—Within two nautical miles of an airspace but not projected to enter it.
- Near & Ahead—Project to enter the airspace within two nautical miles.
- Inside Airspace—Within the boundaries of the airspace.

**Airspace alert setup:**

- 1) From the 'Home' Screen, touch **Tools > Setup > SUA Alarms**.
- 2) Touch the desired **On/Off** Button(s).

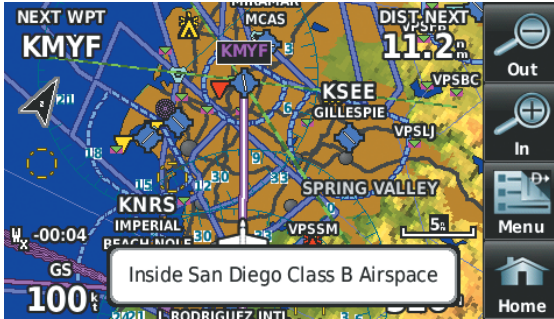

**Airspace Alert Message**

**SMART AIRSPACE™**

Smart Airspace shows airspace at and immediately surrounding the aircraft's current altitude in bold. Airspaces at all other altitudes are de-emphasized.

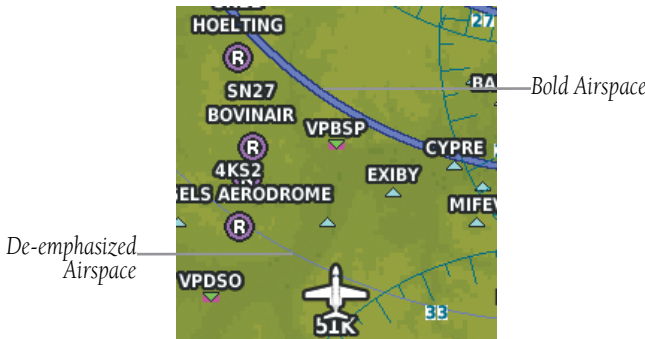

**Smart Airspace™**

**Smart Airspace setup:**

- 1) From the 'Home' Screen, touch **Map > Menu > Set Up Map**.
- 2) Touch the **◀ ▶** buttons to select the **Airspace Category**.
- 3) Touch the **Smart Airspace**.
- 4) Touch the **On/Off** Button.

## 2.6 DIRECT-TO NAVIGATION

The Direct-to method of navigation, initiated by pressing the **Direct To** Icon is quicker to use than a flight plan when the desire is to navigate to a single point such as a nearby airport.

The **Direct To** Icon is available from the 'Home' Screen, or 'touch and hold' the **Menu/▶** Icon when available.

Once a direct-to is activated, the aera establishes a point-to-point course line from the present position to the selected direct-to destination. Course guidance is provided until the direct-to is replaced with a new direct-to or flight plan, or cancelled.



Direct To

### Entering a waypoint identifier, facility name, or city as a direct-to destination:

1) From the 'Home' Screen, touch the **Direct To** **▶** Icon.

**Or:**

Touch and hold the **Menu/▶** Icon (when available).

2) Touch **Menu** > **Resume Navigation**.

**Or:**

a) Touch the '**Search by Identifier**', '**Search by Facility Name**', or '**Search by City**' fields.'

b) Enter the desired Identifier, Facility Name, or City using the keypad. Refer to the Overview Section on 'Data Entry' for more information.

c) Touch the **OK** Icon.



Or:

- a) Touch '**More...**'.
  - b) Touch the  buttons to view '**Flight Plan Waypoints**', '**Nearest Airports**', or '**Recent Waypoints**'.
  - c) Touch the desired waypoint from the list.
- 4) Touch the **Activate** Icon (if necessary).

### Selecting a nearby airport as a direct-to destination:

- 1) From the '**Home**' Screen, touch **Nearest > Airport**.
- 2) Touch the desired nearest airport.
- 3) Touch and hold the **Menu/▶** Icon.
- 4) Touch the **Activate** Icon.



Direct To Shortcut

### Selecting a waypoint as a direct-to destination using the pointer:

- 1) With a map displayed, activate the map pointer by touching the desired waypoint. If no airport, NAVAID, or User Waypoint exists at the desired location, a temporary waypoint named 'MAP' is automatically created at the location of the map pointer.
- 2) Touch and hold the **Direct ▶** Icon.
- 3) Touch the **Activate** Icon.

### Canceling a direct-to:

- 1) From the 'Home' Screen, touch the **Direct To**  Icon.

**Or:**

From the 'Home' Screen, touch the **Active FPL** Icon.

**Or:**

Touch and hold the **Menu**/ Icon (when available).

- 2) Touch the **Menu** Icon.
- 3) Touch 'Stop Navigation'.

## SECTION 3 FLIGHT PLANNING

### 3.1 INTRODUCTION

Flight planning on the aera consists of building a flight plan by entering waypoints one at a time and inserting approaches as needed. The flight plan is displayed on maps using different line widths, colors, and types, based on the type of leg and the segment of the flight plan currently being flown.

Up to 50 flight plans with up to 300 waypoints each can be created and stored in memory. One flight plan can be activated at a time and becomes the active flight plan. The active flight plan is erased when the destination is reached and the system is turned off. When storing flight plans with an approach, the aera uses the waypoint information from the current database to define the waypoints. If the database is changed or updated, the aera automatically updates the information if the procedure has not been modified. If an approach is no longer available, the procedure is deleted from the affected stored flight plan(s), and an alert is displayed.

Whenever an approach is loaded into the active flight plan it replaces the destination airport with a sequence of waypoints for the selected approach. The airport must have a published instrument approach and only the final course segment (usually from final approach fix to missed approach point) of the published approach is available in the aera.

#### DATA FIELDS

The Active and Saved Flight Plan Data Fields can be changed by touching the Data Field Buttons at the top of the flight plan.

#### Changing the information shown in the flight plan data fields:

- 1) From the 'Home' Screen, touch the **Active FPL** Icon.  
**Or:**
  - a) From the 'Home' Screen, touch **Tools > FPL List**.
  - b) Touch the desired Saved Flight Plan from the list. An option menu appears.
  - c) Touch the '**Review Flight Plan**' menu option.

- 2) Touch the desired Data Field Button at the top of the Flight Plan.
- 3) Touch the desired Data Field. The currently selected Data Field is outlined in blue.
- 4) Touch the **OK** Icon.
- 5) If desired, repeat Steps 2-4 for the remaining Data Field.

Data Field Button



Flight Plan Data Fields

## 3.2 FLIGHT PLAN CREATION



The active flight plan is the flight plan to which the aera is currently providing guidance, and is shown on the navigation maps. Stored flight plans are flight plans available for activation (becomes the active flight plan).

Data Fields





Active Flight Plan



## Creating an active flight plan:

- 1) From the 'Home' Screen, touch the **Active FPL** Icon.
- 2) Touch the '**Touch to add Waypoint**' Button.
- 3) Enter the desired waypoint:
  - a) Touch the   buttons to '**Search by Identifier**', '**Search by Facility Name**', or '**Search by City**' using the keypad.
  - b) Enter the desired waypoint.
  - c) Touch the **OK** Icon.



**Or:**

  - a) Touch the   buttons to cycle through the waypoint categories ('**Flight Plan Waypoints**', '**Nearest Airports**', or '**Recent Waypoints**').
  - b) Touch the desired waypoint from the list.
- 4) If duplicate entries exist for the entered facility name or location, duplicate waypoints are displayed. Touch the desired waypoint from the list.
- 5) Repeat Steps 2-5 to enter each additional waypoint.

## Creating a stored flight plan:

- 1) From the 'Home' Screen, touch **Tools > FPL List > Menu > New Flight Plan**.
- 2) Touch the '**Touch to add Waypoint**' Button.
- 3) Enter the desired waypoint:
  - a) Touch the   buttons to '**Search by Identifier**', '**Search by Facility Name**', or '**Search by City**' using the keypad.
  - b) Enter the desired waypoint.
  - c) Touch the **OK** Icon.



**Or:**

  - a) Touch the   buttons to cycle through the waypoint categories ('**Flight Plan Waypoints**', '**Nearest Airports**', or '**Recent Waypoints**').
  - b) Touch the desired waypoint from the list.
- 4) If duplicate entries exist for the entered facility name or location, duplicate waypoints are displayed. Touch the desired waypoint from the list.
- 5) Repeat Steps 2-5 to enter each additional waypoint.



## ADDING WAYPOINTS TO AN EXISTING FLIGHT PLAN

Waypoints can be added to the active flight plan or any stored flight plan. Choose the flight plan, select the desired point of insertion, enter the waypoint, and it is added in front of the selected waypoint. Flight plans are limited to 300 waypoints (including approach waypoints).

### Adding a waypoint to an active or stored flight plan:

- 1) With an active or saved flight plan displayed, touch the desired point of insertion. The new waypoint will be added in front of the selected waypoint. An option menu will appear.
- 2) Touch the '**Insert Waypoint**' menu option.
- 3) Enter the desired waypoint:
  - a) Touch the   buttons to '**Search by Identifier**', '**Search by Facility Name**', or '**Search by City**' using the keypad.
  - b) Enter the desired waypoint.
  - c) Touch the **OK** icon.

**Or:**

  - a) Touch the   buttons to cycle through the waypoint categories ('**Flight Plan Waypoints**', '**Nearest Airports**', or '**Recent Waypoints**').
  - b) Touch the desired waypoint from the list.
- 4) If duplicate entries exist for the entered facility name or location, duplicate waypoints are displayed. Touch the desired waypoint from the list.

### Loading an approach procedure into a stored flight plan:

An Approach Procedure can be loaded at any airport that has an approach available. Only one approach can be loaded at a time in a flight plan. The route for a selected approach is defined by designating transition waypoints.

- 1) With an active or saved flight plan displayed, touch the **Menu** icon
- 2) Touch the '**Select Approach**' menu option. A vertical list of available approaches is displayed.
- 3) Touch the desired approach. The designated transition waypoints are added to the flight plan.



### 3.3 FLIGHT PLAN STORAGE

The aera can store up to 50 flight plans. The active flight plan is erased when another flight plan is activated. Details about each stored flight plan can be viewed using the Flight Plan List function.

#### Viewing information about a stored flight plan:

- 1) From the 'Home' Screen, touch **Tools > FPL List**
- 2) Touch the desired saved flight plan. An option menu is displayed.
- 3) Touch the '**Review Flight Plan**' menu option.

| Flight Plan List | Distance         | ESA               |
|------------------|------------------|-------------------|
| KMYF-KTOA        | 84 <sup>n</sup>  | 3231 <sup>m</sup> |
| KOJC-KMCI        | 27 <sup>n</sup>  | 975 <sup>m</sup>  |
| KOKB-KSBA        | 146 <sup>n</sup> | 3383 <sup>m</sup> |

 Menu  
 Home

Flight Plan List

#### Storing an active flight plan:

- 1) With the Active Flight Plan displayed, touch the **Menu** Icon.
- 2) Touch the '**Save Flight Plan**' menu option. A confirmation window appears.
- 3) Touch **Yes**. A copy of the flight plan is stored in the next available position in the Flight Plan List.

## 3.4 FLIGHT PLAN ACTIVATION

Activating a stored flight plan erases the active flight plan and replaces it with a copy of the flight plan being activated. Inverting a stored flight plan reverses the waypoint order, erases the active flight plan, and replaces it with the flight plan being activated (the stored flight plan is not changed).

### Activating a stored flight plan:

- 1) From the 'Home' Screen, touch **Tools > FPL List**
- 2) Touch the desired saved flight plan. An option menu is displayed.
- 3) Touch the '**Activate Flight Plan**' menu option. A confirmation window appears.
- 4) Touch **Yes**.

### Activating a Flight Plan Leg:

- 1) From the 'Home' Screen, touch the **Active FPL** icon.
- 2) While navigating an active flight plan, touch the desired leg to be activated. An option menu automatically appears.
- 3) Touch the '**Activate Leg**' menu option.
- 4) Touch **Yes**.

## 3.5 FLIGHT PLAN EDITING

### EDITING SPEED AND FUEL FLOW

#### Adjusting the Flight Plan cruise speed and fuel flow:

- 1) From the 'Home' Screen, touch **Tools > Profile**.
- 2) If necessary, touch the Aircraft Button, and touch the desired aircraft from the vertical list.
- 3) Touch the **Cruise Speed** and/or **Fuel Flow** Fields to enter the desired value using the keypad or by touching the '+' or '-' Buttons.



Aircraft Button

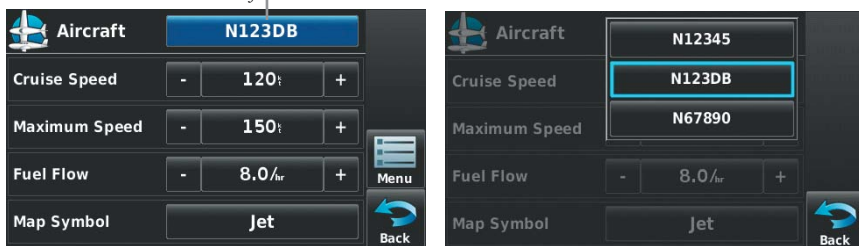

Flight Plan Data Fields

## COPYING FLIGHT PLANS

The aera allows copying a flight plan into a new flight plan memory slot, allowing editing, etc., without affecting the original flight plan. This can be used to duplicate an existing stored flight plan for use in creating a modified version of the original stored flight plan.

### Copying a stored flight plan:

With the desired Stored Flight Plan displayed, touch the **Menu > Copy Flight Plan > Yes**.

**Or:**

With the Flight Plan List displayed, touch the desired flight plan to copy, and touch **Copy Flight Plan**.

## DELETING FLIGHT PLANS

Individual or all stored flight plans can be deleted from the aera memory.

### Deleting a stored flight plan:

With the desired Stored Flight Plan displayed, touch the **Menu > Delete Flight Plan > Yes**

**Or:**

With the Flight Plan List displayed, touch the desired flight plan to delete, and touch **Delete Flight Plan > Yes**.

### Deleting all stored flight plans:

From the 'Home' Screen, touch **Tools > FPL List > Menu > Delete All > Yes**.



**NOTE:** The changes made to the active flight plan affect navigation as soon as they are entered. Editing the active flight plan does not affect any saved flight plans. Waypoints in the final approach segment (such as the FAF or MAP) can not be deleted individually.

### Deleting the Active Flight Plan:

From the 'Home' Screen, touch **Active FPL > Menu > Stop Navigation**.

### Deleting an individual waypoint from the active flight plan:

- 1) From the 'Home' Screen, touch the **Active FPL** icon.
- 2) While navigating an active flight plan, touch the waypoint to be deleted. An option menu appears.
- 3) Touch the '**Remove Waypoint**' menu option. A confirmation window appears.
- 4) Touch **Yes**.

### Deleting an individual waypoint from a saved flight plan:

- 1) From the 'Home' Screen, touch **Tools > FPL List**.
- 2) Touch the desired saved flight plan. An option menu is displayed.
- 3) Touch the '**Review Flight Plan**' menu option.
- 4) Touch the desired waypoint to be deleted. An option menu appears.
- 5) Touch the '**Remove Waypoint**' menu option.
- 6) Touch the desired waypoint to be deleted. A confirmation window appears.
- 7) Touch **Yes**.

## INVERTING A FLIGHT PLAN

Any flight plan may be inverted (reversed) for navigation back to the original departure point.

### Inverting the active flight plan:

From the 'Home' Screen, touch **Active FPL > Menu > Invert Flight Plan > Yes**.

### Inverting a saved flight plan:

- 1) From the 'Home' Screen, touch **Tools > FPL List**
- 2) Touch the desired saved flight plan. An option menu is displayed.

- 3) Touch the 'Review Flight Plan' menu option.
- 4) Touch the **Menu** Icon
- 5) Touch the 'Invert Flight Plan' menu option. A confirmation window appears.
- 6) Touch **Yes**.

### 3.5 APPROACHES



**WARNING:** The aera is not designed to be independently used for flight into instrument meteorological conditions (IMC) or other conditions in which aircraft control is based solely upon flight instruments. The approaches provided are for monitoring purposes only. Only the final course segment (final approach fix (FAF) to missed approach point (MAP)) of the published approach is available for monitoring.

An approach can be loaded at any airport that has one available, and provides guidance for non-precision and precision approaches to airports with published instrument approach procedures. Only one approach can be loaded at a time in a flight plan. If an approach is loaded when another approach is already in the active flight plan, the new approach replaces the previous approach. Only the final course segment (Final Approach Fix (FAF) to Missed Approach Point (MAP)) of the published approach is available for monitoring.

Whenever an approach is selected the aera automatically activates the approach. The procedure is added to the end of the flight plan and immediately begins to provide guidance to the first waypoint in the approach.

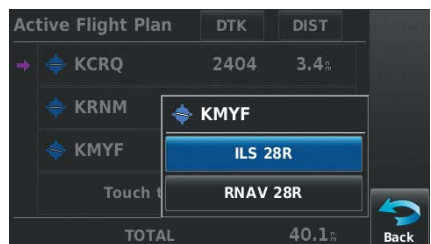
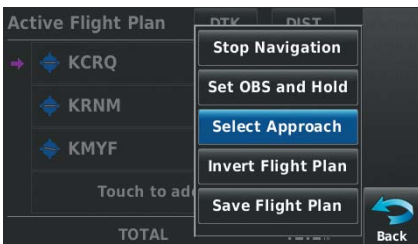

Select Approach

## SELECTING AN APPROACH

When selecting an approach, it replaces the destination airport with the sequence of waypoints for the selected approach. Keep in mind that the airport must have a published approach (GPS, RNAV, VOR, NDB, localizer, or ILS) and only the final course segment (final approach fix to missed approach point) of the published approach is available in the aera. If the airport does not have a published approach, the 'Select Approach' menu option is not available.

An approach can be selected using the Direct-to, Active Flight Plan, and the Saved Flight Plan functions.

### Selecting an approach from the active or saved flight plan:

- 1) From the 'Home' Screen, touch the **Active FPL** Icon.  
**Or:**
  - a) From the 'Home' Screen, touch the **Tools** Icon.
  - b) Touch the **FPL List** Icon.
  - c) Touch the desired Saved Flight Plan from the list. An option menu appears.
  - d) Touch the '**Review Flight Plan**' menu option.
- 2) With the flight plan displayed, touch the **Menu** Icon.
- 3) Touch the '**Select Approach**' menu option (only available if the destination airport has a published approach). A vertical list of available approaches is displayed.
- 4) Touch the desired approach. The 'Vectors to Final?' window appears.
- 5) Touch '**Yes**' or '**No**'. The procedure is added to the end of the flight plan. If activating an approach from the Active Flight Plan, the aera immediately begins to provide guidance to the first waypoint in the approach.

### Selecting an approach using the Direct To function:

- 1) From the 'Home' Screen, touch the **Direct To** Icon.
- 2) Touch the **Menu** Icon.
- 3) Touch the '**Select Approach**' menu option (only available when navigating a flight plan. A vertical list of available approaches is displayed.

- 4) Touch the desired approach. The 'Vectors to Final?' window appears.
- 5) Touch **'Yes'** or **'No'**. The procedure is added to the end of the Active Flight Plan and the aera immediately begins to provide guidance to the first waypoint in the approach.

### Resuming the Flight Plan after selecting an approach:

Whenever an approach is selected the aera automatically activates the approach. The procedure is added to the end of the flight plan and immediately begins to provide guidance to the first waypoint in the approach. Follow the steps below to resume the flight plan after activating the approach.

- 1) From the **'Home'** Screen, touch the **Active FPL** Icon.  
**Or:**  
 From the **'Home'** Screen, touch the **Direct To** Icon.  
**Or:**  
 Touch and hold the **Menu/▶** Icon (when available).
- 2) With a flight plan and an approach loaded, touch the **Menu** Icon.
- 3) Touch the **'Resume Flight Plan'** menu option.

### Removing an approach:

- 1) From the **'Home'** Screen, touch the **Active FPL** Icon.  
**Or:**
  - a) From the **'Home'** Screen, touch the **Tools** Icon.
  - b) Touch the **FPL List** Icon.
  - c) Touch the desired Saved Flight Plan from the list. An option menu appears.
  - d) Touch the **'Review Flight Plan'** menu option.
- 2) Press the **Menu** Icon.
- 3) Touch the **'Remove Approach'** menu option (only available if an approach is loaded).

## ACTIVATING VECTORS-TO-FINAL

After an approach has been activated, the 'Activate Vectors-to-Final' menu option is used when being vectored to the final approach course by Air Traffic Control (ATC).

When Vectors-to-Final are activated, the aera creates an extension of the final course, beyond the final approach waypoint in the database (final approach fix [FAF]). A Vector to Final symbol appears beside the first approach waypoint in the Active Flight Plan.

### Activating/Canceling Vectors-to-Final:

- 1) From the 'Home' Screen, touch the **Active FPL** Icon.
- 2) While navigating an Active Flight Plan (with an approach activated), touch the **Menu** Icon.
- 3) Touch the '**Activate Vectors-to-Final**' or '**Cancel Vectors-to-Final**' menu option.

*Vectors-to-Final Symbol*

| Active Flight Plan | DTK  | DIST                    |
|--------------------|------|-------------------------|
| KOKB               | ---- | ----                    |
| ▲ DEASY            | 4369 | 10.0 <sub>n</sub>       |
| ▲ RW24             | 4367 | 5.0 <sub>n</sub>        |
| <b>TOTAL</b>       |      | <b>15.1<sub>n</sub></b> |

Menu Home

Vectors-to-Final (Active Flight Plan)



Vectors-to-Final (Map)

The aera provides no guidance to the inbound course. The course deviation needle on the graphic HSI remains off-center until established on the final approach course. The map shows an extension of the final approach course using a bold magenta line.

If Vectors-to-Final are not activated, the aera creates a straight-line course directly to the first waypoint in the approach.

Loading the approach cancels the Direct-to and initiates a route to the FAF.

## SECTION 4 HAZARD AVOIDANCE

### 4.1 WEATHER

#### WEATHER SOURCE (aera 510 & 560 ONLY)

With a SiriusXM subscription and FIS-B weather information (through GDL 39), there are three options available for selection through the Main Menu or Weather Page; AUTO, XM (SiriusXM), and GDL FIS-B. The default selection is 'AUTO.' With AUTO selected, and a SiriusXM subscription, SiriusXM weather information is displayed. If SiriusXM service is unavailable with AUTO selected, FIS-B weather information is displayed, if available. If either SiriusXM or FIS-B source is selected, only the selected source is used to display weather information and no automatic source-switching will occur. Data from the selected weather source will apply to all weather shown on the Map Page, Waypoint Page, Weather Page, Nearest Page, and configurable data fields. The weather source can also be changed manually through the Main Menu or on the Weather Page (WX)

#### Switching Weather Sources:

- 1) Touch the **Weather > Menu > Set Up Weather.**
- 2) Use the  buttons to cycle through the available weather sources (AUTO, XM, or GDL FIS-B).

#### XM<sup>®</sup> WEATHER (aera 510 & 560)



**NOTE:** You *MUST* have a GXM 40 smart antenna connected to your aera 510 or aera 560 and a subscription to XM Weather to use XM Weather features.



**NOTE:** The weather products displayed on the aera are dependant on the XM Weather Data Service Package (Aviator LT, Aviator, Aviator Pro) purchased.

## ACTIVATING SERVICES

Before XM Satellite Weather can be used, the service must be activated. Service is activated by providing XM Satellite Radio with a Radio ID unique to the GXM 40 antenna.

XM Satellite Radio uses the Radio ID to send an activation signal that allows the aera to display weather data and/or entertainment programming provided through the GXM 40 antenna.

Refer to the GXM 40 Owner’s Manual for more information on activating XM Satellite Radio.

## XM WEATHER INFORMATION

- Radio ID—Eight-digit ID number used for activation.
- Service Level—XM Weather subscription plan purchased.
- Weather Products—List of weather features and age of weather data in minutes.

### Accessing the Radio ID:

From the ‘Home’ Screen, touch **Weather** > **Menu** > **Information**.



Accessing the XM Radio ID



## **XM SATELLITE WEATHER PRODUCTS**

### **NEXRAD**

NEXRAD (NEXT-generation RADar), is a network of multiple high-resolution Doppler radar sites that are operated by the National Weather Service (NWS). NEXRAD data provides centralized meteorological information for the continental United States and selected overseas locations. The maximum range of a single NEXRAD radar site is 250 nm. In addition to a wide array of services, the NEXRAD network provides important information about severe weather and air traffic safety.

NEXRAD data is not real-time. The lapsed time between collection, processing, and dissemination of NEXRAD images can be significant and may not reflect the current radar synopsis. Due to the inherent delays and the relative age of the data, it should be used for long-range planning purposes only. Never use NEXRAD data or any radar data to penetrate hazardous weather.

Composite data from all the NEXRAD radar sites in the United States is shown. This data is composed of the maximum reflectivity from the individual radar sweeps. The display of the information is color-coded to indicate the weather severity level.

The display of radar coverage is always active when NEXRAD is selected. Areas where NEXRAD radar coverage is not currently available or is not being collected are indicated in grayish-purple on the NEXRAD weather page. Radar capability exists in these areas, but it is not active or is off-line.

### **NEXRAD ABNORMALITIES**

There are possible abnormalities regarding displayed NEXRAD images. Some, but not all, of those include:

- Ground clutter
- Strokes and spurious radar data
- Sun strokes, when the radar antenna points directly at the sun
- Military aircraft deploy metallic dust (chaff) which can cause alterations in radar scans
- Interference from buildings or mountains, which may cause shadows

## NEXRAD LIMITATIONS

Certain limitations exist regarding the NEXRAD radar displays. Some, but not all, are listed for the user's awareness:

- NEXRAD base reflectivity does not provide sufficient information to determine cloud layers or precipitation characteristics (hail vs. rain). For example, it is not possible to distinguish between wet snow, wet hail, and rain.
- NEXRAD base reflectivity is sampled at the minimum antenna elevation angle. An individual NEXRAD site cannot depict high altitude storms at close ranges, and has no information about storms directly over the site.
- Radar coverage only extends to 55°N.
- Any precipitation displayed between 52°N and 55°N is unknown.

## NEXRAD INTENSITY

Colors are used to identify the different NEXRAD echo intensities (reflectivity) measured in dBZ (decibels of Z). "Reflectivity" (designated by the letter Z) is the amount of transmitted power returned to the radar receiver. The dBZ values increase as returned signal strength increases. Precipitation intensity is displayed using colors corresponding to the dBZ values.



RADAR Legend

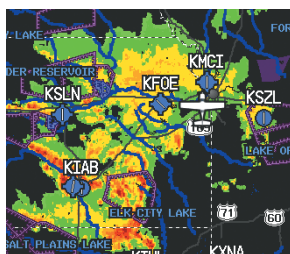

NEXRAD Data

## SATELLITE MOSAIC

Satellite Mosaic displays infrared composite images of cloud cover taken by geostationary weather satellites. The Satellite Mosaic provides up to seven levels of cloud cover.



RADAR Legend

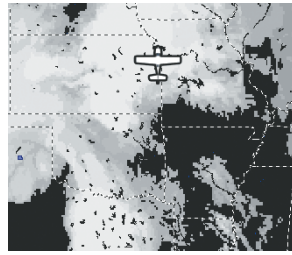

Satellite Mosaic/Cloud Tops Data

### ECHO TOPS

Echo Tops are derived from NEXRAD radar and indicate the highest altitude at which precipitation is falling. Echo Tops at or above the altitude you select are displayed, in 5,000 foot increments up to 70,000 ft. Echo Tops can be helpful in determining the severity of thunderstorms.

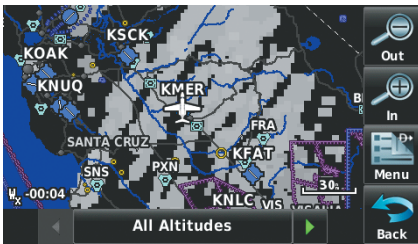

Echo Tops Data

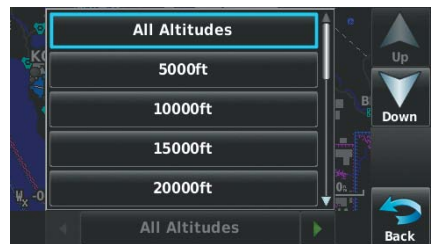

Echo Tops Altitudes

### WINDS ALOFT

Winds Aloft data shows the forecasted wind speed and direction at the surface and at selected altitudes. Altitudes can be displayed in 3,000-foot increments up to 42,000 feet MSL.

Winds Aloft are displayed using wind barbs or a wind streamline depending on the selected range. The wind barbs indicate wind speed and direction. The wind streamline indicates wind direction with arrows.

The wind barbs always point in the direction that the wind is coming from. The wind speed is depicted using flags at the end of the wind barb. A short wind flag is 5 knots, a long wind flag is 10 knots, and a triangle flag is 50 knots.

Overview  
GPS Navigation  
Flight Planning  
Hazard Avoidance  
Additional Features  
Appendices  
Index



Winds Aloft Data

Winds Aloft Altitudes

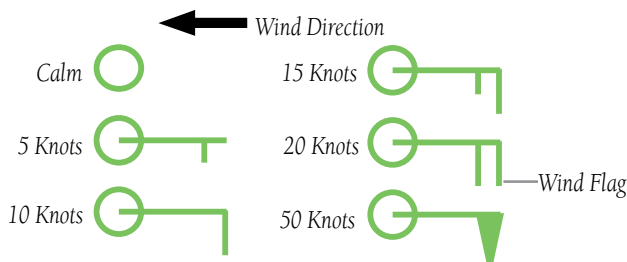

Winds Barbs

## XM LIGHTNING

Lightning data shows the approximate location of cloud-to-ground lightning strikes. A strike icon represents a strike that has occurred within a two-kilometer region and within the last seven minutes. The exact location of the lightning strike is not displayed.



Lightning Data

## STORM CELLS

The Storm Cells feature displays storms as well as the storm's projected path in the immediate future.

The direction of the storm is displayed by an arrow. The map range at which the arrow is displayed depends on the storm cell's speed. The tip of the arrow indicates where the storm should be in 15 minutes. Critical information about the storm cell (tops and intensity) can be viewed by selecting the storm cell with the map pointer. Touching the Map Feature Button will display additional information.

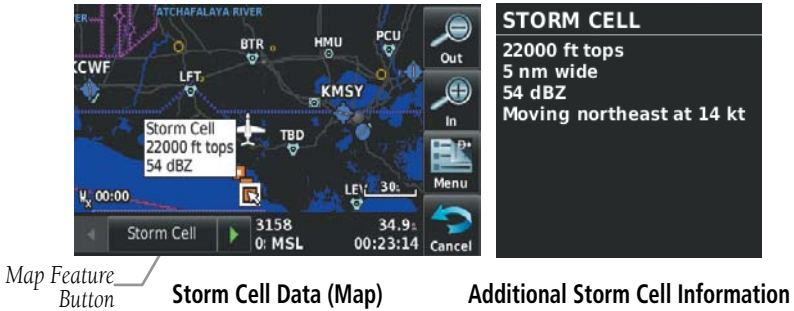

**METARS AND TAFS**



**NOTE:** METAR information is only displayed within the installed aviation database service area.

METAR (METeoro logical Aerodrome Report) is an international code used for reporting weather observations. METARs are updated hourly or as needed. METARs typically contain information about the temperature, dewpoint, wind, precipitation, cloud cover, cloud heights, visibility, and barometric pressure. They can also contain information on precipitation amounts, lightning, and other critical data. If METAR data is available for an airport, a color-coded flag is shown next to the airport.

TAF (Terminal Area Forecast) is the standard format for 24-hour weather forecasts. TAFs may contain some of the same code as METAR data. It typically forecasts significant weather changes, temporary changes, probable changes, and expected changes in weather conditions.

An abbreviated version can be viewed by selecting the METAR flag with the map pointer. Touching the Map Feature Button will display additional information. METAR and TAF data can be displayed as raw or decoded text.







Map Feature Button

## METAR Data (Map)



## Additional METAR Data

The METAR flag color is determined by the information in the METAR text.

-  VFR (ceiling greater than 3000 feet AGL and visibility greater than 5 miles)
-  Marginal VFR (ceiling 1000-3000 feet AGL and/or visibility 3-5 miles)
-  IFR (ceiling 500 to below 1000 feet AGL and/or visibility 1 mile to less than 3 miles)
-  Low IFR (ceiling below 500 feet AGL or visibility less than 1 mile)
-  METAR text does not contain adequate information to determine flight conditions

## AIRMETS

An AIRMET (AIRmen's METeoro logical Information) can be especially helpful for pilots of light aircraft that have limited flight capability or instrumentation. An AIRMET must affect or be forecast to affect an area of at least 3,000 square miles at any one time. AIRMETS are routinely issued for six-hour periods and are amended as necessary due to changing weather conditions. AIRMETS are displayed as colored, dashed lines.

## SIGMETS

A SIGMET (SIGNificant METeoro logical Information) advises of weather that is potentially hazardous to all aircraft. In the contiguous United States, the following

items are covered: severe icing, severe or extreme turbulence, volcanic ash, dust storms, and sandstorms that lower visibility to less than three statute miles.

A Convective SIGMET is issued for the following conditions: thunderstorms, isolated severe thunderstorms, embedded thunderstorms, hail at the surface, and tornadoes.

A SIGMET is widespread and must affect or be forecast to affect an area of at least 3,000 square miles. SIGMETs are displayed as a yellow-dashed line.

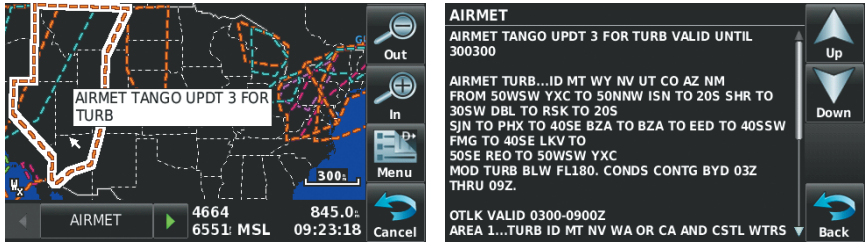

Map Feature Button

**AIRMET Selected**

**Additional AIRMET Data**

## TEMPORARY FLIGHT RESTRICTIONS (TFRS)

Temporary Flight Restrictions or TFRs temporarily restrict all aircraft from entering the selected airspace unless a waiver has been issued. TFRs are routinely issued for activities such as sporting events, dignitary visits, military depots and forest fires. TFRs are represented as an area highlighted by red (active) or yellow (not yet active).



Map Feature Button

**TFR Data Selected**

**Additional TRF Information**

## PIREPS

Pilot Weather Reports (PIREPs) provide timely weather information for a particular route of flight. When significant weather conditions are reported or forecast, Air Traffic Control (ATC) facilities are required to solicit PIREPs. A PIREP may contain unforecast adverse weather conditions, such as low in-flight visibility, icing conditions, wind shear, and turbulence. PIREPs are issued as either Routine (UA) (blue) or Urgent (UUA) (yellow).



PIREP Selected

Map Feature Button

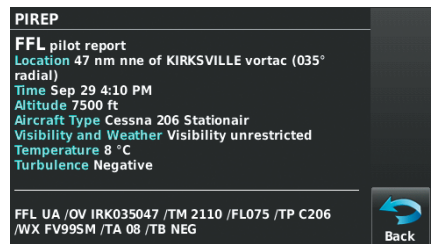

Additional PIREP Data

## FREEZING LEVELS

Freezing Level shows contours for the lowest forecast altitude where icing conditions are likely to occur.

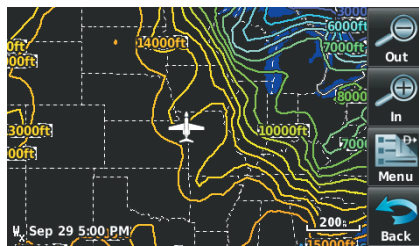

Freezing Level Data



### TURBULENCE FORECAST

Turbulence data identifies the potential for erratic movement of high-altitude air mass associated winds. Turbulence is classified as light, moderate, severe, or extreme. Turbulence data is intended to supplement AIRMETs and SIGMETs.

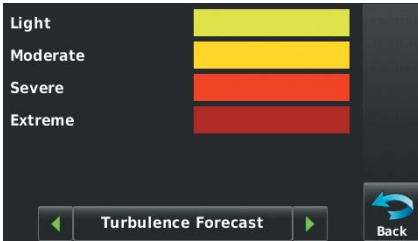

**Turbulence Forecast Legend**

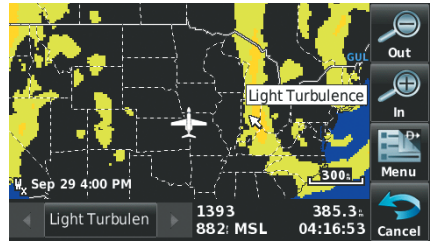

**Light Turbulence Selected**

### ICING FORECAST (CIP & SLD)

Current Icing Product (CIP) data shows a graphical view of the current icing environment. Icing severity is displayed in four categories: light, moderate, severe, and extreme (not specific to aircraft type). The CIP product is not a forecast, but a representation of the current conditions at the time of the analysis.

Supercooled Large Droplet (SLD) icing conditions are characterized by the presence of relatively large, super cooled water droplets indicative of freezing drizzle and freezing rain aloft. SLD threat areas are depicted as magenta dots over the CIP colors.

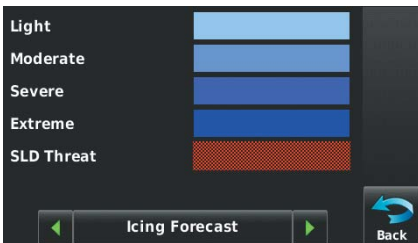

**Icing Forecast Legend**

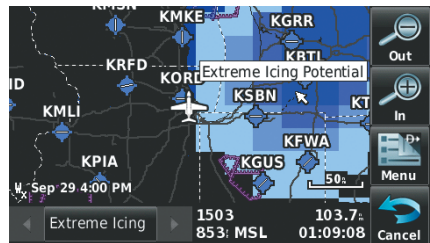

**Extreme Icing Selected With Map Pointer**

# FORECAST

Forecast information is available for current and forecast weather conditions. Forecasts are available for intervals of 12, 24, 36, and 48 hours.

Overview

GPS Navigation

Flight Planning

Hazard Avoidance

Additional Features

Appendices

Index

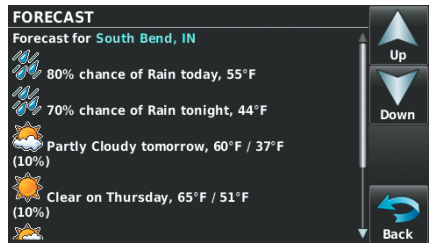
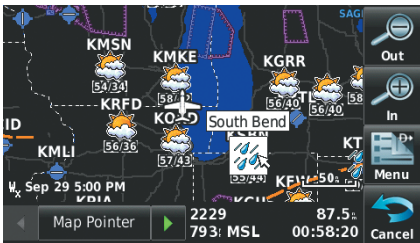

Map Feature Button

Forecast Data Selected

Additional Forecast Information



Forecast Legend



Fronts Legend

## SURFACE PRESSURE

This feature displays pressure isobars and pressure centers. The isobars connect points of equal pressure. Pressure readings can help determine weather and wind conditions. High pressure areas are generally associated with fair weather. Low pressure areas are generally associated with clouds and the chance of precipitation. Isobars that are packed closely together show a strong pressure gradient. Strong gradients are associated with areas of stronger winds. Pressure units can be displayed in Millibars (mb) and Inches of Mercury (in).

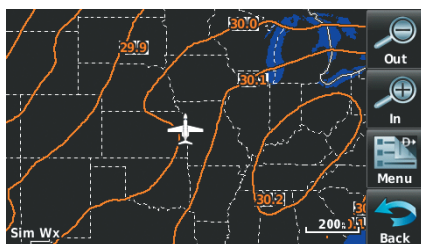

Surface Pressure Data

## USING XM SATELLITE WEATHER PRODUCTS

XM Weather Products can be displayed on the Navigation Map and individually on the Weather Maps.

The setup menu for the Navigation Map controls the map range settings above which weather products are decluttered from the display. If a map range larger than the weather product map range setting is selected, the weather product data is removed from the map. For weather products such as Lightning, and Storm Cells, the weather product is displayed when a map range “smaller” than the weather product map range setting is selected (Satellite Mosaic works inversely). The menu also provides a means for enabling/disabling display of ‘Airmets’, ‘Sigmets’, ‘Weather Data’, ‘NEXRAD’, and/or ‘Fronts’ on the Navigation Map.

Additional information about the following can be displayed by panning over the display on map:

- Storm Cells
- SIGMETs
- AIRMETs
- METARs
- TFRs

Additional information is also available for the following weather products on the Weather Map (not displayed on the Navigation Map):

- Forecast
- PIREPs

### Viewing XM Weather products on the Navigation Map:

- 1) From the 'Home' Screen touch the **Map** Icon.
- 2) Touch the **Menu** Icon.
- 3) Touch the '**Show/Hide...**' menu option.
- 4) Touch the **Weather 'Show/Hide'** Button.

### Viewing XM Weather products on the Weather Map:



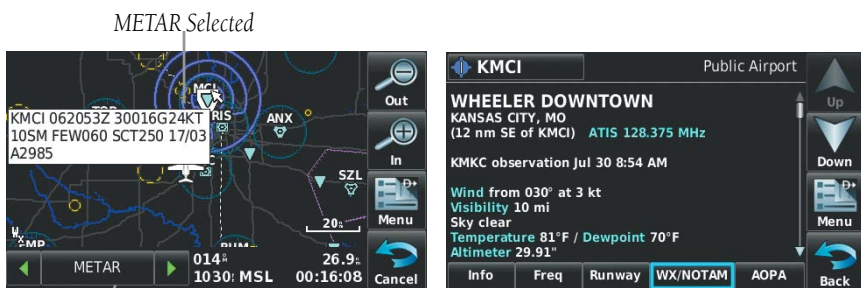

- 1) From the 'Home' Screen touch the **Weather** Icon.
- 2) Touch the desired second-level Weather Icon.
- 3) If necessary, touch the ◀▶ buttons to scroll through the list of available altitudes, AIRMET types, or forecast times.
- 4) Touch the desired weather product to get abbreviated information about the selected weather product (if available).
- 5) With the desired weather product highlighted, touch the Map Feature Button to get detailed information (if available).



Map Feature Button

METAR Information

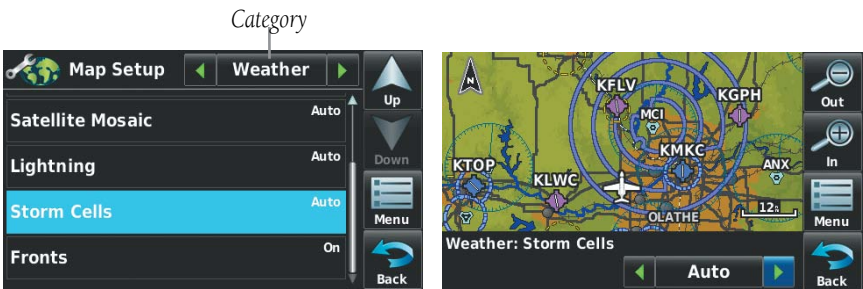

## Setting up and customizing weather data for the Navigation Map:

- 1) From the 'Home' Screen touch the **Map** Icon.
- 2) Touch the **Menu** Icon.
- 3) Touch the '**Set Up Map**' menu option.
- 4) Touch the   buttons to select the '**Weather**' Category.
- 5) Touch the desired setting to change.
- 6) Touch the   buttons (if available) to select the desired settings or touch the **On/Off** Button (if available).





Map Setup (Weather Category)

## Restoring default weather data for the Navigation Map:

- 1) From the 'Home' Screen, touch **Map > Menu > Set Up Map**.
- 2) Touch the   buttons until the '**Weather**' Category is displayed.
- 3) Touch the **Menu** Icon.
- 4) Touch the '**Restore Weather Defaults**' menu option.

## Viewing legends for displayed weather products:

- 1) From the 'Home' Screen, touch the **Map** Icon.  
**Or:**
  - a) From the 'Home' Screen, touch the **Weather** Icon.
  - b) Touch the desired second-level weather icon.
- 2) Press the **Menu** Icon.
- 3) Touch the '**Weather Legend**' menu option.
- 4) If desired, touch the   buttons until the desired legend is displayed.  
**Or:** Touch the **Back** Icon to return to the map.

**Animating XM weather:**

- 1) From the 'Home' Screen, touch the **Map** Icon (weather must be enabled).  
**Or:**
  - a) From the 'Home' Screen, touch the **Weather** Icon.
  - b) Touch the **NEXRAD** Icon or the **Satellite** Icon.
- 2) Touch the **Menu** Icon.
- 3) Touch the '**Animate Weather**' menu option.

**DATA LINK WEATHER (FIS-B) (ALL MODELS)**

The aera is compatible with the GDL 39 data link radio. The GDL 39 is a receive-only data link radio with on-board GPS, 978 MHz (the Universal Access Transceiver frequency band), and 1090 MHz Extended Squitter (1090 ES) receivers. It is designed to receive, process, and output traffic (ADS-B air-to-air, and TIS-B traffic information), and weather (Flight Information Service-Broadcast (FIS-B)) information to the aera through a power/data cable. As a UAT receiver, the GDL 39 can receive and, when connected to the aera, display Flight Information Service-Broadcast (FIS-B) weather products as well as traffic.

FIS-B is a free weather service that is broadcast by Ground Based Transceivers (GBTs) over the 978 MHz UAT frequency band as part of the FAA's Next Generation Air Transportation System (NextGen). To receive FIS-B weather information, the GDL 39 must be within range and line-of-sight of an operating GBT. Reception may be affected by altitude, terrain, and other factors. GDL 39-supported FIS-B weather products include METARs, TAFs, NEXRAD (Regional and CONUS (Combined)), AIRMETs, SIGMETs, PIREPs, and Winds and Temperatures Aloft. Other products include NOTAMs and TFRs.

**Viewing FIS-B Weather product Status:**

- 1) From the **Main Menu** touch the **Tools** Icon.
- 2) Touch **Data Link > Menu > FIS-B Weather**.

**Or:**

- 1) From the **Main Menu** touch the **Weather** Icon.
- 2) Touch **Menu > Information**.

### Viewing Ground Station Status:

- 1) From the **Main Menu** touch the **Tools** Icon.
- 2) Touch **Data Link Menu > Ground Stations**.

**Or:**

- 1) From the **Main Menu** touch the **Weather** Icon.
- 2) Touch **Menu > Information**.
- 3) Touch **Menu > Ground Stations**.

## FIS-B WEATHER PRODUCTS

FIS-B weather broadcasts are updated regularly and may take approximately ten minutes to transmit all available weather data. Therefore, not all available weather data is immediately available. No pilot action is required to receive FIS-B weather informations. Weather product status can be viewed on the dedicated Weather Page or by viewing Data Link status from the main menu.

When a FIS-B weather product is active on a map, the age of the data is displayed on the screen in the lower left corner. The age of the product is based on the time difference between when the data was assembled on the ground and the current GPS time. Weather products are refreshed at specific intervals (see Refresh Rate in the table below).

If, for any reason, a weather product is not refreshed within the Expiration Time intervals (see table), the data is considered expired and is removed from the display. This ensures that the displayed data is consistent with FIS-B broadcast data. If more than half of the expiration time has elapsed, the color of the product age displayed changes to yellow. The system displays dashes instead of a product age when a product has expired. If a weather product is not available or has not been received, the system displays 'N/A' instead of a product age.

The table below shows the FIS-B weather expiration time and the refresh rate. The broadcast interval represents the interval at which FIS-B GBTs broadcast new signals that may or may not contain new weather data. It does not represent the rate at which weather data is updated or new content is received by the GDL 39.

| FIS-B Products                           | Expiration Time | Update Interval (Minutes)                                 | Broadcast Interval (Minutes) |
|--|-----------------|---|------------------------------|
| NEXRAD Composite Reflectivity (CONUS)    | 60 minutes      | ~5 minutes precipitation mode<br>10 minutes for clear air | 15                           |
| NEXRAD Composite Reflectivity (Regional) | 60 minutes      | As Available  | 2.5                          |
| METAR                                    | 8 hours         | 1 minute (where available),<br>As Available otherwise     | 5                            |
| TAF                                      | 12 hours        | 8 hours   | 10                           |
| AIRMET                                   | 12 hours        | As Available  | 5                            |
| SIGMET                                   | 12 hours        | As Available, then at 15<br>minute intervals for 1 hour   | 5                            |
| PIREP                                    | 8 hours         | As Available  | 10                           |
| Winds and Temperatures Aloft             | 12 hours        | 12 hours  | 10                           |
| NOTAM (D)/FDC (Including TFRs)           | 12 hours        | As Available  | 10                           |

## Weather Product Timing

### NEXRAD

NEXRAD (NEXT-generation RADar), is a network of multiple high-resolution Doppler radar sites that are operated by the National Weather Service (NWS). NEXRAD data provides centralized meteorological information for the continental United States and selected overseas locations. The maximum range of a single NEXRAD radar site is 250 nm. In addition to a wide array of services, the NEXRAD network provides important information about severe weather and air traffic safety.

NEXRAD data is not real-time. The lapsed time between collection, processing, and dissemination of NEXRAD images can be significant and may not reflect the current



radar synopsis. Due to the inherent delays and the relative age of the data, it should be used for long-range planning purposes only. Never use NEXRAD data or any radar data to maneuver in or near areas of hazardous weather.

Composite data from all the NEXRAD radar sites in the United States is shown. This data is composed of the maximum reflectivity from the individual radar sweeps. The display of the information is color-coded to indicate the weather severity level.

The display of radar coverage is always active when NEXRAD is selected. Areas where NEXRAD radar coverage is not currently available or is not being collected are indicated in grayish-purple on the NEXRAD weather page. Radar capability exists in these areas, but it is not active or is off-line.

## NEXRAD Abnormalities

There are possible abnormalities regarding displayed NEXRAD images. Some, but not all, of those include:

- Ground clutter
- Strokes and spurious radar data
- Sun strokes, when the radar antenna points directly at the sun
- Military aircraft deploy metallic dust (chaff) which can cause alterations in radar scans
- Interference from buildings or mountains, which may cause shadows
- Poor reception from Ground Based Transceivers (GBTs) can cause portions of the received radar imagery to not be displayed

## NEXRAD Limitations

Certain limitations exist regarding the NEXRAD radar displays. Some, but not all, are listed for the user’s awareness:

- NEXRAD base reflectivity does not provide sufficient information to determine cloud layers or precipitation characteristics (hail vs. rain). For example, it is not possible to distinguish between wet snow, wet hail, and rain.
- NEXRAD base reflectivity is sampled at the minimum antenna elevation angle. An individual NEXRAD site cannot depict high altitude storms at close ranges, and has no information about storms directly over the site.

## NEXRAD INTENSITY

Colors are used to identify the different NEXRAD echo intensities (reflectivity) measured in dBZ (decibels of Z). "Reflectivity" (designated by the letter Z) is the amount of transmitted power returned to the radar receiver. The dBZ values increase as returned signal strength increases. Precipitation intensity is displayed using colors corresponding to the dBZ values.

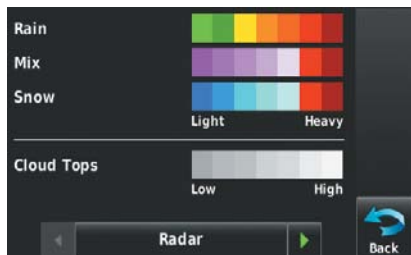

**RADAR Legend**

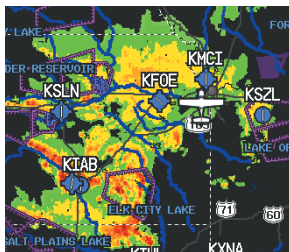

**NEXRAD Data**

## FIS-B RADAR PRODUCTS

FIS-B weather provides two different Radar products, CONUS and Regional. The system can display each individually or a composite (COMBINED). When Regional Radar is displayed, only precipitation for your current region is displayed. The subdued (grayish-purple colored) area represents the area not covered by the regional radar product. When Combined radar data is viewed, Regional Radar data is displayed on top of CONUS data and the time shown in the lower left corner is associated with Regional Radar data only.



**FIS-B Radar CONUS**



**FIS-B Radar Regional**



FIS-B Radar Combined

## WINDS ALOFT

Winds Aloft data shows the forecasted wind speed and direction in 3,000-foot increments up to 39,000 feet MSL.

Winds Aloft are displayed using wind barbs or a wind streamline depending on the selected range. The wind barbs indicate wind speed and direction. The wind streamline indicates wind direction with arrows.

The wind barbs always point in the direction that the wind is coming from. The wind speed is depicted using flags at the end of the wind barb. A short wind flag is 5 knots, a long wind flag is 10 knots, and a triangle flag is 50 knots.



Winds Aloft Data



Winds Aloft Altitudes

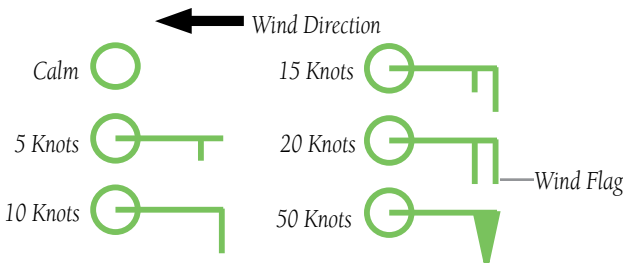

Winds Barbs

## TEMPERATURES ALOFT

Temperature Aloft data shows the forecasted temperatures aloft in 3,000-foot increments up to 39,000 feet MSL. For altitudes 18,000 feet and above the relative ISA temperature is shown. Temperatures are color coded with temperatures near and below freezing are shown as shades of blue, green for temperatures just above freezing and shades of orange are used for warmer temperatures.

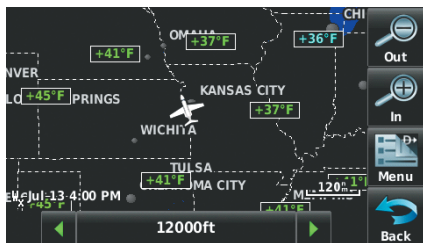

Temperatures Aloft Data



Temperatures Aloft Altitudes

## METARS AND TAFS



**NOTE:** METAR information is only displayed within the installed aviation database service area.

METAR (METeoro logical Aerodrome Report) is an international code used for reporting weather observations. METARs are updated hourly or as needed. METARs typically contain information about the temperature, dewpoint, wind, precipitation, cloud cover, cloud heights, visibility, and barometric pressure. They can also contain information on precipitation amounts, lightning, and other critical data. If METAR data is available for an airport, a color-coded flag is shown next to the airport.

TAF (Terminal Area Forecast) is the standard format for 24-hour weather forecasts. TAFs may contain some of the same code as METAR data. It typically forecasts significant weather changes, temporary changes, probable changes, and expected changes in weather conditions.

An abbreviated version can be viewed by selecting the METAR flag with the map pointer. Touching the Map Feature Button will display additional information. METAR and TAF data can be displayed as raw or decoded text.







Map  
Feature  
Button

### METAR Data (Map)



### Additional METAR Data

The METAR flag color is determined by the information in the METAR text.

-  VFR (ceiling greater than 3000 feet AGL and visibility greater than 5 miles)
-  Marginal VFR (ceiling 1000-3000 feet AGL and/or visibility 3-5 miles)
-  IFR (ceiling 500 to below 1000 feet AGL and/or visibility 1 mile to less than 3 miles)
-  Low IFR (ceiling below 500 feet AGL or visibility less than 1 mile)
-  METAR text does not contain adequate information to determine flight conditions

## AIRMETS

An AIRMET (AIRmen's METeological Information) can be especially helpful for pilots of light aircraft that have limited flight capability or instrumentation. An AIRMET must affect or be forecast to affect an area of at least 3,000 square miles at any one time. AIRMETS are routinely issued for six-hour periods and are amended as necessary due to changing weather conditions. AIRMETS are displayed as colored, dashed lines.

## SIGMETS

A SIGMET (SIGNificant METeological Information) advises of weather that is potentially hazardous to all aircraft. In the contiguous United States, the following items are covered: severe icing, severe or extreme turbulence, volcanic ash, dust storms, and sandstorms that lower visibility to less than three statute miles.

A Convective SIGMET is issued for the following conditions: thunderstorms, isolated severe thunderstorms, embedded thunderstorms, hail at the surface, and tornadoes.

A SIGMET is widespread and must affect or be forecast to affect an area of at least 3,000 square miles. SIGMETs are displayed as a yellow-dashed line.

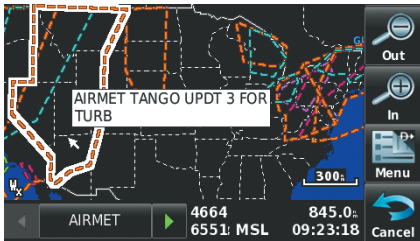

AIRMET Selected

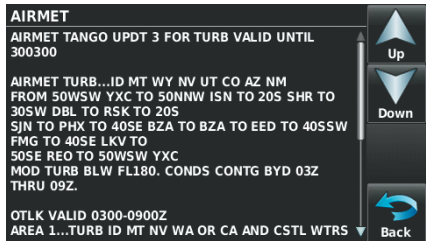

Additional AIRMET Data

## TEMPORARY FLIGHT RESTRICTIONS (TFR)



**NOTE:** Do not rely solely upon data link services to provide Temporary Flight Restriction TFR information. Always confirm TFR information through official sources such as Flight Service Stations of Air Traffic Control.

Temporary Flight Restrictions, or TFRs, temporarily restrict all aircraft from entering the selected airspace unless a waiver has been issued. TFRs are routinely issued for activities such as sporting events, dignitary visits, military depots, and forest fires. TFRs are represented as an area highlighted by red (active) or yellow (not yet active).



TFR Data Selected



Additional TRF Information

### PIREPS

Pilot Weather Reports (PIREPs) provide timely weather information for a particular route of flight. When significant weather conditions are reported or forecast, Air Traffic Control (ATC) facilities are required to solicit PIREPs. A PIREP may contain unforecast adverse weather conditions, such as low in-flight visibility, icing conditions, wind shear, and turbulence. PIREPs are issued as either Routine (UA) (blue) or Urgent (UUA) (yellow).



PIREP Selected

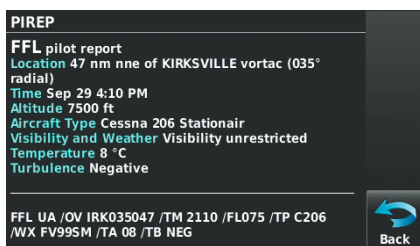

Additional PIREP Data

Map Feature Button

### USING FIS-B WEATHER PRODUCTS



**WARNING:** Do not use data link weather information for maneuvering in, near, or around areas of hazardous weather. Information contained within data link weather products may not accurately depict current weather conditions.



**WARNING:** Do not use the indicated data link weather product age to determine the age of the weather information shown by the datalink weather product. Due to time delays inherent in gathering and processing weather data for data link transmission, the weather information shown by the data link weather product may be significantly older than the indicated weather product age.

FIS-B Weather Products can be displayed on the Map Page and individually on the Weather (WX) Page.

### Switching Weather Sources:

- 1) From the **Main Menu** touch the **Map** Icon.
- 2) Touch the **Weather > Menu > Set Up Weather**.
- 3) Use the  buttons to cycle through the available weather sources (AUTO, XM, or GDL FIS-B).

The setup menu for the Map Page controls the map range settings above which weather products are decluttered from the display. If a map range larger than the weather product map range setting is selected, the weather product data is removed from the map. The menu also provides a means for enabling/disabling display of 'Airmets', 'Sigmet', 'Weather Data', and/or 'NEXRAD' on the Map Page.

Additional information about the following can be displayed by panning over the display on the Weather Page or the Map Page:

- SIGMETs
- METARs
- AIRMETs
- TFRs

Additional information is also available for PIREPs on the Weather Page (not displayed on the Map Page):

### Viewing FIS-B Weather products on the Navigation Map:



- 1) From the **Main Menu** touch the **Map** Icon.
- 2) Touch the **Menu** Icon.
- 3) Touch the '**Show/Hide...**' menu option.
- 4) Touch the **Weather 'Show/Hide'** Button.

### Viewing FIS-B Weather products on the Weather Map:

- 1) From the **Main Menu** touch the **Weather** Icon.
- 2) Touch the desired second-level Weather Icon.
- 3) If necessary, touch the  buttons to scroll through the list of available altitudes, or AIRMET types.
- 4) Touch the desired weather product to get abbreviated information about the selected weather product (if available).
- 5) With the desired weather product highlighted, touch the Map Feature Button to get detailed information (if available).



## Setting up and customizing weather data for the Navigation Map:

- 1) From the **'Home'** Screen touch the **Map** Icon.
- 2) Touch the **Menu** Icon.
- 3) Touch the **'Set Up Map'** menu option.
- 4) Touch the  buttons to select the **'Weather'** Category.
- 5) Touch the desired setting to change.
- 6) Touch the  buttons (if available) to select the desired settings or touch the **On/Off** Button (if available).

## Restoring default weather data for the Navigation Map:

- 1) From the **Main Menu**, touch **Map > Menu > Set Up Map**.
- 2) Touch the  buttons until the **'Weather'** Category is displayed.
- 3) Touch the **Menu** Icon.
- 4) Touch the **'Restore Weather Defaults'** menu option.

## Viewing legends for displayed weather products:

- 1) From the **Main Menu**, touch the **Map** Icon.  
**Or:**
  - a) From the **'Home'** Screen, touch the **Weather** Icon.
  - b) Touch the desired second-level weather icon.
- 2) Press the **Menu** Icon.
- 3) Touch the **'Weather Legend'** menu option.
- 4) If desired, touch the  buttons until the desired legend is displayed.  
**Or:**  
 Touch the **Back** Icon to return to the map.

## Animating FIS-B weather:

- 1) From the **Main Menu**, touch the **Map** Icon (weather must be enabled).  
**Or:**
  - a) From the **Main Menu**, touch the **Weather** Icon.
  - b) Touch the **NEXRAD** Icon.
- 2) Touch the **Menu** Icon.
- 3) Touch the **'Animate Weather'** menu option.

## 4.2 TERRAIN



**WARNING:** Do not use Terrain information for primary terrain avoidance. Terrain information is intended only to enhance situational awareness.



**NOTE:** Terrain data is not displayed when the aircraft latitude is greater than 75° North or 60° South.



**NOTE:** Terrain depicted in the Profile View is always “ahead” of the aircraft, and will change as ground track changes.

The Terrain function displays altitudes of terrain and obstructions relative to the aircraft position and altitude with reference to a database that may contain inaccuracies. Terrain and obstructions are shown only if they are in the database. Terrain and obstacle information should be used as an aid to situational awareness. They should never be used to navigate or maneuver around terrain.

Note that all obstructions may not be available in the terrain and obstacle database. No terrain and obstacle information is shown without a valid 3-D GPS position.

The aera GPS receiver provides the horizontal position and altitude of the aircraft. Aircraft GPS altitude is derived from satellite position. GPS altitude is then converted to a mean sea level (MSL)-based altitude (GPS-MSL altitude) and is used to determine terrain and obstacle proximity. GPS-MSL altitude accuracy is affected by satellite geometry, but is not subject to variations in pressure and temperature that normally affect pressure altitude sensors. GPS-MSL altitude does not require local altimeter settings to determine MSL altitude. It is a widely-used MSL altitude source.

Terrain and obstacle databases are referenced to MSL. Using the GPS position and altitude, the Terrain feature portrays a 2-D picture of the surrounding terrain and obstacles relative to the position and altitude of the aircraft. GPS position and GPS-MSL altitude are used to calculate and predict the aircraft’s flight path in relation to the surrounding terrain and obstacles. In this way, the pilot can view predicted dangerous terrain and obstacle conditions.

Alert windows appear to inform the pilot of proximity to the terrain and obstacles, as well as an unsafe descent rate. These alerts depend on user-defined parameters in the Terrain Setup.

**TERRAIN INFORMATION**











Two views are displayed by the Terrain function: the Map View, and the Profile View. The areas of the terrain shaded red are predicted to be within 100 feet below or above the aircraft. The yellow terrain areas are between the user-defined Caution Elevation and 100 feet below the aircraft. By default, the Caution Elevation is 1,000 feet; therefore, the areas in yellow are between 1,000 feet and 100 feet below the aircraft. The black areas are further than the Caution Elevation. A projected point of impact is marked with an “X” symbol.

**OBSTACLE INFORMATION**

Obstacles are shown on the Terrain Map View, at or below the map range of 12 nm. Obstacles are also shown on the Navigation Map when the map range is set to 5 nm or below.

Standard aeronautical chart symbols are used for lighted or unlighted obstacles taller than 200 feet Above Ground Level (AGL). Refer to the Obstacle Icons legend below.

When selecting an obstacle with the Map Pointer, each obstacle displays the altitude at the top of the obstacle, or Mean Sea Level (MSL). Each obstacle also lists the actual height of the obstacle, or Above Ground Level (AGL).

| Unlighted Obstacle  |   | Lighted Obstacle  |   | Potential Impact Points   | Obstacle Location  |
|---|---|---|---|---|--|
| < 1000' AGL   | > 1000' AGL   | < 1000' AGL   | > 1000' AGL   |   |  |
|  |  |  |  |  | WARNING: Red obstacle is above or within 100' below current aircraft altitude      |
|  |  |  |  |  | CAUTION: Yellow obstacle is between 100' and 1000' below current aircraft altitude |

**Terrain Obstacle Colors and Symbology**

## TERRAIN AND OBSTACLE COLOR CODE

---

Red—terrain or obstacle is above or within 100 feet below the aircraft.

Yellow—terrain or obstacle is between the user-defined Caution Elevation and 100 feet below the aircraft.

### Enabling/Disabling Terrain Shading on the Navigation Map:

- 1) From the **'Home'** Screen touch the **Map** Icon.
  - 2) Touch the **Menu** Icon.
    - a) Touch the **'Show/Hide...'** menu option.
    - b) Touch the **Terrain 'Show/Hide'** Button to toggle the terrain overlay on/off.
- Or:**
- a) Touch the **'Set Up Map'** menu option.
  - b) Touch the  buttons until the **'Map'** Category is displayed.
  - c) Touch the **Terrain Shading** Field.
  - d) Touch the **On/Off** Button.

## TERRAIN VIEWS

---

Three views can be displayed: 'Map with Profile', 'Map Only', and 'Profile Only'.

### Changing the terrain view:

- 1) From the **'Home'** Screen touch the **Terrain** Icon.
- 2) Touch the **Menu** Icon.
- 3) Touch the **'Select Page Layout'** menu option. An option menu is displayed.
- 4) Touch the desired menu option (**'Map with Profile'**, **'Map Only'**, **'Profile Only'**).

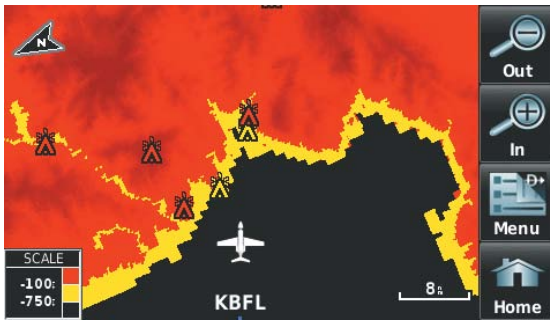
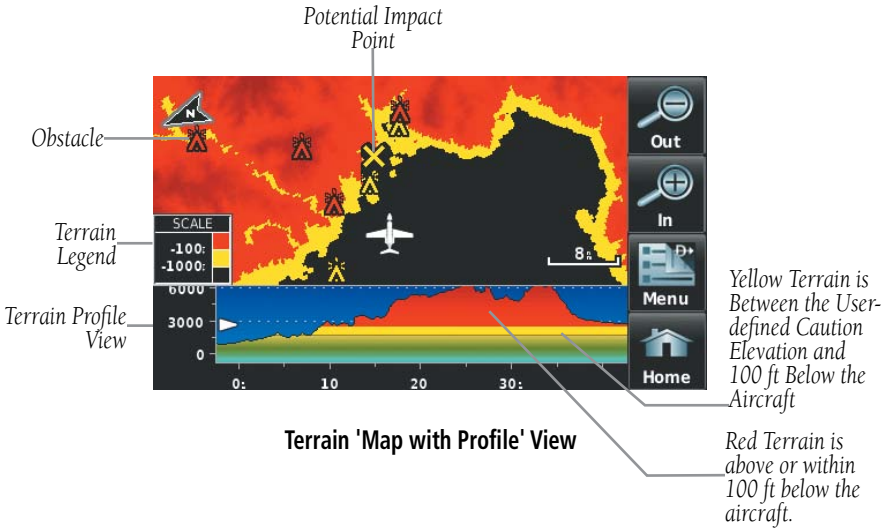

Terrain 'Map Only' View

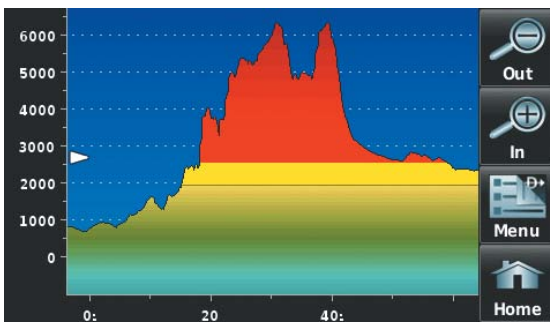

Terrain 'Profile Only' View

## TERRAIN ALERTS & SETUP

### Enabling/Disabling terrain alerts:

- 1) From the **'Home'** Screen touch the **Terrain** Icon.
- 2) Touch the **Menu** Icon.
- 3) Touch the **'Enable Alerts'** or **'Disable Alerts'** menu option.

Use the Terrain Setup Menu to set levels for terrain alerts as well as obstacles in or near your flight path.

- **Caution Elevation**—The aera will provide an alert if the terrain or obstacle is within the default Caution Elevation or user-defined Caution Elevation
- **Look Ahead Time**—Determines the maximum time when an alert annunciation occurs. For example, if 120 seconds is selected, the aera provides an alert up to 120 seconds before you reach the terrain or obstacle
- **Alert Sensitivity**—The three Alert Sensitivity settings (Terrain, Obstacle, and Descent Rate) determine what level of alerts are annunciated. The aera defaults to 'High' sensitivity, which annunciates all red and yellow alerts at the time set in Look Ahead Time. 'Medium' sensitivity annunciates all of the red and the highest priority of yellow alerts. 'Low' only annunciates red alerts. 'Off' disables the alert.

### Accessing terrain/obstacle settings:

- 1) From the **'Home'** Screen touch the **Terrain** Icon.
- 2) Touch the **Menu** Icon.
- 3) Touch the **'Set Up Terrain'** menu option.
- 4) Touch the  buttons to cycle through the list of available settings.

Terrain, Obstacle, and Descent Rate Alerts are issued when flight conditions meet parameters that are set within the software algorithms. Terrain alerts typically employ a CAUTION or a WARNING alert severity level, or both. When an alert is issued, visual annunciations are displayed and aural alerts are simultaneously issued. When the aircraft descends through 500 feet above the destination airport an audible "Five Hundred" altitude reminder occurs.

The Terrain Alert Annunciation is shown to the lower left corner of the screen. If the Terrain Map is not displayed, a pop-up alert appears. The Range Rings on the pop-up alert are spaced every whole mile/kilometer/nautical mile. Touch the Terrain Alert Annunciation to acknowledge the pop-up and/or aural alert.

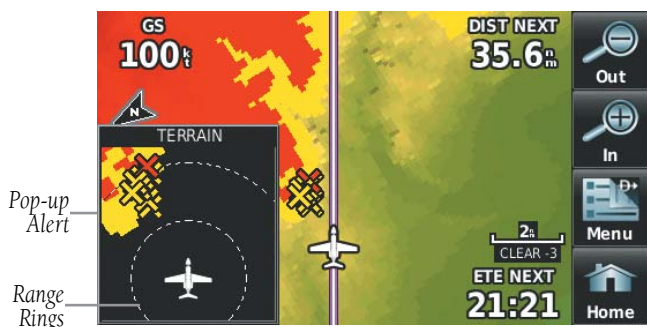

Pop-up Alert (Navigation Map With Terrain Shading)

## AURAL ALERTS

- “Five Hundred”—when the aircraft descends through 500 feet above the destination airport.

The following aural terrain alerts are issued when flight conditions meet parameters that are set within the software algorithms, and are dependant on the sensitivity level set in the Terrain Setup Menu.

| Alert Severity | Terrain  | Obstacle  | Descent Rate                        |
|----------------|--|---|-------------------------------------|
| Caution        | “caution, terrain”<br>“caution, terrain ahead”                     | “caution, obstacle”<br>“caution, obstacle ahead”                      | “caution, sink rate”                |
| Warning        | “terrain ahead! pull up!”<br>“terrain! terrain! pull up! pull up!” | “obstacle ahead! pull up!”<br>“obstacle! obstacle! pull up! pull up!” | “sink rate, pull up!”<br>“pull up!” |

### Aural Alerts Summary

#### Adjusting terrain alert audio:

- 1) From the ‘Home’ Screen, touch **Tools > Setup > Sound**.
- 2) Touch the **Terrain Audio On/Off** Button to toggle the terrain audio on/off, or touch the **Alerts**  Icon to mute both Terrain and TIS alerts.

**Or:**

Touch the **Alerts**  buttons to select an alert volume (0-10).

## 4.3 TRAFFIC

### TRAFFIC INFORMATION SERVICE (TIS-A)





**NOTE:** Refer to Appendix F for general information regarding TIS-A. Refer to Appendix D for configuration information.

The aera supports TIS-A input from a Garmin Mode S transponder, such as the GTX 330.

#### TIS-A SYMBOLOGY

TIS-A traffic is shown according to TCAS symbology, graphically shown on the Navigation Map, and in the Traffic Warning Window. A Traffic Advisory (TA) symbol appears as a solid yellow circle. All other traffic is shown as a hollow white diamond. Altitude deviation from own aircraft altitude is shown above the target symbol if traffic is above own aircraft altitude, and below the symbol if they are below own aircraft altitude. Altitude trend is shown as an up arrow (>+500 ft/min), down arrow (<-500 ft/min), or no symbol if less than 500 ft/min rate in either direction.

| TIS-A Symbol  | Description           |
|---|-----------------------|
|   | Traffic Advisory (TA) |
|  | Other Traffic         |

TIS-A Traffic Symbols

#### TIS-A ALERTS

A TIS-A audio alert is generated whenever the number of Traffic Advisories on the aera screen increases from one scan to the next. Limiting Traffic Advisories only reduces the “nuisance” alerting due to proximate aircraft. For example, when the first Traffic Advisories appear on the TIS-A display, the user is alerted audibly. So long as a single aircraft remains on the TIS-A display, no further audio alert is generated. If a second (or more) aircraft appears on the screen, a new audio alert is sounded.



If the number of Traffic Advisories on the TIS-A display decreases and then increases, a new audio alert is sounded. The TIS-A audio alert is also generated whenever TIS-A service becomes available. The following TIS-A audio alerts are available:

- “Traffic”—TIS-A traffic alert received.
- “Traffic Not Available”—TIS-A service is not available or out of range.

### Adjusting TIS-A audio:

- 1) From the ‘Home’ Screen, touch **Tools > Setup > Sound**.
- 2) Touch the **TIS Audio On/Off** Button to toggle the terrain audio on/off, or touch the **Alerts**  Icon to mute both TIS and Terrain alerts.

**Or:**

Touch the **Alerts**  buttons to select an alert volume (0-10).

## TRAFFIC WARNING WINDOW

When a traffic threat is imminent, the Traffic Warning Window is shown. The Traffic Warning Window shows a small pop-up thumbnail map in the lower left corner. The Range Rings on the pop-up alert are spaced every whole mile/kilometer/nautical mile. Touch the Traffic Warning Window to acknowledge and remove it.



**NOTE:** The Traffic Warning Window is disabled when the aircraft ground speed is less than 30 knots or when on the approach leg of a route.

## TRAFFIC GROUND TRACK

Traffic ground track is indicated on the aera screen by a “target track vector”, a short line shown in 45-degree increments, extending in the direction of target movement.

## DISPLAYING TRAFFIC DATA

TIS-A traffic can be displayed on the Navigation Map.

### Adjusting TIS-A settings on the navigation map:

- 1) From the ‘Home’ Screen, touch **Map > Menu > Set Up Map**.
- 2) Touch the  buttons to select the **Map** Category.

- 3) Touch **TIS-A Traffic**.
- 4) Touch the buttons to select the desired settings ('Off', 'Auto', or range settings).

### Displaying TIS-A information using the map pointer:

With traffic displayed on the Navigation Map, touch the desired TIS-A symbol on the map. The traffic range and altitude separation is displayed.

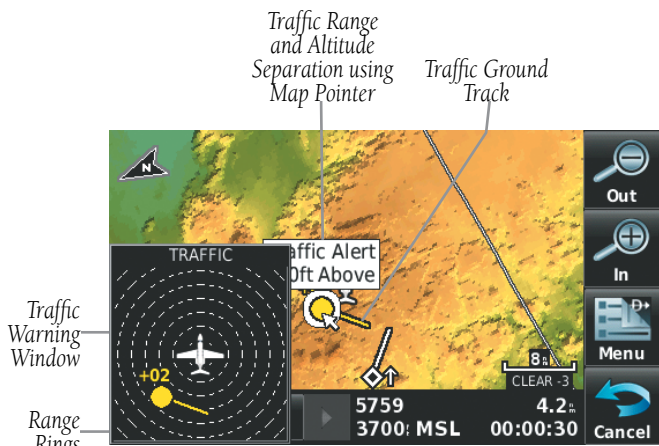

TIS-A (Navigation Map)

## DATA LINK TRAFFIC (GDL 39)

The GDL 39 is a receive-only data link radio with on-board GPS, 978 MHz (Universal Access Transceiver frequency band), and 1090 MHz Extended Squitter (1090 ES) receivers. It is designed to receive, process, and output traffic (ADS-B air-to-air, and TIS-B traffic information), and weather (Flight Information Service-Broadcast (FIS-B)) information to the aera through a power/data cable.

ADS-B (Automatic Dependent Surveillance-Broadcast) is a surveillance technology deployed across the United States as the cornerstone of the FAA’s Next Generation Air Transportation System (NextGen). ADS-B enables improved surveillance services, both air-to-air and air-to-ground, especially in areas where radar is ineffective due to terrain or where it is impractical or cost prohibitive. Initial applications of air-to-air ADS-B are for “advisory” use only, enhancing a pilot’s visual acquisition of other nearby ADS-B equipped aircraft either when airborne or on the airport surface.

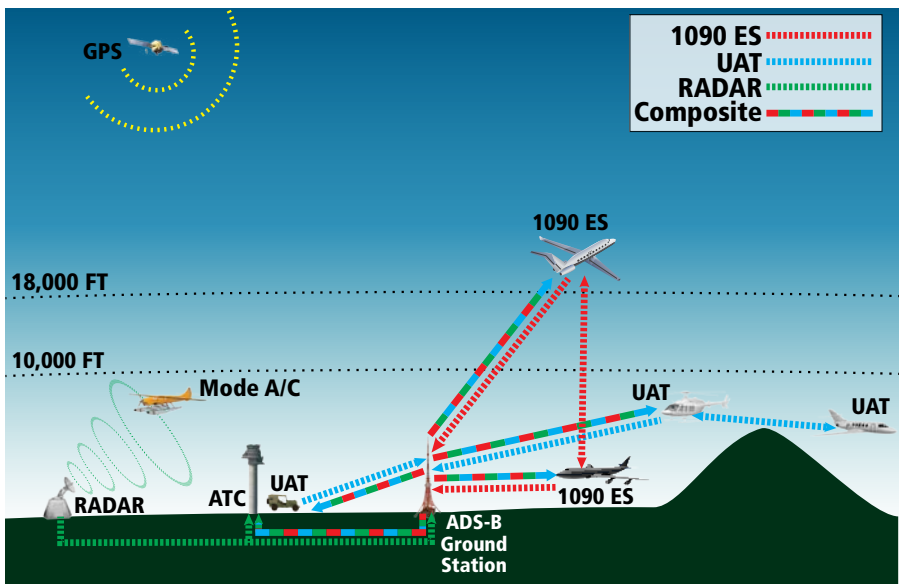

ADS-B System

For the purpose of distinguishing between levels of ADS-B service, there are three classifications of aircraft or system capability; ADS-B In, ADS-B Out, and ADS-B participating. ADS-B In refers to the capability to receive ADS-B information. ADS-B

Out refers to the capability to transmit ADS-B information. ADS-B participating refers to the capability to both send and receive ADS-B information. Aircraft lacking either ADS-In, ADS-B Out, or both ADS-B capabilities may also be referred to as ADS-B non-participating aircraft.

Currently, rule-compliant ADS-B Out capability in the United States requires a TSO'ed SBAS-enabled GPS, such as a Garmin GPS 400W or similar, and one of two possible data links: 1090 ES transponder or a 978 MHz UAT. Either data link system is capable of transmitting the aircraft's position, velocity, identification, and other information every second to compatible aircraft and ground stations called Ground Based Transceivers (GBTs).

Because 1090 ES transponders and UATs operate on different frequencies, aircraft not similarly equipped cannot transmit/receive data link information directly to/from each other. Instead, operation within range of a GBT is required to receive data link information on both frequencies. The GDL 39 is unique in its ADS-B In capability since it can receive data link information from both 1090 ES transponders and UATs.

Thus, the GDL 39 receives traffic information directly from any ADS-B Out aircraft within range as well as the rebroadcast of ADS-B information from any nearby GBT. This rebroadcast is called Automatic Dependent Surveillance-Rebroadcast (ADS-R) and is automatically triggered by the detection of an ADS-B participating aircraft within the service volume of the GBT. As a 978 MHz (UAT frequency) receiver, the GDL 39 can receive both the Traffic Information Service-Broadcast (TIS-B) and Flight Information Service-Broadcast (FIS-B) provided in conjunction with ADS-R services when in range of a GBT.

FIS-B service is provided continuously, but ADS-R including TIS-B will only be broadcast by a GBT when an ADS-B participating aircraft is within the GBT's defined service volume. In this case, a GBT will only rebroadcast TIS-B information relative to the ADS-B participating aircraft. **Only traffic that is within 15 nm lateral and 3,500' vertical of the ADS-B participating aircraft is provided in the broadcast.** Non-participating traffic aircraft located farther than 15 nm laterally and 3,500' vertically from the participating aircraft is are excluded from the information transmitted by the GBT.

TIS-B traffic information includes non-participating aircraft detected by ATC surveillance radar. As TIS-B data is derived from ATC surveillance radar data, TIS-B

traffic position updates typically occur every three to thirteen seconds. **Therefore, TIS-B traffic may be displayed with degraded positional accuracy. Aircraft without operating transponders are invisible to TIS-B. Aircraft operating outside of the ATC radar coverage area are also not displayed.**

Since the GDL 39 is a receive-only device, even when used onboard an aircraft equipped with a qualifying GPS and 1090 ES transponder, a GBT may not identify it as an ADS-B participating aircraft. The squitter of some 1090 ES transponders, including the Garmin GTX 23ES, must be configured to communicate that the aircraft has 978 MHz receive capability in order to be identified as an ADS-B participating aircraft.



**WARNING:** Do not rely solely upon the display of traffic information for collision avoidance maneuvering. The traffic display does not provide collision avoidance resolution advisories and does not under any circumstances or conditions relieve the pilot's responsibility to see and avoid other aircraft.











**WARNING:** Do not rely solely upon the display of traffic information to accurately depict all of the traffic within range of the aircraft. Due to lack of equipment, poor signal reception, and/or inaccurate information from aircraft or ground stations, traffic may be present that is not represented on the display.

### Viewing GDL 39 Traffic and Weather Status:

- 1) From the **Main Menu** touch the **Tools** Icon.
  - 2) Touch **Data Link > Menu > FIS-B Weather**.
- Or**
- 1) From the **Main Menu** touch the **Weather** Icon.
  - 2) Touch **Menu > Information**.
- Or**
- 1) From the **Main Menu** touch the **Traffic** Icon.
  - 2) Touch **Menu > Info**.

### SYSTEM STATUS

The traffic system status is annunciated in the upper right corner of the Map Page, as well as the bottom of the dedicated Traffic Page.

| System Status  | Traffic Icon   |
|--|--|
| Operating TIS-A  |   |
| No Traffic Data Available from TIS-A   |   |
| Full traffic services available for an ADS-B participating aircraft (ground linked TIS-B, FIS-B and ADS-R, and Air-to-Air ADS-B). If you are using the GDL 39 on a non-participating aircraft you may still see this when you are within the service area of any participating aircraft. As a non-participating aircraft you are only receiving TIS-B traffic information for traffic within 15 nm and 3,500' of the participating aircraft. | <br>     |
| Limited traffic services available (may be limited to Air-to-Air ADS-B)  | <br>  |
| No Traffic Data Available  | <br> |

### Traffic Modes

The GDL 39 also has a pressure altitude sensor to aid in displaying the relative altitude of received traffic information. If the GDL 39 is used onboard a pressurized aircraft, the pressure altitude sensor should be turned off.

## Configuring the GDL 39 for a Pressurized or Non-Pressurized Aircraft:





- 1) From the **Main Menu** touch the **Tools** Icon.
- 2) From the **Tools** menu touch **Data Link**.
- 3) Touch **Menu > Set Up Data Link**.
- 4) Touch **Aircraft Type** (Pressurized or Not Pressurized)

Or:

- 1) From the **Main Menu** touch the **Traffic** Icon.
- 2) Touch **Menu > Info > Menu > Set Up Data Link**.
- 3) Touch **Aircraft Type** (Pressurized or Not Pressurized)

## TRAFFIC DESCRIPTION

ADS-B traffic operation is similar to TIS-A discussed previously, but ADS-B adds additional symbology and capabilities. The symbols used to display ADS-B traffic are shown in the table below. The traffic identifier and altitude are displayed below the traffic symbol. A small up or down arrow next to the traffic symbol indicates that the traffic is climbing or descending at a rate of at least 500 feet per minute. The vector line that extends from the traffic symbol is just further indication of the intruder aircraft track.

| Symbol  | Description  |
|---|--|
|  | Non-threat, non-directional airborne traffic   |
|  | Non-threat directional airborne Traffic with track vector. Points in the direction of the aircraft track.  |
|  | Non-directional airborne Proximity Advisory (PA). Proximity Advisories are issued for any traffic within 6 nautical miles and +/- 1,200'.  |
|  | Directional airborne Proximity Advisory (PA) with track vector. Points in the direction of the aircraft track. Proximity Advisories are issued for any traffic within 6 nautical miles and +/- 1,200'. |

|   |   |
|---|---|
|   | Non-directional airborne Traffic Advisory (TA)  |
|   | Non-directional off-scale airborne Traffic Advisory (TA). Displayed at outer range ring at proper bearing.                                    |
|   | Directional airborne Traffic Advisory (TA) with track vector. Points in the direction of the aircraft track.                                  |
|   | Directional off-scale airborne Traffic Advisory (TA). Points in the direction of the aircraft track.  |
|   | *Ground traffic without directional information. Ground traffic is only displayed when own aircraft is below 1,500 feet AGL or on the ground. |
|   | *Directional surface traffic. Ground traffic is only displayed when own aircraft is below 1,500 feet AGL or on the ground.                    |
|   | *Non-directional non-aircraft ground traffic. Ground traffic is only displayed when own aircraft is below 1,500 feet AGL or on the ground.    |
|   | *Directional non-aircraft ground traffic. Ground traffic is only displayed when own aircraft is below 1,500 feet AGL or on the ground.        |
| *Ground traffic is only displayed on the Map Page when the aircraft is on the ground or below 1,500 feet AGL. Ground traffic is always displayed on the dedicated traffic page. |   |

## ADS-B Traffic Symbology

### TRAFFIC ADVISORIES (TA)

The GDL 39 automatically adjusts its Traffic Advisory (TA) sensitivity level to reduce the likelihood of nuisance TA alerts during various phases of flight. TAs are issued for traffic when they are predicted to be within a specified volume of airspace around your aircraft in a specified amount of time. The protected volume and time interval varies based on the current geodetic altitude and groundspeed. Thus, the protected volume of airspace increases with altitude and ground speed. Refer to the following table for details.

| Altitude (Geodetic) | Look Ahead Time (sec.) | Vertical Separation (ft.) | Horizontal Separation (nm.) |
|---------------------|------------------------|---------------------------|-----------------------------|
| Below 5,000         | 30                     | +/-850                    | .35                         |
| 5,000-10,000        | 40                     | +/-850                    | .55                         |



| Altitude (Geodetic) | Look Ahead Time (sec.) | Vertical Separation (ft.) | Horizontal Separation (nm.) |
|---------------------|------------------------|---------------------------|-----------------------------|
| 10,000-20,000       | 45                     | +/-850                    | .80                         |
| 20,000-42,000       | 48                     | +/-850                    | 1.10                        |
| Above 42,000        | 48                     | +/-1,200                  | 1.10                        |

### Traffic Advisories

## TRAFFIC ALERTS (ADS-B TIS-B)

A traffic audio alert is generated whenever the number of Traffic Advisories on the aera display increases. Limiting Traffic Advisories only reduces the “nuisance” alerting due to proximate aircraft. For example, when the first Traffic Advisories appear on the display, the user is alerted audibly. So long as a single aircraft remains on the display, no further audio alert is generated. If a second (or more) aircraft appears on the screen, a new audio alert is sounded. Traffic Advisories can only be issued when the GDL 39 knows its own altitude and the altitude of the intruder aircraft.

If the number of Traffic Advisories on the traffic display decreases and then increases, a new audio alert is sounded. The traffic audio alert is also generated whenever TIS-B service becomes available. The following traffic audio alerts are available:

- “Traffic”—TIS-B/ADS-B traffic alert received.
- “Traffic Not Available”—TIS-B/ADS-B service is not available or out of range.

### Disabling/Enabling the traffic alerts:



**NOTE:** Traffic alerts are reset to ‘enabled’ on the next power cycle.

- 1) From the **Main Menu**, touch **Traffic**.
- 2) Touch **Menu > Disable/Enable Alerts**.

### Adjusting alert volume:

- 1) From the **Main Menu**, touch **Tools > Setup > Sound**.
- 2) Touch the **TIS Audio On/Off** Button to toggle the Traffic audio on/off, or touch the **Alerts**  Icon to mute both TIS and Terrain alerts.

**Or:**

Touch the **Alerts**  buttons to select an alert volume (0-10).

## TRAFFIC WARNING WINDOW

The Traffic Warning Window is shown, when the GDL 39 issues a traffic advisory (TA). The Traffic Warning Window shows a small pop-up thumbnail map in the lower left corner. The Range Rings on the pop-up alert are spaced every whole mile/kilometer/ nautical mile. Touch the Traffic Warning Window to acknowledge and remove it.

## DISPLAYING TRAFFIC DATA

Traffic is displayed by default on the Map Page and the Traffic Warning Window.

### Enabling/disabling traffic data on the Map Page:

- 1) From the **Main Menu** touch the **Map** Icon.
- 2) Touch the **Menu** Icon.
- 3) Touch the '**Set Up Map**' menu option.
- 4) Touch the buttons to select the **Map** Category.
- 5) Touch Traffic, touch the buttons to select the desired settings ('Off', 'Auto', or range settings).

### Displaying Traffic information using the map pointer:

With traffic displayed on the Navigation Map, touch the desired Traffic symbol on the map. The traffic range and altitude separation is displayed.

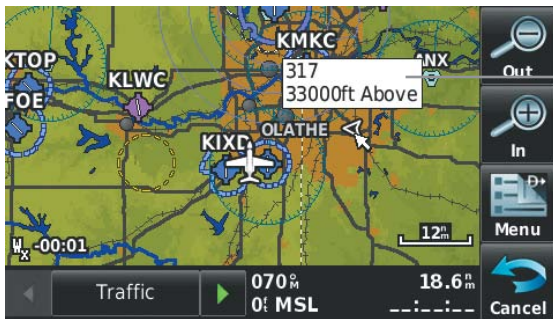

*Traffic Identification and Altitude*

Traffic Data (Navigation Map)

## DEDICATED TRAFFIC PAGE (TRF)

### Viewing the Traffic Page:

- 1) From the **Main Menu** touch the **Traffic** Icon.

## FLIGHT ID DISPLAY AND GROUND TRACK

The Flight IDs of other aircraft (when available) can be enabled for display on the Traffic Page. When a flight ID is received, it will appear above or below the corresponding traffic symbol on the Traffic Page when this option is enabled. Traffic ground track is indicated on the aera display by a “target track vector,” a short line shown in 45-degree increments, extending in the direction of target movement.

### Enabling/Disabling Flight ID Display:

On the Traffic Page, select **Menu > Disable/Enable Target Identifiers**.



**Example ADS-B Traffic Symbol**

## Changing the altitude range:

- 1) On the Traffic Page, select the **Menu > Altitude Filter**.
- 2) Select one of the following:
  - **Unrestricted:** All traffic is displayed.
  - **Normal:** Displays non-threat and proximity traffic from 2700 feet above the aircraft to 2700 feet below the aircraft. Typically used during enroute phase of flight.
  - **Above:** Displays non-threat and proximity traffic from 9000 feet above the aircraft to 2700 feet below the aircraft. Typically used during climb phase of flight.
  - **Below:** Displays non-threat and proximity traffic from 2700 feet above the aircraft to 9000 feet below the aircraft. Typically used during descent phase of flight.

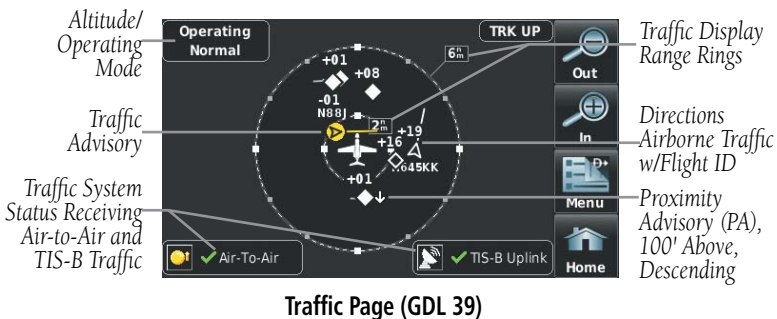

Traffic Page (GDL 39)

## SECTION 5 ADDITIONAL FEATURES



**NOTE:** With the availability of SafeTaxi in electronic form, it is still advisable to carry another source of charts on board the aircraft.

The following additional features are included with the aera depending on the unit.

| Additional Features    | aera     |          |         |          |          |          |         |          |
|------------------------|----------|----------|---------|----------|----------|----------|---------|----------|
|                        | 500      |          |         | 510      | 550      |          |         | 560      |
|                        | Americas | Atlantic | Pacific | Americas | Americas | Atlantic | Pacific | Americas |
| AOPA Airport Directory |          |          |         |          | +        |          |         | +        |
| SafeTaxi®              |          |          |         |          | +        |          |         | +        |
| XM®                    |          |          |         | +        |          |          |         | +        |

aera 500/510/550/560 Additional Features

### 5.1 SAFETAXI

SafeTaxi is an enhanced feature that gives greater map detail when viewing airports at close range. When viewing at ranges close enough to show the airport detail, the map reveals taxiways with identifying letters/numbers, runway incursion “Hot Spot”, and airport landmarks including ramps, buildings, control towers, and other prominent features. Resolution is greater at lower map ranges. The SafeTaxi feature can be seen on the Navigation Map or from the Waypoint Information Runway Tab.

Designated Hot Spots are recognized at airports with many intersecting taxiways and runways, and/or complex ramp areas. Airport Hot Spots are outlined to caution pilots of areas on an airport surface where positional awareness confusion or runway incursions happen most often. Hot Spots are defined by a red shaded area.

During ground operations the aircraft’s position is displayed in reference to taxiways, runways, and airport features. When panning over the airport, features such as runway holding lines and taxiways are shown at the cursor.



SafeTaxi Depiction

### Enabling/disabling SafeTaxi:

- 1) From the 'Home' Screen, touch **Map** > **Menu** > **Set Up Map**.
- 2) Touch the  buttons to display the 'Airport' Category.
- 3) Touch **SafeTaxi**.
- 4) Touch the **On/Off** Button.

## SAFETAXI CYCLE NUMBER AND REVISION

SafeTaxi database is revised every 56 days. SafeTaxi is always available for use after the expiration date. When turning on the aera, the database initialization indicates whether the databases are current, out of date, or not available. The database initialization shows the SafeTaxi database is current when the SafeTaxi name and expiration date are shown in white. When the SafeTaxi cycle has expired, the SafeTaxi name and expiration date will appear in yellow.

The SafeTaxi Region, Cycle, Effective date and Expiration date of the database cycle can also be found from the 'Home' Screen, by touching the **Tools** > **Database**.

The SafeTaxi database is provided by Garmin. Refer to Appendix C for instructions on updating the SafeTaxi database.

## 5.2 AIRPORT DIRECTORY DATA





The Airport Directory contains airport statistics such as pattern altitudes, noise abatement information, FBO phone numbers, hours of operation, local attractions, ground transportation, lodging, and services.

The AOPA Airport Directory (Aera 510 & 560 Only) provides data on airports and heliports throughout the U.S. and it is updated on a 56-day cycle. Detailed information for over 5,300 U.S. airports, along with the names and phone numbers of thousands of FBOs can be viewed. This service allows the pilot to plan an overnight, choose fuel stops, find ground transportation, etc.

Optional airport directory databases such as AC-U-KWIK are also supported. AC-U-KWIK provides complete listings of FBOs, charter companies, fuel suppliers, ground transportation, maintenance and catering services at public airports across the world.

If the AOPA database is in use, the **AOPA** Tab is displayed on the Waypoint (WPT) Page. If another airport directory database is in use, such as AC-U-KWIK, the **DIRECTORY** Tab is displayed on the Waypoint (WPT) Page.

### Viewing AOPA Airport Directory information:

- 1) From the 'Home' Screen, touch **WPT Info** > **AOPA/DIRECTORY** Tab.
  - 2) Touch the Waypoint Identifier Button.
  - 3) Enter the desired waypoint:
    - a) Touch the   buttons to 'Search by Identifier', 'Search by Facility Name', or 'Search by City' using the keypad.
    - b) Enter the desired waypoint.
    - c) Touch the **OK** Icon.
  - Or:**
    - a) Touch the   buttons to cycle through the waypoint categories ('Flight Plan Waypoints', 'Nearest Airports', or 'Recent Waypoints'.)
    - b) Touch the desired waypoint from the list.
  - 4) If duplicate entries exist for the entered facility name or location, duplicate waypoints are displayed. Touch the desired waypoint from the list.
- Or:**

- 1) From any map highlight an airport using the Map Pointer.
- 2) Touch the Map Feature Button.
- 3) Touch the **AOPA/DIRECTORY** Tab (if necessary).

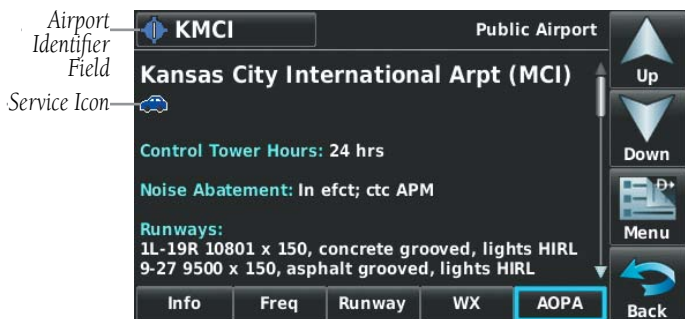

**Airport Directory Data**

| Icon | Description         |
|------|---------------------|
|      | Restaurant on Field |
|      | Self Serve Fuel     |
|      | Courtesy Car        |

**Airport Directory Service Icons**



## 5.3 XM® RADIO (aera 510 & 560)



**NOTE:** XM Satellite Radio is only available with the aera 510 and 560.



**NOTE:** Refer to the Hazard Avoidance Section for information about XM Weather products.



**NOTE:** You **MUST** have a GXM 40 smart antenna connected to your aera 510 or aera 560 and a subscription to XM Radio to use XM Radio features.



**NOTE:** Audio interference can occur while using some audio panels. Use of a Ground Loop Isolator can eliminate this interference.

XM Satellite Radio offers a variety of radio programming over long distances without having to constantly search for new stations. Based on signals from satellites, coverage far exceeds land-based transmissions. XM Satellite Radio services are subscription-based.

### Accessing XM Radio:

From the 'Home' Screen, touch the **XM Radio** Icon.



— XM Radio Icon

### Accessing XM Radio

## ACTIVATING XM SATELLITE RADIO SERVICES

The service is activated by providing XM Satellite Radio with a coded ID (Radio ID). XM Satellite Radio uses the Radio ID to send an activation signal that, when received by the GXM 40, allows it to play entertainment programming.

Refer to the GXM 40 Owner’s Manual for more information on activating XM Satellite Radio.

### Accessing the Radio ID:

From the ‘Home’ Screen, touch **XM Radio > Menu > Information**. The Radio ID is also available from the XM Weather Option Menu.



Accessing the XM Radio ID

Or:

The Radio ID is also displayed on channel ‘0’. Channel ‘0’ is the first channel listed in the ‘All Channels’ Category.

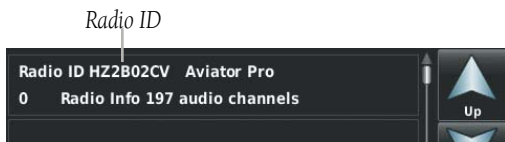

Accessing the XM Radio ID (Channel ‘0’)

## USING XM RADIO

The XM Radio function provides information and control of the audio entertainment features of the XM Satellite Radio.



## CATEGORY

The Category Field cycles through a horizontal list of categories such as jazz, rock, or news.

### Selecting a category:

- 1) From the 'Home' Screen touch the **XM Radio** Icon.
- 2) Touch the ◀▶ buttons to cycle through the horizontal category list. The list automatically refreshes with the selected category.



Category Navigation

### 'Favorites' category shortcut:

Touch and hold the **Category** Button to view the 'Favorites' Category.



'Favorites' Category Shortcut

## ACTIVE CHANNEL AND CHANNEL LIST

The Channel List shows a list of the available channels for the selected category. The active channel is outlined blue (in the Channel List) and displayed below the Channel List.



Active Channel

### Selecting a channel from the channel list:

- 1) Scroll through the Channel List by touching and dragging the list up/down or using the **Up/Down** icons.
- 2) Touch the desired channel. The channel is outlined blue to show it is the active channel.

### Entering a channel number:

- 1) From the 'Home' Screen, touch **XM Radio** > **Menu** > **Enter Channel**.

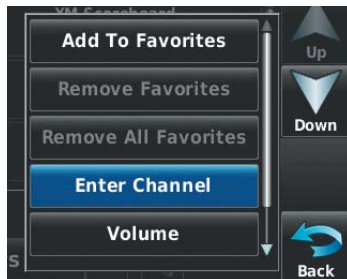

XM Radio Option Menu

- 2) Touch the '+' or '-'.



**Increase/Decrease Channel Number**

**Or:**

- a) Touch the Number Field to activate the keypad function.



**Activate Keypad**

- b) Touch the desired numbers on the keypad and touch the **OK** Icon.

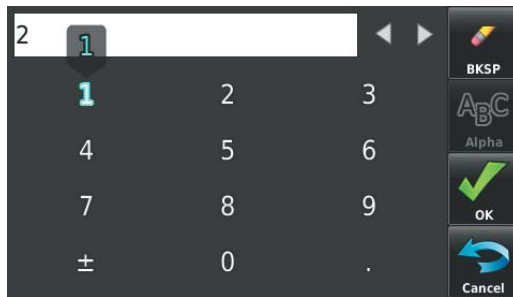

**Keypad Function**

- 3) Touch the **OK** Icon or the **Cancel** Icon to return to the Channel List. If the selected channel is unavailable or off air, the **OK** Icon is subdued.

## USING FAVORITES

Favorites is a customized category of up to 30 of your XM Radio favorites.

### To add a channel to Favorites:

- 1) From the 'Home' Screen touch the **XM Radio** Icon.
- 2) Touch and hold the desired channel. A confirmation window is displayed.
- 3) Touch **Yes**.

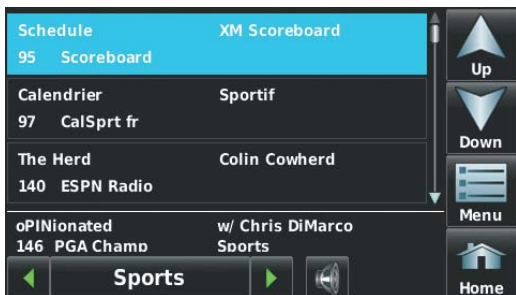

Channel Selected

Or:

With the desired channel selected, touch the **Menu** Icon and touch the **'Add To Favorites'** Menu Option. A confirmation window is displayed.

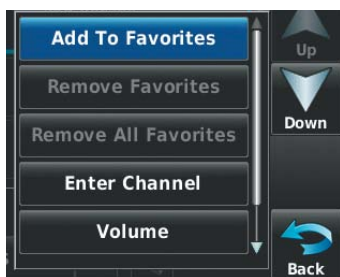

XM Radio Option Menu

- 4) Touch **Yes**. The channel is added to the **'Favorites'** Category.

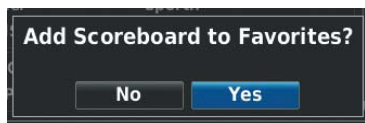

Add Favorites Window

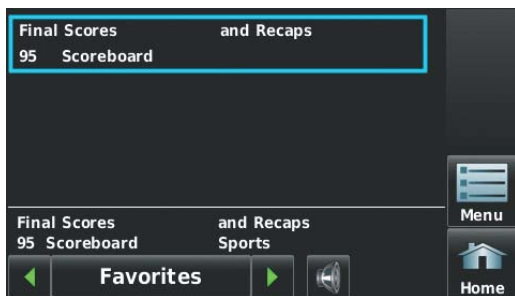

Channel Added to 'Favorites' Category

**Selecting Favorites:**

- 1) From the 'Home' Screen touch the **XM Radio** Icon.
- 2) Touch the  buttons to cycle through the horizontal category list until the 'Favorites' Category is displayed.

**Or:**

Touch and hold the **Category** Button.

- 3) Scroll through the Channel List by touching and dragging the list up/down or using the **Up/Down** Icons.
- 4) Touch the desired channel.

**To delete channel(s) from Favorites:**

- 1) With the Favorites channel selected, touch the **Menu** Key.
- 2) Touch the '**Remove Favorites**' Menu Option.

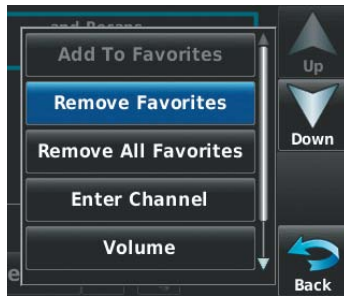

**Favorites Category Option Menu**

**Or:**

Touch the '**Remove All Favorites**' Menu Option and skip to step 5. The 'Remove all favorites?' Window is displayed.

- 3) Touch the check box next to the channel to be deleted. A red x will appear in the box.



**Delete Channel Checkbox**

- 4) Touch **Remove**. The 'Remove selected favorites?' Window is displayed.

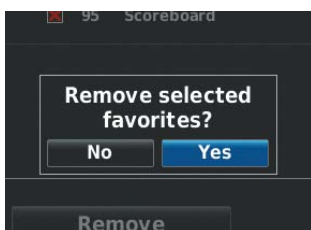

Remove Favorites Window

- 5) Touch **Yes**. The channels are removed from the **'Favorites'** Category.

## VOLUME

Volume is broken down into 'Master', 'Alerts', and 'Media'. The 'Master' volume controls all sound. The 'Alerts' volume refers to system alerts (TIS, Terrain), and the 'Media' volume refers to XM radio volume.

### Adjusting the volume:

- 1) From the **'Home'** Screen touch the **XM Radio** Icon.
- 2) Touch the **Menu** Icon.
- 3) Touch the **'Volume'** Menu Option.



XM Radio Option Menu

- 4) Touch the buttons to increase/decrease the volume.



Increase/Decrease Volume



**Or:**

Touch the Volume Number Field and touch the desired number in the vertical list. The current volume will have a green checkmark next to it.



**Volume Number Field Selected**



**Volume Number List**

### Muting XM Audio:

- 1) From the 'Home' Screen, touch the **XM Radio** Icon.
- 2) Touch the  Icon.

**Or:**

- a) Touch the **Menu** Icon.
- b) Touch the '**Volume**' menu option. 'Sound Setup' is displayed.
- c) Touch the **Media**  Icon.

Overview

GPS Navigation

Flight Planning

Hazard Avoidance

**Additional Features**

Appendices

Index

Blank Page

## SECTION 6 APPENDICES

# APPENDIX A: MESSAGES, ALERTS & DATA FIELD OPTIONS

### MISCELLANEOUS MESSAGE ADVISORIES

| Message                            | Comments  |
|------------------------------------|---|
| <b>Approaching Target Altitude</b> | Within 200 feet of final VNAV target altitude.  |
| <b>Approaching VNAV Profile</b>    | The aircraft is within one minute of reaching the initial VNAV decent point.  |
| <b>Arriving at XXX</b>             | The aircraft is nearing the destination.  |
| <b>Battery Low</b>                 | The battery needs to be recharged.  |
| <b>Can't Unlock Maps</b>           | No applicable unlock code for one or more maps was found. All MapSource maps are not accessible.                              |
| <b>Check XM Antenna</b>            | Internal problem with the GXM antenna. Contact Garmin Product Support.  |
| <b>Database Error</b>              | Internal problem with the system. Contact your dealer or Garmin Product Support to have the unit repaired.                    |
| <b>Fuel Tank</b>                   | A reminder for switching fuel tanks. The reminder message repeats at the specified interval after the beginning of each trip. |
| <b>Lost Satellite Reception</b>    | The system is unable to receive satellite signals.  |
| <b>Memory Full</b>                 | System memory is full, no further data can be saved.  |
| <b>Near Proximity Point</b>        | You have reached the distance set for a proximity waypoint.   |
| <b>Next DTK XXX</b>                | The aircraft is nearing a turn in a route.  |
| <b>Proximity Memory Full</b>       | No additional proximity waypoints can be saved.   |
| <b>Proximity Radius Overlaps</b>   | The radius of two proximity waypoints overlap.  |
| <b>Route Already Exists</b>        | A route name that already exists has been entered.  |

## MISCELLANEOUS MESSAGE ADVISORIES (CONT.)

| Message                           | Comments  |
|-----------------------------------|---|
| <b>Route Memory Full</b>          | No additional routes can be saved.  |
| <b>Route Truncated</b>            | Uploaded route from another device has more than 300 waypoints.   |
| <b>Route Waypoint Memory Full</b> | No additional route waypoints can be saved.   |
| <b>Steep Turn Ahead</b>           | Approaching a turn that requires a bank angle in excess of 25 degrees to stay on course.  |
| <b>Track Already Exists</b>       | A saved track with the same name already exists.  |
| <b>Track Log Full</b>             | The track log is full and track recording was turned off. To record more track points, you need to clear the track log and turn track recording on. |
| <b>Track Memory Full</b>          | No more track data can be stored. Delete the old track data to store the new data.  |
| <b>Track Truncated</b>            | A complete uploaded track will not fit in memory. The oldest track log points have been deleted.  |
| <b>VNAV Cancelled</b>             | VNAV function has been cancelled due to a change in the active route.   |
| <b>Waypoint Already Exists</b>    | A waypoint with the same name already exists.   |
| <b>Waypoint Memory Full</b>       | The unit has stored the maximum number of waypoints.  |

## AIRSPACE MESSAGES

| Message                                  | Comments  |
|--|---|
| <b>Inside Airspace</b>                   | Inside the boundaries of the airspace.  |
| <b>Airspace Near and Ahead</b>           | Within two nautical miles of an airspace and your current course takes you inside the airspace. |
| <b>Airspace Ahead, Within 10 Minutes</b> | The projected course takes you inside an airspace within the next 10 minutes or less.           |
| <b>Airspace Near, Within 2 nm</b>        | Within two nautical miles of an airspace but not projected to enter it.                         |

## DATA FIELD & NUMERIC DATA OPTIONS

| Data Field/Numeric Data       | Definition  |
|-------------------------------|---|
| <b>Accuracy</b>               | The current accuracy of the GPS determined location.  |
| <b>Altitude</b>               | The current altitude in geometric height above Mean Sea Level (MSL).  |
| <b>Bearing</b>                | The compass direction from the present position to a destination waypoint.  |
| <b>Course to Steer</b>        | The recommended direction to steer in order to reduce cross-track error and return to the course line.                      |
| <b>Crosstrack Error</b>       | The distance the aircraft is off a desired course in either direction, left or right.                                       |
| <b>Desired Track</b>          | The desired course between the active "from" and "to" waypoints.  |
| <b>Distance (Destination)</b> | The distance to the destination waypoint in the Active Flight Plan  |
| <b>Distance (Next)</b>        | The distance to the next waypoint in the Active Flight Plan.  |
| <b>En Route Safe Altitude</b> | The recommended minimum altitude within ten miles left or right of the desired course on a active flight plan or direct-to. |

## DATA FIELD & NUMERIC DATA OPTIONS (CONT.)

| Data Field/Numeric Data                        | Definition  |
|--|---|
| <b>Flight Timer</b>                            | Total time in-flight (HH:MM).   |
| <b>Fuel Timer</b>                              | Elapsed time since the Fuel Tank Reminder Alarm was last issued (HH:MM).  |
| <b>Glide Ratio</b>                             | The estimated distance an aircraft will move forward for any given amount of lost altitude.                               |
| <b>Ground Speed</b>                            | The velocity that the aircraft is traveling relative to a ground position.  |
| <b>Ground Track</b>                            | The direction of aircraft movement relative to a ground position.   |
| <b>Minimum Safe Altitude</b>                   | Uses Grid MORAs to determine a safe altitude within ten miles of the aircraft's present position.                         |
| <b>Next Waypoint</b>                           | The next waypoint in the flight plan or direct-to route.  |
| <b>Sunrise</b>                                 | The time at which the sun rises on this day (current location).   |
| <b>Sunset</b>                                  | The time at which the sun sets on this day (current location).  |
| <b>Estimated Time En Route (Destination)</b>   | The estimated time it takes to reach the destination waypoint from the present position, based upon current ground speed. |
| <b>Estimated Time En Route (Next)</b>          | The estimated time it takes to reach the next waypoint from the present position, based upon current ground speed.        |
| <b>Estimated Time of Arrival (Destination)</b> | The estimated time at which the aircraft should reach the destination waypoint, based upon current speed and track.       |
| <b>Estimated Time of Arrival (Next)</b>        | The estimated time at which the aircraft should reach the next waypoint, based upon current speed and track.              |
| <b>Estimated Time to VNAV</b>                  | The estimated time it takes to reach the VNAV waypoint from the present position, based upon current ground speed.        |

**DATA FIELD & NUMERIC DATA OPTIONS (CONT.)**

| Data Field/Numeric Data        | Definition  |
|--------------------------------|---|
| <b>Time of Day (Local)</b>     | The current time and date in 12-hour or 24-hour format.   |
| <b>Time (UTC)</b>              | The current time and date in Universal (UTC) time.  |
| <b>Vertical Speed</b>          | The rate of climb or descent (GPS-derived).   |
| <b>Vertical Speed Required</b> | The vertical speed necessary to descend/climb from a current position and altitude to the previously selected VNAV position and altitude, based upon current groundspeed. |
| <b>Weather (Altimeter)</b>     | The altimeter setting at the nearest METAR reporting station.   |
| <b>Weather (Dew Point)</b>     | The dew point at the nearest weather reporting station.   |
| <b>Weather (Rel. Humidity)</b> | The relative humidity at the nearest weather reporting station.   |
| <b>Weather (Temperature)</b>   | The temperature at the nearest weather reporting station.   |
| <b>Weather (Wind)</b>          | The wind speed and direction at the nearest weather reporting station.  |

**AURAL ALERTS**
**TRAFFIC**

- “Traffic”—TIS-A traffic alert received.
- “Traffic Not Available”—TIS-A service is not available or out of range.

**TERRAIN**

- “Five Hundred”—when the aircraft descends through 500 feet above the destination airport.

The following aural terrain alerts are issued when flight conditions meet parameters that are set within the software algorithms, and are dependant on the sensitivity level set in the Terrain Setup Menu.

| Alert Severity | Terrain   | Obstacle   | Descent Rate                        |
|----------------|---|--|-------------------------------------|
| <b>Caution</b> | "caution, terrain"<br>"caution, terrain ahead"                        | "caution, obstacle"<br>"caution, obstacle ahead"                         | "caution, sink rate"                |
| <b>Warning</b> | "terrain ahead! pull up!"<br>"terrain! terrain! pull up!<br>pull up!" | "obstacle ahead! pull up!"<br>"obstacle! obstacle!<br>pull up! pull up!" | "sink rate, pull up!"<br>"pull up!" |

#### Aural Alerts



## APPENDIX B: ABNORMAL OPERATION

### LOSS OF GPS POSITION

When the aera loses the GPS signal for any reason, the following will occur:

- A blinking red question mark will appear over the airplane icon on the map.
- The 'Lost Satellite Reception' message will display.
- Any GPS dependent data fields will not be available.

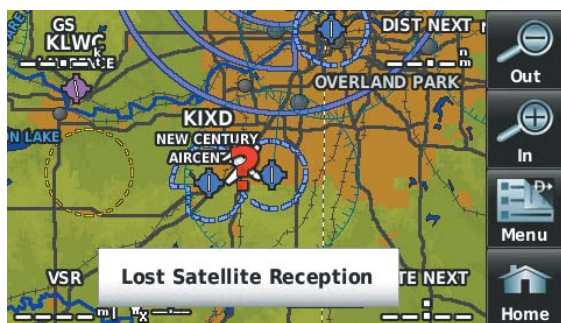

GPS Signal Lost

### HAZARD DISPLAY WITH LOSS OF GPS POSITION

If the Terrain function doesn't have at least a 3D fix (i.e. altitude unknown), a Red X will be displayed.



Terrain Red X

Overview

GPS Navigation

Flight Planning

Hazard Avoidance

Additional Features

Appendices

Index

Blank Page

# APPENDIX C: MANAGING FILES AND DATABASES

## CONNECTING TO A COMPUTER

The aera can be connected to a computer using the included USB-PC Interface Cable to connect to a USB data port.



Mini-USB Connection

### Connecting the aera to a computer:

- 1) (Optional Step) Insert a memory card into the memory card slot in the battery compartment. Press it in until it clicks.
- 2) Turn the aera on in the desired mode (aviation or automotive). In order for data to be copied to the correct mode, the user must connect the aera to the computer while it is in the desired usage mode (aviation or automotive).
- 3) Connect the small end of the USB cable to the connector under the battery cover.
- 4) Connect the larger end of the USB cable to a USB port on the computer. The Mass Storage Icon appears on the screen, along with an icon indicating the usage mode. The aera and memory card appear as removable drives in My Computer in Windows and as mounted volumes on Mac computers.

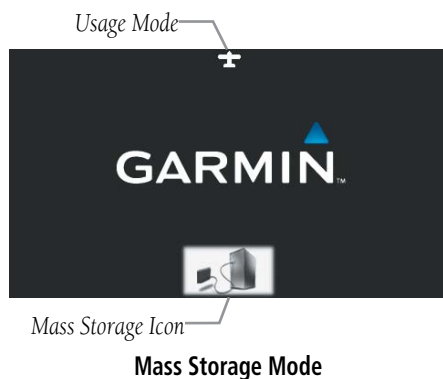

## MANAGING FILES



**NOTE:** The aera is not compatible with Windows95®, 98, Me, Windows NT®, and Mac® OS 10.3 and earlier.

Files can be stored in the aera internal memory or the optional memory card.

| Supported File Types                                   | Mode       |          |
|--|------------|----------|
|  | Automotive | Aviation |
| MP3 music files  | +          |          |
| M3U and M3U8 music playlist files                      | +          |          |
| AA audio book files                                    | +          |          |
| JPEG and JPG image files                               | +          |          |
| GPX route files  | +          |          |
| GPI custom POI files from the POI Loader Application   | +          |          |
| Maps, routes, trip logs, and waypoints from MapSource® | +          | +        |

aera 500/510/550/560 File Types

## MAPSOURCE DETAILED MAPS

The included USB Interface Cable is used to transfer MapSource® CD-ROM data to the aera internal memory or optional MicroSD Card.

For compatible MapSource® products, refer to the Garmin web site at [www.garmin.com/cartography](http://www.garmin.com/cartography).



---

**NOTE:** *If you have several network drives mapped on your computer. Windows may have trouble assigning drive letters to your aera drives. See the aera 500 Series Automotive Owner's Manual to learn how to map and assign drive letters.*

---

## TRANSFERRING FILES





---

**NOTE:** *In order for data to be copied to the correct mode, the user must connect the aera to the computer while it is in the desired usage mode (aviation or automotive).*

---

### To transfer files:

- 1) Browse the computer for the file to copy.
- 2) Highlight the file, and select **Edit > Copy**.
- 3) Open the "Garmin" or memory card drive/volume.
- 4) Select **Edit > Paste**. The file appears in the list of files in the aera memory or on the memory card.
- 5) When finished transferring files, click  in the toolbar (system tray), or drag the volume icon to the  trash can on Mac computers.
- 6) Unplug the aera from the computer

## MicroSD™ CARD USE (OPTIONAL)

The aera uses an optional MicroSD™ Card for storing data.

### INSTALLING AND REMOVING MicroSD™ CARDS

Install the MicroSD Card in the slot located under the battery. Install or remove the MicroSD Card at any time, whether the unit is on or off.

You can load a variety of information to the aera internal memory or MicroSD Card, such as MapSource detailed maps in a MapSource program.



#### Installing an MicroSD Card:

- 1) Slide the 'Release Key' to the right to release the battery cover. The 'Release Key' is located on the bottom right side of the unit.
- 2) Remove the battery to access the MicroSD card slot.
- 3) Firmly push the card into the unit. It is not necessary to force the card. The handle is still exposed when it is properly inserted.
- 4) The unit takes a few seconds to read the card. When the data card has been properly installed and accepted, a summary screen noting the card details appears. Touch to acknowledge.

If you insert an microSD Card and get a card format not recognized message, try removing the card and reinserting it. If the card is still not recognized, contact Garmin Product Support or your Garmin dealer.

### Removing an microSD Card:

- 1) Push the card into the unit until it stops.
- 2) Release the card. The card should eject for easy removal.
- 3) With the card ejected, pull the card out of the slot.

## DATABASES

The following databases are included with the aera depending on the unit (Americas, Atlantic, or Pacific). See the Additional Features section for information on AOPA Airport Directory, AC-U-KWICK Airport Directory, and SafeTaxi®. See the Hazard Avoidance section for information on Obstacles and Terrain.

| Feature/Database              | aera     |          |         |          |          |          |         |          |
|-------------------------------|----------|----------|---------|----------|----------|----------|---------|----------|
|                               | 500      |          |         | 510      | 550      |          |         | 560      |
|                               | Americas | Atlantic | Pacific | Americas | Americas | Atlantic | Pacific | Americas |
| Worldwide Basemap             | +        | +        | +       | +        | +        | +        | +       | +        |
| AOPA Airport Directory        |          |          |         |          | +        |          |         | +        |
| Air Sport Sites               |          |          |         |          |          | +        |         |          |
| Jeppesen® Navigation Database | +        | +        | +       | +        | +        | +        | +       | +        |
| SafeTaxi®                     |          |          |         |          | +        |          |         | +        |
| Obstacle                      | +        | +        |         | +        | +        | +        |         | +        |
| Terrain (arc-second)          | 30       | 30       | 30      | 30       | 9        | 9        | 9       | 9        |
| XM®                           |          |          |         | +        |          |          |         | +        |

**aera 500/510/550/560 Features & Databases**

## GARMIN DATABASE INFORMATION

The following databases are provided by Garmin:

- Worldwide Basemap
- Terrain
- SafeTaxi
- Obstacle

The basemap database contains data for the topography and land features, such as rivers, lakes, and towns. It is updated only periodically, with no set schedule. There is no expiration date.

The terrain database contains the terrain mapping data. The database is updated periodically and has no expiration date.

The obstacle database contains data for obstacles, such as towers, that pose a potential hazard to aircraft. Obstacles 200 feet and higher are included in the obstacle database. It is very important to note that not all obstacles are necessarily charted and therefore may not be contained in the obstacle database. This database is updated on a 56-day cycle and does not expire.



---

**NOTE:** *The data contained in the terrain and obstacle databases comes from government agencies. Garmin accurately processes and cross-validates the data, but cannot guarantee the accuracy and completeness of the data.*

---

The Safe Taxi database contains detailed airport diagrams for selected airports. These diagrams aid in following ground control instructions by accurately displaying the aircraft position on the map in relation to taxiways, ramps, runways, terminals, and services. This database is updated on a 56-day cycle and does not expire.

## GARMIN AVIATION DATABASE UPDATES



---

**NOTE:** *For automotive map updates refer to <http://my.garmin.com>.*

---

The Garmin aviation database updates can be obtained by visiting the 'flyGarmin' website ([www.fly.garmin.com](http://www.fly.garmin.com)).

After the databases have been updated, check that the appropriate databases are initialized and displayed on the splash screen during power-up.



## AIRPORT DIRECTORY DATABASES

The AOPA Airport Directory provides data on airports and heliports throughout the U.S. and it is updated on a 56-day cycle. Detailed information for over 5,300 U.S. airports, along with the names and phone numbers of thousands of FBOs can be viewed. This service allows the pilot to plan an overnight, choose fuel stops, find ground transportation, etc.

Optional airport directory databases such as AC-U-KWIK are also supported. AC-U-KWIK provides complete listings of FBOs, charter companies, fuel suppliers, ground transportation, maintenance and catering services at public airports across the world.

## NAVIGATION DATABASE

The includes an internal navigation database that provides location and facility information for thousands of airports, VORs, NDBs, and more. Updates to the navigation database are available every 28 days online ([www.fly.garmin.com](http://www.fly.garmin.com)). There are two navigation database products available: the Jeppesen Navigation Database, which is sourced by Jeppesen, and the US VFR Navigation Database sourced by AeroNav Products, a division of the FAA. The update program is designed to operate on Windows®-compatible PCs and requires the included USB cable to connect your aera to the PC's USB port. The following information is provided from the internal navigation database:



**NOTE:** *Although the Jeppesen Navigation Database and the US VFR Navigation Database contain much of the same information, pilots may notice differences in behavior, nearest list functionality, direct-to functionality, and map page display due to data content variations. The US VFR Navigation Database, by AeroNav Products, does not contain any approach data.*

- \*Airport—identifier, facility name, city/state/country, latitude/longitude, field elevation, available fuel types, runway designations and layout, runway surface, runway length, runway width, runway lighting, communication frequencies, and published approaches (Jeppesen Navigation Database only).
- Weather—frequencies associated with an airport (ASOS, ATIS, and AWOS).

- \*VORs—identifier, facility name, city/state/country, location (latitude/longitude), frequency, service volume (high, low, terminal), and type (such as VOR-DME, TACAN, and VORTAC).
  - \*NDBs—identifier, facility name, city/state/country, location (latitude/longitude), and frequency.
  - Intersections—identifier, nearest VOR, radial and distance from nearest VOR, location (latitude/longitude), and region/country.
  - ARTCC—Air Route Traffic Control Centers.
  - Airspace—boundaries (Class B, Class C, Control Zones, SUAs, and MOAs), controlling agency, and vertical boundaries.
  - FSS—Flight Service Stations.
- \* Symbology used for NDBs, VORs, and airports is consistent with those used on a sectional chart.



---

**NOTE:** After performing a navigation database update, verify all flight plan(s) (routes) are current. If there is an obsolete aviation point in a saved route, the route is locked and unusable. A new route with current navigation database points will need to be created.

---

# APPENDIX D: INSTALLATION AND INTERFACING

## MOUNTING THE aera IN THE AIRCRAFT

The aera yoke mount comes fully assembled as shown below. The yoke mount is designed to fit the majority of conventional aircraft yokes and center column controls.

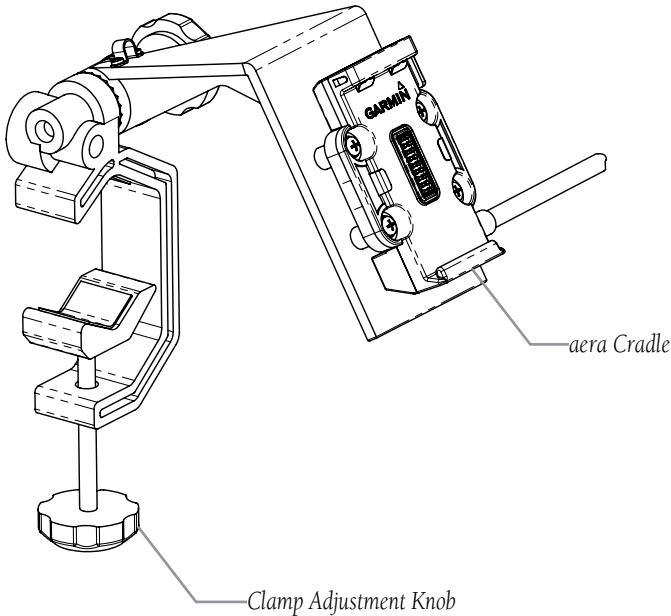

**WARNING:** It is the sole responsibility of the owner/operator of the aera to place this mount and secure the unit so that it will not interfere with the aircraft's operating controls and safety devices, or cause damage or personal injury in the event of an accident or turbulence. Do not mount the aera where the pilot or passengers are likely to impact it in an accident, collision, or turbulence. The mounting hardware provided by Garmin is not warranted against turbulence, collision damage, or related consequences.



**NOTE:** After installation, verify flight controls are free and clear per the flight manual of the applicable aircraft and that the aera yoke mount and wiring do not cause any interference with the flight controls.



**NOTE:** Readjust the position of the aera to provide the best view of the display screen as lighting conditions change.

### Attaching the yoke mount to the yoke shaft or control arm:

- 1) Open the clamp by turning the Clamp Adjustment Knob until it can be easily placed over the yoke shaft or control arm. Install the yoke mount as far from the panel as is practical.
- 2) When in place, tighten the Clamp Adjustment Knob to secure the yoke mount to the yoke shaft or control arm.
- 3) Loosen the Cradle Adjustment Knob, then orient the aera as desired.
- 4) Tighten the Cradle Adjustment Knob to hold the aera in place.
- 5) Connect power/data cables.

### Attaching the aera to the yoke mount:

- 1) Fit the bottom of the aera into the cradle.
- 2) Tilt the aera back until it snaps into place.

### Removing the aera from the yoke mount:

- 1) Press the Release Button on the side of the mount to release the aera.
- 2) Lift out the aera.

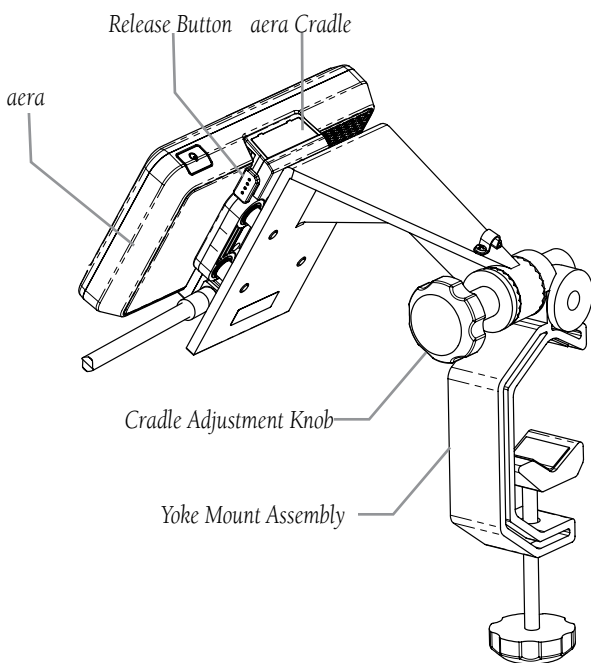

**Connecting the cables:**

Make all applicable cable connections.

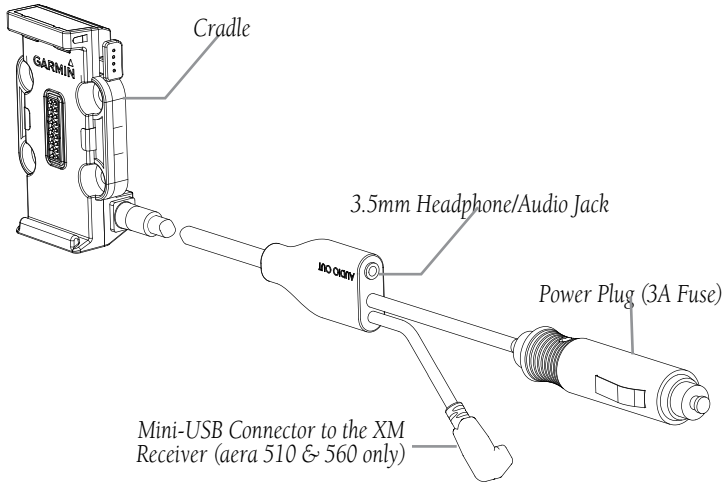

**Reconfiguring the yoke mount for center column yokes:**

- 1) Loosen and remove the Cradle Adjustment Knob, spacer, and rubber washer.
- 2) Rotate the clamp assembly 90° so that the clamp opening faces away from you.
- 3) Secure the clamp assembly to the rest of the yoke mount using the Cradle Adjustment Knob, spacer, and rubber washer. Adjust the clamp angle before fully tightening the Cradle Adjustment Knob.

## Yoke Mount in Conventional Configuration

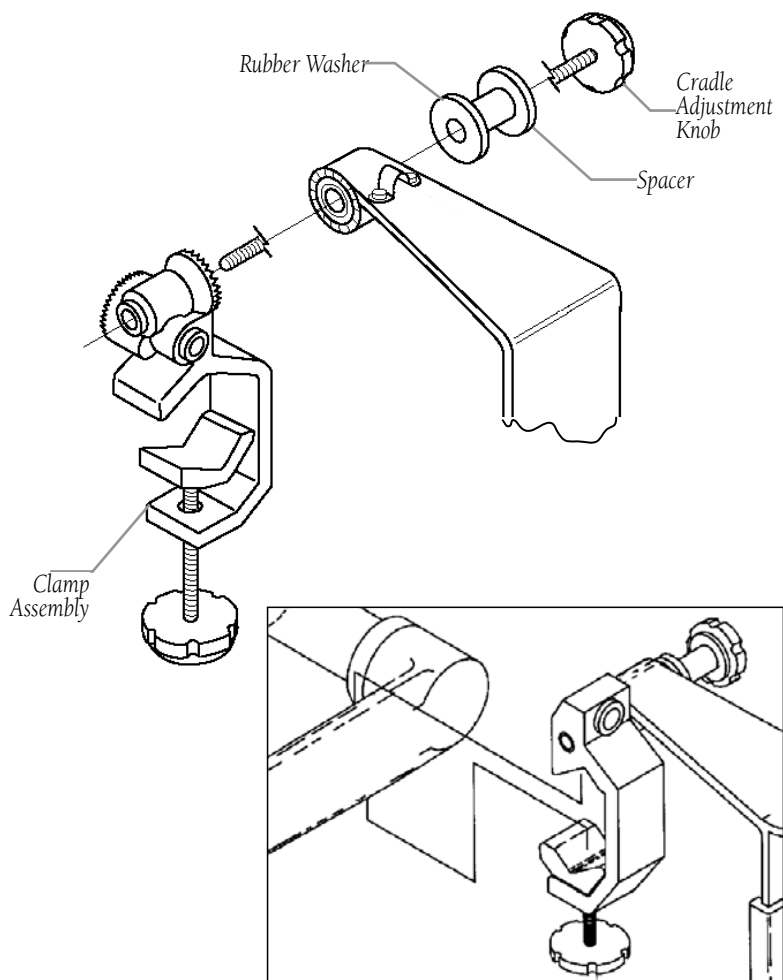

## Yoke Mount in Forward-Facing Configuration

**Securing the cable on the top of the yoke mount:**

- 1) Remove the screws securing the cable clamp.
- 2) Orient the cable and secure the clamp with the screws.

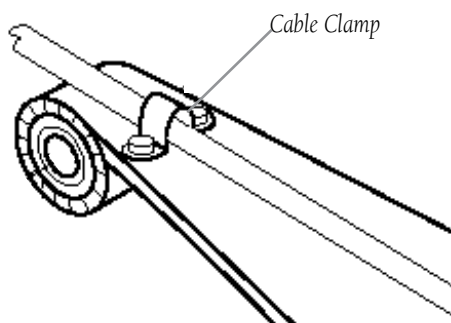

### Removing the yoke mount from the yoke shaft (or control arm):

- 1) Disconnect the cable connectors from the aircraft.
- 2) Loosen the clamp by turning the Clamp Adjustment Knob until the clamp assembly can be easily removed from the yoke shaft or control arm.

## CONNECTING TO A GARMIN VHF COMM RADIO

The aera can also output frequency data to a Garmin aviation radio. Currently the two models supported are the SL30 nav/comm and the SL40 comm.



**NOTE:** For additional information refer to the SL30 nav/comm or the SL40 comm installation manual.



**CAUTION:** This interface does not have an FAA installation airworthiness approval. If any abnormalities with SL 30/40 tuning or operation are encountered, disconnect the aera from the SL 30/40 tuning interface.

### Output frequency data to an SL40/SL30 nav/comm radio:

- 1) Connect the aera to an SL30/SL40 using the Aviation Bare Wire Connector (optional accessory).

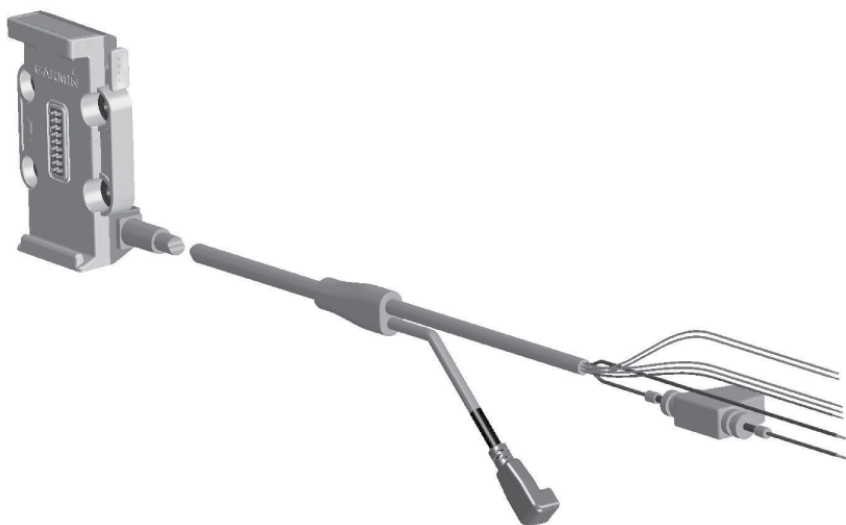

aera Aviation Bare Wire Connector

| Connection    | Wire Color |
|---------------|------------|
| Power         | Red        |
| Ground        | Black      |
| TX (Data Out) | Blue       |
| RX (Data In)  | Yellow     |
| Audio Right   | White      |
| Audio Common  | Green      |
| Audio Left    | Brown      |

aera Aviation Bare Wire Connections

- 2) From the 'Home' Screen, touch **Tools > Setup > Interface**.
- 3) Touch the **Serial Data Format** Button. A vertical list is displayed.
- 4) Touch '**Aviation In/NMEA & VHF Out**' or '**GTX TIS-A In/NMEA & VHF Out**'. These comm modes send both NMEA data and VHF frequency information.



The following features are now available on the radio:

- Remote frequency lists for departure, enroute, and arrival airports.
- Nearest VOR frequencies (SL30 only).

The aera can also directly tune a standby frequency.

### Selecting a standby comm frequency:

- 1) From the 'Home' Screen, touch **WPT Info** > **Freq** Tab
- 2) Touch the desired frequency from the list. The frequency is now tuned in standby.

**Or:**

- a) If the frequency has additional information (denoted with an \*). Touch the desired frequency from the list.
- b) Touch the 'Tune' Button.

## INFORMATION ABOUT USB DRIVERS

When connecting the aera to a USB port, the computer prompts you to locate the destination of the drivers for the device (a USB drivers CD is included). Only install the drivers once. After the drivers are installed, your computer always detects your aera when it is connected. USB driver updates can be found at [www.garmin.com](http://www.garmin.com).

## CONNECTING THE GXM 40 ANTENNA (aera 510 & 560)

Connect the GXM 40 antenna to the aera to access XM Satellite Weather and XM Radio. For more information about the GXM 40 antenna, see the GXM 40 Owner's Manual.



**NOTE:** You must subscribe to XM Radio and/or XM WX Satellite Weather to use the XM Radio and/or XM Weather features on your aera 510 or 560.

### Connecting the GXM 40 antenna:

- 1) Position the antenna where it has a clear view of the sky. This can be on the outside of the vehicle or behind the windshield.
- 2) Plug the GXM 40 cable into the Mini-USB Connector on the appropriate Aviation Mount.



## CONNECTING TO A GTX 330 MODE S TRANSPONDER

To receive Mode S TIS-A traffic data from a GTX 330 transponder on your aera, connect an available RS-232 OUT wire on the transponder to the Data In wire on the aera. (You do not need to connect the transponder to the aera's Data Out wire.) Then, set the corresponding RS-232 output configuration on the transponder to REMOTE + TIS-A and set the aera's Serial Data Format to GTX TIS-A In or GTX TIS-A In/NMEA & VHF Out. For more information see the GTX 330 Transponder Installation Manual.

### Configuring TIS-A input:

- 1) Connect the aera to the GTX 330 using the Aviation Bare Wire Connector (optional accessory).
- 2) From the 'Home' Screen, touch **Tools** > **Setup** > **Interface**.
- 3) Touch the **Serial Data Format** Button. A vertical list is displayed.
- 4) Touch '**GTX TIS-A In**' or '**GTX TIS-A In/NMEA & VHF Out**'.

The TIS-A Status field indicates one of the following messages:

- Waiting For Data—searching for a valid TIS-A data stream.
- Data Available—receiving TIS-A data from the transponder.
- Data Unavailable—connection to transponder established, but TIS-A service is unavailable.
- Lost Connection—an error occurred or the connection to the transponder was lost.

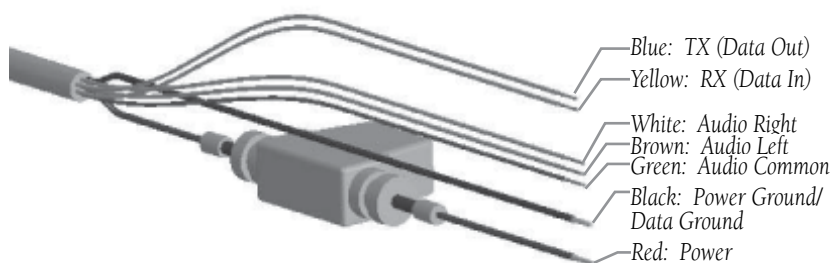

aera Aviation Bare Wire Connector

## CONNECTING TO A GDL 39

To receive weather and traffic information from the GDL 39, the GDL 39 must be connected to the aera using the 'GDL 39 Power/Data Cable to Aera 500 Series' (P/N 010-11686-30) or through a bare wire (P/N 010-11686-40) installation. The aera has only one serial connection, but when two serial connections are needed the GDL 39 can relay serial information to another serial device. Refer to the GDL 39 User's Guide for more information. The aera must also be configured correctly to receive traffic and weather information from the GDL 39 as described below.

### Configuring aera for GDL 39:

- 1) Connect the aera to the GDL 39 through the Power/Data Cable or bare wire.
- 2) From the **Main Menu**, touch **Tools > Setup > Interface**.
- 3) Touch the 'Serial Data Format' data field button. A vertical list is displayed.
- 4) Touch '**Garmin Data Transfer**'. When recognized the GDL 39 device and connections information is shown.
- 5) To view GDL 39 detailed connection/update status, from the **Main Menu**, touch **Tools > Data Link**.



**CAUTION:** Never remove power from the aera or GDL 39 during a software update. Anytime the aera software is updated it may also contain firmware updates for products such as the GDL 39. The aera software will update first, after the unit reboots it will update the firmware of a connected GDL 39. You can view the GDL 39 update progress on the Data Link Information Page.

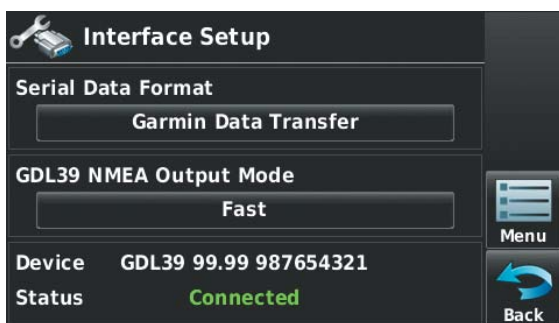

GDL 39 Interface Setup

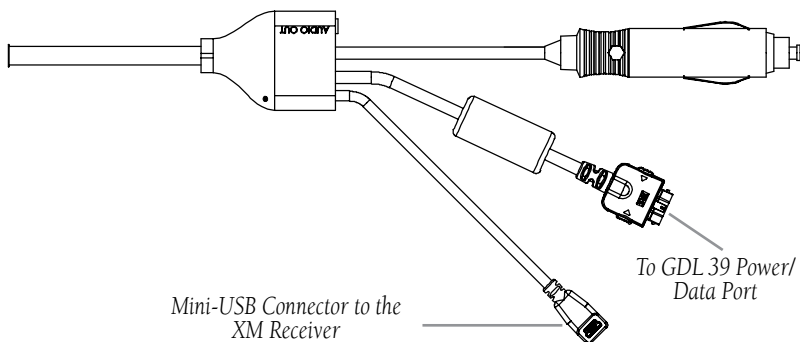

Mini-USB Connector to the  
XM Receiver

To GDL 39 Power/  
Data Port

GDL 39 Power/Data Cable to Aera 500 Series

| Connection                  | aera 5xx Bare Wire Color | GDL 39 Bare Wire Color |
|-----------------------------|--------------------------|------------------------|
| TX (Data Out) from aera 5xx | Blue Wire                | White/Green Wire       |
| RX (Data In) into aera 5xx  | Yellow Wire              | Green Wire             |
| NMEA Out of GDL 39          |                          | Orange Wire            |

aera Aviation Bare Wire Connections to GDL 39

## INTERFACING

The following formats are supported for connection of external devices: NMEA 0180, 0182, 0183 (versions 1.5, 2.0, 2.3, 3.01), ASCII Text Output, and Garmin proprietary formats for connecting to a Mode S transponder for TIS-A data, and to a Garmin aviation NAV/COM radio.

The following are the Approved Sentences for NMEA 0183, version 3.01 output: GPRMC, GPGGA, GPGSA, GPGSV, GPGLL, GPBOD, GPRTE, and GPWPL. The following are the Proprietary Sentences for NMEA 0183, version 3.01 output: PGRME, PGRMZ, PGRMM, and PGRMH.

Garmin's proprietary communication protocol is available from the Web site ([www.garmin.com](http://www.garmin.com)).

### GENERAL INTERFACE SETUP

The Interface Setup controls the input/output format used when connecting the unit to external devices.

#### Selecting an interface:

- 1) From the **'Home'** Screen, touch **Tools > Setup > Interface**.
- 2) Touch **Serial Data Format**. A vertical list is displayed.
- 3) Touch the desired data format ('**Garmin Data Transfer**', '**NMEA Out**', '**Aviation In**', '**Aviation In/NMEA & VHR Out**', '**GTX TIS-A In**', '**GTX TIS-A In/NMEA & VHF Out**', or '**None**').
- 4) If desired, touch **Menu > Description**.

#### Restoring interface defaults:

From the **'Home'** Screen, touch **Tools > Setup > Interface > Menu > Restore Default**.

### SERIAL DATA FORMATS

- **Garmin Data Transfer**—the proprietary format used to exchange data with a PC, GDL 39, or another Garmin aera.
- **NMEA Out**—transmits NMEA position, velocity, and navigation data.

- Aviation In—the proprietary format used for connection to a Garmin panel-mounted GPS receiver. This eliminates the need to enter the destination on both units.
- Aviation In/NMEA & VHF Out—receives aviation data and transmits out both NMEA data, at 9600 baud, and VHF frequency tuning information to a Garmin Nav/Comm radio.
- GTX TIS-A In—receives TIS-A data from a Garmin Mode S transponder or other compatible device.
- GTX TIS-A In/NMEA & VHF Out—receives TIS data and transmits out both NMEA data, at 9600 baud, and VHF frequency tuning information to a Garmin Nav/Comm radio.
- None—provides no interfacing capabilities.

## ADVANCED NMEA OUTPUT SETUP

If interfacing the aera with another piece of equipment (such as an autopilot), the unit needs to be set to output NMEA data. If the NMEA output mode is set to 'Fast', the unit will output a minimum number of NMEA sentences at 1-second intervals. If the NMEA output is set to 'Normal', the unit will output a greater number NMEA sentences as 2-second intervals.

### Setting NMEA output mode:

- 1) From the 'Home' Screen, touch **Tools > Setup > Interface**.
- 2) Touch **Serial Data Format**. A vertical list is displayed.
- 3) Touch '**NMEA Out**'.
- 4) Touch **NMEA Output Mode** to toggle between '**Normal**' or '**Fast**'.

NMEA Sentence Output:

- Normal Mode: GPRMB, GPRMC, GPGGA, GPGSA, GPGSV, GPGLL, GPBWC, GPVTG, GPXTE, GPBOD, GPRTE, GPWPL, GPAPB, PGRME, PGRMZ, PGRMM, and PGRMH.
- Fast Mode: GPRMB, GPRMC, PGRMZ, and PGRMH.

## **USING AN EXTERNAL GPS ANTENNA (OPTIONAL)**

The optional GA27C or GA25 external antenna can be used. Connect the antenna to the connector located on the left side of the unit.



**External Antenna Connector**

Overview

GPS Navigation

Flight Planning

Hazard Avoidance

Additional Features

Appendices

Index

Blank Page



## APPENDIX E: BATTERY AND CARE INFORMATION

### BATTERY INFORMATION

The aera contains a user-replaceable, lithium-ion battery. To maximize the lifetime of the battery, do not leave the aera in direct sunlight, and avoid prolonged exposure to excessive heat.

The  battery icon in the top right of the 'Home' screen indicates the status of the aera battery. To increase the accuracy of the battery gauge, fully discharge the battery and fully charge it. Do not unplug the aera until it is fully charged.

#### MAXIMIZING THE BATTERY LIFE

- Turn down the backlight (refer to the 'System Settings' chapter of this section).
- Unplug the XM antenna (if applicable).
- Do not leave the unit in direct sunlight, in a cool (not freezing) place. When storing the unit, store within the following temperature range: -32° to 122°F (-0° to 50°C).
- Do not operate the unit outside of the following temperature range: -4° to 140°F (-20° to 60°C).
- Avoid prolonged exposure to excessive heat.

#### REPLACING THE BATTERY IN THE AERA

To replace the battery, use a Garmin lithium-ion battery 010-11143-00. Purchase a replacement battery at <http://buy.garmin.com>. Contact your local waste disposal department for information about properly disposing of the battery.

### CHANGING THE FUSE

If the unit does not charge, the fuse may need to be replaced.

- 1) Unscrew the round end piece, and remove it.
- 2) Remove the fuse (glass and silver cylinder), and replace with a 3A fast-blow fuse.
- 3) Ensure that the silver tip is placed in the end piece. Screw on the end piece.

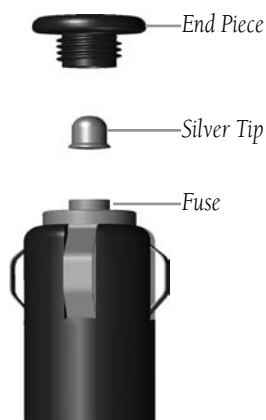

## CLEANING THE CASING

---

The aera is constructed of high-quality materials and does not require user maintenance other than cleaning. Clean the outer casing (not the touchscreen) using a cloth dampened with a mild detergent solution, and then wipe dry. Avoid chemical cleaners and solvents that can damage plastic components.

## CLEANING THE TOUCHSCREEN

---

Clean the touchscreen with a soft, clean, lint-free cloth. Use water, isopropyl alcohol, or eyeglass cleaner, if needed. Apply the liquid to the cloth, and then gently wipe the touchscreen.

## PROTECTING THE UNIT

---

- Do not store the aera where prolonged exposure to extreme temperature can occur.
- Though a PDA stylus can be used to operate the touchscreen, never attempt this while operating an aircraft or vehicle. Never use a hard or sharp object to operate the touchscreen.

## AVOIDING THEFT

---

- Remove the unit from sight when not in use.
- Do not keep the unit in the glove compartment.
- Register the product at <http://my.garmin.com>.

## REGISTERING THE UNIT

---

See the aera 500 Series Automotive Owner's Manual for more information.

Overview

GPS Navigation

Flight Planning

Hazard Avoidance

Additional Features

Appendices

Index

Blank Page

## APPENDIX F: GENERAL TIS-A INFORMATION



**NOTE:** Aircraft without an operational transponder are invisible to TIS-A.



**WARNING:** Do not rely solely upon the display of traffic information for collision avoidance maneuvering. The traffic display does not provide collision avoidance resolution advisories and does not, under any circumstances or conditions, relieve the pilot's responsibility to see and avoid other aircraft.



**WARNING:** Do not rely solely upon the display of traffic information to accurately depict all of the traffic within range of the aircraft. Due to lack of equipment, poor signal reception, and/or inaccurate information from aircraft or ground stations, traffic may be present that is not represented on the display.

The Traffic Information Service (TIS-A) provides traffic advisory information to non-TAS/TCAS-equipped aircraft. TIS-A is a ground-based service providing the relative locations of all ATCRBS (Air Traffic Control Radar Beacon System) Mode-A and Mode-C transponder equipped aircraft within a specified service volume. The TIS-A ground sensor uses real-time track reports to generate traffic notification. The aera displays TIS-A traffic information on the Navigation Map. Surveillance data includes all transponder-equipped aircraft within the coverage volume. The aera displays up to eight traffic targets within a 7.5-nm radius, from 3,000 feet below, to 3,500 feet above the requesting aircraft.

### TIS-A VS. TAS/TCAS

The main difference between the Traffic Information System (TIS-A) and Traffic Advisory (TAS) or Traffic Collision Avoidance Systems (TCAS) is the source of surveillance data. TAS/TCAS uses an airborne interrogator with a half-second update rate, while TIS-A utilizes the terminal Mode-S ground interrogator and accompanying data link to provide a five-second update rate. TIS-A and TAS/TCAS have similar ranges.

### TIS-A LIMITATIONS

TIS-A relies on surveillance of the Mode-S radar system, which is a "secondary surveillance" radar system similar to that used by ATCRBS. Many limitations are inherent in secondary radar surveillance. Information provided by TIS-A is neither

better nor more accurate than the information used by ATC. TIS-A is intended only to assist in visual acquisition of other aircraft in visual meteorological conditions (VMC). While TIS-A is a useful aid for visual traffic avoidance, system limitations must be considered to ensure proper use. No recommended avoidance maneuvers are given, nor authorized, as a direct result of a TIS-A intruder display or TIS-A advisory.

- TIS-A operation may be intermittent during turns or other maneuvering.
- TIS-A is dependent on two-way, line-of-sight communications between the aircraft and the Mode-S radar antenna. Whenever the structure of the aircraft comes between the transponder antenna and the ground-based radar antenna, the signal may be temporarily interrupted.



---

**NOTE:** Refer to the *TIS-A Limitations* section of the *Aeronautical Information Manual (AIM)* for a more comprehensive explanation of limitations and anomalies associated with TIS-A.

---



---

**NOTE:** TIS-A is unavailable at low altitudes in many areas of the United States. This is often the case in mountainous regions.

---



---

**NOTE:** Garmin is not responsible for Mode S geographical coverage. Operation of the ground stations is the responsibility of the FAA. Refer to the AIM for a Terminal Mode S radar site map.

---

TIS-A information is collected during a single radar sweep. Collected information is then sent through the Mode S uplink on the next radar sweep. Because of this, the surveillance information is approximately five seconds old. TIS-A ground station tracking software uses prediction algorithms to compensate for this delay. These algorithms use track history data to calculate expected intruder positions consistent with the time of display. Occasionally, aircraft maneuvering may cause variations in this calculation and create slight errors on the Navigation Map which affect relative bearing information and the target track vector and may delay display of the intruder information. However, intruder distance and altitude typically remain relatively accurate and may be used to assist in spotting traffic. The following errors are common examples:

- When the client or intruder aircraft maneuvers excessively or abruptly, the tracking algorithm may report incorrect horizontal position until the maneuvering aircraft stabilizes.
- When a rapidly closing intruder is on a course that intercepts the client aircraft course at a shallow angle (either overtaking or head-on) and either aircraft abruptly changes course within 0.25 nm, TIS-A may display the intruder aircraft on the incorrect side of the client aircraft.

These are rare occurrences and are typically resolved within a few radar sweeps once the client/intruder aircraft course stabilizes.

Pilots using TIS-A can provide valuable assistance in the correction of malfunctions by reporting observations of undesirable performance. Reports should identify the time of observation, location, type and identity of the aircraft, and describe the condition observed. Reports should also include the type of transponder and transponder software version. Since TIS-A performance is monitored by maintenance personnel, not ATC, malfunctions should be reported in the following ways:

- By telephone to the nearest Flight Service Station (FSS) facility
- By FAA Form 8000-7, Safety Improvement Report (postage-paid card can be obtained at FAA FSSs, General Aviation District Offices, Flight Standards District Offices, and General Aviation Fixed Base Operators)

Overview

GPS Navigation

Flight Planning

Hazard Avoidance

Additional Features

Appendices

Index

Blank Page



## APPENDIX G: UTILITIES

### FLIGHT LOG

The Flight Log shows a list of any recorded flights, including date, route of flight, and flight time. The aera saves up to 50 recorded flights. Entries on this list are automatically created for each flight.

Recording begins when your speed exceeds 30 knots and you gain 250 feet of altitude. If you land and groundspeed drops below 30 knots, the flight entry is saved and a new entry is recorded when you depart the airport. A touch-and-go or brief stop of less than 10 minutes appends to the current flight record, rather than starting a new entry.

### VIEWING THE FLIGHT LOG

Select any listed entry in the log to view additional information, including a map displaying the actual path flown.

#### Viewing details for a flight:

- 1) From the 'Home' Screen, touch **Tools** > **Flight Log**.
- 2) Touch the desired flight log. Route, date, hours, distance, and the flight path are displayed.

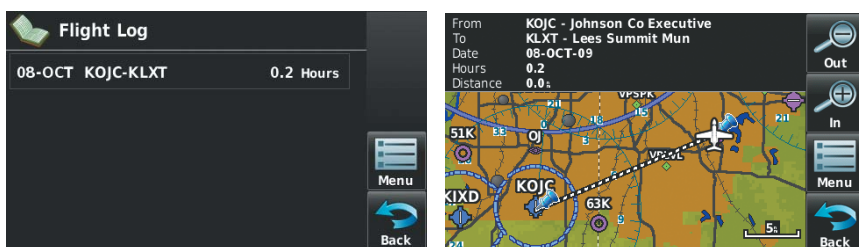

Flight Log

## DELETING FLIGHT RECORDS

You can delete the highlighted flight record or delete all flight records from the Flight Log.

### Deleting flight records:

- 1) From the 'Home' Screen, touch **Tools** > **Flight Log**.
- 2) Touch the desired flight log (if applicable).
- 3) Touch **Menu**.
- 4) Touch '**Delete Flight**' or '**Delete All**'.
- 5) Touch **Yes**.

## TRACK LOG

The aera draws an electronic breadcrumb trail or "track log" on the Navigation Map. The track log contains points along its path, including time, and location for each point.

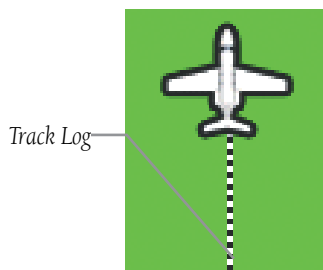

Track Log (Navigation Map)

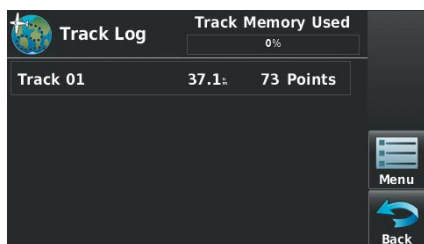

Track Log

The track log starts recording as soon as the aera gets a location fix. For the best results, clear the track log before each flight.



The percentage of memory used by the current track log appears at the top of the Track Log Window. After the track log is cleared, it shows zero percent. When the screen reaches 100%, the most recent track points start to overwrite the least recent track points (if 'Wrap' is selected in the Record Mode Field). To avoid losing track points, save the track log when it approaches the 99% mark.

The Save feature allows storage of up to 15 track logs.

### Showing/hiding the track log on the Navigation Map:

- 1) From the 'Home' Screen, touch **Map > Menu > Set Up Map**.
- 2) Touch the  buttons to display the 'Line' Category.
- 3) Touch **Track Log**.
- 4) Touch the **Show/Hide** Button.

### Changing track log settings:

- 1) From the 'Home' Screen, touch **Map > Menu > Set Up Map**.
- 2) Touch the  buttons to display the 'Line' Category.
- 3) Touch **Track Record Mode**, **Track Interval**, or **Track Color**.
- 4) Touch the  buttons to select the desired setting.

Track Log settings are also available from the Track Log Option Menu

- Track Log—Select '**Show**' or '**Hide**' to display/remove the track log on the map.
- Track Record Mode—'**Off**' disables track log recording. '**Fill**' records a track log until the track log is full (100%). '**Wrap**' records over the oldest tracks when the track log reaches 100%.
- Track Interval—'**Distance**' records track points after a specified distance has been traveled. '**Time**' creates track points after a specified time has elapsed. '**Automatic**' saves points that occur after changes in navigation.
- Track Color—Select a color for the track when it appears on the map.

### Clearing the track log:

- 1) From the 'Home' Screen, touch **Tools** > **Track Log**.
- 2) Touch the desired track log (if applicable).
- 3) Touch **Menu**.
- 4) Touch '**Delete Saved Track**' or '**Delete All Saved Tracks**'.
- 5) Touch **Yes**.

### Saving a track log:

- 1) From the 'Home' Screen, touch **Tools** > **Track Log** > **Menu** > **Save Active Track**.
- 2) Touch the ◀▶ buttons to select '**Entire Active Track**', '**Past 24 Hours**', '**Past 7 Days**', '**Selected Flight**', or '**Specific Dates**'.
- 3) Enter the Selected Flight or Specified Dates (if applicable) and touch **OK**.

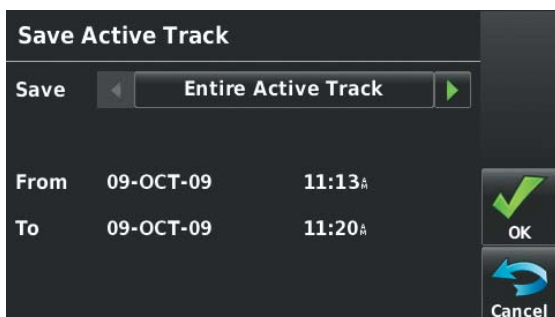

Save Active Track Log

### Editing a track log:

- 1) From the 'Home' Screen, touch **Tools** > **Track Log**.
- 2) Touch the desired track log.
- 3) Touch desired field to edit (**Track Name**, **Show On Map**, or **Color**).

## HEADING LINE

The aera draws an electronic “heading line” on the Navigation Map. The heading line can be set to time or distance.



Heading Line Setup

### Changing the heading line settings on the Navigation Map:

- 1) From the 'Home' Screen, touch **Map** > **Menu** > **Set Up Map**.
- 2) Touch the ◀▶ buttons to display the '**Line**' Category.
- 3) Touch **Heading Line**.
- 4) Touch the ◀▶ buttons to select ('Off', '**Time**', or '**Distance**').
- 5) Touch the +/- buttons to select the desired distance or time (if applicable).

## E6B CALCULATOR

The E6B Calculator calculates Density Altitude, True Airspeed, Tail Wind, Wind From, and Wind Speed, based on information you enter.

### Accessing the E6B calculator:

From the 'Home' Screen, touch **Tools** > **E6B Calc.**

*Barometric Pressure  
from the Nearest  
METAR*

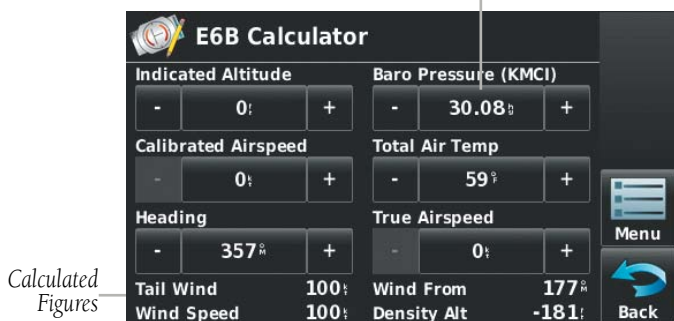

E6B Calculator

- **Indicated Altitude**—required entry for density altitude/true airspeed calculation. Enter the aircraft's altimeter reading.
- **Baro Pressure**—when the unit is receiving XM weather information, the field automatically updates to the barometric pressure of the nearest METAR. If XM weather information is not available you need to enter the current barometric pressure.
- **Calibrated Airspeed**— required entry for density altitude/true airspeed calculation. Enter the aircraft's airspeed indicator value.
- **Total Air Temp**— required entry for density altitude/true airspeed calculation. Total Air Temperature (TAT) is the temperature of the air including the heating effect caused by speed. The temperature reading on a standard outside air temperature gauge found on most piston aircraft is TAT.
- **Heading**— required entry for winds aloft calculation. Use heading from the aircraft's heading indicator or directional gyro.

- **True Airspeed**— (calculated or user-entered figure) determined from entry of calibrated airspeed, barometric pressure, and total air temperature. This can also be entered directly for winds aloft calculations.
- **Tail Wind**— (calculated figure) determined from entry of heading and true airspeed.
- **Wind From**—(calculated figure) determined from entry of heading and true airspeed.
- **Wind Speed**—(calculated figure) determined from entry of heading and true airspeed.
- **Density Altitude**— (calculated figure) determined from entry of indicated altitude, barometric pressure and total air temperature.

### Calculating true airspeed and density altitude:

- 1) From the '**Home**' Screen, touch **Tools** > **E6B Calc**, enter the altitude shown on the altimeter into the 'Indicated Altitude' field.
- 2) Repeat for 'Calibrated Airspeed', 'Baro Pressure', and 'Total Air Temperature' fields. (For Calibrated Airspeed, use the speed shown on the airspeed indicator. Use the current altimeter setting for Baro Pressure. Total Air Temperature is the temperature of the outside air including the heating effect caused by speed. For most aircraft, this is the temperature reading on a standard outside air temperature gauge.) The calculated figures for True Airspeed and Density Altitude are shown in the designated fields.

### Calculating winds aloft:

- 1) From the '**Home**' Screen, touch **Tools** > **E6B Calc**, calculate or enter the true airspeed into the 'True Airspeed' field.
- 2) Enter the aircraft heading shown on the directional gyro or compass into the 'Heading' field. Tail Wind, Wind From, and Wind Speed are calculated.



**NOTE:** If True North is selected as the heading reference, a heading referenced to True North must be used to calculate winds accurately.

### Restoring E6B calculator defaults:

From the '**Home**' Screen, touch **Tools** > **E6B Calc** > **Menu** > **Restore Default**.

## AIRCRAFT PROFILE

The Aircraft Profile allows the pilot to select cruising speed, maximum speed, fuel flow, and map symbol. The unit can save up to 10 aircraft profiles.

The maximum speed is used to define the range for airspeed on the Panel and is automatically updated if you exceed this figure.



### Accessing the aircraft profile:

From the 'Home' Screen, touch **Tools** > **Profile**



Aircraft Profile

### Entering an aircraft profile:

- 1) From the 'Home' Screen, touch **Tools** > **Profile** > **Menu** > **New**
- 2) Enter the Aircraft Name using the keypad, and touch **OK**.
- 3) Enter the **Cruise Speed**, **Maximum Speed**, or **Fuel Flow** using the +/- buttons or the keypad.
- 4) Touch **Map Symbol**.
  - a) Touch the   buttons to cycle through the available symbols.
  - b) Touch **OK**.

### Selecting a saved aircraft profile:

- 1) From the 'Home' Screen, touch **Tools** > **Profile**
- 2) Touch the Aircraft Name Button to access a vertical list of saved profiles.
- 3) Touch the desired profile from the list.



### Renaming a saved aircraft profile:

- 1) From the 'Home' Screen, touch **Tools** > **Profile**
- 2) Touch the Aircraft Name Button to access a vertical list of saved profiles.
- 3) Touch the desired profile from the list.
- 4) Touch **Menu** > **Rename**
- 5) Enter the new Aircraft Name using the keypad, and touch **OK**.

### Deleting a saved aircraft profile:

- 1) From the 'Home' Screen, touch **Tools** > **Profile**
- 2) Touch the Aircraft Name Button to access a vertical list of saved profiles.
- 3) Touch the desired profile from the list.
- 4) Touch **Menu** > **Delete**
- 5) Touch **Yes**.

## WEIGHT & BALANCE

Weight & Balance may be used during pre-flight preparations to verify the weight and balance conditions of the aircraft. By entering the weight and arm values, the aera can calculate the total weight, moment, and center of gravity (CG).

Before entering the various figures, the empty weight of the airplane and the arm (or "station") for each weight should be determined. These figures should be determined using the pilot's operating handbook for the airplane, which also notes the weight limitations and fore/aft CG limits. Compare those figures to the values calculated by the aera.

### To perform weight and balance calculations:

- 1) From the 'Home' Screen, touch **Tools** > **Weight/Bal**
- 2) Touch the fields to enter the desired weights and arms (or "stations"). The calculated moment, weight, and CG figures appear at the bottom of the screen. Keep in mind that the "Aircraft" (empty weight/arm) figures must be entered as a reference to calculate a valid moment, weight, and CG.
- 3) To empty the aircraft, touch **Menu** > **Empty Aircraft**.



**NOTE:** This information is only for flight planning purposes. Consult the aircraft's pilot operating handbook for the official weight and balance data.

| Weight & Balance |        | NGARMN |        |
|------------------|--------|--------|--------|
|                  | Weight |        | Arm    |
| Aircraft         | 1151   | lb     | +30.00 |
| Usable Fuel      | 147    | lb     | +0.00  |
| Pilot            | 180    | lb     | +39.00 |
| Co-Pilot         | 180    | lb     | +39.00 |
| Moment           | 52770  |        |        |
| Weight           | 1708   | lb     |        |
| C.G.             | 30.90  |        |        |

Weight & Balance

## EPE CIRCLE

Estimated Position Error (EPE) indicates the accuracy of the position fix. EPE uses Dilution of Precision (DOP) and other factors to calculate a horizontal position error. DOP measures satellite geometry quality (i.e., number of satellites received and where they are relative to each other).

### Setting up and customizing the EPE circle for the navigation map:

- 1) From the 'Home' Screen, touch **Map > Menu > Set Up Map**.
- 2) Touch the  buttons to display the 'Misc' Category.
- 3) Touch **EPE Circle**.
- 4) Touch the **On/Off** Button.

## PROXIMITY WAYPOINTS

The Proximity Waypoints allows the pilot to define an alarm circle around a waypoint location.

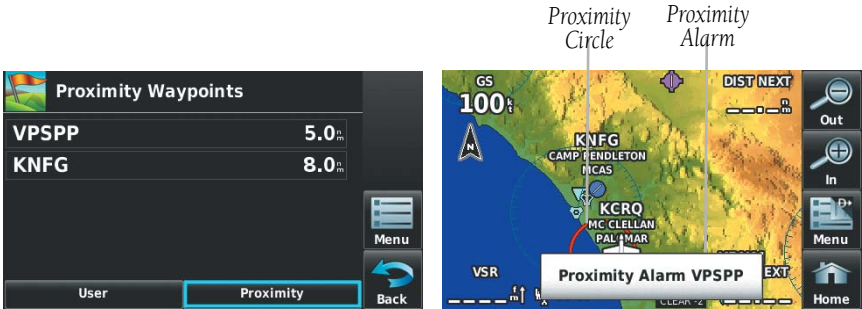

Proximity Waypoints

### Defining proximity waypoints:

- 1) From the 'Home' Screen, touch **Tools > User WPT > Proximity > Menu > New Proximity Waypoint**.
- 2) Touch 'Use Identifier' or 'Use Map'.
- 3) Enter the desired identifier or pan the map.
- 4) Touch the newly created Proximity Waypoint, and touch 'Edit Radius'.
- 5) Enter the desired Radius and touch **OK**.

### Setting up and customizing proximity waypoints for the navigation map:

From the 'Home' Screen, touch **Tools > User WPT > Proximity > Menu > Enable/Disable Proximity Alarms**.

**Or:**

- 1) From the 'Home' Screen, touch **Map > Menu > Set Up Map**.
- 2) Touch the **◀▶** buttons to display the 'Point' Category.
- 3) Touch **Proximity Circle**.
- 4) Touch the **◀▶** buttons to select the desired settings ('Off', 'Auto', or Range Settings).

### Deleting proximity waypoints:











- 1) From the 'Home' Screen, touch **Tools** > **User WPT** > **Proximity**.
  - a) Touch the desired proximity waypoint.
  - b) Touch the '**Delete Proximity Waypoint**' menu option.

**Or:**







  - a) Touch the **Menu** Icon
  - b) Touch the '**Delete All**' menu option.
- 2) Touch **Yes**.

# APPENDIX H: DISPLAY SYMBOLS

## VFR SYMBOLS

| Item                       | Symbol  |
|----------------------------|---|
| Unknown                    |    |
| Non-towered, Non-serviced  |    |
| Towered, Non-serviced      |    |
| Non-towered, Serviced      |    |
| Towered, Serviced          |    |
| Soft Surface, Non-serviced |    |
| Soft Surface, Serviced     |    |
| Soft Surface, Private      |   |
| Paved, Private             |  |
| Seaplane Base              |  |
| Heliport                   |  |

Americas/Pacific Database Airports

| Item   | Symbol  |
|--|---|
| Civilian, Non-serviced                       |  |
| Military, Non-serviced                       |  |
| Civilian, Serviced                           |  |
| Military, Serviced                           |  |
| Civilian, Soft/Unknown Surface, Non-serviced |  |
| Civilian, Soft/Unknown Surface, Serviced     |  |

Atlantic Database Airports

| Item                                  | Symbol |
|---------------------------------------|--------|
| Intersection                          |        |
| Visual Reporting Point                |        |
| LOM (compass locator at outer marker) |        |
| NDB (non-directional radio beacon)    |        |
| VOR                                   |        |
| VOR/DME                               |        |
| ILS/DME or DME only                   |        |
| VORTAC                                |        |
| TACAN                                 |        |

Nav aids

| Item               | Symbol |
|--------------------|--------|
| Interstate Highway |        |
| US Highway         |        |
| State Highway      |        |
| National Highway   |        |
| Small City         |        |
| Medium City        |        |
| Large City         |        |

Miscellaneous











## IFR SYMBOLS

| Item                                    | Symbol |
|---|--------|
| VFR, Soft/unknown Surface, Non-serviced |        |
| VFR, Soft/unknown Surface, Serviced     |        |









Atlantic Database Airports

| Item          | Symbol |
|---------------|--------|
| Low-Altitude  |        |
| High-Altitude |        |

Airways

| Item                            | Symbol  |
|---------------------------------|---|
| Unknown                         |    |
| VFR Airport, Non-serviced       |    |
| IFR Airport, Non-serviced       |    |
| VFR Airport, Serviced           |    |
| IFR Airport, Serviced           |    |
| VFR, Soft Surface, Non-serviced |    |
| VFR, Soft Surface, Serviced     |    |
| VFR, Soft Surface, Private      |    |
| VFR, Paved, Private             |    |
| VFR Seaplane Base               |   |
| VFR Heliport                    |  |

**Americas/Pacific Database Airports**

| Item                                  | Symbol  |
|---------------------------------------|---|
| Intersection                          |  |
| LOM (compass locator at outer marker) |  |
| NDB (non-directional radio beacon)    |  |
| VOR                                   |  |
| VOR/DME                               |  |
| ILS/DME or DME Only                   |  |
| VORTAC                                |  |
| TACAN                                 |  |

**Nav aids**

# AIRSPACE SYMBOLS



| Item                                    | Symbol |
|---|--------|
| Class B, Class E, CTA                   |        |
| Class A, Class C, TMA                   |        |
| Class D                                 |        |
| Mode C Veil                             |        |
| TRSA                                    |        |
| MOA                                     |        |
| Danger, Alert, or Training Area         |        |
| Restricted, Prohibited, or Warning Area |        |
| Radar Area                              |        |
| ATZ, TIZ                                |        |
| MATZ                                    |        |
| ADIZ                                    |        |
| Misc/Unknown                            |        |

VFR Americas/Pacific Database

| Item                                    | Symbol |
|---|--------|
| Class B, Class E, CTA                   |        |
| Class A, Class C, TMA, TRSA             |        |
| Class D                                 |        |
| MOA                                     |        |
| Danger, Alert, or Training Area         |        |
| Restricted, Prohibited, or Warning Area |        |
| Radar Area                              |        |
| ATZ, TIZ                                |        |
| Misc/Unknown                            |        |

IFR Americas/Pacific Database



| Item                                    | Symbol  |
|---|---|
| Danger or Alert Area                    |  |
| Restricted, Prohibited, or Warning Area |  |
| Training Area                           |  |

**VFR Atlantic Database Exceptions**

| Item          | Symbol  |
|---------------|---|
| Training Area |  |

**IFR Atlantic Database Exceptions**

Overview

GPS Navigation

Flight Planning

Hazard Avoidance

Additional Features

Appendices

Index

Blank Page

# APPENDIX I: MAP DATUM AND LOCATION FORMATS

## MAP DATUMS

---

A datum is a mathematical model of the Earth that approximates the shape of the Earth and enables calculations to be carried out in a consistent and accurate manner. The datum is physically represented by a framework of ground monuments (such as trig. stations) whose locations have been accurately measured and calculated on this reference surface. Lines of latitude and longitude on a chart are referenced to a specific map datum. Every chart has a map datum reference and the aera can be set to match most of those commonly used.

## LOCATION FORMATS

---

Your current location can be viewed on the GPS in the form of coordinates. Since different charts use different location formats, Garmin GPS units allow you to choose the correct coordinate system for the type of chart you are using. The most common format is latitude and longitude, which is used by all Garmin units. You can change the location format to use with other coordinate systems. Several other grids, including a user-definable grid (for the advanced user), are available.

Blank Page

## APPENDIX J: GLOSSARY

|                              |  |
|------------------------------|--|
| ADIZ                         | Air Defense Identification Zone  |
| ADS-B                        | Automatic Dependant Surveillance -Broadcast  |
| ADS-B In                     | Ability to receive ADS-B information from other aircraft and Ground Based Transceivers (GBTs)  |
| ADS-B Out                    | Ability to transmit ADS-B data on 1090 ES or 978 MHz   |
| ADS-B Participating Aircraft | An aircraft that has both ADS-B In and ADS-B Out capabilities.   |
| ADS-R                        | Automatic Dependent Surveillance-Rebroadcast   |
| AGL                          | Above Ground Level   |
| AIRMET                       | Airman’s Meteorological Information  |
| ARTCC                        | Air Route Traffic Control Center   |
| ASOS                         | Automated Surface Observing System   |
| ATC                          | Air Traffic Control  |
| ATIS                         | Automatic Terminal Information Service   |
| AWOS                         | Automated Weather Observing System   |
|                              |  |
| Bearing                      | The compass direction from the present position to a destination waypoint.   |
|                              |  |
| °C                           | degrees Celsius  |
| Calibrated Airspeed          | Indicated airspeed corrected for installation and instrument errors.   |
| cm                           | centimeter   |
| COM                          | communication radio  |
| Course                       | The line between two points to be followed by the aircraft.  |
| Course to Steer              | The recommended direction to steer in order to reduce course error or stay on course. Provides the most efficient heading to get back to the desired course and proceed along the flight plan. |

Crosstrack Error The distance the aircraft is off a desired course in either direction, left or right.

dBZ decibels 'Z' (radar return)

deg degree

Desired Track The desired course between the active "from" and "to" waypoints.

DIS distance

Distance The 'great circle' distance from the present position to a destination waypoint.

DME Distance Measuring Equipment

DTK Desired Track

Enroute Safe Altitude The recommended minimum altitude within ten miles left or right of the desired course on an active flight plan or direct-to.

ESA Enroute Safe Altitude

Estimated Time of Arrival The estimated time at which the aircraft should reach the destination waypoint, based upon current speed and track.

Estimated Time Enroute The estimated time it takes to reach the destination waypoint from the present position, based upon current ground speed.

ETA Estimated Time of Arrival

ETE Estimated Time Enroute

°F degrees Fahrenheit

FAA Federal Aviation Administration

FAF Final Approach Fix

FCC Federal Communication Commission

fpm feet per minute

FSS Flight Service Station

ft foot/feet

|                          |  |
|--------------------------|--|
| gal                      | gallon(s)  |
| Glide Ratio, G/R         | The estimated distance an aircraft will move forward for any given amount of lost altitude.  |
| gph                      | gallons per hour   |
| GPS                      | Global Positioning System  |
| Grid MORA                | Grid Minimum Off-Route Altitude; one degree latitude by one degree longitude in size and clears the highest elevation reference point in the grid by 1000 feet for all areas of the grid |
| Ground-Based Transceiver | Provides ADS-R, TIS-B and FIS-B broadcasts to ADS-B participating aircraft.  |
| Groundspeed              | The velocity that the aircraft is travelling relative to a ground position.  |
| Ground Track             | see Track  |
| GS                       | Ground speed   |
| Heading                  | The direction an aircraft is pointed, based upon indications from a magnetic compass or a properly set directional gyro.   |
| Hg                       | mercury  |
| hPa                      | hectopascal  |
| hr                       | hour   |
| HSI                      | Horizontal Situation Indicator   |
| Hz                       | Hertz  |
| IAF                      | Initial Approach Fix   |
| IAT                      | Indicated Air Temperature  |
| ICAO                     | International Civil Aviation Organization  |
| IFR                      | Instrument Flight Rules  |
| ILS                      | Instrument Landing System  |
| IMC                      | Instrument Meteorological Conditions   |

## Overview

|           |  |
|-----------|--|
| in        | inch   |
| Indicated | Information provided by properly calibrated and set instrumentation on the aircraft panel. |
| in HG     | inches of mercury  |

## GPS Navigation

|     |           |
|-----|-----------|
| kg  | kilogram  |
| kHz | kilohertz |
| km  | kilometer |
| kt  | knot      |

## Flight Planning

|     |   |
|-----|---|
| LAT | latitude  |
| lb  | pound   |
| Leg | The portion of a flight plan between two waypoints. |

## Hazard Avoidance

|     |           |
|-----|-----------|
| LOC | localizer |
| LON | longitude |

## Additional Features

|                       |   |
|-----------------------|---|
| m                     | meter   |
| MAP                   | Missed Approach Point   |
| METAR                 | Meteorological Aviation Routine   |
| MHz                   | megahertz   |
| Minimum Safe Altitude | Uses Grid MORAs to determine a safe altitude within ten miles of the aircraft present position. |

## Appendices

|     |                          |
|-----|--------------------------|
| MOA | Military Operations Area |
| MSA | Minimum Safe Altitude    |
| MSL | Mean Sea Level           |

## Index

|        |                        |
|--------|------------------------|
| NAVAID | NAVigation AID         |
| NDB    | Non-directional Beacon |
| NEXRAD | Next Generation Radar  |
| nm     | nautical mile(s)       |



|        |  |
|--------|--|
| OAT    | Outside Air Temperature  |
| OBS    | Omni Bearing Selector  |
| psi    | pounds per square inch   |
| QTY    | quantity   |
| rpm    | revolutions per minute   |
| SBAS   | Satellite-Based Augmentation System  |
| SD     | Secure Digital   |
| sec    | second(s)  |
| SIGMET | Significant Meteorological Information   |
| TA     | Traffic Advisory   |
| TACAN  | Tactical Air Navigation System   |
| TAF    | Terminal Aerodrome Forecast  |
| TAS    | True Airspeed  |
| TCAS   | Traffic Collision Avoidance System   |
| TFR    | Temporary Flight Restriction   |
| TIS-A  | Traffic Information Service  |
| TIS-B  | Traffic Information Service-Broadcast  |
| Track  | Direction of aircraft movement relative to a ground position;<br>also 'Ground Track' |
| TRSA   | Terminal Radar Service Area  |
| UTC    | Coordinated Universal Time   |
| VFR    | Visual Flight Rules  |
| VHF    | Very High Frequency  |

|        |   |
|--------|---|
| VNAV   | vertical navigation   |
| VOR    | VHF Omni-directional Range  |
| VORTAC | very high frequency omnidirectional range station and tactical air navigation |

|     |                          |
|-----|--------------------------|
| VSI | Vertical Speed Indicator |
| VSR | Vertical Speed Required  |
| VTF | vector to final          |

|      |                               |
|------|-------------------------------|
| WAAS | Wide Area Augmentation System |
| WX   | weather                       |

# APPENDIX K: LICENSE AGREEMENT AND WARRANTY

## CONTACT GARMIN

---

Contact Garmin if you have any questions while using your aera. In the USA contact Garmin Product Support by phone: (913) 397-8200 or (800) 800-1020, Monday–Friday, 8 AM–5 PM Central Time; or go to [www.garmin.com/support](http://www.garmin.com/support).

In Europe, contact Garmin (Europe) Ltd. at +44 (0) 870.8501241 (outside the UK) or 0808 2380000 (within the UK).

## SOFTWARE LICENSE AGREEMENT

---

BY USING THE aera, YOU AGREE TO BE BOUND BY THE TERMS AND CONDITIONS OF THE FOLLOWING SOFTWARE LICENSE AGREEMENT. PLEASE READ THIS AGREEMENT CAREFULLY.

Garmin grants you a limited license to use the software embedded in this device (the “Software”) in binary executable form in the normal operation of the product. Title, ownership rights, and intellectual property rights in and to the Software remain with Garmin.

You acknowledge that the Software is the property of Garmin and is protected under the United States of America copyright laws and international copyright treaties. You further acknowledge that the structure, organization, and code of the Software are valuable trade secrets of Garmin and that the Software in source code form remains a valuable trade secret of Garmin. You agree not to decompile, disassemble, modify, reverse assemble, reverse engineer, or reduce to human readable form the Software or any part thereof or create any derivative works based on the Software. You agree not to export or re-export the Software to any country in violation of the export control laws of the United States of America.

## LIMITED WARRANTY

---

This Garmin product is warranted to be free from defects in materials or workmanship for one year from the date of purchase. Within this period, Garmin will, at its sole option, repair or replace any components that fail in normal use. Such repairs or replacement will be made at no charge to the customer for parts or labor, provided that the customer shall be responsible for any transportation cost. This warranty does not cover failures due to abuse, misuse, accident, or unauthorized alteration or repairs. In addition, Garmin reserves the right to refuse warranty claims against products or services that are obtained and/or used in contravention of the laws of any country.

This product is intended to be used only as a travel aid and must not be used for any purpose requiring precise measurement of direction, distance, location, or topography. Garmin makes no warranty as to the accuracy or completeness of map data in this product.

THE WARRANTIES AND REMEDIES CONTAINED HEREIN ARE EXCLUSIVE AND IN LIEU OF ALL OTHER WARRANTIES EXPRESS, IMPLIED, OR STATUTORY, INCLUDING ANY LIABILITY ARISING UNDER ANY WARRANTY OF MERCHANTABILITY OR FITNESS FOR A PARTICULAR PURPOSE, STATUTORY OR OTHERWISE. THIS WARRANTY GIVES YOU SPECIFIC LEGAL RIGHTS, WHICH MAY VARY FROM STATE TO STATE.

IN NO EVENT SHALL GARMIN BE LIABLE FOR ANY INCIDENTAL, SPECIAL, INDIRECT, OR CONSEQUENTIAL DAMAGES, WHETHER RESULTING FROM THE USE, MISUSE, OR INABILITY TO USE THIS PRODUCT OR FROM DEFECTS IN THE PRODUCT. SOME STATES DO NOT ALLOW THE EXCLUSION OF INCIDENTAL OR CONSEQUENTIAL DAMAGES, SO THE ABOVE LIMITATIONS MAY NOT APPLY TO YOU.

Garmin retains the exclusive right to repair or replace the unit or software or offer a full refund of the purchase price at its sole discretion. SUCH REMEDY SHALL BE YOUR SOLE AND EXCLUSIVE REMEDY FOR ANY BREACH OF WARRANTY.

To obtain warranty service, contact your local Garmin authorized dealer or call Garmin Product Support for shipping instructions and an RMA tracking number. Securely pack the unit and a copy of the original sales receipt, which is required as the proof of purchase for warranty repairs. Write the tracking number clearly on the outside of the package. Send the unit, freight charges prepaid, to any Garmin warranty service station.

Online Auction Purchases: Products sold through online auctions are not eligible for rebates or other special offers from Garmin. Online auction confirmations are not accepted for warranty verification. To obtain warranty service, an original or copy of the sales receipt from the original retailer is required. Garmin will not replace missing components from any package purchased through an online auction.

International Purchases: A separate warranty is provided by international distributors for units purchased outside the United States. This warranty is provided by the local in-country distributor and this distributor provides local service for your unit. Distributor warranties are only valid in the area of intended distribution. Units purchased in the United States or Canada must be returned to the Garmin service center in the United Kingdom, the United States, Canada, or Taiwan for service.

## AOPA AIRPORT DIRECTORY NOTICE

AOPA MEMBERSHIP PUBLICATIONS, INC. AND ITS RELATED ORGANIZATIONS (HEREINAFTER COLLECTIVELY "AOPA") EXPRESSLY DISCLAIM ALL WARRANTIES, WITH RESPECT TO THE AOPA INFORMATION INCLUDED IN THIS DATA, EXPRESS OR IMPLIED, INCLUDING, BUT NOT LIMITED TO, THE IMPLIED WARRANTIES OF MERCHANTABILITY AND FITNESS FOR A PARTICULAR PURPOSE. THE INFORMATION IS PROVIDED "AS IS" AND AOPA DOES NOT WARRANT OR MAKE ANY REPRESENTATIONS REGARDING ITS ACCURACY, RELIABILITY, OR OTHERWISE. UNDER NO CIRCUMSTANCES INCLUDING NEGLIGENCE, SHALL AOPA BE LIABLE FOR ANY INCIDENTAL, SPECIAL OR CONSEQUENTIAL DAMAGES THAT RESULT FROM THE USE OR INABILITY TO USE THE SOFTWARE OR RELATED DOCUMENTATION, EVEN IF AOPA OR AN AOPA AUTHORIZED REPRESENTATIVE HAS BEEN ADVISED OF THE POSSIBILITY OF SUCH DAMAGES. USER AGREES NOT TO SUE AOPA AND, TO THE MAXIMUM EXTENT ALLOWED BY LAW, TO RELEASE AND HOLD HARMLESS AOPA FROM ANY CAUSES OF ACTION, CLAIMS OR LOSSES RELATED TO ANY ACTUAL OR ALLEGED INACCURACIES IN THE INFORMATION ARISING OUT OF GARMIN'S USE OF THE INFORMATION IN THE DATASETS. SOME JURISDICTIONS DO NOT ALLOW THE LIMITATION OR EXCLUSION OF IMPLIED WARRANTIES OR LIABILITY FOR INCIDENTAL OR CONSEQUENTIAL DAMAGES SO THE ABOVE LIMITATIONS OR EXCLUSIONS MAY NOT APPLY TO YOU.

## AC-U-KWIK LICENSE AGREEMENT

AC-U-KWIK AND ITS RELATED ORGANIZATIONS (HEREINAFTER COLLECTIVELY "AC-U-KWIK ORGANIZATIONS") EXPRESSLY DISCLAIM ALL WARRANTIES WITH RESPECT TO THE AC-U-KWIK INFORMATION INCLUDED IN THIS DATA, EXPRESS OR IMPLIED, INCLUDING, BUT NOT LIMITED TO, THE IMPLIED WARRANTIES OF MERCHANTABILITY AND FITNESS FOR A PARTICULAR PURPOSE. THE INFORMATION IS PROVIDED "AS IS" AND AC-U-KWIK ORGANIZATIONS DO NOT WARRANT OR MAKE ANY REPRESENTATIONS REGARDING ITS ACCURACY, RELIABILITY, OR OTHERWISE. LICENSEE AGREES NOT TO SUE AC-U-KWIK ORGANIZATIONS AND, TO THE MAXIMUM EXTENT ALLOWED BY LAW, TO RELEASE AND HOLD HARMLESS AC-U-KWIK ORGANIZATIONS FROM ANY CAUSES OF ACTION, CLAIMS OR LOSSES

RELATED TO ANY ACTUAL OR ALLEGED INACCURACIES IN THE INFORMATION ARISING OUT OF GARMIN'S USE OF THE INFORMATION IN THE DATASETS. SOME JURISDICTIONS DO NOT ALLOW THE LIMITATION OR EXCLUSION OF IMPLIED WARRANTIES OR LIABILITY FOR INCIDENTAL OR CONSEQUENTIAL DAMAGES SO THE ABOVE LIMITATIONS OR EXCLUSIONS MAY NOT APPLY TO LICENSEE.

## **XM SATELLITE RADIO SERVICE AGREEMENT**

XM Satellite Radio Inc.

Hardware and required monthly subscription sold separately. Subscription fee is consumer only. Other fees and taxes, including a one-time activation fee may apply. All programming fees and weather data subject to change. XM WX weather data displays and individual product availability vary by hardware equipment. Reception of the XM signal may vary depending on location. Subscriptions subject to Customer Agreement included with the XM Welcome Kit and available at xmradio.com. Available only in the 48 contiguous United States. XM WX is a trademark of XM Satellite Radio Inc.

Contact XM Satellite Radio by phone at 800.985.9200 to subscribe to XM WX Weather and/or XM Radio.

## **WEATHER DATA WARRANTY**

THE WEATHER DATA SOFTWARE PRODUCT IS PROVIDED "AS IS." ALL OTHER WARRANTIES, EXPRESSED OR IMPLIED, INCLUDING ANY WARRANTY OF MERCHANTABILITY OR FITNESS FOR A PARTICULAR PURPOSE OR OF NON-INFRINGEMENT ARE HEREBY EXCLUDED.

### **USER SAFETY**

If you use XM Services it is your responsibility to exercise prudent discretion and observe all safety measures required by law and your own common sense. You assume the entire risk related to your use of the Services. XM and Garmin assume no responsibility for accidents resulting from or associated with use of the Services. Your Radio Service includes traffic and weather information, and you acknowledge that such information is not for "safety for life", but is merely supplemental and advisory in nature, and therefore cannot be relied upon as safety-critical in connection with any aircraft, sea craft or automobile usage. This information is provided "as is" and XM and Garmin disclaim any and all warranties, express and implied, with respect thereto or the transmission or reception thereof. XM and Garmin further do not warrant the accuracy, reliability, completeness or timeliness of the traffic and weather information disclosed on the Radio Service. In no event will XM and Garmin, their data suppliers, service providers, marketing/distribution, software or Internet partners or hardware manufacturers be liable to you or to any third party for any direct, indirect, incidental, consequential, special, exemplary or punitive damages or lost profits resulting from use of or interruptions in the transmission or reception of the Services.

### **LIMITS ON OUR RESPONSIBILITY**

#### **a) DISCLAIMERS.**

EXCEPT AS EXPRESSLY PROVIDED HEREIN, WE MAKE NO WARRANTY OR REPRESENTATION, EITHER EXPRESS OR IMPLIED, REGARDING THE RADIO SERVICE. YOUR USE OF THE SERVICE IS AT YOUR SOLE RISK. THE CONTENT AND FUNCTIONALITY OF THE SERVICE IS PROVIDED "AS IS" WITHOUT ANY WARRANTY OF ANY KIND, EXPRESS OR IMPLIED. ALL SUCH WARRANTIES OR REPRESENTATIONS (INCLUDING, WITHOUT LIMITATION, THE IMPLIED WARRANTIES OF MERCHANTABILITY, FITNESS FOR A PARTICULAR PURPOSE, TITLE AND NON-INFRINGEMENT) ARE HEREBY DISCLAIMED.

#### **b) LIMITATIONS OF LIABILITY.**

WE ARE NOT RESPONSIBLE FOR ANY SPECIAL, INCIDENTAL, OR CONSEQUENTIAL DAMAGES OR LOSSES RELATING TO THE USE OF THE RADIO SERVICE, WHETHER BASED ON NEGLIGENCE OR OTHERWISE. OUR TOTAL LIABILITY TO YOU AND ANY OTHER PERSONS RECEIVING OUR SERVICES, REGARDLESS OF THE CAUSE, WILL IN

NO EVENT EXCEED THE AMOUNTS THAT YOU HAVE PAID TO US FOR THE SERVICE THAT YOU RECEIVED DURING THE SIX (6) MONTH PERIOD IMMEDIATELY PRIOR TO THE SPECIFIC EVENT THAT GAVE RISE TO THE APPLICABLE DAMAGE OR LOSS. THIS ALLOCATION OF RISK IS REFLECTED IN OUR PRICES. YOU MAY HAVE GREATER RIGHTS THAN DESCRIBED ABOVE UNDER YOUR STATE'S LAWS

This product was developed using DAFIF™, a product of the National Geospatial-Intelligence Agency.

This product has not been endorsed or otherwise approved by the National Geospatial-Intelligence Agency, or the United States Department of Defense (10 U.S.C. 425)

- a. Under 10 U.S.C. 456, no civil action may be brought against the United States on the basis of the content of a navigational aid prepared or disseminated by either the former Defense Mapping Agency (DMA), National Imagery and Mapping Agency (NIMA), or the National Geospatial-Intelligence Agency (NGA).
- b. The DAFIF™ product is provided "as is," and no warranty, express or implied, including, but not limited to the implied warranties of merchantability and fitness for particular purpose or arising by statute or otherwise in law or from a course of dealing or usage in trade, is made by NGA as to the accuracy and functioning of the product.
- c. Neither NGA nor its personnel will be liable for any claims, losses, or damages arising from or connected with the use of this product. The user agrees to hold harmless the United States National Geospatial-Intelligence Agency. The user's sole and exclusive remedy is to stop using the DAFIF product.

## FCC COMPLIANCE

This device complies with part 15 of the FCC Rules. Operation is subject to the following two conditions: (1) this device may not cause harmful interference, and (2) this device must accept any interference received, including interference that may cause undesired operation.

This equipment has been tested and found to comply with the limits for a Class B digital device, pursuant to part 15 of the FCC rules. These limits are designed to provide reasonable protection against harmful interference in a residential installation. This equipment generates, uses, and can radiate radio frequency energy and may cause harmful interference to radio communications if not installed and used in accordance with the instructions. However, there is no guarantee that interference will not occur in a particular installation. If this equipment does cause harmful interference to radio or television reception, which can be determined by turning the equipment off and on, the user is encouraged to try to correct the interference by one of the following measures:

- Reorient or relocate the receiving antenna.
- Increase the separation between the equipment and the receiver.
- Connect the equipment into an outlet that is on a different circuit from the GPS unit.
- Consult the dealer or an experienced radio/TV technician for help.

This product does not contain any user-serviceable parts. Repairs should only be made by an authorized Garmin service center. Unauthorized repairs or modifications could result in permanent damage to the equipment, and void your warranty and your authority to operate this device under Part 15 regulations.

## INDUSTRY CANADA COMPLIANCE

Category I radio communication devices comply with Industry Canada Standard RSS-210.

**A**

- Abnormal Operation 145
- Acquiring Satellites 5
- AC-U-KWIK 127, 153
- Additional Features 125
- ADS-B 123
- Aircraft Profile 184
- AIRMETs 86, 101
- Airspace 62
  - Alert Messages 62
  - Smart 63
- Airways 45
- Alerts 139
  - Terrain 110
- AOPA 127, 153
- AOPA Data 127
- Approach
  - Selecting 76
- ARTCC 61
- Aural Alerts 111, 143
- Autolocate 5
- Autozoom 19

**B**

- Backlight 25
- Baro Pressure 182
- Battery
  - Charging 3
  - Information 169
  - Installation 2
  - Life 169
  - Replacement 169
- BKSP 7
- Bug Indicator 36, 38

**C**

- Calibrate 25
- Calibrated Airspeed 182

- Category 131
- CDI Scale 38
- Channel List 132
- Charge Mode 3
- Charging, the battery 3
- Cities 60
- Compass Arc 36
  - Bug Indicator 36
- Computer, connecting to 147
- Connecting, cables 157
- Copying, Flight Plans 73
- Course, setting 39
- Current Icing Product (CIP) 89

**D**

- Database
  - Updates 152
- Databases 147
- Data Entry 16
  - Alphanumeric Data 17
  - Predetermined Data Option 17
- Data Field
  - Options 34
- Data Field Options 139
- Data Fields 32
- Declutter 23
- Direct-to 7, 64
  - Cancelling 66
- Display
  - Backlight Intensity 25
  - Backlight Timeout 25
  - Calibrate 25

**E**

- Echo Tops 83
- Estimated Position Error (EPE) 186
- external GPS Antenna 167

**F**

Favorites 133  
 Files, managing 148  
 Flight Log 177  
 Flight Plan  
   Activation 72  
   Active 69  
   Copying 73  
   Creation 68  
   Data Fields 67  
   Deleting 73  
   Editing 72  
   Fuel Flow 72  
   Inverting 74

## Flight Plan

Storage 69

Forecast 90

Freezing Levels 88

FSS 61

Fuel Flow 72

Fuse, changing 169

**G**

GDL 39 94, 95, 115, 124

GPS Navigation 31

GPS Receiver Status 5

GTX 330 162

GXM 40 Antenna 161

**H**

Hazard Display 145

Heading Line 181, 182

'Home' Screen 8

HSI/Panel 37

**I**

Icing Forecast 89

Indicated Altitude 182

Interfacing 165

Intersections 54

Inverting, flight plans 74

**L**

Lightning 84

Location Formats 195

Loss of GPS Position 145

Lost Satellite Reception 5

**M**

Managing Files 148

## Map

  Autozoom 19

  Declutter 23

  Detail 23

  Display Setup 43

  Orientation 43

  Overlays 22

  Panning 20

  Range 19

  Symbols 23, 189

Map Datum 195

Map Feature

  Button 20

  Information 21

Messages 139

METARs 85, 100

MicroSD Card 150

  Installing 150

Modes

  Changing 4

Mounting, in aircraft 155



**N**

- Navigation Controls 7
- NDBs 54
- Nearest 9, 49
  - Airport Criteria 51
- Nearest Airport Criteria 28
  - Entering 28
  - Restoring 28
- Nearest Type, Changing 29
- New Location 29
- NEXRAD 81, 98
- NMEA 166
- Numeric Data Options 141
- Numeric Flight Data 35

**O**

- Obstacle
  - Color Code 108
- Obstacles 107
- Option Menu 16
- Orientation, map 43
- Overlay
  - Satellite Imagery 22
  - Terrain 22
  - Topography 22
  - Weather 22
- Overlays
  - Displaying/removing 22

**P**

- Panel 37
- PIREPs 88, 103
- POWER Button 4
- Present Position 29
- Proximity Waypoints 187

**R**

- Red X 145
- Runways 47

**S**

- SafeTaxi 125
- Satellite Information 6
- Satellite Mosaic 82
- Scrolling 15
- SD Card 147
- Searching the Sky 5
- Settings 24
- SIGMETs 86, 101
- Simulator Mode 30
- Smart Airspace 63
- Sound
  - Adjusting 25
  - Muting 26
- Storm Cells 84
- Supercooled Large Droplet (SLD) 89
- Surface Pressure 91
- System Settings
  - Display 24

**T**

- Tabs 18
- TAFs 85, 100
- Temperatures Aloft 100
- Temporary Flight Restrictions (TFRS) 87
- Terrain 106
  - Alerts 110
  - Audio 111
  - Aural Alerts 111
  - Views 108
- Tools 12
- Touchscreen 25
- Touchscreen, cleaning 170

Track Log 178  
Traffic Data 113  
Traffic Ground Track 113  
Traffic Information Service (TIS-A)  
Alerts 112  
Configuring 162, 163  
traffic warning window 122  
Transferring Files 149  
Transponder 162  
Turbulence Forecast 89

**U**

Universal Access Transceiver 115  
Updates, database 152  
USB Drivers 161  
User Waypoints 56  
Creating 56  
Deleting 59  
Utilities 177

**V**

Vectors-to-Final 78  
Vertical Navigation (VNAV) 40  
Profile 41  
VHF Comm Radio 159  
VORs 55

**W**

Warranty 203  
Waypoint Information Tabs 18  
Waypoints 46  
Proximity 187  
User 56  
Weather 51  
Weather Products 81  
Weight & Balance 185  
Winds Aloft 83, 99

**X**

## XM

Activating 80  
Animating 94, 105  
Legends 93, 105  
Radio 129  
Radio ID 80  
Weather 79  
Weather Products 81

**Y**

Yoke Mount 156





Garmin International, Inc.  
1200 East 151st Street  
Olathe, KS 66062, U.S.A.  
Toll free: 800.800.1020 or  
866.739.5687  
p: 913.397.8200  
f: 913.397.8282

Garmin AT, Inc.  
2345 Turner Road SE  
Salem, OR 97302, U.S.A.  
Toll free: 800.525.6726  
p: 503.391.3411  
f: 503.364.2138

Garmin (Europe) Ltd  
Liberty House, Bulls Copse Road  
Hounslow Business Park  
Southampton, SO40 9RB, U.K.  
Toll free (within U.K.) 0808.2380000  
p: 44/0870.8501241  
f: 44/0870.8501251

Garmin Corporation  
No. 68, Jangshu 2nd Road  
Shijr, Taipei County, Taiwan  
p: 886/2.2642.9199  
f: 886/2.2642.9099

[www.garmin.com](http://www.garmin.com)