

GPSMAP 162

chartplotting receiver



owner's
manual
and
reference
guide

© 2000-2001 GARMIN Corporation

Software Version 2.50 or above
Internal Database Version 2.00

GARMIN International, Inc., 1200 East 151st Street, Olathe, KS 66062, U.S.A.
Tel. 913/397.8200 or 800/800.1020 Fax 913/397.8282

GARMIN (Europe) Ltd., Unit 5, The Quadrangle, Abbey Park Industrial Estate, Romsey SO51 9AQ, U.K.
Tel. 44/1794.519944 Fax 44/1794.519222

GARMIN Corporation, No. 68, Jangshu 2nd Road, Shijr, Taipei County, Taiwan
Tel. 886/2.2642.9199 Fax 886/2.2642.9099

All rights reserved. Except as expressly provided herein, no part of this manual may be reproduced, copied, transmitted, disseminated, downloaded or stored in any storage medium, for any purpose without prior written consent of GARMIN Corporation. GARMIN Corporation hereby grants permission to download a single copy of this manual onto a hard drive or other electronic storage medium to be viewed for personal use, provided that such electronic or printed copy of this manual or revision must contain the complete text of this copyright notice and provided further that any unauthorized commercial distribution of this manual is strictly prohibited.

Information in this manual is subject to change without notice. GARMIN Corporation reserves the right to change or improve its products and to make changes in the content without obligation to notify any person or organization of such changes. Visit the GARMIN website (www.garmin.com) for current updates and supplemental information concerning the use and operation of this and other GARMIN products.

Foreward



GARMIN®, *Autolocate®*, and *TracBack®* are registered trademarks, *MapSource™*, and *BlueChart™* are trademarks of GARMIN Corporation and may not be used without the express permission of GARMIN Corporation.

Introduction

Preface and Registration



Why should you register your GARMIN GPS unit:

- Notification of Product Updates
- Notification of New Products
- Lost or Stolen unit tracking

Preface

Congratulations on choosing one of the most advanced marine navigation systems available! The GARMIN GPSMAP 162 utilizes the proven performance of GARMIN GPS and full featured mapping to create an unsurpassed marine navigation chartplotter.

To get the most out of your new navigation system, take the time to go through this owner's manual and learn the operating procedures for your unit. This manual is broken down into two parts for your convenience.

Part One introduces you to the GPSMAP 162 and provides a Getting Started tour so you may become more familiar with the unit. This section will provide you with a basic working knowledge necessary to use the unit to its fullest potential.

Part Two is divided into sections that provide detailed references to the advanced features and operations of the GPSMAP 162. This allows you to concentrate on a specific topic quickly and look up detailed information about the GPSMAP 162.

Customer Service Product Registration

Help us better support you by completing our on-line registration today! Have the serial number of your GPSMAP 162 handy and connect to our website (www.garmin.com). Look for the Product Registration link on the Home page. Also, be sure to record your serial number in the area provided on page iv of this manual.



NOTE: If you have previously registered a GARMIN product purchase using a mail-in registration card, we invite you to re-register using our NEW on-line system. Many services provided by our new product registration system are now being automated and re-registering your purchase ensures you the best possible support from GARMIN.

Warning and Precautions

The GPS system is operated by the United States government, which is solely responsible for its accuracy and maintenance. The system is subject to changes which could affect the accuracy and performance of all GPS equipment. Although the GARMIN GPSMAP 162 is a precision electronic NAVigation AID (NAVAID), any NAVAID can be misused or misinterpreted and, therefore, become unsafe.

The electronic chart is an aid to navigation and is designed to facilitate the use of authorized government charts, not replace them. Only official government charts and notices to mariners contain all information needed for safe navigation – and, as always, the user is responsible for their prudent use.

Use the GPSMAP 162 at your own risk. To reduce the risk of unsafe operation, carefully review and understand all aspects of this Owner's Manual—and thoroughly practice operation using the simulator mode prior to actual use. When in actual use, carefully compare indications from the GPSMAP 162 to all available navigation sources, including the information from other NAVAIDS, visual sightings, charts, etc. For safety, always resolve any discrepancies before continuing navigation.

NOTE: This equipment generates, uses and can radiate radio frequency energy and, if not installed and used in accordance with the instructions, may cause harmful interference to radio communications. There is no guarantee that interference will not occur in a particular installation. If this equipment does cause harmful interference, the user is encouraged to try to correct the interference by relocating the equipment or connecting the equipment to a different circuit. Consult an authorized dealer or other qualified technician for additional help if these remedies do not correct the problem.

This device complies with Part 15 of the FCC limits for class B digital devices for home or office use. Operation is subject to the following conditions: (1) This device may not cause harmful interference, and (2) this device must accept any interference received, including interference that may cause undesired operation.

MAP DATA INFORMATION: One of the goals of GARMIN is to provide customers with the most complete and accurate cartography that is available to us at a reasonable cost. We use a combination of governmental and private data sources, which we identify (as required) in product literature and copyright messages displayed to the consumer. Virtually all data sources contain inaccurate or incomplete data to some degree. This is particularly true outside the United States, where complete and accurate digital data is either not available or prohibitively expensive.



CAUTION: IT IS THE USER'S RESPONSIBILITY TO USE THIS PRODUCT PRUDENTLY. THIS PRODUCT IS INTENDED TO BE USED ONLY AS A NAVIGATIONAL AID AND MUST NOT BE USED FOR ANY PURPOSE REQUIRING PRECISE MEASUREMENT OF DIRECTION, DISTANCE, LOCATION, OR TOPOGRAPHY.

Introduction

Warranty and Serial Number

Serial Number

Use this area to record the serial number (8-digit number located on the bottom of the unit) in case it is lost, stolen, or needs service. Be sure to keep your original sales receipt in a safe place or attach a photocopy inside the manual.

Serial Number:

--	--	--	--	--	--	--	--



The GARMIN GPSMAP 162 has no user-serviceable parts. Should you ever encounter a problem with your unit, please take it to an authorized GARMIN dealer for repairs. The GPSMAP 162 is fastened shut with screws. Any attempt to open the case to change or modify the unit in any way will void your warranty and may result in permanent damage to the equipment.

LIMITED WARRANTY

GARMIN Corporation warrants this product to be free from defects in materials and workmanship for one year from the date of purchase. GARMIN will, at its sole option, repair or replace any components that fail in normal use. Such repairs or replacement will be made at no charge to the customer for parts or labor. The customer is, however, responsible for any transportation costs. This warranty does not cover failures due to abuse, misuse, accident or unauthorized alteration or repairs.

THE WARRANTIES AND REMEDIES CONTAINED HEREIN ARE EXCLUSIVE AND IN LIEU OF ALL OTHER WARRANTIES EXPRESS OR IMPLIED OR STATUTORY, INCLUDING ANY LIABILITY ARISING UNDER ANY WARRANTY OF MERCHANTABILITY OR FITNESS FOR A PARTICULAR PURPOSE, STATUTORY OR OTHERWISE. THIS WARRANTY GIVES YOU SPECIFIC LEGAL RIGHTS, WHICH MAY VARY FROM STATE TO STATE.

IN NO EVENT SHALL GARMIN BE LIABLE FOR ANY INCIDENTAL, SPECIAL, INDIRECT OR CONSEQUENTIAL DAMAGES, WHETHER RESULTING FROM THE USE, MISUSE, OR INABILITY TO USE THIS PRODUCT OR FROM DEFECTS IN THE PRODUCT. SOME STATES DO NOT ALLOW THE EXCLUSION OF INCIDENTAL OR CONSEQUENTIAL DAMAGES, SO THE ABOVE LIMITATIONS MAY NOT APPLY TO YOU.

To obtain warranty service, call the GARMIN Customer Service department (913/397.8200) for a returned merchandise tracking number. The unit should be securely packaged with the tracking number clearly marked on the outside of the package and sent freight prepaid and insured to a GARMIN warranty service station. A copy of the original sales receipt is required as the proof of purchase for warranty repairs. GARMIN retains the exclusive right to repair or replace the unit or software or offer a full refund of the purchase price at its sole discretion. SUCH REMEDY SHALL BE YOUR SOLE AND EXCLUSIVE REMEDY FOR ANY BREACH OF WARRANTY.

Designed for detailed electronic charting capability, the GARMIN GPSMAP 162 is a powerful navigation device that can give you the navigation information you need:

Precision Performance

- High-contrast, four-level gray, LCD screen with backlighting
- 12-channel parallel receiver tracks and uses up to 12 satellites for fast, accurate positioning
- WAAS Capable
- Differential-Ready
- Fully gasketed, high-impact plastic alloy case, waterproof to IEC 529-IPX-7

Advanced Navigating and Plotting

- 500 alphanumeric waypoints with selectable icons and comments
- Built-in Americas basemap to 20 miles includes detailed ocean, river and lake coastlines, cities, interstates, US state highways and local thoroughfares
- 20 reversible routes with up to 30 waypoints each
- Uploadable maps up to 2.5 Megabytes of data using GARMIN's MapSource PC products
- Coordinates: Lat/Lon, UTM/UPS, Loran TD, plus 15 grids, including Maidenhead
- TracBack route feature which allows you to quickly retrace your track log to a starting position
- Built-in simulator mode

Index Tab Top

Index Tab Bottom

Before installing and getting started with your unit, please check to see that your package includes the following items. **If any parts are missing, please contact your GARMIN dealer immediately.**

Standard Package:

- GPSMAP 162 Unit
- Bail Mount with knobs
- Mounting Bracket*
- Mount Bracket with Internal Antenna**
- GA 29 Remote Marine Antenna with 30' cable and BNC connector*
- MapSource Fishing Hot Spots and MapSource Waterways & Lights CD-ROMs***
- Power/Data Cable
- AC Power/PC Interface Cable
- Protective Cover
- Owner's Manual and Quick Reference Guide

* Included with part number 010-00191-00.

** Included with part number 010-00192-00.

*** Included with part number 010-00192-03.

Optional Accessories:

- Cigarette Lighter Adapter
- PC Interface Cable
- EURO A/C PC Adapter
- MapSource CDs: Fishing Hot Spots, BlueChart, US Waterways & Lights, US Topo, US Roads & Recreation, European Roads & Recreation, and WorldMap
- GA 26C Remote Automobile Antenna with mounts, 30' cable and BNC connector
- GA 29F Surface Mount GPS Antenna with 30' cable and BNC connector
- Second Mounting Station
- Flush Mounting Kit
- 1" RAM Swivel Mount

Introduction i-viii

Foreword i
Preface and Registration ii
Warnings and Precautions iii
Warranty and Serial Number iv
Capabilities v
Packing List vi
“How To” Index viii

Section One: Getting Started 1-17

Keypad Usage, Selecting Options, Entering Data, Initializing the Receiver, Power On/Off, Contrast, Backlighting, Simulator, Description of Main Pages, Simulated Tour

Section Two: Reference 18-71

Status Page and Options 18
Map Page and Options 22
 Map Page Configuration 29
Compass Page and Options 35
Highway Page and Options 36
Waypoints 38
 Creating 38
 Reviewing and Editing 40
 Options 42
 Nearest 44
 Proximity 44

Going to a Destination 46
 TracBack 48
 MOB 50
Routes 51
 Creating 51
 Route List Page 53
 Reviewing and Editing 54
Active Route Page 58
Main Menu Page 59
 Track Tab 60
 Trip, Time and Pages Tabs 62
 System Tab 63
 Units Tab 64
 Communication Tab 66
 Alarm Tab 68
 Celestial Tab 69
 Tide Tab 70

Appendix A: Loran TD 72

Appendix B: Time Offsets 74

Appendix C: Messages 75

Appendix D: Map Datums 77

Appendix E: Navigation Terms 79

Appendix F: Specifications 81

Appendix G: Installation 82

Appendix H: Advanced NMEA Setup 85

Appendix I: Index 86



Introduction

Table of Contents

Index Tab Top

Index Tab Bottom



The list to the right is provided to help you quickly find some of the more important procedures you will use on your new GPSMAP 162.

TO DO THIS:	SEE PAGE(S):
Turn the unit on or off	4, 6, 17
Initialize the GPS receiver (first time use)	4-5
Adjust screen contrast or backlighting	6-7
Enter data and select options	2-3
Learn how to operate the unit's function keys	1
Mark your present location as a waypoint	10, 38-39
Go to a destination	11-14, 46-50
Create and use a route	51-58
Learn about the Map page	8-9, 22-27
Pan using the map arrow	9, 23
Zoom in or out on the Map page	9, 27
Reconfigure the Map page display	28-34
Access the Main Menu	16, 59
Change units of measure (statute, nautical, metric)	64-65
Change the displayed time (zone)	62
Setup Loran TD	72-73
View tide information	70-71
View celestial information	69
Set Alarms	68
See current position, date and time	18
View a unit message	75

Keypad Usage

The IN Key

The **IN** key adjusts the map scale to display a smaller area with more detail. (Zooms in)

The OUT Key

The **OUT** key adjusts the map scale to display a larger area with less detail. (Zooms out)

The PAGE Key

The **PAGE** key selects the main pages in sequence and returns display from a submenu page.

The ARROW KEYPAD

The **ARROW KEYPAD** is used to select (Highlight) menu options and enter data. It also controls cursor movement on the Map Page.

The ENTER/MARK Key

The **ENTER/MARK** key selects a highlighted menu option. When entering data, it allows you to initiate entry, and then to accept the selected value(s). It also marks the current location as a waypoint when pressed and held for more than one second.

The QUIT Key

The **QUIT** key returns the display to the previous page and, when entering data, it restores the previous value (cancels data entry).

The MENU Key

The **MENU** key displays a menu of available options for the current page. Press twice to display the Main Menu.

The NAV/MOB Key

The **NAV/MOB** key displays the Go To and Follow navigation menu. It also activates the MOB (Man OverBoard) function when pressed and held for more than one second.

The POWER/BACKLIGHT/CONTRAST Key (☞)

The **POWER/BACKLIGHT/CONTRAST** key turns the unit and display illumination on/off .



*Always press and release a key to perform its primary function. Pressing and holding the **ENTER/MARK** or **NAV/MOB** keys will activate their secondary function.*

Getting Started

Selecting Options



Use the **ARROW KEYPAD** to highlight the next option. Press **ENTER/MARK** to activate the option.

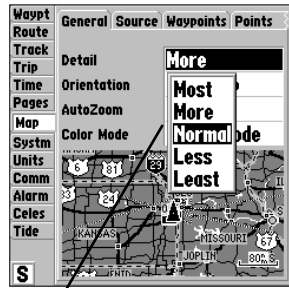

Pop-up list of options for a highlighted field.

How To Select Options and Enter Data

Before moving ahead into GPSMAP 162 features, you will need to learn basic operation. You can select and activate options and enter data to customize the GPSMAP 162 to fit your requirements. You can use the **ENTER/MARK** key and **ARROW KEYPAD** to select options, enter names and numbers in data fields, and activate your selections.

To select and activate an optional feature:

1. With any page displayed, press the **MENU** key to pop-up the options menu. The options menu will display a list of optional features which are specific for that particular page. To select any feature on the list of options requires movement of the cursor, which is identified as highlighting, selecting or choosing an item in a list or a field (box) on a page.
2. Use the **ARROW KEYPAD** to move the cursor (highlight) up and down a list or up, down, and sideways on menus.
3. Once you have moved to the selection desired, press the **ENTER/MARK** key to either activate the feature or pop-up a sub-menu or list of yet more feature options. Just repeat this process to select an option from the list or press the **QUIT** key to return to the previous setting.

The **QUIT** key when pressed, will move backwards through each step to the main page you started on.

To select and activate a function button:

1. When moving about a page with function buttons, like the 'New Map Waypoint' page, you will observe functions such as 'OK', 'Go To' and 'Delete'. To activate the function, highlight the desired button and press the **ENTER/MARK** key.

Naming a waypoint or placing any sort of data that has not been predefined requires the use of both the **ARROW KEYPAD** and the **ENTER/MARK** key.

To enter a name or number in a data field:

1. Once you have accessed a page with programmable data fields (i.e. 'Waypoint Edit') you can use the **ARROW KEYPAD** to move the cursor (highlight) to fields on the page. Use the UP/DOWN arrows to move up or down and the LEFT/RIGHT arrows to move sideways.
2. Pressing the **ENTER/MARK** key with the field highlighted begins the process for entering data in the form of alphanumeric characters.
3. Use the **ARROW KEYPAD** UP/DOWN arrows to cycle through numbers 0 to 9, plus/minus symbols, blank space, and the alphabet. Pressing and releasing the keypad moves you character by character through the list. Pressing and holding the keypad moves you rapidly through the list.
4. Use the **ARROW KEYPAD** LEFT/RIGHT arrows to move to the next character on the line or backwards to edit characters. If there are more than two lines of data, keep pressing to the RIGHT to drop down to the next line.
5. When data entry is completed, press **ENTER/MARK** to accept data, then move to the next programmable field. Not all data fields are programmable, like the date and time. When moving about a page with these type of fields, the cursor will skip over them.

Every field and button on this page can be programmed or activated.

• A waypoint symbol can be selected from a list of symbols.

• The coordinates can be changed.

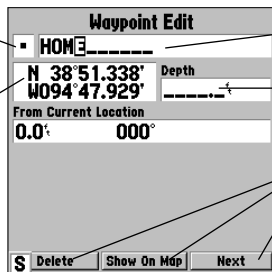

• The waypoint can be renamed.

• A depth can be entered.

• Option buttons can be activated.

Getting Started

Entering Data

N 28°28.327'
W 082°42.401'

N 28°28.328'
W 082°42.401'



Pressing UP or DOWN on the ARROW KEYPAD changes numbers and letters.

N 28°28.328'
W 082°42.401'

N 28°28.328'
W 082°42.401'

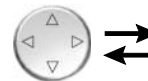

Pressing LEFT or RIGHT on the ARROW KEYPAD moves the cursor along the line or to the next line.

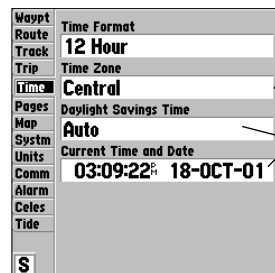

Data Entry Field

Non-programmable data fields

Getting Started

Initializing the Receiver

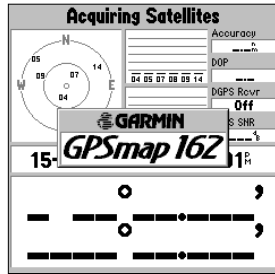

Self-Test Screen

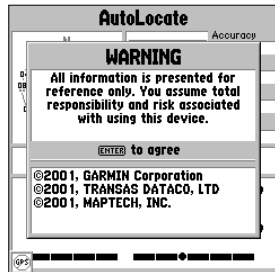

Warning Screen

The GPSMAP 162's advanced keypad system is designed to allow for fast, convenient selection of navigation options and data entry. The Getting Started Tour will introduce you to the keypad and provide a 'hands-on' lesson in using the GPSMAP 162. We strongly encourage you to take the Getting Started tour before using your unit for actual navigation.

The GPSMAP 162 Quick Reference Guide contains helpful tips on using the unit and performing various navigation tasks. It's a good idea to keep the Quick Reference Guide nearby whenever you're operating your new GPSMAP 162.

Initializing the Receiver

The first time you power up your new GPSMAP 162, the receiver must be given an opportunity to collect satellite data and establish its present position. To ensure proper initialization, the GPSMAP 162 is shipped from the factory in AutoLocate mode, which will allow the receiver to "find itself" anywhere in the world. To speed up the initialization process, we recommend using the graphic initialization process described on the next page, which will usually provide a position fix within a few minutes.

Before you initialize, make sure the GPSMAP 162 unit and antenna have been correctly installed on your vessel according to the instructions in Appendix G. The antenna needs to have a clear and unobstructed view of the sky to receive satellite signals.

To turn the GPSMAP 162 on:

1. Press and hold the **POWER** key until the power tone sounds and the display comes on, then release the **POWER** key.

The welcome page will appear while the unit conducts a self-test. Once the internal test is complete, a warning page will appear, asking you to read and acknowledge important information regarding the proper use of the unit.

To acknowledge the warning:

1. After reading the warning, press the **ENTER/MARK** key if you agree.

Initializing the Receiver

To graphically initialize the GPSMAP 162:

1. From the Status Page, press the **MENU** key. The Status Page options menu window will appear.
2. Using the **ARROW KEYPAD**, highlight 'Initialize Position' and press **ENTER/MARK** to initialize the receiver from the built-in worldwide map. The 'Initialize Position' page will appear, prompting you to select your approximate location with the map cursor.
3. Use the **ARROW KEYPAD** to move the map cursor and point to your approximate location within 100 miles. If you have difficulty identifying your location, press and release the **IN** key to zoom in to see the next lower map scale.
4. Once you have determined your approximate location on the map, press the **ENTER/MARK** key.



This does not "calibrate" the unit in any way, but rather helps to speed up the initial satellite acquisition. If the unit switches to the Map Page or displays '2D' or '3D Navigation' during this process, it is not necessary to initialize the unit.

The GPSMAP 162 will now begin searching for the appropriate satellites for your region and should acquire a fix within a few minutes. A signal strength bar for each satellite in view will appear on the top middle of the page, with the appropriate satellite number under each bar. The progress of satellite acquisition is shown in three stages:

- No signal strength bars—the receiver is looking for the satellites indicated.
- Hollow signal strength bars—the receiver has found the indicated satellite(s) and is collecting data.
- Solid signal strength bars—the receiver has collected the necessary data and the satellite(s) are ready for use.

Once the receiver has collected information from at least three satellites, the top of the screen will display either "2D or 3D Navigation", and the GPSMAP 162 will be ready for use.

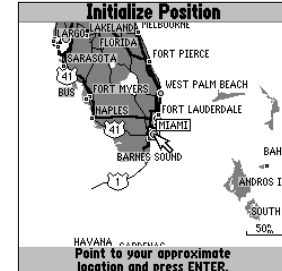

Point to your approximate location and press ENTER/MARK.

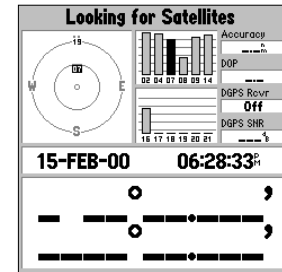

A satellite's signal bar will turn black when it's ready for use.

Getting Started

Power On/Screen Contrast

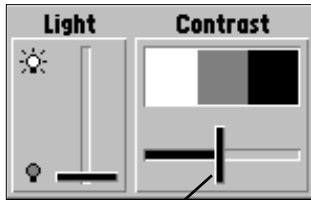

To adjust the screen contrast, press LEFT or RIGHT on the ARROW KEYPAD to move the contrast slider.

GPSMAP 162 Getting Started Tour

The GARMIN GPSMAP 162 is a powerful electronic navigation system that provides detailed map coverage and convenient control of many advanced features right from the screen display. This tour is designed to take you through the basic pages and functions of the system using the simulator mode. Once you're familiar with the main pages and functions of the unit, refer to the reference section for instructions on performing specific tasks and functions.

The Getting Started tour assumes that the receiver has been properly installed and initialized, and you have not changed any of the default unit settings. If you have changed any settings (position formats, units of measure, etc.), the descriptions and pictures in the tour may not match your configuration.

To turn on the GPSMAP 162:

1. Press and hold the **POWER** key until the power tone sounds, then release the **POWER** key. The Welcome Page will appear while the unit conducts a self-test.
2. Once the self-test is complete, press the **ENTER/MARK** key, if you agree, to acknowledge the warning.

The Status Page will appear as the receiver begins acquiring satellites. From the Status Page or any other page, you may also adjust the screen contrast and backlighting.

To adjust the screen contrast:

1. Press **POWER** and the Light and Contrast window will appear.
2. To decrease or increase the screen contrast, press LEFT or RIGHT on the **ARROW KEYPAD**.
3. Press the **ENTER/MARK** key to finish.

The GPSMAP 162's adjustable screen backlighting is controlled with the **POWER** key, and may be adjusted at any time from any page. The backlight can cycle through off, user-defined, and maximum backlight levels by repeatedly pressing the **POWER** key.

Backlighting/ Simulator Mode

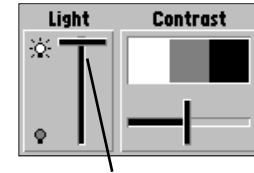

Press UP or DOWN on the ARROW KEYPAD to move the backlighting slider up for brighter or down for dimmer backlighting..

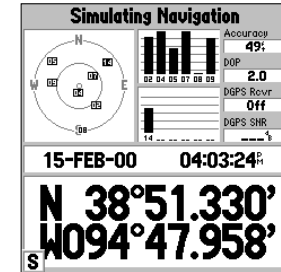

When the unit is in simulator mode, an 'S' will appear in the lower left corner of every screen and the Satellite Page will show "Simulating Navigation."

To turn on and adjust the backlighting:

1. Press **POWER** and the Light and Contrast window will appear.
2. Press **POWER** again and the user-defined level of backlighting will activate. You may adjust this level by pressing UP or DOWN on the **ARROW KEYPAD**. If you press **POWER** one more time, the backlighting will be at the maximum setting.
3. Press **ENTER/MARK** or **QUIT** when done.

The backlight will now cycle through off, the user-defined, and maximum backlight levels by repeatedly pressing the **POWER** key.

The GPSMAP 162's Status Page provides a visual reference of satellite acquisition, receiver status, date, time and position coordinates. Each page of the GPSMAP 162's system also features an options menu, giving you access to other functions and features related to the specific page you are viewing. To get a feel for how the options menus work, let's put the GPSMAP 162 into simulator mode.

To place the GPSMAP 162 in simulator mode:

1. From the Status Page, press the **MENU** key. A menu of options and functions for the Status Page will appear.
2. Press UP DOWN on the **ARROW KEYPAD** to highlight the 'Start Simulator' option and press **ENTER/MARK**.
3. Press the **ENTER/MARK** key to confirm the 'Running Simulator' message that appears at the bottom of the display.

Once the simulator has been started, the status field at the top of the page will display a 'Simulating Navigation' status. Now you're ready to continue the rest of the simulated tour.



The GPSMAP 162 does not track satellites in simulator mode, and this mode should never be used for actual navigation.

All the waypoint and route planning done in simulator mode will still be retained in memory for future use.

Getting Started

Status Page/ Map Page

The Status Page is one of five main pages used in the GPSMAP 162's system. The five main pages are: the Status Page, Map Page, Compass Page, Highway Page and Active Route Page. All five pages are linked together in a simple chain, which allows you to scroll through the pages in either direction using the **PAGE** and **QUIT** keys.

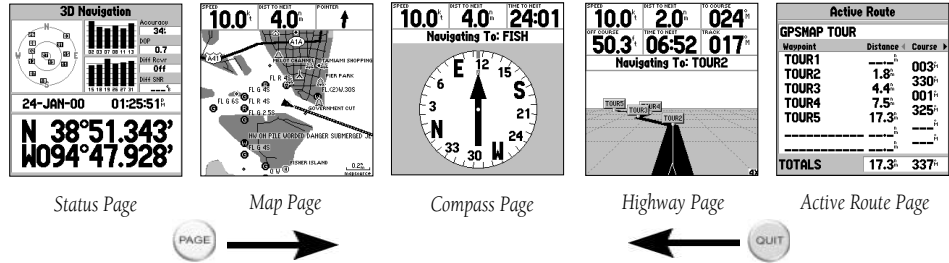

Status Page

Map Page

Compass Page

Highway Page

Active Route Page

To continue the tour, let's move on to the next page, the Map Page.

To scroll to the next page in sequence:

1. Press the **PAGE** key.

The GPSMAP 162's Map Page combines digital chartplotting with a user-selectable display of navigation data and a built-in worldwide database to 20 mi. It will also be the page you use most to create and edit waypoints and routes. Before we take off on our practice route, let's take a brief look at its various features and displays.

The map display shows your "boat" as a triangle marker on an electronically generated chart. Geographic names, roads, markers and buoys that are provided by the optional MapSource data are also shown. It also displays your track, routes and nearby waypoints. An on-screen cursor lets you pan to other map areas, determine the range and bearing to a position, and perform various waypoint and route functions.

The data window, located at the top of the page, provides a user-selectable display of various navigation data, including course, speed over ground, and bearing and distance to the cursor or a particular waypoint. The current map scale setting is located at the bottom right of the page.

Getting Started

Using the Map Cursor

Working from the Map Page is a simple process that centers around the use of the cursor. Controlled by the **ARROW KEYPAD**, the cursor is an important tool that can be used to pan to other map locations, mark and edit waypoints and routes, and review position data of on-screen map items and waypoints.

To get a feel for using the Map Page and using the cursor, try the following exercise:

1. Use the **IN/OUT** keys to set the map scale to the 50 nm setting. Your boat should be near the center of the map, at the receiver's last known position. (If your boat isn't where it should be, make sure that you have initialized the receiver and acquired a position as described on pages 1-2.)
2. Use the **ARROW KEYPAD** to move the cursor. Notice how another data field appears at the top of the page, showing the bearing and distance from your boat to the cursor, along with the latitude/longitude of the cursor.
3. Press the **QUIT** key to remove the cursor and re-center your boat on the map display.

As you become more familiar with the cursor, you'll see that the map display actively scrolls or 'pans', letting you explore areas around the world and create waypoints and routes. Wherever you move the cursor, you'll always be just one **QUIT** keystroke away from returning the map to your present position.

Now that you've seen how the Status and Map Pages can be used to monitor satellite acquisition and your present location, let's take a minute to learn how to mark and store your present position as a waypoint. Since you're in simulator mode, the present position displayed will be the last position calculated by the receiver, which should be the spot where you've initialized the unit. This will also give you an opportunity to see how the GPSMAP 162's keypad and **ENTER/MARK** key are used for data entry and changing the waypoint name and symbol.

Map Cursor

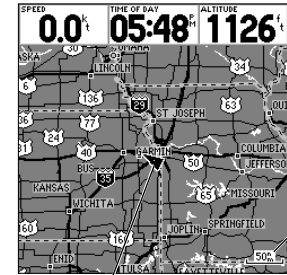

Map Scale

Current position

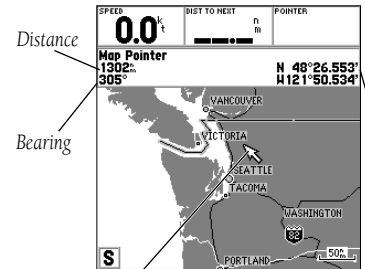

Distance

Bearing

Map Cursor

Cursor Coordinates

Getting Started

Marking Waypoints

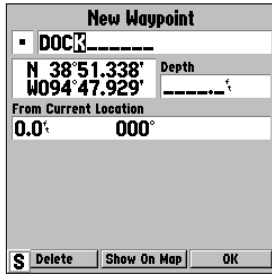

Press **ENTER/MARK** after entering the name.

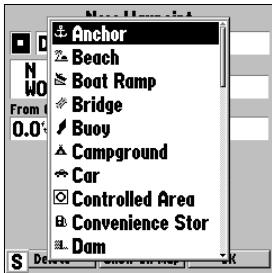

You can choose from a list of 38 useful symbols.

To mark your present position:

1. Hold down the **ENTER/MARK** key until the 'New Waypoint' window appears then release the key. The window will show a default three-digit waypoint name/number (001), symbol (dot), and position. You can leave the name as the auto-assigned number, but for this exercise, let's change the name to 'DOCK'.
2. Use the **ARROW KEYPAD** to highlight the waypoint name field (001) and press **ENTER/MARK**. You will see that just the first '0' is now highlighted.
3. Press **LEFT** on the **ARROW KEYPAD** to clear the name field.
4. Press the **UP** or **DOWN** arrow of the **ARROW KEYPAD** until the letter 'D' appears, and then press the **RIGHT** arrow key to go to the next space to the right, then **UP** or **DOWN** again until 'O' appears. Repeat this until you have entered the name 'DOCK'. If you make a mistake and select an incorrect character, simply press **LEFT** on the **ARROW KEYPAD** to backspace the cursor and then **UP** or **DOWN** to correct the entry. If you accidentally press **ENTER/MARK** before you are done, simply press **ENTER/MARK** again and move the highlight to where you left off.
5. After you have entered all the letters, press **ENTER/MARK** to confirm the name.
6. To access the waypoint symbol menu, highlight the waypoint symbol field which is to the left of the waypoint's name and press **ENTER/MARK**. Note: The default symbol is a dot.
7. You will see an alphabetical list of available waypoint symbols to choose from. Press the **ARROW KEYPAD UP** or **DOWN** until you highlight the 'ANCHOR' symbol. You will see a scroll bar on the right of the window indicating your current position on the entire list of symbols.
8. Press **ENTER/MARK** to confirm the 'ANCHOR' symbol.
9. Highlight 'OK' at the bottom of the window and press **ENTER/MARK** again to confirm the 'OK' prompt and save the waypoint. You may also press **QUIT** to not save the waypoint.

The waypoint is now stored in memory. Note that waypoints may also be created graphically from the map display or by manually entering position coordinates. Each of these techniques is described in the reference section of the manual and/or on your GPSMAP 162 Quick Reference Guide.

Going to a Destination

GPS is all about marking positions as waypoints and navigating to them using the receiver's steering guidance and map displays. We've already seen how to use the **ENTER/MARK** key to store our present position, so it's time to move on to the fun part—going to a destination.

The **NAV/MOB** key, located on the right side of the keypad below the **QUIT** key, is the primary tool used to select a destination waypoint, TracBack, or a route to navigate. The **NAV/MOB** key can be used in three primary ways:

- Pressing **NAV/MOB** once displays a list of options from which you can select 'Go To Waypoint', 'Follow Route', 'Follow Track', or 'Stop Navigation'.
- Holding down **NAV/MOB**, or pressing the key 2 times, activates the MOB (Man OverBoard) feature. This marks the point at which the MOB was activated as a waypoint named "MOB" and also establishes it as an active "Go To" point.
- Highlighting an on-screen waypoint or map item as a destination directly from the Map Page and pressing **NAV/MOB** allows you to graphically select points to "Go To".

For our simulated trip, you're going to select a pre-programmed tour route using the first method. This will also show you how the **MENU** key provides tab style options and functions throughout the GPSMAP system. Let's start by changing the position to where the practice route is located.

To change the GPSMAP 162 position in simulator mode:

1. From the Status Page, press the **MENU** key. The options menu will appear, displaying a menu of options and functions for the Status Page.
2. Press UP or DOWN on the **ARROW KEYPAD** to highlight the 'Initialize Position' option and press **ENTER/MARK**.
3. From the Initialize Position page, press the **MENU** key. You will see 'Enter As Text' highlighted, then press **ENTER/MARK**.
4. On the Enter Position window, press **ENTER/MARK** then use the **ARROW KEYPAD** to enter N34°56.800', W076°24.066' and press **ENTER/MARK** when done.

Getting Started

Using the NAV/MOB Key

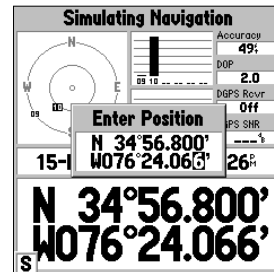

Text entry for simulator position.

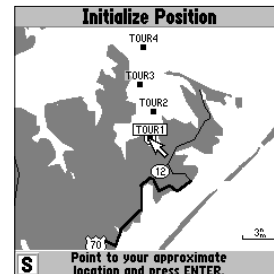

For future practice, you may skip steps 3 and 4 and point to a location from the Initialize Position page.

Getting Started

Simulated Tour

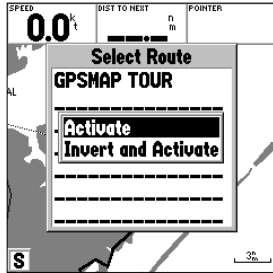

You can also Invert a route to follow it in reverse.



The Set Position, Track Control, Track and Speed fields will only show while in simulator mode.

Let's give it a try by activating the practice route stored in memory for navigation:

1. Press **NAV/MOB**. The options list will appear. (If we were selecting a single waypoint to navigate to rather than a route, we could highlight the waypoint on the map, press **NAV/MOB** and then press **ENTER/MARK**.)
2. Use the **ARROW KEYPAD** to highlight the 'Follow Route' option. Press **ENTER/MARK** to confirm.
3. The Select Route page will appear with the 'GPSMAP TOUR' route highlighted.
4. Press **ENTER/MARK**, then highlight 'Activate' and press **ENTER/MARK** again.

To get a better view of what's going on, zoom in to a closer map scale.

1. Repeatedly press the **IN** key until you select the 3 nm scale.

Note: You may also hold the **IN** or **OUT** keys down to quickly scroll through the map scales.

The Map Page should now display five waypoints chained together in a simple route, with your boat at the first route waypoint.

A data field at the top of the page will now display the speed, distance to the second route waypoint, and a pointer which shows you which way to go. To get started, let's enter a speed for our vessel, which we can do from the Main Menu Page.

To enter a boat speed:

1. Press the **MENU** key twice to display the Main Menu Page.
2. Use the **ARROW KEYPAD** to highlight the 'System' tab. Press **RIGHT**, then **DOWN** until the field below the word 'Speed' is highlighted and press **ENTER/MARK**.
3. Use the **ARROW KEYPAD** to enter a speed of 60 knots.
4. Press **ENTER/MARK** to finish, and **QUIT** until you return to the Map Page.

Once a speed has been entered, you'll notice that the map will automatically begin to move slowly, keeping your boat centered on the display. The direction of movement, also called 'track', will be controlled by the simulator.

You'll now have a clearer picture of the route you are navigating. Keep in mind that whenever you do exceed the usable range of the built-in database or the optional MapSource data in use, the range field will display 'overzoom' or 'NO MAP' to indicate that you should exercise extreme caution using the map data. Press the **IN** key to zoom into the 2 nm scale. Now that you've zoomed in a little closer to your route, you can pan ahead of your vessel with the cursor to review map items and create on-screen waypoints. Try moving the cursor to highlight the 'TOUR3' waypoint—just use the **ARROW KEYPAD** to move the cursor as close as possible to the waypoint. (To move the cursor in small increments, try a series of short key presses.)

Once the cursor is over the TOUR3 waypoint, you'll notice that the waypoint symbol and name will become highlighted or "selected." The data field at the top of the page will display the waypoint name, the range and bearing from your present position, and the coordinates for the waypoint.

To review the waypoint page for a selected waypoint:

1. Press the **ENTER/MARK** key.
2. To return to the Map Page, press **ENTER/MARK** again or press **QUIT**.

The cursor can also be used to create new waypoints right from the map display.

To create a new waypoint using the cursor:

1. Use the **ARROW KEYPAD** to move the cursor to a new position on the map that is NOT a map feature (such as a city, road or lake).
2. Press the **ENTER/MARK** key to capture the cursor position. The New Map Waypoint page appears.
3. Use the **ARROW KEYPAD** to highlight the waypoint symbol field to the left of the waypoint name/number.
4. Press **ENTER/MARK** to access the symbol page.
5. Press UP or DOWN on the **ARROW KEYPAD** to select the 'Shipwreck' symbol and press **ENTER/MARK** to confirm.
6. Highlight 'OK' at the bottom and press **ENTER/MARK** again to save the waypoint.

Getting Started

Reviewing/Creating Map Waypoints

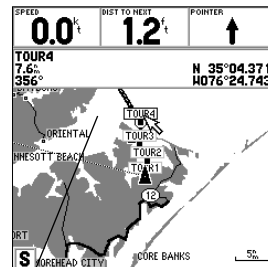

The waypoint will 'highlight' when the cursor is moved over it.

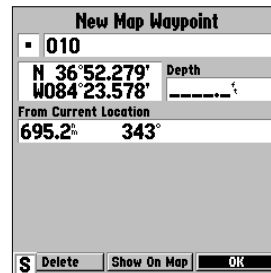

Waypoint numbering will start with 001 and continually count up, even if the waypoint name has been

Getting Started

Compass/Highway Navigation Pages

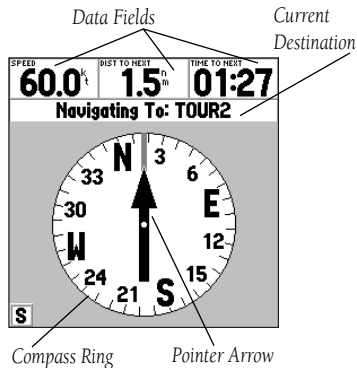

Now that we're navigating to an actual destination, let's move on to the GPSMAP 162 navigation pages by pressing the **PAGE** key.

The GPSMAP 162 features two different navigation pages: the Compass and Highway pages. The Compass Page is first. This page provides graphic steering guidance to a destination waypoint, with an emphasis on the bearing to your destination and current direction of travel. (The Highway Page places greater emphasis on the straight-line desired course and the distance and direction you are off course.) The middle of the page features a rotating 'compass ring' that shows your course over ground (track) while you're moving, and a bearing pointer that indicates the direction of the destination (bearing) relative to the course over ground. The compass ring and pointer arrow work independently to show—at a glance—the direction of your movement and the direction to your destination. For instance, if the arrow points up, you are going directly to the waypoint. If the arrow points any direction other than up, turn toward the arrow until it points up, then continue in that direction.

The current speed, distance to the next waypoint and the time to the next waypoint are displayed at the top of the screen. This page provides better steering guidance than the Highway Page when traveling at slower speeds and/or when making frequent directional changes. When you are not navigating to a waypoint, the compass ring will show your direction of travel as you move but the arrow will not appear.

Let's move on to the Highway page by pressing the **PAGE** key.

Getting Started

Highway Page

The GPSMAP 162's Highway Page also provides graphic steering guidance to a destination waypoint. As you head toward your destination, the middle of the screen provides visual guidance to your waypoint on a moving graphic "highway." Your present position is at the bottom center of the highway display. The line down the middle of the highway represents your desired course. As you navigate toward a waypoint, the highway will actually move—indicating the direction you're off course. To stay on course, simply steer toward the center of the highway or "keep it on the road." The six default data fields at the top of the page indicate Speed, Distance To your destination (or the next waypoint in a route), 'To Course' which shows the bearing to get you back on course, the distance you are 'Off Course', Time To the Next waypoint, and compass Track you are heading. Use the Highway Page as your primary navigation page (in lieu of the Compass Page) when your main concern is following a defined course.

Whenever the GPSMAP 162 is in simulator mode, you can also adjust your speed and course from the Highway Page using the **ARROW KEYPAD**. As you head toward each waypoint in the tour route, try adjusting your boat speed and course to get a feel for how the highway works.

To adjust the simulated boat speed from the Highway Page:

1. Press the UP arrow of the **ARROW KEYPAD** to increase the speed in 10 knot/kph/mpH increments. Press the DOWN arrow to decrease the speed in the same increments.

To steer the boat:

1. Press the LEFT and RIGHT arrows of the **ARROW KEYPAD**.

Notice that as you get off course, the highway will move to give you graphic guidance to get back on course. You can zoom in or out on the Highway Page display for a smaller or larger view. Five available settings range from 1X to 16X, with a default setting of 8X. The current scale will appear in the bottom right of the display.

To zoom in or out on the Highway Page display:

1. Press either the **IN** or **OUT** key to increase or decrease the zoom scale.

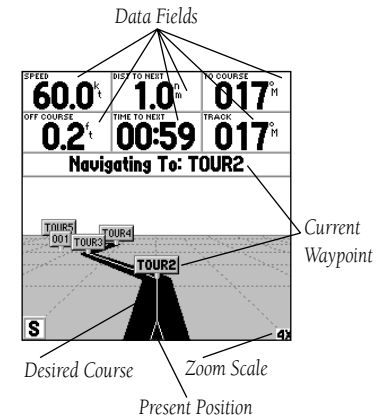

Getting Started

Data Fields/Active Route Page/ Main Menu Page

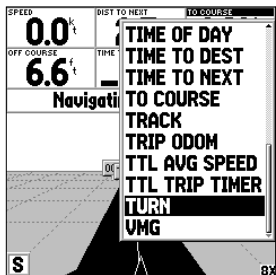

You may choose from 26 different types of data.

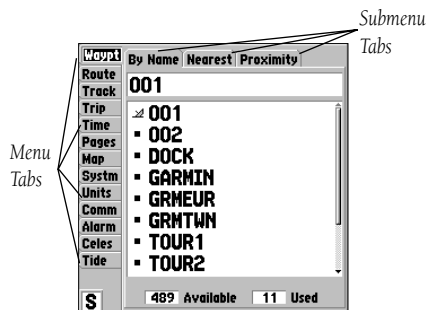

The data fields on the main pages (except the Status and Active Route Pages) may also be configured to display any of 26 information categories (see pages 33-34 for the complete list). On the Highway Page, let's change the 'TO COURSE' field to 'TURN'.

To change a data field:

1. Press the **MENU** key to display the Highway Page options.
2. Press **DOWN** on the **ARROW KEYPAD**, highlight 'Change Data Fields' and press **ENTER/MARK**.
3. Once the menu window disappears, use the **ARROW KEYPAD** and highlight 'TO COURSE', then press **ENTER/MARK**.
4. On the alphabetical list of options, press the **ARROW KEYPAD UP** or **DOWN** until you highlight 'TURN' and press **ENTER/MARK**. You will see a scroll bar on the right side of the window indicating your current position on the entire list of options.
5. Press **QUIT** when done.

Press **PAGE** to see the last page appearing in the main sequence, which is the Active Route Page. Whenever you have activated a route or TracBack, this page will show each waypoint name along with useful data for each point. As you navigate the route, the information will automatically update to indicate the next point along the route, which is denoted by an arrow on the left-hand side of the screen. For more detailed information on the Active Route Page, see page 58.

As you've seen, the primary pages provide status, map, and navigation information. The tour's last page is the Main Menu page, which allows access to the GPSMAP 162's waypoint, route and planning functions, as well as various operational and navigation setup features, and celestial and tide data.

The Main Menu is available from any page, and is accessed through the **MENU** key.

To access the main menu page:

1. Press the **MENU** key twice.

The Main Menu page lists 13 menu 'tabs' that are divided into categories by function. You can view a particular menu by simply highlighting the desired tab, which will then show any secondary submenu tabs and options for that tab.

To get a feel for how the Main Menu page works, let's clear out the track log you created during the simulated tour. This will ensure that you have a clean slate once you start navigating in your home waters.

To select the Track submenu tab:

1. Use the **ARROW KEYPAD** to highlight the 'Track' menu tab. You will see the options for the Track tab appear to the right of the Main Menu list.
2. Press to the right one time on the **ARROW KEYPAD** and you will see 'Active' highlighted.

The Track Log Page allows you to specify whether to record a track plot, define how it is recorded and save your current track log. It also provides both an indicator of the percentage of total memory used and the individual options to save or clear the active track log.

To clear the active track log:

1. Highlight the 'Clear' option and press **ENTER/MARK**. A confirmation page will appear.
2. Highlight the 'OK' prompt and press **ENTER/MARK** to confirm.
3. Press **PAGE** or **QUIT** to return to any of the main pages.

Congratulations! You've now gone through the basic operation of the GARMIN GPSMAP 162. Your new digital chartplotter is a powerful tool with many advanced features not covered in the Getting Started tour. For detailed instructions on using these features or performing a specific task, please refer to the Quick Reference Guide or the appropriate reference section of this manual.

To turn the GPSMAP 162 off:

1. Press and hold the **POWER** key for about 2 seconds, until the screen is blank.
2. When the screen is blank, release the **POWER** key.

The next section of the manual describes the pages and functions of the GPSMAP 162 in detail. If you are unable to locate a specific option or function, please refer to the index on pages 85-87. Thank you for choosing the GARMIN GPSMAP 162 navigation unit. We hope it will be a useful and fun tool for you wherever you go!

Getting Started

Deleting Track Logs/ Powering Off Unit

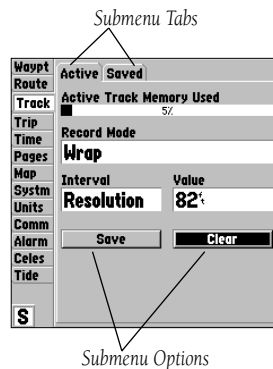

Reference

Status Page

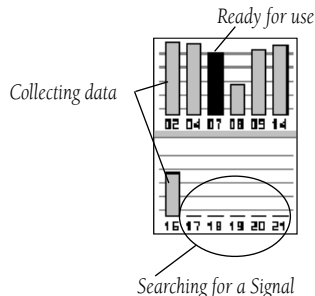
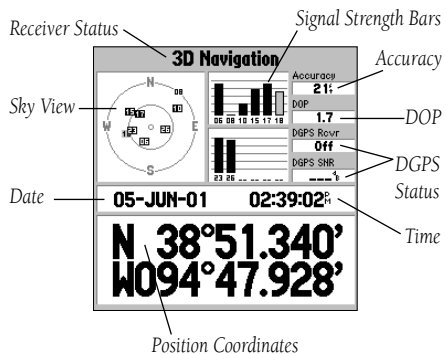

Status Page

The GPSMAP 162 Status Page provides a visual reference of satellite acquisition, receiver status, date, time and position coordinates. The status information will give you an idea of what the receiver is doing at any given moment. The sky view and signal strength bars indicate which satellites are visible to the receiver and whether or not they are being tracked. The signal strength is shown on a bar graph for each satellite, with the satellite number below. As the receiver locks onto satellites, a signal strength bar will appear for each satellite in view, with the appropriate satellite number (01-32) underneath each bar. The progress of satellite acquisition is shown in three stages:

- No signal strength bars— the receiver is looking for the satellites indicated.
- Light signal strength bars— the receiver has found the satellite(s) and is collecting data.
- Dark signal strength bars— the receiver has collected the necessary data and the satellite(s) are ready for use.

Each satellite has a data transmission that must be collected (light bar status) before that satellite may be used for navigation (dark bar status). When the receiver is looking for a particular satellite, the corresponding signal strength bar will be blank and the sky view indicator will not be highlighted. Once the receiver has found the satellite, a light signal strength bar will appear, indicating that the satellite has been found. When the receiver has collected data from the satellite and locked on, the number in the sky view will appear highlighted and the status bar will become dark.

As soon as the GPSMAP 162 has collected the necessary data from the best satellites in view to calculate a fix, the status field will indicate a 2D or 3D status. The unit will then update the position, date and time.

You can use the sky view to help determine if any satellites are being blocked, and whether you have a current position fix (indicated by a '2D Navigation' or '3D Navigation' in the status field). The sky view shows a bird's-eye view of the position of each satellite relative to the receiver's last known position. The outer circle represents the horizon (north up), the inner circle 45° above the horizon, and the center point a position directly overhead. You can also set the sky view to a 'Track Up' configuration, causing the top of the sky view to align along your current track heading.

Receiver Status, Accuracy and DOP

Receiver status is indicated at the top field of the page, with the current Accuracy and Dilution Of Precision (DOP) to the right of the sky view. DOP is an indication of satellite geometry quality measured on a scale of one to ten (lowest numbers the best, highest numbers the poorest). Accuracy uses DOP and other factors to calculate horizontal position accuracy in feet or meters. The status field will show one of the following conditions:

- Looking For Satellites— the receiver is looking for any satellites.
- AutoLocate— the receiver is looking for any satellite whose almanac has been collected. This process can take up to five minutes.
- Acquiring Satellites— the receiver is looking for and collecting data from satellites visible at its last known or initialized position, but has not collected enough data to calculate a fix.
- 2D Navigation— at least three satellites with good geometry have been acquired and a 2 dimensional position fix (latitude and longitude) is being calculated. '2D Differential Navigation' will appear when you are receiving DGPS corrections in 2D mode and a 'D' will show on the strength bar of satellites being corrected.
- 3D Navigation— at least four satellites with good geometry have been acquired and your position is now being calculated in latitude, longitude and altitude. '3D Differential Navigation' will appear when you are receiving DGPS corrections in 3D mode and a 'D' will show on the strength bar of satellites being corrected.
- Poor GPS Coverage— the receiver is no longer tracking enough satellites for a 2D or 3D fix.
- Receiver Not Usable— the receiver is unusable, possibly due to interference or abnormal satellite conditions. Turn the unit off and back on to reset.
- Simulating Navigation— the receiver is in simulator mode.

Reference

Status Page Options

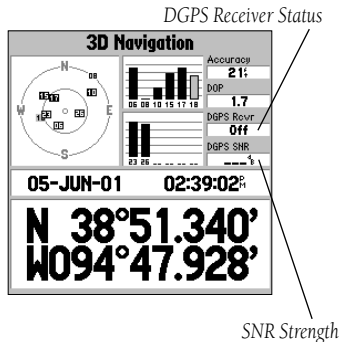

The 'DGPS Rcvr' and 'Diff SNR' fields appear below the 'Accuracy' and 'DOP' fields. The Differential Receiver status will show one of the following:

- Off— No optional beacon receiver attached or enabled in the Comm menu
- No Signal— DGPS receiver attached, but not transmitting RTCM data to GPS
- Tuning— Receiver is tuning manual frequency
- Scanning— DGPS receiver is scanning for available frequency
- Rcvng— Unit is receiving DGPS corrections
- Chk Wiring— DGPS is enabled in Comm menu, but no DGPS receiver attached or bad corrections
- WAAS— The unit is receiving 'WAAS' data

The Differential SNR (Signal to Noise Ratio) indicates, on a scale to 0-30db with 30db being the best, the strength of the DGPS signal being received. If no optional DGPS receiver is used with the GPSMAP 162, the 'DGPS Rcvr' field will display 'Off' and the 'DGPS SNR' field will be blank. The SNR will depend upon the mounting of your DGPS receiver and the distance from the DGPS transmitting station.

Many features of the GPSMAP 162 are menu-driven. Each of the main pages has an options menu, allowing you to custom tailor the corresponding page to your preferences and/or select special features that specifically relate to that page.

The GPSMAP 162's Status Page features an options menu that provides access to functions and features relating to the Status Page.

To display the Status Page options:

1. Press **MENU**.

To select a menu option:

1. Using the **ARROW KEYPAD**, highlight the desired option and press **ENTER/MARK**.

The following options are available:

- Start/Stop Simulator— allows you put the unit in simulator mode. See the Getting Started Tour for more on using simulator mode.
- Enable/Disable WAAS— allows you to activate or deactivate WAAS. ‘WAAS’ is an acronym for ‘Wide Area Augmentation System’. You can use the WAAS capability to increase the accuracy of the GPSMAP 162. When enabled, the GPS receiver searches for a WAAS satellite, then receives data that will help correct differentials in the GPS signal. When the unit is using WAAS data, “WAAS” will be displayed in the ‘DGPS Rcvr’ field on the Status Page, and the receiver status will indicate a 2D or 3D Differential Location.

Currently, the WAAS system is not fully operational and there are only two satellites in place—one over the Pacific Ocean and one over the Atlantic Ocean. You must have a clear, unobstructed view of the sky for the GPSMAP 162 to be able to receive a WAAS signal. Even then, at times it may not be possible to receive a WAAS signal. For more information on the WAAS system, visit the Federal Aviation Administration web site at (gps.faa.gov).

- Track Up/North Up— allows you to select between a north up or track up sky view display for the Status Page only.
- Loran TD On/Off— allows you to toggle the position coordinate format between latitude/longitude and Loran TD (Time Delays). For setup of Loran TD, see pages 72-73.
- AutoLocate— allows the receiver to locate your position automatically. This process can take up to five minutes.
- Initialize Position— allows you to initialize the receiver graphically on the Map Page to initially help the receiver acquire more quickly. See pages 4-5 for instructions on initialization.
- Set 2D Altitude— allows you to manually enter the altitude when in 2D Navigation or Simulator mode only. Any altitude entered will be automatically calculated when the GPS is

Status Page Options

Status Page Options

Reference

Map Page

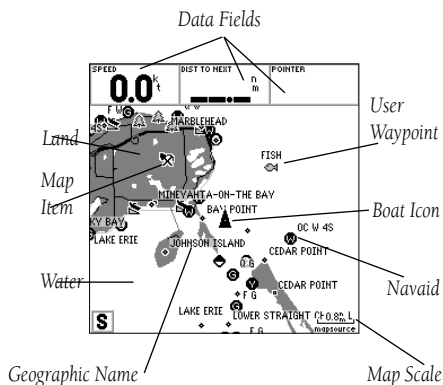

Map Page shown using optional MapSource data.

Map Page

The GPSMAP 162's Map Page provides a comprehensive display of electronic cartography, plotting and navigational data. When using the unit with the optional MapSource software, the map display shows your boat on a digital chart, complete with geographic names, map items, nav aids and a host of other chart features. It also plots your track and displays any routes and waypoints you create. An on-screen cursor lets you pan and scroll to other map areas, determine the distance and bearing to a position, and perform various route and waypoint functions.

When the cursor is active, an additional data window will appear below the data fields to indicate the position, range and bearing to the cursor or a selected waypoint or map item. The map scale displays at the bottom right of the page.

The **IN** and **OUT** keys, combined with the **ARROW KEYPAD**, let you select zoom ranges and move the cursor. Two basic map operating modes, position mode and cursor mode, determine what cartography is shown on the map display. Position mode pans the cartography to keep the present position marker within the display area, while cursor mode pans the cartography to keep the cursor within the display area.

The GPSMAP system will always power up in the position mode, with your vessel centered on the map display.

- When sufficient map coverage is not available to keep the boat centered, the boat icon will move toward the edge of the display.
- If the boat icon attempts to go off the display, the zoom level may need to be adjusted to keep cartography on screen.

When the **ARROW KEYPAD** is pressed, the GPSMAP 162 will enter cursor mode. In cursor mode:

- The cursor can be moved over the map display using the **ARROW KEYPAD**.
- When the cursor reaches the edge of the display, the map will scroll forward under the cursor. Keep in mind that the boat icon will move with the map scrolling and may go off the display screen (you may not be able to see your present position).
- When the cursor is stationary, a fixed coordinate position will appear in the position field. Note that the distance and bearing will change as the boat's position changes.
- Whenever you zoom in cursor mode, the cursor will be centered on screen.
- To return to position mode, press the **QUIT** key.



When the cursor reaches the edge of the map, the unit may pause as it loads new map data.

Using the Cursor

The cursor allows you to pan away from your present position and scroll to other map areas around the world (even outside of your current MapSource coverage). As you pan past the edge of the current map display, the screen will actively scroll forward to provide continuous map coverage.

To move the cursor:

1. Press the **ARROW KEYPAD** to move the cursor in an up, down, left or right direction.

As you move the cursor, the distance and bearing from your present position to the cursor will be displayed on the data window, along with the cursor's position coordinates. Keep in mind that when the cursor is stationary, the distance and bearing from your present position will change as your boat moves. The cursor may also be used to "snap to" on-screen waypoints and map items, allowing you to review a selected position directly from the map display.

Map Page Cursor

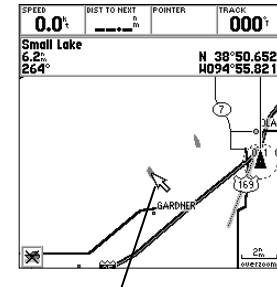

Move the cursor over an item on the map to highlight it.

Reference

Map Page Cursor



Pressing ENTER/MARK while highlighting a map item will bring up additional details and options.

To hide the cursor and re-center your position on screen:

1. Press the **QUIT** key.

To select an on-screen waypoint or map item with the cursor:

1. Use the **ARROW KEYPAD** to move the cursor to the desired waypoint or map item (if there are several waypoints grouped closely together, zoom in for a closer view).
2. When a waypoint or map item is selected, it will become highlighted on the screen with the name and position displayed.

With an on-screen waypoint or map item selected, you may review additional details by pushing the **ENTER/MARK** button. If a map item or waypoint includes more than one map feature (like a town, city, intersection, road, lake or river), details for each feature at that location will be displayed in a tabbed format on the Map Feature Review page.

To view information about a map item:

1. Use the **ARROW KEYPAD** to highlight a map item with the cursor and press **ENTER/MARK**. The Map Feature Review page will appear.
2. Use the **ARROW KEYPAD** to view the tabbed information. Each tab shows the name of the map feature, the distance and bearing from your current location, and offers additional options.
3. To center the selected map item on the Map Page, use the **ARROW KEYPAD** to highlight the 'Show on Map' button and press **ENTER/MARK**. The 'Map Feature' page appears with the map feature name, distance and bearing from your current position, and position coordinates. Press **QUIT** once to return to the Map Feature Review page, or press **QUIT** twice to return to the Map Page.
4. To create a waypoint at the selected map location, use the **ARROW KEYPAD** to highlight 'Create Waypt' and press **ENTER/MARK**. The New Waypoint page appears with the name of the map item set as the default waypoint name (see "Creating Waypoints Graphically" on page 39 for more information on creating a waypoint).

- To return to the Map Page, use the **ARROW KEYPAD** to highlight the 'OK' button and press **ENTER/MARK**, or just press the **QUIT** key.

With MapSource Fishing HotSpots data loaded into the GPSMAP 162, additional details are available when you highlight a point on the map within a Fishing Hot Spots coverage area. Fishing Hot Spots data provides detailed information in tabbed format such as shoreline, depth contours, submerged objects, swimming areas, navigational aids, mile markers, boat ramps, marinas, facilities, lake profiles and fishing areas. Lake profiles include details about size, depth, water source, shoreline, bottom conditions and vegetation. Fishing area information describes the area, the type of fish found there, the best time of year to fish that area, and the best types of lures for catching certain fish in that area.

To view Fishing Hot Spots information:

- Use the **ARROW KEYPAD** to select a map item or map location within the Fishing Hot Spots coverage area and press **ENTER/MARK**.
- Use the **ARROW KEYPAD** to view the tabbed information pages for that location. Highlight 'OK' and press **ENTER/MARK** when you're finished. You may also select the 'Create Waypt' or 'Show on Map' options the same as with a non-MapSource map item.

To read all the information in a 'Fishing Hot Spots Map' tab:

- Use the **ARROW KEYPAD** to highlight the text (the entire text field will be highlighted).
- Press **ENTER/MARK**. A single line of the text field will now be highlighted.
- Use the **ARROW KEYPAD** to scroll through the text.
- When you're finished, press **ENTER/MARK**. Use the **ARROW KEYPAD** to view other tabbed information or select other options, or select 'OK' to return to the Map Page.

Reference

Map Page Cursor

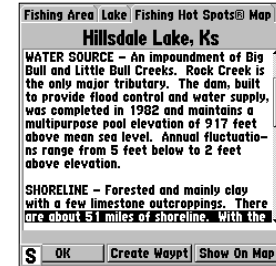

Viewing Fishing Hot Spots information

Reference

Map Page Cursor

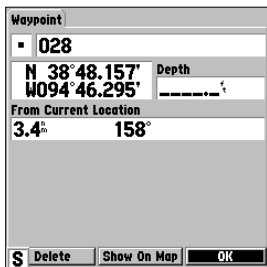

Viewing Waypoint Information

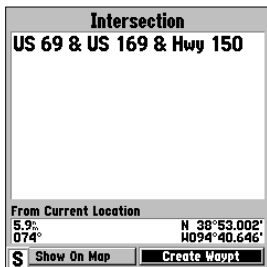

New Map Waypoint Page

To view information about a waypoint:

1. Use the **ARROW KEYPAD** to select a waypoint with the cursor and press **ENTER/MARK**. The Waypoint Review page will appear. If the waypoint is located on a map feature (road, intersection, city, lake, etc.), details about each map feature at that location will be displayed in a tabbed format behind the Waypoint Review Page.
2. From the Waypoint Review Page, you may change the waypoint symbol, name, coordinates, or depth; start a GoTo, Delete the Waypoint or return to the Map Page (see "Reviewing and Editing Waypoints" on page 38 for more information).
3. Use the **ARROW KEYPAD** to view the tabbed Map Feature Information pages. Each tab shows the name of the map feature, the distance and bearing from your current location, and offers additional options.
4. To center the selected map item on the Map Page, use the **ARROW KEYPAD** to highlight the 'Show on Map' button and press **ENTER/MARK**. The 'Map Feature' page appears with the map feature name, distance and bearing from your current position, and position coordinates. Press **QUIT** once to return to the Map Feature Review page, or press **QUIT** twice to return to the Map Page.
5. To create a waypoint from one of the tabbed information pages, use the **ARROW KEYPAD** to highlight 'Create Waypt' and press **ENTER/MARK**. The New Waypoint page appears with the name of the map item set as the default waypoint name (see "Creating Waypoints Graphically" on page 39 for more information on creating a waypoint).
6. To return to the Map Page, use the **ARROW KEYPAD** to highlight the 'OK' button and press **ENTER/MARK**, or press the **QUIT** key.

To create a waypoint with the cursor:

1. Use the **ARROW KEYPAD** to move the cursor to the desired map position.
2. Press and quickly release the **ENTER/MARK** key. The 'New Map Waypoint' page appears.

Map Page Cursor and Zooming

New Map Waypoint	
036	
N 38° 48.157'	Depth
W 094° 44.653'	-----'
From Current Location	
4.1 ⁿ	141°
<div style="display: flex; justify-content: space-between;"> S Delete Show On Map OK </div>	

Creating a New Map Waypoint



Using Built-In Basemap



Using MapSource Data



Overzoom, no additional data

- To change the waypoint symbol, name or position coordinates, or enter a depth, use the **ARROW KEYPAD** to select the desired field, then press **ENTER/MARK**. Make your changes and press **ENTER/MARK** again to accept the changes.
- When you are finished making changes, or to accept the waypoint using the default 3-digit name and symbol, highlight the 'OK' button and press **ENTER/MARK** to save the new waypoint.

For more information, see "Creating Waypoints" on page 38.

Selecting Map Scales

The map display has 28 available range scales from 20 ft. to 800 mi. (6 mt. to 1200 km). The map scale is controlled by the **IN** and **OUT** keys, with the current scale displayed at the bottom right of the data window.

To select a map scale:

- Press the **OUT** key to zoom out and the **IN** key to zoom in.



The scale value represents the distance from one end of the scale bar to the other.

The GPSMAP 162's system has a built-in worldwide database to 20 mi, with more detailed coverage available through the use of the optional MapSource software. The GPSMAP 162 will display cartography as long as there is chart information available for the range you've selected. Map coverage will conform to the following conditions:

- When the selected zoom range is covered by either the internal database or MapSource data, cartography will be displayed.
- When the selected zoom range is covered by both the internal database and MapSource data, cartography will be displayed using the data with the best resolution.
- When the selected zoom range exceeds the resolution of the data in use, overzoom cartography will be displayed and an 'overzoom' warning will appear below the scale field.

Map Page Options

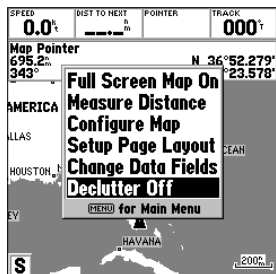

Map Page Options

Map Page Options

Many features of the GPSMAP 162 are menu driven. Each of the main pages have an options menu, allowing you to custom tailor the corresponding page to your preferences and/or select special features that specifically relate to that page. The data window, located at the top of the main pages (Except the Status Page and Active Route Page), provides a user-selectable layout of various types of useful data. Each data field may be configured to display any one of 23 data options. The data window layout may also be changed to display additional data fields and change the actual size of the data displayed.

The GPSMAP 162's Map Page provides access to functions and features relating to the Map Page and the layout options.

To display the Map Page options:

1. Press **MENU**.

To select a menu option:

1. Use the **ARROW KEYPAD** to highlight the desired option and press **ENTER/MARK**.

The available options are Full Screen Map On/Full Screen Map Off, Measure Distance, Configure Map, Setup Page Layout, and Change Data Fields. Following are details on using each of these options.

• **Full Screen Map On/Full Screen Map Off** — toggles between a Map Page without or with data fields on the map display.

To maximize the map/show data fields:

1. Highlight the 'Full Screen Map On' option and press **ENTER/MARK**. The Map Page will now be maximized with no data fields.
2. To show the data fields again, press **MENU**, highlight 'Full Screen Map Off' and press **ENTER/MARK**.

• **Measure Distance**— allows you to measure the bearing and distance between any two points on the map display.

To measure the bearing and distance (BRG/DIS) between two points:

1. Highlight the 'Measure Distance' option and press **ENTER/MARK**. An on-screen pointer will appear on the map display at your present position with 'ENT REF' below it.
2. Move the cursor to the desired reference point (the point that you want to measure from) and press **ENTER/MARK**.
3. Move the cursor to the point that you want to measure to. The bearing and distance from the reference point will be displayed in the data window at the top of the display.
4. Press the **QUIT** key to finish.

• **Configure Map**— allows you to configure the map display to your preferences, including map detail, map orientation, automatic zoom, and various map items and points. The map configuration option uses a 'file tab' feature, making it easier to organize the various settings for ease of use. The following table lists the file tabs and the settings available under each tab:

General	Detail, Orientation, AutoZoom, Color Mode
Source	Basemap, MapSource
Waypoints	Waypoints, Active Route
Points	Spot Soundings, Tide Stations, Services, Navaids
Nav Line	Heading Line, Bearing Line, Course Line
Track	Saved Tracks, Track Log
Geo	Geo Points, Rivers/Lakes, Park Areas
Topo	Major/Medium/Minor Contours, Land Cover
Other	Accuracy Circle, Lat/Lon Grid, Map Outlines

Reference

Map Page Options



(Full Screen Map Shown)

Map Page Options

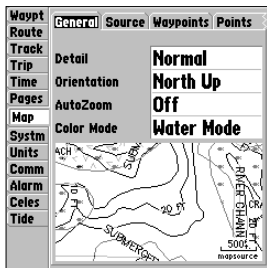

Main Menu—Map Configuration Tab

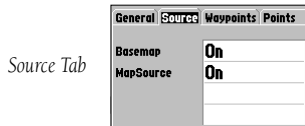
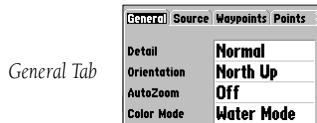

To change a map setup feature:

1. From the Map Page menu, highlight 'Configure Map' and press **ENTER/MARK**.
2. Move LEFT or RIGHT on the **ARROW KEYPAD** to highlight the desired tab, then UP or DOWN on the **ARROW KEYPAD** to highlight to the setting you want to change and press **ENTER/MARK**.
3. Move UP or DOWN on the **ARROW KEYPAD** to highlight to the desired setting and press **ENTER/MARK**.
4. To exit, press **QUIT**.

Map Configuration Tabs

The Waypoints, Points, Track, Geo, and Topo Tabs have settings for either 'Text', 'Zoom' or both. Below is a description for each setting and how it will affect the Map Page.

Text— None, Small, Medium, and Large: controls the screen size of the name.

Zoom— Auto, Off, 20 ft.-800 mi.: sets the maximum scale at which the feature should appear on the screen. Some types of data will only show up to certain zoom scales.

General Tab

Detail— Most, More, Normal, Less, Least: controls how much map detail you will see. This setting only applies to any map feature set to "Auto". Those features which have a specified scale or turned "Off" are unaffected by this setting.

Orientation— North Up— fixes the top of the map display to a north heading; Track Up— fixes the top of the map display to the current track heading; Course Up— fixes the map so the direction of navigation is always "up" and turns the navigation leg line vertical on the screen.

AutoZoom— On/Off: when "On" the map will automatically adjust the map scale to a lower scale as you approach you destination point.

Color Mode— Water Mode, Land Mode: when in "Water Mode", land will appear as a dark color and water will be light. In "Land Mode", land will appear as a light color and water will be dark.

Source Tab

Basemap— On/Off: turns the built in base map on or off.

MapSource— On/Off: turns the optional MapSource data loaded in the unit on or off.

Waypoints Tab— Waypoints, Active Route

Text and Zoom settings, see the description on page 30 for details.

Points Tab— Spot Soundings, Tide Stations, Services, Nav aids

Text and Zoom settings, see the description on page 30 for details.

Nav Line Tab

Heading Line— On/Off: turns the Heading Line on or off. The Heading Line projects from the tiranle showing your current heading.

Bearing Line— Auto, Off, 20 ft-800 mi: sets the maximum scale at which the Bearing Line should appear on the screen. The Bearing Line shows the bearing from your current location to a destination waypoint.

Course Line— Auto, Off, 20 ft-800 mi: sets the maximum scale at which the Course Line should appear on the screen, The Course Line shows a direct navigation line from the point navigation was initiated to a destination waypoint.

Track Tab— Saved Tracks, Track Log

Zoom setting, see the description on page 30 for details.

Geo Tab— Geo Points, Rivers/Lakes, Park Areas

Text and Zoom settings, see the description on page 30 for details.

Topo Tab— Major/Medium/Minor Contours, Land Cover

Text and Zoom settings, see the description on page 30 for details.

Other Tab

Accuracy Circle— On/Off: toggles the circle “On” and “Off”. The circle represents the approximate accuracy of the unit based on EPE, DOP, and basemap quality. You position will be within the circle.

Lat/Lon Grid—Text and Zoom settings determine when the grid and labels will be displayed on the Map Page. See the description for the Text and Zoom settings on page 30 for details.

Map Outlines—On/Off toggles the outline showing areas of MapSource Data that are loaded in the unit.

Map Page Options

Waypoints	Points	Nav Line	Track
		Text	Zoom
Waypoints		Medium	AUTO
Active Route		Medium	AUTO

Waypoints Tab

Waypoints	Points	Nav Line	Track
		Text	Zoom
Spot Soundings		Small	On
Tide Stations		None	AUTO
Services		None	AUTO
Nav aids		Medium	

Points Tab

Waypoints	Points	Nav Line	Track
		Text	Zoom
Heading Line			On
Bearing Line			AUTO
Course Line			AUTO

Nav Line Tab

Waypoints	Points	Nav Line	Track
		Text	Zoom
Saved Tracks			AUTO
Track Log			AUTO

Track Tab

oints	Points	Nav Line	Track	Geo	T
		Text	Zoom		
Geo Points		Medium	AUTO		
Rivers, Lakes		Medium	AUTO		
Park Areas		Medium	AUTO		

Geo Tab

oints	Nav Line	Track	Geo	Topo	C
		Text	Zoom		
Major Contour		Medium	AUTO		
Medium Contour		Medium	AUTO		
Minor Contour		Small	AUTO		
Land Cover		Medium	AUTO		

Topo Tab

Nav Line	Track	Geo	Topo	Other
		Text	Zoom	
Accuracy Circle				On
Lat/Lon Grid		Medium		OFF
Map Outlines				On

Other Tab

Reference

Map Page Options



Map Setup Menu Options

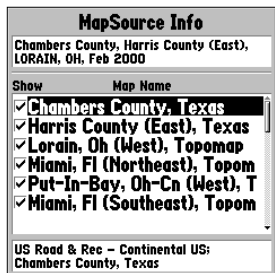

MapSource Info Page

Map Setup Menu Options

From the map setup page, you can access the following menu options:

- Restore Defaults— restores settings back to factory settings for the tab highlighted.
- Restore All Map Defaults— restores settings back to factory settings for all tabs.
- MapSource Info— allows you to display/not display optional map sets loaded in the unit.

To restore defaults for map settings:

1. From the Map tab in the Main Menu, highlight the Map Configuration tab that you want to restore to the factory default settings, and press **MENU**.
2. Highlight 'Restore Defaults' (highlight 'Restore All Map Defaults' if you want all tabs restored) and press **ENTER/MARK**.

MapSource Info— shows the number of maps downloaded from the optional MapSource software package. Each downloaded map is described by name, and may be deselected if you wish to retain the map in memory, but not display the data on the Map Page.

To display the MapSource Info Page:

1. From the Map tab, press **MENU** then highlight 'MapSource Info' and press **ENTER/MARK**.
2. Use the **ARROW KEYPAD** to scroll through the list of downloaded maps.
3. To select/deselect a map, highlight the name of the desired map. Press **ENTER/MARK** to select/deselect the map. The map is selected and will be displayed on the Map Page when a "✓" appears in the box adjacent to that map. You may also press **MENU** and choose to 'Show All' or 'Show None' and press **ENTER/MARK**.

• **Setup Page Layout**— allows you to change the text size and number of data fields that will be displayed. The following options are available:

- None— No data fields will be displayed
- Small (1 Row) Small text, 4 data fields
- Small (2 Rows) Small text, 8 data fields
- Small (3 Rows) Small text, 12 data fields
- Medium (1 Row) Medium text, 3 data fields
- Medium (2 Rows) Medium text, 6 data fields
- Large (1 Row) Large text, 1 data field
- Huge (1 Row) Huge text 1 data field
- Huge (2 Rows)* Huge text with a compass ribbon at the bottom of the display, 2 data fields

* This option is available only on the Compass Page.

Map Page Options

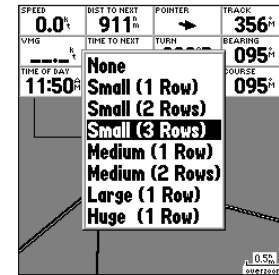

Choose the size and number of data fields you wish to display.

To change the page layout:

1. From the menu, use the **ARROW KEYPAD** to highlight the 'Setup Page Layout' option and press **ENTER/MARK**.
2. Move up or down on the **ARROW KEYPAD** to highlight to the desired setting and press **ENTER/MARK**. To exit, press **QUIT**.

• **Change Data Fields** — allows you to specify the type of data displayed in each data field used on the map display.

The following options are available for Map page data fields (and on the Highway and Compass pages):

- BEARING – Compass direction from your position to destination
- COURSE – Course over ground
- DEPTH – Depth below transducer (only available with additional sonar NMEA data)
- DIST TO DEST – Distance to final waypoint
- DIST TO NEXT – Distance to next waypoint
- ETA AT DEST – Estimated Time of Arrival to final waypoint
- ETA AT NEXT – Estimated Time of Arrival to next waypoint
- ELEVATION – Elevation above/below MSL (Mean Sea Level)
- MAX SPEED – Fastest speed the unit has traveled
- MOV AVG SPEED – Average moving speed
- MOV TRIP TIMER – Time unit has been moving for a trip
- OFF COURSE – Distance from desired track
- POINTER – Arrow points to your destination
- SPEED – Speed over ground/water
- TIME OF DAY – Current time
- TIME TO DEST – Time to final waypoint at current speed and course
- TIME TO NEXT – Time to next waypoint at current speed and course

Map Page Options

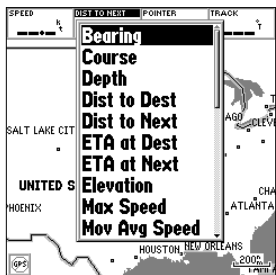

Choose the type of data you wish to display for each field.

Data Field Options continued

- TO COURSE – Distance to desired track
- TRACK – Current compass heading
- TRIP ODOM – Trip Odometer
- TTL AVG SPEED – Total average speed
- TTL TRIP TIMER – Total travel time of trip, stopped and moving
- TURN – Turn angle to waypoint
- VMG – Velocity Made Good to destination
- WATER SPEED – Speed through the water (only available with additional sonar NMEA data)
- WATER TEMP – Water temperature (only available with additional sonar NMEA data)

To change a data field:

1. From the menu, use the **ARROW KEYPAD** to highlight the 'Change Data Fields' option and press **ENTER/MARK**.
2. Move the field highlight to the data field you want to change and press **ENTER/MARK**.
3. Move up or down on the **ARROW KEYPAD** to highlight the data you want to display, and press **ENTER/MARK**. To exit, press **QUIT**.

Compass Page

The GPSMAP 162 features two different navigation pages: Compass and Highway. Whenever a **NAV/MOB**, Follow Track (TracBack) or Follow Route have been activated, the GPSMAP 162's Compass Page will guide you to your destination with digital readouts and a graphic compass display, which includes a bearing pointer. Use this page (instead of the Highway Page) when travelling at slower speeds, when making frequent directional changes, or where straight-line navigation is not possible due to obstructions or terrain. The middle of the page features a rotating 'compass ring' that shows your course over ground (track) while you're moving. Your present course over ground is indicated at the top of the compass ring. A bearing pointer, in the middle of the compass ring, indicates the direction of the destination (bearing) relative to the course over ground. The compass ring and pointer arrow work independently to show—at a glance—the direction of your movement and the direction to your destination. For instance, if the arrow points up, you are going directly to the waypoint. If the arrow points any direction other than up, turn toward the arrow until it points up, then continue in that direction.

The GPSMAP 162's Compass Page features a menu page that provides access to layout and data field options. The data window, located at the top of the page, provides a user-selectable layout of various types of useful data. Each data field may be configured to display any one of 23 data options. The data window layout may also be changed to display additional data fields and change the actual size of the data displayed.

To display the Compass Page options:

1. Press **MENU**.

To select a menu option:

1. Use the **ARROW KEYPAD** to highlight the desired option and press **ENTER/MARK**. For detailed instructions on changing the data fields and layout of the Compass Page, see pages 32-34.

Reference

Compass

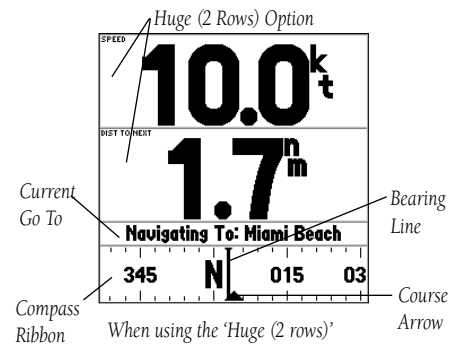
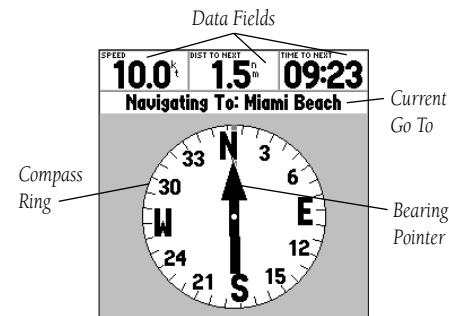

When using the 'Huge (2 rows)' option, steer until the bearing line is aligned with the course arrow.

Reference

Highway Page

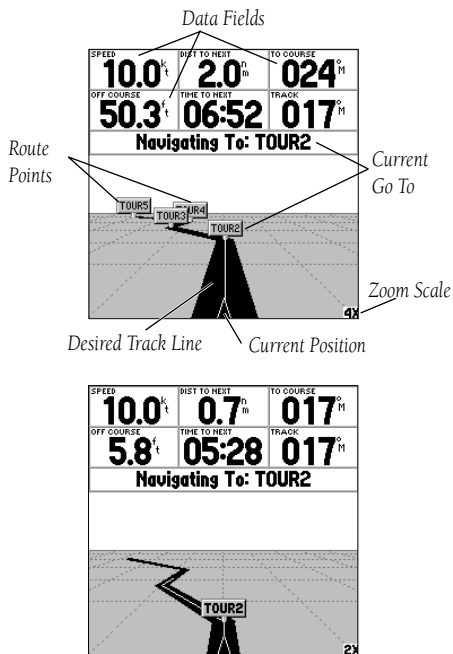

You can configure the page to show the active point only and also zoom in or out to get a better view.

Highway Page

Whenever a **NAV/MOB**, TracBack or route has been activated, the GPSMAP 162's Highway Page will provide digital and graphic steering guidance to the destination with the Navigation Page. The top half of the Highway Page features user-selectable data fields that display useful navigation data. The middle section of the screen provides visual guidance to the waypoint on a graphic highway display. The line down the center of the highway represents your desired track line.

As you head toward your destination, the highway perspective moves to indicate your progress to the waypoint and which direction you should steer to stay on course. If you are navigating a route, the Highway Page shows each route waypoint in sequence connected by a black "road" with a white line down the middle, which is your desired track line. Nearby waypoints not in the active route can also be displayed. The highway perspective scale may also be zoomed in or out to display a larger or smaller view of the highway. Five settings are available from 1X to 16X, with a default setting of 8X.

To change the highway perspective scale:

1. Press the **IN** or **OUT** key to select the desired setting.

The GPSMAP 162's Highway options page allows you to define the data fields and select which waypoints are displayed on screen. The data window, located at the top of the page, provides a user-selectable layout of various types of useful data. Each data field may be configured to display any one of 26 data options. The data window layout may also be changed to display additional data fields and change the actual size of the data displayed.

The GPSMAP 162's Highway Page features a menu options page that provides access to functions and features relating to the Highway Page and the layout options.

To display the Highway Page options:

1. Press **MENU**.

To select a menu option:

1. Using the **ARROW KEYPAD**, highlight the desired option and press **ENTER/MARK**.

The following options are available from the Highway Page menu:

- **Show/Hide Tracks**— toggles the display of track lines on/off.
- **Configure Highway**— allows you to select what waypoints are shown on the Highway display. Four options are available:
 - Rte & Nearest— all route and nearest waypoints displayed.
 - Route Only— only waypoints in the route will be displayed.
 - Active Only— only the active waypoint will be displayed.
 - Hide All— no waypoints will be displayed.

To configure the highway display:

1. From the menu, highlight 'Configure Highway' and press **ENTER/MARK**.
 2. Highlight the desired option and press **ENTER/MARK**.
- **Setup Page Layout**— allows you to change the text size and number of data fields that will be displayed.
 - **Change Data Fields**— allows you to specify the type of data displayed in each data field used on the map display.

For detailed instructions on changing the data fields and layout of the Highway page, see pages 32-34.

Active Route Page

Whenever you have activated a route in the GPSMAP 162 system, the Active Route page will show each waypoint of the active route, along with various, user-selectable types of data. For additional details on the Active Route Page, see page 58.

Highway Page Options



Highway Page Options Menu

Route Name

Active Route		
GPSMAP TOUR		
Waypoint	Distance ←	Course →
TOUR1	--- ^m	003 [°]
TOUR2	1.8 ^m	330 [°]
TOUR3	4.4 ^m	001 [°]
TOUR4	7.5 ^m	325 [°]
TOUR5	17.3 ^m	---
----- ^m --- [°]		
----- ^m --- [°]		
TOTALS	17.3^m	337[°]

Route Points

Selectable Data Field

Active Route Page

Reference

Creating Waypoints

New Waypoint	
▣ 002	
N 38°51.338'	Depth
W094°47.929'	-----'
From Current Location	
0.0'	000'
S Delete Show On Map OK	

Press **ENTER/MARK** to use the default name and symbol.

New Waypoint	
▣ 002	
N 38°51.338'	Depth
W094°47.929'	-----'
From Current Location	
0.0'	000'
S Delete Show On Map OK	

Highlight a field and press **ENTER/MARK** to enter a new symbol, name or depth.

Creating and Using Waypoints

The GARMIN GPSMAP 162 stores up to 500 alphanumeric waypoints with a user-defined icon and depth available for each waypoint. Waypoints can be created using three basic methods:

- **ENTER/MARK** key— used primarily for marking your present position, the **ENTER/MARK** key also provides options that allow you to select a map position or map item from the map display.
- Graphically— allows you to define a new waypoint position from the map display using the **ARROW KEYPAD**.
- Text Entry— allows you to enter a new waypoint's position coordinates manually.

ENTER/MARK Key

The GARMIN GPSMAP 162's **ENTER/MARK** key lets you quickly capture your present position— or cursor or map item position— in order to create a new waypoint. You must have a valid position (2D or 3D) fix to mark your present position. This can be determined by looking at the Status Page. When you move the cursor over a map item, you will see a highlighted description of that item.

To mark your present position:

1. Press and hold the **ENTER/MARK** key until the 'New Waypoint' window appears then release it. You will see a default three-digit name and symbol for the new waypoint.
2. To accept the waypoint with the default name and symbol, press **ENTER/MARK** to confirm the highlighted 'OK' prompt.
3. To enter a different name, highlight the name field and press the **ENTER/MARK** key, then use the **ARROW KEYPAD** to enter the new letter/numbers and press **ENTER/MARK** when done. Note: You may use up to 10 alphanumeric characters for the name.
4. To enter a different symbol, highlight the symbol field to the left of the name and press the **ENTER/MARK** key, then use the **ARROW KEYPAD** to highlight the new symbol and press **ENTER/MARK**.

- To enter an optional depth, highlight the “Depth” field to the right of the position coordinates and press the **ENTER/MARK** key, then use the **ARROW KEYPAD** to enter a value and press **ENTER/MARK**.
- When done, use the **ARROW KEYPAD** to highlight the ‘OK’ prompt and press **ENTER/MARK** to save the waypoint into memory.

Creating Waypoints Graphically

Waypoints may also be quickly created using the map display. This feature allows you to select any map position with the cursor and create a new waypoint. To mark a map item, select the desired map item with the cursor then press and release the **ENTER/MARK** key. If you select an item on the map, like a city, the GPSMAP 162 will use the text or name shown on the cartography as the default name. When selecting a map item, the option ‘Create Waypoint’ will appear in addition to a description of that point and its distance and bearing from your current position.

To create a new waypoint graphically:

- Use the **ARROW KEYPAD** to move the cursor to the desired map position. If you want to create the new waypoint at an on-screen map item, highlight the map item on the map display.
- Press and quickly release the **ENTER/MARK** key. The ‘New Map Waypoint’ page appears. (NOTE: Pressing and holding the **ENTER/MARK** key will mark your current location instead of the cursor location, and bring up the ‘New Waypoint’ page)

If you are using a map item to create a waypoint, an information page(s) for the map item will appear first. Use the **ARROW KEYPAD** to highlight ‘Create Waypt’ and press **ENTER/MARK**. The ‘New Waypoint’ page will now appear.

- To accept the waypoint with the default name and symbol, press **ENTER/MARK**. If you are creating a waypoint from an on-screen map item, the name and symbol will automatically reflect the selected map item’s name and symbol.
- To change the name, symbol or enter a depth, highlight the appropriate field and press **ENTER/MARK**. Make your changes and press **ENTER/MARK** when done.
- After entering and confirming your changes, highlight ‘OK’ and press **ENTER/MARK**.

Creating Waypoints

New Map Waypoint	
003	
N 38°51.142'	Depth
W094°47.472'	
From Current Location	
0.4 ⁿ	119°
<input type="button" value="Delete"/> <input type="button" value="Show On Map"/> <input type="button" value="OK"/>	

Map waypoint from non-map item.

Large City	
Miami	
From Current Location	
1074.8 ⁿ	N 25°50.391'
132°	W080°09.375'
<input type="button" value="Show On Map"/> <input type="button" value="Create Waypt"/>	

Choose ‘Create Waypt’ to use a map item for a new waypoint.

Reference

Creating and Editing Waypoints

Symbol

Name

Coordinates

Depth

From Current Location

Delete Show On Map OK

New Waypoint Page

Waypoint

Symbol

Name

Coordinates

Depth

From Current Location

Delete Show On Map OK

Waypoint Review Page

Creating Waypoints By Text Entry

Waypoints may also be created by manually entering position coordinates through the 'Waypt' tab on the main menu page.

To create a new waypoint by manually entering its coordinates:

1. Press **MENU** twice to display the main menu page.
2. Highlight the 'Waypt' tab and press **MENU**. Then highlight 'New Waypoint' and press **ENTER/MARK**. The New Waypoint page will appear, with the next available waypoint number and the receiver's last known position as the default name and position.
3. Use the **ARROW KEYPAD** to highlight the position coordinates field and press **ENTER/MARK**. Press UP or DOWN on **ARROW KEYPAD** to change the digits, and press RIGHT or LEFT to move to the next number position. Press RIGHT at the end of the top line to move to the bottom line.
4. If you want to change the waypoint name, symbol or enter a depth, highlight the desired field and press **ENTER/MARK**. Use the **ARROW KEYPAD** to enter the new information and press **ENTER/MARK** after the last character in each section.
5. When you have finished, highlight 'OK' and press **ENTER/MARK**.

Reviewing and Editing Waypoints

Once you have created and stored a waypoint, it may be reviewed, modified, moved or deleted at any time through the Waypoint Review and Waypoint Edit pages.

On the Waypoint Review page, you may change the name, symbol, position coordinates, or depth for the selected waypoint, show the waypoint on the map or delete the waypoint. If the selected waypoint is located on a map item or a MapSource item, tabbed information pages for each map feature will be displayed behind the Waypoint Review page. To review the tabbed information pages, use the **ARROW KEYPAD** to highlight the desired tab. The Waypoint Edit page has all the same options as the Waypoint Review page, except it does not include the tabbed information pages for waypoints located on map features.

To access the Waypoint Review page:

1. Use the **ARROW KEYPAD** to highlight the desired waypoint on the map and press **ENTER/MARK**.

Editing Waypoints

To access the Waypoint Edit page:

1. Press **MENU** twice, highlight the 'Waypt' tab, and then highlight a waypoint from the 'By Name', 'Nearest', or 'Proximity' waypoint lists. Press **ENTER/MARK** to display the Waypoint Edit page.

To change the waypoint name:

1. Highlight the waypoint name field and press **ENTER/MARK**.
2. Use the **ARROW KEYPAD** to enter a new name and press **ENTER/MARK** when done.

To change the waypoint symbol:

1. Highlight the waypoint symbol field to the left of the waypoint name and press **ENTER/MARK**.
2. Use the **ARROW KEYPAD** to select the desired symbol and press **ENTER/MARK** when done.

To change the position coordinates:

1. Highlight the position coordinate field and press **ENTER/MARK**.
2. Use the **ARROW KEYPAD** to edit the coordinates. To drop to the next line, press to the right on the **ARROW KEYPAD**. Press **ENTER/MARK** when done.

To enter a depth:

1. Highlight the depth field and press **ENTER/MARK**.
2. Use the **ARROW KEYPAD** to enter a depth. Press UP or DOWN to change the digits and press RIGHT or LEFT to move the cursor. Press **ENTER/MARK** when done.

Waypoint Edit	
▣	005
N 38°51.338'	Depth
W094°47.876'	-----'
From Current Location	
246.7'	090°
S Delete	Show On Map Next

Waypoint Edit Page

Waypoint Options

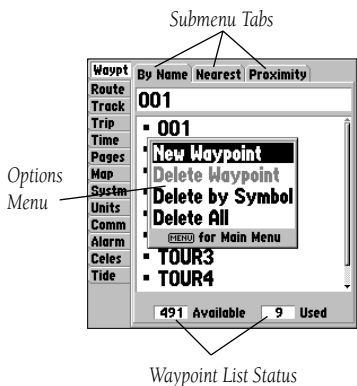

Waypoint Submenus

The GPSMAP 162's Main Menu Page features three submenus in the Waypoints tab, 'By Name', 'Nearest', and 'Proximity', that let you manage a large number of waypoints quickly and efficiently. The submenu tabs also provide a continuously updated nearest waypoints list and a proximity waypoint alarm function that defines an alarm circle around submerged hazards, shallow waters, etc.

To access the Main Menu Page/Waypoint (Waypt) submenus:

1. Press **MENU** twice, then highlight the 'Waypt' tab using the **ARROW KEYPAD**, then highlight the desired submenu tab.

By Name Waypoint List

The first waypoint submenu list available from the 'Waypt' tab is the 'By Name' list, which displays a master list of all waypoints currently stored in memory. From the By Name list, you may review, edit, rename or delete individual waypoints, or delete all user waypoints. The total number of stored and available waypoints is displayed at the bottom of the 'By Name' page, with the stored waypoints arranged in numerical/alphabetical order.

The following options are available from the 'By Name' submenu of the 'Waypt' tab:

- New Waypoint— creates a new waypoint.
- Delete Waypoint— deletes selected waypoint from list and any route in which it was used.
- Delete by Symbol— deletes waypoints that use the same symbol.
- Delete All— deletes all waypoints from the unit.



Once a waypoint is deleted from the list, it cannot be recovered from the unit. It is advisable to back up important waypoints to a computer using Garmin's MapSource software.

To display the waypoint menu options:

1. Using the **ARROW KEYPAD**, highlight the 'By Name' tab and press the **MENU** key.

To scroll through and review the waypoint list:

1. With the **ARROW KEYPAD**, highlight the 'Waypt' tab from the Main Menu page and then highlight the 'By Name' tab.
2. Use the **ARROW KEYPAD** to scroll through the list in the desired direction.
3. Press **ENTER/MARK** to review the highlighted waypoint on the 'Waypoint Edit' page.
4. Press **ENTER/MARK** to return to the list. To create a new waypoint using the waypoint menu, see page 36.

To delete an individual waypoint from the list:

1. Use the **ARROW KEYPAD** to highlight the waypoint to be deleted and press **MENU**.
2. Highlight 'Delete Waypoint' and press **ENTER/MARK**. You may also highlight the waypoint, press **ENTER/MARK**, then highlight 'Delete' and press **ENTER/MARK**.
3. Press the **ENTER/MARK** key to confirm the deletion warning.

To delete waypoints by symbol:

1. From the 'By Name' tab, highlight the waypoint to be deleted and press **MENU**. Select 'Delete By Symbol' and press **ENTER/MARK**.
2. Use the **ARROW KEYPAD** to highlight the symbol of the waypoint(s) to be deleted and press **ENTER/MARK**.
3. Press **ENTER/MARK** to confirm. You may also choose 'Cancel' or press **QUIT** to stop the deletion.

To delete all waypoints or the entire waypoint list:

1. Press the **MENU** key to select the options window.
2. Use the **ARROW KEYPAD** to highlight 'Delete All' and then press **ENTER/MARK**.
3. Highlight 'OK' and press **ENTER/MARK** to confirm.

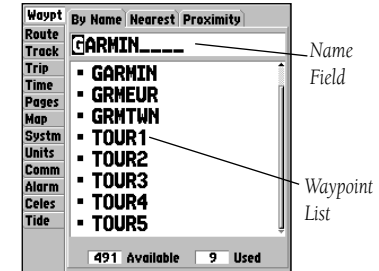
Waypoint Options

You may also search for a waypoint by name:

1. Highlight the name field and press **ENTER/MARK**.
2. Use the **ARROW KEYPAD** to select the first letter of the name.
3. Move to the **RIGHT** and enter the second letter if you do not see it on the list below.
4. Repeat this until the name appears. Press **ENTER/MARK** when you see the name.
5. Highlight the name on the list and press **ENTER/MARK** again to review the waypoint.

Reference

Nearest/Proximity Waypoint Lists

Waypt	By Name	Nearest	Proximity
Route	Waypoint	Brg	Dist
Track	TOUR3	308 ⁿ	1.0 ⁿ
Trip	TOUR2	182 ⁿ	1.8 ⁿ
Time	ROCKS	045 ⁿ	1.9 ⁿ
Pages	SHIPWRECK	264 ⁿ	1.9 ⁿ
Map	TOUR4	001 ⁿ	3.6 ⁿ
Systm	PILE	338 ⁿ	3.6 ⁿ
Units	TOUR1	190 ⁿ	4.0 ⁿ
Comm	BAIT	327 ⁿ	10.2 ⁿ
Alarm	SWIM	303 ⁿ	10.3 ⁿ
Celes	FISH	014 ⁿ	11.5 ⁿ
Tide			

Nearest Waypoint List

Waypt	By Name	Nearest	Proximity
Route	Proximity Alarm		
Track	On		
Trip	Waypoint	Distance	
Time	SHIPWRECK	0.40 ⁿ	
Pages	ROCKS	1.00 ⁿ	
Map	PILE	0.25 ⁿ	
Systm	-----	----- ⁿ	
Units	-----	----- ⁿ	
Comm	-----	----- ⁿ	
Alarm	-----	----- ⁿ	
Celes	-----	----- ⁿ	
Tide	-----	----- ⁿ	

Proximity Waypoint List

Nearest Waypoint List

The second waypoint submenu list available from the 'Waypt' tab is the 'Nearest' list, which shows the ten nearest waypoints that are within 100 miles of your present position. The nearest waypoints are continuously updated to your present position, and provide quick access to the closest points of safety in emergency situations.

To scroll through and review the nearest waypoint list:

1. Highlight the 'Nearest' tab, then use the **ARROW KEYPAD** to scroll through the list in either direction.
2. Press **ENTER/MARK** to review the highlighted waypoint.
3. To return to the waypoint list, highlight 'OK' and press **ENTER/MARK**.

To select a nearest waypoint as a NAV/MOB destination:

1. Use the **ARROW KEYPAD** key to select the desired waypoint.
2. Press **NAV/MOB**, followed by **ENTER/MARK**.

Proximity Waypoint List

The third waypoint submenu list available from the 'Waypt' tab is the 'Proximity' list, which lets you define an alarm circle around a stored waypoint position, and can be used to help you avoid reefs, rocks or restricted waters. Up to ten waypoints may be listed, with a maximum alarm radius of 99.99 nautical or statute miles or kilometers. If a proximity alarm circle overlaps with an existing alarm circle, a 'Proximity Overlaps Another Proximity Waypoint' message will appear each time the unit is turned on. If you enter an alarm circle overlap, you will only be alerted to the closest proximity waypoint.

The following options are available from the 'Proximity' submenu of the 'Waypt' tab:

- Add Waypoint— adds a waypoint to the proximity list from the waypoint list.
- Clear Alarm— removes selected waypoint from proximity list.
- Clear All— removes all waypoints from proximity list.

To display the proximity waypoint menu options:

1. Using the **ARROW KEYPAD**, highlight the 'Proximity' tab and press the **MENU** key.

To add a proximity waypoint:

1. From the 'Proximity' tab menu options, use the **ARROW KEYPAD** to highlight 'Add Waypoint' and press **ENTER/MARK**. The 'Find' screen appears.
2. Use the **ARROW KEYPAD** to select a category from the 'Find' list. Select a point from the chosen category and press **ENTER**. The 'Waypoint Review' page will be displayed.
3. Press **ENTER/MARK** to confirm. The distance field will now be highlighted.
4. Press **ENTER/MARK** to begin entry of the proximity radius.
5. Use the **ARROW KEYPAD** to enter a distance value (to 99.99 units) and press **ENTER/MARK**.

Proximity Waypoints

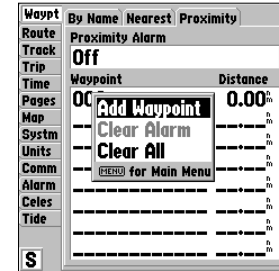

Proximity Tab Options Menu

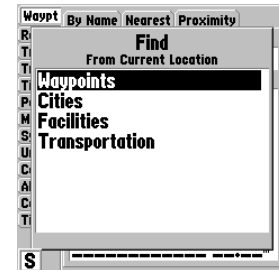

'Find' list.

Reference

Going to a Destination

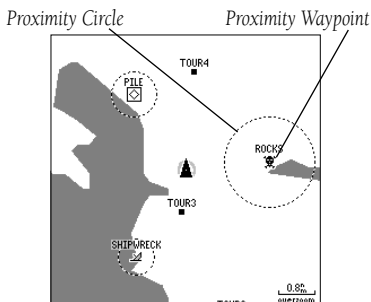

A dashed circle will appear showing the alert boundary for the proximity waypoints.

To turn proximity alarms on or off:

1. Use the **ARROW KEYPAD** to highlight the field below "Proximity Alarm" and press **ENTER/MARK**.
2. Select the desired 'ON' or 'OFF' setting and press **ENTER/MARK**.

To clear one or all proximity waypoint(s) from the list:

1. Use the **ARROW KEYPAD** to highlight the proximity waypoint to clear and then press the **MENU** key.
2. To clear a single alarm, highlight the 'Clear Alarm' field and press **ENTER/MARK**.
3. To clear all proximity waypoints, select the 'Clear All' option and press **ENTER/MARK**.
4. Use the **ARROW KEYPAD** to highlight the 'OK' prompt and press **ENTER/MARK** to confirm.

Going to a Destination

Using the **NAV/MOB** key, the GPSMAP 162 provides four ways to navigate to a destination: Go To Waypoint, Follow Track (TracBack), MOB (Man OverBoard), and Follow Route navigation. Once you are actively navigating, you will see a straight line that always runs from the point where you started the GOTO, to the destination. The easiest method for selecting a destination is the 'Go To' function, which lets you select a destination waypoint and quickly sets a direct course from your present position. If you have a waypoint highlighted on a list or the map, 'Go To <waypoint name>' will appear in addition to 'Go To Waypoint'. The 'Go To' function can be accessed from a list of waypoints or graphically from the map display.

To activate a 'Go To' from the find list:

1. Press the **NAV/MOB** key.
2. Use the **ARROW KEYPAD** to highlight 'Go To Point' and press **ENTER/MARK**. The 'Find' list will be displayed.
3. Select a category (i.e. Waypoint, City, Facilities, Transportation) from the 'Find' list, then using the **ARROW KEYPAD** select a point from that category. Press **ENTER/MARK** to display a review page for the selection, then with the 'GO TO' button highlighted, press **ENTER/MARK** to begin navigation.

Selecting a 'Go To' Graphically

A graphical 'Go To' may be used to select one of three items from the map display: an existing waypoint, an on-screen map item (roads, rivers, cities, nav aids, etc.), or a new map point (non-map item). If you are selecting a map item as the 'Go To' destination, the GPSMAP 162 will automatically use the name of the map item, but the point will not be stored in the waypoint list. See page 39 for creating waypoints using map items. If you are selecting a new map point (non-map item) as the 'Go To' destination, the GPSMAP 162 will automatically create or move a waypoint named 'MAP' at the cursor position.

To activate an existing waypoint or map item as a 'Go To' from the map display:

1. Use the **ARROW KEYPAD** to highlight the waypoint or map item on screen and press **NAV/MOB**.
2. You will see 'Go To <waypoint name>', then press **ENTER/MARK**.

To activate a new map point (non-map item) as a 'Go To' from the map display:

1. Use the **ARROW KEYPAD** to move the arrow cursor to the desired position.
2. Press **NAV/MOB**, you will see 'Go To MAP Point' highlighted, then press **ENTER/MARK**.

Going to a Destination

Choose a category from 'Find' list then select a point from that category.

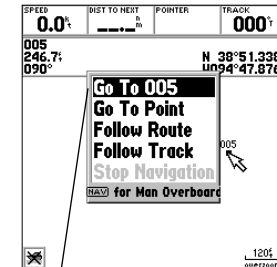

The waypoint or map item name will automatically appear when highlighted and NAV/MOB is pressed.

TracBack Navigation



'Go To MAP Point' allows you to navigate to a spot on the map which is not a waypoint or map item.



Highlight 'Save' and press ENTER/MARK to save an active track log.

TracBack Navigation (Follow Track)

The second method of navigating to a destination is by using the TracBack feature. The TracBack function allows you to retrace your path using the track log automatically stored in the receiver's memory, which will eliminate the need to store waypoints along the way. TracBack routes are created by reducing your track log into a route of up to 30 turns and activating an inverted route along those points. Once activated, a TracBack route will lead you back to the oldest stored track log point, so it's good idea to clear the existing track log at the start of your current trip before you get started.

To clear the track log and define a starting point for a TracBack route:

1. Press the **MENU** key twice to display the Main Menu page.
2. Using the **ARROW KEYPAD**, highlight the 'Track' tab, then highlight the 'Active' tab to the right.
3. Use the **ARROW KEYPAD** to select the 'Clear' option and press **ENTER/MARK**.
4. Highlight the 'OK' field and press **ENTER/MARK**.

You must first save the track log before you can use the 'Follow Track' feature. The Save feature allows you to store a track log from certain times and dates.

To save a track log:

1. From the Main Menu, use the **ARROW KEYPAD** to highlight the 'Track' tab, then highlight the 'Active' tab to the right.
2. Use the **ARROW KEYPAD** to select the 'Save' option and press **ENTER/MARK**.
3. From the 'Save Back Through' window, highlight the desired time, date, or 'Entire Log' and press **ENTER/MARK**.
4. Next, the track will begin saving and then display the 'Saved Track' window when done. The default name, distance and number of points will be displayed. Highlight 'OK' and **ENTER/MARK** press to save the track.

To activate a TracBack using the NAV/MOB key:

1. Press the **NAV/MOB** key, then highlight the 'Follow Track' option and press **ENTER/MARK**.
2. Highlight the track you wish to follow and press **ENTER/MARK**.
3. Choose either 'Original', which will navigate you from the end to the start of your trip, or 'Reverse', which will navigate you from the start to the end of your trip and press **ENTER/MARK**.

Once a TracBack has been activated, the GPSMAP 162 will take the track log currently stored in memory and divide it into segments called 'legs'. Up to 30 temporary 'turns' will be created to mark the most significant features of the track log in order to duplicate your exact path as closely as possible. To get the most out of the TracBack feature, remember the following tips:

- Always clear the track log at the point that you want to go back to (dock, etc.).
- The 'Record Mode' option on the track log setup page must be set to 'Fill' or 'Wrap'.
- There must be at least two track log points stored in memory to create a TracBack route.
- If the track log interval is set to the 'Time' option, the route may not follow your exact path (keep the interval set to 'resolution' for best performance).
- If the receiver is turned off or satellite coverage is lost during your trip, the TracBack will draw a straight line between any point where coverage was lost and where it resumed.
- If your track log's changes in distance and direction are too complex, 30 waypoints may not mark your path accurately. The receiver then assigns the 30 waypoints to the most significant points of your track, and simplifies segments with fewer changes in direction.

To stop TracBack navigation:

1. Press the **NAV/MOB** key, highlight 'Stop Navigation' and press **ENTER/MARK**.
2. Choose either 'Yes' or 'No' and press **ENTER/MARK** to confirm.

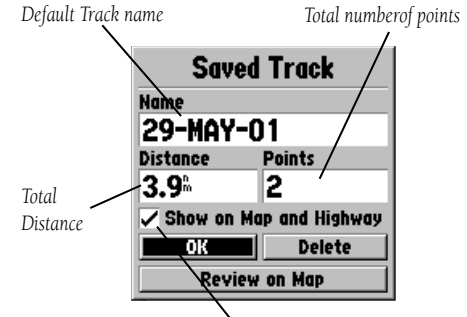
TracBack Navigation

Check this box to display track



You must save a track before using the 'Follow Track' option.

Reference

MOB: Man OverBoard

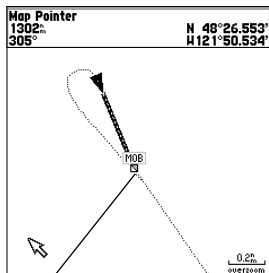

The MOB function allows you to quickly activate a navigation back to a location.

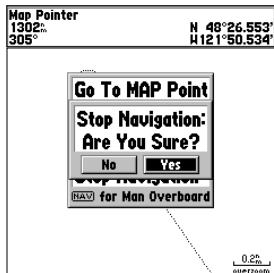

Highlight 'Yes' and press ENTER/MARK to stop navigation.

MOB

The GPSMAP 162's Man OverBoard function (MOB) lets you simultaneously mark and set a course to a position for quick response to emergency situations.

To activate the MOB function:

1. Press and hold the **NAV/MOB** key or press the **NAV/MOB** key twice.
2. Press the **ENTER/MARK** key to confirm and begin navigating to the MOB position.

Once a MOB has been activated, a 'MOB' waypoint with a diver down symbol will be created and the unit will be on an active navigation to that point. Use any of the Navigation Pages to guide you back to the MOB point. The MOB waypoint will be stored in the waypoint list and may be deleted like any other waypoint.

To stop navigation to the MOB position:

1. Press the **NAV/MOB** key, highlight 'Stop Navigation' and press **ENTER/MARK**.
2. Choose either 'Yes' or 'No' and press **ENTER/MARK** to confirm.

Routes

The last way to navigate to a destination is to create a user-defined route. The GARMIN GPSMAP 162 system lets you create and store up to 20 reversible routes, with up to 30 waypoints each. Routes can be created and modified in two ways. The first way is to 'Edit as Text' from the Route Review page, allowing you to see a list of the waypoints as you create, review, or modify the route. The second way is from the 'Edit on Map' from the Route Edit map page, allowing you to see each route graphically on-screen as you create, review, or modify the route. All of the GPSMAP 162's route functions are accessed through the Main Menu page or the **NAV/MOB** key.

To create a route using text from the Route Review page:

1. Press the **MENU** key twice to display the Main Menu page.
2. Use the **ARROW KEYPAD** to highlight the 'Route' tab and press the **MENU** key to display the route options page.
3. Select the 'New Route' option and press **ENTER/MARK**.
4. Use the **ARROW KEYPAD** to highlight the first field under the word "Waypoint" and press **ENTER/MARK**.
5. From the 'Find' list, choose a category, then choose a point from that category. Press **ENTER/MARK** to display a review page. With the 'OK' button highlighted press **ENTER/MARK** to place the selected point in the route. The next field down on the list will automatically highlight.
6. Keep using the methods on steps 4 and 5 until the desired route points have been entered in the order you want to navigate to them. Press **QUIT** to return to the Route List page.



Note: To use map items as route points, you will need to either already have them saved as a waypoint or create the route graphically on the Route Edit map page.

Creating Routes

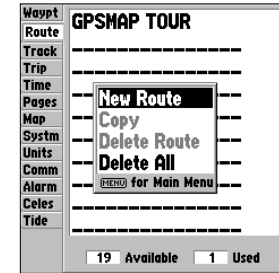

Route Tab and Route Options Menu

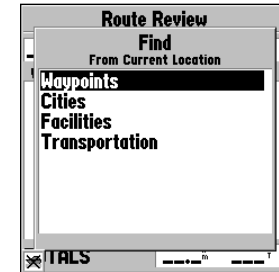

Choose a waypoint from either the 'By Name' or 'Nearest' tab list.

Reference

Creating Routes

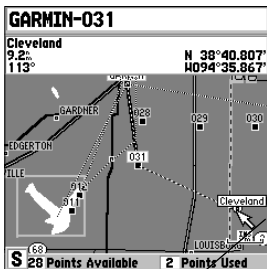

You will see 'ADD' below the cursor as you add points.

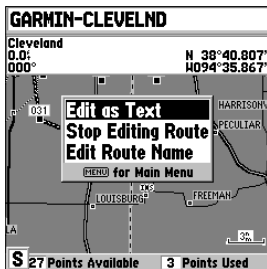

To stop editing, press **MENU** and select 'Edit as Text' or 'Stop Editing Route'.

To create a route graphically from the Route Review page:

1. Press the **MENU** key twice to display the Main Menu page. Use the **ARROW KEYPAD** to highlight the 'Route' tab, then press the **MENU** key to display the route options page.
2. Select the 'New Route' option and press **ENTER/MARK**.
3. Press **MENU**, highlight 'Create on Map' and press **ENTER/MARK**.
4. To add an existing waypoint or map item to the route, use the arrow cursor to highlight the desired waypoint or map item on screen and press **ENTER/MARK**.

To add a map location to the route that is not an existing waypoint or map item, you must mark it as a new waypoint. Use the arrow cursor to select the desired map position and press **ENTER/MARK**. Press **ENTER/MARK** again to confirm the new waypoint. You may also change the name and symbol of the new waypoint (see page 41).

5. As you add each new waypoint to the route, the data window just above the map display will show the waypoint/map item name or 'Map Pointer', bearing and distance from your location, and coordinates of the cursor. The top data window shows the name of the route as it is being created, using the beginning and end points as the default name. The bottom of the display shows the number of available and used points. A route line appears on the map to indicate each completed leg, and a dotted line appears to indicate the distance and bearing to the arrow cursor from the last route waypoint.
6. Repeat steps 4 and 5 until you have finished defining all route waypoints.
7. To change the route name, press **MENU**, then select 'Edit Route Name' and press **ENTER/MARK**. The route name will be highlighted. Press **ENTER/MARK** to highlight the first character, then use the **ARROW KEYPAD** to change the character and move to the next space. Press **ENTER/MARK** when you are done changing the route name, then **QUIT** to return to the route list.
8. When finished, press **MENU**, highlight either 'Edit as Text' to return to the Route Review page, or 'Stop Editing Route' (or press **QUIT**) to return to the Route List page, then press **ENTER/MARK**; or just press **QUIT**.

Route List Page

The GPSMAP 162 Route List page displays all the routes currently stored in memory, along with a descriptive name for each route. Once a route has been created, it can be activated and used for navigation with the **NAV/MOB** key. A route may be followed in the same sequence as it was originally created, or you can invert the route and navigate from the end waypoint back to the beginning waypoint. From the Route list menu, you may choose 'New Route' (pg 51), 'Copy', 'Delete Route', or 'Delete All'.

To activate a route with the NAV/MOB key:

1. From any page, press the **NAV/MOB** key, then using the **ARROW KEYPAD**, highlight 'Follow Route' and press **ENTER/MARK**. (If you highlight a route from the Route List or Route Review page and press **NAV/MOB**, the window will automatically display, 'Follow <the route name>'.)
2. Highlight the route you wish to navigate and press **ENTER/MARK**.
3. Choose 'Activate' or 'Invert and Activate' and press **ENTER/MARK**. ('Activate' will use the route as is, 'Invert and Activate' will reverse the route then activate it.)

To deactivate (stop navigation) of a route:

1. Press the **NAV/MOB** key, highlight 'Stop Navigation' and press **ENTER/MARK**.
2. Choose either 'Yes' or 'No' and press **ENTER/MARK** to confirm.

To copy or delete a route:

1. From the Route List, using the **ARROW KEYPAD**, highlight the route you want to copy or delete and press **MENU**.
2. Choose either 'Copy' or 'Delete Route' and press **ENTER/MARK** and with "OK" highlighted, press **ENTER/MARK** again to confirm a deletion.

To delete all routes:

1. From the Route List, press **MENU**.
2. Highlight 'Delete All' and press **ENTER/MARK** and with "OK" highlighted, press **ENTER/MARK** again to confirm the deletion.

Reference

Route List Page



If you highlight a route name from the Route List and press NAV/MOB, the name will automatically appear.



Route List Options Menu

Reference

Route Review Page

Route Review		
TOUR1-TOURS----		
Waypoint	Distance	Course
TOUR1	0.0 ^h	003 ^h
TOUR2	2.3 ^h	330 ^h
TOUR3	4.8 ^h	001 ^h
TOUR4	7.9 ^h	325 ^h
TOURS	17.7 ^h	---
----- ^h		
----- ^h		
TOTALS	17.7^h	337^h

Route Name: TOUR1-TOURS----

Route Points: TOUR1, TOUR2, TOUR3, TOUR4, TOURS

Data Fields: 0.0^h, 2.3^h, 4.8^h, 7.9^h, 17.7^h, 003^h, 330^h, 001^h, 325^h, ---^h, ---^h, 17.7^h, 337^h

Data Totals: 17.7^h, 337^h

Route Review		
TOUR1-TOURS		
Waypoint		Course
TOUR	Edit on Map	003 ^h
TOUR	Insert Waypoint	003 ^h
TOUR	Remove Waypoint	330 ^h
TOUR	Invert	001 ^h
TOUR	Plan Route	325 ^h
TOUR	Delete Route	---
----- ^h		
----- ^h		
TOTALS	17.7^h	337^h

Route Review Options Menu

Route Review Page

Once you have created a route, the Route Review page allows you to review and modify the route displayed.

To view the Route Review page:

1. Press **MENU** twice, then highlight the 'Route' tab.
2. Highlight the name of the route you wish to review and press **ENTER/MARK**.

The Route Review page also allows you to enter your own 15-character name for any listed route. By default the name includes the first and last waypoints in the route.

To enter a custom route name:

1. From the Route Review page, highlight the name field and press **ENTER/MARK** to begin editing.
2. Use the **ARROW KEYPAD** to enter the desired name and press **ENTER/MARK** when finished.

Once you are on the Route Review page, you may review the route points (waypoints or map items) one at a time from the list:

To review individual route points:

1. Highlight the desired point and press **ENTER/MARK**.
2. On the Waypoint Review page, you may choose 'Delete' (permanently delete the waypoint from the unit) 'Show On Map' (show the selected point on the Map Page) or 'Next' (highlight the next point on the route list).

If the route point is a map item, you may choose 'Create Wypnt' to turn it into a permanent waypoint. Once you are back on the Route Review page, the next point in the route will automatically be highlighted. This allows you to review each point on the route by pressing only **ENTER/MARK** repeatedly.

Route Review Menu Options

Menu options available from the Route Review page are Edit on Map, Insert/Add Waypoint, Remove Waypoint, Invert, Plan Route, and Delete Route.

Edit on Map— this option allows you to review and modify the route displayed through a pop-up window menu for each point (waypoint or map item) on a map page. You may also use the cursor to insert a new route point on a route leg, and review the waypoint or map item.

To edit the route on the map:

1. From the Route Review page options menu, select 'Edit on Map' and press **ENTER/MARK**.

To review or modify a route point:

1. Place the cursor on a route point and press **ENTER/MARK**, or press **MENU** and select 'Edit as Text'. On the Waypoint Review page, you may review and modify the waypoint name, symbol, coordinates, and depth, just like on the Waypoint Edit page (see page 41). Make any desired changes and press **ENTER/MARK** again when done.

To remove a route point:

1. Place the cursor on the desired point and press **MENU**. Select 'Remove' and press **ENTER/MARK**.

To move a route point:

1. Place the cursor on the desired point and press **MENU**. Select 'Move' and press **ENTER/MARK**. The cursor will now have 'Move' displayed below it.
2. Move the cursor to the new map position and press **ENTER/MARK** to relocate the point.

To add turns at the beginning or end of the route:

1. Select the first or last route waypoint with the map cursor, and press **MENU**.
2. Highlight the 'Add' option and press **ENTER/MARK**.
3. Move the cursor to the new point or position and press **ENTER/MARK**.
4. If you are not inserting an existing waypoint, press **ENTER/MARK** to confirm the new waypoint.
5. Repeat steps 3 and 4 to insert additional waypoints, or press **QUIT** to finish.

Editing Routes

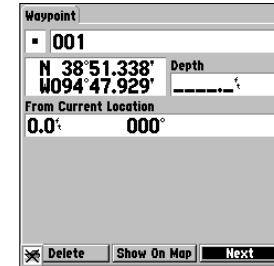

Select a route waypoint on the map, then press **ENTER/MARK** to review the waypoint.

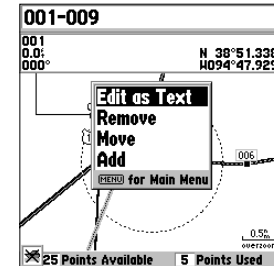

Choose 'Edit as Text' to return to the Route Page

Reference

Editing Routes

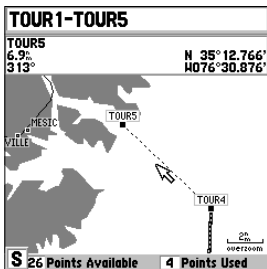

Highlight the route leg on which you wish to insert a waypoint and press **ENTER/MARK**.

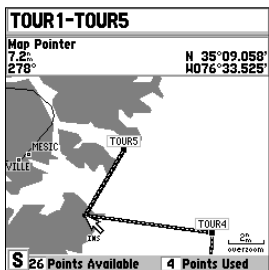

Drag the route leg to an existing waypoint (shown), map item, or a blank spot on the map to create a new route point.

The GPSMAP 162s 'Edit on Map' mode also allows you to insert a new route waypoint in any route leg using the map cursor.

To insert a new point between two existing route waypoints:

1. Use the **ARROW KEYPAD** to select the leg you want to insert the new waypoint in (the route line will highlight and change to a dotted line when the leg is selected) and press **ENTER/MARK**.
2. Move the cursor to the new map position, existing waypoint, or map item (You will see 'ADD' below the arrow and the route lines will move with the arrow), and press **ENTER/MARK**.
3. If you are not inserting an existing point, press **ENTER/MARK** to confirm the new waypoint.

Insert/Add Waypoint— Allow you to insert a waypoint into the list of route points or add a point(s) onto the end of the route.

To insert a point into the route or add a point to the end:

1. From either the Route Review or Active Route pages, use the **ARROW KEYPAD** to highlight the point you wish to insert the new point before (to add a point to the end, highlight the blank field at the bottom of the list).
2. Press **MENU**, highlight 'Add Waypoint' or 'Insert Waypoint' and press **ENTER/MARK**.
3. From the 'Find' list, select a point to be inserted/added and press **ENTER/MARK**.

Remove Waypoint— Allows you to remove a point (waypoint or map item) from a route. This option is available from both the Route Review and Active Route Pages.

To remove a point from a route:

1. From either the Route Review or Active Route pages, use the **ARROW KEYPAD** to highlight the point to remove and press **MENU**.
2. Highlight 'Remove Waypoint' and press **ENTER/MARK**.

Invert— The Invert function will reverse the route you choose. This option is available from both the Route Review and Active Route Pages.

To invert a route:

1. From the Route Review or Active Route page, press **MENU**.
2. Using the **ARROW KEYPAD**, highlight 'Invert' and press **ENTER/MARK**.

Plan Route— The Route Review and Active Route pages also display trip-planning information for each leg or the entire route. Available information includes Course, ETA, Fuel (to point), Leg Distance, Leg Fuel, Leg Time, Sunrise and Sunset (at point location) and Time To (point).

To use the Plan Route feature:

1. To select the desired planning figure, highlight the desired route from the Route List and press **ENTER/MARK** to display the Route Review page. If you have an active route, you may also do the following from the Active Route page:
2. One of nine available planning figures appears to the right of each route waypoint and its distance. Use the LEFT/RIGHT keys on the **ARROW KEYPAD** to select the desired item.
3. To enter planning information, Press **MENU**, select 'Plan Route' from the options list, and press **ENTER/MARK**. Enter the figures for Speed, Fuel Flow, Depart(ure) Time, and Depart(ure) Date. Press **QUIT** to return to the Route Plan Page.



Fuel flow rates on your unit are measured in "units per hour." System setting changes for units of measure (statute, nautical or metric) do not affect the fuel flow measure. You should enter fuel flow rates based upon available information for your vehicle (operator's manual, performance specifications, etc.) and make note of the desired units of measure (gallons, liters, etc.).

Delete Route— deletes route and any map item points within route.

To delete a route:

1. From the Route Review page press **MENU**.
2. Highlight 'Delete Route' and press **ENTER/MARK** and **ENTER/MARK** again to confirm the deletion.

Reference

Editing Routes

Route Review		
TOURS-TOUR1		
Waypoint	Distance	Course
TOUR5	0.0 ^m	145 [°]
TOUR4	9.8 ^m	181 [°]
TOUR3	12.9 ^m	150 [°]
TOUR2	15.4 ^m	183 [°]
TOUR1	17.7 ^m	

TOTALS	17.7^m	157[°]

Press LEFT or RIGHT on the ARROW KEYPAD to change the data field.

Route Review		
TOUR1-TOURS		
Waypoint	Distance	Course
Plan Route		
T	Speed	Depart Time
T	0.0 ^h	06:00 ^h
T	Fuel Flow	Depart Date
T	0.0 ^h	01-JAN-06

TOTALS	17.7^m	337[°]

Plan Route Data Fields

Active Route Page

Active Route		
TOUR1-TOURS		
Waypoint	Distance	Course
TOUR1	---	017 ^h
▶ TOUR2	2.3 ^h	344 ^h
TOUR3	4.8 ^h	015 ^h
TOUR4	7.9 ^h	339 ^h
TOUR5	17.7 ^h	---
---	---	---
---	---	---
TOTALS	17.7^h	351^h

Active Route Page

Active Route		
TOUR1-TOURS		
Waypoint	Edit on Map	Course
TOUR	Insert Waypoint	017 ^h
▶ TOUR	Remove Waypoint	344 ^h
TOUR	Invert	015 ^h
TOUR	Plan Route	339 ^h
TOUR	Re-evaluate	---
---	---	---
---	---	---
TOTALS	17.7^h	351^h

Active Route Page Menu Options

Active Route Page

Whenever you have activated a route in the GPSMAP 162 system, the Active Route page shows each point (waypoint or map item) of the active route, with the point name, distance and choice of Course, ETA, Fuel to point, Leg Distance, Leg Fuel, Leg Time, Sunrise and Sunset at point location, or Time To point for each point from your present position. The current destination point, the 'active' point, is marked with an arrow icon. As you navigate a route, the waypoint list will automatically update to indicate the next 'active' point first. The Active Route and Route Review pages share many of the same features and options.

The following route options are available from the active route page:

- Edit on Map— see page 55 for instructions.
- Add Waypoint— see page 56 for instructions.
- Remove Waypoint— see pages 55 for instructions.
- Invert— see page 57 for instructions.
- Plan Route— see page 57 for instructions.
- Re-evaluate— recalculates and reactivates the current route data.

Re-evaluate— reactivates the current route and selects the route leg closest to your current position as the active leg. The active leg defines the current 'from' and 'to' waypoints.

To Re-evaluate an active route:

- 1 From the Active Route page, press **MENU**.
- 2 Using the **ARROW KEYPAD**, highlight 'Re-evaluate' and press **ENTER/MARK** to recalculate.

Main Menu Page

The GPSMAP 162's Main Menu Page provides access to various waypoint, system, navigation and interface management, and setup menus in an easy to use “tab” format. The Main Menu page is available from any page in the GPSMAP 162's system, and is accessed through the **MENU** key.

See pages 2-3 for additional instructions changing settings and entering data.

To access the Main Menu Page:

1. Press **MENU** twice.

The 13 Menu tabs are divided into categories by function.

To select a Menu tab from the Main Menu page:

1. Move the **ARROW KEYPAD** UP or DOWN to highlight the tab you want to view. The information for the highlighted tab will automatically appear to the right.
2. If you want to highlight any of the tab items, press to the RIGHT on the **ARROW KEYPAD**, then move UP or DOWN to select individual items.
3. You may then press either **MENU** for additional submenu options or press **ENTER/MARK** to make changes to the highlighted item.
4. Press LEFT on the **ARROW KEYPAD** to get back to the Menu tab list. Pressing **QUIT** will take you out of the Main Menu page.

The Main Menu tabs are:

- Waypt— allows you to create, edit or delete waypoints. See pages 38-46.
- Route— allows you to create, edit, activate or delete routes. See pages 51-58.
- Track— lets you record a track, define how it is recorded and displayed.
- Trip— provides trip speeds, odometers, averages, and trip timers.
- Time— sets up time format, time zones, and daylight savings.

Main Menu Tabs

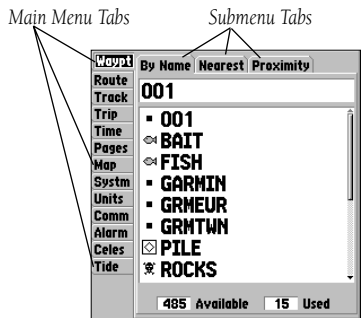

Main Menu Page

Reference

Main Menu: Track Tab



Active Track Tab



Saved Track Tab

- Pages—allows user to determine which of the main pages will be displayed.
- Map— sets up Map Page features, zooms, and text size. See pages 29-34.
- System— defines beeper and simulator, restores setup, and displays software version.
- Units— defines position format, datum, heading, and distance and speed units.
- Comm— interface settings for use with a PC or second device.
- Alarm— sets up alarms for anchor drag, arrival, off course, and clock.
- Celes— Celestial page shows sun/moon time cycles and positions
- Tide— Tide page show 12 hour tide chart with levels and times

Track Tab— lets you specify whether or not to record a track log (an electronic ‘breadcrumb trail’ recording of your path), define how it is recorded, or save track log data for future use. The Track tab Page also provides an indicator of the memory used for the active track log and options to clear the track memory or start a TracBack route. See pages 48-49 for TracBack information. The Track submenu is divided in two tabs: ‘Active’ tab and the ‘Saved’ tab.

The ‘Active’ tab is for the active log (the log currently being recorded). It displays track memory used and current settings. The ‘Saved’ tab displays and manages a list of any saved track logs, allows TracBack activation, map display of saved logs. The active log stores up to approximately 2000 track log points, based upon the criteria specified in the Track settings. Up to 10 track logs may be saved in memory, with up to 250 track log points in each saved log.

For the ‘Active’ tab, the following settings are available:

- Record Mode— lets you select one of three track recording options:
 - Off— No track log will be recorded. Note that selecting the ‘Off’ setting will prevent you from using the TracBack feature.
 - Fill— a track log will be recorded until the track memory is full.
 - Wrap— A track log will be continuously recorded, wrapping through the available memory (replacing the oldest track data with new data).

Reference

- Interval— defines the frequency at which the track plot is recorded. Three interval settings are available:

Time— records track plot based on a user-defined time interval.

Resolution— records track plot based upon a user-defined variance from your course over ground. The resolution option is the default setting and is recommended for the most efficient use of memory and TracBack performance. The distance value (entered in the value field) is the maximum error allowed from the true course before recording a track point.

Distance— records track based on a user-defined distance between points.

- Value— defines the distance or time used to record the track log.
- Save— allows you to save the current active track log.
- Clear— allows you to clear the active track log currently stored in memory.

For the 'Saved' tab, the following menu options are available:

- Show Map— displays the saved track log on a Track Map page.
- Delete Track— deletes highlighted saved track log from memory.
- Delete All— deletes all saved track logs from memory.

You may also activate a TracBack from any of the saved tracks on this tab.

To activate a TracBack from the 'Saved' tab list:

- Using the **ARROW KEYPAD**, highlight the track you wish to use for a TracBack and press **NAV/MOB**.
- The 'Follow <track name>' will automatically appear highlighted. Press **ENTER/MARK**.
- Choose either 'Original', which will navigate you from the end to the start of your trip, or 'Reverse', which will navigate you from the start to the end of your trip and press **ENTER/MARK**.

Main Menu: Track Tab

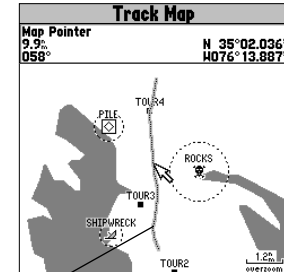

You can use the 'Show Map' option to display a saved track.



The track name will automatically appear when highlighted on the 'Saved' list and NAV/MOB is pressed.

Reference

Main Menu: Trip, Time and Pages Tabs

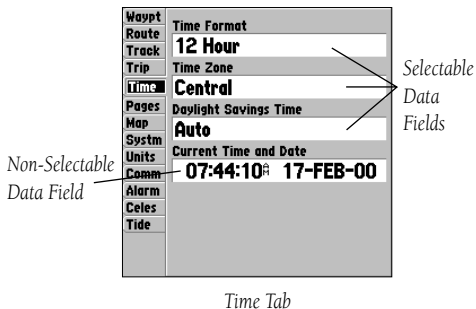
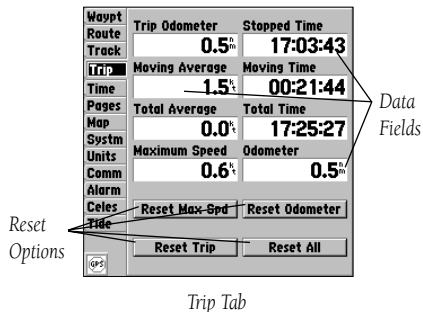

Trip Tab— displays Trip Odometer, Moving Average speed, Total Average speed, Maximum Speed, Stopped Time, Moving Time, Total Time, and Odometer. You may reset the data by choosing from 'Reset Trip', 'Reset Odometer', 'Reset Max Spd (speed)', or 'Reset All' and pressing **ENTER/MARK**.

Time Tab— displays the current time and date, allows you to adjust the 12 or 24 hour time format, enter a time zone and adjust for daylight savings to show correct local time.

The following options are available:

- Time Format— choose from 12 or 24 hour (military) time format.
- Time Zone- choose your correct time zone to show correct local time or enter a UTC Offset. The UTC (also called Greenwich Time) offset is how many hours you are ahead or behind the time line. See the table on page 74 for time offsets.
- Daylight Savings— choose from 'Auto', 'On', or 'Off' to adjust for daylight savings.

Pages Tab— allows you to turn on/off any of the main pages or 'Jump To' a particular page.

To select/deselect a main page:

1. Use the **ARROW KEYPAD** to highlight the box to the left of the page name. Pressing **ENTER/MARK** will select/deselect that page. When a page is selected, a '✓' will appear in the box. You must leave at least one page checked.

You may also press Menu and choose from one of the following and press **ENTER/MARK**:

- Enable All Pages— selects all pages.
- Basic Chartplotter— selects Map page only.
- Nav Tools Only— selects Compass, Highway, and Active Route pages only.

To 'Jump To' a specific page:

1. Use the **ARROW KEYPAD** to highlight the 'Jump To' option to the right of the desired page and press **ENTER/MARK**.

System (System) tab— controls system setting for beeper, speed filter, languages, system mode, simulator controls, restores factory settings, and displays software version.

The following settings are available:

- **Beeper**— controls audible beep. Select from 'Off', 'Alarms Only' (sounds for alarms/messages), or 'Key and Alarm' (sounds for key presses and alarms/messages).
- **Speed Filter**— averages speed-readings. Choose from 'Off', 'Auto' (automatically controls filtering), or 'On' (allows you to enter a value from 1 to 255 seconds).
- **Language**— select from 11 languages for the unit's on-screen display.
- **System Mode**— select from 'Normal' (Normal Navigation) or 'Simulator' (For practice ONLY)
- **Track Control***— 'Auto Track' will steer to the current navigation point. 'User Track' allows you to enter a heading in the 'Track' field.
- **Speed***— lets you enter a speed.
- **Track***— lets you enter a heading.
- **Set Position***— allows to set your location while in simulator mode. See page 11, starting with step 2, for additional instructions.

* These fields will only appear when the unit is in Simulator Mode.

The following options are available by pressing **MENU** from the "System" tab:

- **Restore Garmin Setup**— restores all settings to Garmin's original setup values for the entire unit.
- **Software Version**— displays the unit's software, basemap version and Unit ID.

Main Menu: System (System) Tab

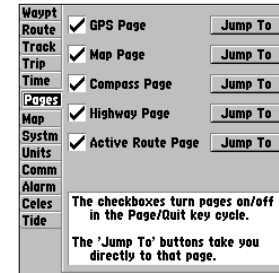

Pages Tab

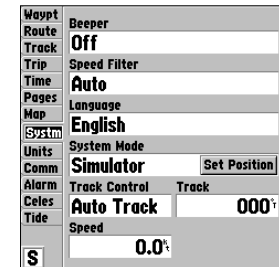

System (System) Tab

Reference

Main Menu: Units Tab



The Units tab settings will affect how navigation information is displayed on the GPSMAP 162. When in doubt, seek assistance.

If you are using a map or chart in conjunction with your GPS, make sure the settings under the 'Units' tab of the GPSMAP 162 match that of the map or chart. This information should be displayed somewhere on the map or chart.

If the information is not present, contact the map or chart maker to determine what position format, datum, heading and units of measure are being used for the map or chart.

Waypt	Position Format
Route	hddd°mm.mmm'
Track	
Trip	Map Datum
Time	WGS 84
Pages	Heading
Map	
System	True
Units	Distance, Speed and Elevation
Comm	Nautical (nm, kt, ft)
Alarm	Depth
Celes	Feet (ft)
Tide	Temperature
	Fahrenheit (°F)

Units Tab

Units Tab— defines Position Format, Map Datum, Heading, Distance, Speed, Elevation, Depth and Temperature.

The following settings are available:

- Position Format— is used to change the coordinate system in which a given position reading is displayed. You should only change the position format if you are using a map or chart that specifies a different position format or wish to use a format you are familiar with. The default format is latitude and longitude in degrees, minutes, and thousandths of a minute (hddd°mm.mmm'). The following additional formats are available:
 - hddd.dddd°— latitude/longitude in decimal degrees only
 - hddd°mm'ss.s"— latitude/longitude in degrees, minutes, seconds
 - UTM/UPS— Universal Transverse Mercator / Universal Polar Stereographic grids
 - British Grid
 - Dutch Grid
 - Finnish KKJ27
 - German Grid
 - Irish Grid
 - Maidenhead
 - MGRS
 - New Zealand
 - Qatar Grid
 - Swedish Grid
 - Swiss Grid
 - Taiwan Grid
 - Loran TD
 - User Grid
 - W Malayan RSO

For additional information on Loran TD setup, see pages 72-73.

- Map Datum— allows you to select the datum reference used to determine a given position. The default setting is 'WGS 84'. Datums are used to describe geographic positions for surveying, mapping, and navigation and are not actual maps built in the unit. Although over 100 datums are available (as listed on pages 77-78), you should only change the datum if you are using a map or chart that specifies a different datum.



WARNING: Selecting the wrong map datum can result in substantial position errors. When in doubt, use the default WGS 84 datum for best overall performance.

- Heading— lets you select the reference used in calculating heading information. You can select from ‘Auto Mag Var’, ‘True’, ‘Grid’ and ‘User Mag Var’. ‘Auto Mag Var’ provides magnetic north heading references which are automatically determined from your current position. ‘True’ provides headings based upon a true north reference. ‘Grid’ provides headings based on a grid north reference (and is used in conjunction with the grid position formats described on page 64). ‘User Mag Var’ allows you to specify the magnetic variation at your current position and provides magnetic north heading references based upon the variation you enter.

To enter a user defined magnetic variation:

1. With the “Heading” field set to ‘User Mag Var’, highlight the heading reference field (immediately to the right) and press **ENTER/MARK**.
2. Use the **ARROW KEYPAD** to enter the magnetic variation at your current position and press **ENTER/MARK**.



***WARNING:** If ‘User Mag Var’ is selected, you must periodically update the magnetic variation as your position changes. Using this setting, the unit will not automatically calculate and update the magnetic variation at your present position. Failure to update this setting may result in substantial differences between the information displayed on your unit and external references, such as a magnetic compass.*

- Distance, Speed and Elevation— lets you select the desired units of measure for distance, speed and elevation readouts in ‘Nautical’ (nm, kt, ft), ‘Statute’ (mi, mh, ft) or ‘Metric’ (km, kh, mt) terms.
- Depth— lets you select the desired units of measure for depth in Feet (ft), Fathoms (fa) or Meters (mt).
- Temperature— lets you select the desired units of measure for temperature in Fahrenheit (°F) or Celsius (°C).

Reference

Main Menu: Units Tab

Waypt	Position Format
Route	hddd°mm.mmm'
Track	
Trip	Map Datum
Time	WGS 84
Pages	Heading
Map	User Mag Var 010°E
System	Distance, Speed and Altitude
Units	Nautical (nm, kt, ft)
Comm	Depth
Alarm	Feet (ft)
Celes	Temperature
Tide	Fahrenheit (°F)

You may manually enter a magnetic variation.

Reference

Main Menu: Comm Tab

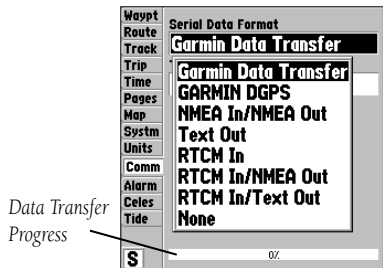

Comm Tab Serial Data Formats

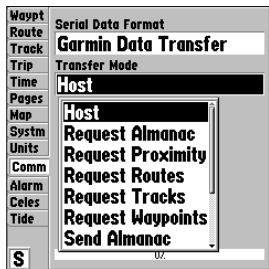

Comm Tab Transfer Modes

Comm (Communications) tab— lets you control the input/output format used when connecting your GPSMAP 162 to external NMEA devices, a DGPS beacon receiver, a personal computer, another Garmin GPSMAP 162/168, etc. Eight format settings are available:

- **Garmin Data Transfer**— the proprietary format used to upload/download MapSource data, exchange waypoint, route, track, almanac, and proximity data with a PC or another GARMIN GPSMAP 162/168. When you select 'Garmin Data Transfer', there are 11 Transfer Modes to choose from: Host, Request Almanac, Request Proximity, Request Routes, Request Tracks, Request Waypoints, Send Almanac, Send Proximity, Send Routes, Send Tracks and Send Waypoints.
- **Garmin DGPS**— used to connect the GPSMAP 162 with a Garmin DGPS beacon receiver.
- **NMEA In/NMEA Out**— supports the input/output of standard NMEA 0183 version 2.3 data, and sonar NMEA input support for the DPT, MTW and VHW sentences. See Appendix H on page 85 for the Advanced NMEA Setup feature.
- **Text Out**— outputs simple text (ASCII) output which contains time, position, and velocity data.
- **RTCM In**— allows DGPS input using a standard RTCM format, without any output capabilities.
- **RTCM In/NMEA Out**— allows Differential GPS (DGPS) input using a standard RTCM format and also provides NMEA 0183 version 2.3 output.
- **RTCM In/Text Out**— allows Differential GPS (DGPS) input using a standard RTCM format and also provides simple text (ASCII) output which contains time, position, and velocity data.
- **None**— provides no interfacing capabilities.

To select an input/output format:

1. Highlight the 'Serial Data Format' field and press **ENTER/MARK**.
2. Use the **ARROW KEYPAD** to select the desired setting and press **ENTER/MARK**.

To select a transfer mode:

1. Use the **ARROW KEYPAD** to select 'Garmin Data Transfer' in the 'Serial Data Format' field.
 1. Highlight the 'Transfer Mode' field and press **ENTER/MARK**.
 2. Use the **ARROW KEYPAD** to select the desired setting and press **ENTER/MARK**.

To restore the Serial Data Format settings to the default 'Garmin Data Transfer':

1. From the Comm tab, press **MENU**, highlight 'Restore Defaults' and press **ENTER/MARK**.

If 'Garmin DGPS' or 'RTCM In/NMEA Out' format is selected, additional fields are provided to control a GARMIN differential beacon receiver directly from your GPSMAP 162. You may have the unit automatically scan for the DGPS beacon signal or you can enter the beacon frequency and bit rate on the unit and the information will be used to tune the beacon receiver.

To have the unit automatically scan for a frequency:

1. With the unit set to 'Garmin DGPS' or 'RTCM In/NMEA Out', use the **ARROW KEYPAD** to highlight the "Beacon" field and press **ENTER/MARK**.
2. Highlight 'Scan' and press **ENTER/MARK**. The numbers in the "Frequency" field will change as the unit scans from 284 kHz to 325 kHz, 200 bit rate, then 100, at 6-second intervals.

To restart the scan:

1. Press **MENU**, highlight 'Restart Scan' and press **ENTER/MARK**.

To manually enter a frequency and bit rate:

1. With the unit set to 'Garmin DGPS' or 'RTCM In/NMEA Out', use the **ARROW KEYPAD** to highlight the "Beacon" field and press **ENTER/MARK**.
2. Highlight 'User' and press **ENTER/MARK**.
3. Highlight the "Frequency" or "Bit Rate" field, press **ENTER/MARK**, then enter a frequency or bit rate and press **ENTER/MARK** when done.

The "Status" field will show one of the following:

- Tuning— unit is attempting to tune to the specified frequency and bit rate.
- Scanning— unit is automatically scanning through the frequencies and bit rates.
- Receiving— unit is receiving DGPS signal and ready for operation.
- Check Wiring— unit is not making connection with DGPS receiver.

When the unit is receiving a DGPS signal, the "SNR" (Signal to Noise Ratio) and "Distance" fields will show data. The SNR range is 0dB to 30dB, with 30 being the best. The Distance may or may not show data, depending upon the signal being broadcast from the DGPS site.

Reference

Main Menu: Comm tab

Waypt	Serial Data Format		
Route	GARMIN DGPS		
Track			
Trip	Baud	Status	
Time	4800	Tuning	
Pages	Beacon	Bit Rate	Frequency
Map	User	200	293.0
System			
Units	SNR	Distance	
Comm	---	---	---
Alarm			
Celes			
Tide			

You may also manually enter a bit rate and frequency.

Waypt	Serial Data Format		
Route	GARMIN DGPS		
Track			
Trip	Baud	Status	
Time	4800	Tuning	
Pages	Beacon	Bit Rate	Frequency
Map	User	200	312.0
System			
Units	SNR	Distance	
Comm	---	---	---
Alarm			
Celes			
Tide			

Status Field

SNR and Distance will show data when signal is received.

Reference

Main Menu: Comm and Alarm Tabs

Waypt	Anchor Drag	Off	0.00 ^m
Route	Arrival	Time	00:00:15
Track	Off Course	Off	0.00 ^m
Trip	Clock	Off	12:00 ^h
Time	Shallow Water	Off	20.0 ^f
Pages	Deep Water	Off	100.0 ^f
Map			
System			
Units			
Comm			
Alarm			
Celes			
Tide			
S			

Alarm Tab

Waypt	Anchor Drag	Off	0.00 ^m
Route	Arrival	Time	00:00:15
Track	Off Course	Off	0.00 ^m
Trip	Clock	On	08:25 ^h
Time	Shallow Water	Off	20.0 ^f
Pages	Deep Water	Off	100.0 ^f
Map			
System			
Units			
Comm			
Alarm			
Celes			
Tide			

Press ENTER/MARK to acknowledge an alarm.

The DGPS beacon transmitters are operated by the U.S. Coast Guard (or similar government agency in other countries), which is responsible for their accuracy and maintenance. For DGPS transmitter problems or to find the most updated list of frequencies and coverage areas, contact your local USCG, or visit their web site at <http://www.navcen.uscg.mil/>.

Alarm Tab— allows you to define the alarm setting for Anchor Drag, Arrival, Off Course, Clock, Shallow Water and Deep Water.

- Anchor Drag— sets an alarm to sound when you've exceeded a specified drift distance. Enter a distance in the distance field and use the control field to turn the alarm on and off.
- Arrival— sets an alarm to sound when you're a specified distance or time away from a destination waypoint. Enter a distance radius or time for sounding the alarm and use the control field to set the alarm to 'Off', 'Dist' (Distance), or 'Time'.
- Off Course— sets an alarm to sound when you're off a desired course by a specified distance. Enter a distance in the distance field and use the control field to turn the off course alarm on and off.
- Clock— provides an alarm for the system clock. Enter a time in the time field and turn the alarm on and off from the control field menu. Remember to enter alarm times in the same time format (UTC or local) you're using for your system. The unit must be on for the clock alarm to work.
- Shallow Water/Deep Water— set alarms to sound when you enter an area of specified depth that is too shallow and/or too deep. Enter a depth in the distance fields and use the control fields to turn the alarms on and off.

To set an alarm:

1. Use the **ARROW KEYPAD** to highlight the field to the right of the alarm name you wish activate and press **ENTER/MARK**.
2. Change the mode to 'On' (Dist or Time for the 'Arrival' alarm) and press **ENTER/MARK**.
3. Highlight the next field to the right and press **ENTER/MARK**, then enter the desired settings and press **ENTER/MARK** to finish.

Celes (Celestial) Tab— displays celestial data for sun and moon rise/set, moon phase, and an approximate skyview location of the sun and moon. The moon phase will display the current visible portion of the moon as a light color. You may display this data for your current position, a position from the map, or a point location. Also, you may select a different date and time, or use the current data.

The location the unit is using will appear in the Date/Time/Position field. The timetables displayed will be based upon your current time zone. When using a position from another location outside of your time zone, you will need to set the Time Zone for that location under the “Time” tab on the Main Menu (see page 74).

To select a different location:

1. From the Celes tab, use the **ARROW KEYPAD** to highlight the position field and press **ENTER/MARK**. The ‘Find’ page will be displayed.
2. Select a ‘Flnd’ category and then select a point from that category. Press **ENTER/MARK** to display a review page then press **ENTER/MARK** confirm the selection.

To change the time or date:

1. From the Celes tab, use the **ARROW KEYPAD** to highlight the date or time and press **ENTER/MARK**.
2. Enter a new date or time and press **ENTER/MARK**.

To use current date and time:

1. From the Celes tab, press **MENU**, then use the **ARROW KEYPAD** to highlight ‘Use Current Date and Time’ and press **ENTER/MARK**. This selection will only be available if the current date is not displayed.

Reference

Main Menu: Celest (Celestial) Tab

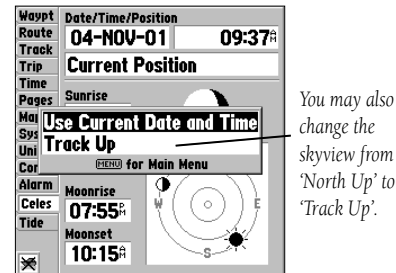
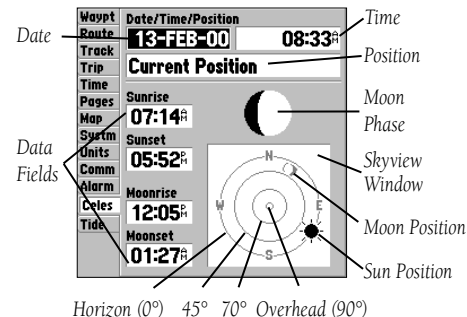

You may also change the skyview from 'North Up' to 'Track Up'.

Reference

Main Menu: Tide Tab

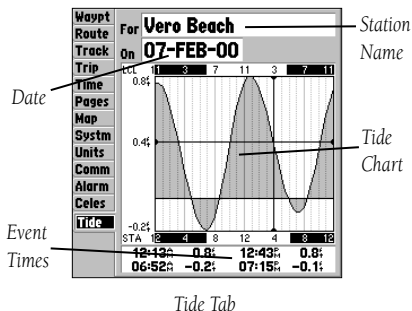

You can select from a list of nearest stations

Tide Tab— shows a graphical chart which displays tide station information in a 24 hour span starting at midnight station time. You can choose from different dates and over 3000 tide stations around the USA coastline, Alaska, Hawaii, western Canada and several of the Caribbean islands.

The top of the page displays the tide station being referenced, with the date below. The top of the chart shows a 24-hour block of local time (LCL) for your position, with the reported station time (STA) appearing at the bottom. Daylight (light bar) and nighttime (dark bar) show across the time scale, with the time progressing from left to right. (Local time scales and sunrise/sunset info may not be available for a few stations). The solid, light vertical lines are in 4-hour increments, and the light, dotted vertical lines are in 1-hour increments. A dark, vertical line (with arrows at the ends of the line) will indicate the time of day when using current date and will intersect the tide graph to show their relation.

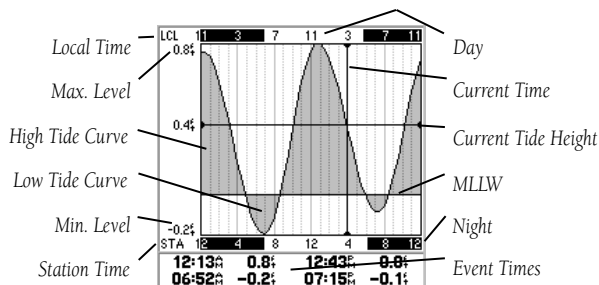

The tide curve shows as a shaded area, with higher tides being taller and lower tides shorter. The dark, horizontal line (with arrows at the ends of the line) indicates the current tide height. The figure to the left of the line will show the current tide level in feet. The Mean Lower Low Water (MLLW) appears as a solid, vertical line near the bottom of the chart (This line will only appear if the tide ranges to the zero value or below). The numbers directly below/above 'LCL' and 'STA' indicate the maximum/minimum levels, respectively. The four data fields below the chart, indicate event times and levels at which the tide changes starting in the upper left field, going downward, then to the upper right and down again.

To search for the nearest tide stations:

1. Highlight the 'For' field and press **ENTER/MARK**.

A list of the Tide Stations nearest to your location will be displayed. If you are not within several miles of any tide stations, the list will indicate "None Found". To search for tide stations at a different location, press **MENU** and select 'Nearest to Other'.

To select a tide station from the list:

1. Using the **ARROW KEYPAD**, highlight the desired station and press **ENTER/MARK**.

To change the date for the tide chart:

1. Using the **ARROW KEYPAD**, highlight the "On" field and press **ENTER/MARK**.
2. Enter the desired date and press **ENTER/MARK**.

To use the current date:

1. Press **MENU**, then highlight 'Use Today's Date' and press **ENTER/MARK**.



WARNING: When you load MapSource data into the GPSMAP 162, the tide station information provided with the unit will be deleted. Replacement tide station data for the GPSMAP 162 can be found on our web site (www.garmin.com).

If you are loading US BlueChart data, tide information can be included with the charts that you have selected.

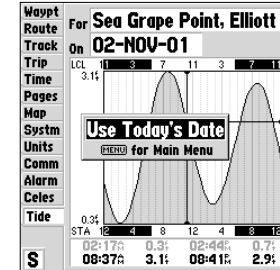
**Main Menu:
Tide Tab**

To use today's date, from the 'Tide' tab, press **MENU** and with 'Use Today's Date' selected, press **ENTER/MARK**

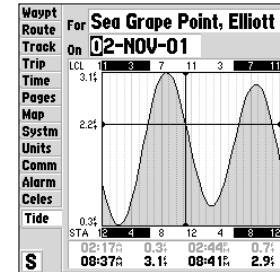

To enter a date manually, highlight the 'On' field and press **ENTER/MARK**. Using the **ARROW KEYPAD** enter a new date then press **ENTER/MARK** to accept the change.

Appendix A

Loran TD

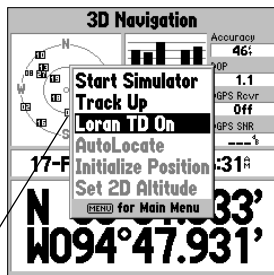

You may change to Loran TD from either the Satellite Page or Units Tab on the Main Menu.

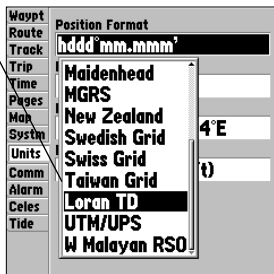

Loran TD System

LORAN C is a radio navigation aid operated and maintained in the United States by the United States Coast Guard. The name LORAN is an acronym for “LONG RANGE Navigation”. The LORAN system covers the entire United States and the U.S. Coastal Confluence Zone. From the perspective of a mariner, the system is used for ocean and coastal navigation. It can be used as a supplemental system for harbor and harbor approach navigation, and it is used for inland navigation by recreational vehicles.

LORAN TD Feature

The LORAN TD (Time Delay) feature eases the transition from using LORAN to using GPS. The GPSMAP unit automatically converts GPS coordinates to LORAN TDs for those who have a collection of LORAN fixes for favorite fishing spots and other waypoints recorded as TDs. You can display your position as a TD or enter waypoints as TDs. The accuracy to be expected from this conversion is approximately thirty meters. When the unit is placed in the LORAN TD format mode, it simulates the operation of a LORAN receiver. Position coordinates may be displayed as TDs, and all navigation functions may be used as if the unit was actually receiving LORAN signals.

Using the LORAN TD Format

When creating new waypoints using LORAN TD coordinates, you must set the correct LORAN chain number and secondary stations in the Setup TD field before storing the waypoint. After the waypoint is stored in unit memory, it will always reference the LORAN chain number and secondary stations currently selected in the Setup TD field. If you enter a different LORAN chain number, change the secondary stations or offsets in the Setup TD field, the active waypoint information will reflect those changes. Since the GPSMAP unit does not rely on the LORAN signal for navigation, it can reference a different GRI chain and/or secondary stations and still navigate to the location stored in memory.

The LORAN Position Format field is located under the Units tab in the Main Menu. The 'LORAN TD Setup' window contains the fields to select the Loran GRI-Chain Number, Primary and Secondary Stations, and TD Offsets.

Loran TD Setup

To setup Loran TD from the Main Menu:

1. Using the **ARROW KEYPAD**, highlight the "Units" tab and then the "Position Format" field press **ENTER/MARK**.
2. Highlight 'Loran TD', press **ENTER/MARK**, then highlight 'Setup' and press **ENTER/MARK**.
3. To change the settings of any of the five fields, highlight the field, press **ENTER/MARK**, select/enter the desired setting and press **ENTER/MARK**.
4. When done, press the **QUIT** key to return to the Main Menu.

To setup Loran TD from the Status Page:

1. Press **MENU**, then use the **ARROW KEYPAD**, highlight the 'Loran TD On' and press **ENTER/MARK**.
2. To change the settings of any of the five fields, highlight the field, press **ENTER/MARK**, select/enter the desired setting and press **ENTER/MARK**.
3. When done, press the **QUIT** key to return to the Status Page.

If the active GRI Chain, secondary stations or offsets have been changed since the waypoint was created, the waypoint will now reference the active GRI-chain and secondary stations and adjust the TD coordinates accordingly. Remember that the GPS is not relying on the LORAN signal for navigation and actually converts the TD coordinate to a useful LAT/LON coordinate (in the background) before storing the waypoint to memory or using it for navigation. Because of this, the unit can navigate to a TD coordinate anywhere in the world.

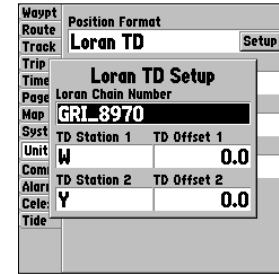

Loran TD Setup Page

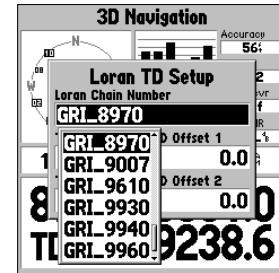

Selecting the Loran Chain Number.

Appendix B

Time Offsets



A simple way to determine your local time offset is how many hours you are behind or ahead of UTC (also called 'Greenwich' or 'zulu' time).

Example: EST (Eastern Standard Time) is 5 hours behind UTC, so your offset would be -5. Adding one hour for daylight savings would make EDT (Eastern Daylight Time) - 4. Subtract an hour for each time zone as you travel west.

Offsets for Continental U.S. would be:

EST	-5	EDT	-4
CST	-6	CDT	-5
MST	-7	MDT	-6
PST	-8	PDT	-7

The chart below gives an approximate UTC (Universal Time Coordinate) time offset for the various longitudinal zones. Check with local charts for more detailed information. If you are in daylight savings time, add one hour to the offset.

Longitudinal Zone	Offset	Longitudinal Zone	Offset
W180.0° to W172.5°	-12	E007.5° to E022.5°	+1
W172.5° to W157.5°	-11	E022.5° to E037.5°	+2
W157.5° to W142.5°	-10	E037.5° to E052.5°	+3
W142.5° to W127.5°	-9	E052.5° to E067.5°	+4
W127.5° to W112.5°	-8	E067.5° to E082.5°	+5
W112.5° to W097.5°	-7	E082.5° to E097.5°	+6
W097.5° to W082.5°	-6	E097.5° to E112.5°	+7
W082.5° to W067.5°	-5	E112.5° to E127.5°	+8
W067.5° to W052.5°	-4	E127.5° to E142.5°	+9
W052.5° to W037.5°	-3	E142.5° to E157.5°	+10
W037.5° to W022.5°	-2	E157.5° to E172.5°	+11
W022.5° to W007.5°	-1	E172.5° to E180.0°	+12
W007.5° to E007.5°	0		

The GPSMAP 162 uses an on-screen pop-up message system to alert you to unit operating characteristics. Press the **ENTER** key to acknowledge and return to the page you were viewing.

Alarm Clock— The alarm clock has sounded.

Anchor Drag Alarm— You have drifted out of the specified distance range.

Antenna Input Shorted To Ground— Check antenna wiring/connections or antenna replacement.

Approaching Waypoint— You are a specified alarm distance from a destination waypoint.

Arrival At Waypoint— You have arrived at the destination waypoint.

Basemap Failed Unit Needs Repair— Internal problem with unit. Contact your dealer or GARMIN Customer Service (pg. iv) to have the unit serviced.

Can't Unlock Maps— A valid unlock code has not been entered for locked MapSource cartography. See the MapSource owner's manual for more information on unlock codes and locked map data.

Database Error— Internal problem with unit. Contact your dealer or GARMIN Customer Service (pg. iv) to have the unit serviced.

Lost Satellite Reception— The unit has lost satellite signals. Check antenna connections or try moving to a location with a clear view of the sky.

Memory (RAM) Failed Unit Needs Repair— Internal problem with unit. Contact your dealer or GARMIN Customer Service (pg. iv) to have the unit serviced.

Memory (ROM) Failed Unit Needs Repair— Internal problem with unit. Contact your dealer or GARMIN Customer Service (pg. iv) to have the unit serviced.

No DGPS Position— No differential correction data is available or not enough data is available to compute a DGPS position.

No Tide Stations For That Area— No tide stations within 100 miles of the specified point. Try another area.

Off Course Alarm— You have exceeded the specified off-course distance.

Processor Failed Unit Needs Repair— Internal problem with unit. Contact your dealer or GARMIN Customer Service (pg. iv) to have the unit serviced.

Proximity Alarm List is Full— You have used all ten proximity waypoints.

Appendix C

Messages

Proximity Alarm Waypoint— You have entered the alarm radius for the proximity waypoint indicated.

Proximity Overlaps Another Proximity Waypoint—The alarm radius specified overlaps the area specified for another proximity waypoint. Adjust distance.

Route Already Exists: <route name>— You have entered a route name that already exists in memory. Modify route name or delete the previous route name.

Route Does Not Exist: <route name>— Route has been renamed or removed from memory and cannot be used.

Route Is Full— You have attempted to add more than 30 points to a route. Reduce number of points or create second route.

Route Memory Is Full Can't Create Route— Maximum amount of 20 routes already in unit memory and no additional routes can be added until existing ones are removed.

Route Truncated— Uploaded route from other device has more than 30 points. Reduce number of points.

Running Simulator— Unit is in simulator (practice) mode.

Track Already Exists: <track name>— You have entered a saved track name that already exists in memory. Modify track name or delete the previous track name.

Track Memory Is Full Can't Create Track— Track log memory is full. No additional track log data can be stored without deleting old data to create memory space.

Track Truncated— A complete upload track will not fit into memory. The oldest track log points were deleted to make space for the most recent data.

Transfer Complete— The unit has finished uploading/downloading information to the connected device.

Waypoint Already Exists: <waypoint name>— You have entered a waypoint name that already exists in memory. Modify waypoint name or delete the previous waypoint name.

Waypoint Memory Is Full Can't Create Waypoint— You have used all 500 waypoints available. Delete unwanted waypoints to make space for new entries.

Adindan	Adindan- Ethiopia, Mali, Senegal, Sudan
Afgooye	Afgooye- Somalia
AIN EL ABD '70	AIN EL ANBD 1970- Bahrain Island, Saudi Arabia
Anna 1 Ast '65	Anna 1 Astro 1965- Cocos I.
ARC 1950	ARC 1950- Botswana, Lesotho, Malawi, Swaziland, Zaire, Zambia, Zimbabwe
ARC 1960	Kenya, Tanzania
Ascnsn Isld '58	Ascension Island 1958- Ascension Island
Astro B4 Sorol	Sorol Atoll- Tern Island
Astro Bcn "E"	Astro Beacon "E"- Iwo Jima
Astro Dos 71/4	Astro Dos 71/4- St. Helena
Astr Stn '52	Astronomic Stn 1952- Marcus Island
Aus Geod '66	Australian Geod 1966- Australia, Tasmania Island
Aus Geod '84	Australian Geod 1984- Australia, Tasmania Island
Austria	Austria
Bellevue (IGN)	Efate and Erromango Islands
Bermuda 1957	Bermuda 1957- Bermuda Islands
Bogota Observ	Bogota Observatry- Colombia
Campo Inchspe	Campo Inchauspe- Argentina
Canton Ast '66	Canton Astro 1966- Phoenix Islands
Cape	Cape- South Africa
Cape Canavrl	Cape Canaveral- Florida, Bahama Islands
Carthage	Carthage- Tunisia
CH-1903	CH 1903- Switzerland
Chatham 1971	Chatham 1971- Chatham Island (New Zealand)

Chua Astro	Chua Astro- Paraguay
Corrego Alegr	Corrego Alegre- Brazil
Djakarta	Djakarta (Batavia)- Sumatra Island (Indonesia)
Dos 1968	Dos 1968- Gizo Island (New Georgia Islands)
Dutch	Dutch
Easter Isld 67	Easter Island 1967
European 1950	European 1950- Austria, Belgium, Denmark, Finland, France, Germany, Gibraltar, Greece, Italy, Luxembourg, Netherlands, Norway, Portugal, Spain, Sweden, Switzerland
European 1979	European 1979- Austria, Finland, Netherlands, Norway, Spain, Sweden, Switzerland
Finland Hayfrd	Finland Hayford- Finland
Gandajika Base	Gandajika Base- Republic of Maldives
GDA	Geocentric Datum of Australia
Geod Datm '49	Geodetic Datum 1949-New Zealand
Guam 1963	Guam 1963- Guam Island
Gux 1 Astro	Guadalcanal Island
Hjorsey 1955	Hjorsey 1955- Iceland
Hong Kong '63	Hong Kong 1963
Hu-Tzu-Shan	Taiwan
Indian Bngldsh	Indian- Bangladesh, India, Nepal
Indian Thailand	Indian- Thailand, Vietnam
Indonesia 74	Indonesia 1974-Indonesia
Ireland 1965	Ireland 1965- Ireland
ISTS 073 Astro	ISTS 073 ASTRO '69- Diego Garcia
Johnston Island	Johnston Island

Appendix D

Map Datums



The GPSMAP's built-in world-wide database includes coverage down to 20 n.m. (30 km). Note that the GPSMAP 162 basemap is valid to 75° north and 60° south of latitude.



The 'User' datum is based on a WGS-84-Local datum and is an advanced feature for unlisted or custom datums. Check your local library or on the world wide web for educational materials on datums and coordinate systems.

Appendix D

Map Datums

Kandawala	Kandawala- Sri Lanka
Kergueln Islnd	Kerguelen Island
Kertau 1948	West Malaysia, Singapore
L.C. 5 Astro	Cayman Brac Island
Liberia 1964	Liberia 1964- Liberia
Luzon Mindanao	Luzon- Mindanao Island
Luzon Philippine	Luzon- Philippines (excluding Mindanao Island)
Mahe 1971	Mahe 1971- Mahe Island
Marco Astro	Marco Astro- Salvage Island
Massawa	Massawa- Eritrea (Ethiopia)
Merchich	Merchich- Morocco
Midway Ast '61	Midway Astro 1961- Midway
Minna	Minna- Nigeria
NAD27 Alaska	North American 1927- Alaska
NAD27 Bahamas	North American 1927- Bahamas (excluding San Salvador Island)
NAD27 Canada	North American 1927- Canada and Newfoundland
NAD27 Canal Zn	North American 1927- Canal Zone
NAD27 Caribbn	North American 1927- Caribbean (Barbados, Caicos Islands, Cuba, Dominican Republic, Grand Cayman, Jamaica, Leeward and Turks Islands)

NAD27 Central	North American 1927-Central America (Belize, Costa Rica, El Salvador, Guatemala, Honduras, Nicaragua)
NAD27 CONUS	North American 1927- Mean Value (CONUS)
NAD27 Cuba	North American 1927- Cuba
NAD27 Grnland	North American 1927- Greenland (Hayes Peninsula)
NAD27 Mexico	North American 1927- Mexico
NAD27 San Sal	North American 1927- San Salvador Island
NAD83	North American 1983- Alaska, Canada, Central America, CONUS, Mexico
Naparima BWI	Naparima BWI- Trinidad and Tobago
Nhrwn Masirah	Nahrwn- Masirah Island (Oman)
Nhrwn Saudi A	Nahrwn- Saudi Arabia
Nhrwn United A	Nahrwn- United Arab Emirates
Obsrvtorio '66	Observatorio 1966- Corvo and Flores Islands (Azores)
Old Egyptian	Old Egyptian- Egypt
Old Hawaiian	Old Hawaiian- Mean Value
Oman	Oman- Oman
Ord Srvy GB	Old Survey Great Britain- England, Isle of Man, Scotland, Shetland Island, Wales
Pico De Las Nv	Canary Islands
Potsdam	Potsdam-Germany
Prov S Am '56	Prov South American 1956- Bolivia, Chile, Colombia, Ecuador, Guyana, Peru, Venezuela
Prov S Chln '63	South Chilean 1963- S. Chile
Ptcairn Ast '67	Pitcairn Astro 1967- Pitcairn
Puerto Rico	Puerto Rico, Virgin Islands
Qatar National	Qatar National- Qatar

Qornoq	Qornoq- South Greenland
Reunion	Reunion- Mascarene Island
Rome 1940	Rome 1940- Sardinia Island
RT 90	Sweden
Santo (Dos)	Santo (Dos)- Espirito Santo
Sao Braz	Sao Braz- Sao Miguel, Santa Maria Islands
Sapper Hill '43	Sapper Hill 1943- East Falkland Island
Schwarzeck	Schwarzeck- Namibia
SE Base	Southeast Base- Porto Santo and Madiera Islands
South Asia	South Asia- Singapore
Sth Amrcn '69	South American 1969- Argentina, Bolivia, Brazil, Chile, Colombia, Ecuador, Guyana, Paraguay, Peru, Venezuela, Trinidad/Tobago
SW Base	Southwest Base- Faial, Graciosa, Pico, Sao Jorge and Terceira Islands
Timbalai 1948	Timbalai 1948- Brunei and E. Malaysia (Sarawak and Sabah)
Tokyo	Tokyo- Japan, Korea, Okinawa
Tristan Ast '68	Tristan Astro 1968- Tristan da Cunha
User	User-defined custom datum
Viti Levu 1916	Viti Levu 1916- Viti Levu/ Fiji Islands
Wake-Eniwetok	Wake-Eniwetok- Marshall
WGS 72	World Geodetic System 72
WGS 84	World Geodetic System 84
Zanderij	Zanderij- Surinam

Navigation Terms

Average Speed— The average of all second-by-second speed readings since last reset.

Bearing (BRG)— The compass direction from your present position to a destination waypoint.

Course— The desired course between the active 'from' and 'to' waypoints.

Distance (Dist)— The 'great circle' distance from present position to a destination waypoint.

Distance to Destination— The 'great circle' distance from present position to a GOTO destination, or the final waypoint in a route.

Distance to Next— The 'great circle' distance from present position to a GOTO destination, or the next waypoint in a route.

Elevation— Height above Mean Sea Level (MSL).

ETA— Estimate Time of Arrival. The estimated time you will reach your destination waypoint, based on current speed and track.

ETA at Destination— The estimated time you will reach a GOTO destination, or the final waypoint in a route.

ETA at Next— The estimated time you will reach a GOTO destination, or the next waypoint in a route.

Fuel— The fuel required to travel from present position to the indicated route waypoint.

Leg Distance— The distance between two route waypoints.

Leg Fuel— The fuel required to travel from a route waypoint to the next waypoint (in sequence) in the route.

Leg Time— The time required to travel from a route waypoint to the next waypoint (in sequence) in the route.

Max Speed— The maximum second-by-second speed recorded since last reset.

Moving Average Speed— Average speed while the unit is moving.

Moving Trip Timer— Total time the unit has been moving.

Appendix E

Navigation Terms

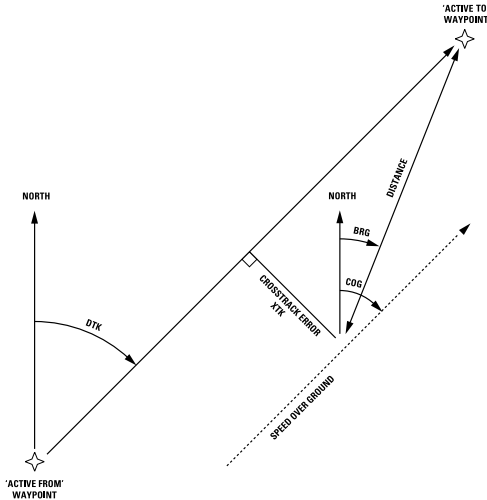

Odometer— A running tally of distance travelled, based upon the distance between second-by-second position readings.

Off Course— The distance you are off a desired course in either direction, left or right. Also referred to as ‘cross-track error’ or ‘course error’.

Speed— The current velocity at which you are travelling, relative to a ground position. Also referred to as ‘ground speed’.

Time To— The estimated time required to reach a GOTO destination, or the next waypoint in a route. Also referred to as ‘estimated time en route’.

Time to Destination— The estimated time required to reach a GOTO destination, or the final waypoint in a route.

Time to Next— The estimated time required to reach a GOTO destination, or the next waypoint in a route.

To Course— The recommended direction to steer in order to reduce course error or stay on course. Provides the most efficient heading to get back to the desired course and proceed along your route.

Track— The direction of movement relative to a ground position. Also referred to as ‘ground track’.

Trip Odometer— A running tally of distance travelled since last reset. Also see ‘Odometer’.

Total Average Speed— Average speed of unit for both moving and stopped speeds since last timer reset.

Total Trip Timer— Total time the unit has been in operation since last reset of the trip timers.

Turn— The angle difference between the bearing to your destination and your current track. ‘L’ indicates you should turn left, ‘R’ indicates you should turn right. The degrees indicate the angle you are off course.

VMG— Velocity Made Good. The speed you are closing in on a destination along a desired course. Also referred to as the ‘vector velocity’ to your destination.

Specifications

Physical Specifications

Size:	4.63" H x 6.0" W x 2.75" D (11.7cm x 15.2cm x 7cm)
Weight:	1 lb. 6 oz. (.763 kg)
Display:	4.2" diagonal (10.7cm) high-contrast, 4-level gray LCD with backlighting (240 x 240 pixels)
Case:	Fully gasketed, high-impact plastic alloy, waterproof to IEC 529-IPX-7
Temp. Range:	5°F to 158°F (-15°C to 70°C)

Performance

Receiver: Differential-ready 12 parallel channel receiver tracks all satellites in view

Acquisition Times:

Warm: Approx. 15 seconds

Cold: Approx. 45 seconds

AutoLocate: Approx. 5 minutes

Update Rate: 1/second, continuous

Accuracy:

Position*: 15 meters (49 feet) RMS; 1-5 meters (3-15 feet) RMS with optional GARMIN DGPS receiver

Velocity: 0.1 knot RMS steady state

Dynamics: 6g's

* Subject to accuracy degradation to 100m 2DRMS under the U.S. DOD-imposed Selective Availability Program.

Power

Source: 10-40V DC

Usage: 4 watts max.

Fuse: AGC/3AG - 1.5 Amp

Appendix G

Antenna Installation

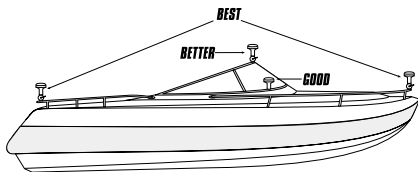

Suggested locations for mounting the GA 29 antenna.



It is possible to route the coaxial cable either through, or outside the antenna mount. The BNC connector on the coaxial cable can be removed, and the coaxial cable shortened to ease installation. If the BNC connector is removed it must be replaced with a new BNC connector.

Installing the GPSMAP 162

The GPSMAP 162 must be properly installed according to the following instructions to get the best possible performance. If you have the 162 with the built-in internal bail mount antenna (010-00192-00), you may skip this section and proceed to the next page. For units purchased with the external GA 29 antenna (010-00191-00), follow the instructions below. To complete the installation, you'll need the appropriate fasteners and a 1" x 14-thread marine antenna mount available at most marine dealers.

Mounting the GPS Antenna

The antenna should be mounted in a location that has a clear, unobstructed view of the sky in all directions to ensure the best reception. Avoid mounting the antenna where it will be shaded by the boat's superstructure, a radome antenna, or mast. Sailboat users should avoid mounting the antenna high on the mast to prevent inaccurate speed readings caused by excessive heeling. Most marine VHF and LORAN antennas should not seriously degrade the GPS antenna's reception. Never paint the antenna or clean it with harsh solvents.

The GARMIN antenna screws directly onto any standard 1" x 14-thread antenna mount. If you need to raise the antenna to avoid shading, try using a 1" x 14-thread extension mast available at most marine dealers.

To install the GPS antenna:

1. Screw the antenna directly onto the 1" x 14-thread mount.
2. Route the cable to the mounting location of the display unit. Use the appropriate tie-wraps, fasteners and sealant to secure the cable along the route and through any bulkhead or deck.
3. Once the GPSMAP 162 unit has been installed, connect the cable to the antenna connector on the back of the display unit. Make sure that you turn the antenna cable connector 1/4 turn clockwise to lock the cable into place.

Mounting the GPSMAP 162 Unit

The GPSMAP 162's compact, waterproof case is suitable for mounting in exposed locations or at the nav station. The unit comes with a gimbal bracket that can be used for surface or overhead mounting. When choosing a location for the display unit, make sure you consider the following conditions:

- There should be at least a 3" (5 cm) clearance behind the case to allow connection of the antenna (external antenna only), power/data cables.
- The mounting surface should be heavy enough to support the unit and protect it from excessive vibration and shock.
- For unit's with the built-in internal bail mount antenna (010-00192-00), it should be mounted in a location that has the clearest, most unobstructed view of the sky in all directions to ensure the best reception. Avoid mounting the unit where it will be blocked by the boat's superstructure, a radar arch, or mast.



The temperature range for the GPSMAP 162 is 5°F to 158°F (-15°C to 70°C). Extended exposure to temperatures exceeding this range (in storage or operating conditions) may cause failure of the LCD screen. This type of failure and related consequences are NOT covered by the manufacturer's limited warranty.

To install the GPSMAP 162 unit:

1. Place the mounting bracket in the desired location.
2. Mark and drill the four mounting holes for the fastener you are using.
3. Fasten the bracket to the surface using the appropriate fastener.
4. Insert the GPSMAP 162 into the mounting bracket. The bracket is designed for a tight fit to provide additional support when swiveling the unit.
5. Screw the two mounting knobs through the bracket and into the display case.
6. Connect the power/data and antenna cables (external antenna only) to the back of the unit, making sure the locking rings are fully tightened on both connectors.

Unit Installation

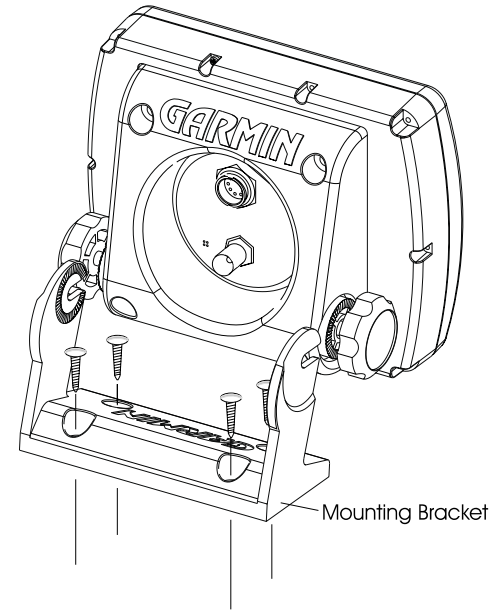

Appendix G

Wiring and Interfacing

Connecting the Power/Data

The power/data cable connects the GPSMAP 162 to a 10-40 volt DC system and provides interface capabilities for connecting external devices. The color code in the diagram below indicates the appropriate harness connections. Replacement fuse is a AGC/3AG - 1.5 Amp fuse.

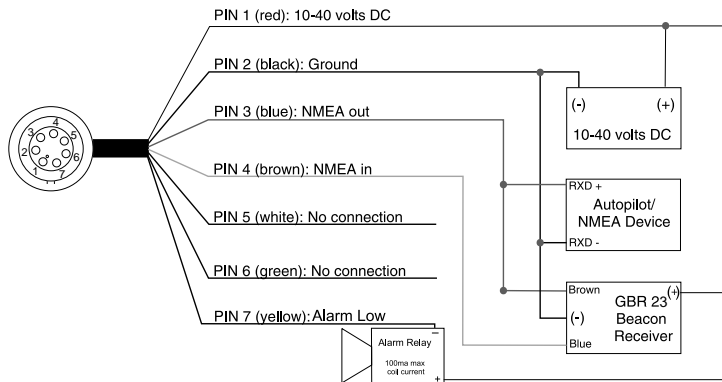

Interfacing

The following formats are supported for connection of external devices: GARMIN proprietary Differential GPS (DGPS), NMEA 0180, 0182, 0183 (versions 1.5, 2.0, 2.3), ASCII Text Output, RTCM SC-104 input (version 2.0).

The following are the sentences for NMEA 0183, version 2.3 output: Approved sentences—GPRMC, GPGGA, GPGSA, GPGSV, GPGLL, GPBOD, GPRTE, and GPWPL; Proprietary sentences—PGRME, PGRMZ, and PSLIB. The GPSMAP 162 also includes NMEA input with support for the WPL sentence and Sonar NMEA input with support for the DPT, MTW and VHW sentences.

You can download a copy of GARMIN's proprietary communication protocol the Help and Support section of our website at www.garmin.com.

Complete information concerning NMEA formats and sentences is available for purchase from NMEA at:

NMEA
PO Box 3435
New Bern, NC 28564-3435
252-638-2626
252-638-4885 FAX.

Advanced NMEA Setup

NMEA Interface

If you are going to interface the GPSMAP 162 with another piece of equipment such as a radar or autopilot the unit has to be set to output NMEA data. The NMEA data can be customized to shorten the update time from the unit. If too many NMEA sentences are activated the unit may take longer than 2 seconds to update.

Activating the NMEA Data:

1. With the GPSMAP 162 turned on, press the **MENU** key twice to display the Main Menu. Using the Arrow Keypad, select the 'COMM' tab.
2. Highlight the 'Serial Data Format' field and press **ENTER**.
3. Select 'NMEA IN/NMEA OUT' and press **ENTER**.

Advanced NMEA Output Setup

The GPSMAP 162 NMEA data transmission can be customized to keep the output rate at two seconds. If the unit is setup to output all of the available NMEA sentences, the output rate may exceed two seconds. The 'Advanced NMEA Output Setup' page will allow you to turn On/Off the GPS Status (GSA, GSV), Waypoint/Route (WPL, RTE) and the GARMIN Proprietary sentences. You can also change the precision of the Lat/Lon Minutes.

Advanced NMEA Output Setup:

1. With NMEA In/NMEA Out selected, press the **MENU** key. Select NMEA Setup and press **ENTER**.
2. To turn a field On/Off, place the highlight over that field and press **ENTER**. Make a selection and press **ENTER** again to accept the selection.

GPSMAP 162 NMEA Sentence Output (NMEA Version 2.30 compliant)

Always transmitted:

GPRMC, GPGLL, GPBOD, GPBWC, GPVTG, GPXTE, GPRMB

Switchable sentences:

GPGSA, GPGSV, GPWPL, GPRTE

Garmin Proprietary:

PGRME, PGRMZ, PGRMM

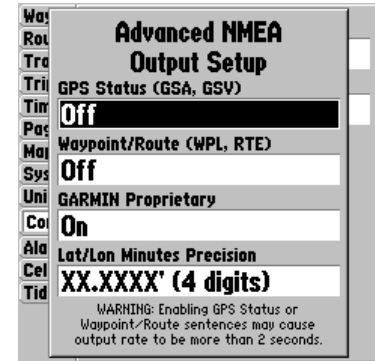

Advanced NMEA Setup Page

Appendix I

Index

A

Accessories	vi
Accuracy	19
Accuracy Circle	31
Active Route Page.....	37, 58
Active Route Page Options	58
Advanced NMEA Setup	85
Alarm Tab.....	60, 68
Anchor Drag Alarm	68
Arrival Alarm.....	68
ARROW KEYPAD.....	1, 3
AutoLocate	21

B

Backlighting	6-7
Bearing Line	31
Bearing/Distance Measuring	29
Beeper	63
Boat Speed	12, 15
By Name Waypoint List	44

C

Capabilities	v
--------------------	---

Cautions.....	iii
Celes(tial) Tab	60, 69
Changing Data Fields	16, 33-34
Clearing the Track Log	17, 48, 61
Clock Alarm	68
Color Mode	31
Comm Tab	60, 66-68
Compass Page	14, 35
Compass Page Options.....	35
Configure Highway	37
Configuring the Map	29
Contrast Setting.....	6
Cursor Movement	9, 23-27

D

Data Fields	33-34
Data Transfer	66
Date/Time.....	18, 62, 69
Datum, Map	64, 77-78
Daylight Savings Time	62
Deep Water Alarm	68
Depth.....	65
DGPS Interface Settings.....	66-68
DGPS Status	19-20, 67-68
Differential Receiver Status	20
Dilution Of Precision (DOP).....	19
Distance, Speed and Altitude.....	65

E

Editing Routes.....	55-57
Editing Waypoints.....	40-41
ENTER/MARK Key.....	3, 38
Entering Data	3

F

Fishing Hot Spots Info	25
Follow Track	48-49
Follow Route	12, 53
Fuel Flow	57
Full Screen Map	28

G

Go To Waypoint	46-47
Going to a Destination.....	11, 46-50

H

Heading	65
Highway Page.....	14-15, 36
Highway Page Configuration	37
Highway Page Options	36-37
“How To” Index.....	viii

I

IN Key.....	1
Initialization	4-5, 21
Installation	82-84
Interfacing.....	66, 84

Index

K
Keypad Usage..... 1

L
Land Mode..... 31
Language Selection..... 63
Local Time Offset 62, 74
Loran TD..... 21, 72-73
Loran TD Setup..... 73

M
Main Menu..... 16, 59-71
Map Configuration..... 29-31
Map Datums..... 64, 77-78
Map Page 8-9, 22-34
 Cursor 12, 9, 23-27
 Layout 32-33
 Options 28-34
Map Scales 27
MapSource Info Page..... 32
Measure Distance/Bearing..... 29
MENU Key..... 1
Messages 75-76
MOB 46,50
Moonrise/Moonset..... 69

N
NAV/MOB Key 1, 11-12, 46-47
Navigation Terms 79-80

Nearest Tide Station 71
Nearest Waypoint List 44
NMEA Output Formats 66, 84

O
Odometers, Trip 62
Off Course Alarm 68
OUT Key 1
Overzoom 27

P
Packing List..... vi
PAGE Key..... 1
Pages Tab 59, 62
Plan Route..... 57
Position Format..... 64
Power Off..... 17
Power On..... 4, 6
Power/Backlight/Contrast Key 1
Preface..... ii
Proximity Waypoints 44-46

Q
QUIT Key..... 1

R
Receiver Status 18-19
Re-evaluate Active Route 58
Registration ii

Restore Garmin Setup..... 63
Restoring Defaults 31-32
Reviewing Waypoints 40
Route List Page..... 53
Route Review Page 54
Routes 51
 Activating 12, 53
 Copying..... 53
 Creating..... 51-52
 Deactivating..... 53
 Deleting 53, 57
 Editing..... 55-57
 Insert/Add Turns & Points..... 55-56
 Inverting..... 57
 Moving Points..... 55
 Naming..... 54
 Planning 57
 Removing Points..... 54, 55
 Reviewing Points..... 54, 55

Appendix I

Index

S

Satellite Sky View	18
Selecting Options	2
Serial Data Format	66
Serial Number	iv
Setting Alarms	68
Setup Page Layout	32-33, 37
Shallow Water Alarm	68
Signal Strength Bars	5, 18
Simulator	7, 63
Simulator Speed	63
Software Version	63
Specifications	81
Speed, Distance and Altitude	65
Speed Filter	62
Status Page	5-8, 18-19
Status Page Options	20-21
Sunrise/Sunset	57, 58, 69
Symbols, Waypoint	10, 13, 38-43
System Tab	60, 63

T

Table of Contents	vii
Temperature	65
Tide Charts	70-71
Tide Tab	60, 70-71
Time Format	62
Time Offsets	74
Time Tab	59, 62
Time Zone	58
TracBack	48-49, 61
<i>Track Log</i>	
Clearing	17, 48, 61
Deleting	61
Saving	48, 61
Showing on Map	30, 37, 49, 61
Track Tab	60-61
Trip and Fuel Planning	57
Trip Odometers	62
Trip Tab	62
Trip Timers	62

U

Units Tab	60, 64-65
User Datum	77-78

W

WAAS	21
Warnings	iii
Warranty	iv
Water Mode	31
WaypointLists	42, 44
Waypoint Options	42-43
Waypoints	
Creating	10, 13, 26-27, 38-40
Deleting	43
Editing	40-41
Moving	41
Naming	41
Nearest	44
Proximity	44-46
Reviewing	13, 40
Symbols	10, 13, 38-43
Viewing Info	26
Welcome Page	ii
Wiring Installation	84

Z

Zooming	9, 15, 22, 27, 36
---------------	-------------------



© 2001 GARMIN Corporation

GARMIN International, Inc.
1200 East 151st Street, Olathe, Kansas 66062, U.S.A.

GARMIN (Europe) Ltd.
Unit 5, The Quadrangle, Abbey Park Industrial Estate, Romsey, SO51 9AQ, U.K.

GARMIN (Asia) Corporation
No. 68, Jangshu 2nd Road, Shijr, Taipei County, Taiwan

www.garmin.com

Part Number 190-00169-00 Rev. C