



eTrex[®] Legend C

color map navigator

owner's manual



© Copyright 2004 Garmin Ltd. or its subsidiaries

Garmin International, Inc.

1200 East 151st Street, Olathe, Kansas 66062, U.S.A.

Tel. 913/397.8200 or 800/800.1020

Fax 913/397.8282

Garmin (Europe) Ltd.

Unit 5, The Quadrangle, Abbey Park Industrial Estate, Romsey, SO51 9DL, U.K.

Tel. 44/0870.8501241

Fax 44/0870.8501251

Garmin Corporation

No. 68, Jangshu 2nd Road, Shijr, Taipei County, Taiwan

Tel. 886/2.2642.9199

Fax 886/2.2642.9099

All rights reserved. Except as expressly provided herein, no part of this manual may be reproduced, copied, transmitted, disseminated, downloaded or stored in any storage medium, for any purpose without the express prior written consent of Garmin. Garmin hereby grants permission to download a single copy of this manual onto a hard drive or other electronic storage medium to be viewed and to print one copy of this manual or of any revision hereto, provided that such electronic or printed copy of this manual must contain the complete text of this copyright notice and provided further that any unauthorized commercial distribution of this manual or any revision hereto is strictly prohibited.

Information in this document is subject to change without notice. Garmin reserves the right to change or improve its products and to make changes in the content without obligation to notify any person or organization of such changes or improvements. Visit the Garmin web site (www.garmin.com) for current updates and supplemental information concerning the use and operation of this and other Garmin products.

Garmin[®], MapSource[®], BlueChart[®], TracBack[®] and eTrex[®] are registered trademarks of Garmin Ltd. or its subsidiaries and may not be used without the express permission of Garmin.

eTrex Legend C

Introduction

Preface

Thank you for choosing the Garmin eTrex Legend C handheld navigation system. This Owner's Manual and Reference Guide is comprised of the following sections:

Introduction — contains the Garmin software license agreement, FCC and safety information, the Table of Contents and an overview of the eTrex Legend C functional features.

Getting Started — takes you through installing batteries, using the unit control buttons, initialization of the GPS receiver, etc.

GPS Navigation — takes you through the process of navigating with your eTrex Legend C and how to use GPS Navigation to customize the operation of your eTrex Legend C.

GPS Features — provides detailed descriptions of additional GPS enhanced features such as the Calendar, Hunt and Fish, Sun and Moon and Games, Also included in this section are a few non-GPS features such as the Calculator, a non-GPS enhanced game, etc.

Appendix — provides you with additional information about your eTrex Legend C and an index by subject.

Preface

Contact Garmin

If you should encounter any difficulty while using your eTrex Legend C, or if you have any questions, in the U.S.A. contact Garmin Product Support by phone at 913-397-8200 or 800-800-1020,

Monday – Friday, 8 am – 5 pm Central Time; or by e-mail at www.garmin.com/contactUs/techSupport.jsp.

In Europe, contact Garmin (Europe) Ltd. at Tel. 44/0870.8501241 - Fax. 44/0870.8501251.

Recording Your Serial Number

Use this area to record the serial number in case it is lost, stolen, or needs service. Be sure to keep your original sales receipt in a safe place or attach a photocopy inside the manual. The 8-digit number is located in the battery compartment.

Serial Number:

--	--	--	--	--	--	--	--

Product Registration

Connect to our website (www.garmin.com) and look for the Product Registration link on the Home Page and follow instructions for registration.

NOTE: *If you have previously registered a Garmin product purchase, we invite you to re-register using our on-line system. Many services provided by our product registration system are automated and re-registering your purchase ensures you the best possible support from Garmin.*

Software License Agreement

Software License Agreement

BY USING THE eTrex Legend C, YOU AGREE TO BE BOUND BY THE TERMS AND CONDITIONS OF THE FOLLOWING SOFTWARE LICENSE AGREEMENT. PLEASE READ THIS AGREEMENT CAREFULLY.

Garmin grants you a limited license to use the software embedded in this device (the “Software”) in binary executable form in the normal operation of the product. Title, ownership rights and intellectual property rights in and to the Software remain in Garmin.

You acknowledge that the Software is the property of Garmin and is protected under the United States of America copyright laws and international copyright treaties. You further acknowledge that the structure, organization and code of the Software are valuable trade secrets of Garmin and that the Software in source code form remains a valuable trade secret of Garmin. You agree not to decompile, disassemble, modify, reverse assemble, reverse engineer or reduce to human readable form the Software or any part thereof or create any derivative works based on the Software. You agree not to export or re-export the Software to any country in violation of the export control laws of the United States of America.

FCC Compliance Information



The eTrex Legend C complies with Part 15 of the FCC interference limits for Class B digital devices FOR HOME OR OFFICE USE. These limits are designed to provide more reasonable protection against harmful interference in a residential installation, and are more stringent than “outdoor” requirements.

Operation of this device is subject to the following conditions: (1) This device may not cause harmful interference, and (2) this device must accept any interference received, including interference that may cause undesired operation.

This equipment generates, uses and can radiate radio frequency energy and, if not installed and used in accordance with the instructions, may cause harmful interference to radio communications. However, there is no guarantee that interference will not occur in a particular installation. If this equipment does cause harmful interference to radio or television reception, which can be determined by turning the equipment off and on, the user is encouraged to try to correct the interference by one of the following measures:

- Reorient or relocate the receiving antenna.
- Increase the separation between the equipment and the receiver.
- Connect the equipment into an outlet on a circuit different from that to which the receiver is connected.
- Consult the dealer or an experienced radio/TV technician for help.

The eTrex Legend C does not contain any user-serviceable parts. Repairs should only be made by an authorized Garmin service center. Unauthorized repairs or modifications could result in permanent damage to the equipment, and void your warranty and your authority to operate this device under Part 15 regulations.

Warnings and Precautions

CAUTION: Use the eTrex Legend C at your own risk. To reduce the risk of unsafe operation, carefully review and understand all aspects of this Owner's Manual — and thoroughly practice operation using the Demo Mode prior to actual use. When in actual use, carefully compare indications from the eTrex Legend C to all available navigation sources, including the information from other NAVAIDS, visual sightings, charts, etc. For safety, always resolve any discrepancies before continuing navigation.

CAUTION: IT IS THE USER'S RESPONSIBILITY TO USE THIS PRODUCT PRUDENTLY. THIS PRODUCT IS INTENDED TO BE USED ONLY AS A NAVIGATIONAL AID AND MUST NOT BE USED FOR ANY PURPOSE REQUIRING PRECISE MEASUREMENT OF DIRECTION, DISTANCE, LOCATION OR TOPOGRAPHY. THIS PRODUCT SHOULD NOT BE USED AS AN AID TO DETERMINE GROUND PROXIMITY FOR AIRCRAFT NAVIGATION.

CAUTION: The electronic chart is an aid to navigation and is designed to facilitate the use of authorized government charts, not replace them. Only official government charts and notices to mariners contain all information needed for safe navigation – and, as always, the user is responsible for their prudent use.

Warnings and Precautions

MAP DATA INFORMATION: One of the goals of Garmin is to provide customers with the most complete and accurate cartography that is available to us at a reasonable cost. We use a combination of governmental and private data sources, which we identify as required in product literature and copyright messages displayed to the consumer. Virtually all data sources contain inaccurate or incomplete data to some degree. This is particularly true outside the United States, where complete and accurate digital data is either not available or prohibitively expensive.

WARNING: The Global Positioning System (GPS) is operated by the United States government, which is solely responsible for its accuracy and maintenance. The system is subject to changes which could affect the accuracy and performance of all GPS equipment. Although the Garmin eTrex Legend C is a precision electronic NAVigation AID (NAVAID), any NAVAID can be misused or misinterpreted and, therefore, become unsafe.

WARNING: This product, its packaging, and its components contain chemicals known to the State of California to cause cancer, birth defects, or reproductive harm. This Notice is being provided in accordance with California's Proposition 65. If you have any questions or would like additional information, please refer to our web site at <http://www.garmin.com/prop65>.

eTrex Legend C Introduction

Warnings and Precautions

Important

Because the Garmin eTrex Legend C can be used for vehicular navigation, important safety considerations must be observed. Please read and observe the instructions on this page.

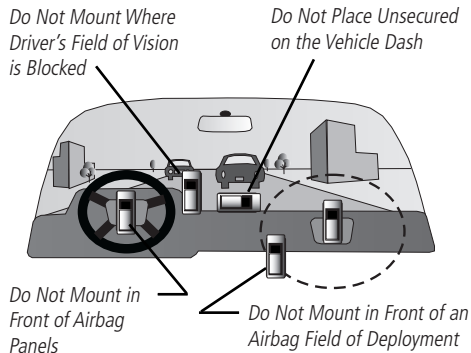

Safety Warnings and Cautions—Read This First!

WARNING: For use in vehicles, it is the sole responsibility of the owner/operator of a vehicle with the eTrex Legend C installed to place and secure the device so that it will not interfere with the vehicle operating controls and safety devices, obstruct the driver's view of driving conditions, or cause damage or personal injury in the event of an accident.

Do not mount the unit over airbag panels or in the field of airbag deployment. Airbags expand with a rapid force that can propel objects in their path towards the vehicle driver or passengers causing possible injury. Refer to airbag safety precautions contained in the vehicle owner's manual.

Do not mount the unit in a place where the driver or passengers are likely to impact it in a collision. The mounting hardware provided by Garmin is not warranted against collision damage or the consequences thereof.

WARNING: When used in vehicles, it is the sole responsibility of the driver of the vehicle to operate the vehicle in a safe manner, maintain full surveillance of all driving conditions at all times, and not become distracted by the unit to the exclusion of safe driving practices. It is unsafe to operate the controls of the unit while you are driving. Failure by the driver of a vehicle equipped with a eTrex Legend C installed to pay full attention to operation of the vehicle and road conditions while the vehicle is in motion could result in an accident with property damage and personal injury.

Table of Contents

Section 1: Introduction.....	i-viii	Section 3: GPS Navigation.....	8-55
Preface.....	i	The Map Page.....	8
Software License Agreement.....	ii	The Compass Page.....	14
FCC Compliance Information.....	iii	Using Waypoints.....	16
Warnings and Precautions.....	iv-vi	Using Find.....	20
Table of Contents.....	vii-viii	The Main Menu.....	32
Section 2: Getting Started.....	1-7	The Trip Computer Page.....	33
Battery Installation and Start Up.....	1	Using Tracks.....	34
Key Functions.....	2	Using Routes.....	39
Unit Features.....	3	The Highway Page.....	44
Initialization.....	4	The Setup Menu.....	45
The Satellite Page.....	4	System Setup.....	46
Navigating with the eTrex Legend C.....	5	Display Setup.....	46
The Main Page Sequence.....	6	Tones Setup.....	47
The Main Page Features.....	7	Page Sequence Setup.....	47
		Map Setup.....	48
		Routing Setup.....	51
		Geocache Setup.....	52
		Marine Setup.....	52
		Time Setup.....	53
		Units Setup.....	53
		Heading Setup.....	54
		Welcome Page Setup.....	54
		Proximity Waypoints.....	55

Table of Contents

Section 4: GPS Features.....	56-64
Calendar.....	56
Alarm Clock.....	57
Calculator.....	57
Stopwatch.....	58
Sun and Moon Tables.....	59
Hunt and Fish Tables.....	60
GPS Enhanced Games.....	61
Non-Enhanced Game.....	64
Section 5: Appendix.....	65-80
Accessories.....	65
Specifications.....	67
Data Field Definitions.....	69
Connecting the eTrex Legend C to a Computer.....	73
Downloading MapSource Map Data.....	74
UTC Offset Chart.....	75
Map Datums and Position Formats.....	76
Loran TD Setup.....	77
WAAS	78
Index.....	79
Limited Warranty.....	81

Battery Installation and Start Up

Installing the Batteries

The eTrex Legend C operates on two “AA” batteries (not included), which are located in the back of the unit. Alkaline or NiMH batteries may be used (see page 46 for setting the battery type). Stored data is not lost when batteries are removed.

To install batteries:

1. Remove the battery cover from the back of the unit by turning the D-Ring 1/4 turn counter-clockwise and pulling out.
2. Insert the batteries, observing the proper polarity. A polarity diagram can be found molded into the battery compartment.
3. Reinstall the battery cover by inserting the bottom slot over the tab at the base of the unit and reinserting the locking pin in the back of the unit. Turn the D-Ring 1/4 turn clockwise to lock in place.

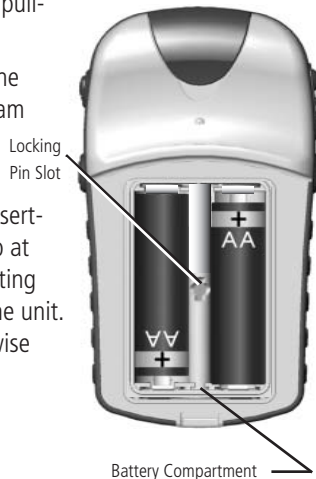

Important Note

When replacing batteries, use only new or fully charged batteries. Do not mix Alkaline and NiMH batteries. Rechargeable batteries may typically display less capacity than disposable batteries.

Remove the batteries from the unit if you don't plan to use it for several months. Storing batteries in the unit for prolonged periods of time may result in leakage and damage to the battery compartment.

Follow the manufacturer's instructions for proper care and disposal of used batteries. Do not incinerate used batteries, as internal materials may ignite with explosive violence.

Extensive use of backlighting and/or WAAS as well as key beep tones will significantly reduce battery life.

To set backlighting intensity and timeout, see page 46.

To disable WAAS, see page 46.

To mute the beep tones, see page 47.

eTrex Legend C Getting Started

Key Functions

GPS Antenna

- Provides quick satellite acquisition.



IN/OUT Zoom Keys

- From the Map Page, press to zoom in or out.
- From any other page, press to scroll up or down a list or move a high-lighted slider.



MENU/FIND Key



- Press and release to view the Options Menu for a page.
- Press and hold to display the Find Menu.



“Thumb Stick” ENTER/ROCKER Key

(Press down to Enter - move to the side or up/down to scroll, cursor or increase/decrease)

- Rock Up/Down or Right/Left to move through lists, highlight fields, on-screen buttons and icons, enter data or move the map panning arrow.
- Press in and release to enter highlighted options and data or confirm on-screen messages.
- Press in and hold at any time to mark your current location as a waypoint.



QUIT Key

- Press to cycle through the main pages.
- Press when using the on-screen keyboard to cancel.



POWER/LIGHT Key

- Press and hold to turn unit On/Off.
- Press and release to adjust back-lighting, and to view date/time and battery capacity.

Unit Features

USB Connector Port (under weather cover)

- Provides interface to a PC for faster data transfer.
- Provides auxiliary power via USB cable connection to a PC or from a cigarette lighter adapter cable with USB connector.

Battery Compartment Locking Ring

- Turn 1/4 turn counter-clockwise and lift to remove cover.

Battery Compartment Cover

IMPORTANT NOTE: Before connecting the unit to the USB Cable, install the USB Cable drivers included with the MapSource Trip and Waypoint Manager CD-ROM provided with this unit. Otherwise, your PC may attempt to auto-install USB drivers incompatible with the unit. Refer to page 73 for detailed instructions.

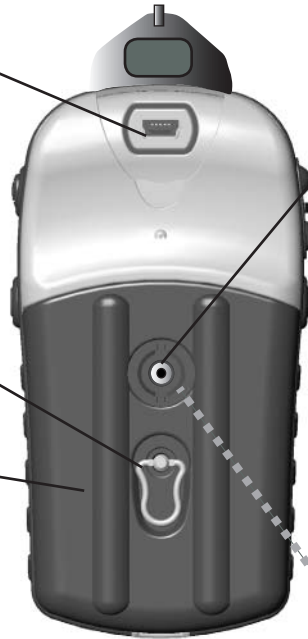

Belt Clip/Auxiliary Mount Adapter Attachment Location

- Accepts a Belt Clip accessory for convenient access when hiking or walking.
- Accepts the Auxiliary Mount Adapter accessory supplied with the unit.

(Refer to pages 65 and 66 for accessory listings and installation instructions.)



Auxiliary Mount Adapter
(Do not discard - retain for use with Garmin Auto, Bike and Marine Mount Accessories)

eTrex Legend C Getting Started

Initialization & the Satellite Page



The eTrex Legend C locates satellites above its position

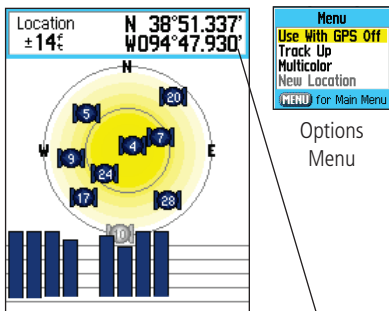

Satellite Page displaying a location "Fix"

Starting Up the GPS Receiver

When you turn on the eTrex Legend C, the GPS receiver begins to search for satellites in order to determine (fix) its location. This process is called "initialization" and can take from 5 to 15 minutes the first time you use your unit. Thereafter, if you haven't moved more than 600 miles from your original location, it takes only seconds to minutes. In order to receive satellite signals, you must be outdoors and have a clear view of the sky. Satellite signals cannot pass through solid materials (except glass) or dense overhead tree cover. To shorten the time required for initialization, select "New Location" from the options menu, then use the Map Page to determine your general location so the eTrex Legend C can search for those satellites above you.

To initialize your eTrex Legend C:

1. Press and release the **POWER** key to turn on the unit.
2. Observe the "Power On" Page followed by the Satellite Page. The Satellite Page displays at Start-Up only; thereafter, it can be accessed through the Main Menu.
3. While the GPS receiver is searching for signals, a "Locating Satellites" message appears followed by an "Acquiring Satellites" message until enough signals are acquired to fix its location.

You can also see a sky view array of the satellites overhead with your position centered in the array. The outer circle represents the horizon and the inner circle a position 45° from the horizon. The numbers displayed indicate the number assigned to each satellite. A bar graph displays the strength of signals from each satellite.

eTrex Legend C Getting Started

4. When the receiver has signals from at least three satellites, the display at the top of the page changes to indicate position accuracy and location coordinates. The Status Bar at the top of the display indicates the GPS status and status of other features.

If, for any reason, you have difficulty initializing your eTrex Legend C, the solution could be as simple as moving slightly to avoid objects that are blocking or deflecting the satellite signals.

5. Press and release the **QUIT** key until the Map Page is displayed. You are now ready to begin GPS-aided navigation.

Active Navigation is supported by three of the Main Pages:

The **Map Page** graphically shows your current location, marks your route to a destination with a route line, and leaves a trail (track log) of where you've been.

The **Compass Page** indicates direction to go and direction of travel.

The **Trip Computer Page** records and displays travel data.

There are three methods of navigating to a destination when using the eTrex Legend C, each graphically displayed on the **Map Page**.

Go To - A direct path to a selected destination (waypoint, city, address, etc.).

Track - A previous path of travel that has been stored (logged) in the eTrex Legend C. A Track allows you to repeat a path or retrace the path.

Route - A path to a destination consisting of intermediate stops along the way (waypoints, cities, exits, points of interest, intersections, etc.).

Refer to the sections on Tracks, Routes and Waypoints for details.

Initialization & The Satellite Page

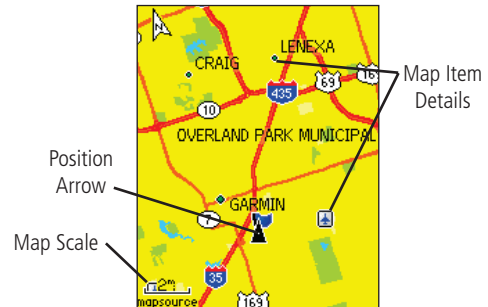

Map Page with Current Position Arrow

Navigating with eTrex Legend C

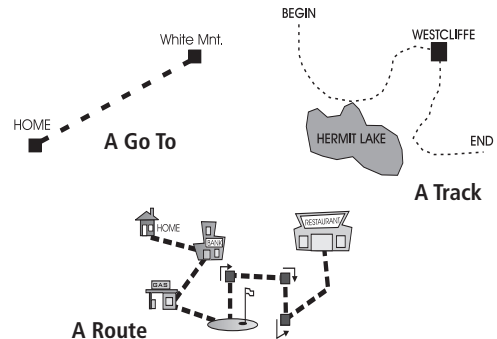

eTrex Legend C Getting Started

The Main Page Sequence

When you turn on the eTrex Legend C, you can see the Power On Page, followed by the Satellite Page (which displays only at start up), and then the Map Page. The Map Page is the first of the three Main Pages in sequence.

To view each Main Page:

1. Press and release the **QUIT** key repeatedly to cycle through the pages.
2. With a page displayed, press the **MENU** key to display the list of options for that page.



"Power On" Page

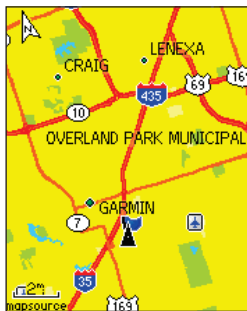

Map Page

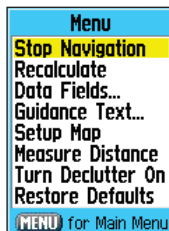

Map Page Options



Compass Page

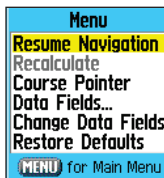

Compass Page Options

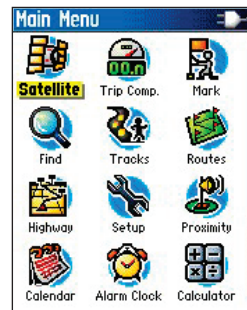

Main Menu



There are no Main Menu Options at the Main Page level

Note: When navigating to a destination, the Active Route Page is added to the Main Page Sequence.

Status Bar, Backlighting and On-Screen Messages

When you press and release the **POWER** key, the Backlight Brightness Adjustment Slider and a Status Bar with time and date displays current status information for several unit features.

- Power to the unit is provided either by the batteries or from an auxiliary source (DC Adapter). The Battery Power icon displays the remaining power as the battery becomes depleted.
- Satellite signal status is shown when searching for (acquiring) satellites, when a two-dimensional fix is attained, and when four or more satellites have been received (three dimensional fix).
- The Alarm Clock icon displays whenever the Alarm is set.
- The USB cable connection icon displays when the unit is in communication with a PC Universal Serial Bus.

You can adjust the backlight level by pressing the **POWER** key and releasing it. Then tap the **POWER** key or **ROCKER** key Up or Down to cycle through the levels of backlight adjustment. See page 46 for information on changing the display colors and backlight timeout and brightness levels. Backlighting is Off when you power up the unit. When On, it uses a significant amount of battery power.

Whenever a significant event in the operation of the unit occurs, an on-screen message appears to advise you of the occurrence. In each case, the condition is described and often a remedy provided. Press the **ENTER** key to acknowledge the message and close the window.

The Main Page Features

Status Bar



Battery Power



Acquiring Satel-



Alarm is Set



USB is Connected



Auxiliary Power



2-Dimension Navigation



3-Dimension Navigation



Backlight Adjustment
Slider
(Brightness varies
according to battery
power level.)

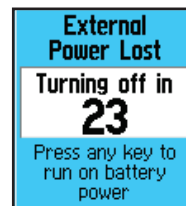

On-Screen Messages

eTrex Legend C GPS Navigation

The Map Page

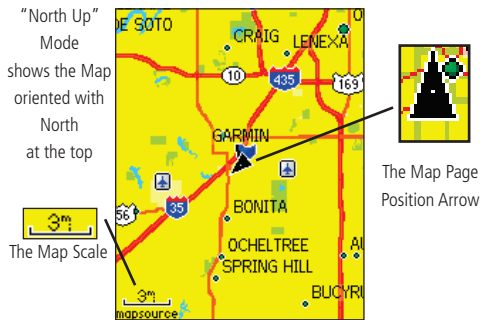

Using the Map Page

The Map Page is the primary navigation feature of the eTrex Legend C. The Map Page displays a detailed map of the area surrounding your current location. It allows you to pan the map with the **ROCKER** key and view your progress when navigating. When in the "Track Up" mode (oriented in the direction of travel), a north reference arrow appears at the top left corner to orient the map. When in the "North Up" mode the map is oriented like a paper map. When you activate the Track Log feature, your path of movement is indicated by a dotted line. The map display can be changed to "Night" mode for easier viewing in dim light. The factory set default automatically changes the display at sunrise and sunset.

The map also displays geographic details such as rivers, lakes, highways and towns. The maps to the left show a higher level of detail than the basemap provided with the unit (i.e. residential streets, parks, etc.) because Garmin MapSource® detailed mapping data has been downloaded from a CD-ROM program.

You can use the Map Page to do the following:

- Determine your current location and progress while moving.
- Select and save a map point as a waypoint.
- Locate and navigate to map items by following a Route displayed on the map.
- Customize the map display to your requirements.

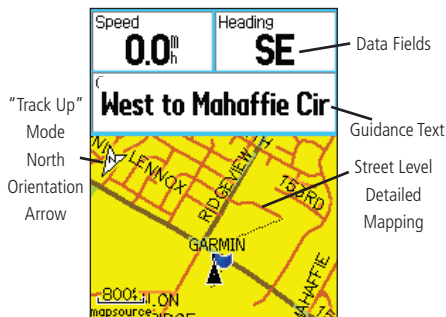

The Map Page with Data Fields and Guidance Text

Using Map Page Features

Use the Zoom **IN** and **OUT** buttons to change the map scale. You can show more map area with less detail or less map area with more detail. Press and hold to Zoom the map scale rapidly.

The map scale in the lower left hand side of the display is shown in units of measurement selected in the “Units” field of the Unit Setup Page. If you zoom in so far that the resolution of the map data is exceeded and the appearance of the map is no longer accurate, the word, “overzoom” displays just below the map scale. When using MapSource detailed maps, “mapsource” appears below the scale.

In many instances the map displays an “Accuracy Circle” surrounding the “Position Icon.” The eTrex Legend C uses both map resolution and GPS accuracy in defining your location to a point within the circle. The smaller the circle, the more accurate your location.

When using the “Pan Map” feature, a small outline arrow (Panning Arrow) can be moved about the page to highlight and identify map items or to scroll the map to view areas not shown on the display screen. If there is more than one map item under the Panning Arrow. A list of those items displays with the item highlighted on the map and on the list.

Optional data fields can be added at the top of the display to provide a variety of travel and navigational information, see pages that follow.

When navigating, Guidance Text is displayed at the top of the map.

The Map Page

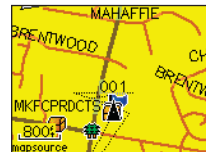

Zoom In



Zoom Out

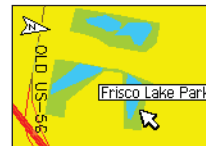

Map Features

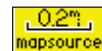

Map Scales



Accuracy Circle



Panning Arrow

South to US 169

Guidance Text

The Map Page

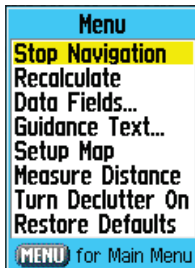

The Map Page Options Menu

A Quick Look at the Map Page Options

Stop Navigation - Stops navigation and is disabled when there is no active navigation.

Recalculate - Recalculates a route and is disabled when there is no active navigation.

Data Fields - Allows two to four fields to display at the top of the page showing Speed, Heading, Elevation and Time.

Guidance Text - Displays messages on the screen to advise you of your next navigation move when navigating to a destination.

Change Data Fields - Allows you change data field types.

Setup Map - Access to six pages of Map display settings so you can customize the map to your preferences.

Measure Distance - Measures the distance from your current location to the Map Pointer.

Turn Declutter On - Eliminates the display of items on the map that can block out road details when the map is zoomed out.

Restore Defaults - Returns the map display to the factory set map display defaults.

The Map Page Options Menu

The Map Page can be changed to display a variety of information for navigation. You can stop navigation to a destination and arrange up to four data fields to display the type of navigation information you desire. Include a navigation guidance text message on the map page. You can select the type of data fields to display and change the way the map displays items by selecting your own settings for text size, what items are displayed and more. You can display the distance from your current location to other locations on the map and reduce the amount of map clutter (map item icons and names) to increase the visibility of roads and other geographic features. You can restore the Map Page display to the factory default settings.

To arrange the Map Page:

1. With unit turned On, press and release the **QUIT** key until the Map Page displays.
2. Press the **MENU** key to display the Map Page Options Menu.
3. Use the **ROCKER** key to select the feature you want to use to customize the Map Page and press the **ENTER** key.

Some of these options contain sub-menus that allow you to further control how the option is used.

The pages that follow discuss each option in detail.

To display Data Fields:

1. With the Map Page Options Menu displayed, use the **ROCKER** key to highlight the Data Fields option and press **ENTER**.
2. Observe the sub-menu options: "Map Only," "2 Data Fields," "3 Data Fields" and "4 Data Fields."
You can choose to leave the Map Page as is (full page map), or add two, three or four navigation data fields.
3. Highlight your choice and press **ENTER**.

To change Data Fields:

1. After you display the data fields, a "Change Data Fields" option appears on the options menu when you press the **MENU** key.
2. Select this option and press **ENTER**.
3. Press **ENTER** again to select from a list of types of navigation data to display in the first data field.
4. After making your selection and entry, use the **ROCKER** key to move to the next field and repeat the process.

For an explanation of what each option represents, see page 69 of the Appendix.

The Map Page

The image displays four screenshots of the eTrex Legend C GPS navigation interface, illustrating different data field configurations. Each screenshot shows a map of a street grid with a blue arrow indicating the current location and heading. The data fields are displayed in a grid format at the top of the screen.

- Two Data Fields:** The top-left screenshot shows two data fields: Trip Odom (0.84 mi) and Heading (SE).
- Three Data Fields:** The top-right screenshot shows three data fields: Trip Odom (0.84 mi), Heading (SE), and Location (N 38°51.338', W 094°47.930').
- Four Data Fields:** The bottom-left screenshot shows four data fields: Trip Odom (0.84 mi), Heading (SE), Elevation (1097'), and Time of Day (04:02).

To the right of the screenshots is a list of available data field options, titled "List of Data Field Options". The options are:

- Accuracy of GPS
- Bearing
- Course
- Distance To Destination
- Distance To Next
- ETA At Destination
- ETA At Next
- Elevation
- Glide Ratio
- Glide Ratio To Dest
- Heading
- Odometer
- Off Course
- Painter
- Speed
- Speed - Maximum
- Speed - Moving Avg.
- Speed - Overall Avg.
- Sunrise
- Sunset
- Time To Destination
- Time To Next
- Time of Day
- To Course
- Trip Odometer
- Trip Time - Moving
- Trip Time - Stopped
- Trip Time - Total
- Turn
- Velocity Made Good
- Vertical Speed
- Vertical Speed To Dest
- Waypoint At Dest
- Waypoint At Next

The Map Page

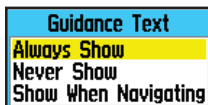

Guidance Text Options Menu

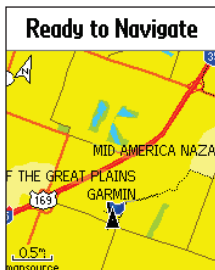

GPS Status Message when not navigating

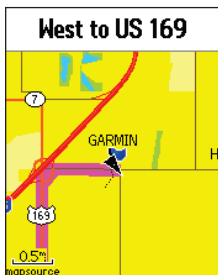

Guidance Message when navigating

To display Guidance Text:

1. With Map Page displayed, press the **MENU** key to display the Map Page Options Menu.
2. Highlight the Guidance Text Option and press **ENTER** to display the Guidance Text Options Menu.
3. Select the desired option “Always Show,” “Never Show” or “Show When Navigating” then press **ENTER** to activate.

If you select “Always Show,” a guidance message is always displayed whether or not you are navigating.

If you select “Show When Navigating,” a guidance message is displayed until you select “Stop Navigation” from the Options Menu.

Guidance Text shows you useful information when using one of the navigation methods described on page 5. If you select “Always Show” and you are not navigating, the message field displays GPS Status information.

To set up the Map:

Refer to the “Map Setup” section on page 48.

Measuring Distance

This Map Page option allows you to determine the distance to a point on the map from your current location. Access the Map Page Options Menu, select "Measure Distance" and press **ENTER** to activate. To measure between two selected points on the Map, move the Map Pointer to the first map point you want to measure from, press **ENTER** and then move the Map Pointer to the second map point. Press **QUIT** to cancel.

Turning Declutter On/Off

This Map Page option allows you to remove map item titles and icons that clutter the view of roadways, especially when the map is zoomed in.

To turn Declutter On, access the Map Page Options Menu, select "Declutter On" and press **ENTER** to activate. Do the same to cancel the "Declutter" option.

Restoring Default Settings

This option allows you to return the map settings to factory settings.

The Map Page

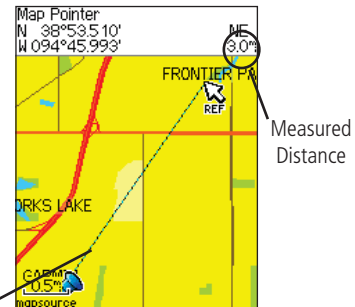

The "Measure Distance" Option Enabled

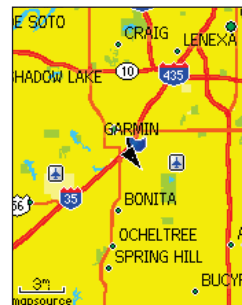

Map Declutter "Off"

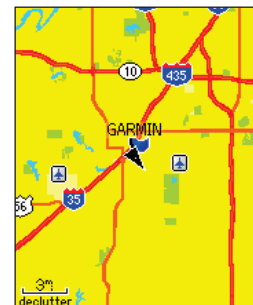

Map Declutter "On"

The Compass Page

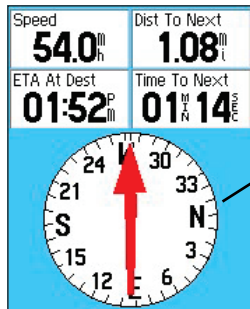

Compass Page

The Compass Ring moves to indicate North orientation when you are moving.



Course Pointer

Scale
The Course Pointer indicates your course of travel and the distance you drift off course.



Bearing Pointer

The Bearing Pointer always indicates the direction to your destination.

Using the Compass Page

The Compass Page is your guide to accurate and efficient navigation. It uses traditional navigation displays to provide navigation information.

When navigation is in progress, the Compass Page provides navigation data and directions. It uses a graphic compass display, a bearing pointer and digital data fields to display information such as current speed, distance to the next point on the route, estimated arrival time, etc. You can choose from three or four data fields and select the type of data displayed in each from a list of options.

When moving, the rotating graphic compass indicates the direction you are heading. The Bearing Pointer indicates the direction (bearing) to your destination relative to your current heading direction. The compass dial and Bearing Pointer work independently to show your direction of movement and the direction to your destination. You can choose between a Bearing Pointer or a Course Pointer for guidance.

The compass does not function as a magnetic compass when you are stationary. However when you move, the dial rotates to keep you oriented in relation to North. This is especially helpful when using a paper map in conjunction with your unit for navigation.

To use the Compass Page Options:

1. Press the **MENU** key to display the Options Menu.
2. The first option is "Stop Navigation" which can be highlighted and activated by pressing **ENTER** to stop navigating.
3. The second option is "Course Pointer" or "Bearing Pointer."

The Bearing Pointer and Course Pointer work independently of each other, one indicating the direction to your destination and the other indicating your relationship to a course line leading to the destination.

If the Bearing Pointer arrow is pointing straight up, you are going directly to your destination. If it points in any other direction, turn towards that direction until the arrow is pointing up and then continue in that direction. The Bearing Pointer always points to the destination, no matter what direction you are moving and is most efficient if you must move around obstacles like lakes, private property, etc.

If you are using the "Course Pointer" option instead and you drift away from the line of travel from your original location to your destination. The Course Deviation Indicator (arrow with horizontal dotted line) provides graphic indication of drift (right or left) according to the scale displayed at the edge of the compass ring.

4. The third option is "Data Fields." Highlight the data fields option and press **ENTER** to display the data field display options.
5. The next option is "Change Data Fields" which allows you to determine what data is displayed in the fields. Refer to page 11 for details on changing data fields.

The Compass Page

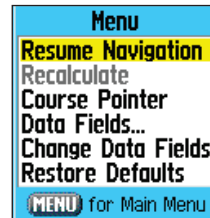

Compass Page Options Menu

Course Deviation Scale



Bearing Pointer

The direction to your destination from your current location



Course Pointer

Course Deviation Indicator (CDI)

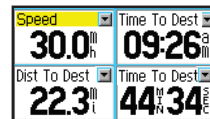

Change Data Fields Option

Using Waypoints



Press and hold the ENTER/ROCKER key to display the Mark Waypoint

Mark Waypoint		
002		
Note	15-APR-04 9:39:48AM	
Location	N 38°51.337' W 094°47.930'	
Elevation	1118'	
From Current Location	W 4'	
Avg	Map	OK

Mark Waypoint Page



Symbols Chart

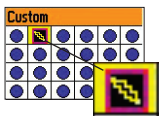

Custom Symbol

Mark Waypoint		
002		
ABC	Clear 123	
DEFGH	Space 456	
IJKLM	OK 789	
NOPQR	↑ ↓ 0 - +	
STUVWXYZ	& # . , ' " : ;	
Elevation	1118'	
From Current Location	W 4'	
Avg	Map	OK

Naming a Waypoint

The Mark Waypoint Page

The Mark Waypoint Page allows you to mark and record your current (or any other) location as a waypoint and displays name for that waypoint and a waypoint symbol. You can mark your current location at any time.

To mark your current location as a waypoint:

1. Press in and hold the **ENTER** key to view the Mark Waypoint Page.
2. To change the name of the waypoint, use the **ROCKER** key to highlight the waypoint name field and press **ENTER** to display the on-screen keypad. Use the **ROCKER** key and **ENTER** key to select a name for the waypoint. If you choose a name that has already been used, a "Waypoint Already Exists" message appears.
3. To assign an identifying symbol to a waypoint, use the **ROCKER** key to highlight the symbol block next to the waypoint name and press **ENTER** to display the Symbols Chart.
4. To save the waypoint to the Find Menu Waypoints List, highlight "OK" and press **ENTER**.
5. If you do not want to save it as a new waypoint, press the **QUIT** button to cancel.

Custom Waypoint Symbols

At the bottom of the Waypoint Symbols Chart is a group of custom waypoint symbols that can be assigned a unique design. Access the Garmin website <http://www.garmin.com/ximage> to download the xImage transfer program. From there, the xImage help files provide instructions for customizing waypoints and downloading screen shots from your unit.

To create a waypoint using the Map Panning Arrow:

1. With the Map Page displayed, move the panning arrow (map pointer) to the map item you want use as a waypoint. If there is information in the mapping database for that location it highlights momentarily and display a name or address.
2. Press **ENTER** to display the item information page. With the Waypoint Information Page displayed, highlight the "Save" button at the bottom of the page and then press **ENTER** to save it to the Find Menu Waypoints List.

If the map selected does not contain any information, a message appears, stating "No map information at this point. Do you want to create a user waypoint here?". Select "Yes" and press **ENTER** to display a new waypoint page.

Averaging a Waypoint Location

A waypoint location can be averaged over time for more accuracy, but only while the GPS has a fix on the location and before saving it.

To average a Waypoint Location using measurements over time:

1. With the "New Waypoint" information page displayed, highlight the on-screen "Avg" button and press **ENTER** to average.
3. Select "Average Location" and press **ENTER** to display the Average location Page. It begins to average automatically.
4. Highlight the "Save" button and press **ENTER** when desired.

Using Waypoints

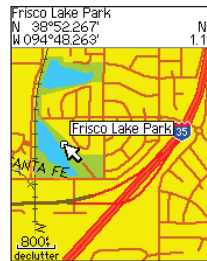

Map Item selected as a
Waypoint

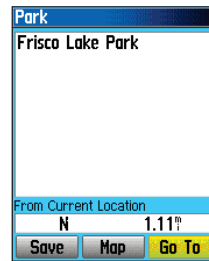

Information Page for a
Map Point with Data

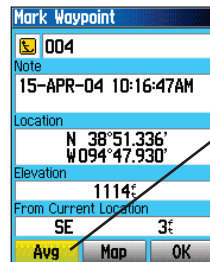

Mark Waypoint Page

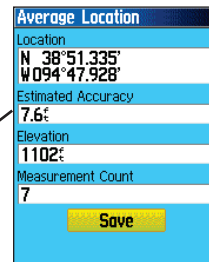

Average Location Page

Using Waypoints

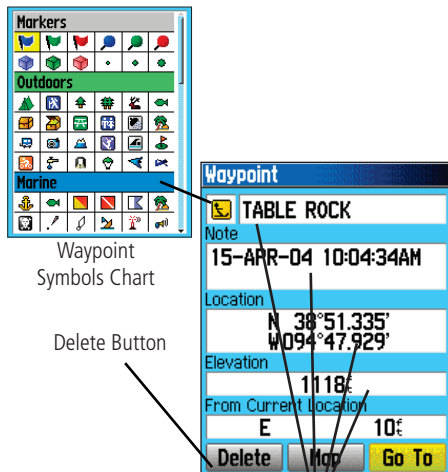

Alpha-Numeric Keypad

Editing a Waypoint

A waypoint can be selected from the Find Feature Waypoints list and edited to change the map symbol, name, location coordinates, elevation or to delete it. Refer to page 21 for details on using the Find Feature.

To edit a Waypoint:

1. Use the Find Feature to display the desired waypoint information page.
2. Make changes as required by highlighting each field and using the waypoint symbol chart and alpha/numeric keypad to enter new data.
3. Press the **MENU** key to close and save the changes.

To delete a Waypoint:

1. Use the Find Feature to display the desired waypoint information page.
2. Highlight the "Delete" button at the bottom of the page and press **ENTER**. Answer "Yes" to the pop-up prompt and press **ENTER** to delete.

To move a Waypoint on the Map Page:

1. Use the Find Feature to display the Information Page for the desired waypoint (refer to page 23).
2. Highlight the "Map" button at the bottom of the page and press **ENTER** to display the waypoint on the map.
3. Press **ENTER** again to place a "Move" marker next to the waypoint.
4. Use the **ROCKER** key to drag the waypoint to the desired location on the map and release to place it there. Then press **ENTER**.

Projecting a Waypoint

Projecting a waypoint from any map item (another waypoint, etc.) allows you to establish a new waypoint that is a certain bearing and distance away from that map item.

To project a waypoint:

1. Select an item from the Find Menu and display the Information Page.
2. Press the **FIND** key to display the Options Menu and select "Project Waypoint."
3. Press **ENTER** to display the Project Waypoint Page.
4. Enter the distance and bearing to the projected waypoint in the appropriate fields at the bottom of the page and press the **MENU** key to save and exit.

Using Waypoints

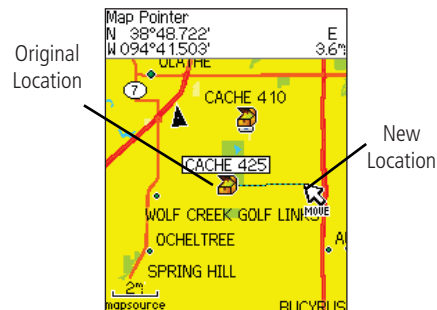

Moving a Waypoint

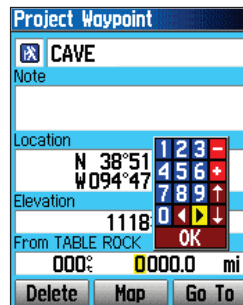

Project Waypoint
Page

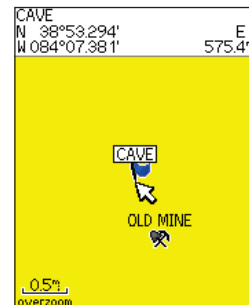

Projected Waypoint on
the Map

eTrex Legend C GPS Navigation

Using Find



Press and hold the MENU/FIND key to display the Find Menu

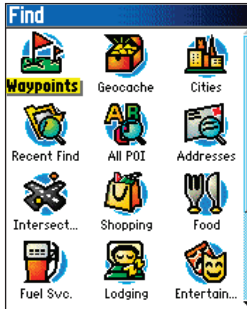

Find Menu



Auto Ordering Option places the last selected category at the top of the page.

Find By Name
Option



Options Menu for Waypoints



Options Menu for groups with Sub-Categories

Using the Find Menu

The Find Feature provides you with a method for searching for Cities and Exits which are included in the eTrex Legend C basemaps. If you have downloaded Garmin MapSource mapping data that contains additional map detail, you can search for Points of Interest, Addresses and Intersections. If you download BlueChart® data,* you can find detailed Marine items such as Wrecks and Obstructions, NAVAIDS, and Anchorages. If this additional data is not loaded, these options are not available. Waypoints and Geocache Points are items you can create and add to the Find Menu.

Searching for a map item is simplified because the map database is separated into groups, which are shown as icons on the Find Menu Page.

- When you access a Find group list, by default it contains only those items near your current location or the Panning Arrow (if active).
- To save effort in searching again for an item already found, you can use the “Recent Finds” group, which contains a list of 50 last found items of all categories.

The options menu for each map item group offers its own unique search options such as “Find By Name,” “Find Nearest,” “Select Symbol” (for Waypoints), “Change Reference” (by moving the map Panning Arrow to a new location), “Nearest Containing” (a key word you enter) and “Select Category” (for those groups such as Food and Drink, Lodging, etc.). Using these options can effectively shorten your search.

* Refer to the Garmin website: <http://www.garmin.com/cartography/mapSource/bluechartCD.jsp>

Searching for a location using Find By Name

If you know the name of the location you want to find, the Find By Name search option may be the easiest method of searching.

To find a location using Find By Name:

1. Press and hold the **MENU/FIND** key to display the Find Menu.
2. Use the **ROCKER** key to highlight the Group icon for the type of item you want to search for and press **ENTER** to display the page. Or, if you want to search the entire item database, select "All Points of Interest."
3. Press the **MENU** key to select "Find By Name."
4. Use the **ROCKER** key and **ENTER** key to operate the keypad at the base of the display and enter the name of the location, when the list displays a match, highlight "OK" and press **ENTER** to go a list where you can select the item.
5. Next, the Information Page for that location displays.

Searching for a location using Recent Finds

The Recent Finds Page saves all of your most recent searches in a list. Your last found location appears at the top of the list. When you exceed the number of entries the list can hold, the oldest is deleted.

To return to a recently found item:

1. With the Find Menu displayed, use the **ROCKER** key to highlight the Recent Finds icon and press **ENTER** to display the Recent Finds List.
2. Use the **ROCKER** key to select the list item you want view and press **ENTER** to display the Information Page for that item.

Using Find

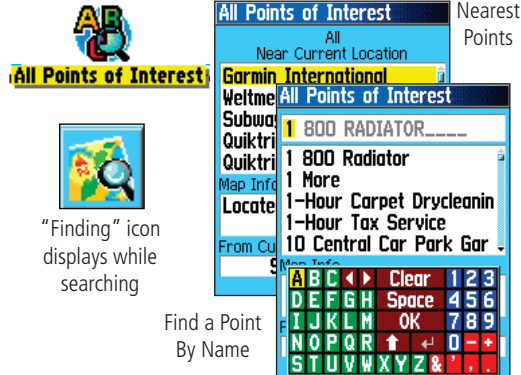

"Finding" icon displays while searching

Find a Point By Name



Pressing and holding the FIND key with Find Menu displayed will take you to this page.

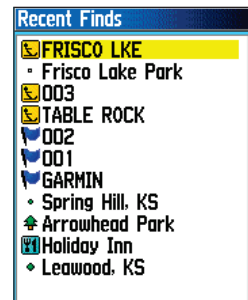

Recent Finds List

Using Find

Waypoint	
<input checked="" type="checkbox"/> LAKE TRAIL	
Note	15-APR-04 2:25:44PM
Location	N 38°51.337' W 094°47.929'
Elevation	1099'
From Current Location	N 0'
Delete Map Go To	

Select
as a
destination

Information Page
for a Waypoint

Park/Garden	
Naval Air Park	
100 E Old US-56 Olathe, KS 66061	
From Current Location	NW 1.35 mi
Save Map Use	

Select
as a
point on a
Route or
Track

Information Page
for a Map Item

Using the Find Item Information Page

When you select a Find item and press the **ENTER** key, an Information Page displays with detailed information about the item. This page contains the following information:

- A title (if a waypoint, it can be renamed and a map symbol assigned).
- An information field (if a waypoint, information you add, if a map item, an address or other description).
- Location coordinates, if the item is a waypoint.
- Elevation and depth, if a waypoint.
- Direction and distance from current location or the map pointer.

At the bottom of the page are three on-screen buttons. These buttons appear differently depending on whether you are selecting a Find item to navigate to or adding a Find item to a route list as a waypoint.

- If selecting an item as a destination, the buttons display as follows:
 - Delete** - remove from the Waypoints list.
 - Map** - display on the Map Page.
 - Go To** - start a Go To navigation.
- If selecting an item to add to a list of points, these three buttons are displayed.
 - Save** - save as a waypoint.
 - Map** - display on the Map Page.
 - Use** - insert into a list of points on a route.

The Find Information Page Options Menu offers eight options for using a Find Item as a tool for navigation.

To use the Find Item Information Page Options Menu:

1. With an Information page displayed for a Find item, press the **MENU** key to display the Options Menu.
2. Use the **ROCKER** key to highlight the desired option and press **ENTER**. The following items appear in the Options Menu:

- **Average Location** - Used when marking waypoints only, it samples a waypoint location over time and averages the result for a more accurate position reference.
(Refer to page 18 for detailed information on Location Averaging.)

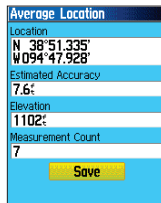

- **Project Waypoint** - Create a new waypoint by entering a bearing and distance from this point.
(Refer to page 20 for detailed instructions.)



- **Find Near Here** - Returns you to the Find Menu, where you can search for map items near this point.

Using Find

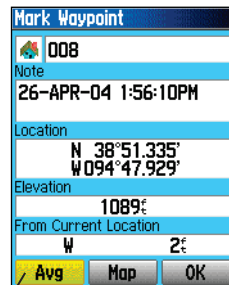

Mark Waypoint Information Page Options include "Average Location"

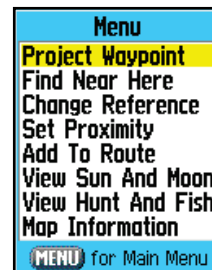

Mark Waypoint and Find Map Database Item Information Page Options

Using Find

- **Change Reference** - Point to a new location on the map Page using the Panning Arrow and press **ENTER**.

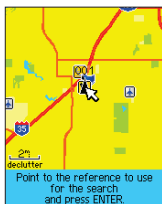

- **Set Proximity** - Program an alarm to sound when you are within a specified radius of an item defined by the Information Page.

(Refer to the Section on Proximity Waypoints on page 55 for detailed information.)

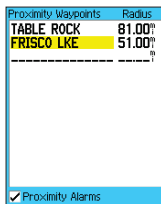

- **Add To Route** - Include this item on a New Route or add it to an existing route.

(See “Using Routes” page on 39 for details.)

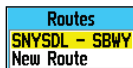

- **View Sun and Moon** -

View the Sun and Moon tables for this item location.

(Refer to page 59 for detailed information about the Sun and Moon Tables.)

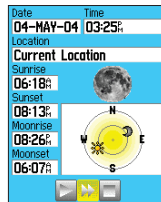

- **View Hunt and Fish** -

View the Hunt and Fish tables for this item location.

(Refer to page 60 for detailed information about the Hunt and Fish Tables.)

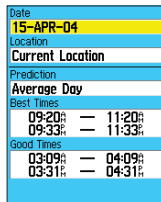

- **Map Information** -

Displays information about the map that the item originated from.

(Refer to page 74 of the Appendix for information about downloading detailed maps.)

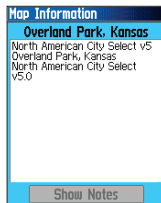

Searching for a Waypoint

The Waypoints List is your storage file for all created and saved waypoints. Waypoints are stored in alpha/numerical order and are also identified by a symbol assigned from a list of symbol types. Waypoints can be selected as destinations and added as points on a route.

To find a Waypoint:

1. Press and hold the **MENU/FIND** key to display the Find Menu.
2. Highlight the Waypoint icon and press **ENTER** to display the Waypoints List.
3. Use the **ROCKER** key to scroll up and down the list to find a waypoint. If the list is large, you can press the **MENU** key to display a list of the following search options.

“Find By Name” allows you to enter the name of the waypoint in a search field.

“Find Nearest” allows you to list only those waypoints near your current location.

“Select Symbol” allows you to search for only those waypoints of a specific type.

“Change Reference” allows you to use the Panning Arrow to select a point on the map other than your current location.

4. Once you find a waypoint, press **ENTER** to view the Waypoint Information Page. You can edit the data or select “Go To” to navigate to the waypoint.

Using Find

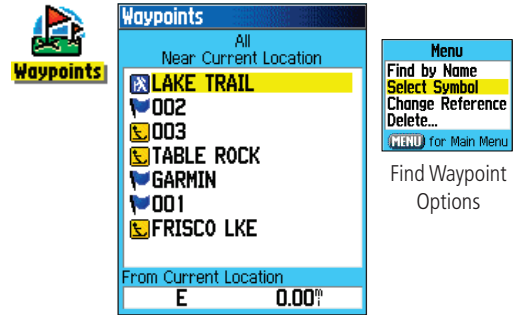

Find Waypoints List

Waypoint Information Page

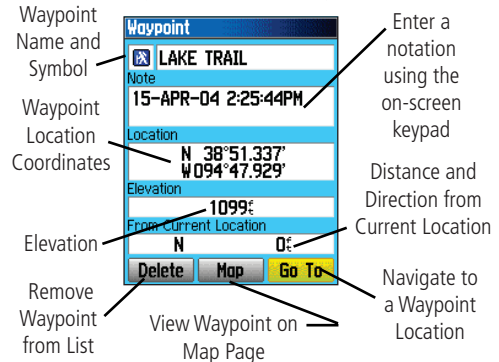

eTrex Legend C GPS Navigation

Using Find



Geocache

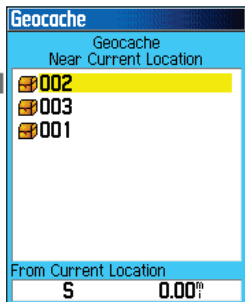

Find Geocache List



Options
Menu

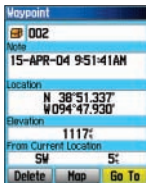

Information Page

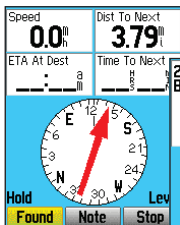

Use the "Found" button when you reach a geocache.

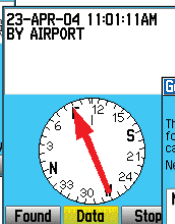

Use the "Data" button for information about a geocache.

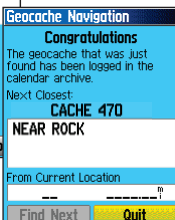

"Find Next" Option

Searching for a Geocache

The Find Geocache feature allows you to view the list of geocache locations that you have created using the eTrex Legend C or downloaded from your computer. A geocache location is actually a waypoint with a special geocache symbol assigned to separate it from others on the waypoints list. For more information on creating a geocache point, refer to "Geocache Setup" instructions on page 52.

To find a Geocache:

1. Press and hold the **MENU/FIND** key to display the Find Menu.
2. Use the **ROCKER** key to highlight the Geocache icon and press **ENTER** to display the Geocache List. You can display either found geocaches or those that have not been found.
3. Use the **ROCKER** key to highlight the desired geocache in the list and press **ENTER** to display the information page.
4. Highlight the "Go To" button and press **ENTER** to navigate to the geocache location. When you navigate to a geocache, the Compass Page changes to "Geocache Navigation" mode and any additional information about downloaded cache location is displayed in the field.

Note: When you find a geocache, the unit marks the cache as found, logs an entry into the calendar and provides an option that, when activated, shows the next nearest cache.

Searching for a City

The Find Cities feature allows you to search for any city listed in the mapping database (either in the basemap or from downloaded detailed mapping data).

To find a city:

1. Use the **ROCKER** key to select the "Cities" option, then press **ENTER** to display the find by "Nearest" list of cities.
2. Use the Options Menu to find a city "By Name," by entering a key word for "Nearest Containing," use "Select Map" to select a different map to search from or "Change Reference" from your current location using the Map Pointer.
3. If using find "By Name," begin spelling the name of the city by using the keyboard. When you have entered enough characters to define the name, the keyboard closes and a match list of cities displays. Scroll through the list to find the city you want. If using "Nearest Containing," use the keyboard to enter a key word to display a list of cities using that word.
4. Use the **ROCKER** key to select the desired city from the list and then press **ENTER** to display the Information Page for that city.
5. With the Information Page displayed, you can select from "Go To," "Map" or "Save" options.

Using Find



Cities

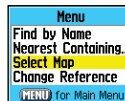

Cities Options
Menu

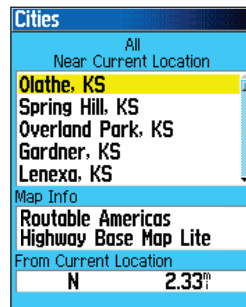

Find Cities
List

Select Maps
Options

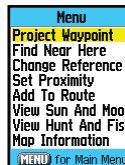
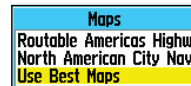

City Page
Options

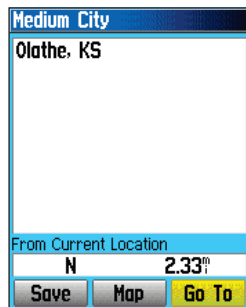

City
Information
Page

Using Find



Exits

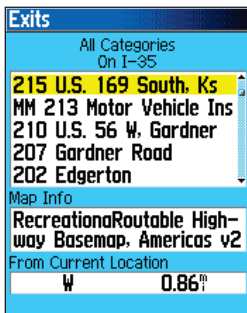

Find Exits List

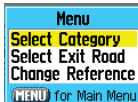

Options
Menus

Searching for an Interstate Exit

The Find Exits feature allows you to search for the nearest Interstate Exits.

1. Press and hold the **MENU/FIND** key to display the Find Menu. Select the Exits icon, then press **ENTER** to display the Exit List.
2. Highlight and select an exit type by pressing **ENTER**. A list of exits nearest to you displays. The title box indicates the interstate highway which is served by the exits. Two fields at the bottom of the page indicate distance and bearing to the exit.
3. Scroll through the list to highlight the desired exit. Press **ENTER** to display the Information Page for that exit. This page contains the exit description with a list of available services near that exit along with the distance and bearing fields.
4. Use the **ROCKER** key to move to the list of services and highlight a selection from the list.
5. Press **ENTER** to display the Information Page for the selected service.

The Exit Services Information Page displays the name of the service, its direction from the exit, and a list of the services available.

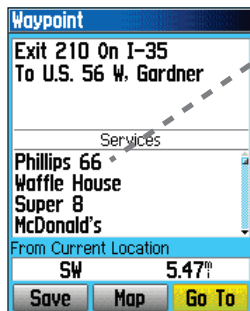

Exit Information Page

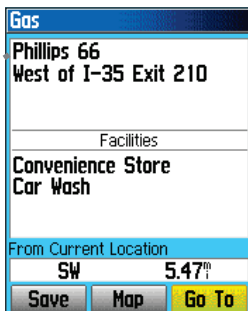

Exit Services Info Page

Searching for an Address

The Find Addresses feature allows you to search for an address if you have downloaded detailed mapping data. Enter the street number, street name and city and the Find Feature matches that data with addresses in the map database.

To find an Address:

1. Press and hold the **MENU/FIND** key to display the Find Menu.
2. Highlight the Addresses icon and press **ENTER** to display the "Find Addresses" page.
3. If your unit has a GPS fix, the "Region" field at the top of the page is completed with your current region and the <Enter Number> field is highlighted. Identifying a city is not necessary as the database has information for the entire region.
4. Enter the Street Number "<Enter Number>" using the on-screen keypad. Select "OK" to enter the number.
5. Finally press **ENTER** to display the street list. Use the on-screen keypad to enter enough of the street name to display a match on the list below. For name streets, like Main or Elm, enter the core name instead of "E," "W," etc., to make the search faster.
6. When done, a list of matches appears below. Select one and press **ENTER** to display the Information Page.

Using Find



Addresses



Search Clear
Options

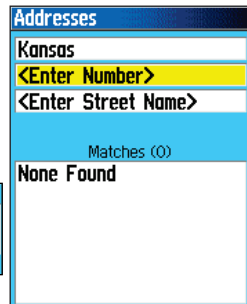

Find Addresses Search
Page

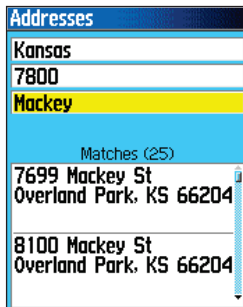

Find Address Matches



Address Information
Page



Options
Menu

Using Find

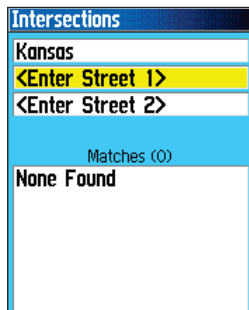

Intersections Search Page

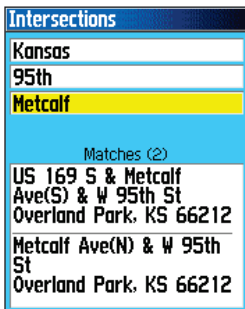

Intersection Matches

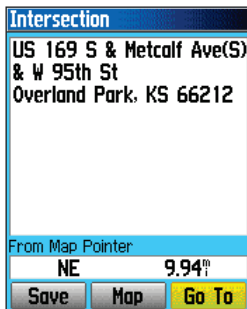

Intersection Info Page

Searching for an Intersection

The Find Intersections feature allows you to search for an intersection if you have downloaded detailed mapping data. Enter the two street names and city and the Find Feature matches that data with intersections in the map database.

To find an Intersection:

1. Press and hold the **MENU/FIND** key to display the Find Menu.
2. Highlight the Intersections icon and press **ENTER** to display the "Find Intersections" search page.
3. If your unit has a GPS fix, the "Region" field at the top of the page is completed with your current region and the <Enter Street 1> field is highlighted. Identifying a city is not necessary, as the database has information for the entire region.
4. With <Enter Street 1> highlighted, follow instructions in step 6 of the previous page. Repeat for <Enter Street 2>.
5. Press **ENTER** to display the street list. Use the on-screen keypad to enter enough of the street name to display a match on the list below. For name streets, like Main or Elm, enter the core name instead of "E," "W," etc., to make the search faster.
6. When done, a list of matches appears below. Select one and press **ENTER** to display the Information Page.

Searching for a Point of Interest

You can use the Find Point of Interest feature to locate a nearby restaurant, lodging, landmark, public building, park, etc. However, you must have downloaded MapSource detailed mapping that supports this feature otherwise; these options, plus Address and Intersection options, are not functional.

To find a point of interest:

1. Press and hold the **MENU/FIND** key to display the Find Menu.
2. Highlight a desired "Points of Interest" icon and then press **ENTER** to display the list of nearest points.
3. Press the **MENU** key to choose from search options or choose "Select Category" to narrow your search.
4. Highlight the desired item from the list and then press **ENTER** to display the Information Page for that item.

If you are searching for a restaurant that is part of a national chain, only the nearest restaurant to your location is displayed when you search using the "Find Nearest" method. If you search using the "By Name" method, then all of the locations for that chain in the mapping database will be displayed, with the closest to your current location listed first.

Using Find



Find POI Topic List

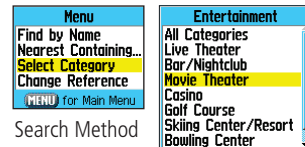

Select Category



Category List

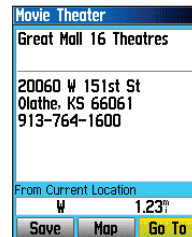

POI Information Page

The Main Menu

The Main Menu is the directory for all unit features not in the Main Page sequence. Use the **ROCKER** key to highlight a feature name and then press **ENTER** to display the feature page.

- **Satellite** - This feature allows you to observe the status of overhead GPS satellites.
- **Trip Computer** - This feature provides a variety of useful travel and navigation data.
- **Mark** - This feature allows you to mark and record your current location as a waypoint.
- **Find** - This feature provides a method for searching for map items in the unit's basemap.
- **Tracks** - This feature allows you to maintain a record of your movements (track log) with information.
- **Routes** - Allows you to create a list of points that you wish to navigate to in a specific order and save for later use.
- **Highway** - A useful graphic perspective for navigating a route.
- **Setup** - Controls the settings for many of the unit operating system features.
- **Proximity** - Activates an alarm for a defined radius around a specified waypoint.
- **Calendar** - An outdoor calendar with data access and waypoint association.
- **Alarm Clock** - Allows you to use the eTrex Legend C as an Alarm Clock.
- **Calculator** - A standard or scientific calculator for measurement conversions, etc.
- **Stopwatch** - A multi-featured stopwatch.
- **Sun & Moon** - Sunrise and sunset times, moon phases and sun and moon positions for any given date and time.
- **Hunt & Fish** - A table of time frames for best hunting and fishing opportunities for any given location and date.
- **Games** - A series of challenging games, some incorporating GPS navigation.

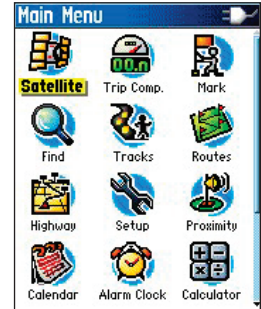

Using the Trip Computer Page

The Trip Computer Page provides you with a wide variety of travel data that is useful when navigating long distances. It indicates your current speed, average speed, trip odometer and many other statistics useful for navigation.

You can customize the Trip Computer display to meet your personal requirements. Selecting the type of data to display is done in the same manner as for the data fields on the Map Page. (See page 11 for details.)

If you want to record new data for each trip, a “Reset” option is available. If you want to view significant trip data at a glance, you can use the “Big Numbers” option, which shows fewer fields with larger displays.

Before each trip, be certain to reset the trip information by highlighting “Reset” from the options menu and pressing **ENTER**.

The Reset Page offers options for resetting trip computer data, clearing the Track Log and deleting Saved Tracks, Waypoints and Routes. This page allows you select individual items, select all and unselect all. Once your selections are made, highlight the “Apply” button and press **ENTER**. Answer “OK” to the Yes/Cancel prompt and press **ENTER** to complete the reset.

Selecting the “Restore Defaults” option returns the page to factory settings.

Reset	
<input checked="" type="checkbox"/>	Reset Trip Data
<input type="checkbox"/>	Reset Odometer
<input checked="" type="checkbox"/>	Reset Max Speed
<input type="checkbox"/>	Clear Track Log
<input type="checkbox"/>	Delete Saved Tracks
<input type="checkbox"/>	Delete All Waypoints
<input type="checkbox"/>	Delete All Routes
<input type="button" value="Select All"/> <input type="button" value="Unselect All"/>	
<input type="button" value="Apply"/>	

The Trip Computer Page

Select “Change Data Fields” or press the **ROCKER** key to highlight a field you want to change.

Trip Odom 0.81 ^m _t	Max Speed 3.8 ^m _h
Moving Time 08:41 ^M _{MIN}	Moving Avg 5.6 ^m _h
Stopped 52:36 ^H _{SS}	Overall Avg 0.0 ^m _h
Elevation 1101 ^f _t	
Odometer 0.81 ^m _t	

Menu
Reset...
Big Numbers
Change Data Fields
Restore Defaults
MENU for Main Menu

Options Menu

Trip Odom 0.86 ^m _t
Speed 0.0 ^m _h
Moving Time 10:55 ^M _{MIN}

Big Numbers Option



Using Tracks

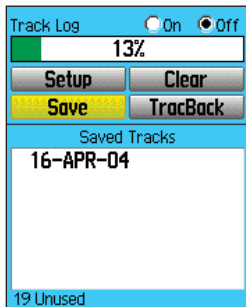

Tracks Page with Saved Track Log

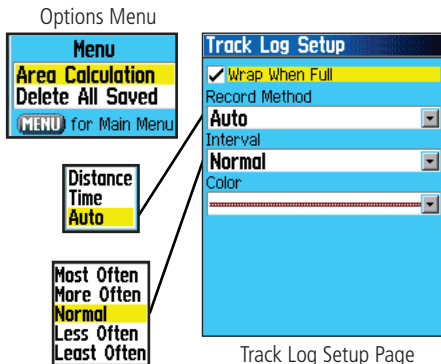

Track Log Setup Page

Using a Track Log

The Tracks feature creates an electronic trail on the map page as you travel about and is referred to as a Track Log. A track log contains information about points along its path, including time, position and elevation.

Use a Track Log to do the following:

- Record your movements for a given time and place and save it.
- Measure the area of any space you encompass with a track.
- Retrace your path in either direction.

To create a Track Log:

1. Press and release the **QUIT** key until the Main Menu displays. Then use the **ROCKER** key to highlight the Tracks icon.
2. Press **ENTER** to display the Tracks Page. The page contains On and Off buttons to activate or cancel the Track Log and a Track Log meter which displays the percentage of track log space used.
3. Beneath the Track Log field are four on-screen buttons to "Setup" a track log, "Clear" the track log, "Save" a track log and activate the "TracBack®" feature for the current log.
4. To setup a track log, highlight the "Setup" button and press **ENTER** to display the Setup page. Check "Wrap When Full" to continue recording when full by overwriting the oldest data with new.

- Highlight the "Record Method" field and press **ENTER** to display the Distance, Time and Auto options. Because a track is made of a series of points that define your path of travel, they can be placed a specified "Distance" apart or placed at a "Time" interval you specify. The "Auto" option allows you choose from five intervals.
- Next, set the interval for setting track points. You can choose from distance, time or frequency values.
- When completed, press the **QUIT** key to return to the Track Log Page.

To save a Track Log:

- With the Tracks Page displayed, highlight the "Save" button and press **ENTER**. A message asks "Do You Want To Save the Entire Track?" If you select "Yes," a "Saving Track" message appears followed by the Saved Track Page. The new saved track is a representation of the entire track log from beginning to end.
 - If you select "No," a map showing the entire track appears and prompts "Select the beginning point for the saved track." Use the **ROCKER** key to move the Panning Arrow to the point on the track line that you want to become the beginning of the Saved Track and press **ENTER**.
 - The next prompt asks you, "Select the ending point for the saved track." Use the Panning Arrow to identify a point on the track that you want as the End Point and press **ENTER**. A "Saving Track" message appears followed by the Saved Track Page.
- (cont. on following page)

Using Tracks

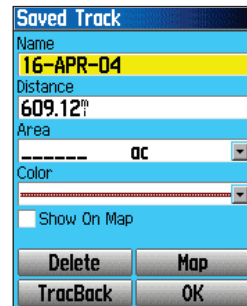

Saved Track Page

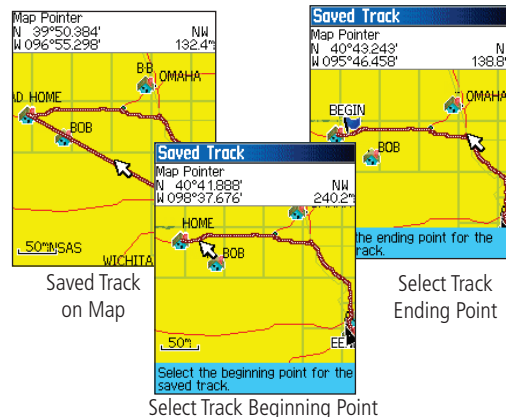

eTrex Legend C GPS Navigation

Using Tracks

Saved Track	
Name	19-APR-04
Distance	112.56"
Area	411955 ac
Color	
<input type="checkbox"/> Show On Map	
Delete	Map
TracBack	OK

Saved Track Page

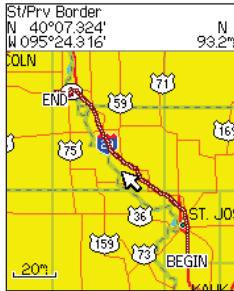

Saved Track on the Map Page

4. The Saved Track Page allows you to rename the track, view the track distance, view the calculated area encompassed by the track (an area is defined even if the track is open ended) and specify a color for the track when displayed on the map page (Show On Map). On-screen buttons at the bottom of the page allow you to Save the track (OK), delete, view it on the Map, and navigate the track back to any point along the track (TracBack).

To view a Track on the Map:

1. With the Saved Tracks Page for the track or the Track Log displayed, highlight the Map button and press **ENTER** to display the Map Page.
2. A map showing the entire track appears with Begin and End markers. Any User Waypoints added to the Track are displayed as well.

Area Calculation Option

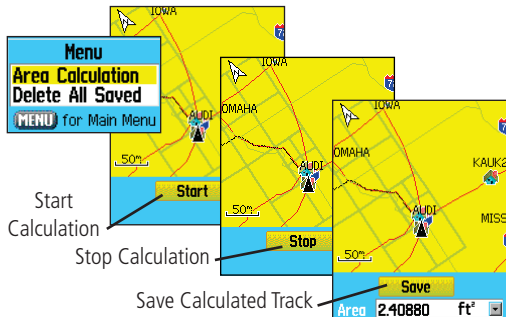

To calculate the area of a Track:

1. With the Track Log Page displayed and the Track Log On, press the **MENU** key, highlight the Area Calculation option and press **ENTER**.
2. Press **ENTER** to start the calculation as you begin to move and define the area's boundaries. The page now displays a Stop button.
3. When you have completed defining the area, press **ENTER** to display the page with a Save button.
4. Press **ENTER** again to save the new track to the Saved Tracks List.

Track Profiles

A Track Elevation Profile can be created from Digital Elevation Models (DEM) maps (MapSource U.S. Topo 24K) which include elevation data contained in the map. To create a track profile, you must be located within the geographic area supported by the DEM map data loaded on your eTrex Legend C. A Track Profile page displays when you select "Profile." See page 74 for more information about MapSource U.S. Topo 24K maps.

To view a Track Profile:

1. With the Saved Tracks Page for the Track displayed, press the **MENU** key to display the Profile option.
2. Then press **ENTER** to display the Track Profile.

The beginning of the track is marked by a flag and you can scroll across the profile by pressing the left **ROCKER** key arrow.

As you scroll the profile, the elevation for each point on the profile is displayed at the top of the page and the distance from the Start point and the End Point is displayed at the bottom.

3. At any point along the profile, you can press **ENTER** to display that point on the map.
4. Press the **MENU** key to use "Zoom Ranges" and "Hide Symbols" options.

Using Tracks

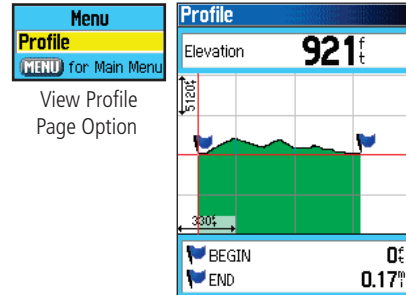

Track Profile Page

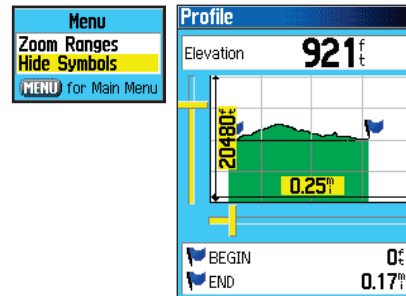

Zoom Ranges Page

Using Tracks

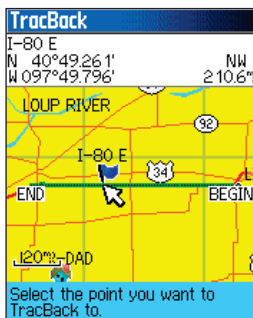

TracBack Page



TracBack
Route
Options



Active TracBack Following the Track

To use the TracBack feature:

1. With the Saved Tracks Page for the track or the Track Log displayed, highlight the TracBack button and press **ENTER** to display the TracBack Page.
2. A map showing the entire track appears and you are prompted to select the point you want to TracBack to. Use the **ROCKER** key to move the Panning Arrow to the desired point on the map and press **ENTER** to start navigating the TracBack.
3. Select either "Follow Road" to route back to the selected point using available roadways or "Follow Track" to retrace your original path of travel. Highlight the "Don't ask Again" option and press **ENTER** if you want to use the same option the next time you use TracBack.
4. When the TracBack Navigation Page appears, directions to the first turn on the track display at the top of the page. Move in the direction of the first turn. When you reach the first turn, the display provides direction to the next turn, and so on, until you have reached your destination.
5. To exit a TracBack, press the **MENU** key and select "Stop Navigation."

To create a User Waypoint on a Saved Track:

1. With a saved track displayed on the map, use the **ROCKER** key to move the Panning Arrow to the point on the track that you want to mark as a user waypoint. Press **ENTER** to display the Mark Waypoint Page.
2. Customize the user waypoint if desired as explained on page 19; then highlight the "OK" button and press **ENTER** to save.

Creating and Using a Route

With routes, you can create a sequence of intermediate waypoints that lead you to your final destination. The eTrex Legend C stores 50 routes, with up to 250 waypoints each. A route can be created and modified from the Routes Page, and waypoints can be added to a route from the Find Menu. More complex routes can be created using a PC and MapSource mapping programs and then transferred to the unit memory. Auto-Routes which are generated when you select “Go To” for a Find item, map item or waypoint cannot be saved.

To create and save a route:

1. Access the “Routes” page from the Main Menu. The page has a “New” button, an “Active” button and a list of saved routes.
2. Use the **ROCKER** key to highlight the “New” button and press **ENTER** to display the route Setup Page.
3. With an empty row (dashed) in the route list highlighted, press **ENTER** to display the Find Menu.
4. Use the Find Menu to select a route waypoint from one of the Find Menu groups and display the Information Page for the selected waypoint, city, exit, point of interest, etc. Highlight the on-screen “Use” button and press **ENTER** to place it on the Route Waypoint List.
5. To add more waypoints to the route, repeat the process in Steps 3 and 4. You can rename the route if desired.
6. Press **QUIT** to save it to the Saved Routes list or highlight the “Navigate” button and press **ENTER** to navigate.

Using Routes

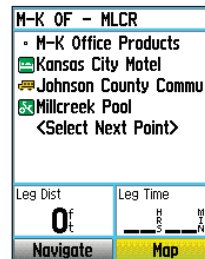
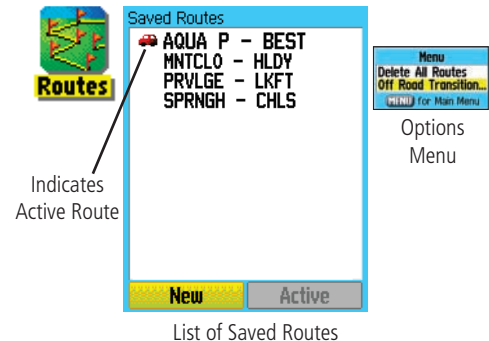

Route Setup Page

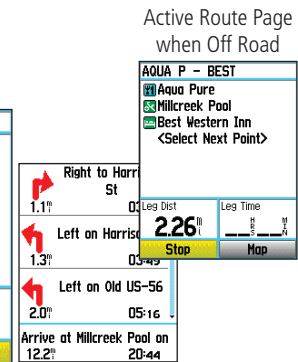

Active Route Page when following roads

eTrex Legend C GPS Navigation

Using Routes

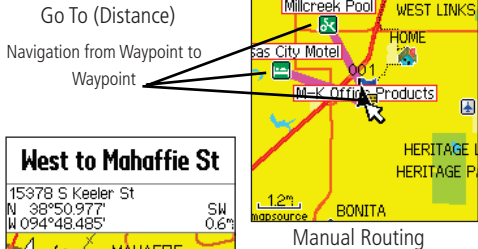
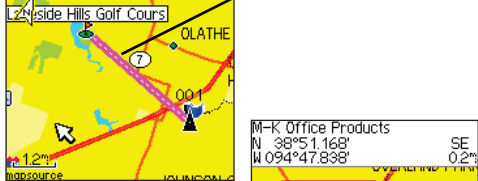
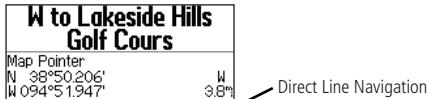

Methods of navigating to a destination:

- When you activate the “Go To” button on the Information Page for a User Waypoint or other Find Menu items, the eTrex Legend C creates a straight path (point to point) from your current location to that location.
- When you press the “Navigate” button on a Route page, the eTrex Legend C creates a route composed of several User Waypoints or Find Menu items, with the last being your destination. It navigates directly from point to point. Before each turn in the route a turn page displays a guidance message and graphic of the turn. You can view the turns at any time by pressing the **ROCKER** key Up or Down arrows while the route is active.
- These two navigation methods change when you select the “Follow Roads” option from the Routing Setup Page. Both Go To navigation and point to point routing become routes that use roads.

The routes use existing roadways (either those in the basemap or from downloaded detail mapping) to automatically calculate a route to your destination. Turns on roadways are added to the active route page and is preceded by a guidance message with graphic display of the turns.

If there are not enough roads at your location to calculate a route, a message appears to advise you.

Navigating a Route

After you have created a route, you can begin navigation immediately. When you are navigating a route, a guidance message and graphic view of turns in the route displays as you approach each one. Using the “Follow Roads” option from the Routing Setup Page increases the number of turns and displays an Active Route page with a list of turns. If you selected the “Off Road” option you can view only the list of points for a route from the Active Route Page. (See Routing Setup on page 51.)



To preview the turns for an Active Route:

1. From the Routes Page, highlight the route from the Routes list and press **ENTER** to display the Route Page for the route.
2. Highlight the “Navigate” button and press **ENTER** to begin navigation and display the route on the Map Page.
3. To view the list of turns on the route, press the **QUIT** key to display the Active Route Page. The view any individual turn on the list, use the **ROCKER** key to highlight it and press **ENTER**.
4. The page displays the turn and guidance text and a small field at the bottom showing the turn number in sequence and total turns in the route. To scroll through all turn previews, use the **ROCKER** key Up and Down arrows. To exit the preview page, press the **QUIT** key.
5. To stop navigating, select “Stop Navigation” from the Map or Compass Page and press **ENTER**.

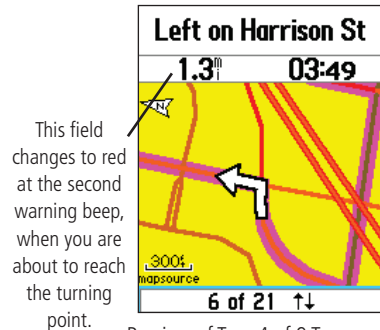
Using Routes



Preview of Turn 4 of 9 Turns on a Route

	Right to Harrison St	1.1 ^m	03:14
	Left on Harrison St	1.3 ^m	03:49
	Left on Old US-56	2.0 ^m	05:16
Arrive at Millcreek Pool on		12.2 ^m	20:44

List of Turns for an Active Route using the “Follow Roads” option

Using Routes



Saved Routes
Options

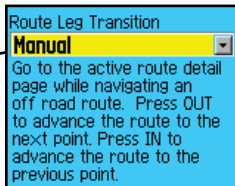
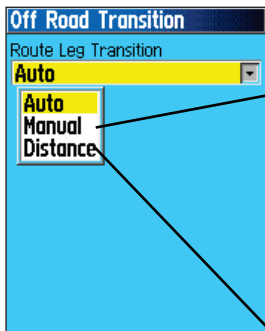

Route Leg Transition
Options

Route on the map will transition to the next leg point when you are within a 1 mile radius of that point.

Route Options

To delete the route:

1. Access the Saved Routes Page from the Main Menu and press the **MENU** key to display the Options Menu.
2. To clear the saved routes list, select "Delete All Routes" and press **ENTER**. A prompt displays, asking "Do you really want to delete all routes?" Select "Yes" and press **ENTER**.

To change the off-road transition for a route:

1. Access the Saved Routes Page from the Main Menu and press the **MENU** key to display the Options Menu.
2. To select a method for advancing the route to the next point on the route, select "Off Road Transition" and press **ENTER** to display the Off Route Transition Page.
3. Highlight the Route Leg Transition field and press **ENTER** to display the list of options. Select "Auto," "Manual" or "Distance."

Using the Route Detail Page Options:

To remove all waypoints:

1. Press the **MENU** key to display the Options Menu.
2. Highlight the "Remove All" option and press **ENTER**. At the prompt, select "Yes."

To reverse the route:

With the Options Menu displayed, highlight the "Reverse Route" option and press **ENTER**.

To create a vertical profile of the route:

(Available only if Garmin MapSource DEM map data is used. See page 74 for details.)

Select "Profile" and press **ENTER** to display the route profile.

To copy the route:

Highlight the "Copy Route" option and press **ENTER**. The copied route displays on the Routes Page and is named the same but followed by a numeral 1.

To delete the route:

Select "Delete" and press **ENTER**. At the prompt, select "Yes."

To change the route data fields:

Select "Change Data Fields" and press **ENTER** to display a list of data field options (see page 11 for detailed information).

To restore default settings for the route:

Select "Restore Defaults" and press **ENTER**.

To modify a waypoint on a Route Detail Page:

Select the waypoint from the list of waypoints and press **ENTER** to access the Route Waypoint Options Menu.

Using Routes

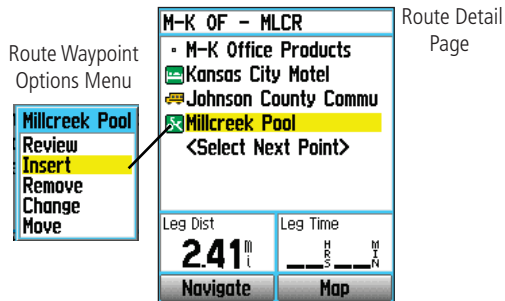

Route Waypoint
Options Menu



Options Menu

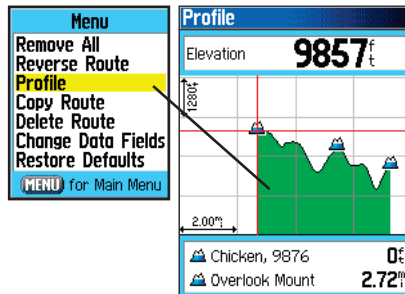

Route Vertical Profile using
U.S. Topo 24K DEM mapping data

The Highway Page

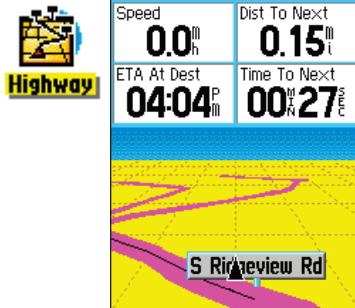

Highway Page with an Active Route



Highway Page Options Menu

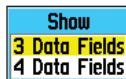

Data Field Display Options

The Highway Page

When navigating a route, the Highway Page can guide you to the destination using data fields and a graphic highway. Up to four user selectable data fields display information such as speed, distance, time to next point on the route, etc. The list of data to display and the method of selection is the same as for the Compass Page and is explained in detail on page 11.

The Highway graphic provides visual guidance, taking you point by point to your final destination. Your course is represented by a center line down the middle of the graphic. As you move toward each point on your route, the graphic shows the direction you should move to stay on course to the point. Five scale settings allow you to zoom in or out on the highway.

To navigate using the Highway Page:

1. While navigating, access the Highway Page from the Main Menu and observe your path of travel displayed on the highway graphic.
2. Press the **MENU** key to display the options menu. You can do the following:

Stop Navigation/Resume Navigation, Recalculate, Configure Data Fields from four to three with a destination guidance message, Change the Data Fields or restore Defaults to factory settings.

The Setup Menu

The Setup Menu allows you to customize the eTrex Legend C to your personal preferences. Each setup page is identified by an icon, Highlight an icon and press **ENTER** to view that setup page.

The setup pages are arranged with features and data fields that can be changed to meet your requirements. All setup features have been set to default settings at the factory. It is not necessary to set up each feature unless you desire a different option.

To access the Setup Menu:

1. From the Main Menu select the Setup icon and press **ENTER**.
2. With the Setup Menu displayed, select the feature you wish to modify and press **ENTER**.



The Setup Menu

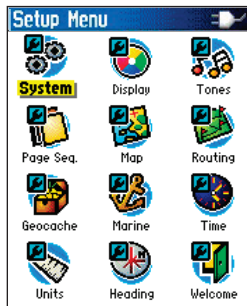

Setup Menu

System Setup

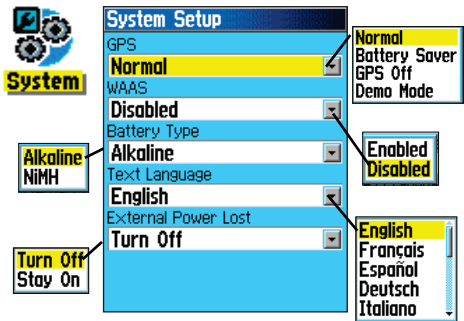

System Setup Page and Options

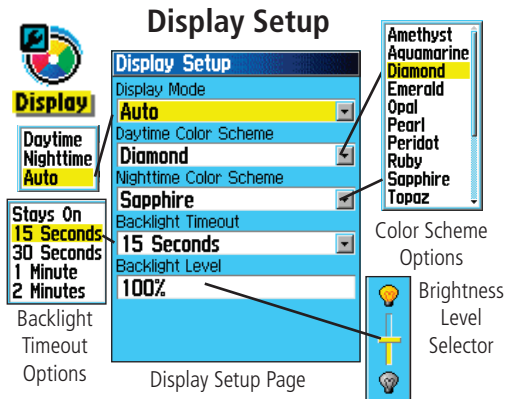

Display Setup Page

System Setup

The System Setup Page allows you to choose from four modes of GPS operation, enable/disable WAAS (see page 78), designate battery type, choose a display text language and choose what happens when the unit is disconnected from an external power source.

To change a System Setup feature:

1. Use the **ROCKER** and **ENTER** keys to select the feature field and setup options.
2. With an option for a field highlighted, press **ENTER** to select.

To view the software version, press **MENU** and select "Software Version."



Display Setup

The Display Setup Page allows you to select a screen display color scheme for day and night viewing. You can set the backlight timeout and the level of brightness, which can significantly save battery power.

To change a Display Setup feature:

1. Use the **ROCKER** and **ENTER** keys to select the feature field and setup options menus.
2. With an option for a feature field highlighted, press **ENTER** to select. Use the **ROCKER** key to slide the brightness level selector up or down.

Tones Setup

The Tones Setup Page allows you to customize the tones for a variety of unit features.

To use the Tones Setup feature:

1. Access the Tones Setup Page.
2. Use the **ROCKER** key to highlight the feature for which you want to set a tone and press **ENTER** to display the options menu.
3. Highlight the desired option and press **ENTER**. As you move down the list, each different tone sounds.

Page Sequence Setup

The Page Sequence Setup Page allows you to reorder any of the Main Pages, or add pages when you cycle the **MENU** key. If you add a page to the sequence, it no longer appears in the Main Menu.

To move, insert or remove a page:

1. Access the Page Sequence Setup Page.
2. To move a page in the order, highlight the page and press **ENTER**. Select "Move," then move Up or Down until the desired position is displayed and press **ENTER**.
3. To insert a new page, highlight the page you want to follow the new page and press **ENTER**. Then select "Insert," and choose a page from the displayed list and press **ENTER**.
4. To remove a page, highlight the page and press **ENTER**. Select "Remove" and press **ENTER**.

Tones Setup



Tones Sound when high-lighted

Check the "Mute" box to turn tones off

Page Sequence Setup

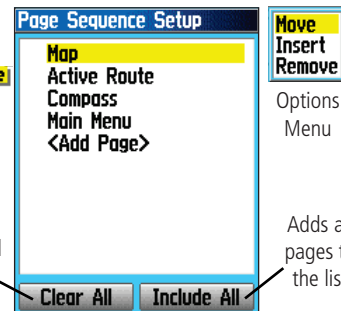

Restores to original setting

Options Menu

Adds all pages to the list

Page Sequence Setup Page

eTrex Legend C GPS Navigation

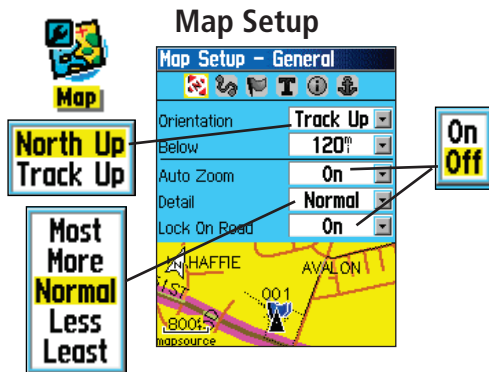

The "General Settings" Map Setup Page

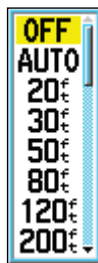

Max Zoom Options

Many of the Setup features use the same type of option lists: Off/On, Most to Least, Small to Large, a scale from 20 feet to 500 miles and a keypad for numerical data entry.

The Map Setup Options Menu allows you to quickly restore map settings.



Numeric Keypad

Using the Map Setup Feature

The map display for your eTrex Legend C can be customized. A factory set of default settings currently controls the Map Page display and may be satisfactory for your current requirements. The Map Setup pages allow you to determine how map features appear on the page by controlling map orientation, text size, track display, map item display, detailed map data display and more. It is suggested that you wait until you are more familiar with the operation of your unit before deciding what features you want to customize.

To customize the Map Page display:

1. To access the Map Setup Pages, press the **MENU** key with the Map Page displayed.
2. Scroll down the menu to the "Setup Map" option and then press **ENTER** to display the Map Setup Page. At the top of the page are icons for each setup page.
3. Use the **ROCKER** key to move from icon to icon when selecting a map setup page and to move up and down to the feature fields on each page.
4. With a Map Setup feature highlighted, press the **ENTER** key to display the list of options for that feature. Each Map Setup Page has a menu of general options. This menu can be accessed by pressing the **MENU** key with the page displayed.

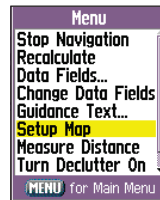

Map Setup - General Settings

The first page of the Map Setup feature is the General Settings Page. Use this page to select the map orientation. “Below” sets the map scale at which the Track Up feature displays; all scales above that revert to the North Up map orientation. “Auto Zoom” changes the map scale to include the beginning and ending points of a route. “Detail” selects the degree of map detail displayed. You can lock the Position Arrow to display on the nearest road, compensating for variances in map position accuracy.

Map Setup - Tracks Settings

The second page of the Map Setup feature is Tracks Settings. You can change maximum zoom settings for viewing saved tracks and active track logs. You can set the number of track points for recording a track and select either a bearing or course line for navigating a track.

Map Setup - Points Settings

The third page of the map setup feature allows you determine the map scale at which various map features display. You turn off the display, set it to Auto or select a value from 20 feet to 500 miles.

Map Setup

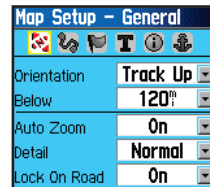

The “General Settings” Map Setup Page

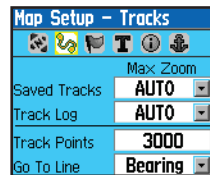

The “Tracks Settings” Map Setup Page

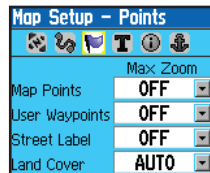

The “Points Settings” Map Setup Page

Map Setup

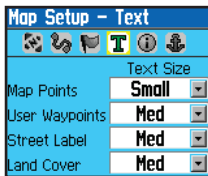

The "Text Settings" Map Setup Page



The "Map Information" Map Setup Page



The "Marine Settings" Map Setup Page

Map Setup - Text Settings

The fourth page of the Map Setup feature is the Text Settings Page. Use this page to select the text size for descriptions of items on the Map Page. You can select from Small, Medium, or Large.

Map Setup - Information Settings

This page of the Map Setup feature displays a list of MapSource maps you have downloaded such as topographic, marine charts, and MapSource maps with auto-routing capability. Use the **ROCKER** key to highlight the desired map then press **ENTER** to show it on the map display or turn it off.

Pressing the **MENU** key displays list of options for managing these maps.



Map Information Options Menu

Map Setup - Marine Settings

The last page of the Map Setup is the Marine Settings Page. Use this page to control the display of marine chart items when using downloaded marine charts (i.e. MapSource BlueChart® marine mapping data).

Routing Setup

The Routing Setup Page allows you to customize how routing functions behave. There are setup and option menus for route creation and methods of navigation.

To Use Routing Setup Options:

1. Access the Routing Setup Page.
2. Select the Guidance Method and choose "Prompted" if you want to be asked to choose one of the other two options ("Follow Road" or "Off Road") each time a route is being calculated. Otherwise, the chosen method is always used for navigation.
3. If you chose "Follow Road" then the "Follow Road Method" field will offer a similar choice of "Prompted," "Faster Time" or "Shorter Distance."
4. If you want the Next Turn Preview Page to display just before each turn on the route, select "On" from the "Next Turn Pop-Up" field.
5. When using the "Follow Road" guidance method, select the Follow Road Options button and press **ENTER** to choose from a page of options.

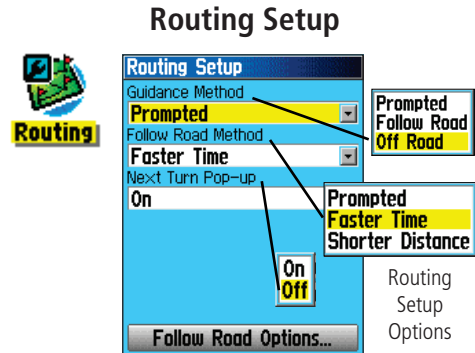

Routing Setup Page

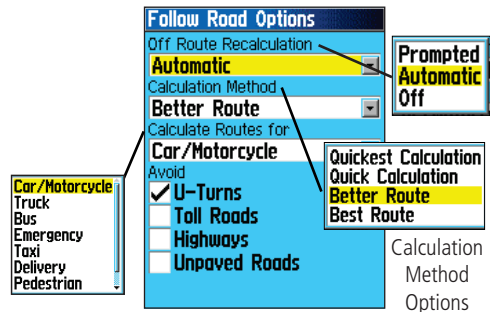

Follow Road Options

eTrex Legend C GPS Navigation

Geocache Setup

Geocache

Yes/No

Waypoint Symbols List

Geocache Setup
Geocache Symbols
Find Found
Calendar Entry When Found
Yes
Find hidden treasures using GPS coordinates posted on the Internet by those hiding the cache. Find the cache, fill out the logbook, take something out, put something back in, and return the cache. For more details visit <http://www.garmin.com/outdoor/geocaching/>.

Waypoint Symbols List

Marine Setup

Marine

Speed Filter Options

Off Auto User

Marine Setup
Anchor Drag Alarm
0.0%
Off Course Alarm
0.31°
Speed Filter
Auto

Geocache Setup

The Geocache Setup Page allows you to find and record items hidden at geographic locations. Refer to the Garmin website www.garmin.com, for details and directions for downloading geocache locations from the internet.

To use the Geocache Setup feature:

1. Access the Geocache Setup Page.
2. Highlight the symbols fields and press **ENTER** to change the default geocache symbols. Select “Yes” or “No” for Calendar entry when found.

IMPORTANT NOTE: Before setting up and placing physical geocache stations on public or private land, be certain you are not in violation of ordinances or laws governing use of these properties.

Marine Setup

The Marine Setup Page allows you to activate alarms for maritime navigation.

To use the Marine Setup feature:

1. Access the Marine Setup Page.
2. Highlight the box in front of each field to activate the desired alarm and press **ENTER**.
3. Highlight the field adjacent to each checked box, press **ENTER** and use the Number Keypad to enter the value for each alarm. Highlight “OK” and press **ENTER** to close.

Time Setup

The Time Setup Page allows you to set the correct time for your geographic location.

To use the Time Setup feature:

1. Access the Time Setup Page.
2. Highlight the Time Format field and press **ENTER** to choose from 12 or 24 (Military Time) hour formats.
3. Highlight the Time Zone field and press **ENTER** to choose the correct zone for your location. If you selected "Other," you must enter the correct Universal Time Coordinate for your location. Refer the UTC Chart on page 75.
4. Daylight Savings Time offers choices of "Yes," "No" and "Auto."

Units Setup

The Units Setup Page allows you to select the units of measurement for your eTrex Legend C.

To use the Units Setup feature:

1. Access the Units Setup Page.
2. Use the **ROCKER** and **ENTER** keys to highlight the various units fields and select the desired units from the lists displayed.

For more information about selecting Position Formats and Map Datums, refer to page 76 in the Appendix.

Time Setup

Time

Time Setup

Time Format
12 Hour

Time Zone
US - Central

UTC Offset
-06hrs 00min

Daylight Saving Time
Auto

04:42:32^{PM} 19-APR-04

US - Alaska
US - Atlantic
US - Central
US - Eastern
US - Hawaii
US - Mountain
US - Pacific
Other

12 Hour
24 Hour

To set the UTC Offset for "Other" Time Zones, see page 75.

Yes
No
Auto

Time Zone Options

Units Setup

Units

Units Setup

Position Format
hddd°mm.mmm'

Map Datum
WGS 84

Distance/Speed
Statute

Elevation/Vert. Speed
Feet

There are Options Menus for each data field.

Heading Setup

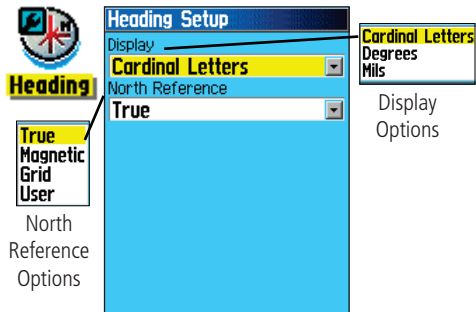

Heading Setup

The Heading Setup Page allows you to specify the type of heading display and the type of North Reference used to calculate your heading. Unless you have a working knowledge of Headings and North Referencing, it is recommended that you use the default values.

To use the Heading Setup feature:

1. Access the Heading Setup Page.
2. Highlight the Display field, press **ENTER** and select from Cardinal Letters, Degrees or Mils to display the heading value.
3. Highlight the North Reference field, press **ENTER** and select from True North, Magnetic North, Grid North, or User Grid North.

Welcome Page Setup

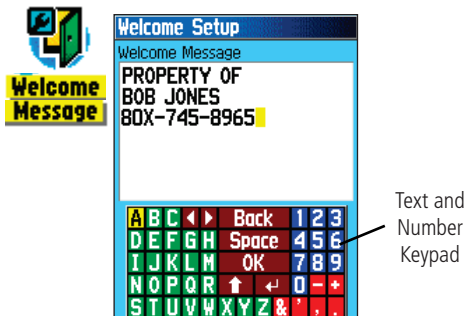

Welcome Page Setup

The Welcome Page Setup Page allows you to insert a message on the Welcome Page (the first page to display when you turn the unit on).

1. Access the Welcome Page Setup Page.
2. Use the keypad at the base of the screen to enter your welcome message. Use the **ROCKER** key to move between characters and press **ENTER** to select them.
3. When finished, highlight "OK" on the keypad and press **ENTER** to close.

Proximity Waypoints

The Proximity Waypoints Page allows you to establish waypoints that have alarm circles around them at specified distances. The alarm helps you avoid locations that are restricted or hazardous.

To use the Proximity Waypoint feature:

1. Access the Proximity Waypoints Page from the Main Menu by highlighting the Proximity icon and pressing **ENTER**.
2. With the Name field highlighted, press **ENTER** to display the Find Menu. (See page 21 for details on using the Find Feature.)
3. Select a waypoint from the Waypoints List or from any other group of map points and press **ENTER** to display the Information Page for that item.
4. Highlight the "Use" button at the bottom of the page and press **ENTER** to place the point in the list on the Proximity Waypoints Page.
5. Next use the **ROCKER** key to highlight the Radius field if you want to enter a value different than the default of 1 mile.
6. Highlight the "Proximity Alarms" check box and press **ENTER** to activate the alarm feature. When you trigger an alarm, a tone will sound and a "Near Proximity Point" message appears. When you move outside the set radius, a "Leaving Proximity Point" message appears.
7. To remove or review a single entry, press **ENTER**. To remove all waypoints from the list, press **MENU** and choose "Remove All."

Proximity Waypoints

Proximity

Proximity Waypoints	Radius
TABLE ROCK	81.00 ^m
FRISCO LAKE	51.00 ^m

Review Remove

Use the ENTER key to Review or Remove an entry.

Proximity Waypoints List

Menu
Remove All
MENU for Main Menu

Press the Menu key to Clear the Entire List

Waypoint
FRISCO LAKE
Note 19-APR-04 11:20:44AM
Location N 38°51.338' W 094°47.930'
Elevation 1088 ^{ft}
From Current Location NW 7 ^{ft}
Delete Map Use

Selected Waypoint

eTrex Legend C

GPS Features

Calendar



Calendar

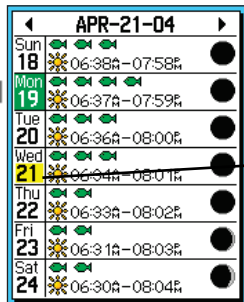

Calendar: Week Format



New Location
Options

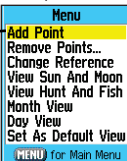

Options
Menu

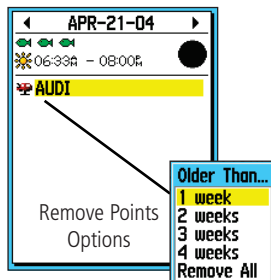

Calendar: Day Format

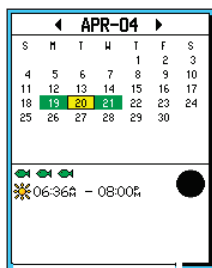

Calendar: Month Format

Marked waypoints are automatically added to the Calendar.

Calendar

The Calendar allows you to view the following for any given day and location: Sunrise/Sunset times, moon phase, Hunt and Fish probabilities, archived waypoints for activities you want to navigate to and a day, week or month format display.

To use the Calendar feature:

1. Access the Calendar from the Main Menu. The current week is displayed.
2. Use the **ROCKER** key to highlight the day you want. To add waypoints, press **ENTER** to display the Page for that day.
3. Press the **MENU** key to display the Options Menu. Highlight "Add Point" and press **ENTER** to display the Find Feature Menu.
4. Select the type of point you want to place on the Day Page. (See page 21 for details on using the Find Feature.) With the Information Page for that point displayed, highlight the "Use" button and press **ENTER** to place the point reference on the Day Page.
5. To remove points from a Day Page press **MENU** to display the Options Menu. Select "Remove Points" and press **ENTER** to display the Remove Points Options List.
6. To view other calendar formats, Sun and Moon or Hunt and Fish data for a specific date and location, press the **MENU** key and use the **ROCKER** key to make your choice.

Alarm Clock

The Alarm Clock Feature allows you to use your eTrex Legend C as an alarm clock. You can choose from different alarm tones, and use the “Snooze” feature to delay the alarm for an additional seven minutes.

To set the Alarm Clock:

1. Access the Alarm Clock from the Main Menu.
2. Highlight the Alarm Time field and press **ENTER** to display the Number Keypad and set the desired alarm time.
3. Highlight the Alarm Mode field and press **ENTER** to display the On/Off switch.
4. Highlight the Alarm Beep field and select the type of alarm tone desired.

When you turn the alarm On, an “Alarm Set” message appears and allows you to turn the unit Off. When the “Set Time” arrives, the unit switches On and the alarm beeps. Press any key to silence the alarm.

Calculator

The Calculator Feature allows you to use your eTrex Legend C as a calculator. You can select either a Standard or Scientific calculator and you can choose from degrees or radians using the Options Menu.

To use the Calculator:

1. Access the Calculator from the Main Menu.
2. Use the **ROCKER** and **ENTER** keys to operate the calculator.

Alarm Clock



Calculator

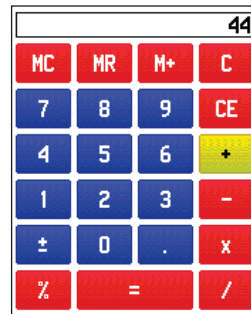
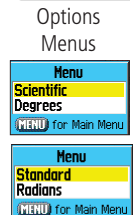

eTrex Legend C GPS Features



Stopwatch

Laps 0	Lap Distance 0.0
Last Lap 00:00:00	Current Lap 00:00:00
Time 00:00:00	
Total Lap 00:00:00	Avg Lap 00:00:00
Start	
Reset	

Stopwatch Page

Lap Distance Setup	
Lap Distance	
1.0	mi
Enter the distance at which you want the stopwatch lap to be triggered. You may also change this setting by pressing the lap button after traveling the desired distance.	
OK	

Setting Lap By Distance

Menu
Lap by Distance
Set Lap Distance
MENU for Main Menu

Lap Options
Menu

Stopwatch

This feature allows you to use the eTrex Legend C as a stopwatch, which includes a lap timer. You can choose to have the unit record the lap time based on distance.

To start the stopwatch:

Use the **ROCKER** key to highlight the "Start" field and then press **ENTER**.

To stop the stopwatch:

Use the **ROCKER** key to highlight the "Stop" field and press **ENTER**.

To use the lap feature:

With the stopwatch running, use the **ROCKER** key to highlight the "Lap" field and then press **ENTER**.

To reset the stopwatch:

With the stopwatch stopped, use the **ROCKER** key to highlight the "Reset" field and then press **ENTER**.

To time lap by distance:

Use the **ROCKER** key to highlight the Options Menu and then press **ENTER**. Choose "Lap by Distance" and press **ENTER**. To return to "Lap by Button Press," repeat these same steps.

To set a lap distance value:

1. Use the **ROCKER** key to highlight the Options Menu and then press **ENTER**. Choose "Set Lap Distance" and press **ENTER**.
2. Use the **ROCKER** key to highlight the field you wish to change and then press **ENTER**. Enter the new value and press **ENTER**.

Sun and Moon

The Sun and Moon Tables provide you with a graphic depiction of the sun and moon relative to the Earth. Sun and moon positions can be displayed for any time, date and location on Earth.

The Sun and Moon Page also displays sunrise, sunset, moonrise and moonset times for the selected time, date and location. On-screen buttons allow you to animate the movement of the sun and moon and stop at a given time/date. The button to the left animates the display of the sun and moon. The center button animates more rapidly, showing the phases of the moon. The right button stops animation.

To display sun and moon positions:

1. Access the Sun and Moon Page from the Main Menu.
2. To view the predictions for a different date and time, highlight those fields and press **ENTER** to display the Number Keypad.
3. To view the predictions for a different location, highlight the Location field and press **ENTER** to display the "New Location" options menu and choose from the options shown.

Sun and Moon Tables

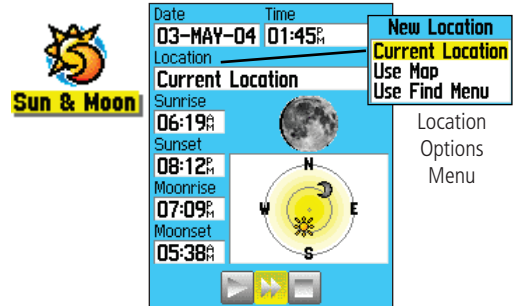

eTrex Legend C

GPS Features

Hunt and Fish Tables



Hunt & Fish

Date	21-APR-04
Location	Current Location
Prediction	Good Day
Best Times	01:11 ^A — 03:11 ^A 01:42 ^P — 03:42 ^P
Good Times	07:22 ^A — 08:22 ^A 07:53 ^P — 08:53 ^P

Hunt and Fish Page

New Location
Current Location
Use Map
Use Find Menu

Location Options Menu

Menu
Use Current Date
MENU for Main Menu

Page Options Menu

Hunt and Fish

The Hunt and Fish Tables provide you with a listing of predicted best times for hunting and fishing for a chosen date and location.

To display hunting and fishing predictions:

1. Access the Hunt and Fish Page from the Main Menu. The current date and location are displayed in the date and location fields at the top of the page.
2. To view the predictions for a different date, highlight the Date field and press **ENTER** to display the Number Keypad.
3. To view the predictions for a different location, highlight the Location field and press **ENTER** to display the "New Location" options menu.

Choose "Use Map" to select a point on the map using the Panning Arrow. Then press **ENTER** to display the table for that location. The Location field now states "Map Location."

Choose "Use Find Menu" to select a point from the Find Feature database. Follow instructions for using the Find Feature beginning on page 21. When a find item has been selected, highlight the "Use" button at the bottom of the item information page and press **ENTER**. The Location field now displays the name of the find item.

4. To return to the current date, press **MENU** and then **ENTER**.

Games

The eTrex Legend C provides games as an entertainment feature. Several of these games employ GPS.

To select and play a game:

1. Access the Main Menu and use the **ROCKER** key to select the Games icon.
2. Use the **ROCKER** key to highlight the desired game and press **ENTER** to display a brief description prompt for the game.

Memory Race

This is a GPS virtual game where the playing piece moves where you move. To win the Memory Race, remember which square has which symbol then clear the board by matching all of the two symbol sets together. Travel to each square, highlight "Open" at the bottom of the screen and press **ENTER** to view the symbol. Press the **QUIT** key to stop play.

To adjust the Grid or Square Size in custom mode:

1. Highlight the "Grid Size" or "Square Size" field and press **ENTER** to select from the options lists. Press **ENTER** to make your selection.
2. Highlight "Start" and press **ENTER** to begin the game.
3. Highlight "Re-Center" and press **ENTER** to place yourself back in the middle of the game board.

GPS Enhanced Games

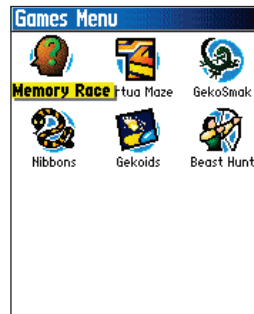

Memory Race

Game Board

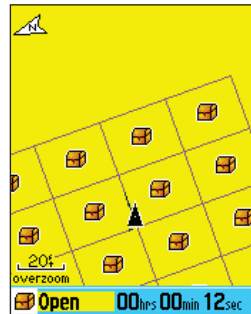

MEMORY RACE:
Be the first to clear the board by matching symbols.
Press enter to open the square you are in.
OK

Game Prompt



Game Settings

Unopened Symbol



Opened Symbol



GPS Enhanced Games

Virtua Maze

Virtua Maze:
Find All The Flags In
The Maze.

OK

00:01:03 16

Virtua Maze

Maze Size
Medium

Difficulty
Normal

Best times
23:59:59

Start

Move To The Geko And
Press Enter

OK

GekoSmak

Field Size
Medium

Difficulty
Easy

Orient Map
Ahead

High score
0

Start

0 0% 1

Virtua Maze

This GPS game creates a virtual maze on the screen. You are placed at a central position in the maze and must explore the maze collecting flags. The lower right corner of the screen tells you how many flags remain. The lower left corner displays the elapsed time. The Difficulty Level determines how much of the maze you can see at one time. Viewing less of the maze makes the game more difficult.

HINT: Pressing the **ENTER** key and selecting “Cheat On” enables a “cheat mode.” Enabling this mode penalizes you by five minutes and count seconds by 10 instead of 2. Turn the cheat mode Off by pressing the **ENTER** key.

Geko Smak

Geko Smak is a GPS-based game that features you as the player piece. In measured rhythm, Gekos appears on the screen. Before the Geko disappears, move toward the Geko and press the **ENTER** key to smack the Geko with a hammer. If you get the Geko, an “!” mark displays above the hammer. If not, just a hammer displays momentarily.

Field size choices are small, medium and large. Small fields are roughly 20 yards by 30 yards and large fields are 60 yards by 90 yards (about the size of an American football field).

The difficulty levels are Easy, Normal and Hard. These levels determine how often Gekos appear. The pace quickens and values vary as difficulty levels increase.

Nibbons

In this GPS game, you must walk around the board collecting the flags as they appear. As you walk, your “tail” grows. You may travel anywhere on the screen but you cannot walk on your tail, or you lose a life. As an added challenge, you must also avoid the Skulls that chase after you.

Gekoids

This GPS game, which can be played without GPS on, is all about blasting gekoids. The catch is, you are the ship and you can survive only when you avoid getting hit. Before you begin to play, make certain to make your game settings. Orient Map “Northwards” rotates your ship in the center of the map. The map is stationary and north is always up. Orient Map “Ship Up” rotates the virtual world around your ship. Your ship always points Up.

Press the **ENTER** key to start and blast away!

IMPORTANT WARNING: When playing any of the virtual games (where you are moving about on a real playing field), use reasonable and prudent caution in selecting an area free of hazards such as holes, obstructions or proximity to vehicular traffic. Playing these games may distract your attention from observing objects in your path.

GPS Enhanced Games

Nibbons

Nibbons:
Gather The Numbers
But Do Not Cross Your
Track.
OK

Nibbons
Field Size
Small
Difficulty
Normal
High score
0
Start

0 3

Gekoids

Destroy All Meteors But
Don't Get Hit
OK

Gekoids
Field Size
Small
Location
Indoors
Orient Map
Northwards
High score
5
Start

5 3

eTrex Legend C

GPS Features

Non-Enhanced Game



Beast Hunt

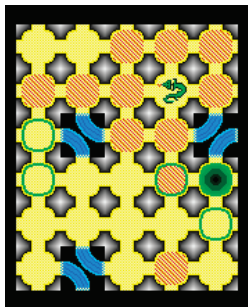

BEAST HUNT:
Find the beast before the beast finds you, and be careful of the pits.
Press MENU during the game for more help or to quit.
OK

Difficulty Level
Trainee
Beginner
Expert
Master

Visibility
Extended
Limited

Game Symbols



Player



Pit Warning



Dragon Near



Pit



Dragon



Aim Arrow

Scoreboard	
Trainee	0
Beginner	0
Expert	0
Master	0
Losses	13
Last Game Time:	
00hrs:00min:50sec	

Beast Hunt

Although not a true GPS game, Beast Hunt requires some navigation skills. You must find and defeat the dragon with an arrow before it breathes fire at you or you fall into one of the pits while navigating a maze of platforms. At times you are transported to the next platform by slides that curve or move you diagonally. The game consists of several difficulty levels and an extended or limited visibility option. When you lose a game the screen displays the hazards, slides and warning platforms. A scoreboard keeps track of your wins and losses.

To play Beast Hunt:

1. Select "Beast Hunt" from the Games Menu and press **ENTER** to display the game prompt window.
2. Read the prompt and then press **ENTER** to display the Difficulty Options window. Make your choice and press **ENTER** to display Visibility Options.
3. Make a selection and press **ENTER** to begin the game.
4. Use the **ROCKER** key to jump from platform to platform.

When you land on a shaded platform, you are one or two steps from the dragon, a platform with a circle is next to a pit. If you fall into a pit you lose. If you jump into the dragon you will lose, if you shoot an arrow at where you think the dragon is and miss, you lose.

To defeat the dragon, use **ENTER** to place an arrow in a shaded platform. Use the **ROCKER** key to point and **ENTER** to shoot. Hit the dragon and you win!

Accessories *(Included with the Unit)*

Wrist Strap - Provides convenient method for carrying the unit.

USB Interface Cable - Provides connection to a PC for data transfer and auxiliary power. Includes MapSource Trip and Waypoint Manager CD-ROM with USB Drivers.

Owner's Manual - Start up instructions and detailed operation reference.

Quick Start Guide - Abbreviated overview of unit operation and reference.

Auxiliary Mount Adapter - Attaches to the Battery Cover to allow connection to any of the Mounting Kits in the list below and shown on the following page.

Note: Refer to the list of accessories on the unit packaging.

Optional Accessories *(Not included with the Unit)*

Belt Clip - Attaches to the back of the unit and clips to belt or waistband.

Belt Clip with Carabiner - Same as above but includes a carabiner. *(Not shown)*

Cigarette Lighter Adapter - Provides power from an automobile cigarette lighter.

MapSource CD-ROMs - Allows transfer of detailed map data. *(Not shown)*

Carrying Case - Provides protection during transport of the unit. *(Not shown)*

Auto Mount Kit - Allows installation on a vehicle dash.

Marine Mount Kit - Allows installation on a boat.

Suction Mount Kit - Allows installation on a vehicle windshield.

Bicycle Mount Kit - Allows installation on bicycle handlebar.

Note: The Mount Kits listed above are supplied with a battery cover and mounting adapter designed for use with eTrex units without color displays. The battery cover for the color display series is slightly larger and uses the mounting adapter provided with the unit (see installation instructions on the following page). Discard the battery cover with mounting adapter provided in the mount kit, unless you also have an eTrex with a monochromatic display which accepts that battery cover.

Accessories



USB Interface Cable and MapSource Trip and Waypoint Manager CD-ROM with USB Drivers
(Install drivers before connecting USB Cable)



Belt Clip Assembly

Auxiliary Mount Adapter



Cigarette Lighter Adapter

CAUTION: Garmin Accessories have been designed and tested specifically for use with Garmin products. Accessories offered for sale by other manufacturers have not necessarily been tested or approved by Garmin for use with Garmin Products. Use of such accessories might cause damage to your Garmin Product and void the terms of the warranty. Using Garmin Accessories with other manufacturer's products is not recommended.

See your Garmin Dealer or website for availability.

Installing the Belt Clip, Mounting Adapter and Carry Lanyard

Accessories



Suction Mount Kit



Auto Dash Mount Kit



Marine Mount Kit



Bicycle Mount Kit

(Press tab to
release the Clip
Knob)



Belt Clip Knob
(attaches to back of unit)

Belt Clip
(attaches to belt or waistband)



Wrist Strap Installation

Back of eTrex Legend C

USB Power/Data Connector
(under weather cover)



Auxiliary Mount Adapter
(Do not discard -attaches to back of unit
for connection to the mounting kits shown
to the left)

PHYSICAL

Case:	Rugged, fully gasketed, water resistant, IEC-60529 IPX7 (Submersible 1 meter @ 30 minutes)
Size:	4.2" H x 2.2" W x 1.2" D
Weight:	5.6 ounces (159 g) with batteries
Display:	1.3" W x 1.7" H, 256-color, high resolution, transreflective TFT (176 x 220 pixels) Backlit
Antenna:	Built-in patch
Keypad:	Six multifunction keys
Operating Range:	5 to 158°F (-15 to 70°C) ¹

PERFORMANCE

Receiver:	WAAS enabled, 12 parallel channel
Acquisition Time:	Warm: Approximately 15 seconds Cold: Approximately 45 seconds AutoLocate™: Approximately 2 minutes
Update Rate:	Once per second, continuous
GPS Accuracy	
Position:	< 15 meters (49 feet), 95% typical ²
Velocity:	0.05 meter/sec steady state

Specifications



eTrex Legend C

Specifications

DGPS Accuracy

Position: 3-5 meters (10-16 feet), 95% typical

Velocity: 0.05 meter/sec steady state

Dynamics: Performs to specifications to 6 g's

Interfaces: Garmin Proprietary (USB)

Data Storage Life: Indefinite: no memory battery required

Map Storage: Internal; approximately 24 MB

POWER

Source: Two 1.5 volt AA batteries or 12 V Adapter Cable

Battery Life: Up to 36 hours (typical use)³

Specifications subject to change without notice.

1. The temperature rating of the eTrex Legend C may exceed the usable range of some batteries. Some batteries can rupture at high temperatures.
2. Subject to accuracy degradation to 100m 2DRMS under the U.S. DoD imposed Selective Availability (SA) Program.
3. Alkaline batteries lose a significant amount of their capacity as the temperature decreases. Use Lithium batteries when operating the eTrex Legend C in below-freezing conditions. Extensive use of screen backlighting and audible tones significantly reduce battery life.

Data Field Options

The following list provides a brief description of each data field option. Some of these options are supported only by devices interfaced to your eTrex Legend C.

Accuracy GPS - The current accuracy of your GPS determined location.

Bearing - The compass direction from your current position to a destination point.

Course - The desired path of travel from your starting point to your destination point.

Depth - The depth of water from sonar NMEA input.

Distance - Next - The distance to the next point on a route.

Distance - Destination - The entire distance, from beginning to end, of a route.

ETA - Next - The estimated time of arrival at the next point on your route, if you maintain your current speed and course.

ETA - Destination - The estimated time of arrival at your destination, if you maintain your current speed and course.

Elevation - The distance above or below mean sea level.

Glide Ratio - The ratio of horizontal distance traveled to vertical distance.

Data Field Options

Glide Ratio Dest - The glide ratio required to descend from your present position and elevation to the destination's elevation.

Heading - Your direction of travel as indicated by a compass, in degrees or cardinal letters (N,S,E,W).

Location (lat/lon) - Your current location as latitude/longitude coordinates.

Location (selected) - Your current location described in the selected units of measure (other than lat/lon).

Odometer - The total distance you have traveled for all trips.

Off Course - The distance off your direct course line, right or left.

Pointer - The arrow that indicates the direction to travel to the next point on a route.

Speed - Your current vehicle speed can be measured in miles per hour, kilometers per hour or knots.

Speed - Maximum - The maximum speed you have attained since the Trip Computer was reset.

Speed - Moving Avg. - The average speed while your vehicle was moving.

Speed - Overall Avg. - The average speed determined by both the moving and stopped time and speed.

Data Field Options

Sunrise - The time of sunrise for the current date and location.

Sunset - The time of sunset for the current date and location.

Time To Destination - The estimated time enroute to your final destination, if you maintain your current speed and course.

Time To Next - The estimated time enroute to the next point on your route, if you maintain your current speed and course.

Time of Day - The current time and date. It can be displayed in 12 or 24 hour format in local time or universal (UTC) time.

To Course - Your direction of travel to get back on course.

Trip Odometer - The running total of distance traveled since the Trip Computer was reset.

Trip Time - Moving - The length of time your vehicle has been in motion, since the Trip Computer was reset.

Trip Time - Stopped - The length of time that the vehicle has been stopped (stationary) while the unit was powered On and tracking your location (since the Trip Computer was reset).

Trip Time - Total - The total time the unit has been tracking since the Trip Computer was reset.

Turn - The direction of, and distance to, the next turn on an active route.

Data Field Options

Velocity Made Good - The rate of closure on a destination based upon your current speed and course of travel.

Vertical Speed - The rate of altitude gain/loss over time.

Vertical Speed Dest - The measurement of your rate of ascent to a predetermined height.

Water Speed - The data acquired from measurement devices interfaced to the eTrex Legend C is used to calculate your current speed over water.

Water Temperature - The temperature of water at a measured depth using measurement devices interfaced to the eTrex Legend C.

Waypoint - Destination - The last point on a route, your destination.

Waypoint - Next - The next point on your route.

Interfacing the eTrex Legend C

The eTrex Legend C is provided with interface connection to a PC using the USB connector cable provided with the unit. Connection to your computer is necessary for downloading of detailed map from Garmin MapSource Map Data CDs. You can also save routes, waypoints, and tracks from the eTrex Legend C to MapSource. Refer to the MapSource User's Guide provided with your MapSource CDs.

Before you begin communication between your PC and the eTrex Legend C you must install the USB drivers contained in the MapSource Trip and Waypoint Manager CD-ROM. Follow the installation instructions provided with the CD-ROM and install the USB drivers.

To connect to your computer using the USB connector:

1. Install the MapSource Trip and Waypoint Manager CD-ROM provided with your eTrex Legend C on your PC. USB drivers, required for USB interfacing to the eTrex Legend C are installed when you run the CD-ROM. Do not connect the USB cable until these drivers have been installed (see note on page 3).
2. Lift the USB protective cover from the back of the eTrex Legend C and insert the smaller connector on the USB cable into the matching port.
3. Connect the remaining cable end to your PC USB port.

When connected to a PC, the USB cable provides auxiliary power to the eTrex Legend C to conserve batteries.

Connecting the eTrex Legend C to a Computer



Downloading MapSource Map Data



Garmin MapSource

CD-ROM's offer a variety of detailed mapping data and navigation information.

MapSource is also an excellent medium for storage and safety backup of Personal Waypoints, Routes and Saved Tracks.

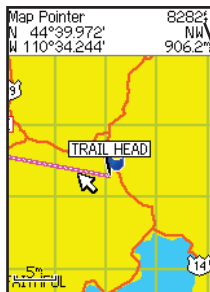

Garmin MapSource
U.S. Topo 24K
Digital Elevation Models
(DEM) Maps
provide elevation data
at any point identified by the
Panning Arrow

See your Garmin Dealer or visit the
Garmin web site at www.garmin.com
for information on which maps work with the
eTrex Legend C.

Transferring MapSource Map Data

If you have purchased a Garmin MapSource CD-ROM mapping program you may want to transfer detailed map data before beginning use to provide your unit with maximum Find features and mapping capability. The eTrex Legend C accepts up to 24 MB of map data from most MapSource products. It is not possible to transfer 3rd party maps into Garmin products.

You cannot view multiple types of MapSource data in the same location at the same time (one displays over the other). When you leave a MetroGuide area for example and enter the area of a topographic map, the display will change to contour lines. The same is true when moving from a topo map to a MetroGuide map.

Maps that are at the top of the hierarchy and display over any other map information. Because new maps are constantly being released, consult your Garmin Dealer or the Garmin website to determine the order of hierarchy.

Map data transfer requires the use of a PC, a Garmin MapSource CD-ROM, and the Universal Service Bus (USB) cable supplied with this unit. Follow detailed instructions for data transfer in the MapSource User's Manual. Note that downloading maps overwrites any maps already downloaded to the unit. This includes the Marine Points of Interest database provided with the eTrex Legend C.

It is also important to note that certain features contained in the eTrex Legend C is not enabled unless you are using mapping data they are designed to support, such as many of the Find Features and DEM Elevation Profiles. Visit the Garmin website for details on all of the maps you can use with the eTrex Legend C.

This chart is provided to help you determine the time offset settings for your current location if it is not in one of the time zones listed on the Time Setup Page. To change the UTC Offset, access the Main Menu, then Setup and then open the Time Setup Page. Highlight the Time Zone field and press the **ENTER** to display the list of time zones. If the desired zone is not displayed, select "Other." Highlight the UTC Offset field and press **ENTER** to enter the appropriate offset value from the chart below. To determine your longitudinal zone, press and hold the **ENTER** key and observe the longitude value in the Mark Waypoint Location field. It should fall within the sets of values on the chart. Press the **QUIT** key to avoid marking a waypoint.

UTC Offset Chart

Longitudinal Zone	Offset
W180.0° to W172.5°	-12.00
W172.5° to W157.5°	-11.00
W157.5° to W142.5°	-10.00
W142.5° to W127.5°	-09.00
W127.5° to W112.5°	-08.00
W112.5° to W097.5°	-07.00
W097.5° to W082.5°	-06.00
W082.5° to W067.5°	-05.00
W067.5° to W052.5°	-04.00
W052.5° to W037.5°	-03.00
W037.5° to W022.5°	-02.00
W022.5° to W007.5°	-01.00
W007.5° to E007.5°	-00.00

Longitudinal Zone	Offset
E007.5° to E022.5°	+01.00
E022.5° to E037.5°	+02.00
E052.5° to E067.5°	+03.00
E067.5° to E082.5°	+04.00
E082.5° to E097.5°	+05.00
E097.5° to E112.5°	+06.00
E112.5° to E122.5°	+07.00
E122.5° to E127.5°	+08.00
E127.5° to E142.5°	+09.00
E142.5° to E157.5°	+10.00
E157.5° to E172.5°	+11.00
E172.5° to E180.5°	+12.00

Map Datums and Position Formats

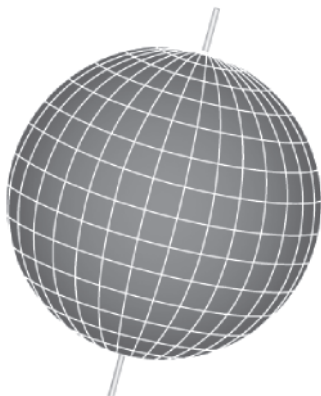

Map Datums are based on a mathematical model of the Earth.

```
hhdd.ddddd°  
hhdd°mm.mmm'  
hhdd°mm.ss.s"  
British Grid  
Dutch Grid  
Finnish Grid  
German Grid  
India Zone 0  
India Zone IA  
India Zone IB  
India Zone IIA  
India Zone IIB  
India Zone IIA  
India Zone IIB
```

Position
Formats

```
Aridan  
Afgooye  
AIN EL ABD '70  
Anna 1 Ast '65  
ARC 1950  
ARC 1960  
Ascnsn Isl'd '58  
Astro B4 Sorol  
Astro Bcn "E"  
Astr Dos 71/4  
Astro Stn '52  
Aus Geod '66  
Aus Geod '84  
Austria
```

Map Datums

What are Map Datums, and which should I use?

A datum is a mathematical model of the Earth which approximates the shape of the Earth and enables calculations to be carried out in a consistent and accurate manner. The datum is physically represented by a framework of ground monuments (i.e. trig. stations) whose positions have been accurately measured and calculated on this reference surface. Lines of latitude and longitude on a map or chart are referenced to a specific map datum. Every chart has a map datum reference and the eTrex Legend C can be set to match most of those commonly used.

If you are navigating and comparing the GPS coordinates to a map, chart or other reference, the map datum in the GPS unit should be set to the same datum as the map or chart to ensure the most accurate navigation.

What is a Position Format, and which should I use?

Your current location can be viewed on the GPS in the form of coordinates. Since different maps and charts use different location formats, Garmin GPS units allow you to choose the correct coordinate system for the type of map you are using. The most common format is latitude and longitude, which is utilized by all Garmin units. On most models, you may choose to change the position format to use with other coordinate systems. UTM/UPS (Universal Transverse Mercator/Universal Polar Stereographic) are easy-to-use metric grids that are found on most USGS topographic quadrangle maps. Several other grids, including a user-definable grid (for the advanced user), may also be selected.

To set up Loran TD from the Setup Menu:

1. Press the **MENU** key twice to display the Main Menu, then press again to display the Setup Menu.
2. Use the **ROCKER** key to highlight the Units icon and press **ENTER** to display the Units Setup Page.
3. Highlight the “Position Format” field and press **ENTER** to display the format list.
4. Highlight “Loran TD” press **ENTER** to display the Loran Setup Page.
5. To change the settings of any of the five fields, highlight the field, press **ENTER** select/enter the desired setting, then press **ENTER**.
6. When done, highlight the “Save” button and press **ENTER**.

If the active GRI Chain, secondary stations, or offsets have been changed since the waypoint was created, the waypoint will now reference the active GRI-chain and secondary stations and adjust the TD coordinates accordingly. Remember that the eTrex Legend C is not relying on the LORAN signal for navigation and actually converts the TD coordinate to a useful LAT/LON coordinate before storing the waypoint to memory or using it for navigation. Because of this, the unit can navigate to a TD coordinate anywhere in the world.

You must know your GRI chain number and secondary stations to create a LORAN TD position. For more information please read our LORAN TD Position Format Handbook, available at the Garmin Web site, at www.garmin.com/support/userManual.html.

Loran TD Setup

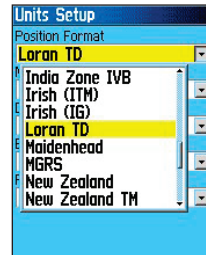

Units Setup Page

(Position Format List with Loran TD selected.)

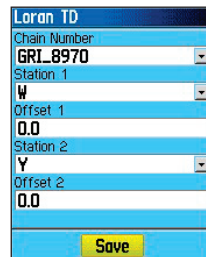

Loran TD Setup Page

WAAS

What is WAAS?

The Wide Area Augmentation System (WAAS) is an F.A.A. funded project to improve the overall integrity of the GPS signal. It is a space-based system that broadcasts integrity information and correction data as determined by ground reference stations (see DGPS below). At this time the system is still in the developmental stage with a goal of providing reliable signals with an accuracy of 7 meters (21-22 ft.) both horizontally and vertically 95% of the time. Current tests have shown the actual accuracy to be on the order of 2-3 meters. For more information, go to <http://gps.faa.gov/Programs/WAAS/waas.htm>.

Index

A

Accessories 65
Accuracy Circle 9
Activate a Route 40
Alarm Clock 58
Arrow, Panning 9
AutoZoom 49

B

Backlight Timeout 7, 46
Backlighting On/Off 7, 46
Battery Level Indicator 7
Battery Saver Mode 46
Battery Type 46
Bearing Pointer 14
Big Numbers 33

C

Calculator Page 58
Calendar Page 57
Cautions iv-vi
Cities, By Name 27
Cities, Nearest 27
Compass Page 14
Compass Ring 14
Course Pointer 15
Custom Waypoint Symbols 16

D

Data Fields 11, 15, 43, 44
Data Field Definitions 69
Date and Time Setup 53, 75
Detail, Map 49
Display Mode 46
Display Setup 46

E

Elevation 11, 22, 33, 44
Exit Services 28
Exits 28
Exits, Nearest 28

F

Fields, Data 11, 17, 43, 44
Find Address 29
Find Cities 27
Find Exits 28
Find Geocache 26
Find Intersections 30
Find Points of Interest 31
Find Waypoints 25

G

Games 61-64
Geocache Setup 52
Global Positioning System (GPS) 4
Go To 5, 22

H

Heading Setup 54
Highway Page 44
Hunt and Fish Tables 60

I

Initialization 4

K

Key Functions 2

L

Location (Marking) 16-17
Loading Map Data 74
Lock On Road 49
Loran TD Setup 77

M

Main Menu Page 6, 32
Map Datums 53, 76
Map Display 8
Map Features 9

Map Page 8
Map Page Options 10
Map Page Panning 9
Map Scale 9
Map Setup 48
MapSource Map Data 8, 76
Marine Setup 52
Mark a Waypoint 16
Mark Waypoint Page 16
Measuring Distance 13
Microphone Sensitivity 8
MOB Feature 16
Moving a Route Waypoint 19

N

Nearest (Waypoints, Cities, Exits, etc.) 20
Normal Mode 45
North Reference 56
North Up 8, 49

O

Odometer 33
Offset (Time) 53, 75
Orient Map 49
Overall Average Speed 33

Index

P

Page Sequence Setup 47
Panning (Map) 9, 17
Position Format 54, 76
Projecting a Waypoint 20
Proximity Waypoints 55

R

Reset Trip Page 33
Routes 39-43
 Creating 39
 Copying 43
 Deleting 43
 Editing 43
 Navigating 43
 Reversing 41
Routing Setup 51

S

Satellite Page 4
Saving the Tracklog 35
Selecting a Page 2
Setup Menu 45
Show Data Fields 10
Show Map Only 10
Software Version (Operating) 45
Specifications 67
Stop Navigation 10, 15, 41

Stopwatch Page 58
Sun and Moon Tables 59
Symbol, Waypoint 16
Symbols, Status Bar 7
System Setup 45

T

Text Size 50
Time Format 53
Time Zone 53
Tones Setup 47
TracBack 35
Track Logs 34
Track Log Saving 35
Track Log Setup 34
Tracks Page 34
Track Up 8, 49
Trip Computer Page 33
Trip Odometer 33
Trip Time 33

U

Unit Features 3
Unit i.d. 45
Units of Measure 53
Units Page 53

User Waypoint Symbol 16
UTC Offset 53, 75

V

View Waypoints on Route 39, 43

W

WAAS, Enable/Disable 45
Warnings iv-vi
Warranty 81
Waypoints 16-19
 Deleting 18
 Editing 18
 List 25
 Marking 16
 Moving 19
 Naming 16
 Projecting 19
 Proximity 55
 Symbols 16
Welcome Page Setup 54

Z

Zooming In/Out 2, 9

Limited Warranty

This Garmin product is warranted to be free from defects in materials or workmanship for one year from the date of purchase. Within this period, Garmin will at its sole option, repair or replace any components that fail in normal use. Such repairs or replacement will be made at no charge to the customer for parts or labor, provided that the customer shall be responsible for any transportation cost. This warranty does not cover failures due to abuse, misuse, accident or unauthorized alteration or repairs.

THE WARRANTIES AND REMEDIES CONTAINED HEREIN ARE EXCLUSIVE AND IN LIEU OF ALL OTHER WARRANTIES EXPRESS OR IMPLIED OR STATUTORY, INCLUDING ANY LIABILITY ARISING UNDER ANY WARRANTY OF MERCHANTABILITY OR FITNESS FOR A PARTICULAR PURPOSE, STATUTORY OR OTHERWISE. THIS WARRANTY GIVES YOU SPECIFIC LEGAL RIGHTS, WHICH MAY VARY FROM STATE TO STATE.

IN NO EVENT SHALL GARMIN BE LIABLE FOR ANY INCIDENTAL, SPECIAL, INDIRECT OR CONSEQUENTIAL DAMAGES, WHETHER RESULTING FROM THE USE, MISUSE, OR INABILITY TO USE THIS PRODUCT OR FROM DEFECTS IN THE PRODUCT. Some states do not allow the exclusion of incidental or consequential damages, so the above limitations may not apply to you.

Garmin retains the exclusive right to repair or replace the unit or software or offer a full refund of the purchase price at its sole discretion. SUCH REMEDY SHALL BE YOUR SOLE AND EXCLUSIVE REMEDY FOR ANY BREACH OF WARRANTY.

To obtain warranty service, call your local Garmin authorized dealer. Or call Garmin Customer Service at one of the numbers listed below for shipping instructions and an RMA tracking number. The unit should be securely packed with the tracking number clearly written on the outside of the package. The unit should be sent, freight charges prepaid, to any Garmin warranty service station. A copy of the original sales receipt is required as the proof of purchase for warranty repairs.

Online auction confirmations are not accepted for warranty verification. To obtain warranty service, an original or copy of the sales receipt from the original retailer is required. Garmin will not replace missing components from any package purchased through an online auction.

Garmin International, Inc.
1200 E. 151st Street
Olathe, KS 66062, U.S.A.
Tel. 913/397.8200 or 800/800.1020
Fax 913/397.8282

www.garmin.com

Garmin (Europe) Ltd.
Unit 5, The Quadrangle, Abbey Park Industrial Estate
Romsey, SO51 9DL, U.K.
Tel. 44/0870.8501241
Fax 44/0870.8501251

**For the latest free software updates (excluding map data)
throughout the life of your Garmin products, visit the
Garmin web site at www.garmin.com**



© Copyright 2004 Garmin Ltd. or its subsidiaries

Garmin International, Inc.
1200 East 151st Street, Olathe, Kansas 66062, U.S.A.

Garmin (Europe) Ltd.
Unit 5, The Quadrangle, Abbey Park Industrial Estate, Romsey, SO51 9DL, U.K.

Garmin Corporation
No. 68, Jangshu 2nd Road, Shijr, Taipei County, Taiwan

www.garmin.com

Part Number 190-00365-00 Rev. B