

GARMIN 

G1000[®] Integrated Flight Deck Pilot's Guide



TBM850 by SOCATA

Copyright © 2007, 2009-2011 Garmin Ltd. or its subsidiaries. All rights reserved.

This manual reflects the operation of System Software version 0719.09 or later for the Socata TBM 850. Some differences in operation may be observed when comparing the information in this manual to earlier or later software versions.

Garmin International, Inc., 1200 East 151st Street, Olathe, Kansas 66062, U.S.A.
Tel: 913/397.8200 Fax: 913/397.8282

Garmin AT, Inc., 2345 Turner Road SE, Salem, OR 97302, U.S.A.
Tel: 503/391.3411 Fax: 503/364.2138

Garmin (Europe) Ltd, Liberty House, Bulls Copse Road, Hounslow Business Park, Southampton, SO40 9RB, U.K.
Tel: 44/0870.8501241 Fax: 44/0870.8501251

Garmin Corporation, No. 68, Jangshu 2nd Road, Shijr, Taipei County, Taiwan
Tel: 886/02.2642.9199 Fax: 886/02.2642.9099

For after-hours emergency, aircraft on ground (AOG) technical support for Garmin panel mount and integrated avionics systems, please contact Garmin's AOG Hotline at 913.397.0836.

Web Site Address: www.garmin.com

Except as expressly provided herein, no part of this manual may be reproduced, copied, transmitted, disseminated, downloaded or stored in any storage medium, for any purpose without the express written permission of Garmin. Garmin hereby grants permission to download a single copy of this manual and of any revision to this manual onto a hard drive or other electronic storage medium to be viewed for personal use, provided that such electronic or printed copy of this manual or revision must contain the complete text of this copyright notice and provided further that any unauthorized commercial distribution of this manual or any revision hereto is strictly prohibited.

Garmin® and G1000® are registered trademarks of Garmin Ltd. or its subsidiaries. WATCH®, FliteCharts®, and SafeTaxi® are trademarks of Garmin Ltd. or its subsidiaries. These trademarks may not be used without the express permission of Garmin.

NavData® is a registered trademark of Jeppesen, Inc.; Stormscope® is a registered trademark of L-3 Communications; and XM® is a registered trademark of SiriusXM Satellite Radio, Inc.; Honeywell® and Bendix/King® are registered trademarks of Honeywell International, Inc.; Becker® is a registered trademark of Becker Flugfunkwerk GmbH.

AOPA Membership Publications, Inc. and its related organizations (hereinafter collectively "AOPA") expressly disclaim all warranties, with respect to the AOPA information included in this data, express or implied, including, but not limited to, the implied warranties of merchantability and fitness for a particular purpose. The information is provided "as is" and AOPA does not warrant or make any representations regarding its accuracy, reliability, or otherwise. Under no circumstances including negligence, shall AOPA be liable for any incidental, special or consequential damages that result from the use or inability to use the software or related documentation, even if AOPA or an AOPA authorized representative has been advised of the possibility of such damages. User agrees not to sue AOPA and, to the maximum extent allowed by law, to release and hold harmless AOPA from any causes of action, claims or losses related to any actual or alleged inaccuracies in the information. Some jurisdictions do not allow the limitation or exclusion of implied warranties or liability for incidental or consequential damages so the above limitations or exclusions may not apply to you.

LIMITED WARRANTY

Within the warranty period, Garmin will, at its sole discretion, repair or replace any components that fail in normal use. Such repairs or replacement will be made at no charge to the customer for parts and/or labor incidental to the direct repair of said product. Garmin may, at its discretion with prior approval, reimburse an authorized Garmin Service Center for associated labor costs incurred for removal and replacement of the panel mount product installed in an aircraft. The customer shall be responsible for any transportation or other cost. This warranty does not apply to: (i) cosmetic damage, such as scratches, nicks and dents; (ii) consumable parts, such as batteries, unless product damage has occurred due to a defect in materials or workmanship; (iii) damage caused by accident, abuse, misuse, water, flood, fire, or other acts of nature or external causes; (iv) damage caused by service performed by anyone who is not an authorized service provider of Garmin; or (v) damage to a product that has been modified or altered without the written permission of Garmin. In addition, Garmin reserves the right to refuse warranty claims against products or services that are obtained and/or used in contravention of the laws of any country.

THE WARRANTIES AND REMEDIES CONTAINED HEREIN ARE EXCLUSIVE AND IN LIEU OF ALL OTHER WARRANTIES, WHETHER EXPRESS, IMPLIED OR STATUTORY, INCLUDING ANY LIABILITY ARISING UNDER ANY WARRANTY OF MERCHANTABILITY OR FITNESS FOR A PARTICULAR PURPOSE, STATUTORY OR OTHERWISE. THIS WARRANTY GIVES YOU SPECIFIC LEGAL RIGHTS, WHICH MAY VARY FROM STATE TO STATE.

IN NO EVENT SHALL GARMIN BE LIABLE FOR ANY INCIDENTAL, SPECIAL, INDIRECT OR CONSEQUENTIAL DAMAGES, WHETHER RESULTING FROM THE USE, MISUSE, OR INABILITY TO USE THIS PRODUCT OR FROM DEFECTS IN THE PRODUCT. Some states do not allow the exclusion of incidental or consequential damages, so the above limitations may not apply in every case.

Garmin retains the exclusive right to repair or replace (with a new or newly-overhauled replacement product) the product or offer a full refund of the purchase price at its sole discretion. SUCH REMEDY SHALL BE YOUR SOLE AND EXCLUSIVE REMEDY FOR ANY BREACH OF WARRANTY.

To obtain warranty service, contact your local Garmin Authorized Service Center. For assistance in locating the nearest Service Center, call Garmin Customer Service at one of the numbers listed below.

Products sold through online auctions are not eligible for warranty coverage or rebates or other special offers from Garmin. Online auction confirmations are not accepted for warranty verification. To obtain warranty service, an original or copy of the sales receipt from the original retailer is required. Garmin will not replace missing components from any package purchased through an online auction.

Garmin International Inc.
1200 East 151st Street, Olathe, Kansas 66062
Telephone: (913)397-8200
Telephone Toll Free: (888)606-5482
Facsimile: (913)397-8282
Facsimile Toll Free: (800)801-4670
E-mail: orders@garmin.com
avionics@garmin.com
warranty@garmin.com

Garmin (Europe) Ltd.
Liberty House, Bulls Copse Road, Southampton, SO40
9RB, UK
Telephone: ++44 (0) 870-8501243
Telephone Toll Free: ++44 (0) 0808 238 0000
(option 5)
Facsimile: ++44 (0) 238052004
E-mail: avionics.europe@garmin.com



WARNING: Navigation and terrain separation must NOT be predicated upon the use of the terrain avoidance feature. The terrain avoidance feature is NOT intended to be used as a primary reference for terrain avoidance and does not relieve the pilot from the responsibility of being aware of surroundings during flight. The terrain avoidance feature is only to be used as an aid for terrain avoidance. Terrain data is obtained from third party sources. Garmin is not able to independently verify the accuracy of the terrain data.



WARNING: The displayed minimum safe altitudes (MSAs) are only advisory in nature and should not be relied upon as the sole source of obstacle and terrain avoidance information. Always refer to current aeronautical charts for appropriate minimum clearance altitudes.



WARNING: The altitude calculated by G1000 GPS receivers is geometric height above Mean Sea Level and could vary significantly from the altitude displayed by pressure altimeters, such as the GDC 74B Air Data Computer, or other altimeters in the aircraft. GPS altitude should never be used for vertical navigation. Always use pressure altitude displayed by the G1000 PFD or other pressure altimeters in aircraft.



WARNING: Do not use outdated database information. Databases used in the G1000 system must be updated regularly in order to ensure that the information remains current. Pilots using any outdated database do so entirely at their own risk.



WARNING: Do not use basemap (land and water data) information for primary navigation. Basemap data is intended only to supplement other approved navigation data sources and should be considered as an aid to enhance situational awareness.



WARNING: Traffic information shown on system displays is provided as an aid in visually acquiring traffic. Pilots must maneuver the aircraft based only upon ATC guidance or positive visual acquisition of conflicting traffic.



WARNING: Use of the Stormscope is not intended for hazardous weather penetration (thunderstorm penetration). Stormscope information, as displayed on the G1000 MFD, is to be used only for weather avoidance, not penetration.





WARNING: Do not use datalink weather products (e.g., XM WX Satellite Weather, GFDS World Wide Weather, or FIS-B) for hazardous weather penetration. Weather information provided by these products is aged by up to several minutes and may not depict actual weather conditions as they currently appear.





WARNING: NEXRAD weather data is to be used for long-range planning purposes only. Due to inherent delays in data transmission and the relative age of the data, NEXRAD weather data should not be used for short-range weather avoidance.

 **WARNING:** *The Garmin G1000, as installed in the Socata TBM 850 aircraft, has a very high degree of functional integrity. However, the pilot must recognize that providing monitoring and/or self-test capability for all conceivable system failures is not practical. Although unlikely, it may be possible for erroneous operation to occur without a fault indication shown by the G1000. It is thus the responsibility of the pilot to detect such an occurrence by means of cross-checking with all redundant or correlated information available in the cockpit.*

 **WARNING:** *For safety reasons, G1000 operational procedures must be learned on the ground.*

 **WARNING:** *The United States government operates the Global Positioning System and is solely responsible for its accuracy and maintenance. The GPS system is subject to changes which could affect the accuracy and performance of all GPS equipment. Portions of the Garmin G1000 utilize GPS as a precision electronic NAVigation AID (NAVAID). Therefore, as with all NAVAIDs, information presented by the G1000 can be misused or misinterpreted and, therefore, become unsafe.*

 **WARNING:** *To reduce the risk of unsafe operation, carefully review and understand all aspects of the G1000 Pilot's Guide documentation and the Socata TBM 850 Airplane Flight Manual. Thoroughly practice basic operation prior to actual use. During flight operations, carefully compare indications from the G1000 to all available navigation sources, including the information from other NAVAIDs, visual sightings, charts, etc. For safety purposes, always resolve any discrepancies before continuing navigation.*

 **WARNING:** *The illustrations in this guide are only examples. Never use the G1000 to attempt to penetrate a thunderstorm. Both the FAA Advisory Circular, Subject: Thunderstorms, and the Aeronautical Information Manual (AIM) recommend avoiding "by at least 20 miles any thunderstorm identified as severe or giving an intense radar echo."*

 **WARNING:** *Lamp(s) inside this product may contain mercury (HG) and must be recycled or disposed of according to local, state, or federal laws. For more information, refer to our website at www.garmin.com/aboutGarmin/environment/disposal.jsp.*

 **WARNING:** *Because of variation in the earth's magnetic field, operating the system within the following areas could result in loss of reliable attitude and heading indications. North of 72° North latitude at all longitudes. South of 70° South latitude at all longitudes. North of 65° North latitude between longitude 75° W and 120° W. (Northern Canada). North of 70° North latitude between longitude 70° W and 128° W. (Northern Canada). North of 70° North latitude between longitude 85° E and 114° E. (Northern Russia). South of 55° South latitude between longitude 120° E and 165° E. (Region south of Australia and New Zealand).*



WARNING: Do not use GPS to navigate to any active waypoint identified as a 'NON WGS84 WPT' by a system message. 'NON WGS84 WPT' waypoints are derived from an unknown map reference datum that may be incompatible with the map reference datum used by GPS (known as WGS84) and may be positioned in error as displayed.



CAUTION: The PFD and MFD displays use a lens coated with a special anti-reflective coating that is very sensitive to skin oils, waxes, and abrasive cleaners. **CLEANERS CONTAINING AMMONIA WILL HARM THE ANTI-REFLECTIVE COATING.** It is very important to clean the lens using a clean, lint-free cloth and an eyeglass lens cleaner that is specified as safe for anti-reflective coatings.



CAUTION: The Garmin G1000 does not contain any user-serviceable parts. Repairs should only be made by an authorized Garmin service center. Unauthorized repairs or modifications could void both the warranty and the pilot's authority to operate this device under FAA/FCC regulations.



NOTE: All visual depictions contained within this document, including screen images of the G1000 panel and displays, are subject to change and may not reflect the most current G1000 system and aviation databases. Depictions of equipment may differ slightly from the actual equipment.



NOTE: This device complies with part 15 of the FCC Rules. Operation is subject to the following two conditions: (1) this device may not cause harmful interference, and (2) this device must accept any interference received, including interference that may cause undesired operation.



NOTE: The data contained in the terrain and obstacle databases comes from government agencies. Garmin accurately processes and cross-validates the data, but cannot guarantee the accuracy and completeness of the data.



NOTE: This product, its packaging, and its components contain chemicals known to the State of California to cause cancer, birth defects, or reproductive harm. This notice is being provided in accordance with California's Proposition 65. If you have any questions or would like additional information, please refer to our web site at www.garmin.com/prop65.



NOTE: Interference from GPS repeaters operating inside nearby hangars can cause an intermittent loss of attitude and heading displays while the aircraft is on the ground. Moving the aircraft more than 100 yards away from the source of the interference should alleviate the condition.



NOTE: Use of polarized eyewear may cause the flight displays to appear dim or blank.

BLANK PAGE

Record of Revisions				
Part Number	Revision	Date	Page Range	Description
190-00709-00	A	11/2/07	All	Initial release
190-00709-01	A	7/7/08	All	Added Synthetic Vision System and other GDU 9.02 parameters
190-00709-02	A	5/5/09	All	Added new page selection presentation Added import/export flight plans Added flight data logging Added other GDU 9.14 parameters.
	B	7/30/09	53	Corrected discussion of setting Selected Altitude
190-00709-03	A	4/10	All	Added GDU 11.01 parameters. Added GTS 820 Added AOPA Airport Directory Added dual navigation database capability Added database synchronization
	B	6/10	Page 7 Pages 411-413 Pages 106, 558 Page 579	Updated System Configuration Diagram Added Flight ID discussion for GTS 820 Traffic Page Added NG HI CAS message Added "Airspeed, Airspeed" and GTS 820 aural alerts
190-00709-04	A	10/11	All	Added Profile View Added Standby Navigation Database Added new database update procedures Added Iridium Satellite Telephone & SMS messaging Added GFDS Worldwide Weather Added WX LGND, LEGEND, and METAR softkeys Updated system messages Added other GDU 12.01 parameters

BLANK PAGE

SECTION 1 SYSTEM OVERVIEW	
1.1	System Description 1
1.2	Line Replaceable Units (LRU) 2
1.3	G1000 Controls 8
	PFD Controls 8
	Controls Associated With the MFD 10
	AFCS Controls 11
	Audio Panel Controls 13
1.4	Secure Digital Cards 15
1.5	System Power-up 16
1.6	System Operation 17
	Normal Operation 17
	Reversionary Mode 18
	G1000 System Annunciations 21
	Softkey Function 22
	GPS Receiver Operation 28
1.7	Accessing G1000 Functionality 33
	Menus 33
	MFD Page Groups 33
	MFD System Pages 38
1.8	Display Backlighting 48
	Automatic Adjustment 48
	Manual Adjustment 48
SECTION 2 FLIGHT INSTRUMENTS	
2.1	Flight Instruments 54
	Airspeed Indicator 54
	Attitude Indicator 56
	Altimeter 57
	Vertical Speed Indicator (VSI) 61
	Vertical Deviation 61
	Horizontal Situation Indicator (HSI) 62
	Course Deviation Indicator (CDI) 67
2.2	Supplemental Flight Data 75
	Temperature Displays 75
	Wind Data 77
	Vertical Navigation (VNV) Indications 78
2.3	PFD Annunciations and Alerting Functions 79
	System Alerting 79
	Marker Beacon Annunciations 80
	Traffic Annunciation 80
	Terrain Annunciations 81
	Altitude Alerting 82
	Low Altitude Annunciation 82
	Minimum Descent Altitude/Decision Height Alerting 83
	Radar Altimeter 84
2.4	Abnormal Operations 86
	Abnormal GPS Conditions 86
	Unusual Attitudes 87
SECTION 3 ENGINE AND AIRFRAME SYSTEMS	
3.1	Engine Indication System (EIS) 91
	Engine Parameters 92
	Cabin Pressurization 94
	Fuel Information 94
	Electrical Information 95
	Trim and Flap Indicators 95
3.2	Synoptics 96
	Electrical System 97
	Fuel System 100
	General Systems 102
3.3	Crew Alerting System (CAS) 103
	CAS Display Inhibits 104
	CAS Messages and Prioritization 105
SECTION 4 AUDIO PANEL AND CNS	
4.1	Overview 107
	Audio Panel Volume Control 107
	PFD Controls and Frequency Display 108
	Audio Panel Controls 110
4.2	COM Operation 112
	COM Transceiver Selection and Activation 112
	COM Transceiver Manual Tuning 113
	Quick-Tuning and Activating 121.500 MHz 114
	Auto-Tuning the COM Frequency 115
	Frequency Spacing 120
	Automatic Squelch 121
	Volume 121
4.3	NAV Operation 122
	NAV Radio Selection and Activation 122
	NAV Receiver Manual Tuning 123
	Auto-Tuning a NAV Frequency from the MFD 125
	Marker Beacon Receiver 130
	ADF/DME Tuning 131

4.4 GTX 33/33D Mode S Transponders	135	NDBs	194
Transponder Controls	136	VORs	196
Transponder Mode Selection	137	User Waypoints	198
Entering a Transponder Code	139	5.4 Airspaces	204
IDENT Function	140	5.5 Direct-to-Navigation	209
Flight ID Reporting	141	5.6 Flight Planning	215
4.5 Additional Audio Panel Functions	142	Flight Plan Creation	216
Power-Up	142	Adding Waypoints to an Existing Flight Plan	221
Mono/Stereo Headsets	142	Adding Airways to a Flight Plan	223
Speaker	142	Adding Procedures to a Stored Flight Plan	226
Intercom	143	Flight Plan Storage	233
Passenger Address (PA) System	144	Flight Plan Editing	235
Simultaneous COM Operation	144	Along Track Offsets	238
Clearance Recorder and Player	145	Parallel Track	240
Entertainment Inputs	146	Activating a Flight Plan Leg	243
4.6 Audio Panels Preflight Procedure	147	Inverting a Flight Plan	244
4.7 Abnormal Operation	149	Flight Plan Views	245
Stuck Microphone	149	Closest Point of FPL	247
COM Tuning Failure	149	5.7 Vertical Navigation	248
PFD Failure	150	Altitude Constraints	250
Audio Panel Fail-Safe Operation	151	5.8 Procedures	254
Reversionary Mode	151	Departures	254
<hr/>			
SECTION 5 FLIGHT MANAGEMENT			
5.1 Introduction	153	Arrivals	257
Navigation Status Box	154	Approaches	259
5.2 Using Map Displays	156	5.9 Trip Planning	265
Map Orientation	156	Trip Planning	265
Map Range	158	Weight Planning	269
Map Panning	161	Weight Caution And Warning Conditions	271
Measuring Bearing and Distance	166	5.10 RAIM Prediction	272
Topography	167	5.11 Navigating a Flight Plan	276
Map Symbols	170	5.12 Abnormal Operation	305
Airways	176	<hr/>	
Track Vector	178	SECTION 6 HAZARD AVOIDANCE	
Wind Vector	179	6.1 XM WX Satellite Weather	308
Nav Range Ring	180	Activating Services	308
Fuel Range Ring	181	Using XM WX Products	309
Field of View (SVS)	182	Weather Softkeys on the Weather Data Link (XM) Page 313	
Selected Altitude Intercept Arc	183	6.2 GFDS Worldwide Weather	344
5.3 Waypoints	184	Registering the System for Garmin Flight Data Services	344
Airports	185	GFDS Weather Data Requests	353
Intersections	192	Worldwide Weather Products	358
		Abnormal Operations	374

6.3 Airborne Color Weather Radar	376	SECTION 7 AUTOMATIC FLIGHT CONTROL SYSTEM	
System Description	376	7.1 AFCS Controls	470
Principles of Pulsed Airborne Weather Radar	376	7.2 Flight Director Operation	472
Safe Operating Distance	380	Activating the Flight Director	472
Basic Antenna Tilt Setup	381	AFCS Status Box	473
Weather Mapping and Interpretation	383	Flight Director Modes	474
6.4 Stormscope	397	Switching Flight Directors	474
Setting Up Stormscope on the Navigation Map	397	Command Bars	475
Selecting the Stormscope Page	401	7.3 Vertical Modes	476
6.5 Terrain Proximity	404	Pitch Hold Mode (PIT)	477
Displaying Terrain Proximity Data	405	Selected Altitude Capture Mode (ALTS)	478
Terrain Proximity Page	407	Altitude Hold Mode (ALT)	479
6.6 Terrain-SVS	409	Vertical Speed Mode (VS)	480
Displaying Terrain-SVS Data	410	Flight Level Change Mode (FLC)	481
Terrain-SVS Page	412	Vertical Navigation Modes (VPTH, ALTV)	483
Terrain-SVS Alerts	414	Glidepath Mode (GP)	488
System Status	418	Glideslope Mode (GS)	490
6.7 TAWS-B	419	Takeoff (TO) and Go Around (GA) Modes	491
Displaying TAWS-B Data	420	7.4 Lateral Modes	492
TAWS-B Alerts	424	Roll Hold Mode (ROL)	493
System Status	432	Low Bank Mode	493
6.8 Profile View Terrain	434	Heading Select Mode (HDG)	494
Profile View Display	435	Navigation Modes (GPS, VOR, LOC)	495
6.9 Traffic Information Service (TIS)	438	Approach Modes (GPS, VAPP, LOC)	497
Displaying Traffic Data	439	Backcourse Mode (BC)	498
Traffic Map Page	441	7.5 Autopilot and Yaw Damper Operation	500
TIS Alerts	443	Flight Control	500
System Status	444	Engagement	501
6.10 GTS 820 Traffic	447	Control Wheel Steering	501
Theory of operation	447	Disengagement	502
TAS Alerts	450	7.6 Example Flight Plan	503
System Test	451	Departure	504
Operation	452	Intercepting a VOR Radial	506
6.11 KTA 870 Traffic	460	Flying a Flight Plan/GPS Course	507
TAS Symbology	460	Descent	508
Operation	461	Approach	512
Altitude Display	464	Go Around/Missed Approach	515
Traffic Map Page Display Range	464	7.7 AFCS Annunciations and Alerts	517
TAS Alerts	466	AFCS Status Alerts	517
System Status	466	Overspeed Protection	518

SECTION 8 ADDITIONAL FEATURES

- 8.1 Synthetic Vision System (SVS)** 520
 - SVS Operation 521
 - SVS Features 523
 - Field of View 532
- 8.2 SafeTaxi** 534
 - SafeTaxi Cycle Number and Revision 537
- 8.3 ChartView** 540
 - ChartView Softkeys 540
 - Terminal Procedures Charts 541
 - Chart Options 549
 - Day/Night View 555
 - ChartView Cycle Number and Expiration Date 557
- 8.4 FliteCharts** 560
 - FliteCharts Softkeys 560
 - Terminal Procedures Charts 561
 - Chart Options 568
 - Day/Night View 571
 - FliteCharts Cycle Number and Expiration Date 573
- 8.5 AOPA Airport Directory** 576
 - AOPA Database Cycle Number and Revision 576
- 8.6 SiriusXM Radio Entertainment** 578
 - Activating SiriusXM Satellite Radio Services 578
 - Using SiriusXM Radio 580
- 8.7 Scheduler** 583
- 8.8 Electronic Checklists** 585
- 8.9 Flight Data Logging** 589
- 8.10 Satellite Telephone & SMS Messaging Service** 591
 - Registering the Iridium Satellite System 591
 - Telephone Communication 591
 - Text Messaging (SMS) 598
- 8.11 Abnormal Operation** 609
 - SVS Troubleshooting 609
 - Reversionary Mode 609
 - Unusual Attitudes 610

- System Annunciations 616
- Message Advisories 619
- AFCS Alerts 632
- Terrain-SVS Alerts 633
- TAWS-B ALERTS 634
- Other G1000 Aural Alerts 635
- Flight Plan Import/Export Messages 636
- Database Management** 637
 - Jeppesen Databases 637
 - Garmin Databases 641
- Glossary** 647
- Frequently Asked Questions** 653
- Map Symbols** 657

INDEX

- Index** I-1

APPENDICES

- Annunciations and Alerts** 613
 - CAS Messages 613
 - Comparator Annunciations 615
 - Reversionary Sensor Annunciations 616

SECTION 1 SYSTEM OVERVIEW

1.1 SYSTEM DESCRIPTION

This section is designed to provide an overview of the G1000 Integrated Flight Deck. The G1000 system is an integrated flight control system that presents flight instrumentation, position, navigation, communication, and identification information to the pilot through large-format displays. The system consists of the following Line Replaceable Units (LRUs):

- **GDU 1040A** Primary Flight Display (PFD)
- **GDU 1500** Multi Function Display (MFD)
- **GIA 63W** Integrated Avionics Unit
- **GDC 74B** Air Data Computer (ADC)
- **GEA 71** Engine/Airframe Unit
- **GRS 77** Attitude and Heading Reference System (AHRS)
- **GMU 44** Magnetometer
- **GMA 1347D Cabin** Dual Audio System with Integrated Marker Beacon Receiver
- **GTX 33/33D** Mode S Transponder
- **GDL 69A** Data Link (optional)
- **GWX 68** Weather Radar (optional)
- **GSR 56** Iridium Transceiver (optional)
- **GCU 475** MFD Control Unit
- **GMC 710** AFCS Control Unit
- **GTS 820** Traffic Avoidance System (optional)
- **GA 58** Directional Antenna
- **GA 36** and **GA 37** GPS/SBAS Antennas
- **GSA 81** AFCS Servos
- **GSM 85/86** Servo Gearboxes
- **GTA 82** Trim Adapter

A top-level G1000 system block diagram is shown in Figure 1-1 (it does not include the GA 36, GA 37, GA 58, or GSM 85/86).



NOTE: Refer to the AFCS section for details on the GFC 700 AFCS.

In the aircraft, the GFC 700 Automated Flight Control System (AFCS) provides the Flight Director (FD), Autopilot (AP), and Yaw Damper (YD) functions of the G1000 system.

1.2 LINE REPLACEABLE UNITS (LRU)

- **GDU 1040A** – Each unit is configured as a PFD that features a 10.4-inch LCD with 1024 x 768 resolution. The unit installed on the left/pilot side is designated as PFD1, and the one installed on the right/copilot side is designated as PFD2. These units communicate with each other, the MFD, and with the on-side GIA 63W Integrated Avionics Unit through a High-Speed Data Bus (HSDB) connection.



- **GDU 1500** – Features a 15-inch LCD with 1024 x 768 resolution and is configured as an MFD. This unit is linked to both PFDs via HSDB connection.



- **GIA 63W** – Functions as the main communication hub, linking all LRUs with the on-side PFD. Each GIA 63W contains a GPS SBAS receiver, VHF COM/NAV/GS receivers, a flight director (FD) and system integration microprocessors. Each GIA 63W is paired with the on-side PFD via HSDB connection. The GIA 63Ws are not paired together and do not communicate with each other directly.



- **GDC 74B** – Processes data from the pitot/static system as well as the OAT probe. This unit provides pressure altitude, airspeed, vertical speed and OAT information to the G1000 system, and it communicates with the on-side GIA 63W, on-side GDU 1040A and on-side GRS 77, using an ARINC 429 digital interface (it also interfaces directly with the OAT). The GDC 74B is designed to operate in Reduced Vertical Separation Minimum (RVSM) airspace.



- **GEA 71** – Receives and processes signals from the engine and airframe sensors. This unit communicates with both GIA 63Ws using an RS-485 digital interface.



- **GRS 77** – Provides aircraft attitude and heading information via ARINC 429 to both the on-side GDU 1040A and the on-side GIA 63W. The GRS 77 contains advanced sensors (including accelerometers and rate sensors) and interfaces with the on-side GMU 44 to obtain magnetic field information, with the GDC 74B to obtain air data, and with both GIA 63Ws to obtain GPS information. AHRS modes of operation are discussed later in this document.



- **GMU 44** – Measures local magnetic field. Data is sent to the GRS 77 for processing to determine aircraft magnetic heading. This unit receives power directly from the GRS 77 and communicates with the GRS 77, using an RS-485 digital interface.



- **GMA 1347D Cabin** – Integrates NAV/COM digital audio, intercom system and marker beacon controls, and is installed in dual configuration on the outboard side of PFD1 and PFD2. This unit also enables the manual control of the display reversionary mode (red **DISPLAY BACKUP** button) and communicates with the on-side GIA 63W, using an RS-232 digital interface.



- **GTX 33 and GTX 33D** – Solid-state transponders that provide Modes A, C and S capability. The GTX 33D includes Mode S with diversity and is indicated as 'XPDR1'. The GTX 33 is indicated as 'XPDR2'. Both transponders can be controlled from either PFD, and only one transponder can be active at a time. Each transponder communicates with the on-side GIA 63W through an RS-232 digital interface.



- **GDL 69A** – A satellite radio receiver that provides real-time weather information to the G1000 MFD (and, indirectly, to the inset map of the PFD) as well as digital audio entertainment. The GDL 69A communicates with the MFD via HSDB connection. A subscription to the SiriusXM Satellite Radio service is required to enable the GDL 69A capability.



- **GSR 56** – The Iridium Transceiver operation for voice communication is by means of pilot and copilot headsets in the cockpit. The system is also capable of SMS text messaging. Connection to the system is through the RS-232 bus.



- **GWX 68** – Provides airborne weather and ground mapped radar data to the MFD, through the GDL 69A, via HSDB connection.

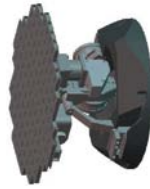

- **GTS 820** – The GTS 820 Traffic Advisory System (TAS) uses active interrogations of Mode S and Mode C transponders to provide Traffic Advisories to the pilot independent of the air traffic control system.



- **GCU 475** – Provides the Flight Management System (FMS) controls for the MFD through an RS-232 digital interface.



- **GMC 710** – Provides the controls for the GFC 700 AFCS through an RS-232 digital interface allowing communication with both PFDs.



- **GSA 81**, and **GSM 85/86** – The GSA 81 servos are used for the automatic control of roll, yaw, pitch, and pitch trim. These units interface with each GIA 63W.

The GSM 85/86 servo gearbox is responsible for transferring the output torque of the GSA 81 servo actuator to the mechanical flight-control surface linkage.



- **GTA 82** – The GTA 82 Trim Adapter is a remote mounted device that is used to allow the GFC 700 to drive the yaw trim actuator.



- **GA 36** and **GA 37** – The GA 36 is a through-mount GPS/SBAS antenna. The GA 37 is a through-mount GPS/SBAS antenna with SiriusXM/Datalink.



- **GA 58** – The GA 58 is directional antenna for the Traffic Avoidance System. One top-mounted directional antenna is required. Optional bottom mounted antenna offers better threat visibility.

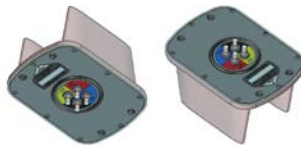

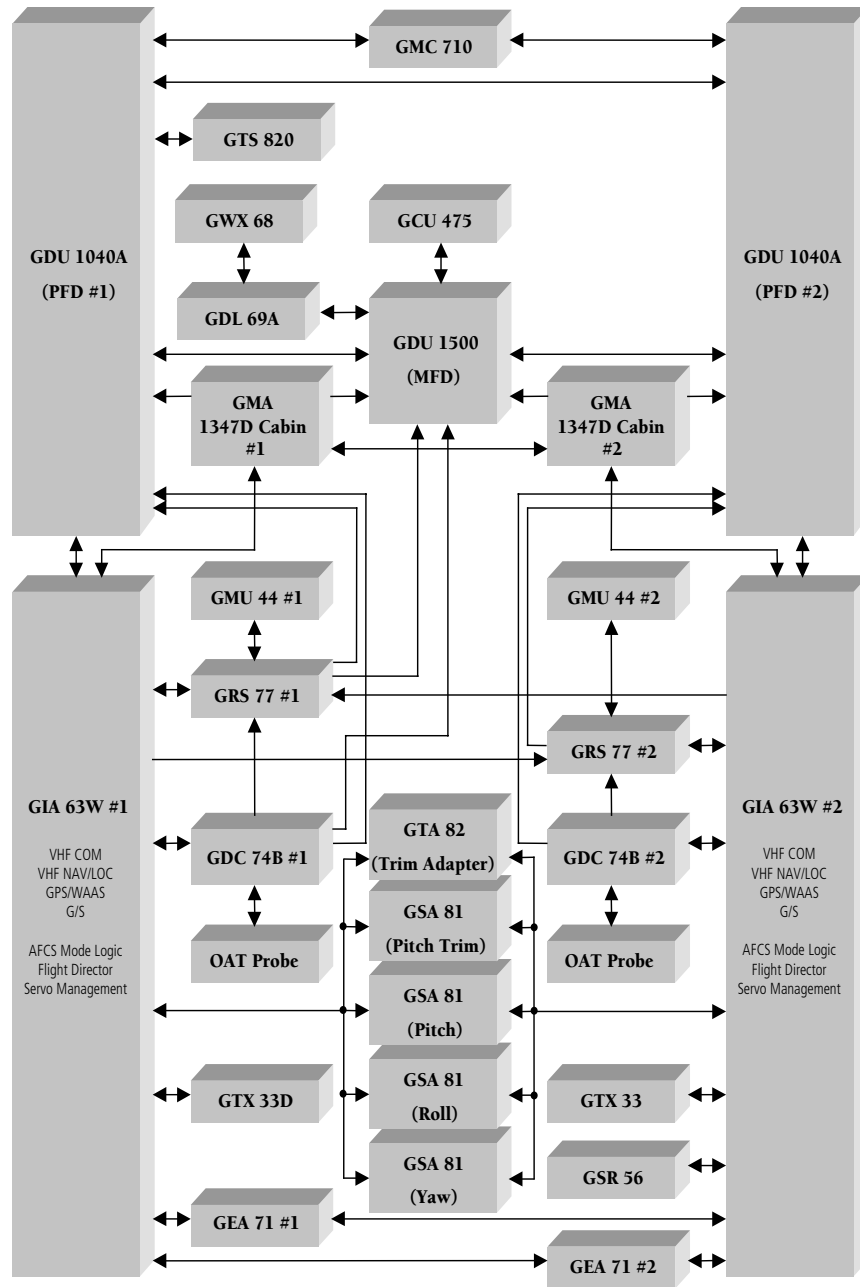

Figure 1-1 Example G1000 System (LRU Configuration)

1.3 G1000 CONTROLS

NOTE: The Audio Panel (GMA 1347D Cabin) and AFCS controls (GMC 710) are described in the CNS & Audio Panel and AFCS sections respectively.

The G1000 system controls are located on the PFD and MFD bezels, MFD Control Unit, AFCS Control Unit and audio panel. The controls for the PFD and MFD are discussed within the following pages of this section.

PFD CONTROLS

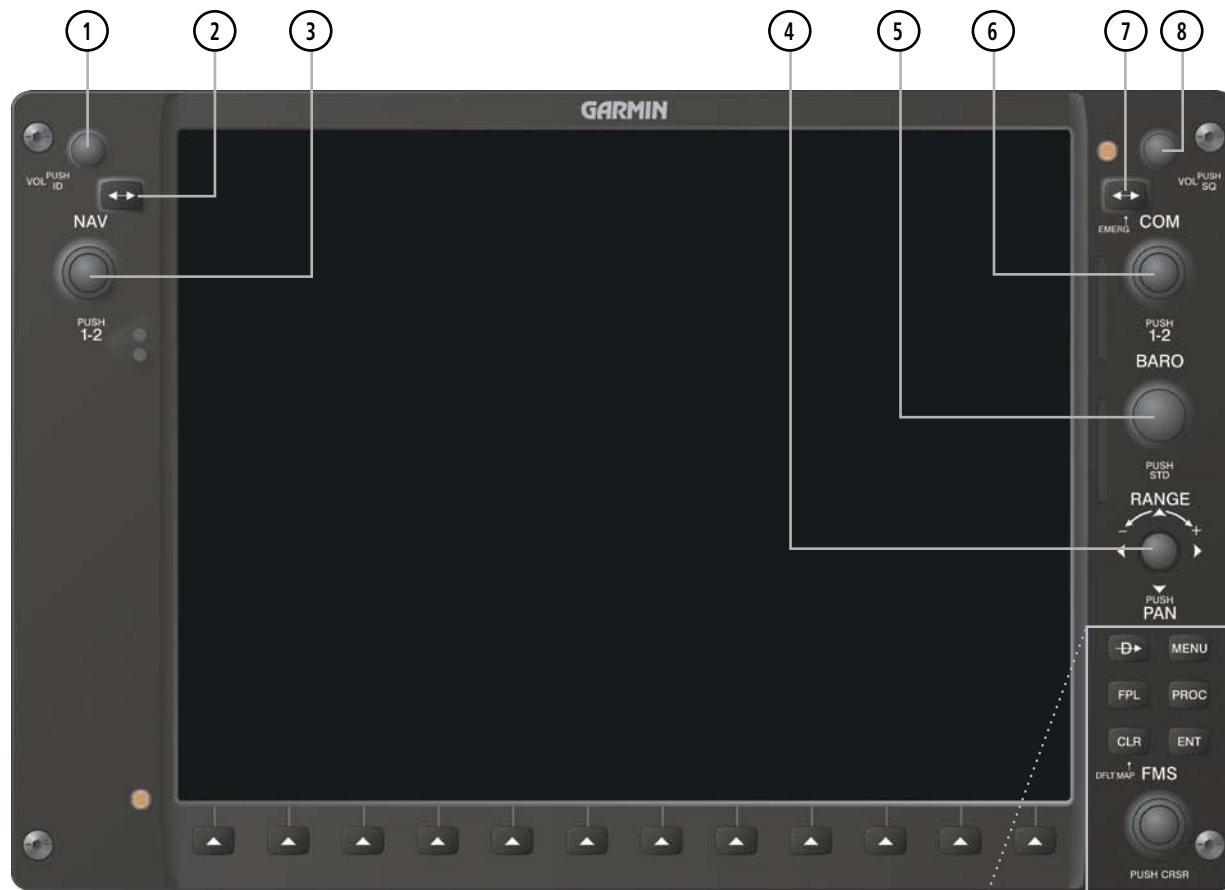
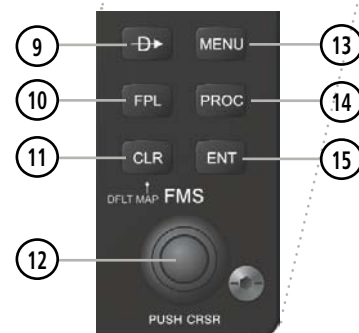

Figure 1-2 PFD Controls



The following list provides an overview of the controls located on the PFD bezel (see Figure 1-2).

- ① **NAV VOL/ID Knob** – Controls NAV audio volume level. Press to switch the Morse code identifier audio ON and OFF. Volume level is shown in the NAV frequency field as a percentage.
- ② **NAV Frequency Transfer Key** – Switches the standby and active NAV frequencies.
- ③ **Dual NAV Knob** – Tunes the standby frequencies for the NAV receiver (large knob for MHz; small knob for kHz). Press to switch the tuning box (light blue box) between NAV1 and NAV2.
- ④ **Joystick** – Changes the map range when rotated. Activates the map pointer when pressed.
- ⑤ **BARO Knob** – Sets the altimeter barometric pressure. Press to enter standard pressure (29.92in/1013 Hpa).
- ⑥ **Dual COM Knob** – Tunes the standby frequencies for the COM transceiver (large knob for MHz; small knob for kHz). Press to switch the tuning box (light blue box) between COM1 and COM2.
- ⑦ **COM Frequency Transfer Key** – Switches the standby and active COM frequencies. Press and hold this key for two seconds to tune the emergency frequency (121.5 MHz) automatically into the active frequency field.
- ⑧ **COM VOL/SQ Knob** – Controls COM audio volume level. Volume level is shown in the COM frequency field as a percentage. Press to turn the COM automatic squelch ON and OFF.
- ⑨ **Direct-to Key** (D▶) – Allows the user to enter a destination waypoint and establish a direct course to the selected destination (the destination is either specified by the identifier, chosen from the active route, or taken from the map pointer position).
- ⑩ **FPL Key** – Displays the active Flight Plan Page for creating and editing the active flight plan.
- ⑪ **CLR Key** – Erases information, cancels entries, or removes page menus.
- ⑫ **Dual FMS Knob** – Flight Management System Knob. Press the **FMS** Knob to turn the selection cursor ON and OFF. When the cursor is ON, data may be entered in the applicable window by turning the small and large knobs. The large knob moves the cursor on the page, while the small knob selects individual characters for the highlighted cursor location.
- ⑬ **MENU Key** – Displays a context-sensitive list of options. This list allows the user to access additional features or make setting changes that relate to particular pages.
- ⑭ **PROC Key** – Gives access to IFR departure procedures (DPs), arrival procedures (STARs) and approach procedures (IAPs) for a flight plan. If a flight plan is used, available procedures for the departure and/or arrival airport are automatically suggested. These procedures can then be loaded into the active flight plan. If a flight plan is not used, both the desired airport and the desired procedure may be selected.
- ⑮ **ENT Key** – Validates or confirms a menu selection or data entry.

CONTROLS ASSOCIATED WITH THE MFD

The controls for the MFD (GDU 1500) are located on both the MFD bezel and the MFD Control Unit (GCU 475). The bottom portion of the MFD bezel features 12 softkeys that are designed to perform various functions depending upon the control display mode and the specific page being displayed. These softkeys are discussed throughout this documentation.

The following list provides an overview of the controls located on the MFD Control Unit (see Figure 1-3):

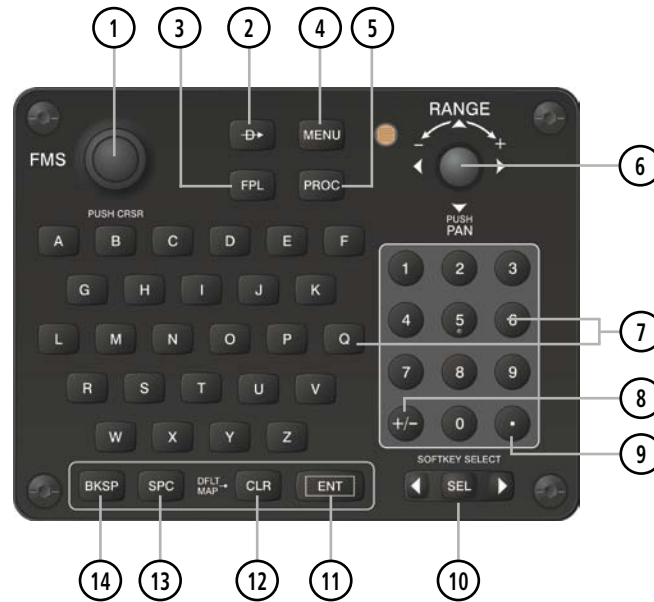

Figure 1-3 MFD Control Unit (GCU 475)

- ① **Dual FMS Knob** – Flight Management System Knob. This knob selects the MFD page to be viewed; the large knob selects a page group (MAP, WPT, AUX, NRST), while the small knob selects a specific page within the page group. Pressing the **FMS** Knob turns the selection cursor ON and OFF. When the cursor is ON, data may be entered in the applicable window by turning the small and large knobs. In this case, the large knob moves the cursor on the page, while the small knob selects individual characters for the highlighted cursor location.
- ② **Direct-to Key** (D→) – Allows the user to enter a destination waypoint and establish a direct course to the selected destination (the destination is either specified by the identifier, chosen from the active route, or taken from the map pointer position).
- ③ **FPL Key** – Displays the active Flight Plan Page for creating and editing the active flight plan, or for accessing stored flight plans.
- ④ **MENU Key** – Displays a context-sensitive list of options. This list allows the user to access additional features or make setting changes that relate to particular pages.
- ⑤ **PROC Key** – Gives access to IFR departure procedures (DPs), arrival procedures (STARs) and approach procedures (IAPs) for a flight plan. If a flight plan is used, available procedures for the departure and/or arrival airport are automatically suggested. These procedures can then be loaded into the active flight plan. If a flight plan is not used, both the desired airport and the desired procedure may be selected.

- ⑥ **Joystick** – Changes the map range when rotated. Activates the map pointer when pressed.
- ⑦ **Alphanumeric Keys** – Allow the user to enter data quickly, without having to select individual characters with the **FMS** Knob.
- ⑧ **Plus (+) Minus (-) Key** – Switches between a (+) or (-) character.
- ⑨ **Decimal Key** – Enters a decimal point.
- ⑩ **SEL Key** – The center of this key activates the selected softkey, while the right and left arrows move the softkey selection box to the right and left, respectively.
- ⑪ **ENT Key** – Validates or confirms a menu selection or data entry.
- ⑫ **CLR Key** – Erases information, cancels entries, or removes page menus. Pressing and holding this key displays the Navigation Map Page automatically.
- ⑬ **SPC Key** – Adds a space character.
- ⑭ **BKSP Key** – Moves the cursor back one character space.

AFCS CONTROLS

NOTE: With the exception of the **FD** and **SPD** Keys, if a key is selected, its respective annunciator is illuminated.

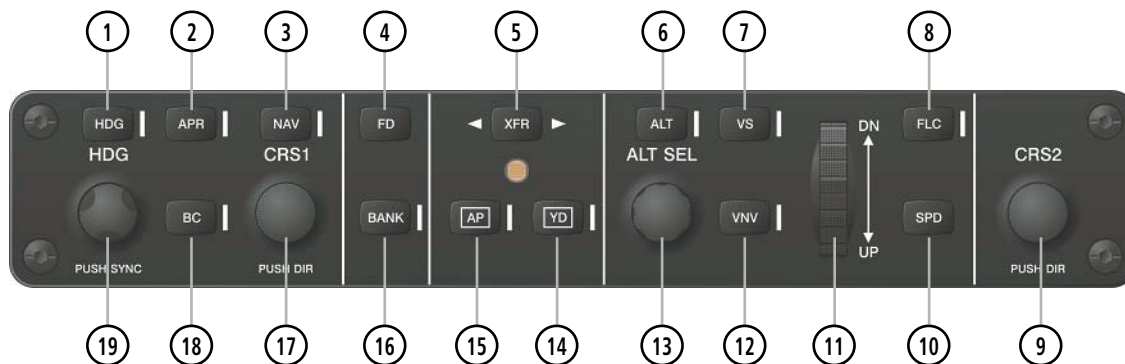

Figure 1-4 AFCS Control Unit (GMC 710)

The GFC 700 AFCS is mainly controlled through the GMC 710 AFCS Control Unit. The AFCS Control Unit consists of the following controls:

- ① **HDG Key** – Selects/deselects the Heading Select mode.
- ② **APR Key** – Selects/deselects the Approach mode.
- ③ **NAV Key** – Selects/deselects the Navigation mode.

- ④ **FD Key** – Activates/deactivates the Flight Director in the default Pitch and Roll modes. If the Autopilot is engaged, the **FD Key** is disabled.
- ⑤ **XFR Key** – Switches the Autopilot between the pilot and the copilot Flight Director. This selection also selects which Air Data Computer is communicating with the active transponder. Upon power-up, the pilot FD is selected.
- ⑥ **ALT Key** – Selects/deselects the Altitude Hold mode.
- ⑦ **VS Key** – Selects/deselects the Vertical Speed mode.
- ⑧ **FLC Key** – Selects/deselects the Flight Level Change mode.
- ⑨ **CRS2 Knob** – Sets the copilot-selected course on the HSI of PFD2 when the VOR1, VOR2, or OBS/SUSP mode is selected. Pressing this knob centers the CDI on the currently selected VOR. The copilot-selected course provides course reference to the copilot Flight Director when operating in Navigation and Approach modes.
- ⑩ **SPD Key** – Switches the Flight Level Change mode reference speed between IAS and MACH number.
- ⑪ **NOSE UP/DN Wheel** – Controls the active mode reference for the Pitch, Vertical Speed, and Flight Level Change modes.
- ⑫ **VNV Key** – Selects/deselects Vertical Navigation mode.
- ⑬ **ALT SEL Knob** – Sets the selected altitude in the Selected Altitude Box. In addition to providing the standard G1000 altitude alerter function, selected altitude provides an altitude setting for the Altitude Capture/Hold mode of the AFCS.
- ⑭ **YD Key** – Engages/disengages Yaw Damper.
- ⑮ **AP Key** – Engages/disengages the Autopilot.
- ⑯ **BANK Key** – Selects/deselects the Low Bank mode.
- ⑰ **CRS1 Knob** – Sets the pilot-selected course on the HSI of PFD1 when the VOR1, VOR2, or OBS/SUSP mode is selected. Pressing this knob centers the CDI on the currently selected VOR. The pilot-selected course provides course reference to the pilot Flight Director when operating in Navigation and Approach modes.
- ⑱ **BC Key** – Selects/deselects the Back Course approach mode.
- ⑲ **HDG Knob** – Sets the selected heading on the HSI. When operating in Heading Select mode, this knob provides the heading reference to the Flight Director.

ADDITIONAL AFCS CONTROLS

The **AP DISC** (Autopilot Disconnect) Button, **CWS** (Control Wheel Steering) Button, **GO AROUND** Button, and **MET** (Manual Electric Trim) Switch are additional AFCS controls and are located in the cockpit, separately from the AFCS Control Unit. These are discussed in detail in the AFCS section.

AUDIO PANEL CONTROLS

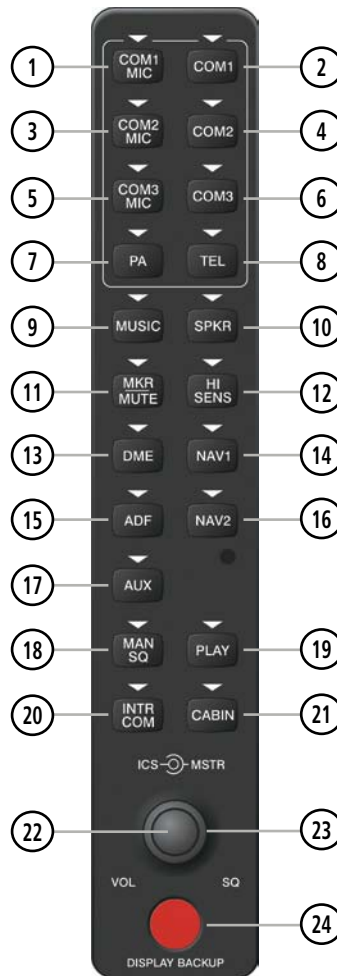

Figure 1-5 Audio Panel Controls (GMA 1347D Cabin)



NOTE: When a key is selected, a triangular annunciator above the key is illuminated.

- ① **COM1 MIC** – Selects the #1 transmitter for transmitting. COM1 receive is simultaneously selected when this key is pressed allowing received audio from the the #1 Com receiver to be heard. COM2 receiver audio can be added by pressing the **COM2** Key.
- ② **COM1** – When selected, audio from the #1 Com receiver can be heard.
- ③ **COM2 MIC** – Selects the #2 transmitter for transmitting. COM2 is simultaneously selected when this key is pressed allowing received audio from the the #2 Com receiver to be heard. COM2 can be deselected by pressing the **COM2** Key, or COM1 can be added by pressing the **COM1** Key.
- ④ **COM2** – When selected, audio from the #2 Com receiver can be heard.
- ⑤ **COM3 MIC** – Not used on some aircraft..

- ⑥ **COM3** – Not used on some aircraft.
- ⑦ **PA** – Selects the passenger address system. The selected Com transmitter is deselected when the **PA** Key is pressed.
- ⑧ **TEL** – Not used on some aircraft.
- ⑨ **MUSIC** – Not used on some aircraft.
- ⑩ **SPKR** – Pressing this key selects and deselects the corresponding cockpit speaker. Com and Nav receiver audio is heard on the speaker.
- ⑪ **MKR/MUTE** – Mutes the currently received Marker Beacon Receiver audio. Unmutes when new marker beacon audio is received.
- ⑫ **HI SENS** – Press to increase Marker Beacon Receiver sensitivity. Press again to return to normal.
- ⑬ **DME** – Pressing turns DME audio on or off.
- ⑭ **NAV1** – When selected, audio from the #1 Nav receiver can be heard.
- ⑮ **ADF** – Pressing turns on or off the audio from the ADF receiver.
- ⑯ **NAV2** – When selected, audio from the #2 Nav receiver can be heard.
- ⑰ **AUX** – Not used on some aircraft.
- ⑱ **MAN SQ** – Pressing activates/deactivates intercom manual squelch operation.
- ⑲ **PLAY** – Press once to play the last recorded audio. Press during play to play the previously recorded memory block. Each subsequent press of the **PLAY** Key begins playing the next previously recorded block.
- ⑳ **INTR COM** – Pressing selects/deselects the pilot/copilot intercom on both audio panels.
- ㉑ **CABIN** – Pressing activates/deactivates two-way communication between pilot/copilot and passengers.
- ㉒ **ICS Knob** – Turn to adjust intercom volume or squelch. Press to switch between volume and squelch control as indicated by the 'VOL' or 'SQ' being illuminated. The **MAN SQ** Key must be selected to allow squelch adjustment.
- ㉓ **MSTR Knob** – The Master Volume Control adjusts volume for the blended NAV, COM, and intercom audio.
- ㉔ **Reversionary Mode Button** – Pressing manually selects Reversionary Mode.

1.4 SECURE DIGITAL CARDS



NOTE: Refer to the Appendices for instructions on updating the navigation database.



NOTE: Ensure that the G1000 system is powered off before inserting the SD card.

The GDU 1040A and GDU 1500 data card slots use Secure Digital (SD) cards and are located on the top right portion of the display bezels. Each display bezel is equipped with two SD card slots. SD cards are used for navigation database and system software updates as well as expanded basemap, terrain, obstacle, SafeTaxi, FliteCharts, ChartView, and AOPA Airport Directory database storage.

Not all SD cards are compatible with the G1000. Use only SD cards supplied by Garmin or the aircraft manufacturer.

To install an SD card:

- Insert the SD card in the SD card slot, pushing the card in until the spring latch engages. The front of the card should remain flush with the face of the display bezel.

To remove an SD card:

- Gently press on the SD card to release the spring latch and eject the card.

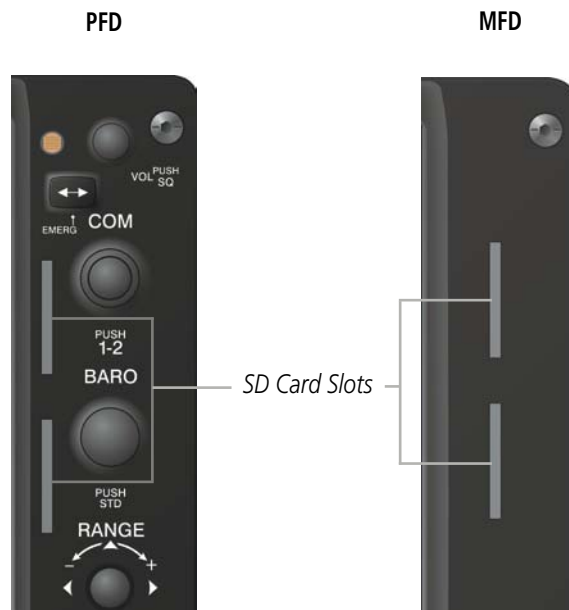

Figure 1-6 Display Bezel SD Card Slots

1.5 SYSTEM POWER-UP

- NOTE:** Refer to the Appendices for AHRS initialization bank angle limitations.
- NOTE:** See the Appendices for additional information regarding system-specific annunciations and alerts.
- NOTE:** See the Airplane Flight Manual (AFM) for specific procedures concerning avionics power application and emergency power supply operation.

The G1000 system is integrated with the aircraft electrical system and receives power directly from electrical busses. The G1000 PFDs, MFD and supporting sub-systems include both power-on and continuous built-in test features that exercise the processor, RAM, ROM, external inputs and outputs to provide safe operation.

During system initialization, test annunciations are displayed, as shown in Figure 1-7. All system annunciations should disappear typically within one (1) minute of power-up. Upon power-up, key annunciator lights also become momentarily illuminated on the audio panels, the control units and the display bezels.

On the PFD, the AHRS begins to initialize and displays ‘AHRS ALIGN: Keep Wings Level’. The AHRS should display valid attitude and heading fields typically within one (1) minute of power-up. The AHRS can align itself both while taxiing and during level flight.

When the MFD powers up (Figure 1-8), the MFD Power-up Page displays the following information:

- System version
- Copyright
- Land database name and version
- Safe Taxi database information
- Terrain database name and version
- Airport Terrain database name and version
- Obstacle database name and version
- Navigation database name, version, and effective dates
- Airport Directory name, version and effective dates
- FliteCharts/ChartView database information

Current database information includes the valid operating dates, cycle number and database type. When this information has been reviewed for currency (to ensure that no databases have expired), the pilot is prompted to continue. Pressing the **ENT** Key acknowledges this information and displays the Auxiliary (AUX) Weight Planning Page.

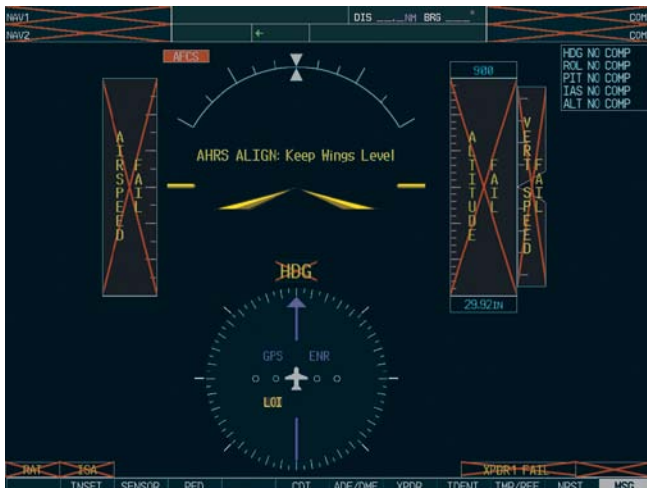

Figure 1-7 PFD Initialization

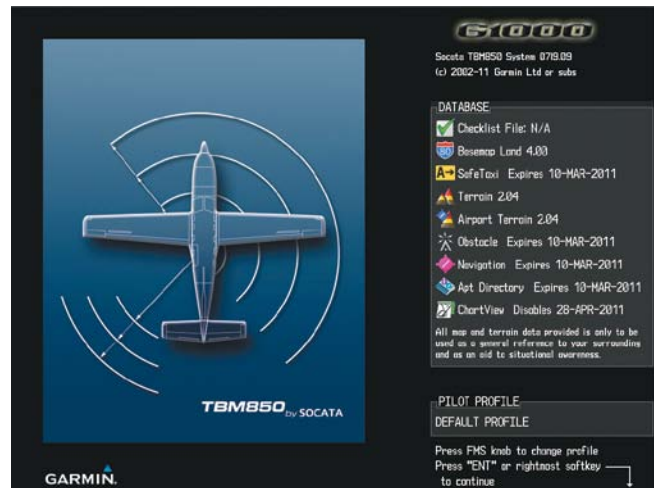

Figure 1-8 MFD Power-up Page

1.6 SYSTEM OPERATION

The displays are connected together via a single Ethernet bus, thus allowing for high-speed communication. As shown in Figure 1-1, each GIA 63W is connected to the on-side PFD. This section discusses the normal and reversionary modes of operation as well as the various AHRS modes of the G1000 system.

NORMAL OPERATION

PFD

In normal mode, the PFD presents graphical flight instrumentation (attitude, heading, airspeed, altitude and vertical speed), thereby replacing the traditional flight instrument cluster. The PFD also offers control for COM and NAV frequency selection.

MFD

In normal mode, the right portion of the MFD displays a full-color moving map with navigation information, while the left portion of the MFD is dedicated to the Engine Indication and Crew Alerting System (EICAS).

Figure 1-9 gives an example of the G1000 displays in normal mode.



Figure 1-9 Normal Operation

REVERSIONARY MODE



NOTE: The G1000 system alerts the pilot when backup paths are utilized by the LRUs. Refer to the Appendices for further information regarding system-specific alerts.

Reversionary mode is a mode of operation in which all important flight information is presented identically on at least one of the remaining displays (see Figure 1-10). Transition to reversionary mode should be straightforward for the pilot, for flight parameters are presented in the same format as in normal mode.



Figure 1-10 Reversionary Mode (Manual)

Reversionary mode is activated by pressing the dedicated **DISPLAY BACKUP** button at the bottom of the audio panel (see Figure 1-11 and refer to the Audio Panel section for further details). Pressing this button again deactivates reversionary mode.

Pressing the **DISPLAY BACKUP** button activates/deactivates reversionary mode for both the on-side PFD and the MFD.



Figure 1-11 DISPLAY BACKUP Button

Each display can be configured to operate in reversionary mode, as follows:

- **PFD1** – By pressing the **DISPLAY BACKUP** button on the left audio panel.
- **MFD** – By pressing the **DISPLAY BACKUP** button on the left or the right audio panel.
- **PFD2** – By pressing the **DISPLAY BACKUP** button on the right audio panel.

Should the connection between a PFD and the on-side GIA 63W become inoperative, the on-side GIA 63W can no longer communicate with the remaining PFD (refer to Figure 1-1). As a result, the NAV and COM functions provided to the failed PFD by the on-side GIA 63W are flagged as invalid (red “x”) on the remaining PFD (see Figure 1-12).



Figure 1-12 Inoperative Input (NAV1 Shown)

AHRS OPERATION

NOTE: Refer to the Appendices for specific AHRS alert information.

NOTE: Aggressive maneuvering while the AHRS is not operating normally can degrade AHRS accuracy.

In addition to using internal sensors, the GRS 77 AHRS uses GPS information, magnetic field data and air data to assist in attitude/heading calculations. In normal mode, the AHRS relies upon GPS and magnetic field measurements. If either of these external measurements is unavailable or invalid, the AHRS uses air data information for attitude determination. Four AHRS modes of operation are available (see Figure 1-13) and depend upon the combination of available sensor inputs. Loss of air data, GPS, or magnetometer sensor inputs is communicated to the pilot by message advisory alerts.

The AHRS (GRS 77) corrects for shifts and variations in the Earth’s magnetic field by applying the Magnetic Field Variation Database. The Magnetic Field Variation Database is derived from the International Geomagnetic Reference Field (IGRF). The IGRF is a mathematical model that describes the Earth’s main magnetic field and its annual rate of change. The database is updated approximately every 5 years. See the Appendices for information on updating the Magnetic Field Variation Database. The system will prompt you on startup when an update is available. Failure to update this database could lead to erroneous heading information being displayed to the pilot.

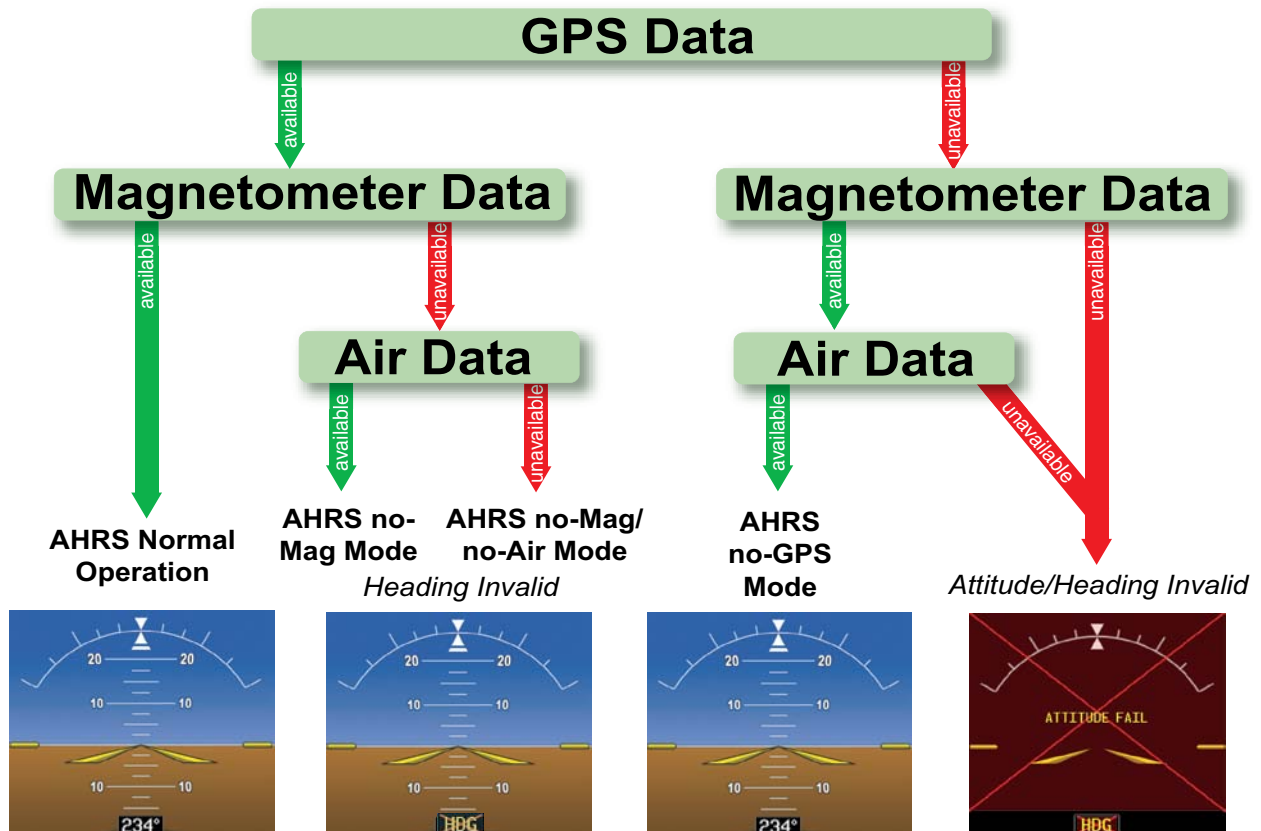

Figure 1-13 AHRS Operation

GPS INPUT FAILURE



NOTE: *In-flight initialization of AHRS, when operating without any valid source of GPS data and at true air speed values greater than approximately 200 knots, is not guaranteed. Under these rare conditions, it is possible for in-flight AHRS initialization to take an indefinite amount of time which would result in an extended period of time where valid AHRS outputs are unavailable.*

The G1000 system provides two sources of GPS information. If a single GPS receiver fails, or if the information provided from one of the GPS receivers is unreliable, the AHRS seamlessly transitions to using the other GPS receiver. An alert message informs the pilot of the use of the backup GPS path. If both GPS inputs fail, the AHRS continues to operate in reversionary No-GPS mode so long as the air data and magnetometer inputs are available and valid.

AIR DATA INPUT FAILURE

A failure of the air data input has no effect on AHRS output while AHRS is operating in normal mode. A failure of the air data input while the AHRS is operating in reversionary No-GPS mode results in invalid attitude and heading information on the PFD (as indicated by red “x” flags).

MAGNETOMETER FAILURE

If the magnetometer input fails, the AHRS transitions to one of the reversionary No-Magnetometer modes and continues to output valid attitude information. However, if the aircraft is airborne, the heading output on the PFD does become invalid (as indicated by a red “x”).

G1000 SYSTEM ANNUNCIATIONS

NOTE: For a detailed description of all annunciations and alerts, refer to Appendix A. Refer to the Airplane Flight Manual (AFM) for additional information regarding pilot responses to these annunciations.

When an LRU or an LRU function fails, a large red 'X' is typically displayed on windows associated with the failed data (Figure 1-14 displays all possible flags and responsible LRUs). Upon G1000 power-up, certain windows remain invalid as equipment begins to initialize. All windows should be operational within one minute of power-up. If any window remains flagged, the G1000 System should be serviced by a Garmin-authorized repair facility.

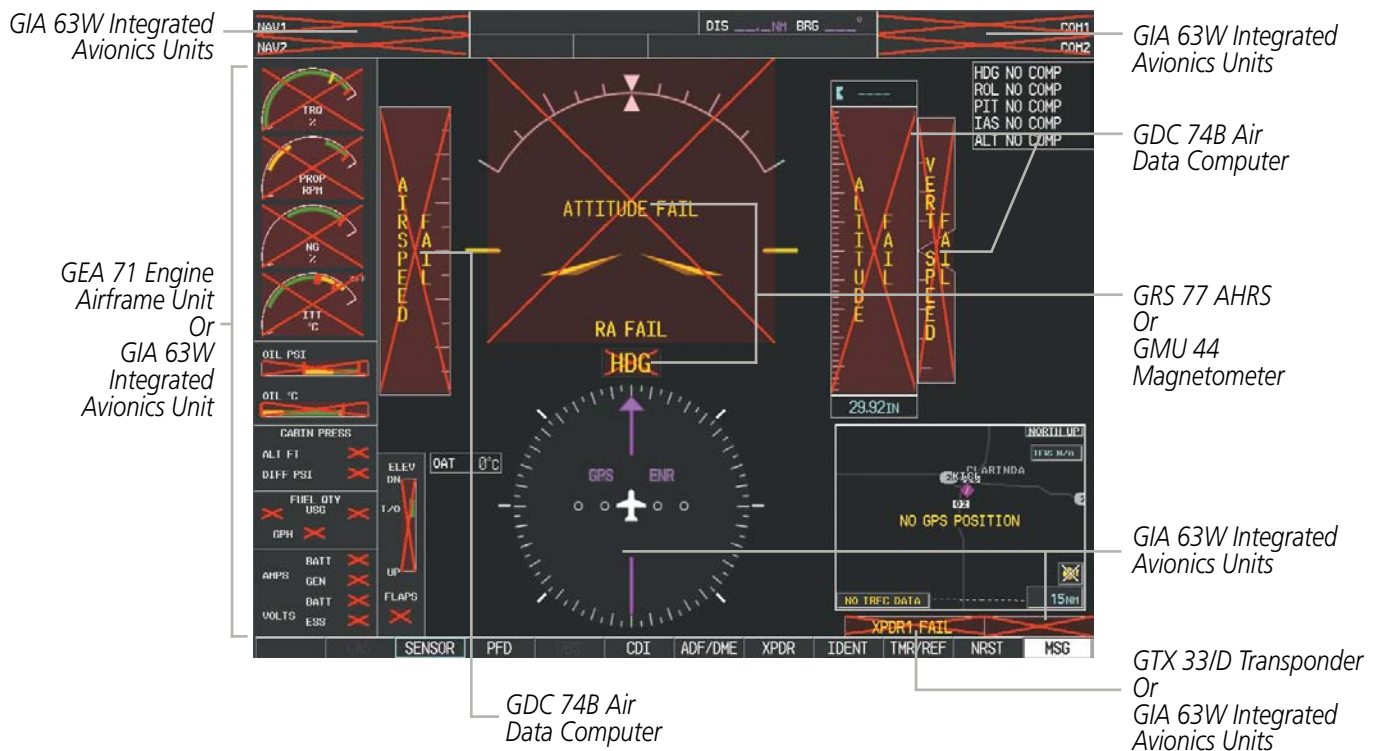

Figure 1-14 G1000 System Failure Annunciations

SOFTKEY FUNCTION

The softkeys are located along the bottoms of the displays. The softkeys shown depend on the softkey level or page being displayed. The bezel keys below the softkeys can be used to select the appropriate softkey. When a softkey is selected, its color changes to black text on gray background and remains this way until it is turned off, at which time it reverts to white text on black background.



Figure 1-15 Softkeys (Level 2 PFD Configuration)

Another means of selecting softkeys is by using the MFD/PFD Control Unit:

To select a softkey using the MFD Control Unit:

- 1) Move the softkey selection box to the desired softkey using the arrows of the **SEL** Key.
- 2) Press the center of the **SEL** Key to select the desired softkey.

PFD SOFTKEYS

The **CDI**, **IDENT**, **TMR/REF**, **NRST**, and **MSG** Softkeys undergo a momentary change to black text on gray background and automatically switch back to white text on black background when selected. If messages remain after acknowledgement, the **MSG** Softkey is black on white.

The PFD softkeys provide control over flight management functions, including GPS, NAV, terrain, traffic, and lightning (optional). Each softkey sublevel has a **BACK** Softkey which can be pressed to return to the previous level. The **MSG** Softkey is visible in all softkey levels. For the top level softkeys and the transponder (XPDR) levels, the **IDENT** Softkey remains visible.

Level 1	Level 2	Level 3	Description
INSET			Displays Inset Map in PFD lower left corner
	OFF		Removes Inset Map
	DCLTR (3)		Selects desired amount of map detail; cycles through declutter levels: DCLTR (No Declutter): All map features visible DCLTR-1: Declutters land data DCLTR-2: Declutters land and SUA data DCLTR-3: Removes all except the active flight plan
	WX LGND		Displays icon and age on the Inset Map for the selected weather products (optional)
	TRAFFIC		Cycles through traffic display options: TRFC-1: Traffic displayed on inset map TRFC-2: Traffic Map Page is displayed in the inset map window
	TOPO		Displays topographical data (e.g., coastlines, terrain, rivers, lakes) and elevation scale on Inset Map

Level 1	Level 2	Level 3	Description
	TERRAIN		Displays terrain information on Inset Map
	NEXRAD or PRECIP		Displays NEXRAD weather and coverage information on Inset Map (optional) Displays GFDS precipitation on Inset Map (optional)
	XM LTNG or DL LTNG		Displays XM WX lightning information on Inset Map (optional) Displays GFDS Worldwide Weather lightning information on Inset Map (optional)
	METAR		Displays METAR flags on airport symbols shown on the Inset Map (optional)
SENSOR			Displays softkeys selecting the #1 and #2 sensors
	ADC1		Selects the #1 Air Data Computer
	ADC2		Selects the #2 Air Data Computer
	AHRS1		Selects the #1 AHRS
	AHRS2		Selects the #2 AHRS
PFD			Displays second-level softkeys for additional PFD configurations
	SYN VIS		Displays the softkeys for enabling or disabling Synthetic Vision features
		PATHWAY	Displays rectangular boxes representing the horizontal and vertical flight path of the active flight plan
		SYN TERR	Enables synthetic terrain depiction
		HRZN HDG	Displays compass heading along the Zero-Pitch line
		APTSIGNS	Displays position markers for airports within approximately 15 nm of the current aircraft position. Airport identifiers are displayed when the airport is within approximately 9 nm.
	DFLTS		Resets PFD to default settings, including changing units to standard
	WIND		Displays softkeys to select wind data parameters
		OPTN 1	Wind direction arrows with headwind/tailwind and crosswind components
		OPTN 2	Wind direction arrow and speed
		OPTN 3	Wind direction arrow with headwind/tailwind and crosswind components
		OFF	Information not displayed
	DME		Displays the DME information window
	BRG1		Cycles the Bearing 1 Information Window through NAV1, GPS/waypoint identifier and GPS-derived distance information, and ADF/frequency.
	HSI FRMT		Provides access to the HSI formatting softkeys

Level 1	Level 2	Level 3	Description
		360 HSI	Displays the HSI in a 360 degree view
		ARC HSI	Displays the HSI as an arc
	BRG2		Cycles the Bearing 2 Information Window through NAV2 or GPS waypoint identifier and GPS-derived distance information, and ADF/frequency.
	ALT UNIT		Displays softkeys for setting the altimeter and BARO settings to metric units
		METERS	When enabled, displays altimeter in meters
		IN	Select to display the BARO setting as inches of mercury
		HPA	Select to display the BARO setting as hectopascals
	STD BARO		Sets barometric pressure to 29.92 in Hg (1013 hPa if metric units are selected)
OBS			Selects OBS mode on the CDI when navigating by GPS (only available with active leg)
CDI			Cycles through GPS, VOR1, and VOR2 navigation modes on the CDI
ADF/DME			Displays the ADF/DME Tuning Window, allowing tuning of the ADF, ADF Mode selection, ADF volume control, and selection of the DME
XPDR			Displays transponder mode selection softkeys
	XPDR1		Selects the #1 transponder as active
	XPDR2		Selects the #2 transponder as active
	STBY		Selects standby mode (transponder does not reply to any interrogations)
	ON		Selects Mode A (transponder replies to interrogations)
	ALT		Selects Mode C – altitude reporting mode (transponder replies to identification and altitude interrogations)
	GND		Manually selects Ground Mode, the transponder does not allow Mode A and Mode C replies, but it does permit acquisition squitter and replies to discretely addressed Mode S interrogations
	VFR		Automatically enters the VFR code (1200 in the U.S.A. only)
	CODE		Displays transponder code selection softkeys 0-7
		0 — 7	Use numbers to enter code
		BKSP	Removes numbers entered, one at a time
IDENT			Activates the Special Position Identification (SPI) pulse for 18 seconds, identifying the transponder return on the ATC screen
TMR/REF			Displays Timer/References Window
NRST			Displays Nearest Airports Window
MSG			Displays Messages Window

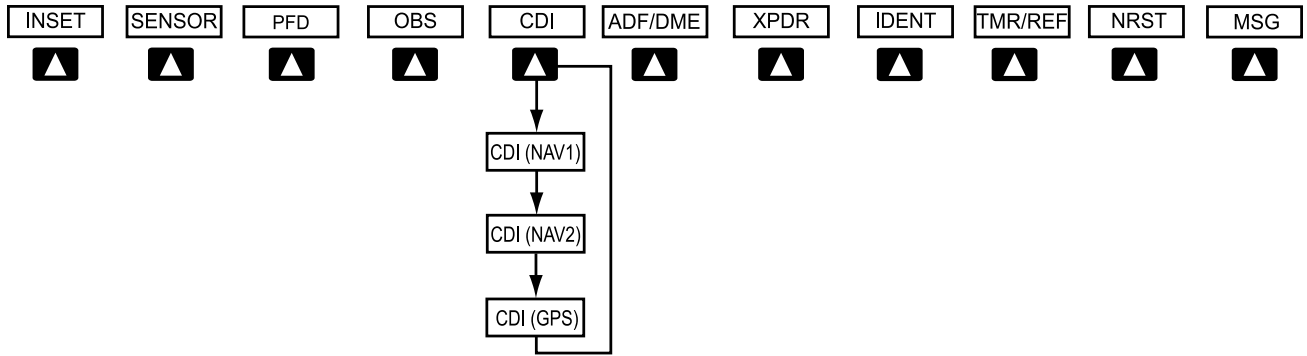

Figure 1-16 Top Level PFD Softkeys

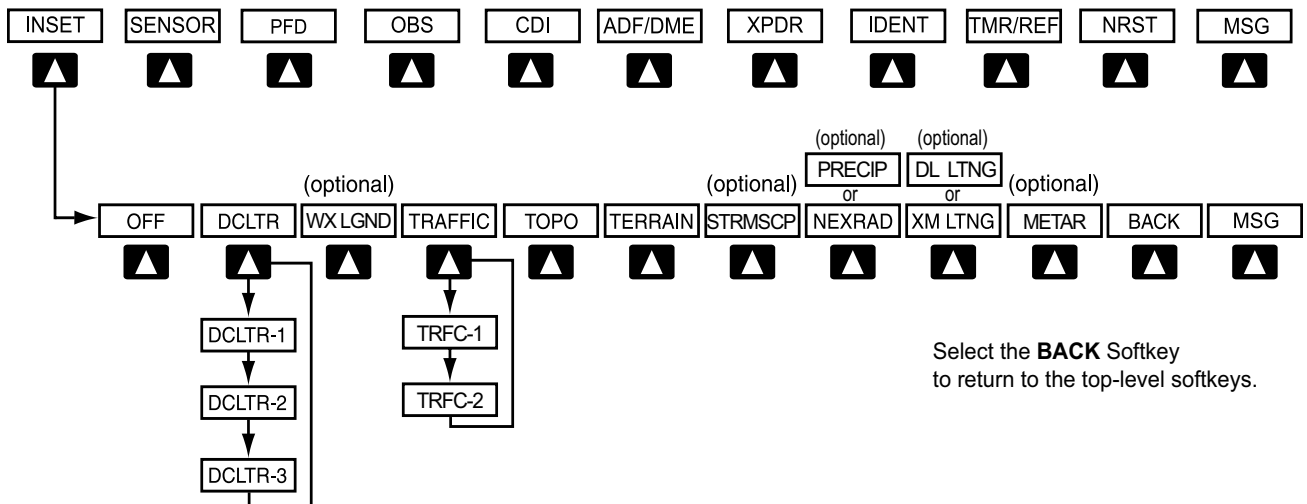

Figure 1-17 INSET Softkeys

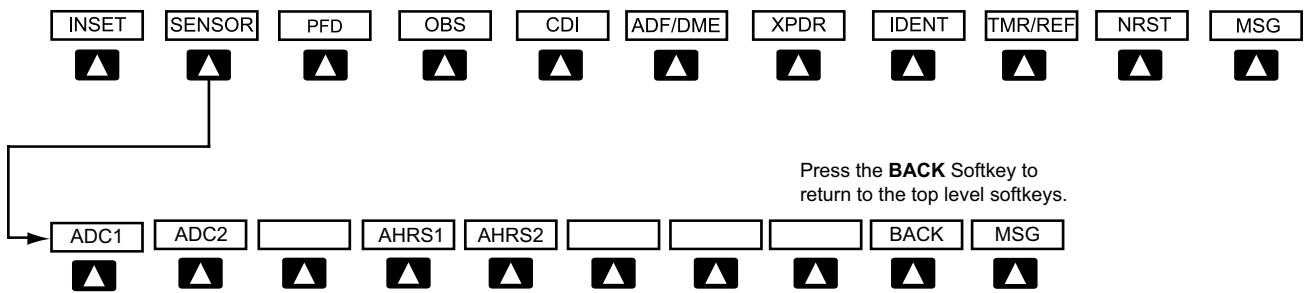

Figure 1-18 SENSOR Softkeys

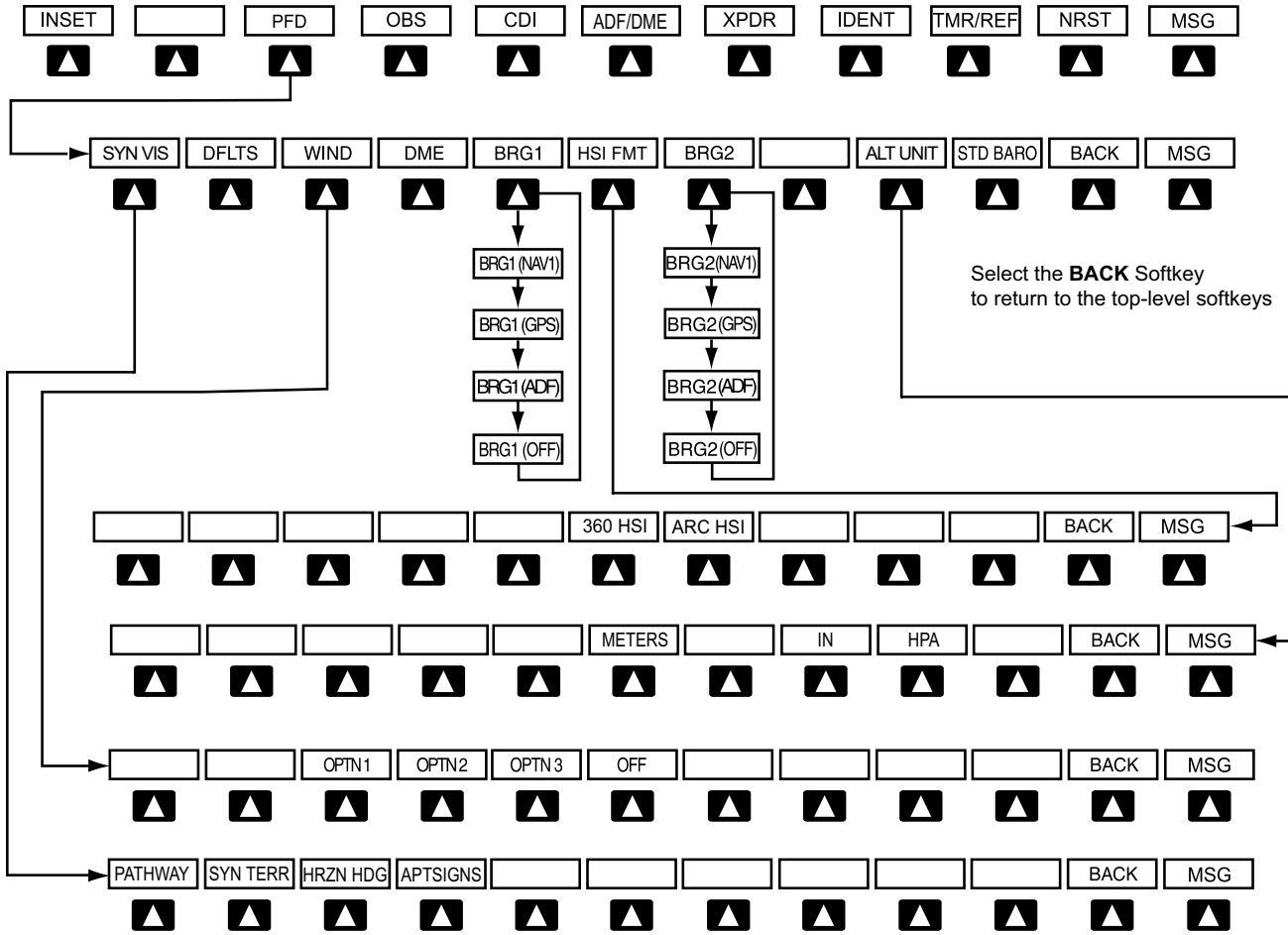

Figure 1-19 PFD Configuration Softkeys

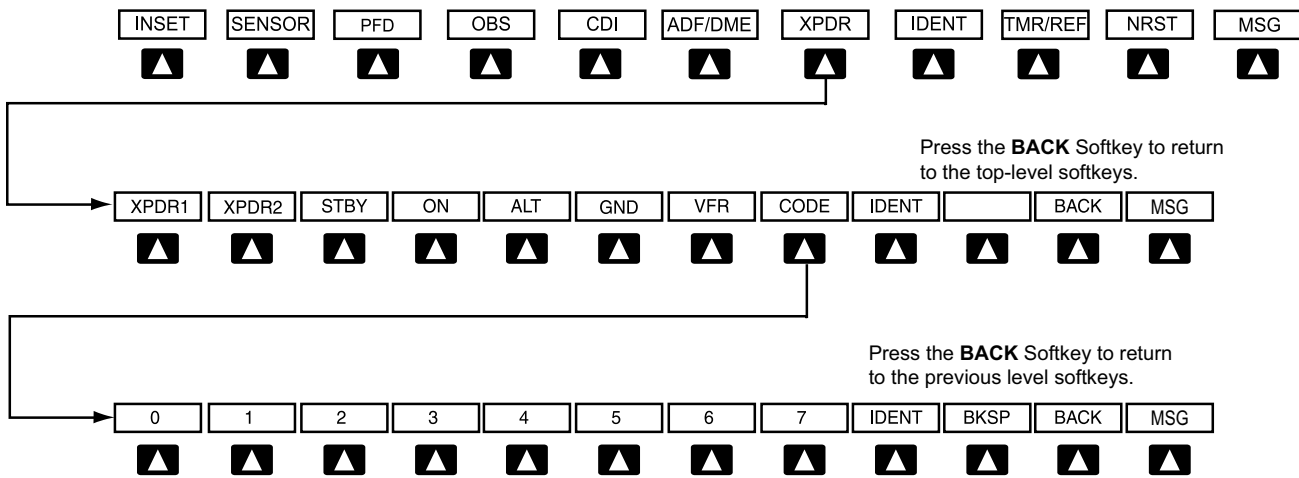

Figure 1-20 XPDR Softkeys

MFD SOFTKEYS

Level 1	Level 2	Description
SYSTEM		Accesses the Synoptics page softkeys
	ELEC	Displays the Electrical Synoptics Page
	FUEL	Displays the Fuel Synoptics Page
	GEN	Displays the General Synoptics Page for the anti-ice system and doors
CAS		Accesses the CAS scrolling softkeys.
	CAS ↑	Scroll up (Displayed only when a sufficient number of items are displayed in the Crew Alerting System Display to warrant scrolling)
	CAS ↓	Scroll down (Displayed only when a sufficient number of items are displayed in the Crew Alerting System Display to warrant scrolling)
MAP		Enables second-level Navigation Map softkeys
	TRAFFIC	Displays traffic information on Navigation Map
	PROFILE	Displays/removes Profile View on Navigation Map Page
	TOPO	Displays topographical data (e.g., coastlines, terrain, rivers, lakes) and elevation scale on Navigation Map
	TERRAIN	Displays terrain information on Navigation Map
	AIRWAYS	Displays airways on the map; cycles through the following: AIRWAYS: No airways are displayed AIRWY ON: All airways are displayed AIRWY LO: Only low altitude airways are displayed AIRWY HI: Only high altitude airways are displayed
	STRMSCP	Displays Stormscope weather and coverage information on Navigation Map (optional feature)
	NEXRAD or PRECIP	Displays NEXRAD weather and coverage information on the Navigation Map (optional) Displays GFDS precipitation on Navigation Map (optional)
	XM LTNG or DL LTNG	Displays XM WX lightning information on the Navigation Map (optional) Displays GFDS Worldwide Weather lightning information on the Navigation Map (optional)
	METAR	Displays METAR flags on airport symbols shown on the Navigation Map
	LEGEND	Displays the legend for the selected weather products. Available only when NEXRAD, XM LTNG, and/or METAR softkeys are selected.
	BACK	Returns to top-level softkeys
DCLTR (3)		Selects desired amount of map detail; cycles through declutter levels: DCLTR (No Declutter): All map features visible DCLTR-1: Declutters land data DCLTR-2: Declutters land and SUA data DCLTR-3: Removes everything except the active flight plan

Level 1	Level 2	Description
SHW CHRT		When available, displays optional airport and terminal procedure charts
CHKLIST		When available, displays optional checklists

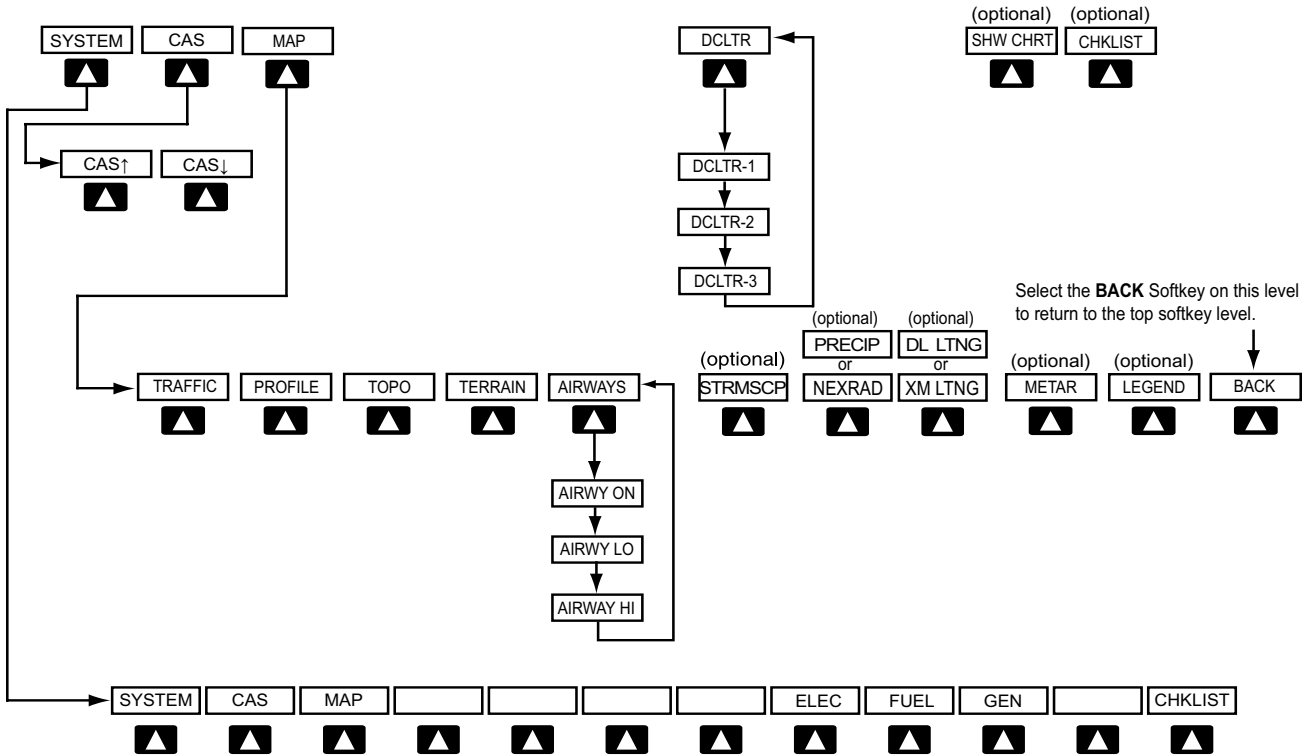

Figure 1-21 MFD Softkeys

GPS RECEIVER OPERATION

Each GIA 63W Integrated Avionics Unit (IAU) contains a GPS receiver. Information collected by the specified receiver (GPS1 for the #1 IAU or GPS2 for the #2 IAU) may be viewed on the AUX - GPS Status Page.

GPS1 provides information to the pilot-side PFD and GPS2 provides data to the copilot-side PFD. Internal system checking is performed to ensure both GPS receivers are providing accurate data to the PFDs. In some circumstances, both GPS receivers may be providing accurate data, but one receiver may be providing a better GPS solution than the other receiver. In this case the GPS receiver producing the better solution is automatically coupled to both PFDs. “BOTH ON GPS 1” or “BOTH ON GPS 2” are then displayed in the Reversionary Sensor Window (see Appendix A) indicating which GPS receiver is being used. Both GPS receivers are still functioning properly, but one receiver is performing better than the other at that particular time.

These GPS sensor annunciations are most often seen after system power-up when one GPS receiver has acquired satellites before the other, or one of the GPS receivers has not yet acquired an SBAS (Satellite Based Augmentation System) signal. While the aircraft is on the ground, the SBAS signal may be blocked by obstructions causing one GPS receiver to have difficulty acquiring a good signal. Also, while airborne, turning the aircraft may result in one of the GPS receivers temporarily losing the SBAS signal.

If the sensor annunciation persists, check for a system failure message in the Messages Window on the PFD. If no failure message exists, check the GPS Status Page and compare the information for GPS1 and GPS2. Discrepancies may indicate a problem.

Viewing GPS receiver status information

- 1) Use the large **FMS** Knob to select the Auxiliary Page Group (see Section 1.7 for information on navigating MFD page groups).
- 2) Use the small **FMS** Knob to select GPS Status Page.

Selecting the GPS receiver for which data may be reviewed

- 1) Use the **FMS** Knob to select the AUX - GPS Status Page.
- 2) To change the selected GPS receiver:
 - a) Select the desired **GPS** Softkey.
 - Or:
 - a) Press the **MENU** Key.
 - b) Use the **FMS** Knob to highlight the receiver which is not selected and press the **ENT** Key.

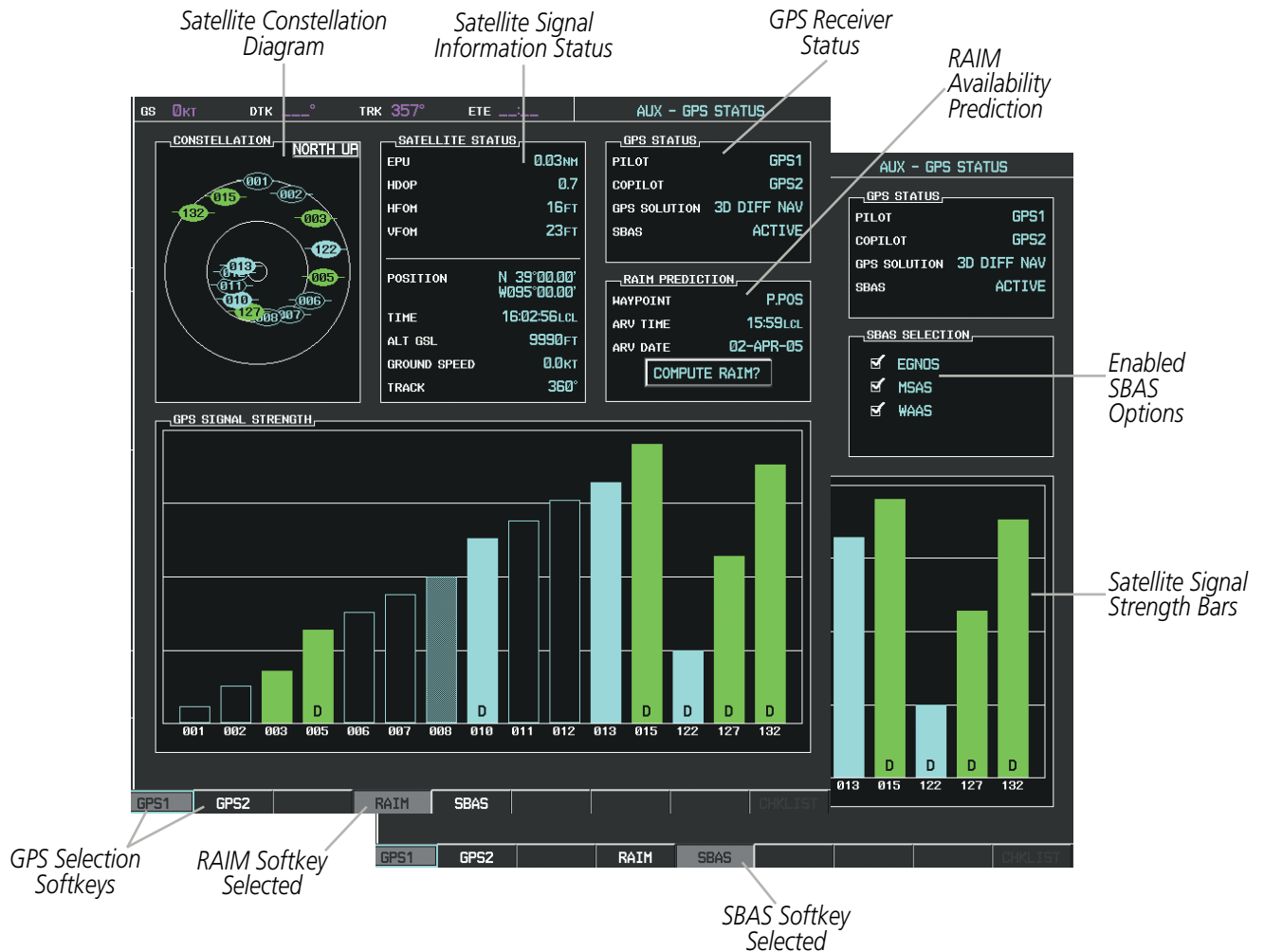

Figure 1-22 GPS Status Page (RAIM or SBAS Selected)

The GPS Status Page provides the following information:

- Satellite constellation diagram

Satellites currently in view are shown at their respective positions on a sky view diagram. The sky view is always in a north-up orientation, with the outer circle representing the horizon, the inner circle representing 45° above the horizon, and the center point showing the position directly overhead.

Each satellite is represented by an oval containing the Pseudo-random noise (PRN) number (i.e., satellite identification number). Satellites whose signals are currently being used are represented by solid ovals.

- Satellite signal information status

The accuracy of the aircraft's GPS fix is calculated using Estimated Position Uncertainty (EPU), Dilution of Precision (DOP), and horizontal and vertical figures of merit (HFOM and VFOM). EPU is the radius of a circle centered on an estimated horizontal position in which actual position has 95% probability of laying. EPU is a statistical error indication and not an actual error measurement.

DOP measures satellite geometry quality (i.e., number of satellites received and where they are relative to each other) on a range from 0.0 to 9.9, with lower numbers denoting better accuracy. HFOM and VFOM, measures of horizontal and vertical position uncertainty, are the current 95% confidence horizontal and vertical accuracy values reported by the GPS receiver.

The current calculated GPS position, time, altitude, ground speed, and track for the aircraft are displayed below the satellite signal accuracy measurements.

- GPS receiver status

The GPS solution type (ACQUIRING, 2D NAV, 2D DIFF NAV, 3D NAV, 3D DIFF NAV) for the active GPS receiver (GPS1 or GPS2) is shown in the upper right of the GPS Status Page. When the receiver is in the process of acquiring enough satellite signals for navigation, the receiver uses satellite orbital data (collected continuously from the satellites) and last known position to determine the satellites that should be in view. ACQUIRING is indicated as the solution until a sufficient number of satellites have been acquired for computing a solution.

When the receiver is in the process of acquiring a 3D differential GPS solution, 3D NAV is indicated as the solution until the 3D differential fix has finished acquisition. SBAS (Satellite-Based Augmentation System) indicates INACTIVE. When acquisition is complete, the solution status indicates 3D DIFF NAV and SBAS indicates ACTIVE.

- RAIM (Receiver Autonomous Integrity Monitoring) Prediction (**RAIM** Softkey is selected)

In most cases performing a RAIM prediction is not necessary. However, in some cases, the selected approach may be outside the SBAS coverage area and it may be necessary to perform a RAIM prediction for the intended approach.

Receiver Autonomous Integrity Monitoring (RAIM) is a GPS receiver function that performs a consistency check on all tracked satellites. RAIM ensures that the available satellite geometry allows the receiver to calculate a position within a specified RAIM protection limit (2.0 nautical miles for oceanic and enroute, 1.0 nm for terminal, and 0.3 nm for non-precision approaches). During oceanic, enroute, and terminal phases of flight, RAIM is available nearly 100% of the time.

The RAIM prediction function also indicates whether RAIM is available at a specified date and time. RAIM computations predict satellite coverage within ±15 min of the specified arrival date and time.

Because of the tighter protection limit on approaches, there may be times when RAIM is not available. The G1000 automatically monitors RAIM and warns with an alert message when it is not available. If RAIM is not predicted to be available for the final approach course, the approach does not become active, as indicated by the messages “Approach is not active” and “RAIM not available from FAF to MAP”. If RAIM is not available when crossing the FAF, the missed approach procedure must be flown.

Predicting RAIM availability

- 1) Select the GPS Status Page.
- 2) If necessary, select the **RAIM** Softkey.
- 3) Press the **FMS** Knob. The ‘WAYPOINT’ field is highlighted.
- 4) Turn the small **FMS** Knob to display the Waypoint Information Window.
- 5) Enter the desired waypoint:
 - a) Use the **FMS** Knob to enter the desired waypoint by identifier, facility, or city name and press the **ENT** Key. Refer to Section 1.7 for instructions on entering alphanumeric data into the G1000.
- Or:**
 - a) Use the large **FMS** Knob to scroll to the Most Recent Waypoints List.
 - b) Use the small **FMS** Knob to highlight the desired waypoint in the list and press the **ENT** Key. The G1000 automatically fills in the identifier, facility, and city fields with the information for the selected waypoint.
 - c) Press the **ENT** Key to accept the waypoint entry.
- 6) Use the **FMS** Knob to enter an arrival time and press the **ENT** Key.
- 7) Use the **FMS** Knob to enter an arrival date and press the **ENT** Key.
- 8) With the cursor highlighting ‘COMPUTE RAIM?’, press the **ENT** Key. Once RAIM availability is computed, one of the following is displayed:
 - ‘COMPUTE RAIM?’—RAIM has not been computed for the current waypoint, time, and date combination
 - ‘COMPUTING AVAILABILITY’—RAIM calculation in progress
 - ‘RAIM AVAILABLE’—RAIM is predicted to be available for the specified waypoint, time, and date
 - ‘RAIM NOT AVAILABLE’—RAIM is predicted to be unavailable for the specified waypoint, time, and date

Predicting RAIM availability at present position

- 1) Select the GPS Status Page.
- 2) If necessary, select the **RAIM** Softkey.
- 3) Press the **FMS** Knob. The ‘WAYPOINT’ field is highlighted.
- 4) Press the **MENU** Key.
- 5) With ‘Set WPT to Present Position’ highlighted, press the **ENT** Key.
- 6) Press the **ENT** Key to accept the waypoint entry.
- 7) Use the **FMS** Knob to enter an arrival time and press the **ENT** Key.

- 8) Use the **FMS** Knob to enter an arrival date and press the **ENT** Key.
 - 9) With the cursor highlighting 'COMPUTE RAIM?', press the **ENT** Key. Once RAIM availability is computed, one of the following is displayed:
 - 'COMPUTE RAIM?'—RAIM has not been computed for the current waypoint, time, and date combination
 - 'COMPUTING AVAILABILITY'—RAIM calculation in progress
 - 'RAIM AVAILABLE'—RAIM is predicted to be available for the specified waypoint, time, and date
 - 'RAIM NOT AVAILABLE'—RAIM is predicted to be unavailable for the specified waypoint, time, and date
- SBAS Selection (**SBAS** Softkey is pressed)(WAAS, EGNOS, or MSAS capable systems only)

In certain situations, such as when the aircraft is outside or on the fringe of the WAAS, EGNOS, or MSAS coverage area, it may be desirable to disable the reception of the applicable SBAS signal (although it is not recommended). When disabled, the SBAS field in the GPS Status box indicates DISABLED. There may be a small delay for the GPS Status box to be updated upon WAAS, EGNOS, and MSAS enabling/disabling.

Disabling WAAS, EGNOS or MSAS

- 1) Select the GPS Status Page.
 - 2) If necessary, select the **SBAS** Softkey.
 - 3) Press the **FMS** Knob, and turn the large FMS Knob to highlight the desired SBAS system.
 - 4) Press the **ENT** Key to uncheck the box.
 - 5) Press the **FMS** Knob to remove the cursor.
- GPS Satellite Signal Strengths

The GPS Status Page can be helpful in troubleshooting weak (or missing) signal levels due to poor satellite coverage or installation problems. As the GPS receiver locks onto satellites, a signal strength bar is displayed for each satellite in view, with the appropriate satellite PRN number (01-32 or 120-138 for WAAS) below each bar. The progress of satellite acquisition is shown in three stages, as indicated by signal bar appearance:

 - No bar—Receiver is looking for the indicated satellite
 - Hollow bar—Receiver has found the satellite and is collecting data
 - Light blue bar—Receiver has collected the necessary data and the satellite signal can be used
 - Green bar—Satellite is being used for the GPS solution
 - Checkered bar—Receiver has excluded the satellite (Fault Detection and Exclusion)
 - "D" indication—Denotes the satellite is being used as part of the differential computations

Each satellite has a 30-second data transmission that must be collected (signal strength bar is hollow) before the satellite may be used for navigation (signal strength bar becomes solid).

1.7 ACCESSING G1000 FUNCTIONALITY

MENUS

The G1000 has a **MENU** Key that, when pressed, displays a context-sensitive list of options. This options list allows the user to access additional features or make settings changes which specifically relate to the currently displayed window/page. There is no all-encompassing menu. Some menus provide access to additional submenus that are used to view, edit, select, and review options. Menus display 'NO OPTIONS' when there are no options for the window/page selected. The main controls used in association with all window/page group operations are described in section 1.3. Softkey selection does not display menus or submenus.

To navigate the Page Menu Window:

- 1) Press the **MENU** Key to display the Page Menu Window.
- 2) Turn the **FMS** Knob to scroll through a list of available options (a scroll bar appears to the right of the window when the option list is longer than the window).
- 3) Press the **ENT** Key to select the desired option.
- 4) The **CLR** Key may be pressed to remove the menu and cancel the operation. Pressing the **FMS** Knob also removes the displayed menu.

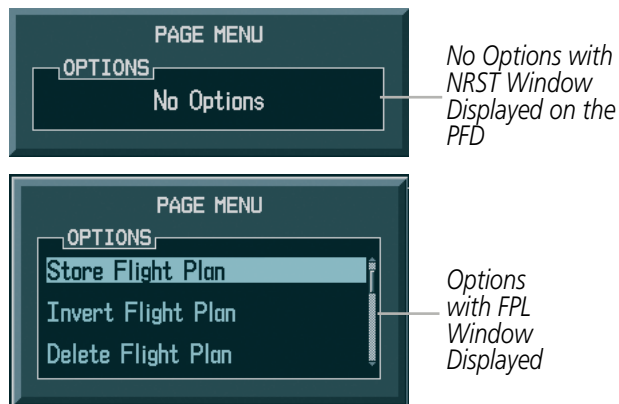

Figure 1-23 Page Menu Examples

MFD PAGE GROUPS



NOTE: Refer to the *Flight Management, Hazard Avoidance, and Additional Features* sections for details on specific pages.

Information on the MFD is presented on pages which are grouped according to function. The page group and active page title are displayed in the upper center of the screen, below the Navigation Status Box. In the bottom right corner of the screen, a page group window is displayed by turning either **FMS** Knob. The page group tabs are displayed along the bottom of the window. The page titles are displayed in a list above the page group tabs. The current page group and current page within the group are shown in light blue. For some of these pages

(Airport/Procedures/Weather Information, XM, Procedure Loading), the active title of the page changes while the page name in the list remains the same.

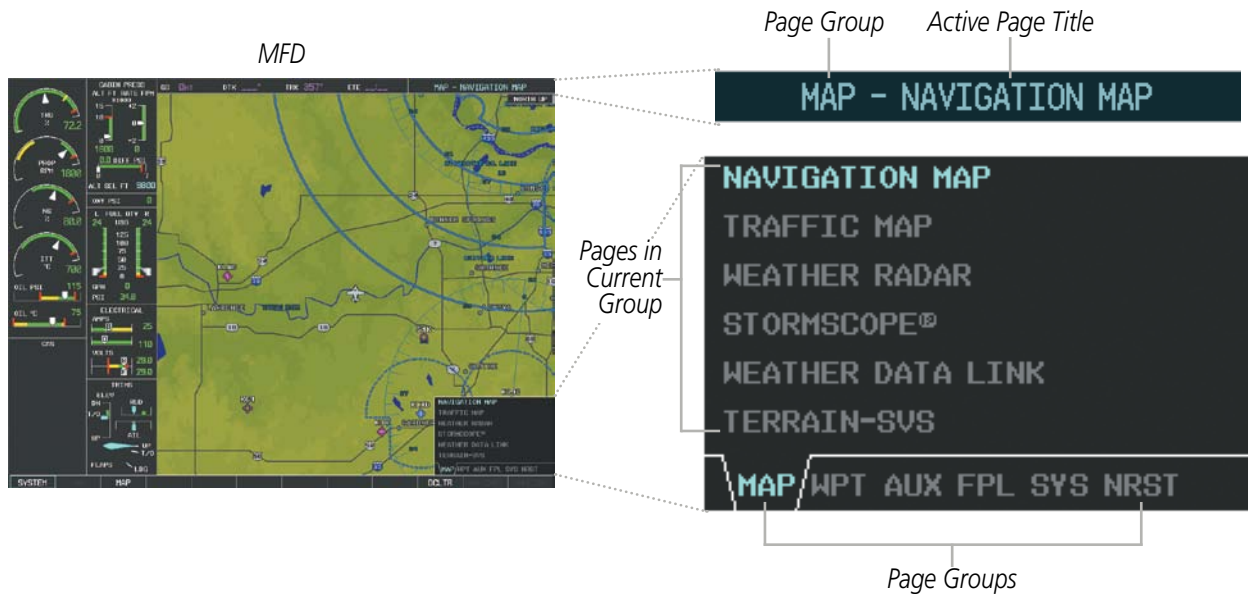

Figure 1-24 Page Title and Page Groups

The main page groups are navigated using the **FMS** Knob; specific pages within each group can vary depending on the configuration of optional equipment.

Selecting a page using the FMS Knob:

- 1) Turn the large **FMS** Knob to display the list of page groups; continue turning the large **FMS** Knob until the desired page group is selected
- 2) Turn the small **FMS** Knob to display the desired page within a specific page group.

There are also several pages (Airport/Procedures/Weather Information and XM pages) which are selected first from within a main page group with the **FMS** Knob, then with the appropriate softkey at the bottom of the page (or from the page menu). In this case, the page remains set to the selected page until a different page softkey is selected, even if a different page group is selected.

Map Pages (MAP)

- Navigation Map
- Traffic Map
- Stormscope®
- Weather Radar
- Weather Data Link
(service optional)
- Terrain Proximity,
Terrain-SVS, or TAWS

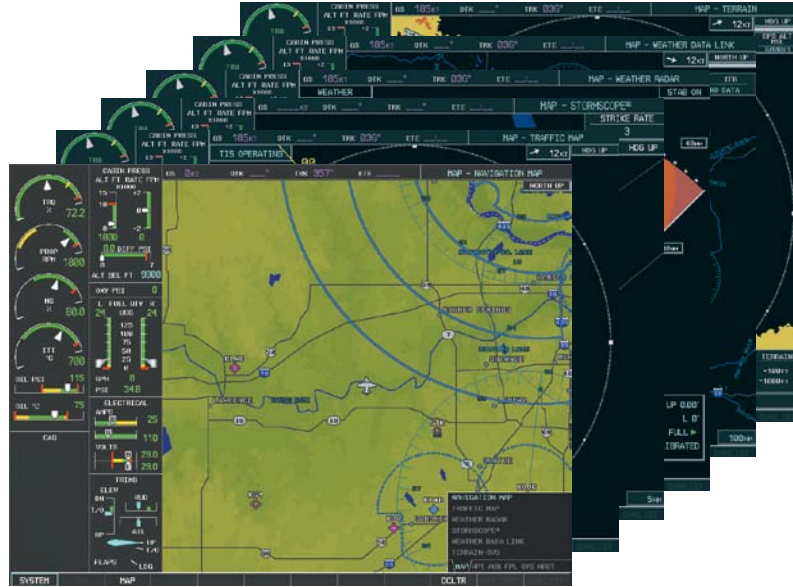
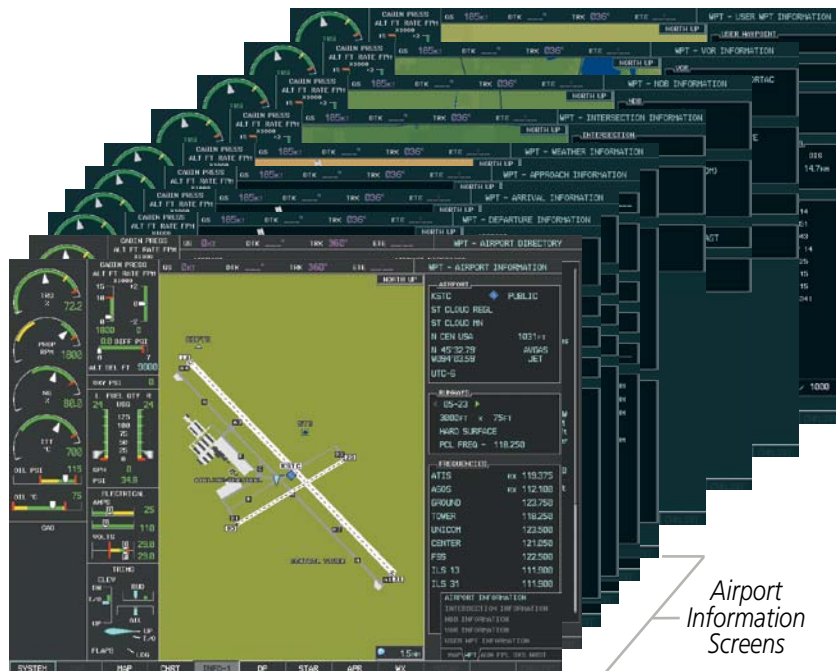

Figure 1-25 Map Pages

Waypoint Pages (WPT)

- Airport Information screens
 - Airport Information
(**INFO-1** Softkey)
 - Airport Directory
(**INFO-2** Softkey)
 - Departure Information
(**DP** Softkey)
 - Arrival Information
(**STAR** Softkey)
 - Approach Information
(**APR** Softkey)
 - Weather Information
(**WX** Softkey)
- Intersection Information
- NDB Information
- VOR Information
- User Waypoint Information



Airport Information Screens

Figure 1-26 Waypoint Pages

Auxiliary Pages (AUX)

- Weight Planning
- Trip Planning
- Utility
- GPS Status
- System Setup
- SiriusXM Satellite Radio screens
 - XM Information (**INFO** Softkey)
 - XM Radio (**RADIO** Softkey)
- Satellite Phone
- System Status

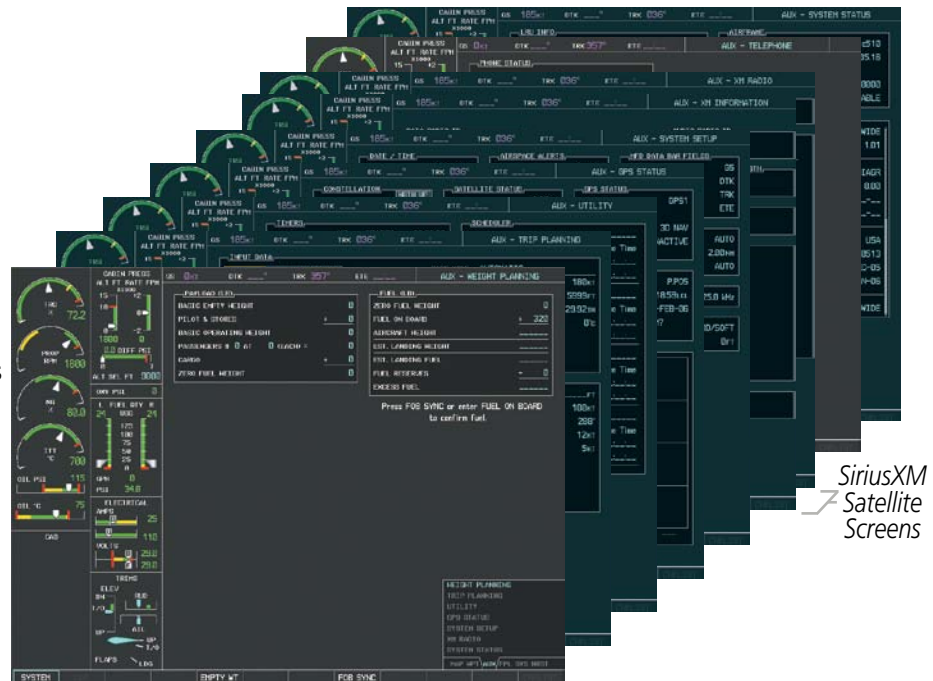

Figure 1-27 Auxiliary Pages

Flight Plan Pages (FPL)

- Active Flight Plan
 - Wide View, Narrow View (**VIEW** Softkey)
- Flight Plan Catalog
 - Stored Flight Plan (**NEW** Softkey)



Figure 1-28 Flight Plan Pages

The Flight Plan Pages may also be accessed using the **FPL** Key. Main pages within this group are selected by turning the small **FMS** Knob.

System Pages (SYS)

System Synoptic Displays

- Electrical System
(also select **ELEC** Softkey)
- Fuel System
(also select **FUEL** Softkey)
- General System Information
(also select **GEN** Softkey)



Figure 1-29 System Pages

The System Pages may also be accessed by selecting the **SYSTEM** Softkey when viewing the other page groups. Main pages within this group are shown by selecting the applicable softkey or turning the small **FMS** Knob.

Nearest Pages (NRST)

- Nearest Airports
- Nearest Intersections
- Nearest NDB
- Nearest VOR
- Nearest User Waypoints
- Nearest Frequencies
- Nearest Airspaces



Figure 1-30 Nearest Pages

The Procedure pages may be accessed at any time on the MFD by pressing the **PROC** Key. A menu is initialized, and when a departure, approach, or arrival is selected, the appropriate Procedure Loading Page is opened. Turning the **FMS** Knob does not scroll through the Procedure pages (note the single page icon in the lower right corner).

Procedure Pages (PROC)

Departure Loading

Arrival Loading

Approach Loading



Figure 1-31 Procedure Pages

For some of these pages (Airport Information screens, SiriusXM Satellite screens, Procedure Pages), the title of the page may change while the page icon remains the same.

MFD SYSTEM PAGES

In the Auxiliary (AUX) Page Group, there are two system pages: System Setup (page 5 of 6) and System Status (page 6 of 6). The System Setup Page allows management of various system parameters, while the System Status Page displays the status of all G1000 System LRUs.

SYSTEM SETUP PAGE

The System Setup Page allows management of the following system parameters:

- Pilot Profiles
- Date/time
- Display Units (see Flight Instruments Section)
- Baro Transition Alert (see Flight Instruments Section)
- Airspace Alerts (see Flight Management Section)
- Arrival Alerts
- Audio Alerts
- Flight Director
- Page Navigation
- MFD Data Bar Fields (Navigation Status Box) (see Flight Management Section)
- GPS CDI scaling for GPS navigation source (see Flight Instruments Section)
- COM Configuration (see Audio Panel and CNS Section)
- Nearest Airports display criteria (see Flight Management Section)
- Synchronization of Baro and CDI between PFDs

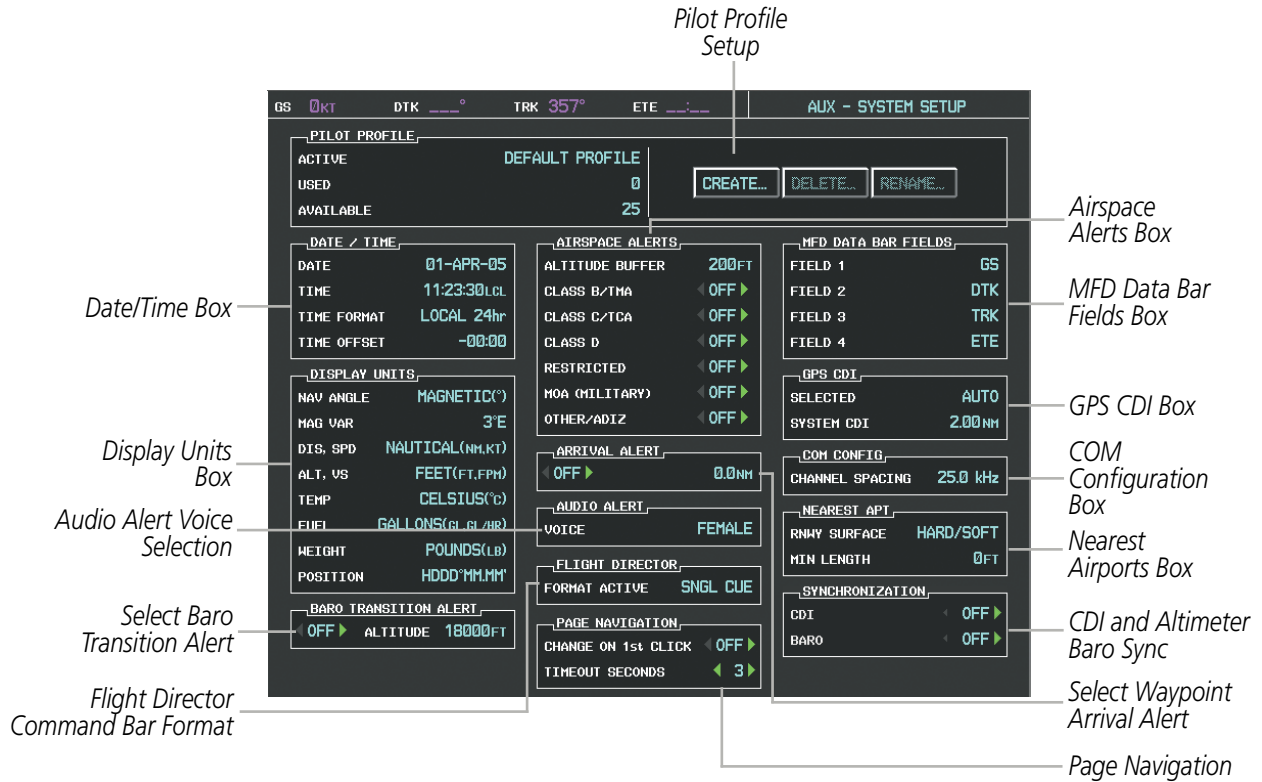

Figure 1-32 System Setup Page

DATE/TIME

The Date/Time Box on the System Setup Page displays the current date and time and allows the pilot to set the time format (local 12-hr, local 24-hr, or UTC) and offset. The time offset is used to define current local time. UTC (also called “GMT” or “Zulu”) date and time are calculated directly from the GPS satellites signals and cannot be changed. When using a local time format, designate the offset by adding or subtracting the desired number of hours.

To set the system time format:

- 1) While on the System Setup Page, press the **FMS** Knob momentarily to activate the flashing cursor.
- 2) Turn the large **FMS** Knob to highlight the time format field in the Date/Time Box.
- 3) Turn the small **FMS** Knob to select the desired system time format (local 12hr, local 24hr, UTC) and press the **ENT** Key.

To set the current time offset:

- 1) While on the System Setup Page, press the **FMS** Knob momentarily to activate the flashing cursor.
- 2) Turn the large **FMS** Knob to highlight the time offset field in the Date/Time Box.
- 3) Turn the **FMS** Knobs to enter the time offset and press the **ENT** Key.

DISPLAY UNITS

The Display Units Box on the System Setup Page allows configuration of the measurement units used for the following displayed data:

- Nav angle (magnetic, true)
 - Affects the BRG field in the PFD Navigation Status Box.
 - Affects the BRG, DTK, TKE, TRK, and XTK fields in the MFD Navigation Status Box.
 - When set to 'AUTO', magnetic variation is figured into the displayed value. When 'TRUE' is selected, no magnetic variation is calculated and a 'T' is displayed next to the value.
- Distance and speed (metric, nautical)
 - Affects the DIS field in the PFD Navigation Status Box and the range setting of the Inset Map.
 - Affects all distance and speed displays on the MFD with the exception of the displayed wind speed displayed on the Navigation Map Page. Wind speed is affected on the Trip Planning Page.
- Altitude and vertical speed (feet, meters)
 - Affects the Altitude and Vertical Speed References in the AFCS Status Box on the PFD.
 - Affects all altitude and elevation displays on the MFD, with the exception of VNAV altitudes on the Active Flight Plan Page.
- Barometric pressure (inches of mercury, hectopascals)
 - Affects the altimeter setting on the PFD and the pressure display on the Trip Planning Page.
- Temperature (Celsius, Fahrenheit)
 - Affects all temperature displays on the PFD.
 - Affects the temperature display on the Trip Planning Page. Does not affect the Engine Indicating System display.
- Fuel and fuel flow (gallons, imperial gallons, liters, pounds, kilograms)
 - Affects all fuel and fuel flow displays.
- Weight (pounds, kilograms)
 - Affects aircraft weights on the Weight Planning Page.
- Position (HDDD°MM.MM', HDDD°MM'SS.S", MGRS, UTM/UPS)
 - Affects all position displays.

To change a Display Units setting:

- 1) While on the System Setup Page, press the **FMS** Knob momentarily to activate the flashing cursor.
- 2) Turn the large **FMS** Knob to highlight the desired field in the Display Units Box.
- 3) Turn the small **FMS** Knob to select from a list of measurement units and press the **ENT** Key when the desired unit is highlighted. Press the **CLR** Key to cancel the action without changing the units.

BARO TRANSITION ALERT

See the Flight Instruments section for a discussion on setting the Baro Transition Alert.

AIRSPACE ALERTS

The Airspace Alerts Box allows the pilot to turn the controlled/special-use airspace message alerts on or off. This does not affect the alerts listed on the Nearest Airspaces Page or the airspace boundaries depicted on the MFD Navigation Map Page. It simply turns on/off the warning provided when the aircraft is approaching or near an airspace.

Alerts for the following airspaces can be turned on/off in the Airspace Alerts Box:

- Class B/TMA
- Class C/TCA
- Class D
- Restricted
- MOA (Military)
- Other airspaces

An altitude buffer is also provided which “expands” the vertical range above or below an airspace. For example, if the buffer is set at 500 feet, and the aircraft is more than 500 feet above/below an airspace, an alert message is not generated, but if the aircraft is less than 500 feet above/below an airspace and projected to enter it, the pilot is notified with an alert message. The default setting for the altitude buffer is 200 feet.

To change the altitude buffer distance setting:

- 1) While on the System Setup Page, press the **FMS** Knob momentarily to activate the flashing cursor.
- 2) Turn the large **FMS** Knob to highlight the altitude buffer field in the Airspace Alerts Box.
- 3) Turn the **FMS** Knobs to enter an altitude buffer value and press the **ENT** Key.

To turn an airspace alert on or off:

- 1) While on the System Setup Page, press the **FMS** Knob momentarily to activate the flashing cursor.
- 2) Turn the large **FMS** Knob to highlight the desired field in the Airspace Alerts Box.
- 3) Turn the small **FMS** Knob clockwise to turn the airspace alert ON or counterclockwise to turn the alert OFF.

ARRIVAL ALERTS

The Arrival Alert Box on the System Setup Page allows arrival alerts to be turned on/off and the alert trigger distance set. An arrival alert can be set to notify the pilot with a message upon reaching a user-specified distance from the final destination (the direct-to waypoint or the last waypoint in a flight plan). Once the set distance (up to 99.9 units) has been reached, an “Arrival at [waypoint]” message is displayed in the PFD Navigation Status Box.

Enabling/disabling an arrival alert:

- 1) Use the **FMS** Knob to select the AUX - System Setup Page.
- 2) Press the **FMS** Knob momentarily to activate the flashing cursor.
- 3) Turn the large **FMS** Knob to select the ON/OFF field in the Arrival Alert Box.

- 4) Turn the small **FMS** Knob clockwise to turn the airspace alert ON or counterclockwise to turn the alert OFF.
- 5) Press the **FMS** Knob to deactivate the cursor.

Changing the arrival alert trigger distance:

- 1) Use the **FMS** Knob to select the AUX - System Setup Page.
- 2) Press the **FMS** Knob momentarily to activate the flashing cursor.
- 3) Turn the large **FMS** Knob to highlight the distance field in the Arrival Alert Box.
- 4) Use the **FMS** Knob to enter a trigger distance and press the **ENT** Key.
- 5) Press the **FMS** Knob to deactivate the cursor.

AUDIO ALERTS

The Audio Alert Box on the System Setup Page allows the audio alert voice to be set to male or female.

To change the audio alert voice:

- 1) While on the System Setup Page, press the **FMS** Knob momentarily to activate the flashing cursor.
- 2) Turn the large **FMS** Knob to highlight the voice in the Audio Alert Box.
- 3) Turn the small **FMS** Knob to display and highlight the desired voice and press the **ENT** Key.

FLIGHT DIRECTOR

Not pilot selectable.

PAGE NAVIGATION

The large **FMS** Knob displays the Page Group Tabs and navigates through the tabs. The small **FMS** Knob navigates through the pages listed within a specific group. The number of clicks it takes to display the Page Group Tabs and change to the next tab can be controlled from the Page Navigation box on the AUX - System Setup Page.

OFF – Displays the Page Group Tabs with one click of the large **FMS** Knob.

ON – Displays the Page Group Tabs and navigates to the next tab with one click of the large **FMS** Knob.

The pilot can select, from the AUX - System Setup Page, the amount of time the Page Group Tabs are displayed (in the lower right corner of the MFD). The timeout can range from two to ten seconds.

Selecting page navigation settings:

- 1) Use the **FMS** Knob to select the AUX - System Setup Page.
- 2) Press the **FMS** Knob momentarily to activate the flashing cursor.
- 3) Turn the large **FMS** Knob to highlight the 'Change On 1st Click' field in the Page Navigation Box.
- 4) Turn the small **FMS** Knob to select 'OFF' or 'ON'.
- 5) Turn the large **FMS** Knob to highlight the 'Timeout Seconds' field in the Page navigation Box.
- 6) Turn the small **FMS** Knob to select the desired number of seconds
- 7) Press the **FMS** Knob momentarily to remove the flashing cursor.

MFD DATA BAR FIELDS

The MFD Data Bar Fields Box on the System Setup Page displays the current configuration of the MFD Navigation Status Box. By default, the Navigation Status Bar is set to display ground speed (GS), distance to next waypoint (DIS), estimated time en route (ETE), and en route safe altitude (ESA).

To change the information shown in an MFD Navigation Status Bar field:

- 1) While on the System Setup Page, press the **FMS** Knob momentarily to activate the flashing cursor.
- 2) Turn the large **FMS** Knob to highlight the desired field number in the MFD Data Bar Fields Box.
- 3) Turn the small **FMS** Knob to display and scroll through the data options list and press the **ENT** Key when the desired data selection is highlighted.

The following data may be selected for display in each of the four fields of the Navigation Status Box.

- Bearing (BRG)
- Distance (DIS)
- Desired Track (DTK)
- En Route Safe Altitude (ESA)
- Estimated Time of Arrival (ETA)
- Estimated Time En Route (ETE)
- Ground Speed (GS)
- Minimum Safe Altitude (MSA)
- True Air Speed (TAS)
- Track Angle Error (TKE)
- Track (TRK)
- Vertical Speed Required (VSR)
- Crosstrack Error (XTK)
- Fuel Over Destination (FOD)
- Fuel On Board (FOB)
- Endurance (END)

GPS CDI

The GPS CDI Box on the System Setup Page allows the pilot to define the range for the on-screen course deviation indicator (CDI). The range values represent full range deflection for the CDI to either side. The default setting is 'AUTO'. At this setting, leaving the departure airport the CDI range is set to 1.0 nm and gradually ramps up to 2 nm beyond 30 nm from the departure airport. The CDI range is set to 2.0 nautical miles during the en route phase of flight. Within 30 nm of the destination airport, the CDI range gradually ramps down to 1.0 nm (terminal area). During approach operations, the CDI range ramps down even further to 0.3 nm. This transition normally occurs within 2.0 nm of the final approach fix (FAF).

If a lower CDI range setting is selected (i.e., 1.0 or 0.3 nm), the higher range settings are not selected during any phase of flight. For example, if 1.0 nm is selected, the system uses this for en route and terminal phases and ramps down to 0.3 nm during an approach. Note that the Receiver Autonomous Integrity Monitoring (RAIM) protection limits follow the selected CDI range and corresponding flight phases.

The GPS CDI Box on the System Setup Page displays the following:

- Selected CDI range (auto, 2 nm, 1 nm, 0.3 nm)
- Current system CDI range (2 nm, 1 nm, 0.3 nm)

Changing the CDI range:

- 1) While on the System Setup Page, press the **FMS** Knob momentarily to activate the flashing cursor.
- 2) Turn the large **FMS** Knob to highlight the selected field in the GPS CDI Box.
- 3) Turn the small **FMS** Knob to display and scroll through the range list and press the **ENT** Key when the desired selection is highlighted.
- 4) Press the **FMS** Knob to deactivate the cursor.

COM CONFIGURATION

NOTE: 8.33 kHz VHF communication frequency channel spacing is not approved for use in the United States. Select the 25.0 kHz channel spacing option for use in the United States.

The COM Configuration Box on the System Setup Page allows the pilot to select 8.33 kHz or 25.0 kHz COM frequency channel spacing.

To change COM channel spacing:

- 1) While on the System Setup Page, press the **FMS** Knob momentarily to activate the flashing cursor.
- 2) Turn the large **FMS** Knob to highlight the channel spacing field in the COM Configuration Box.
- 3) Turn the small **FMS** Knob to select the desired spacing and press the **ENT** Key.

NEAREST AIRPORTS

The Nearest Airports Box on the System Setup Page defines the minimum runway length and surface type used when determining the nine nearest airports to display on the MFD Nearest Airports Page. A minimum runway length and/or surface type can be entered to prevent airports with small runways or runways that are not of appropriate surface from being displayed. Default settings are zero feet (or meters) for runway length and “HARD/SOFT” for runway surface type.

To select nearest airport surface matching criteria (any, hard only, hard/soft, water):

- 1) While on the System Setup Page, press the **FMS** Knob momentarily to activate the flashing cursor.
- 2) Turn the large **FMS** Knob to highlight the runway surface field in the Nearest Airports Box.
- 3) Turn the small **FMS** Knob to display and scroll through the runway options (any, hard only, hard/soft, water) and press the **ENT** Key when the desired selection is highlighted.

To select nearest airport minimum runway length matching criteria:

- 1) While on the System Setup Page, press the **FMS** Knob momentarily to activate the flashing cursor.
- 2) Turn the large **FMS** Knob to highlight the minimum length field in the Nearest Airport Box.
- 3) Turn the **FMS** Knobs to enter the minimum runway length (zero to 99,999 feet) and press the **ENT** Key.

CDI/BARO SYNCHRONIZATION

See the Flight Instruments section for a discussion on synchronizing both PFD's Course Deviation Indicators and the altimeter barometric settings.

PILOT PROFILES

System settings may be saved under a pilot profile. When the system is powered on, the last selected pilot profile is shown on the MFD power-up screen (Figure 1-8). The G1000 can store up to 25 profiles; the currently active profile, the amount of memory used, and the amount of memory available are shown at the top of the System Setup Page in the box labeled 'Pilot Profile'. From here, pilot profiles may be created, selected, renamed, or deleted.

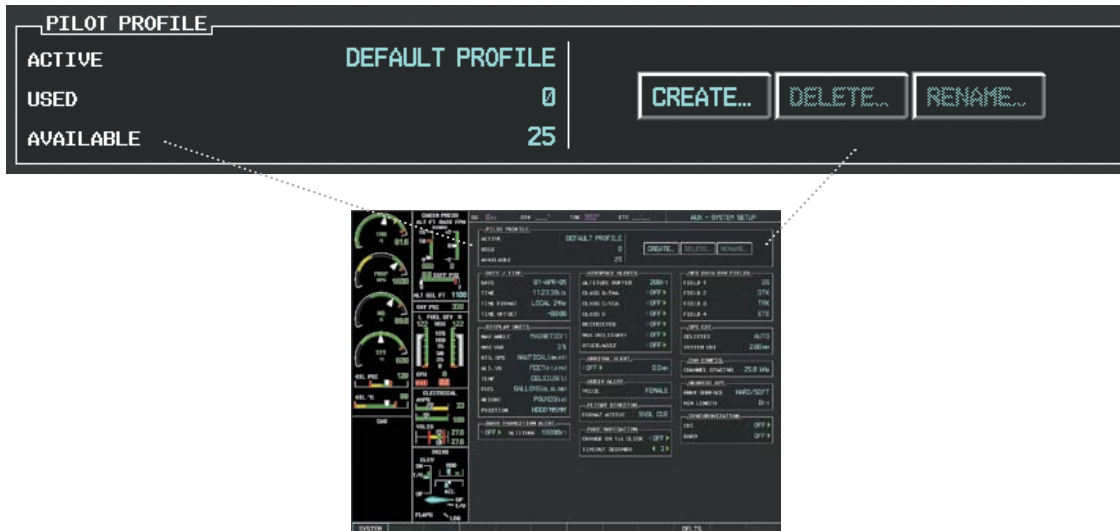

Figure 1-33 Pilot Profiles (System Setup Page)

Creating a profile:

- 1) Use the **FMS** Knob to select the AUX - System Setup Page.
- 2) Press the **FMS** Knob momentarily to activate the flashing cursor.
- 3) Turn the large **FMS** Knob to highlight 'CREATE' in the Pilot Profile Box.
- 4) Press the **ENT** Key. A 'Create Profile' window is displayed.
- 5) Use the **FMS** Knob to enter a profile name up to 16 characters long and press the **ENT** Key. Pilot profile names cannot begin with a blank as the first letter.
- 6) In the next field, use the small **FMS** Knob to select the desired settings upon which to base the new profile. Profiles can be created based on Garmin factory defaults, default profile settings (initially based on Garmin factory defaults unless edited by the pilot), or current system settings.
- 7) Press the **ENT** Key.

- 8) With 'CREATE' highlighted, press the **ENT** Key to create the profile

Or:

Use the large **FMS** Knob to select 'CREATE and ACTIVATE' and press the **ENT** Key to activate the new profile.

- 9) To cancel the process, select 'CANCEL' with the large **FMS** Knob and press the **ENT** Key.

Selecting an active profile:

- 1) Use the **FMS** Knob to select the AUX - System Setup Page.
- 2) Press the **FMS** Knob momentarily to activate the flashing cursor.
- 3) Turn the large **FMS** Knob to highlight the active profile field in the Pilot Profile Box.
- 4) Turn the small **FMS** Knob to display the pilot profile list and highlight the desired profile.
- 5) Press the **ENT** Key. The G1000 loads and displays the system settings for the selected profile.

Renaming a profile:

- 1) Use the **FMS** Knob to select the AUX - System Setup Page.
- 2) Press the **FMS** Knob momentarily to activate the flashing cursor.
- 3) Turn the large **FMS** Knob to highlight 'RENAME' in the Pilot Profile Box.
- 4) Press the **ENT** Key.
- 5) In the 'Rename Profile' window, turn the **FMS** Knob to select the profile to rename.
- 6) Press the **ENT** Key.
- 7) Use the **FMS** Knob to enter a new profile name up to 16 characters long and press the **ENT** Key.
- 8) With 'RENAME' highlighted, press the **ENT** Key.
- 9) To cancel the process, use the large **FMS** Knob to select 'CANCEL' and press the **ENT** Key.

Deleting a profile:

- 1) Use the **FMS** Knob to select the AUX - System Setup Page.
- 2) Press the **FMS** Knob momentarily to activate the flashing cursor.
- 3) Turn the large **FMS** Knob to highlight 'DELETE' in the Pilot Profile Box.
- 4) Press the **ENT** Key.
- 5) In the 'Delete Profile' window, turn the **FMS** Knob to select the profile to delete.
- 6) Press the **ENT** Key.
- 7) With 'DELETE' highlighted, press the **ENT** Key.
- 8) To cancel the process, use the large **FMS** Knob to select 'CANCEL' and press the **ENT** Key.

SYSTEM STATUS PAGE

The System Status Page displays the status and software version numbers for all detected system LRUs. Pertinent information on all system databases is also displayed. Active LRUs are indicated by green check marks and failed LRUs are indicated by red 'X's. Failed LRUs should be noted and a service center informed.

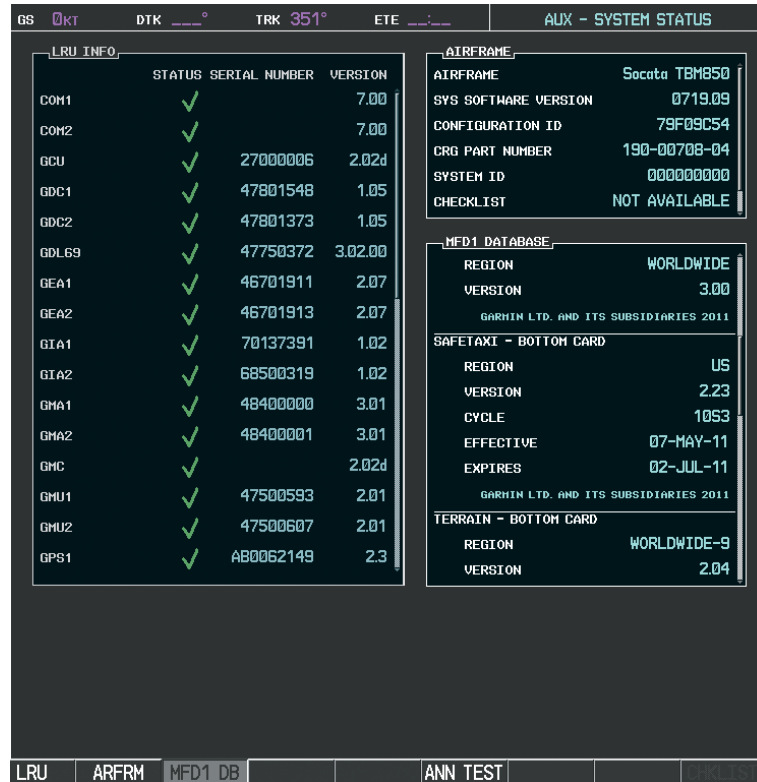

Figure 1-34 Example System Status Page

The **LRU** and **ARFRM**, Softkeys on the System Status Page select the applicable list (LRU INFO or AIRFRAME window) through which the **FMS** Knob can be used to scroll information within the selected window.

Selecting the **MFD1 DB** Softkey (label background changes to grey indicating the softkey is selected) places the cursor in the DATABASE window. Use the **FMS** Knob to scroll through database information for the MFD. Selecting the softkey again will change the softkey label to **PFD1 DB**. PFD 1 database information is now displayed in the DATABASE window. Selecting the softkey a third time will change the softkey label to **PFD2 DB**. PFD 2 database information is now displayed in the DATABASE window.

The **ANN TEST** Softkey, when selected, causes an annunciation test tone to be played.

1.8 DISPLAY BACKLIGHTING

The G1000 display and control backlighting can be adjusted either automatically or manually. Backlighting intensity ranges from 0.22% to 100% on the PFDs and 0.80% to 100.00% on the MFD.

AUTOMATIC ADJUSTMENT

The existing instrument panel dimmer bus normally controls the PFD and MFD bezels, MFD Control Unit, AFCS Control Unit and audio panel key annunciator lighting. When the dimmer bus is not used by the G1000 system, photocell technology automatically controls backlighting adjustments. Photocell calibration curves are pre-configured to optimize display appearance through a broad range of cockpit lighting conditions.

MANUAL ADJUSTMENT



NOTE: In normal mode, backlighting can only be adjusted from PFD1 or PFD2. In reversionary mode, it can also be adjusted from the MFD.



NOTE: No other window can be displayed on the PFD while the PFD Setup Menu Window is displayed.

Backlighting may also be adjusted manually for all of the displays and the associated bezels. The audio panel key backlighting is directly tied to the on-side PFD key backlighting setting.

To adjust display backlighting manually:

- 1) Press the **MENU** Key on the PFD to display the PFD Setup Menu Window. 'AUTO' becomes highlighted to the right of 'PFD1 DSPL'.

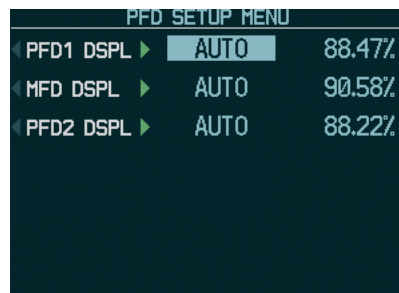

Figure 1-35 Manual Display Backlighting Adjustment

- 2) Turn the small **FMS** Knob to display the selection box. Turn the **FMS** Knob to select 'MANUAL', then press the **ENT** Key. The intensity value becomes highlighted.
- 3) Turn the small **FMS** Knob to select the desired backlighting, then press the **ENT** Key.
- 4) Turn the large **FMS** Knob to highlight 'AUTO' to the right of 'MFD DSPL' or 'PFD2 DSPL', respectively, and repeat steps 2 and 3.
- 5) Press the **CLR** or **MENU** Key to remove the PFD Setup Menu Window from the display.

To adjust key backlighting manually:

- 1) Press the **MENU** Key on the PFD to display the PFD Setup Menu Window. 'AUTO' becomes highlighted to the right of 'PFD1 DSPL'.

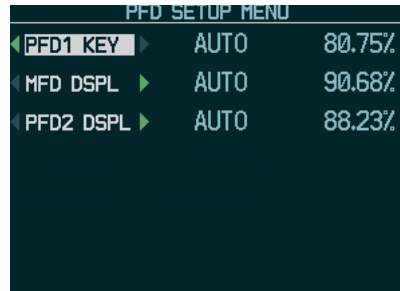

Figure 1-36 Manual Key Lighting Adjustment

- 2) Turn the large **FMS** Knob to highlight 'PFD1 DSPL'. Turn the small **FMS** Knob in the direction of the green arrowhead to display 'PFD1 KEY'.
- 3) Turn the large **FMS** Knob to highlight 'AUTO' and turn the small **FMS** Knob to display the selection box.
- 4) Turn the **FMS** Knob to select 'MANUAL', then press the **ENT** Key. The intensity value becomes highlighted.
- 5) Turn the small **FMS** Knob to select the desired backlighting, then press the **ENT** Key.
- 6) Turn the large **FMS** Knob to highlight 'MFD DSPL' or 'PFD2 DSPL' and turn the small **FMS** Knob in the direction of the green arrowhead to display 'MFD KEY' or 'PFD2 KEY', respectively.
- 7) Repeat steps 3 to 5.
- 8) Press the **CLR** or **MENU** Key to remove the PFD Setup Menu Window from the display.

BLANK PAGE

SECTION 2 FLIGHT INSTRUMENTS



WARNING: If the airspeed, attitude, altitude, or heading indications become unusable, refer to the backup instruments.



NOTE: The Automatic Flight Control System (AFCS) provides additional readouts and bugs on selected flight instruments. Refer to the AFCS Section for details on these bugs and readouts, as they appear on the display during certain AFCS flight director modes.

Increased situational awareness is provided by replacing the traditional instruments on the panel with two easy-to-scan Primary Flight Displays (PFDs) that feature large horizons, airspeed, attitude, altitude, vertical speed, and course deviation information. In addition to the flight instruments, navigation, communication, terrain, traffic, and weather information are also presented on the PFDs and are explained in other sections of this Pilot's Guide.

The following flight instruments and supplemental flight data are displayed on the PFDs:

- Airspeed Indicator, showing
 - Indicated airspeed
 - True airspeed
 - Airspeed awareness ranges
 - Vspeed reference flags
- Attitude Indicator with slip/skid indication
- Altimeter, showing
 - Trend vector
 - Barometric setting
 - Selected altitude
- Vertical Deviation, Glideslope, and Glidepath Indicators
- Vertical Speed Indicator (VSI)
- Vertical Navigation (VNV) indications
- Outside air temperature (OAT)
- Horizontal Situation Indicator, showing
 - Turn Rate Indicator
 - Bearing pointers and information windows
 - Navigation source
 - Course Deviation Indicator (CDI)
 - Bearing pointers and information windows
 - DME Information Window
- Transponder Mode, Code, and Ident/Reply
- Timer/References Window, showing
 - Generic timer
 - Vspeed values
 - Barometric minimum descent altitude (MDA)
- Wind data

The PFDs also displays various alerts and annunciations.

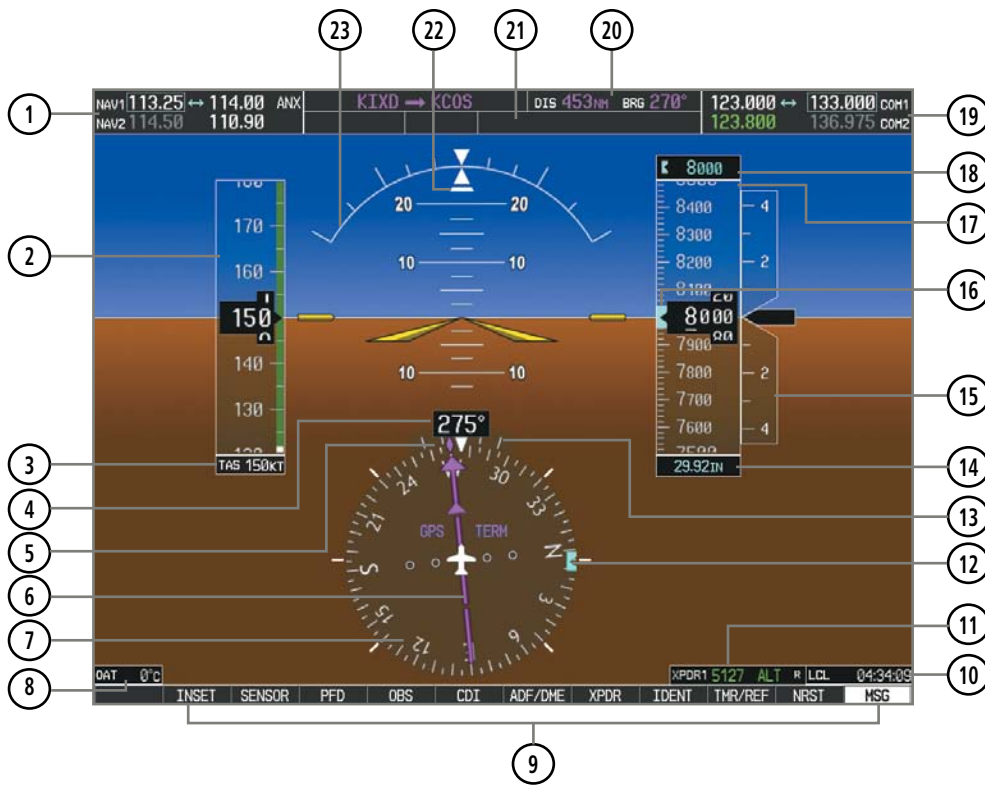

Figure 2-1 Primary Flight Display (Default)

- | | |
|--|----------------------------------|
| ① NAV Frequency Box | ⑬ Turn Rate Indicator |
| ② Airspeed Indicator | ⑭ Barometric Altimeter Setting |
| ③ True Airspeed | ⑮ Vertical Speed Indicator (VSI) |
| ④ Current Heading | ⑯ Selected Altitude Bug |
| ⑤ Current Track Indicator | ⑰ Altimeter |
| ⑥ Course Deviation Indicator (CDI) | ⑱ Selected Altitude |
| ⑦ Horizontal Situation Indicator (HSI) | ⑲ COM Frequency Box |
| ⑧ Outside Air Temperature (OAT) | ⑳ Navigation Status Box |
| ⑨ Softkeys | ㉑ AFCS Status Box |
| ⑩ System Time | ㉒ Slip/Skid Indicator |
| ⑪ Transponder Data Box | ㉓ Attitude Indicator |
| ⑫ Selected Heading Bug | |



Figure 2-2 Primary Flight Display (Additional Information)

- | | |
|-------------------------------|--|
| ① Traffic Annunciation | ⑨ Flight Plan Window |
| ② Vspeed Reference | ⑩ Minimum Descent Altitude/Decision Height |
| ③ Radar Height | ⑪ Selected Course |
| ④ Selected Heading | ⑫ Current Vertical Speed |
| ⑤ Wind Data | ⑬ Glidepath Indicator |
| ⑥ Inset Map | ⑭ Terrain Annunciation |
| ⑦ DME Information Window | ⑮ AFCS Status Annunciation |
| ⑧ Bearing Information Windows | |

2.1 FLIGHT INSTRUMENTS

AIRSPEED INDICATOR



NOTE: Refer to the Pilot's Operating Handbook (POH) for airspeed criteria and Vspeed values.

The Airspeed Indicator displays airspeed on a moving tape rolling number gauge. The true airspeed is displayed in knots below the Airspeed Indicator. The numeric labels and major tick marks on the moving tape are shown at intervals of 10 knots. The minor tick marks on the moving tape are marked at intervals of five knots. Speed indication starts at 20 knots, with 60 knots of airspeed viewable at any time. The indicated airspeed is displayed inside the black pointer. The pointer remains black until reaching maximum operating speed (V_{MO}), at which point it turns red.

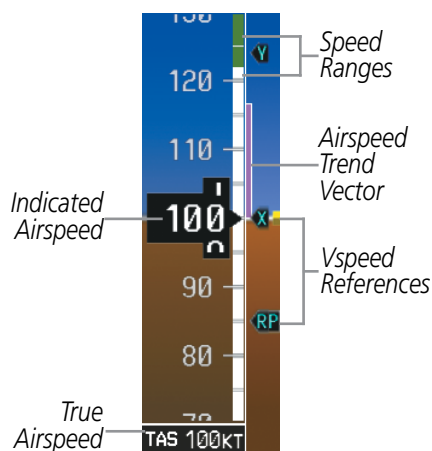

Figure 2-3 Airspeed Indicator



Figure 2-4 Red Pointer Showing Overspeed

A color-coded (white, green, and red/white barber pole) speed range strip is located on the moving tape. The colors denote flaps operating range, normal operating range, and maximum operating speed (V_{MO}). A red range is also present for low speed awareness.

The Airspeed Trend Vector is a vertical magenta line that appears to the right of the color-coded speed range strip when airspeed is either accelerating or decelerating. One end of the magenta line is anchored to the tip of the airspeed pointer while the other end moves continuously up or down corresponding to the rate of acceleration or deceleration. For any constant rate of acceleration or deceleration, the moving end of the line shows approximately what the indicated airspeed value will be in six seconds. The trend vector is absent if the speed remains constant or if any data needed to calculate airspeed is not available due to a system failure.

Vspeeds (V_R , V_X , V_Y , and V_{APP}) can be changed and the Vspeed flags can be turned on/off from the Timer/References Window. When active (on), the Vspeeds are displayed at their respective locations to the right of the airspeed scale. All Vspeed values are reset and all Vspeed flags are turned off during power up.

Changing Vspeeds and turning Vspeed flags on/off:

- 1) Press the **TMR/REF** Softkey.
- 2) Turn the large **FMS** Knob to highlight the field of the desired Vspeed to be changed.
- 3) Use the small **FMS** Knob to change the Vspeed in 1-kt increments. When a speed has been changed from a default value, an asterisk appears next to the speed.
- 4) Press the **ENT** Key or turn the large **FMS** Knob to highlight the ON/OFF field.
- 5) Turn the small **FMS** Knob clockwise to ON or counterclockwise to OFF.
- 6) To remove the window, press the **CLR** Key or the **TMR/REF** Softkey.

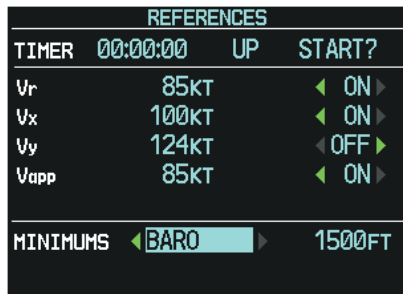

Figure 2-5 Timer/References Window

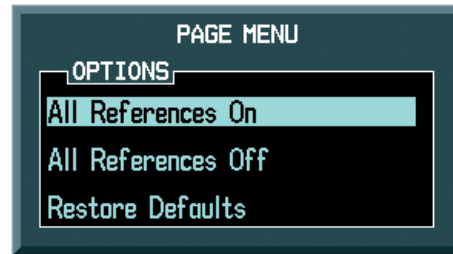

Figure 2-6 Timer/References Menu

Turning all Vspeed flags on/off:

- 1) Press the **TMR/REF** Softkey.
- 2) Press the **MENU** Key.
- 3) To activate all Vspeed flags, press the **ENT** Key with All References On highlighted.
- 4) To remove all Vspeed flags, turn the **FMS** Knob to highlight All References Off and press the **ENT** Key.

Restoring all defaults:

- 1) Press the **TMR/REF** Softkey.
- 2) Press the **MENU** Key.
- 3) Turn the **FMS** Knob to highlight Restore Defaults and press the **ENT** Key.

ATTITUDE INDICATOR

Attitude information is displayed over a virtual blue sky and brown ground with a white horizon line. The Attitude Indicator displays the pitch, roll, and slip/skid information.

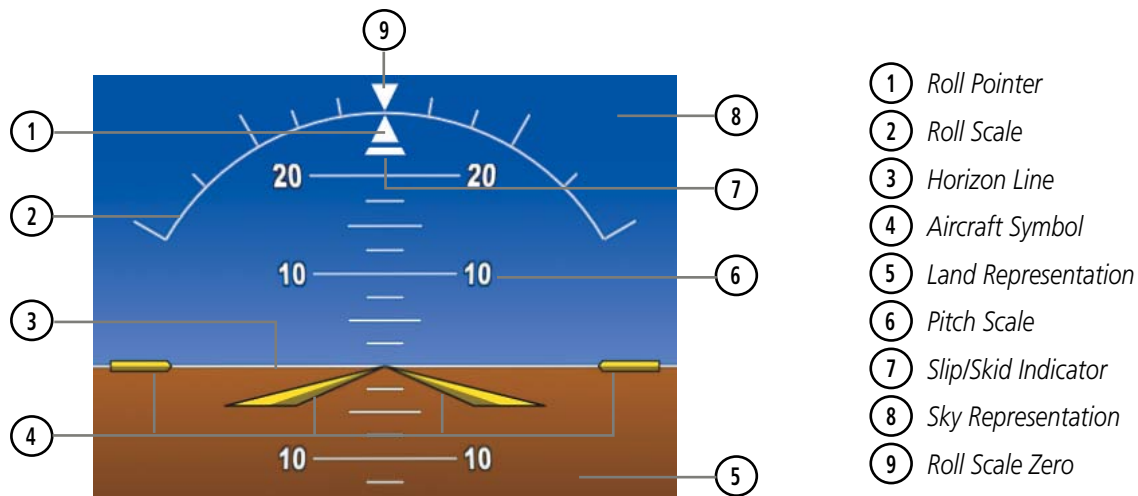

Figure 2-7 Attitude Indicator

The horizon line is part of the pitch scale. Above and below the horizon line, major pitch marks and numeric labels are shown for every 10°, up to 80°. Minor pitch marks are shown for intervening 5° increments, up to 25° below and 45° above the horizon line. Between 20° below to 20° above the horizon line, minor pitch marks occur every 2.5°.

The inverted white triangle indicates zero on the roll scale. Major tick marks at 30° and 60° and minor tick marks at 10°, 20°, and 45° are shown to the left and right of the zero. Angle of bank is indicated by the position of the pointer on the roll scale.

The Slip/Skid Indicator is the bar beneath the roll pointer. The indicator bar moves with the roll pointer and moves laterally away from the pointer to indicate uncoordinated flight. Slip (inside the turn) or skid (outside the turn) is indicated by the location of the bar relative to the pointer.



Figure 2-8 Slip/Skid Indication

ALTIMETER

The Altimeter displays 1,000 feet of barometric altitude values at a time on a moving tape rolling number gauge. Numeric labels and major tick marks are shown at intervals of 100 feet. Minor tick marks are at intervals of 20 feet. The current altitude is displayed in the black pointer.

The Selected Altitude is displayed above the Altimeter in the box indicated by a selection bug symbol. A bug corresponding to this altitude is shown on the tape; if the Selected Altitude exceeds the range shown on the tape, the bug appears at the upper or lower edge of the tape. See the AFCS Section for more information about Selected Altitude.

Setting the Selected Altitude:

Turn the **ALT SEL** Knob to set the Selected Altitude in 100-ft increments (increments reduce to 10 feet for approach) up to the aircraft’s service ceiling. When meters are displayed, Selected Altitude is adjusted in 50 meter increments.

If set, the Minimum Descent Altitude/Decision Height (MDA/DH) value is also available for the Selected Altitude.

If desired, press the **ALT SEL** Knob to synchronize the selected altitude to the displayed altitude to the nearest 10 ft.

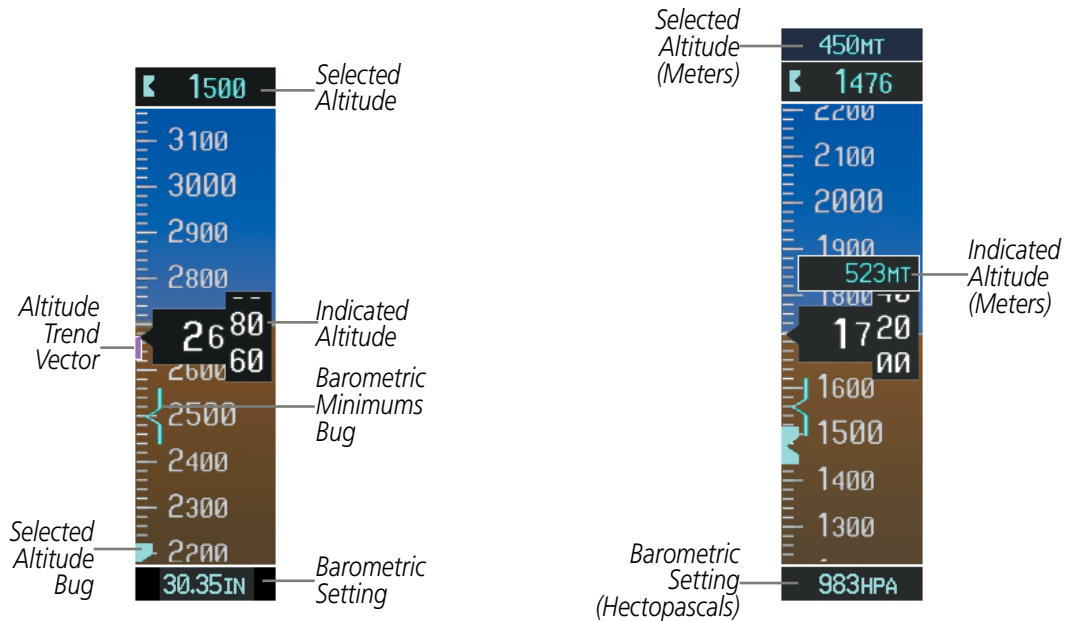

Figure 2-9 Altimeter (Standard and Metric)

Altitudes can also be displayed in meters (Figure 2-9). Note that the altitude tape does not change scale.

Displaying altitude in meters:

- 1) Press the **PFD** Softkey to display the second-level softkeys.
- 2) Press the **ALT UNIT** Softkey.
- 3) Press the **METERS** Softkey to turn on metric altitude readouts.
- 4) Select the **BACK** Softkey twice to return to the top-level softkeys.

A magenta Altitude Trend Vector extends up or down the left of the altitude tape. The end extends to the approximate altitude to be reached in six seconds at the current vertical speed. The trend vector is not shown if altitude remains constant or if data needed for calculation is not available due to a system failure.

The barometric pressure setting is displayed below the Altimeter in inches of mercury (in Hg) or hectopascals (hPa). Adjusting the altimeter barometric setting creates discontinuities in VNV vertical deviation, moving the descent path. For large adjustments, it may take several minutes for the aircraft to re-establish on the descent path. If the change is made while nearing a waypoint with a VNV Target Altitude, the aircraft may not re-establish on the descent path in time to meet the vertical constraint.

Selecting the altimeter barometric pressure setting:

Turn the **BARO** Knob to select the desired setting.

Selecting standard barometric pressure (STD BARO):

Press the **BARO** Knob to select standard pressure.

Or:

- 1) Press the **PFD** Softkey to display the second-level softkeys.
- 2) Press the **STD BARO** Softkey.



Figure 2-10 Standard Barometric Altimeter Setting

Changing altimeter barometric pressure setting units:

- 1) Press the **PFD** Softkey to display the second-level softkeys.
- 2) Select the **ALT UNIT** Softkey.
- 3) Select the **IN** Softkey to display the barometric pressure setting in inches of mercury (in Hg).
Or, select the **HPA** Softkey to display the barometric pressure setting in hectopascals (hPa).
- 4) Select the **BACK** Softkey twice to return to the top-level softkeys.

If the barometric altimeter settings differ between PFDs by more than 0.02 in Hg, the readouts turn yellow (Figure 2-11). The settings can be synchronized from the AUX - System Setup Page on the MFD. Once the settings are synchronized (BARO SYNCHRONIZAT turned on), they remain synchronized for the entire flight.

Synchronizing the altimeter barometric pressure settings:

- 1) Select the AUX - System Setup Page using the **FMS** Knob.
- 2) Press the **FMS** Knob to activate the cursor.
- 3) Turn the large **FMS** Knob to highlight Baro in the Synchronization box.
- 4) Turn the small **FMS** Knob clockwise to ON or counterclockwise to OFF.
- 5) Press the **FMS** Knob to remove the cursor.

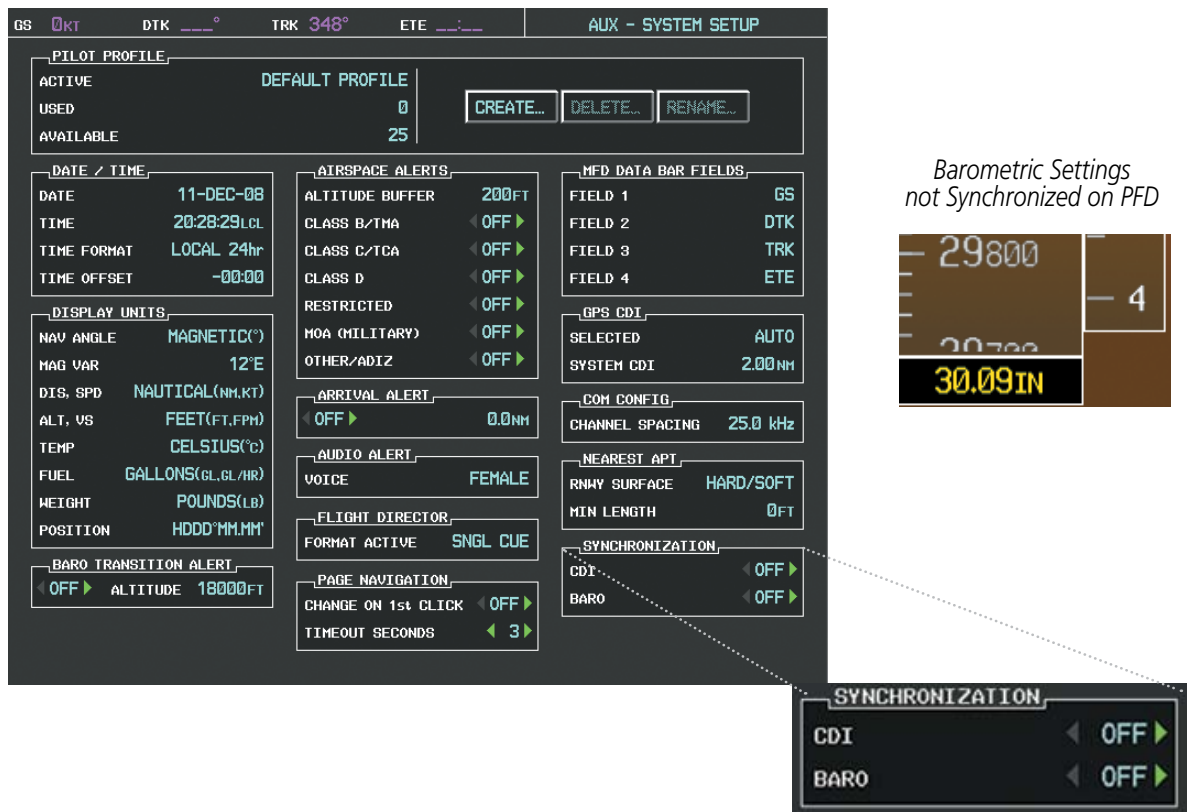

Figure 2-11 Baro Synchronization Setting (AUX - System Setup Page)

A Baro Transition Alert is provided to alert the pilot to change the barometric pressure setting when crossing the transition altitude in either direction. This is displayed by the barometric pressure setting flashing light blue when crossing the transition altitude. The flashing stops when the barometric pressure setting is changed.

Setting the Baro Transition Alert:

- 1) Use the **FMS** Knob to select the AUX - System Setup Page on the MFD.
- 2) Press the **FMS** Knob to activate the cursor.
- 3) Turn the large **FMS** Knob to highlight Altitude in the Baro Transition Alert box.
- 4) Turn the small **FMS** Knob to turn the alert OFF or ON and press the **ENT** Key.
- 5) Turn the small **FMS** Knob to change the altitude and press the **ENT** Key.
- 6) To cancel the selection, press the **FMS** Knob.

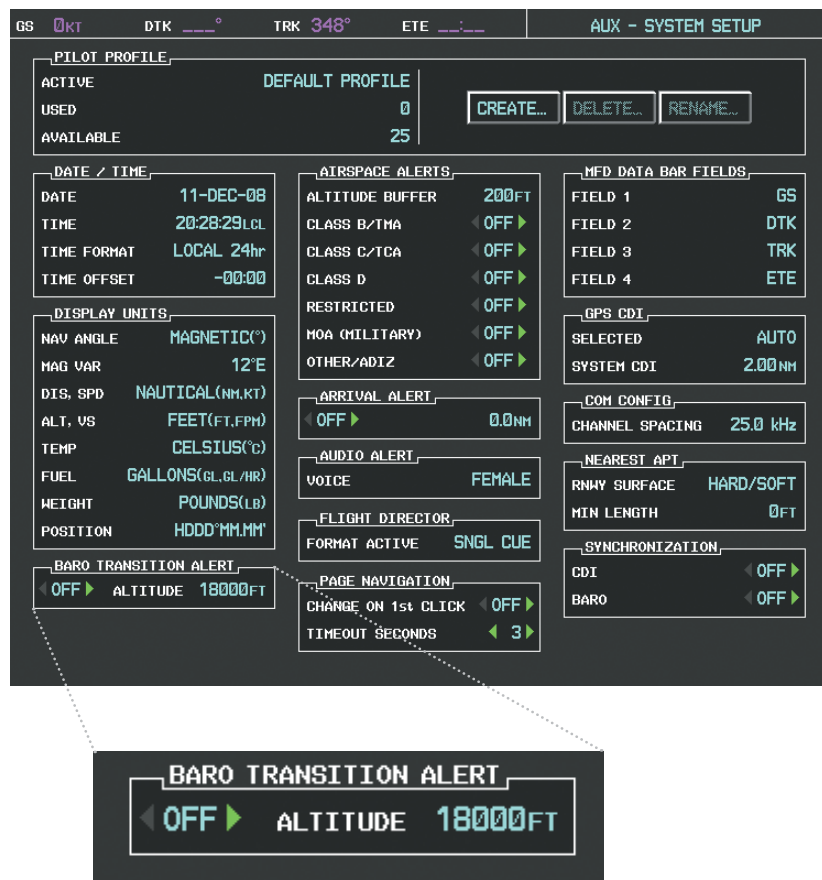

Figure 2-12 Baro Transition Alert (AUX - System Setup Page)

VERTICAL SPEED INDICATOR (VSI)

The Vertical Speed Indicator (VSI) displays the aircraft vertical speed on a fixed scale with labels at 2000 and 4000 fpm and minor tick marks every 1000 fpm (Figure 2-13). Digits appear in the pointer when the climb or descent rate is greater than 100 fpm. If the rate of ascent/descent exceeds 4000 fpm, the pointer appears at the edge of the tape and the rate appears inside the pointer.

A magenta chevron is displayed on the VSI as the Required Vertical Speed for reaching a VNV Target Altitude once the “TOD [Top of Descent] within 1 minute” alert has been generated. See the Flight Management and AFCS sections for details on VNV features, and refer to Section 2.2, Supplemental Flight Data, for more information about VNV indications on the PFD.

VERTICAL DEVIATION

The Vertical Deviation Indicator (VDI) is a magenta chevron to indicate the baro-VNV vertical deviation when Vertical Navigation (VNV) is being used. The VDI (Figure 2-13) appears in conjunction with the “TOD within 1 minute” alert. Full-scale deflection (two dots) is 1000 feet. The VDI is removed from the display if vertical deviation becomes invalid. See the Flight Management and AFCS sections for details on VNV features, and refer to Section 2.2, Supplemental Flight Data, for more information about VNV indications on the PFD.

The Glideslope Indicator (Figure 2-14) appears to the left of the Altimeter whenever an ILS frequency is tuned in the active NAV field and the aircraft heading and selected course are within 107°. A green diamond acts as the Glideslope Indicator, like a glideslope needle on a conventional indicator. If a localizer frequency is tuned and there is no glideslope, “NO GS” is annunciated in place of the diamond.

The glidepath is analogous to the glideslope for GPS approaches supporting SBAS vertical guidance (LNAV+V, LNAV/VNAV, LPV). When an approach of this type is loaded into the flight plan and GPS is the selected navigation source, the Glidepath Indicator (Figure 2-15) appears as a magenta diamond when the aircraft reaches a point prior to the FAF. If the approach type changes past the final approach fix (FAF), “NO GP” is displayed in place of the diamond.

Full-scale deflection of two dots is 1000 feet.

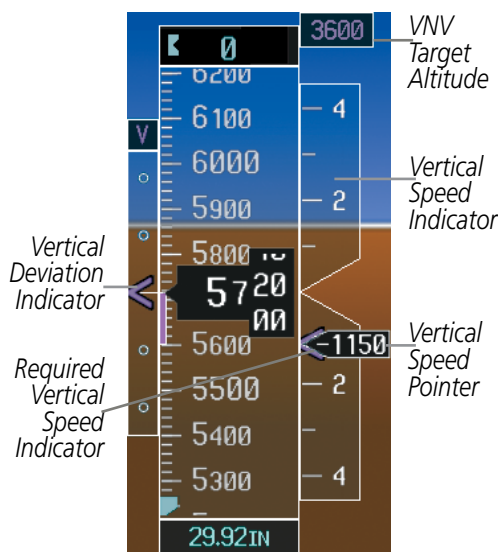

Figure 2-13 Vertical Speed and Deviation Indicators (VSI and VDI)

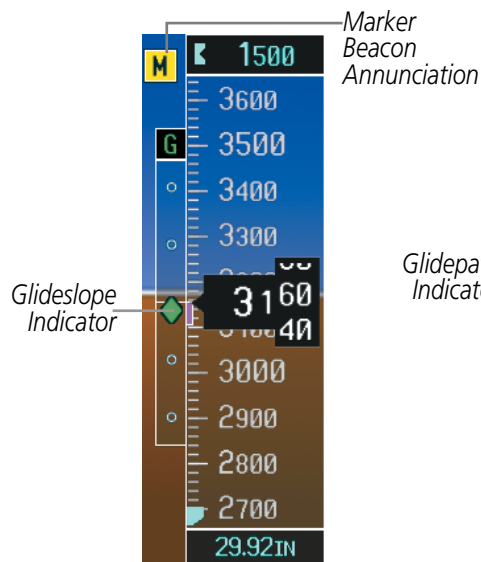

Figure 2-14 Glideslope Indicator

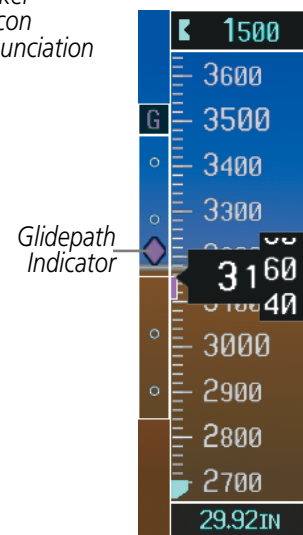

Figure 2-15 Glidepath Indicator

HORIZONTAL SITUATION INDICATOR (HSI)

The Horizontal Situation Indicator (HSI) displays a rotating compass in a heading-up orientation. Letters indicate the cardinal points and numeric labels occur every 30°. Major tick marks are at 10° intervals and minor tick marks at 5° intervals. A digital reading of the current heading appears on top of the HSI, and the current track is represented on the HSI by a magenta diamond bug. The HSI also presents turn rate, course deviation, bearing, and navigation source information and is available in two formats (360° compass rose and 140° arc).

Changing the HSI display format:

- 1) Press the **PFD** Softkey.
- 2) Press the **HSI FRMT** Softkey.
- 3) Press the **360 HSI** or **ARC HSI** Softkey.

The 360° HSI contains a Course Deviation Indicator (CDI), with a Course Pointer, To/From Indicator, and a sliding deviation bar and scale. The course pointer is a single line arrow (GPS, VOR1, and LOC1) or a double line arrow (VOR2 and LOC2) which points in the direction of the set course. The To/From arrow rotates with the course pointer and is displayed when the active NAVAID is received.

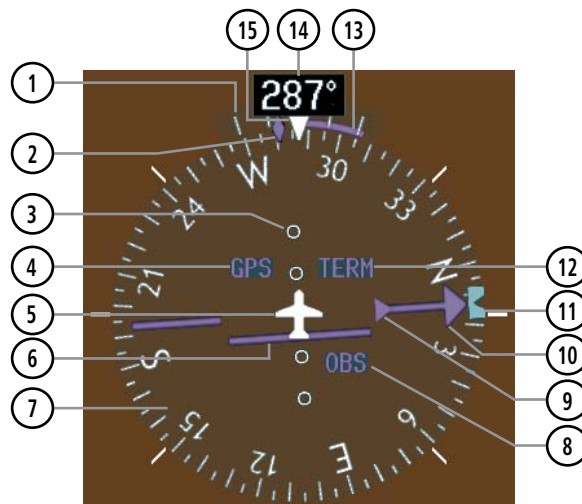

Figure 2-16 Horizontal Situation Indicator (HSI)

- | | |
|------------------------------------|----------------------------------|
| ① Turn Rate Indicator | ⑨ To/From Indicator |
| ② Current Track Indicator | ⑩ Course Pointer |
| ③ Lateral Deviation Scale | ⑪ Heading Bug |
| ④ Navigation Source | ⑫ Flight Phase |
| ⑤ Aircraft Symbol | ⑬ Turn Rate/Heading Trend Vector |
| ⑥ Course Deviation Indicator (CDI) | ⑭ Current Heading |
| ⑦ Rotating Compass Rose | ⑮ Lubber Line |
| ⑧ OBS Mode Active | |

The Arc HSI is a 140° expanded section of the compass rose. The Arc HSI contains a Course Pointer, To/From Indicator, a sliding deviation indicator (the To/From and deviation indicators are combined), and a deviation scale. Upon station passage, the To/From Indicator flips and points to the tail of the aircraft, just like a conventional To/From flag. Depending on the navigation source, the CDI on the Arc HSI can appear in two different ways: an arrowhead (GPS, VOR, OBS) or a diamond (LOC).

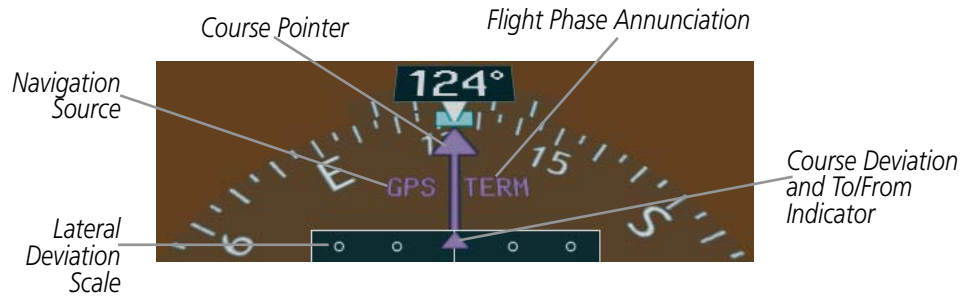

Figure 2-17 Arc HSI

The Selected Heading is shown to the upper left of the HSI for three seconds after being adjusted. The light blue bug on the compass rose corresponds to the Selected Heading. While the HSI is displayed as an arc, if the Selected Heading Bug is adjusted off the shown portion of the compass rose, the digital reading displayed.

Adjusting the Selected Heading:

Turn the **HDG** Knob to set the Selected Heading.

Press the **HDG** Knob to synchronize the bug to the current heading.

The Selected Course is shown to the upper right of the HSI for three seconds after being adjusted. While the HSI is displayed as an arc, the Selected Course is displayed whenever the Course Pointer is not within the 140° currently shown.

Adjusting the Selected Course:

Turn the **CRS** Knob to set the Selected Course.

Press the **CRS** Knob to re-center the CDI and return the course pointer to the bearing of the active waypoint or navigation station (see OBS Mode for adjusting a GPS course).

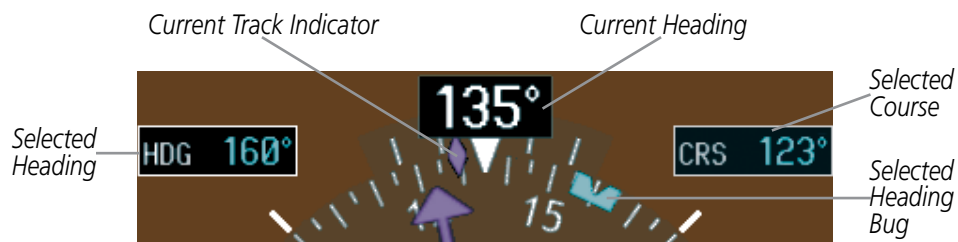

Figure 2-18 Heading and Course Indications

Navigation angles (track, heading, course, bearing) are corrected to the computed magnetic variation (Mag Var) or referenced to true north (T), set on the AUX - System Setup Page. When an approach referenced to true north has been loaded into the flight plan, the system generates a message to change the navigation angle setting to True at the appropriate time.



Figure 2-19 Heading and Course Indications (True)

Changing the navigation angle setting:

- 1) Use the **FMS** Knob to select the AUX - System Setup Page on the MFD.
- 2) Press the **FMS** Knob to activate the cursor.
- 3) Turn the large **FMS** Knob to highlight Nav Angle in the Display Units box.
- 4) Turn the small **FMS** Knob to highlight the desired setting and press the **ENT** Key.
 - TRUE - References angles to true north (T)
 - MAGNETIC - Angles corrected to the computed magnetic variation (Mag Var)

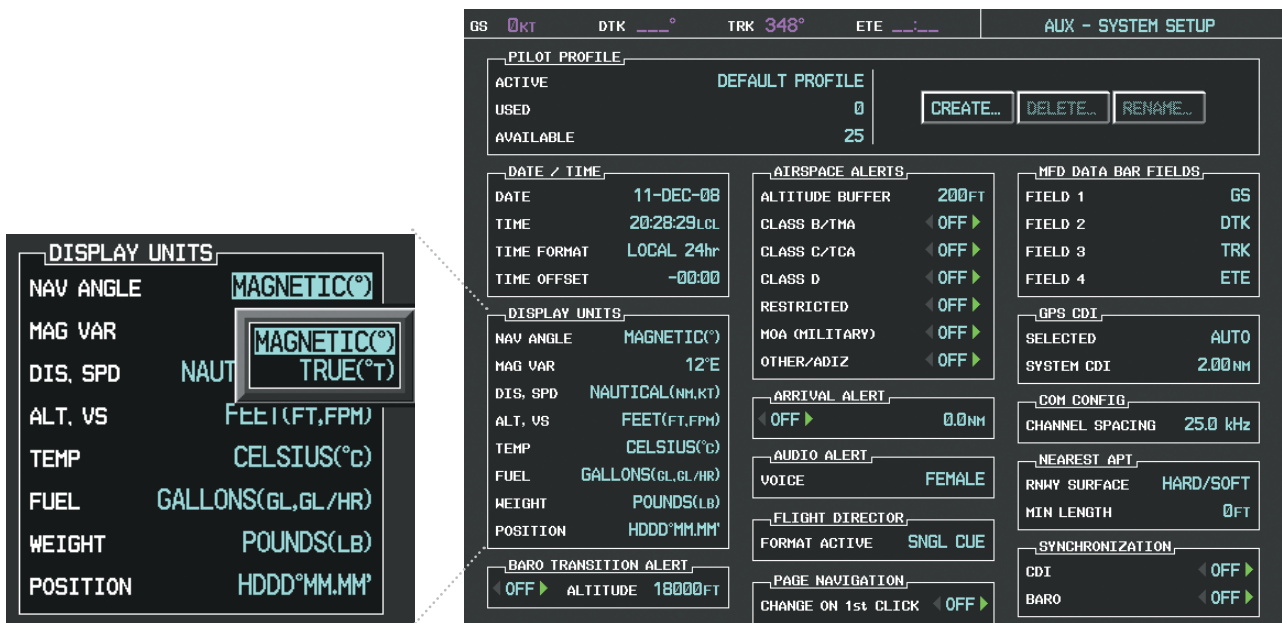

Figure 2-20 Navigation Angle Settings (AUX - System Setup Page)

TURN RATE INDICATOR

The Turn Rate Indicator is located directly above the rotating compass card. Tick marks to the left and right of the lubber line denote half-standard and standard turn rates. A magenta Turn Rate Trend Vector shows the current turn rate. The end of the trend vector gives the heading predicted in six seconds, based on the present turn rate. A standard-rate turn is shown on the indicator by the trend vector stopping at the standard turn rate tick mark, corresponding to a predicted heading of 18° from the current heading. At rates greater than 4 deg/sec, an arrowhead appears at the end of the magenta trend vector and the prediction is no longer valid.



Figure 2-21 Turn Rate Indicator and Trend Vector

BEARING POINTERS AND INFORMATION WINDOWS



NOTE: When the Arc HSI is displayed, the Bearing Information windows and pointers are disabled.

Two bearing pointers and associated information can be displayed on the HSI for the NAV, GPS, and ADF sources. The bearing pointers are light blue and are single-line (BRG1) or double-line (BRG2). A pointer symbol is shown in the information window to indicate the navigation source. The bearing pointers never override the CDI and are visually separated from the CDI by a white ring. Bearing pointers may be selected but not necessarily visible due to data unavailability.

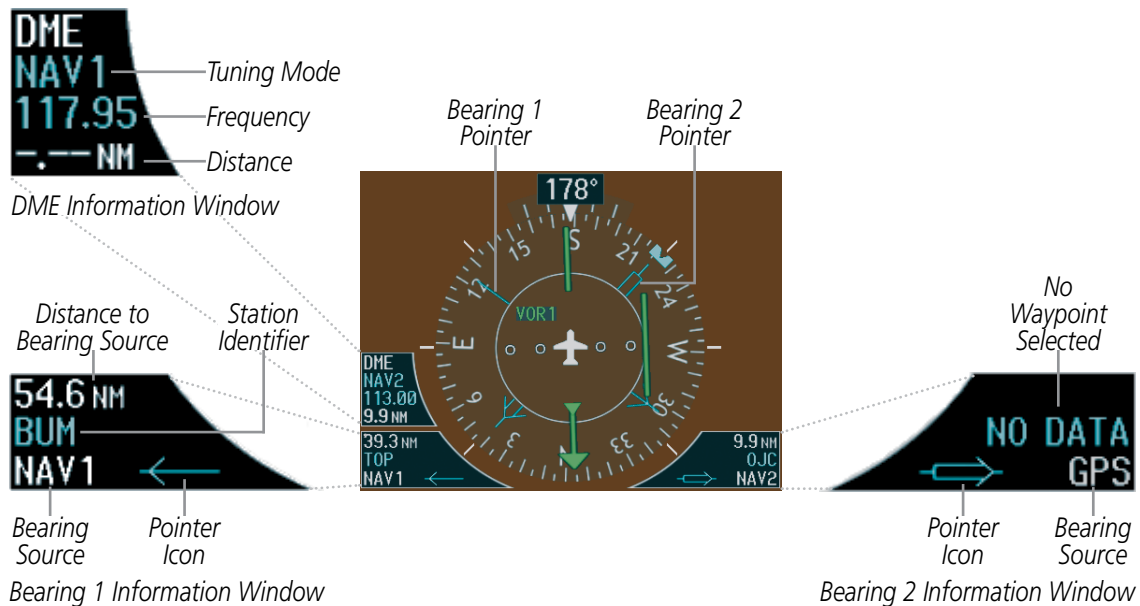

Figure 2-22 HSI with Bearing and DME Information

When a bearing pointer is displayed, its associated information window is also displayed. The Bearing Information windows (Figure 2-22) are displayed to the lower sides of the HSI and give the following information:

- Bearing source (NAV, GPS, ADF)
- Pointer icon (single line for BRG1, double line for BRG2)
- Frequency (NAV, ADF)
- Station/waypoint identifier (NAV, GPS)
- GPS-derived great circle distance to bearing source

When the NAV radio is tuned to an ILS frequency the bearing source and the bearing pointer are removed from the HSI and the frequency is replaced with “ILS”. When NAV1 or NAV2 is the selected bearing source, the frequency is replaced by the station identifier when the station is within range. If GPS is the bearing source, the active waypoint identifier is displayed instead of a frequency.

The bearing pointer is removed from the HSI and NO DATA is displayed in the information window if: the NAV radio is not receiving the tuned VOR station or if GPS is the bearing source and an active waypoint is not selected.

When the Arc HSI is displayed, the Bearing Information windows and pointers are disabled.

Selecting bearing display and changing sources:

- 1) Press the **PFD** Softkey.
- 2) Press a **BRG** Softkey to display the desired bearing pointer and information window with a NAV source.
- 3) Press the **BRG** Softkey again to change the bearing source to GPS.
- 4) Press the **BRG** Softkey a third time to change the bearing source to ADF (note: ADF radio installation is optional).
- 5) To remove the bearing pointer and information window, press the **BRG** Softkey again.

DME INFORMATION WINDOW



NOTE: DME radio installation is optional.

The DME Information Window (Figure 2-22) is displayed above the BRG1 Information Window and shows the DME label, tuning mode (NAV1, NAV2, or HOLD), frequency, and distance. When a signal is invalid, the distance is replaced by “-- -- NM”. Refer to the Audio Panel and CNS Section for information on tuning the radios.

Displaying the DME Information Window:

- 1) Press the **PFD** Softkey.
- 2) Press the **DME** Softkey to display the DME Information Window above the BRG1 Information Window.
- 3) To remove the DME Information Window, press the **DME** Softkey again.

COURSE DEVIATION INDICATOR (CDI)

NOTE: During a heading change of greater than 105° with respect to the course, the CDI on the Arc HSI switches to the opposite side of the deviation scale and displays reverse sensing.

The Course Deviation Indicator (CDI) moves left or right from the course pointer along a lateral deviation scale to display aircraft position relative to the course. If the course deviation data is not valid, the CDI is not displayed.

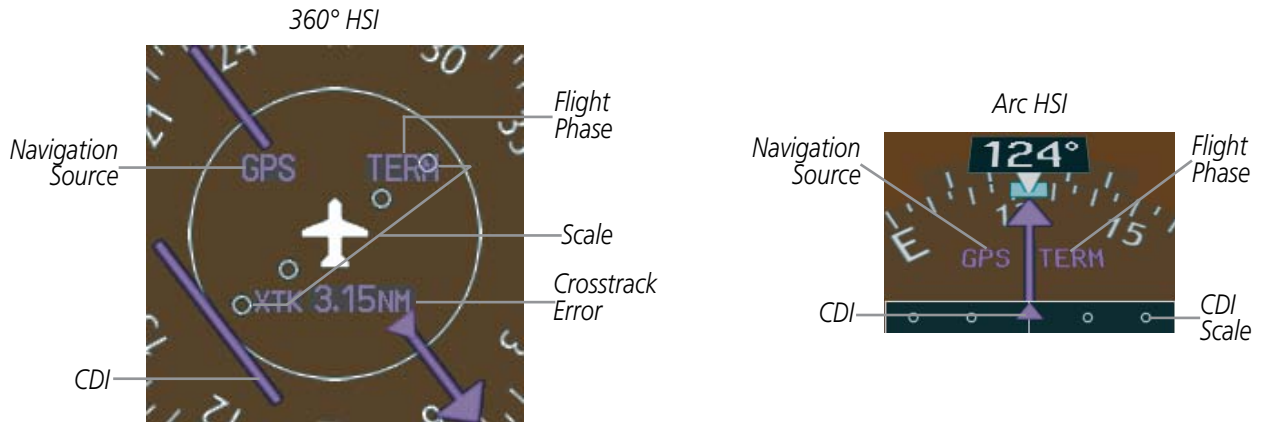

Figure 2-23 Course Deviation Indicator

The CDI can display two sources of navigation: GPS or NAV (VOR/LOC). The color indicates the current navigation source: magenta for GPS or green for VOR and LOC. The full scale limits for the CDI are defined by a GPS-derived distance when navigating GPS. When navigating using a VOR or localizer (LOC), the CDI has the same angular limits as a mechanical CDI. If the CDI exceeds the maximum deviation on the scale (two dots) while navigating with GPS, the crosstrack error (XTK) is displayed below the white aircraft symbol.

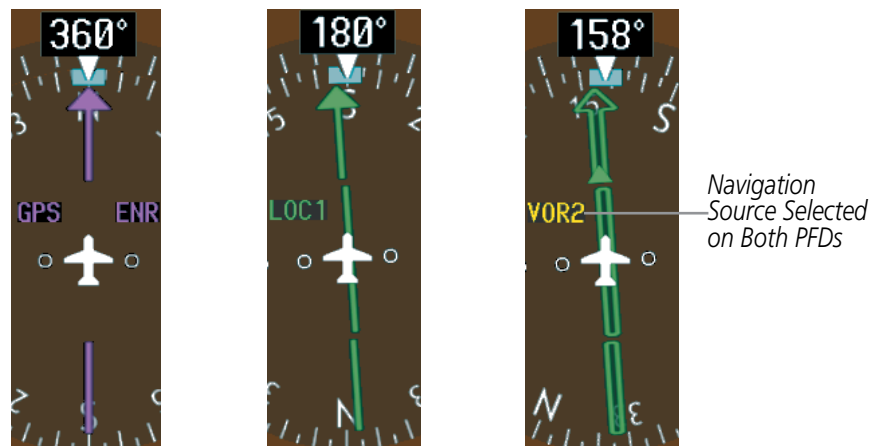

Figure 2-24 Navigation Sources

Changing navigation sources:

- 1) Press the **CDI** Softkey to change from GPS to VOR1 or LOC1. This places the light blue tuning box over the NAV1 standby frequency in the upper left corner of the PFD.
- 2) Press the **CDI** Softkey again to change from VOR1 or LOC1 to VOR2 or LOC2. This places the light blue tuning box over the NAV2 standby frequency.
- 3) Press the **CDI** Softkey a third time to return to GPS.

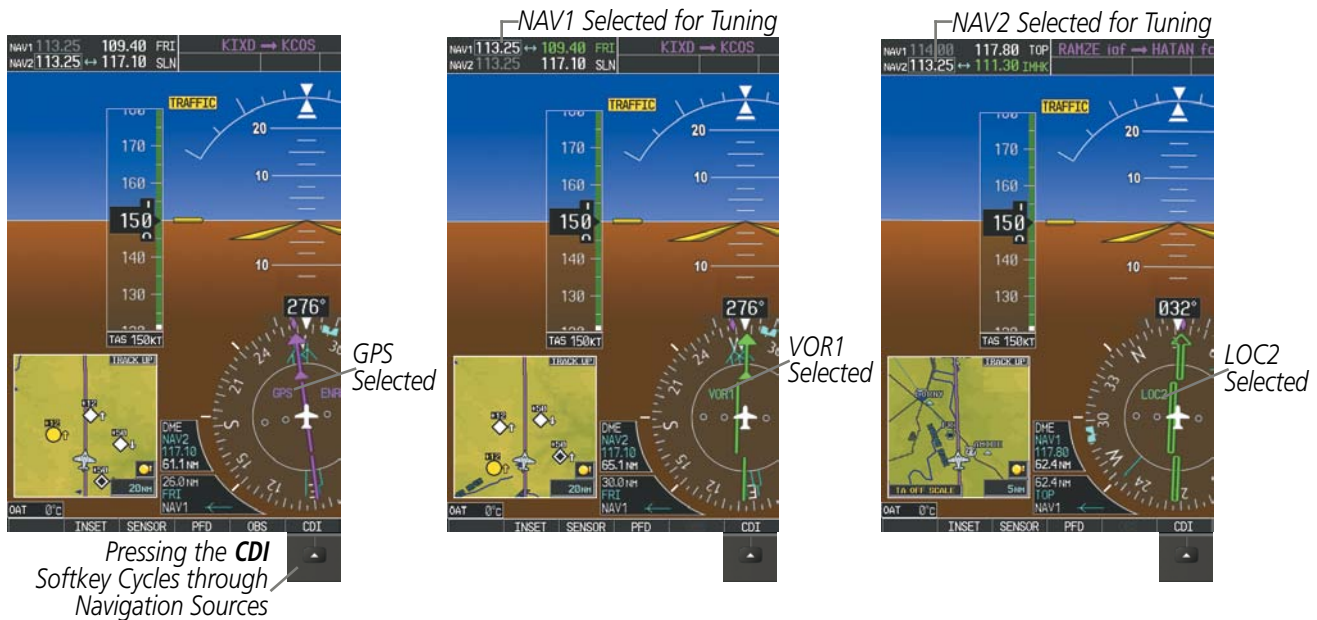

Figure 2-25 Selecting a Navigation Source

The system automatically switches from GPS to LOC navigation source and changes the CDI scaling accordingly when all of the following occur:

- A localizer or ILS approach has been loaded into the active flight plan
- The final approach fix (FAF) is the active leg, the FAF is less than 15 nm away, and the aircraft is moving toward the FAF
- A valid localizer frequency has been tuned
- The GPS CDI deviation is less than 1.2 times full-scale deflection

GPS steering guidance is still provided after the CDI automatically switches to LOC until LOC capture, up to the Final Approach Fix (FAF) for an ILS approach, or until GPS information becomes invalid. Activating a Vector-to-Final (VTF) also causes the CDI to switch to LOC navigation source. GPS steering guidance is not provided after this switch.

If the same VOR/LOC navigation source is selected on both PFDs, the navigation source annunciation turns yellow on both displays (unless synchronized). Once the CDIs are synchronized (CDI Synchronization turned on), they remain synchronized until the setting is changed. When turning on the G1000 for use, the system remembers the last CDI synchronization setting.

Synchronizing the CDIs:

- 1) Select the AUX - System Setup Page using the **FMS** Knob.
- 2) Press the **FMS** Knob to activate the cursor. Time Format is highlighted.
- 3) Turn the large **FMS** Knob to highlight the CDI Synchronization ON/OFF field.
- 4) Turn the small **FMS** Knob clockwise to ON or counterclockwise to OFF.
- 5) Press the **FMS** Knob to remove the cursor.

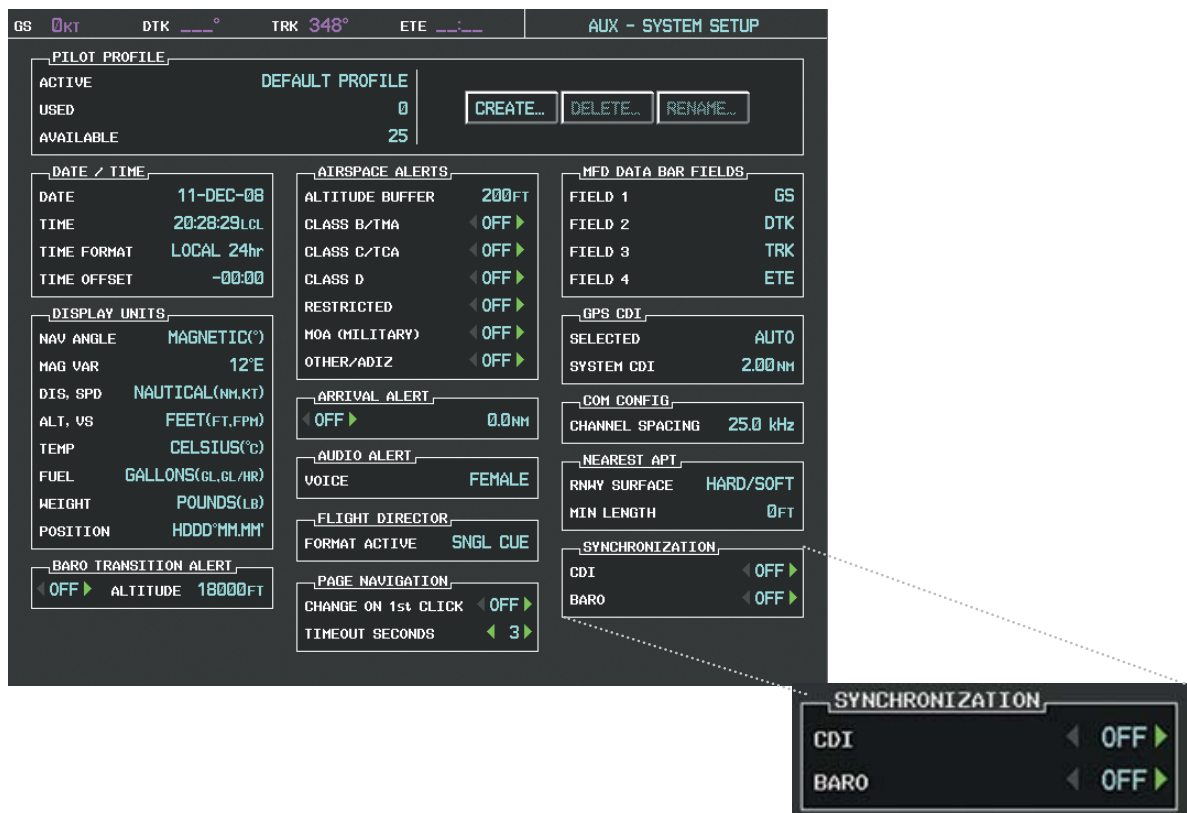

Figure 2-26 CDI Synchronization Setting (AUX - System Setup Page)

GPS CDI SCALING

When GPS is the selected navigation source, the flight plan legs are sequenced automatically and annunciations appear on the HSI for the flight phase. Flight phase annunciations are normally shown in magenta, but when cautionary conditions exist the color changes to yellow. If the current leg in the flight plan is a heading leg, HDG LEG is annunciated in magenta beneath the aircraft symbol.

The current GPS CDI scale setting is displayed as System CDI on the AUX - System Setup Page and the full-scale deflection setting may also be changed (2.0 nm, 1.0 nm, 0.3 nm, or Auto) from this page. If the selected scaling is smaller than the automatic setting for enroute and terminal phases, the CDI is scaled accordingly and the selected setting is displayed rather than the flight phase annunciation.

Changing the selected GPS CDI setting:

- 1) Use the **FMS** Knob to select the AUX - System Setup Page on the MFD.
- 2) Press the **FMS** Knob to activate the cursor.
- 3) Turn the large **FMS** Knob to highlight Selected in the GPS CDI box.
- 4) Turn the small **FMS** Knob to highlight the desired setting and press the **ENT** Key.
- 5) To cancel the selection, press the **FMS** Knob or the **CLR** Key.

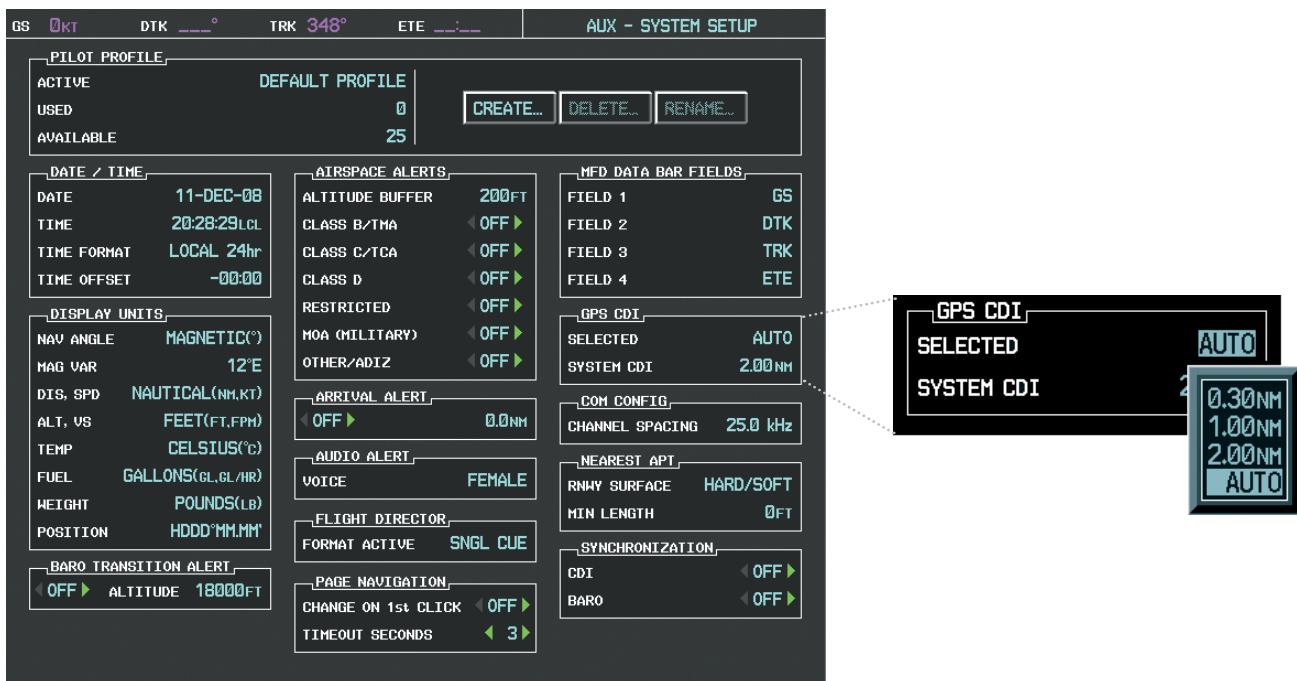

Figure 2-27 GPS CDI Settings (AUX - System Setup Page)

When set to Auto (default), the GPS CDI scale automatically adjusts to the desired limits based upon the current phase of flight (Figure 2-28, Table 2-1).

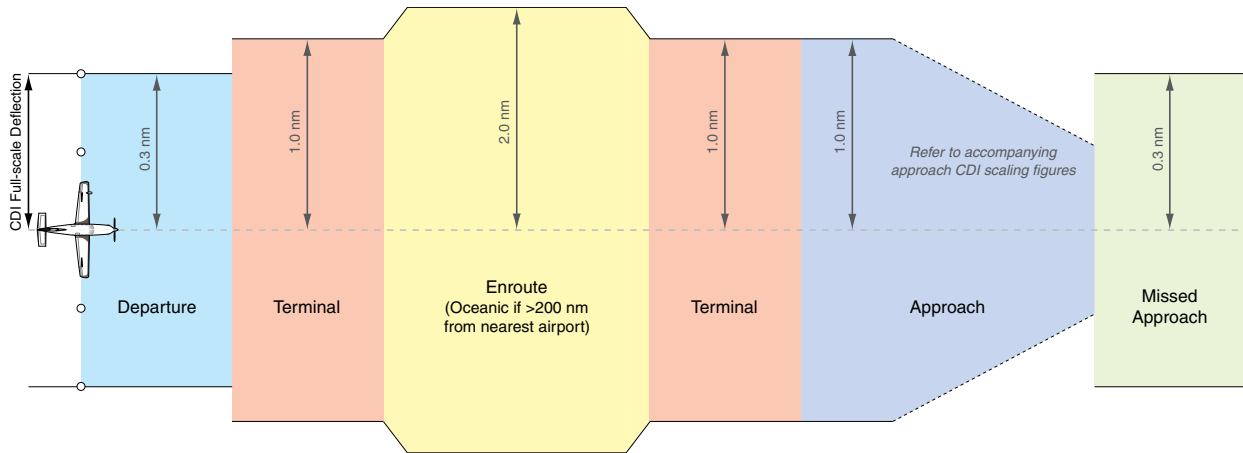

Figure 2-28 Automatic CDI Scaling

- Once a departure procedure is activated, the CDI is scaled for **departure** (0.3 nm).
- The system switches from departure to **terminal** CDI scaling (1.0 nm) under the following conditions:
 - The next leg in the departure procedure is not aligned with the departure runway
 - The next leg in the departure procedure is not a CA, CD, CF, CI, CR, DF, FA, FC, FD, FM, IF, or TF (see Glossary for leg type definitions)
 - After any leg in the departure procedure that is not a CA or FA
- At 30 nm from the departure airport, the **enroute** phase of flight is automatically entered and CDI scaling changes to 2.0 nm over a distance of 1.0 nm, except under the following conditions:
 - When navigating with an active departure procedure, the flight phase and CDI scale does not change until the aircraft arrives at the last departure waypoint (if more than 30 nm from the departure airport) or the leg after the last departure waypoint has been activated or a direct-to waypoint is activated.
- If after completing the departure procedure the nearest airport is more than 200 nm away from the aircraft and the approach procedure has not yet commenced, the CDI is scaled for **oceanic** flight (2.0 nm).
- Within 31 nm of the destination airport (**terminal** area), the CDI scale gradually ramps down from 2.0 nm to 1.0 nm over a distance of 1.0 nm; except under the following conditions:
 - When navigating with an active arrival route, the flight phase and CDI scale does not change until the aircraft arrives at the first waypoint in the arrival route (if within 31 nm from the destination airport).
- During **approach**, the CDI scale ramps down even further (see Figures 2-29 and 2-30). This transition normally occurs within 2.0 nm of the final approach fix (FAF). The CDI switches to approach scaling automatically once the approach procedure is activated or if Vectors-To-Final (VTF) are selected.
 - If the active waypoint is the FAF, the ground track and the bearing to the FAF must be within 45° of the final approach segment course.
 - If the active waypoint is part of the missed approach procedure, the active leg and the preceding missed approach legs must be aligned with the final approach segment course and the aircraft must not have passed the turn initiation point.

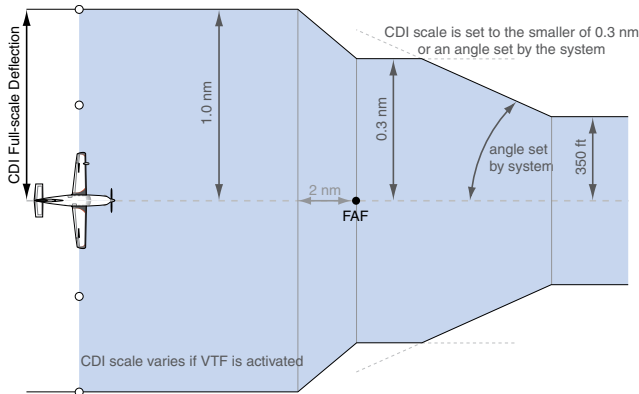

Figure 2-29 Typical LNAV and LNAV+V Approach CDI Scaling

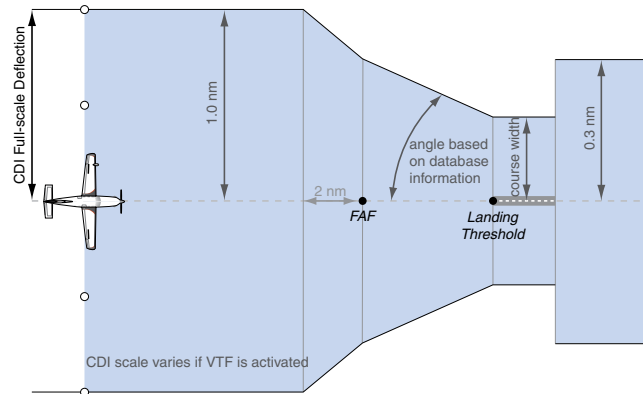

Figure 2-30 Typical LNAV/VNAV and LPV Approach CDI Scaling

- When a **missed approach** is activated, the CDI scale changes to 0.3 nm.
- The system automatically switches back to **terminal** mode under the following conditions:
 - The next leg in the missed approach procedure is not aligned with the final approach path
 - The next leg in the missed approach procedure is not a CA, CD, CF, CI, CR, DF, FA, FC, FD, FM, IF, or TF
 - After any leg in the missed approach procedure that is not a CA or FA

Flight Phase	Annunciation*	Automatic CDI Full-scale Deflection
Departure	DPRT	0.3 nm
Terminal	TERM	1.0 nm
Enroute	ENR	2.0 nm
Oceanic	OCN	2.0 nm
Approach (Non-precision)	LNAV	1.0 nm decreasing to 350 feet depending on variables (see Figure 2-29)
Approach (Non-precision with Vertical Guidance)	LNAV + V	
Approach (LNAV/VNAV)	L/VNAV	1.0 nm decreasing to a specified course width, then 0.3 nm, depending on variables (see Figure 2-30)
Approach (LPV)	LPV	
Missed Approach	MAPR	0.3 nm

* Flight phase annunciations are normally shown in magenta, but when cautionary conditions exist the color changes to yellow.

Table 2-1 Automatic GPS CDI Scaling

OBS MODE



NOTE: VNV is inhibited while automatic waypoint sequencing has been suspended.

Enabling Omni-bearing Selector (OBS) Mode suspends the automatic sequencing of waypoints in a GPS flight plan (GPS must be the selected navigation source), but retains the current “active-to” waypoint as the navigation reference even after passing the waypoint. OBS is annunciated to the lower right of the aircraft symbol on the moving map when OBS Mode is selected.

While OBS Mode is enabled, a course line is drawn through the Active-to waypoint on the moving map. If desired, the course to/from the waypoint can now be adjusted. When OBS Mode is disabled, the GPS flight plan returns to normal operation with automatic sequencing of waypoints, following the course set in OBS Mode. The flight path on the moving map retains the modified course line.

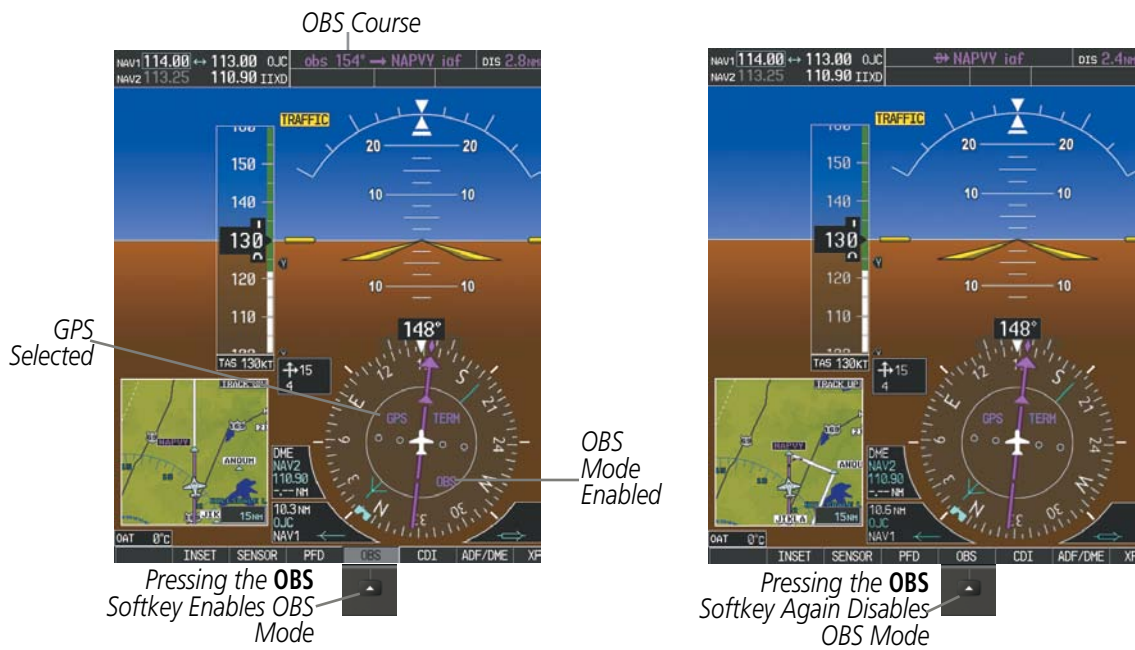

Figure 2-31 Omni-bearing Selector (OBS) Mode

Enabling/disabling OBS Mode while navigating a GPS flight plan:

- 1) Press the **OBS** Softkey to select OBS Mode.
- 2) Turn a **CRS** Knob to select the desired course to/from the waypoint. Press the **CRS** Knob to synchronize the Selected Course with the bearing to the next waypoint.
- 3) Press the **OBS** Softkey again to return to automatic waypoint sequencing.

As the aircraft crosses the missed approach point (MAP), automatic approach waypoint sequencing is suspended. **SUSP** appears on the HSI at the lower right of the aircraft symbol. The **OBS** Softkey label changes to indicate the suspension is active as shown in figure 2-32. Selecting the **SUSP** Softkey deactivates the suspension and resumes automatic sequencing of approach waypoints.

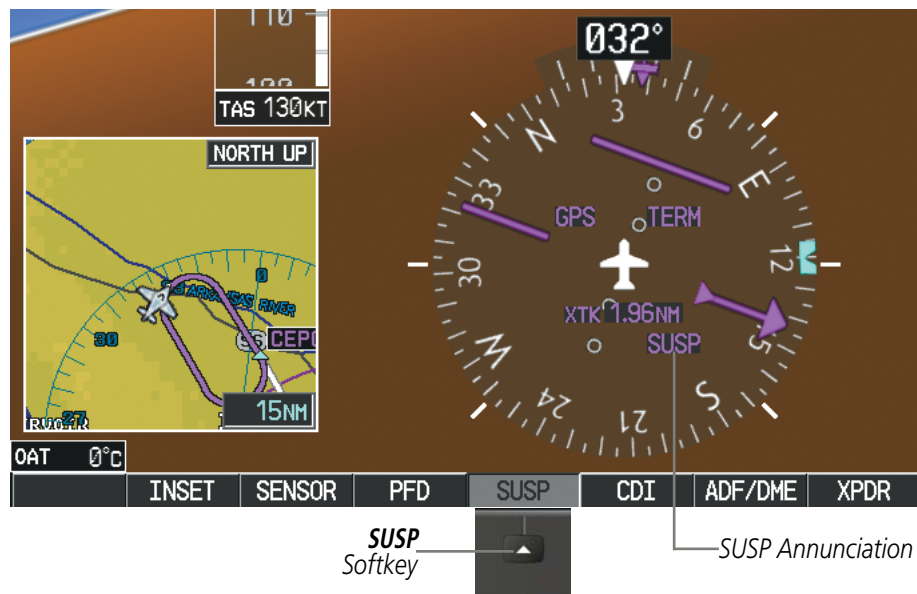

Figure 2-32 Suspending Automatic Waypoint Sequencing

2.2 SUPPLEMENTAL FLIGHT DATA

NOTE: Selecting the **DFLTS** Softkey turns off metric altimeter display, Hpa Baro Setting, the Inset Map, and wind data display.

In addition to the flight instruments, the PFD also displays various supplemental information, including temperatures, wind data, and Vertical Navigation (VNV) indications.

TEMPERATURE DISPLAYS

The Outside Air Temperature (OAT) is displayed in degrees Celsius (°C) by default in the lower left of the PFD under normal display conditions, or below the true airspeed in reversionary mode.

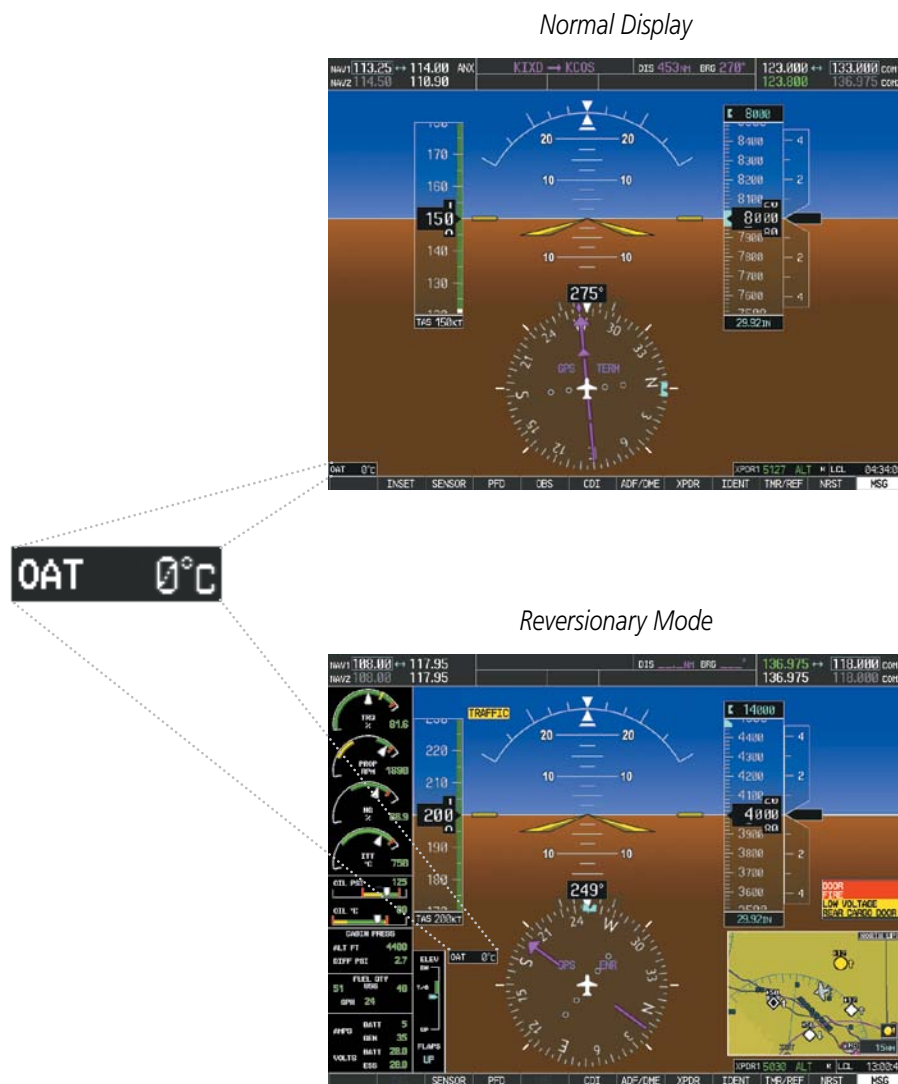

Figure 2-33 Outside Air Temperature

Changing temperature display units:

- 1) Select the AUX - System Setup Page on the MFD using the **FMS** Knob.
- 2) Press the **FMS** Knob to activate the cursor.
- 3) Turn the large **FMS** Knob to highlight the TEMP field in the Display Units box.
- 4) Turn the small **FMS** Knob to highlight either CELSIUS or FAHRENHEIT and press the **ENT** Key to confirm the selection.
- 5) To cancel the selection, press the **FMS** Knob or the **CLR** Key.

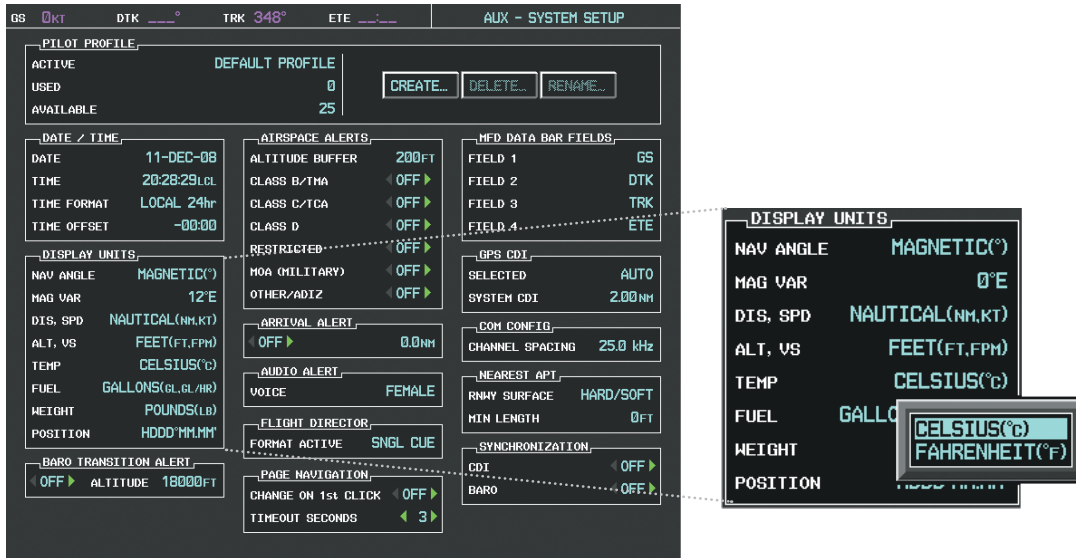

Figure 2-34 Temperature Selection Setting (AUX - System Setup Page)

WIND DATA

Wind direction and speed in knots can be displayed relative to the aircraft in a window to the upper left of the HSI. When the window is selected for display, but wind information is invalid or unavailable, the window shows NO WIND DATA. Wind data can be displayed in three different ways.

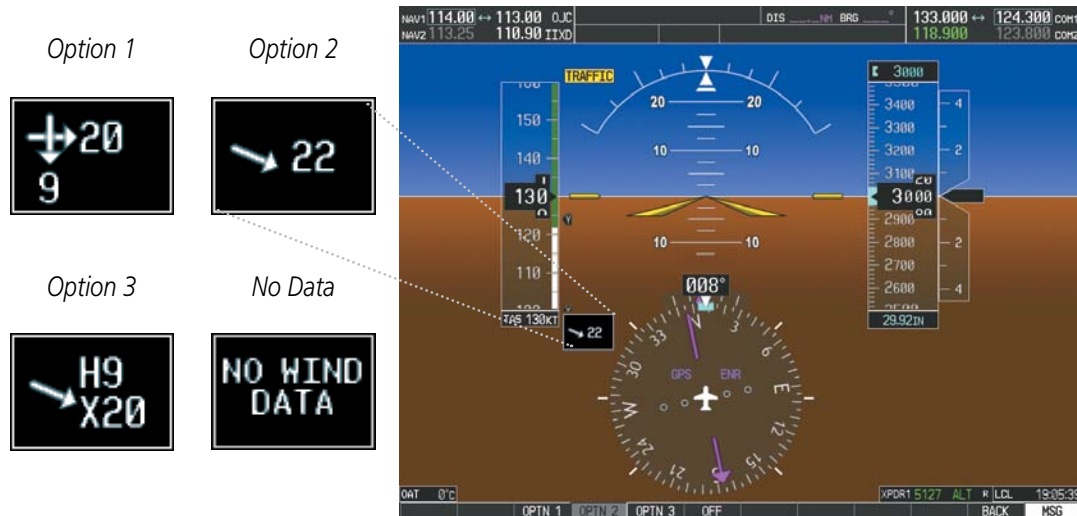

Figure 2-35 Wind Data

Displaying wind data:

- 1) Press the **PFD** Softkey.
- 2) Press the **WIND** Softkey to display wind data to the left of the HSI.
- 3) Press one of the **OPTN** softkeys to change how wind data is displayed:
 - **OPTN 1**: Wind direction arrows with numeric headwind/tailwind and crosswind components
 - **OPTN 2**: Wind direction arrow with numeric speed
 - **OPTN 3**: Wind direction arrow with numeric direction and speed
- 4) To remove the window, select the **OFF** Softkey.

VERTICAL NAVIGATION (VNV) INDICATIONS

When a VNV flight plan has been activated, VNV indications (VNV Target Altitude, RVSI, VDI) appear on the PFD in conjunction with the “TOD within 1 minute message” and “Vertical track” voice alert. See the Flight Management and AFCS sections for details on VNV features. VNV indications are removed from the PFD according to the criteria listed in Table 2-2.



Figure 2-36 Vertical Navigation Indications (PFD)

Criteria	VNV Indication Removed		
	Required Vertical Speed (RVSI)	Vertical Deviation (VDI)	VNV Target Altitude
Aircraft > 1 min before the next TOD due to flight plan change	X	X	X
VNV cancelled (CNCL VNV Softkey selected on MFD)	X	X	X
Distance to active waypoint cannot be computed due to unsupported flight plan leg type (see Flight Management Section)	X	X	X
Aircraft > 250 feet below active VNV Target Altitude	X	X	X
Current crosstrack or track angle error has exceeded limit	X	X	X
Active altitude-constrained waypoint can not be reached within maximum allowed flight path angle and vertical speed	X	X	

Table 2-2 VNV Indication Removal Criteria

2.3 PFD ANNUNCIATIONS AND ALERTING FUNCTIONS

The following annunciations and alerting functions are displayed on the PFD. Refer to the Engine/Airframe Systems Section for information on the Crew Alerting System (CAS) and to Appendix A for more information on alerts and annunciations.

SYSTEM ALERTING

The System Messages Window conveys messages to the flight crew regarding problems with the G1000 System. When a new message is issued, the **MSG** Softkey flashes to alert the flight crew. It continues to flash until pressed, which opens the System Messages Window and acknowledges the message(s) which initiated the flashing. When the window is open, messages for conditions which are no longer active turn gray. Messages generated while the window is open are not automatically displayed, but cause the **MSG** Softkey to begin flashing again. Pressing the **MSG** Softkey while the System Messages Window is open closes the window unless the **MSG** Softkey is flashing.

Critical values generated by redundant sensors are monitored by comparators. If differences in the sensors exceed a specified amount, the Comparator Window appears in the upper right corner of the PFD and the discrepancy is annunciated in the Comparator Window as a MISCOMP (miscompare). If one or both of the sensed values are unavailable, it is annunciated as a NO COMP (no compare).

Reversionary sensor selection is annunciated in a window on the right side of the PFD. These annunciations reflect reversionary sensors selected on one or both PFDs. Pressing the **SENSOR** Softkey accesses the **ADC1**, **ADC2**, **AHRS1**, and **AHRS2** softkeys. These softkeys allow switching of the sensors being viewed on each PFD. With certain types of sensor failures, the system may make some sensor selections automatically. The GPS sensor cannot be switched manually.

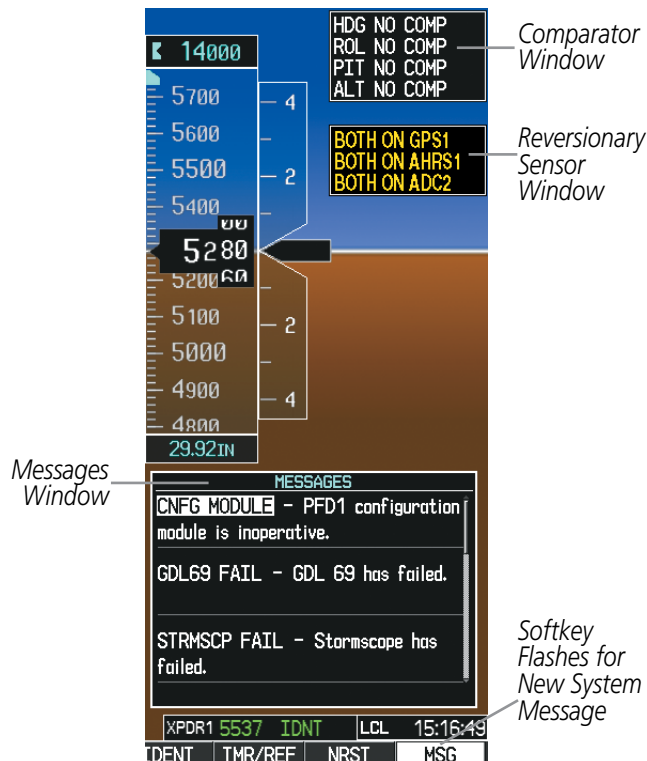

Figure 2-37 G1000 Alerting System

MARKER BEACON ANNUNCIATIONS

Marker Beacon Annunciations are displayed on the PFD to the left of the Selected Altitude. Outer marker reception is indicated in blue, middle in amber, and inner in white. Refer to the Audio Panel and CNS Section for more information on Marker Beacon Annunciations.

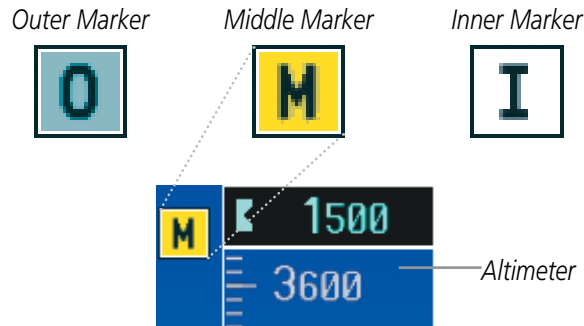

Figure 2-38 Marker Beacon Annunciations

TRAFFIC ANNUNCIATION

Traffic is displayed symbolically on the Inset Map (PFD), the Navigation Map Page (MFD), and various other MFD page maps. Refer to the Hazard Avoidance Section and Appendix F for more details about Traffic alerts. When a Traffic Advisory (TA) is detected, the following automatically occurs:

- The PFD Inset Map is enabled, displaying traffic
- A flashing black-on-yellow TRAFFIC annunciation appears to the top left of the Attitude Indicator for five seconds and remains displayed until no TAs are detected in the area
- The aural alert “TRAFFIC” is generated

If additional TAs appear, new aural and visual alerts are generated.

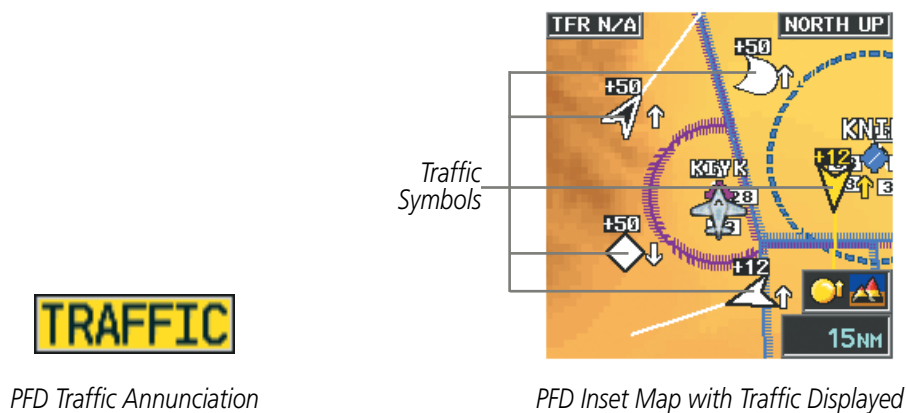

Figure 2-39 Traffic Annunciation and Inset Map with Traffic Displayed

TERRAIN ANNUNCIATIONS

Terrain Awareness and Warning System (TAWS) or TERRAIN-SVS annunciations appear on the PFD to the upper left of the altimeter. Refer to the Hazard Avoidance Section and Appendix A for information on terrain alerts and annunciations.



Figure 2-40 Traffic and Example Terrain Annunciations

ALTITUDE ALERTING

The Altitude Alerting function provides visual alerts when approaching the Selected Altitude, and visual and aural alerts when deviating from the selected altitude. Whenever the Selected Altitude on the PFD is changed, Altitude Alerting is reset. Altitude Alerting is independent of the AFCS.

The following occur when approaching the Selected Altitude:

- Upon passing through 1000 feet of the Selected Altitude, the Selected Altitude Box changes to black text on a light blue background and flashes for five seconds.
- When the aircraft passes within 200 feet of the Selected Altitude, the Selected Altitude changes to light blue text on a black background and flashes for five seconds.
- After reaching the Selected Altitude, if the aircraft flies outside the deviation band (± 200 feet of the Selected Altitude), the Selected Altitude Box changes to yellow text on a black background, flashes for five seconds, and an aural tone is generated.



Figure 2-41 Altitude Alerting Visual Annunciations

LOW ALTITUDE ANNUNCIATION



NOTE: This Low Altitude Annunciation is available only for aircraft with GIA 63W Integrated Avionics Units when SBAS is available. This annunciation is not shown for systems with TAWS, unless TAWS is inhibited.

When the Final Approach Fix (FAF) is the active waypoint in a GPS SBAS approach using vertical guidance, a Low Altitude Annunciation may appear if the current aircraft altitude is at least 164 feet below the prescribed altitude at the FAF. A black-on-yellow LOW ALT annunciation appears to the top right of the Altimeter, flashing for several seconds then remaining displayed until the condition is resolved.

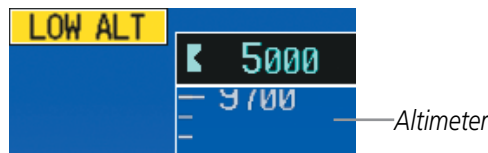

Figure 2-42 Low Altitude on GPS SBAS Approach

MINIMUM DESCENT ALTITUDE/DECISION HEIGHT ALERTING

For altitude awareness, a Minimum Descent Altitude (MDA) or Decision Height (DH), based on barometric altitude or radar altitude, can be set. When active, the altitude setting is displayed to the lower left of the altimeter and with a bug at the corresponding altitude along the altimeter (once the altitude is within the visible range of the tape). The following visual annunciations alert the pilot when approaching the MDA or DH:

- When the aircraft altitude descends to within 2500 feet of the MDA/DH setting, a box labeled BARO MIN or RA MIN (based on the selected altitude source) appears with the altitude in light blue text. The bug appears in light blue on the altitude tape at the corresponding altitude once in range.
- When the aircraft passes through 100 feet of the MDA or DH, the bug and text turn white.
- Once the aircraft reaches the MDA/DH, the bug and text turn yellow and the aural alert, “Minimums Minimums”, is generated. When the radar altimeter is selected as the altitude source for the Minimum Descent Altitude alerting function, the color of the current radar height changes to yellow.

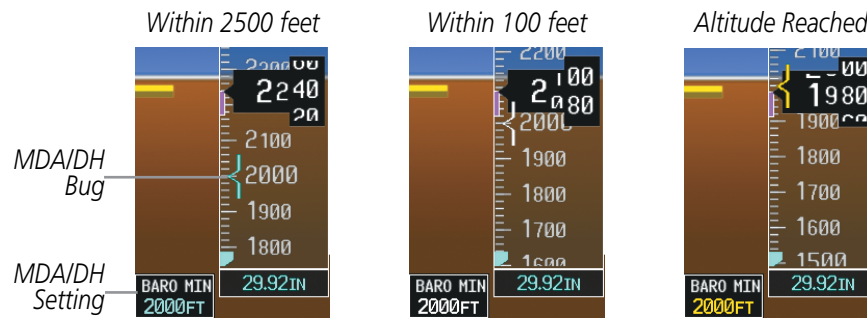

Figure 2-43 Barometric MDA/DH Alerting Visual Annunciations

Alerting is inhibited while the aircraft is on the ground and until the aircraft reaches 150 feet above the setting for the alert. If the aircraft proceeds to climb after having reached the MDA/DH, once it reaches 50 feet above the MDA/DH, alerting is disabled.

The MDA/DH may be set from either PFD and is synchronized on both PFDs. The function is reset when the power is cycled.

Setting the barometric minimum descent altitude and bug:

- 1) Press the **TMR/REF** Softkey.
- 2) Turn the large **FMS** Knob to highlight the Minimums field.
- 3) Turn the small **FMS** Knob to select the desired altitude source: barometric (BARO) or radar altimeter (RAD ALT). OFF is selected by default. Press the **ENT** Key or turn the large **FMS** Knob to highlight the next field.
- 4) Use the small **FMS** Knob to enter the desired altitude (from zero to 16,000 feet).
- 5) To remove the window, press the **CLR** Key or press the **TMR/REF** Softkey.

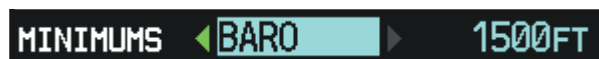

Figure 2-44 Timer/References Window, MDA/DH Setting

RADAR ALTIMETER

When the radar height (the aircraft altitude above ground level detected by the radar altimeter) is between zero and 2500 feet, the current value is displayed in green to the upper right of the HSI (Figure 2-45). Display of radar height becomes more sensitive as the height above ground decreases (Table 2-3).



Figure 2-45 Current Radar Height

Radar Height Range	Shown to Nearest
0 to 200 feet	5 feet
200 to 1500 feet	10 feet
1500 to 2500 feet	50 feet

Table 2-3 Radar Altimeter Sensitivity

When the radar altimeter is selected as the altitude source for the minimum descent altitude alerting function (Figure 2-46), the color of the radar height changes to yellow upon reaching (or descending below) the altitude entered. (Figure 2-47).

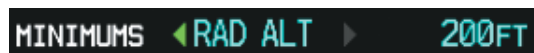

Figure 2-46 RAD ALT Setting
(Timer/References Window)



Figure 2-47 RA as Altitude Source for MDA/DH

A ground line (Figure 2-48) is shown on the Altimeter to display the aircraft's height relative to the ground. If the data becomes invalid, the message "RA FAIL" is displayed in yellow in place of the current radar height (Figure 2-49). The Radar Altimeter test is done on the MFD but is displayed on the PFD directly above the Radar Altimeter box (Figure 2-50).

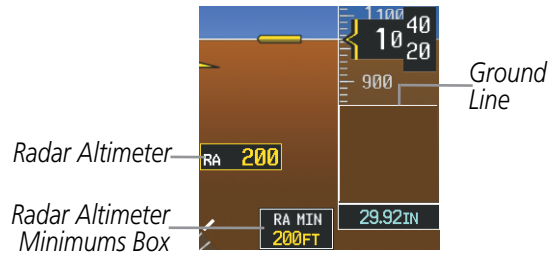

Figure 2-48 Altimeter Displaying the Ground Line (RAD ALT)



Figure 2-49 Radar Altimeter Invalid Data

Testing the Radar Altimeter (KRA 405 only):

- 1) Turn the **FMS** Knob to select the AUX - System Status Page on the MFD.
- 2) Select the **RA TEST** Softkey.

Or:

- 1) Press the **MENU** Key.
- 2) Turn the **FMS** Knob to highlight 'Enable RA Test Mode' and press the **ENT** Key.

The 'RA TEST' annunciation is displayed above the RA box (Figure 2-50). To cancel the test, select the **RA TEST** Softkey again, or turn the **FMS** Knob to exit the AUX - System Status Page.



Figure 2-50 Radar Altimeter Test Display (KRA 405)

2.4 ABNORMAL OPERATIONS

ABNORMAL GPS CONDITIONS

The annunciations listed in Table 2-4 can appear on the HSI when abnormal GPS conditions occur (Figure 2-52). Refer to the Flight Management Section for more information on Dead Reckoning Mode.

Annunciation	Location	Description
LOI	Lower left of aircraft symbol	Loss of Integrity Monitoring—GPS integrity is insufficient for the current phase of flight
INTEG OK	Lower left of aircraft symbol	Integrity OK—GPS integrity has been restored to within normal limits (annunciation displayed for five seconds)
DR	Upper right of aircraft symbol	Dead Reckoning—System is using projected position rather than GPS position to compute navigation data and sequence active flight plan waypoints

Table 2-4 Abnormal GPS Conditions Annunciated on HSI



Figure 2-51 Example of HSI Annunciations

Dead Reckoning (DR) Mode causes the following items on the PFD to be shown in yellow when GPS is the selected navigation source:

- CDI (removed after 20 minutes)
- Current Track Bug
- Wind Data (calculated based on GPS information)
- Distances in the Bearing Information windows
- GPS bearing pointers

It is important to note that estimated navigation data supplied by the G1000 in DR Mode may become increasingly unreliable and must not be used as a sole means of navigation. See the Flight Management section for more information about DR mode

UNUSUAL ATTITUDES

When the aircraft enters an unusual pitch attitude, red extreme pitch warning chevrons pointing toward the horizon are displayed on the Attitude Indicator, starting at 50° above and 30° below the horizon line.

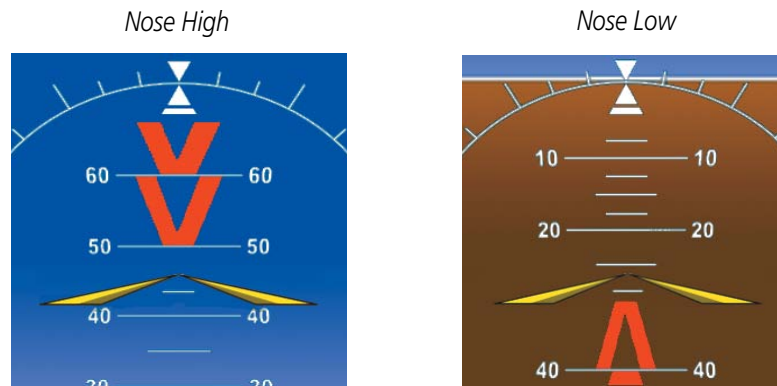

Figure 2-52 Pitch Attitude Warnings

If pitch exceeds +30°/-20° or bank exceeds 65°, some information displayed on the PFD is removed. The Altimeter and Airspeed, Attitude, Vertical Speed, and Horizontal Situation indicators remain on the display and the Bearing Information, Alerts, and Annunciation windows can be displayed during such situations. The following information is removed from the PFD (and corresponding softkeys are disabled) when the aircraft experiences unusual attitudes:

- Traffic Annunciations
- AFCS Annunciations
- Flight director Command Bars
- Inset Map
- Outside air temperature (OAT)
- DME Information Window
- Wind data
- Selected Heading readout
- Selected Course readout
- Transponder Status Box
- System Time
- PFD Setup Menu
- Windows displayed in the lower right corner of the PFD:
 - Timer/References
 - Nearest Airports
 - Flight Plan
 - Messages
 - Procedures
 - ADF/DME Tuning
- Minimum Descent Altitude/ Decision Height readout
- Vertical Deviation, Glideslope, and Glidepath Indicators
- Altimeter Barometric Setting
- Selected Altitude
- VNV Target Altitude

BLANK PAGE

SECTION 3 ENGINE AND AIRFRAME SYSTEMS

NOTE: Refer to the Pilot's Operating Handbook (POH) for limitations.

The G1000 offers improved flight operations and reduces crew workload by automatically monitoring critical system parameters and providing system alerts during all phases of flight using the following:

- The **Engine Indication System** (EIS) displays electrical, fuel, engine, pressurization, and flight control information on the left side of the Multi Function Display (MFD).
- **Synoptics pages** are provided for monitoring the status of the doors, de-icing systems, electrical, and fuel.
- The **Crew Alerting System** (CAS) displays advisories, cautions, and warnings to communicate conditions, statuses, and system failures. CAS messages are grouped by level of importance and color-coded based on urgency and appear on the left side of the MFD.

In combination with these, aural alerts, additional avionics messages, and master indicators are used to inform the crew of aberrant flight conditions. The system also provides an improved level of maintenance data for the ground crew.

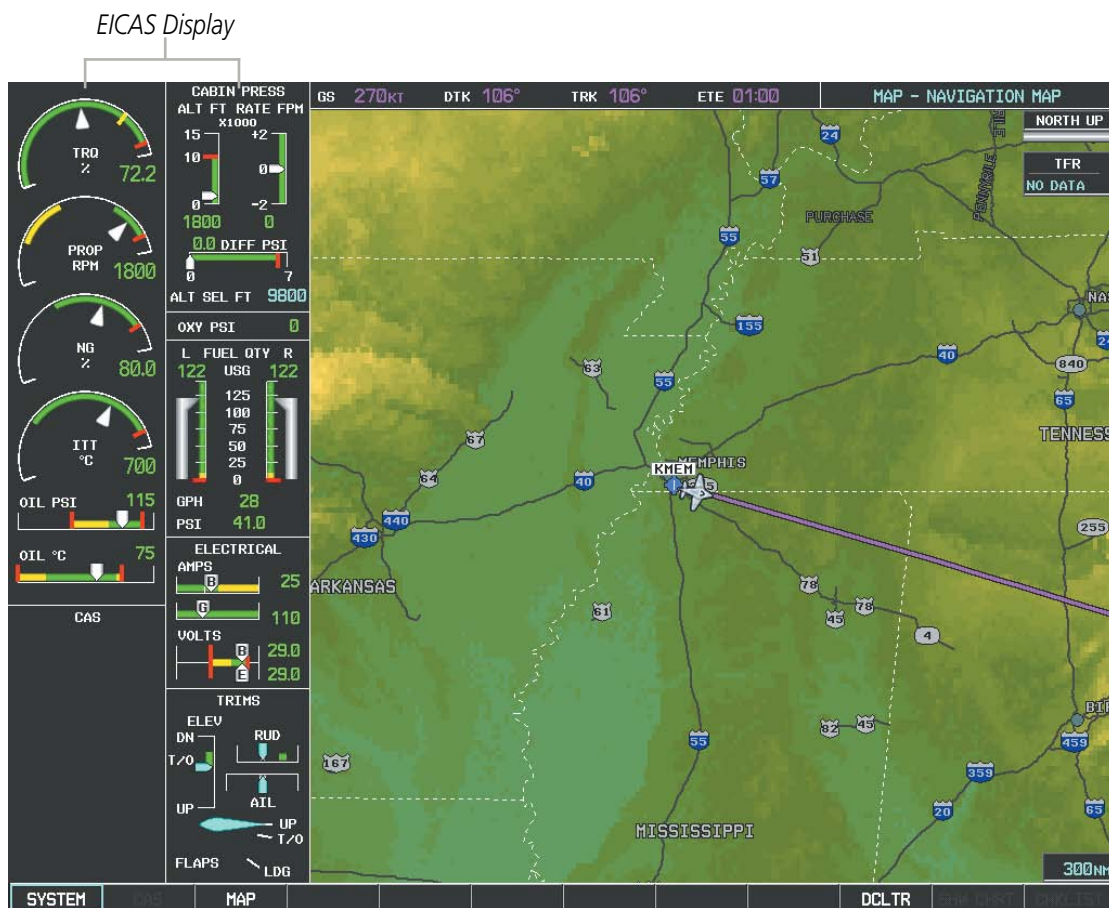

Figure 3-1 Multi Function Display

In the event of a display failure, depending on the failed display(s), the functioning display(s) may be re-configured to present Primary Flight Display (PFD) symbology together with engine and CAS information (refer to the System Overview for more information about Reversionary Mode). In Reversionary Mode, engine, pressurization, fuel, electrical, and trim data is presented in an abbreviated format on the left of the display. CAS messages appear in a window on the right of the display. Synoptics are not available while in Reversionary Mode.



Figure 3-2 Reversionary Mode

3.1 ENGINE INDICATION SYSTEM (EIS)

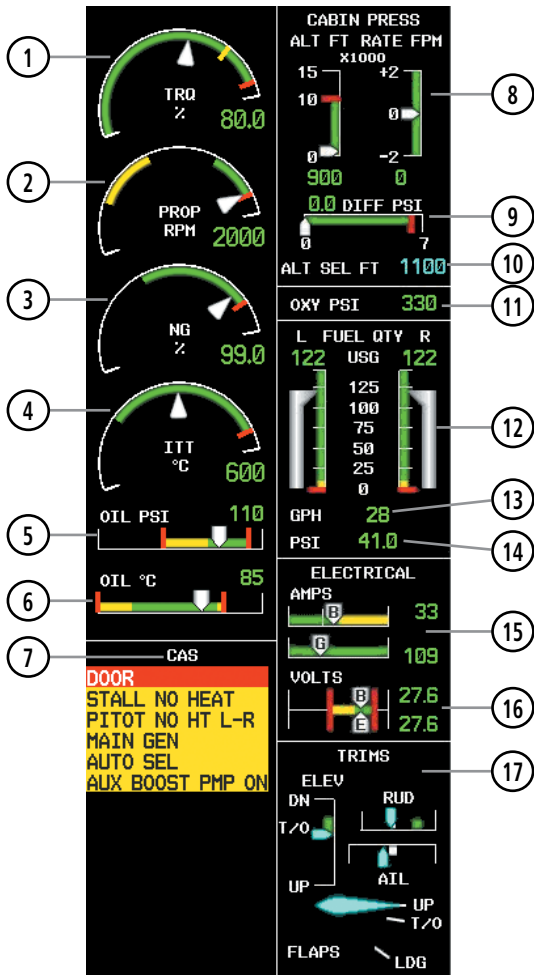

Figure 3-3 EIS Display (Normal Mode)

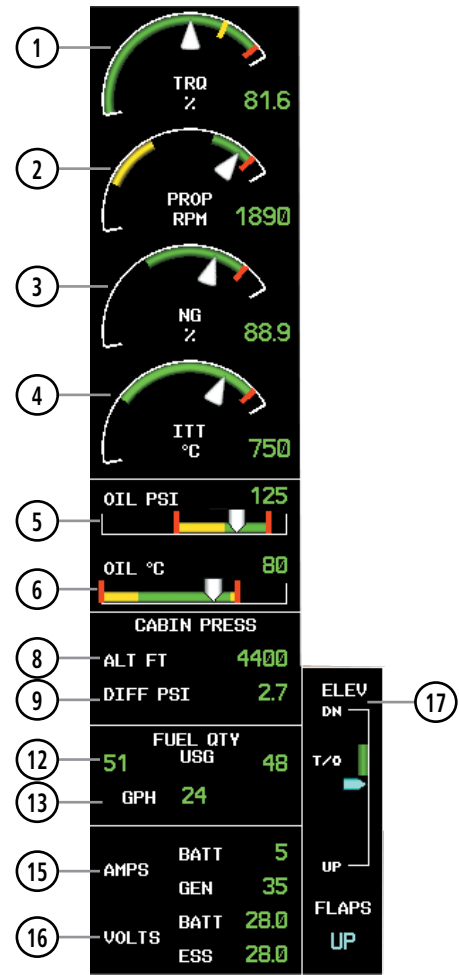

Figure 3-4 EIS Display (Reversionary Mode)

- | | |
|--|---|
| <ul style="list-style-type: none"> ① Torque ② Propeller Speed ③ Generator Speed ④ Interturbine Temperature ⑤ Oil Pressure ⑥ Oil Temperature ⑦ CAS Display ⑧ Cabin Pressure Altitude and Change Rate ⑨ Differential Pressure | <ul style="list-style-type: none"> ⑩ Selected Cabin Altitude ⑪ Oxygen Pressure ⑫ Fuel Quantity ⑬ Fuel Flow ⑭ Fuel Pressure ⑮ Battery and Generator Currents ⑯ Battery and Essential Bus Voltages ⑰ Elevator, Aileron, and Rudder Trim and Flap Position |
|--|---|

EIS information is presented using gauges, horizontal and vertical bar indicators, slide bars, and digital readouts. Green ranges on the instrument scales indicate normal ranges of operation; yellow and red bands indicate caution and warning, respectively. During normal operating conditions, an instrument's pointer appears in white and the readout text is green. When data is out of the range of the indicator or gauge, the pointer moves to the end of the scale; digital readouts display as "---" (dashes).

When an unsafe operating condition occurs, the pointer and readout color change to yellow or flash red, indicating a caution or warning. If a cautionary time limit is exceeded, the sliders, pointers, and digits may flash red, even if the parameter is still within in the cautionary range (refer to each display description for details). If the sensor data for a parameter becomes invalid or unavailable, a red "X" is displayed across the indicator and/or readout.

ENGINE PARAMETERS

The TBM 850's EIS displays torque, propeller speed, generator speed, and interturbine temperature using arc gauges.

TORQUE GAUGE

The Torque Gauge displays values from 0 to 130% of maximum safe torque. If the torque remains above 121.4% for more than 5 seconds or exceeds the value indicated by the red tick mark, a warning condition occurs. The maximum climb torque is displayed as a white triangle (bug) while the optimum cruise range is displayed as a white band on the Torque Gauge. When bleed pressure reaches its upper limit, 'BLEED HI' is annunciated above the Torque Gauge.



Figure 3-5 Torque Gauge

PROPELLER RPM GAUGE

Propeller speed is shown in revolutions per minute (rpm) from zero to 2200. If propeller speed slows to where the gauge pointer enters the yellow range, a caution is issued. A propeller overspeed warning is indicated if propeller speed exceeds the maximum safe operating speed.

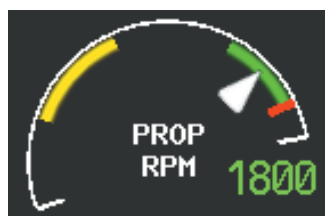

Figure 3-6 Propeller RPM Gauge

GENERATOR SPEED GAUGE

Generator speed is indicated as a percentage of maximum safe operating speed (rpm), from 0 to 120%. If generator speed exceeds 104% a warning condition occurs.

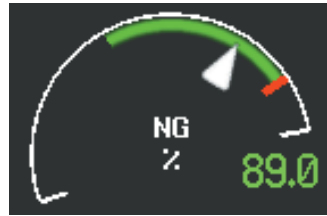

Figure 3-7 Generator Speed Gauge

ITT GAUGE

The Interturbine Temperature (ITT) Gauge ranges differ for engine off/start and running conditions. Values between 200 and 1200 degrees Celsius (°C) are shown at engine start; values change to 200 to 900°C when the engine starts running. When the engine is not running, 'OFF' is annunciated above the ITT readout; this changes to 'STRT' upon engine start. No annunciation is shown when the engine is running normally.

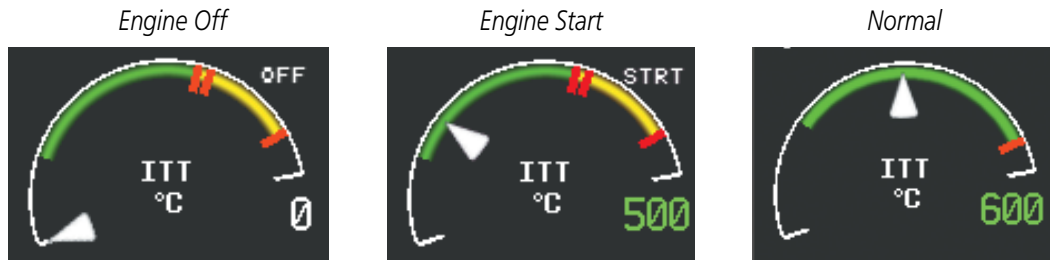

Figure 3-8 Interturbine Temperature Gauge Status Annunciations

Temperatures above which warnings occur are indicated by red tick marks along the ITT Gauge. Refer to comments for the 'ITT' CAS message in Table 3-5 for warning issuance criteria.

OIL PRESSURE AND TEMPERATURE GAUGES

Engine oil pressure and temperature are shown along horizontal bar indicators below the engine gauges. Oil pressure is shown in pounds per square inch (psi) and temperature in degrees Celsius (°C).



Figure 3-9 Oil Pressure and Temperature Gauges

CABIN PRESSURIZATION

Cabin pressurization information (cabin altitude, rate of change, and differential cabin pressure) is shown at the top of the right EICAS column. Only readouts for cabin altitude and pressure differential are displayed in Reversionary Mode.

Cabin altitude (ALT FT) is shown on a color-coded scale labeled in 5,000-ft increments with a readout (in feet) below. Cabin altitude change rate (RATE FPM) is displayed on a scale in terms of 2,000 fpm increments with a readout (in fpm) below. Cabin pressure differential (DIFF PSI), in pounds per square inch (psi), is indicated on a color-coded scale with a readout. Selected Cabin Altitude is displayed as a digital readout (in 100 ft increments) with a range from -1,000 to 11,000 feet.

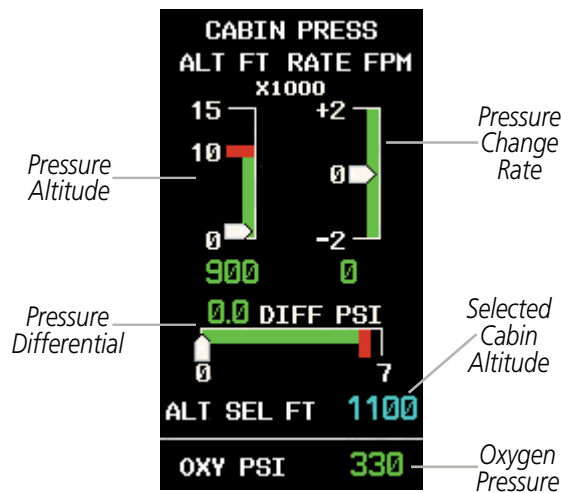

Figure 3-10 Cabin Pressure Display

The pressure (in psi) for the oxygen system is given as a readout below the cabin pressurization display under normal display conditions.

FUEL INFORMATION

The fuel display is located beneath the oxygen pressure readout and shows the fuel quantity in each tank (in United States gallons, USG), fuel flow (gallons per hour, gph), and fuel pressure (psi). Fuel quantity for each tank is normally shown along a slider scale. Readouts for fuel quantity and fuel flow are shown in Reversionary Mode.

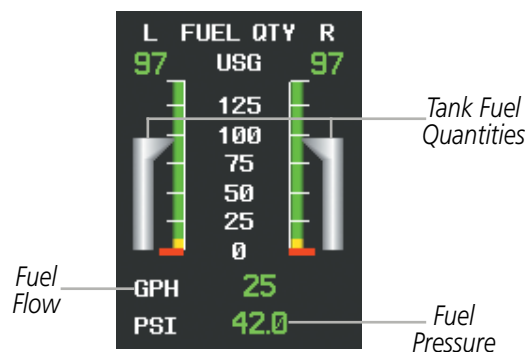

Figure 3-11 Fuel Display

ELECTRICAL INFORMATION

Currents for the battery (pointers labeled “B”) and generator (pointer labeled “G” for primary generator and “S” for standby generator) and voltages for the battery and essential bus (pointer labeled “E”) are shown along color-coded scales, with readouts to the right.

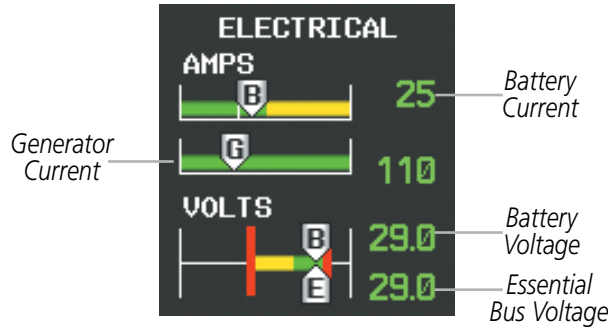

Figure 3-12 Electrical Display

TRIM AND FLAP INDICATORS

Elevator, rudder, and aileron trim indications are shown along slide bar scales next to the CAS messages in normal display mode. Flap deflection is normally displayed beneath the trim indications using a rotating pointer. Flap positions for takeoff, landing, and up positions are labeled. In Reversionary Mode, only elevator trim is indicated and flap position (UP, T/O, LDG) is provided as a digital readout.

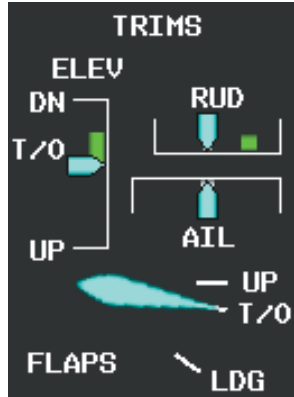

Figure 3-13 Trim and Flap Indications

3.2 SYNOPTICS

The Synoptics pages show current conditions of certain aircraft functionality on aviation system diagrams, reducing workload by allowing the flight crew to rapidly analyze the situation. Aircraft systems graphically depicted in the synoptic diagrams include:

- Electrical system
- Fuel system
- De-ice system
- Doors

Once the **SYSTEM** Softkey is selected, the Synoptics pages can be accessed using softkeys or the small **FMS** Knob. To return to the previously displayed page when a Synoptics Page has been displayed, select the **SYSTEM** Softkey or **CLR** Key, or turn the large **FMS** Knob.

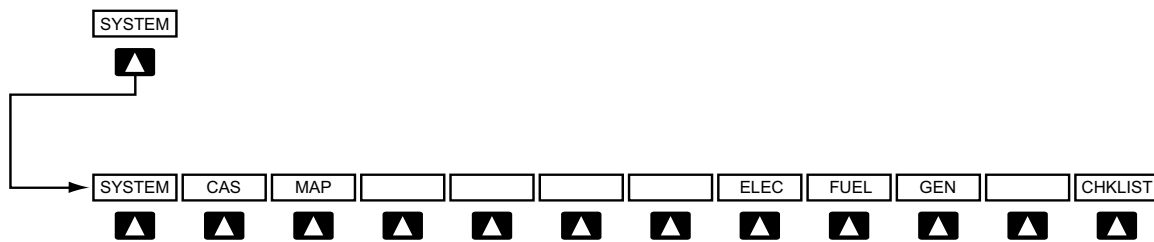

Figure 3-14 Synoptic Pages Softkeys

- **SYSTEM** Accesses the Synoptics page softkeys
- **ELEC** Displays the Electrical Synoptics Page
- **FUEL** Displays the Fuel Synoptics Page
- **GEN** Displays the General Synoptics Page for the de-ice system and doors

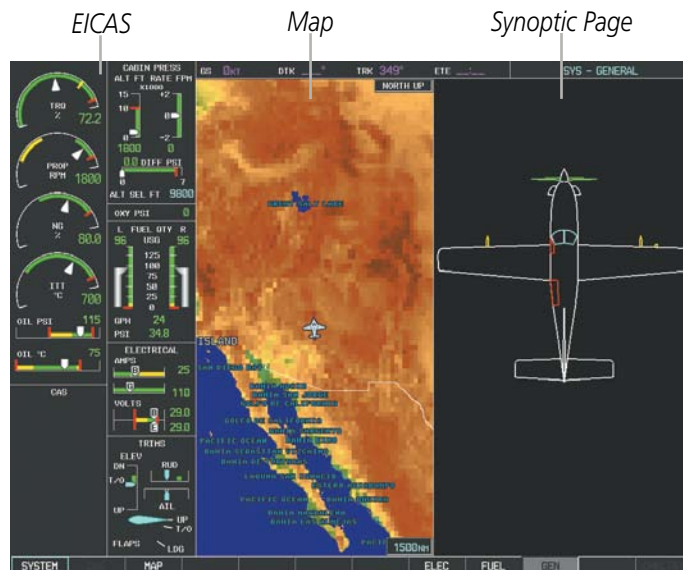

Figure 3-15 MFD Layout

ELECTRICAL SYSTEM

The Electrical Synoptics Page uses a diagram of the aircraft's electrical system to display the system status. The generators, ground power supply (GPU), batteries, and buses are shown in green to denote normal operation. Color of the units change depending on the condition.

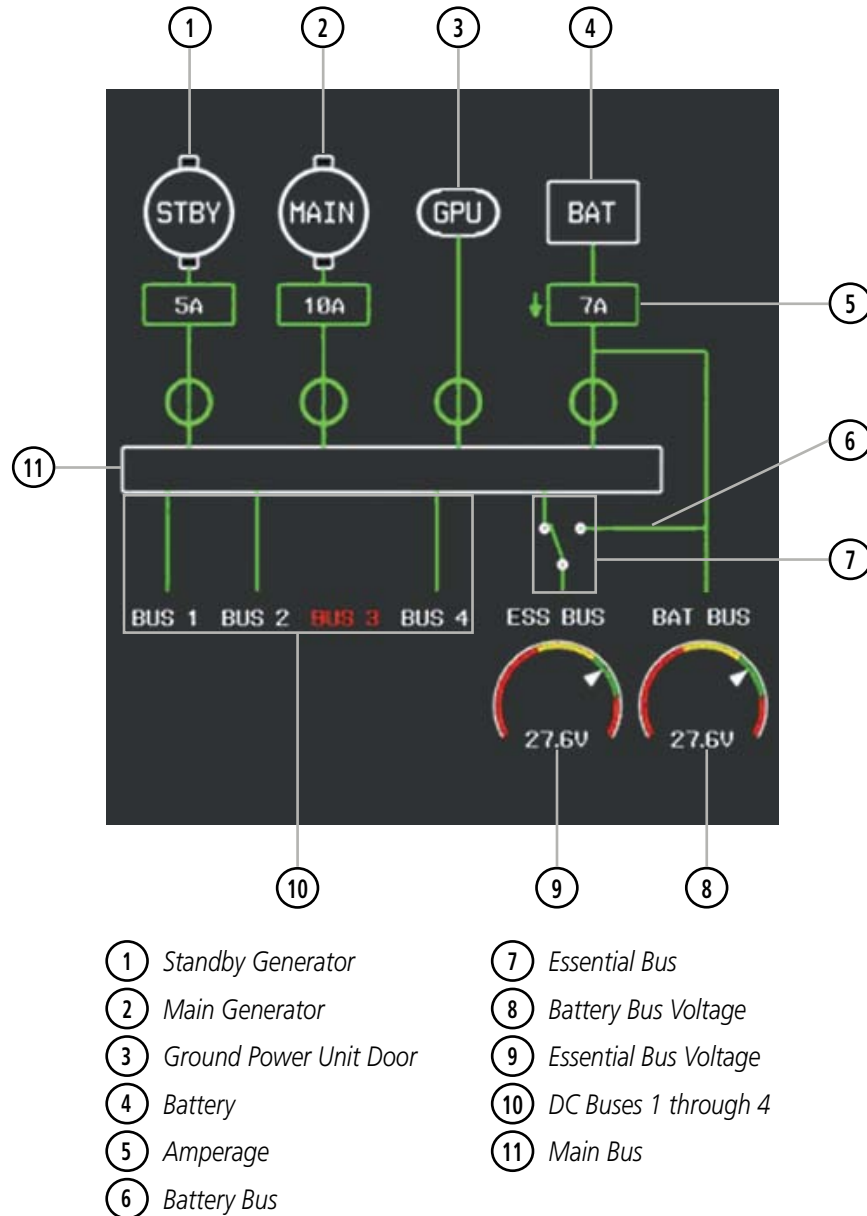

Figure 3-16 Electrical Synoptics Page

Active generator currents are displayed below the generator icons. A disconnected generator is indicated in gray; the current is removed from the display and the switch symbol is closed.

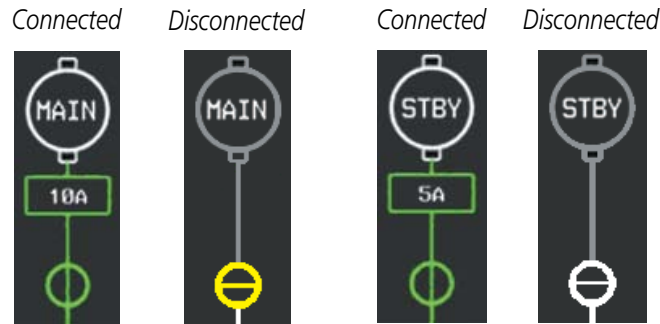

Figure 3-17 Generator Status

GPU status information is removed from the electrical diagram when the GPU door is closed. If the GPU door is open and selected, the GPU status is shown in green; when the door is open, but not selected, the status is shown in gray with the switch closed. A CAS message, ‘GPU DOOR’ is generated if the GPU door is open.

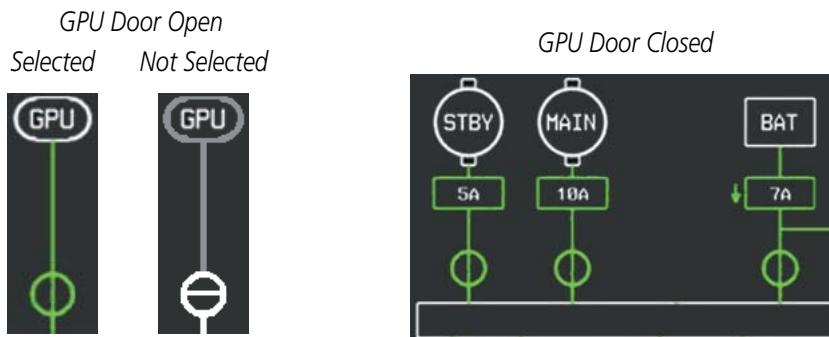

Figure 3-18 GPU Door Status

Battery connection status to the main bus is indicated in green; direction of current flow is indicated with an arrow next to the current readout. If the battery is disconnected from the main bus, the switch is closed. Battery overheating is indicated in red with a ‘BAT OVHT’ annunciation; a CAS message is also generated.

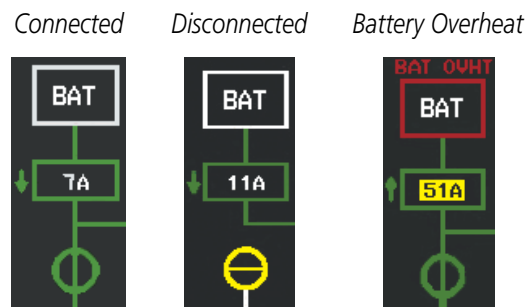

Figure 3-19 Battery Status

Battery and essential bus voltages are displayed using gauges. DC buses are shown in green when energized. When not energized, the connection line to the main bus is removed and the bus label is displayed in red.



Figure 3-20 Battery and Essential Bus Low Voltage

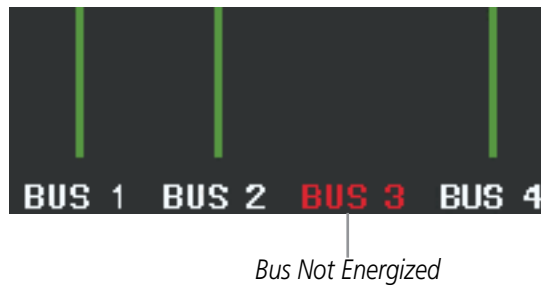

Figure 3-21 DC Bus Status

The Emergency Buses switch has two positions, UP (open) and DN (ground). If the switch is in the UP position, the essential bus is connected to the battery bus. If the switch is in the DN position, the essential bus is connected to the main bus.

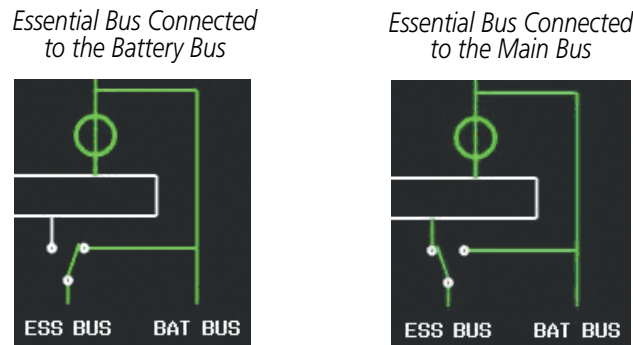

Figure 3-22 Essential Bus Connections

A red “X” over a component indicates invalid data or a failed unit.

FUEL SYSTEM

The Fuel Synoptics Page displays the status of the fuel tanks and feed system. Fuel quantity is depicted graphically; the color changes to yellow if the fuel quantity drops below the threshold level.

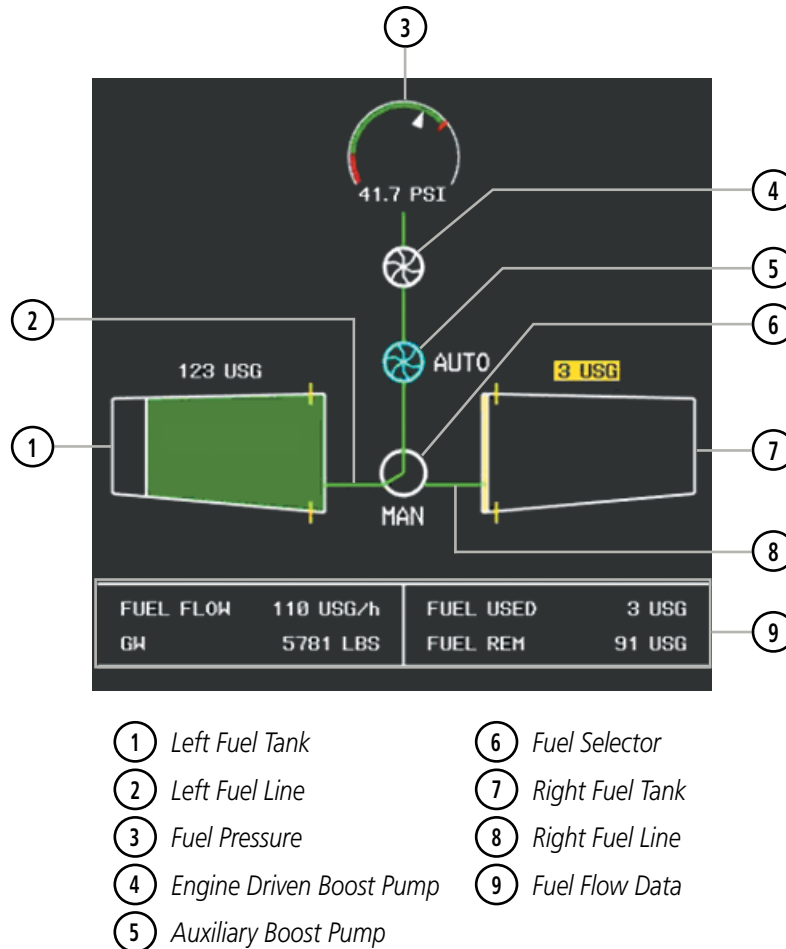

Figure 3-23 Fuel Synoptics Page

Fuel Pressure is displayed using a gauge. If fuel pressure is low the readout is displayed in red.

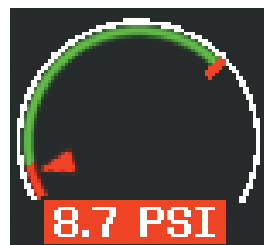

Figure 3-24 Fuel Pressure Low

Status of the fuel selector is indicated between the fuel tank symbols. The mode, automatic (AUTO) or manual (MAN) is shown beneath the fuel selector symbol.

Left Fuel Tank Selected	Switching Fuel Tank Selection	Right Fuel Tank Selected	Manual or Unknown Fuel Tank Selection	Fuel Selector Off
				

Table 3-1 Fuel Selector Status

If the auxiliary fuel boost pump is on, the symbol is displayed in green. The mode, automatic (AUTO) or manual (MAN) is displayed next to the pump symbol. If the boost pump is off, the symbol is shown in light blue (automatic mode) or red (manual mode).



Fuel Boost Pump On	Fuel Boost Pump Off (Auto)	Fuel Boost Pump Off (Manual)
		

Table 3-2 Auxiliary Boost Pump Status

Fuel used and remaining are based on the fuel flow. The aircraft's gross weight (GW) is entered on the AUX - Weight Planning Page (see the Flight Management Section).

FUEL FLOW	110 USG/h	FUEL USED	1 USG
GW	5793 LBS	FUEL REM	93 USG

Figure 3-25 Fuel Flow Data

A red "X" over a component indicated invalid data or a failed unit.

GENERAL SYSTEMS

The General Synoptics Page aircraft diagram displays open doors in red (CAS messages also generated). Statuses of stall sensor, propeller, pitot probes, and windshield heat are also indicated on the diagram:

- White indicates that heat is off (propeller and windshield)
- Light blue indicates heat has been selected (windshield)
- Green indicates heat is on
- Yellow indicates heat has failed (stall sensor, propeller and pitot tube).

Invalid sensor information is indicated with a red 'X'.

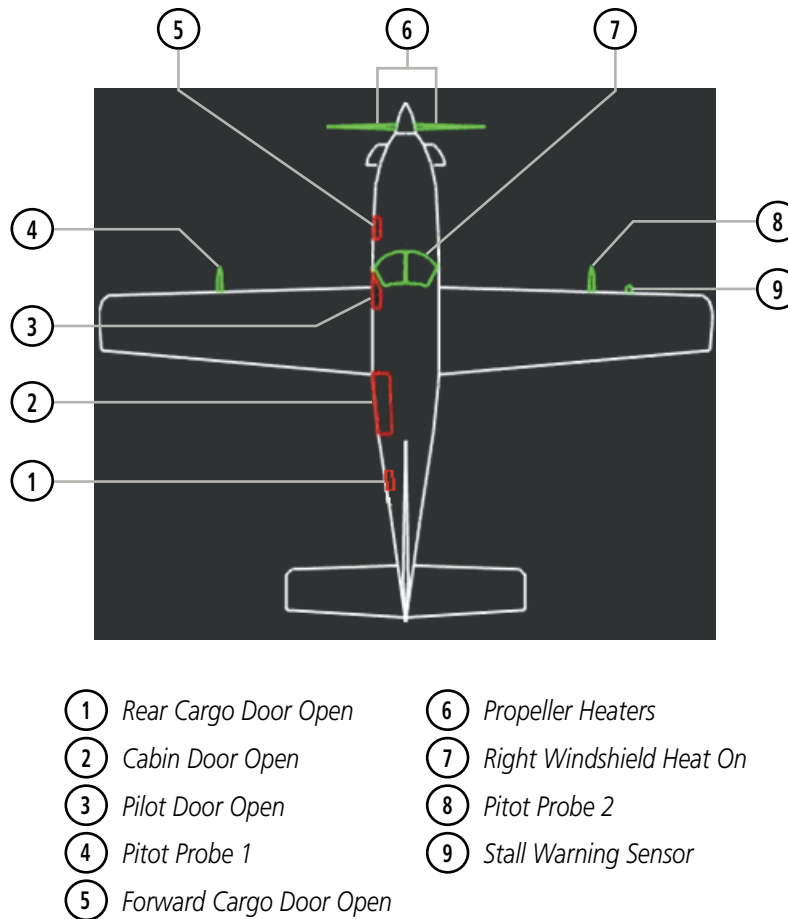

Figure 3-26 General Synoptics Page



Figure 3-27 Windshield Heat Status

3.3 CREW ALERTING SYSTEM (CAS)



NOTE: Refer to the Pilot's Operating Handbook (POH) for emergency procedures.



NOTE: Aural alerts associated with abnormal conditions and advisories are managed through the audio panels. Refer to the Audio Panel and CNS Section for more information.

The Crew Alerting System (CAS) Display is located in the lower left corner of the EICAS Display (on the MFD) under normal display conditions. Up to 14 messages can be displayed; when more than 14 messages accumulate, the scrolling **CAS** softkeys become available.

When CAS messages are present while in Reversionary Mode, the CAS Window appears on the display along with the flight instruments and EIS. The window size increases to fit up to 14 CAS messages; if more than 14 messages are generated, the messages can be scrolled through using the **CAS** softkeys (two left-most softkeys).

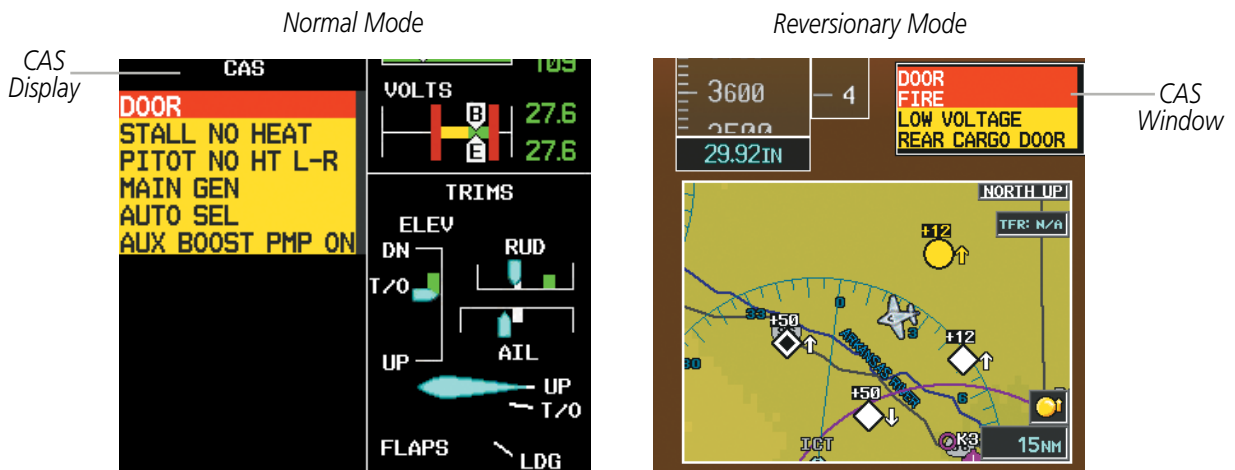

Figure 3-28 CAS Messages

CAS DISPLAY INHIBITS

Inhibits prevent certain CAS messages from being displayed during one or more of the following conditions:

- Engine off
- Engine on
- Aircraft on ground
- Takeoff
- Aircraft in air
- Landing

Takeoff and Landing Operation Phase inhibits (TOPI and LOPI) are implemented to reduce flight crew workload and distractions during takeoff and landing. The following tables list the criteria which must be met to activate or deactivate TOPI or LOPI; only one criterion must be met for activation or deactivation to occur.

Activation	Deactivation
Transitions from on-ground to in-air	Airborne > 25 sec
IAS transitions > 50 knots (on either PFD)	IAS < 40 knots (on either PFD) IAS invalid (on both PFDs)
	Radar altitude (if available) > 400 ft AGL Pressure altitude > 400 ft above field elevation*
	Active > 90 sec

* Pressure altitude captured when the aircraft transitions from on-ground to in-air

Table 3-3 Takeoff Operation Phase Inhibit (TOPI) Activation/Deactivation Criteria

Activation	Deactivation
Transitions from in-air to on-ground	On-ground > 25 sec
	IAS < 40 knots (on either PFD) IAS invalid (on both PFDs)
Radar altitude (if available) transitions < 400 ft AGL GPS altitude transitions < 400 ft above field elevation*	Radar altitude (if available) > 600 ft AGL GPS altitude > 600 ft above field elevation*
	Active > 90 sec

* Stored in terrain database

Table 3-4 Landing Operation Phase Inhibit (LOPI) Activation/Deactivation Criteria

Inhibits affecting each warning and caution message are indicated with an “X” under the corresponding inhibit column in tables 3-5 and 3-6. Alerts affected by an inhibit are not displayed while the inhibit is enabled. If an alert is displayed prior to the activation of an inhibit affecting it, the alert continues to be displayed normally until the condition causing the alert ceases to exist.

If a GEA or GIA fails, all CAS messages depending on sensors associated with that LRU are automatically inhibited. Inhibits cannot be activated by invalid sensor data.

CAS MESSAGES AND PRIORITIZATION



NOTE: Refer to the Pilot's Operating Handbook (POH) for corrective pilot actions.



NOTE: Red warning messages cannot be scrolled through and remain at the top of the CAS display. The scroll bar changes to yellow if more than ten caution messages exist to be scrolled through.

CAS messages are grouped by criticality (warning, caution) and sorted by order of appearance (most recent messages on top). The color of the message is based on its urgency and on required action:

- **Warning** (red) – Immediate crew awareness and action required; Master Warning triggered
- **Caution** (yellow) – Immediate crew awareness and possible future corrective action required; Master Caution triggered

When a new red CAS warning message appears, it flashes (inversely red on white) in conjunction with the Master Warning Indicator. Pressing the Master Warning Indicator acknowledges all flashing red messages, extinguishing the master warning lights, and stops warning message flashing. Once acknowledged, CAS warning messages are shown in red text and are displayed until the issue is corrected.

Messages	Comments	Inhibits					
		ENGINE OFF	ENGINE ON	GROUND	TOPI	AIR	LOPI
BAT OVERHEAT	Battery temperature over 70°C						
BLEED TEMP	Bleed temperature high	X			X		
CABIN ALTITUDE	Cabin altitude over 10,000 ft			X			
CABIN DIFF PRESS	Cabin pressure differential over 6.2 psi	X					
DOOR	Pilot or cabin door open						
FIRE	Engine compartment fire (temperature over 200°C; if installed)						
FLAPS ASYM	Dissymmetry between left- and right-hand flaps						
FUEL OFF	Fuel tank selector set to "Off"						
FUEL PRESS	Fuel pressure below 10 psi						
ITT	Engine start: ITT over 1000°C, 870°C (5 s), or 840°C (20 s) Engine running: ITT over 840°C						
OIL PRESS	Oil pressure below 60 psi						
OXYGEN	Oxygen cylinder closed						
PARK BRAKE	Parking brake applied						
TORQUE	Torque greater than or equal to 121.4% maximum torque						

Table 3-5 Warning CAS Messages

When a new yellow caution message appears on the CAS display, it flashes (inversely black on yellow) in conjunction with the Master Caution Indicator. Pressing the Master Caution Indicator acknowledges all flashing yellow messages, extinguishes the master caution lights, and stops caution message flashing. Messages are displayed until the issue is corrected.

Messages	Comments	Inhibits					
		ENGINE OFF	ENGINE ON	GROUND	TOPI	AIR	LOPI
AUTO SEL	Fuel timer off or out of service				X		
AUX BOOST PMP ON	Electric fuel pump running (manual or automatic mode)						
BAT AMP	Battery current over 50 A while on ground				X	X	X
BAT OFF	Battery off				X		
BLEED OFF	Flow control and shut-off valve/shut-off valve closed	X			X		X
CHIP	Oil chip detector on (if installed)				X		X
FRONT CARGO DOOR	Forward cargo door open				X		
FUEL IMBALANCE	Fuel tanks imbalanced by more than 15 USGAL for > 30 seconds						
FUEL LOW L-R*	Fuel quantity less than or equal to 9.1 USG in specified tank						
GPU DOOR	GPU receptacle door not closed				X		X
IGNITION	Ignition exciter running						
INERT SEP FAIL	Inertial separator failure	X			X		
INERT SEP ON	Inertial separator extended						
LOW LVL FAIL L-R*	Low fuel level sensor failure for specified tank						
LOW VOLTAGE	Battery voltage below 26 V				X		X
MAIN GEN	Starter generator unconnected	X			X		
NG HI	Generator speed is more than 103%						
OIL PRESS	Oil pressure between 60 and 100 psi	X					
OIL TEMP	Oil temperature below 0°C or above 104°C				X		
PITOT HEAT ON L-R*	Specified pitot heat (left or right) on while engine off		X				
PITOT NO HT L-R*	Specified pitot heat (left or right) off	X					
PROP DEICE FAIL	Prop deice selected and not on	X			X		
PROP DEICE ON	Prop deice on while engine off		X				
REAR CARGO DOOR	Rear cargo door open				X		
STALL HEAT ON	Stall warning heat on while engine off		X				
STALL NO HEAT	Stall warning heat off	X					
STARTER	Starter generator running						
VACUUM LOW	Vacuum pressure less than 3.75 in Hg	X			X		

* Only affected side (L, R, or L-R) displayed in CAS message; applicable messages listed here display L-R for example

Table 3-6 Caution CAS Messages

SECTION 4 AUDIO PANEL AND CNS

4.1 OVERVIEW

The Communication/Navigation/Surveillance (CNS) system includes the Audio Panels, communication radios, navigation radios, and Mode S transponders. The System Overview Section provides a block diagram description of the Audio Panels and CNS system interconnection.

CNS operation in the TBM 850 is performed by the following Line Replacement Units (LRUs):

- Primary Flight Display (PFD) (2)
- Multi Function Display (MFD)
- Integrated Avionics Unit (2)
- Audio Panel (2)
- Mode S Transponder (2)
- MFD Control Unit

The PFD controls are used to tune the communication transceivers and navigation radios.

The two Audio Panels provide the traditional audio selector functions of microphone and receiver audio selection. Each Audio Panel includes an intercom system (ICS) between the pilot, copilot, and passengers, a marker beacon receiver, and a COM clearance recorder. Ambient noise from the aircraft radios is reduced by a feature called Master Avionics Squelch (MASQ). When no audio is detected, MASQ processing further reduces the amount of background noise from the radios.

The Mode S Transponders are controlled with softkeys and the **FMS** Knob located on the Primary Flight Display (PFD). The Transponder Data Box is located to the left of the System Time Box. The data box displays the active four-digit code, mode, and a reply status (Figure 4-1).

AUDIO PANEL VOLUME CONTROL

Adjusting the master volume control affects all radio audio volume and airframe type warnings that are heard in the headsets (not the speaker) for the pilot or copilot side Audio Panel. Radio adjustments made on the PFD controls to compensate for the master volume change on the Audio Panel also affect the radio levels for the other pilot. Independent radio volume adjustments made using the Audio Panel Master Volume controls affect only the audio heard in the corresponding crew position headset.

Radio volume adjustments may be overridden by each crew position independently using the master volume control on the Audio Panel for the respective crew position. In addition, the master volume control for each Audio Panel affects all other system audio output to its designated crew position headset much like volume adjustments found on many aviation headsets.

PFD CONTROLS AND FREQUENCY DISPLAY



Figure 4-1 PFD Controls, COM/NAV Frequency Tuning Boxes, and ADF/DME Tuning Window

- ① **NAV VOL/ID Knob** – Controls NAV audio volume level. Press to turn the Morse code identifier audio on and off. Volume level is shown in the NAV frequency field as a percentage.
- ② **NAV Frequency Transfer Key** – Transfers the standby and active NAV frequencies.
- ③ **NAV Knob** – Tunes the standby frequencies for the NAV receiver (large knob for MHz; small knob for kHz). Press to move the tuning box (light blue box) and Frequency Transfer Arrow between NAV1 and NAV2.
- ④ **NAV Frequency Box** – Displays NAV standby and active frequency fields, volume, and station ID. The frequency of the NAV radio selected for navigation is displayed in green.
- ⑤ **COM Frequency Box** – Displays COM standby and active frequency fields and volume. The selected COM transceiver frequency is displayed in green.
- ⑥ **COM Knob** – Tunes the standby frequencies for the COM transceiver (large knob for MHz; small knob for kHz). Press to move the tuning box (light blue box) and Frequency Transfer Arrow between COM1 and COM2.
- ⑦ **COM Frequency Transfer Key** – Transfers the standby and active COM frequencies. Press and hold this key for two seconds to tune the emergency frequency (121.500 MHz) automatically into the active frequency field.
- ⑧ **COM VOL/SQ Knob** – Controls COM audio volume level. Press to turn the COM automatic squelch on and off. Volume level is shown in the COM frequency field as a percentage.
- ⑨ **ADF/DME Tuning Window** – Displays ADF frequencies, volume setting, and modes, and DME tuning selection. Display by pressing the **ADF/DME** Softkey.
- ⑩ **ENT Key** – Validates or confirms an ADF frequency or ADF/DME mode and Auto-tune selection.
- ⑪ **FMS Knob** – Flight Management System Knob, used to enter ADF frequencies and select ADF/DME modes, enter transponder codes, and Auto-tune entries when ADF/DME Tuning Window or NRST Window is present. Press the **FMS** Knob to turn the selection cursor on and off. The large knob moves the cursor in the window. The small knob selects individual characters for the highlighted cursor location.
- ⑫ **Transponder Data Box** – Indicates the selected transponder code, operating mode, reply, and ident status for the applicable transponder.

AUDIO PANEL CONTROLS

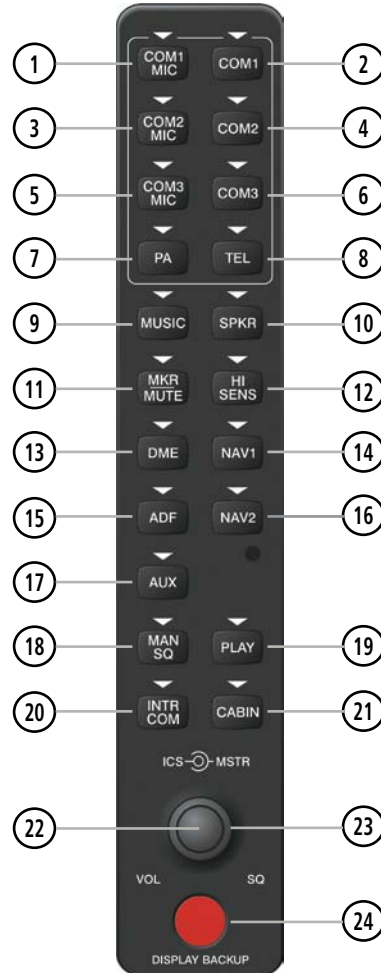

Figure 4-2 Audio Panel Controls





NOTE: When a key is selected, a triangular annunciator above the key is illuminated.

- ① **COM1 MIC** – Selects the #1 transmitter for transmitting. COM1 receive is simultaneously selected when this key is pressed allowing received audio from the #1 COM receiver to be heard. COM2 receive can be added by pressing the **COM2** Key.
- ② **COM1** – When selected, audio from the #1 COM receiver can be heard.
- ③ **COM2 MIC** – Selects the #2 transmitter for transmitting. COM2 receive is simultaneously selected when this key is pressed allowing received audio from the #2 COM receiver to be heard. COM1 receive can be added by pressing the **COM1** Key.
- ④ **COM2** – When selected, audio from the #2 COM receiver can be heard.
- ⑤ **COM3 MIC** – Not used in the TBM 850.

- ⑥ **COM3** – Not used in the TBM 850.
- ⑦ **PA** – Selects the passenger address system. The selected COM transmitter is deselected when the **PA** Key is pressed.
- ⑧ **TEL** – Not used in the TBM 850.
- ⑨ **MUSIC** – Toggles the Music 1 input on or off. Pressing and holding toggles music muting on or off.
- ⑩ **SPKR** – Selects and deselects the on-side flight deck speaker. COM and NAV receiver audio can be heard on the speaker.
- ⑪ **MKR/MUTE** – Selects marker beacon receiver audio. Mutes the currently received marker beacon receiver audio. Unmutes automatically when new marker beacon audio is received.
- ⑫ **HI SENS** – Press to increase marker beacon receiver sensitivity. Press again to return to low sensitivity.
- ⑬ **DME** – Turns optional DME audio on or off.
- ⑭ **NAV1** – When selected, audio from the #1 NAV receiver can be heard.
- ⑮ **ADF** – Turns optional ADF receiver audio on or off.
- ⑯ **NAV2** – When selected, audio from the #2 NAV receiver can be heard.
- ⑰ **AUX** – Not used in the TBM 850.
- ⑱ **MAN SQ** – Enables manual squelch for the intercom. When the intercom is active, press the **ICS** Knob to illuminate SQ. Turn the **ICS** Knob to adjust squelch.
- ⑲ **PLAY** – Press once to play the last recorded COM audio. Press again to stop playing. Press twice within 0.5 second while audio is playing and the previous block of recorded audio is played. Each subsequent two presses within 0.5 second plays each previously recorded block.
- ⑳ **INTR COM** – Selects and deselects the pilot/copilot intercom on both Audio Panels.
- ㉑ **CABIN** – Initiates intercom communications with passengers in the cabin.
- ㉒ **ICS Knob** – Turn to adjust intercom volume or squelch. Press to switch between volume and squelch control as indicated by illumination of VOL or SQ. The **MAN SQ** Key must be selected to allow squelch adjustment.
- ㉓ **MSTR Knob** – The Master Volume Control adjusts volume for the blended NAV, COM, intercom audio, and alert warnings.
- ㉔ **DISPLAY BACKUP Button** – Manually selects Reversionary Mode.

4.2 COM OPERATION

COM TRANSCIVER SELECTION AND ACTIVATION

- 
NOTE: During PA Mode, the COM MIC Annunciator is extinguished and the COM active frequency color changes to white, indicating that neither COM transmitter is active.
- 
NOTE: When turning on the G1000 for use, the system remembers the last frequencies used and the active COM transceiver state prior to shutdown.

The COM Frequency Box is composed of four fields; the two active frequencies are on the left side and the two standby frequencies are on the right. The COM transceiver is selected for transmitting by pressing the **COM MIC** Keys on the Audio Panel. During reception of audio from the COM radio selected for transmission, audio from the other COM radio is muted.

An active COM frequency displayed in green indicates that the COM transceiver is selected on the Audio Panel (**COM1 MIC** or **COM2 MIC** Key). Both active COM frequencies appearing in white indicate that no COM radio is selected for transmitting (**PA** Key is selected on the Audio Panel).

Frequencies in the standby field are displayed in either white or gray. The standby frequency in the tuning box is white. The other standby frequency is gray.

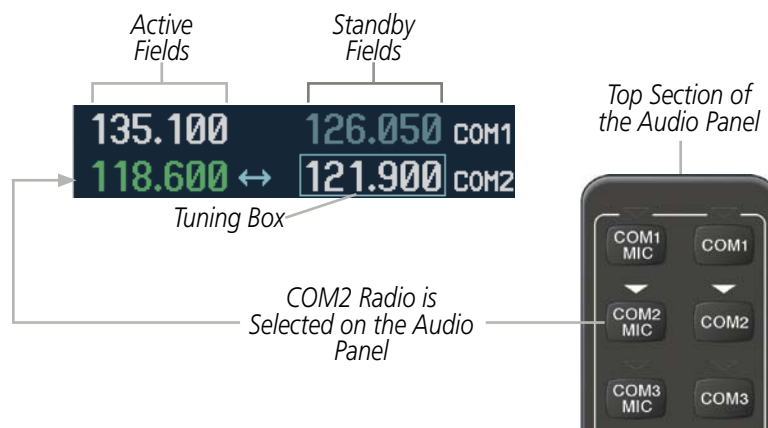

Figure 4-3 Selecting a COM Radio for Transmit

TRANSMIT/RECEIVE INDICATIONS

During COM transmission, a white TX appears by the active COM frequency replacing the Frequency Transfer Arrow. On the Audio Panel, when the active COM is transmitting, the active transceiver **COM MIC** Key Annunciator flashes approximately once per second.

During COM signal reception, a white RX appears by the active COM frequency replacing the Frequency Transfer Arrow.



Figure 4-4 COM Radio Transmit and Receive Indications

When the same COM radio is selected on both Audio Panels, the pilot has transmit priority on COM1, the copilot has transmit priority on COM2.

COM TRANSCEIVER MANUAL TUNING

The COM frequency controls and frequency boxes are on the right side of each PFD.

Manually tuning a COM frequency:

- 1) Turn the **COM** Knob to tune the desired frequency in the COM Tuning Box (large knob for MHz; small knob for kHz).
- 2) Press the **Frequency Transfer** Key to transfer the frequency to the active field.
- 3) Adjust the volume level with the COM **VOL/SQ** Knob.
- 4) Press the COM **VOL/SQ** Knob to turn automatic squelch on and off.



Figure 4-5 COM Frequency Tuning

SELECTING THE RADIO TO BE TUNED

Press the small **COM** Knob to transfer the frequency tuning box and Frequency Transfer Arrow between the upper and lower radio frequency fields.

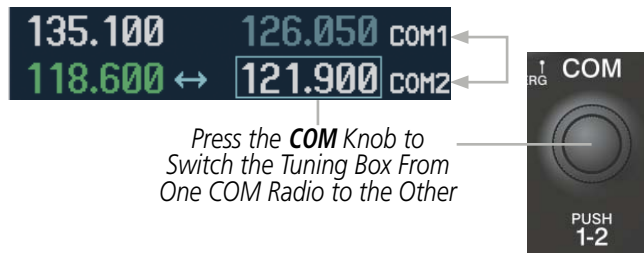

Figure 4-6 Switching COM Tuning Boxes

QUICK-TUNING AND ACTIVATING 121.500 MHZ

Pressing and holding the COM **Frequency Transfer** Key for two seconds automatically loads the emergency COM frequency (121.500 MHz) in the active field of the COM radio selected for tuning (the one with the transfer arrow). In the example shown, pressing the Audio Panel **COM2 MIC** Key activates the transceiver.

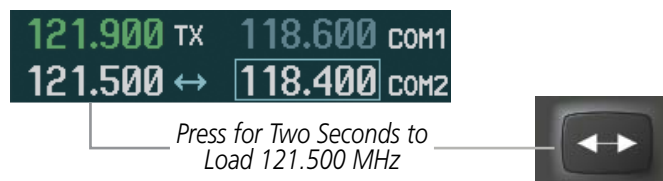

Figure 4-7 Quickly Tuning 121.500 MHz

AUTO-TUNING THE COM FREQUENCY

COM frequencies can be automatically tuned from the following:

- Nearest Airports Window (PFD)
- WPT – Airport Information Page
- NRST – Nearest Airports Page
- NRST – Nearest Frequencies Page (ARTCC, FSS, WX)
- NRST – Nearest Airspaces Page

AUTO-TUNING FROM THE PFD

COM frequencies for the nearest airports can be automatically tuned from the Nearest Airports Window on the PFD. When the desired frequency is entered, it becomes a standby frequency. Pressing the **Frequency Transfer** Key places this frequency into the COM Active Frequency Field.

Auto-tuning a COM frequency for a nearby airport from the PFD:

- 1) Press the **NRST** Softkey on the PFD to open the Nearest Airports Window. A list of 25 nearest airport identifiers and COM frequencies is displayed.
- 2) Turn the **FMS** Knob to scroll through the list and highlight the desired COM frequency.
- 3) Press the **ENT** Key to load the COM frequency into the COM Standby Tuning Box.
- 4) Press the **Frequency Transfer** Key to transfer the frequency to the COM Active Frequency Field.



Select the **NRST** Softkey to Open the Nearest Airports Window

Figure 4-8 Nearest Airports Window (PFD)

AUTO-TUNING FROM THE MFD

Frequencies can be automatically loaded into the COM Frequency Box from pages in the NRST or WPT page group by highlighting the frequency and pressing the **ENT** Key (Figures 4-9, 4-10, and 4-11).

Auto-tuning a COM frequency from the WPT and NRST Pages:

- 1) From any page that the COM frequency can be auto-tuned, activate the cursor by pressing the **FMS** Knob on the MFD control unit or selecting the appropriate softkey.
- 2) Turn the **FMS** Knob to place the cursor on the desired COM frequency (Figure 4-11).
- 3) Press the **ENT** Key to load the COM frequency into the standby field of the selected COM radio.
- 4) Press the **Frequency Transfer** Key on either PFD to transfer the frequency to the COM Active Frequency Field.

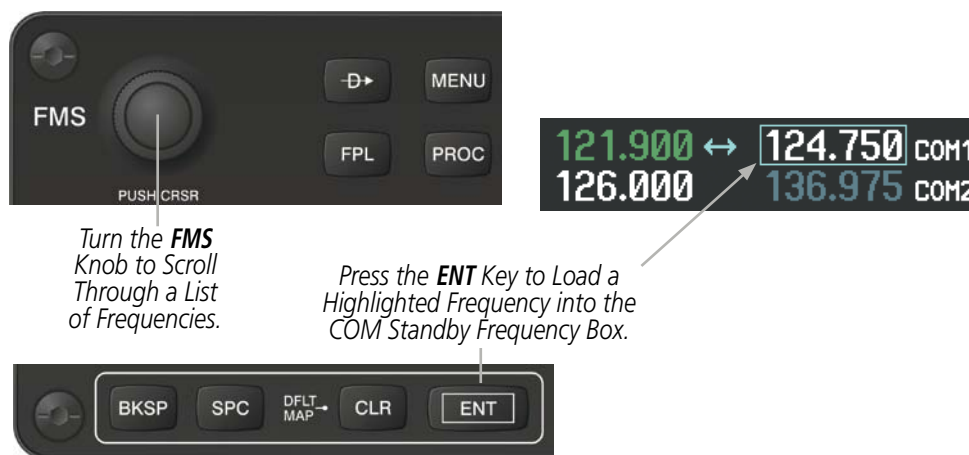

Figure 4-9 Frequency Auto-Tuning from the MFD

Or:

- 1) On the Nearest Airports, Frequencies, or Airspaces page, press the **MENU** Key on the MFD control unit to display the page menu.
- 2) Turn the large **FMS** Knob to scroll through the menu options.
- 3) Press the **ENT** Key to place the cursor on the desired selection.
- 4) Scroll through the frequency selections with the **FMS** Knob.
- 5) Press the **ENT** Key to load the COM frequency into the standby field of the selected COM radio.
- 6) Press the **Frequency Transfer** Key to transfer the frequency to the COM Active Frequency Field.

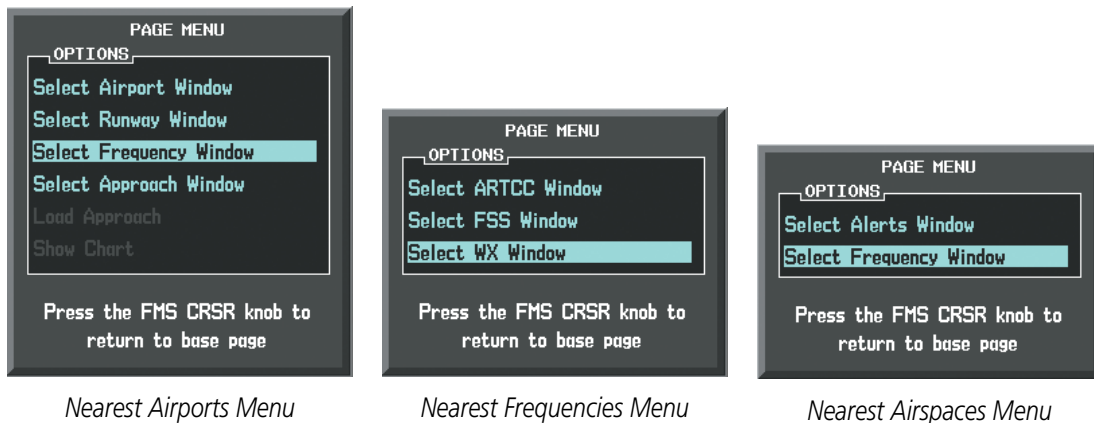

Figure 4-10 Nearest Pages Menus

On the WPT - Airport Information Page, the cursor can be placed on the frequency field by pressing the **FMS** Knob and scrolling through the list. The frequency is transferred to the COM Standby Field with the **ENT** Key.



Selected Airport Identifier and Information

Runway Information

Press **ENT** Key to load frequency into PFD1 COM Standby Field. Cursor then advances to the next frequency.

Select **INFO-x** Softkey for AIRPORT, RUNWAYS, and FREQUENCIES Windows

Figure 4-11 WPT – Airport Information Page

COM frequencies can also be auto-tuned from the NRST – Nearest Airspaces, NRST – Nearest Frequencies, and NRST – Nearest Airports Pages on the MFD in a similar manner using the appropriate softkeys or **MENU** Key, the **FMS** Knob, and the **ENT** Key.



Figure 4-12 NRST – Nearest Airspaces, NRST – Nearest Airports, and NRST – Nearest Frequencies Pages

FREQUENCY SPACING

The G1000 COM radios can tune either 25-kHz spacing (118.000 to 136.975 MHz) or 8.33-kHz spacing (118.000 to 136.990 MHz) for 760-channel or 3040-channel configuration. When 8.33-kHz channel spacing is selected, all of the 25-kHz channel spacing frequencies are also available in the complete 3040-channel list. Variable rate tuning is provided with 8.33-kHz spacing to achieve faster selection of the decimal digits.

COM channel spacing is set on the System Setup Page of the AUX Page Group.



Figure 4-13 COM Channel Spacing

Changing COM frequency channel spacing:

- 1) Select the AUX – System Setup Page.
- 2) Press the **FMS** Knob to activate the flashing cursor.
- 3) Turn the large **FMS** Knob to highlight the Channel Spacing Field in the COM Configuration Box.
- 4) Turn the small **FMS** Knob to select the desired channel spacing.
- 5) Press the **ENT** Key to complete the channel spacing selection.

While the COM CONFIG Window is selected, the G1000 softkeys are blank.



Figure 4-14 AUX – System Setup Page

AUTOMATIC SQUELCH

Automatic Squelch quiets unwanted static noise when no audio signal is received, while still providing good sensitivity to weak COM signals. To disable Automatic Squelch, press the **VOL/SQ** Knob. When Automatic Squelch is disabled, COM audio reception is always on. Continuous static noise is heard over the headsets and speaker, if selected. Pressing the **VOL/SQ** Knob again enables Automatic Squelch.

When Automatic Squelch is disabled, a white SQ appears next to the COM frequency.

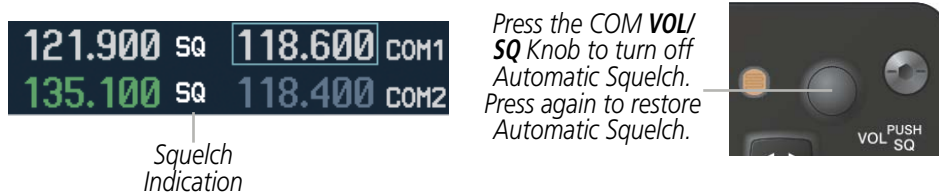

Figure 4-15 Overriding Automatic Squelch

VOLUME

COM radio volume level can be adjusted from 0 to 100% using the **VOL/SQ** Knob. Turning the knob clockwise increases volume, turning the knob counterclockwise decreases volume. When adjusting volume, the level is displayed in place of the standby frequencies. Volume level indication remains for two seconds after the change.



Figure 4-16 COM Volume Level

4.3 NAV OPERATION

NAV RADIO SELECTION AND ACTIVATION

The NAV Frequency Box is composed of four fields; two standby fields and two active fields. The active frequencies are on the right side and the standby frequencies are on the left.

A NAV radio is selected for navigation by pressing the **CDI** Softkey located on the PFD. The active NAV frequency selected for navigation is displayed in green. Pressing the **CDI** Softkey once selects NAV1 as the navigation radio. Pressing the **CDI** Softkey a second time selects NAV2 as the navigation radio. Pressing the **CDI** Softkey a third time activates GPS mode. Pressing the **CDI** Softkey again cycles back to NAV1.

While cycling through the **CDI** Softkey selections, the NAV Tuning Box and the Frequency Transfer Arrow are placed in the active NAV Frequency Field and the active NAV frequency color changes to green.

The three navigation modes that can be cycled through are:

- VOR1 (or LOC1) – If NAV1 is selected, a green single line arrow (not shown) labeled either VOR1 or LOC1 is displayed on the HSI and the active NAV1 frequency is displayed in green.
- VOR2 (or LOC2) – If NAV2 is selected, a green double line arrow (shown) labeled either VOR2 or LOC2 is displayed on the HSI and the active NAV2 frequency is displayed in green.
- GPS – If GPS Mode is selected, a magenta single line arrow (not shown) appears on the HSI and neither NAV radio is selected. Both active NAV frequencies are then displayed in white.

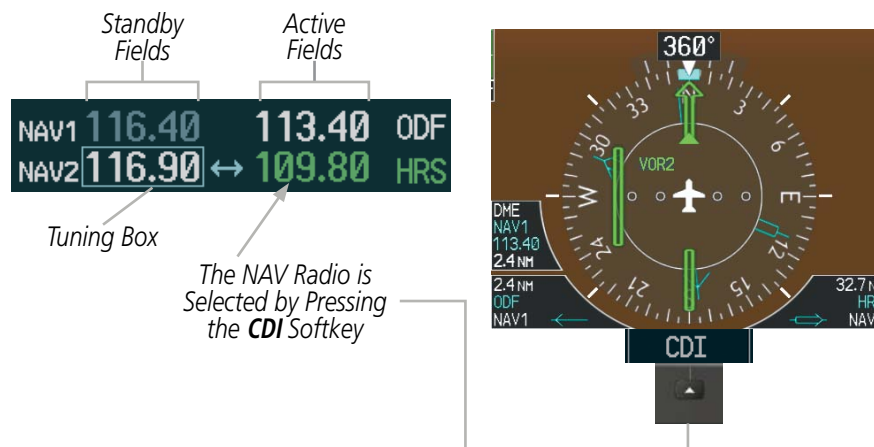

Figure 4-17 Selecting a NAV Radio for Navigation

See the Flight Instruments Section for selecting the DME and Bearing Information windows and using VOR or ADF as the source for the bearing pointer.

NAV radios are selected for listening by pressing the corresponding keys on the Audio Panel. Pressing the **NAV1**, **NAV2**, **ADF**, or **DME** Key selects and deselects the navigation radio source. Selected audio can be heard over the headset and the speakers (if selected). All radios can be selected individually or simultaneously.



Figure 4-18 Selecting a NAV Radio Receiver

NAV RECEIVER MANUAL TUNING

The NAV frequency controls and frequency boxes are on the left side of the PFDs.

Manually tuning a NAV frequency:

- 1) Turn the **NAV** Knob to tune the desired frequency in the NAV Tuning Box.
- 2) Press the **Frequency Transfer** Key to transfer the frequency to the NAV Active Frequency Field.
- 3) Adjust the volume level with the NAV **VOL/ID** Knob.
- 4) Press the NAV **VOL/ID** Knob to turn the Morse code identifier audio on and off.

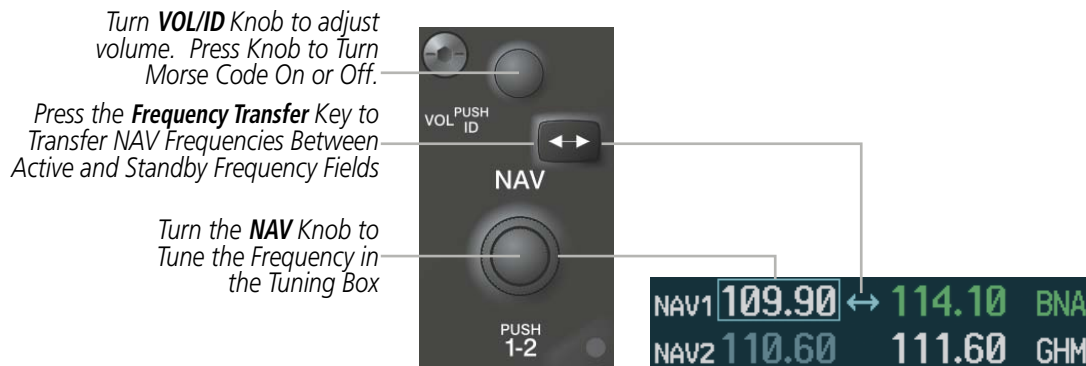

Figure 4-19 NAV Frequency Tuning

SELECTING THE RADIO TO BE TUNED

Press the small **NAV** Knob to transfer the frequency tuning box and Frequency Transfer Arrow between the upper and lower radio frequency fields.

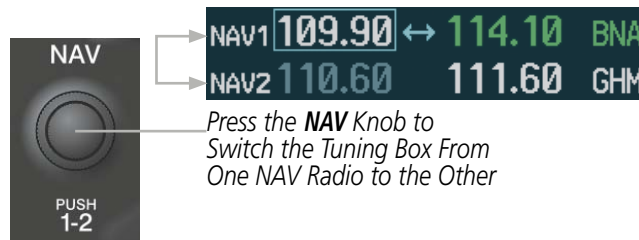

Figure 4-20 Switching NAV Tuning Boxes

VOR/LOC ID

When the Morse code Identifier audio is on for a NAV radio, a white ID appears to the left of the active NAV frequency.

In the example shown, in order to listen to either station identifier, press the **NAV1** or **NAV2** Key on the Audio Panel. Pressing the **VOL/ID** Knob turns off the Morse code audio only in the radio with the NAV Tuning Box. To turn off both NAV IDs, transfer the NAV Tuning Box between NAV1 and NAV2 by pressing the small **NAV** Knob and pressing the **VOL/ID** Knob again to turn the Morse code off in the other radio.



Figure 4-21 NAV Radio ID Indication

VOLUME

NAV Radio volume level can be adjusted from 0 to 100% using the **VOL/ID** Knob. Turning the knob clockwise increases volume, counterclockwise decreases volume.

When adjusting, the level is displayed in place of the standby frequencies. Volume level indication remains for two seconds after the change.



Figure 4-22 NAV Volume Levels

AUTO-TUNING A NAV FREQUENCY FROM THE MFD

NAV frequencies can be selected and loaded from the following MFD pages:

- WPT – Airport Information
- WPT – VOR Information
- NRST – Nearest Airports
- NRST – Nearest VOR
- NRST – Nearest Frequencies (FSS, WX)
- NRST – Nearest Airspaces

The MFD provides auto-tuning of NAV frequencies from waypoint and nearest pages. During enroute navigation, the NAV frequency is entered automatically into the NAV standby frequency field. During approach activation the NAV frequency is entered automatically into the NAV active frequency field.

Frequencies can be automatically loaded into the NAV Frequency Box from pages in the NRST or WPT page group by highlighting the frequency and pressing the **ENT** Key (Figures 4-23, 4-24, and 4-25).

Auto-tuning a NAV frequency from the WPT and NRST Pages:

- 1) From any page that the NAV frequency can be auto-tuned, activate the cursor by pressing the **FMS** Knob on the MFD control unit or selecting the appropriate softkey.
- 2) Turn the **FMS** Knob to place the cursor on the desired NAV identifier or NAV frequency.
- 3) On the Nearest VOR, Nearest Airspaces, and Nearest Airports pages, select the **FREQ** Softkey to place the cursor on the NAV frequency (Figure 4-25).
- 4) Press the **ENT** Key to load the NAV frequency into the standby field of the selected NAV radio.
- 5) Press the **Frequency Transfer** Key to transfer the frequency to the NAV Active Frequency Field.

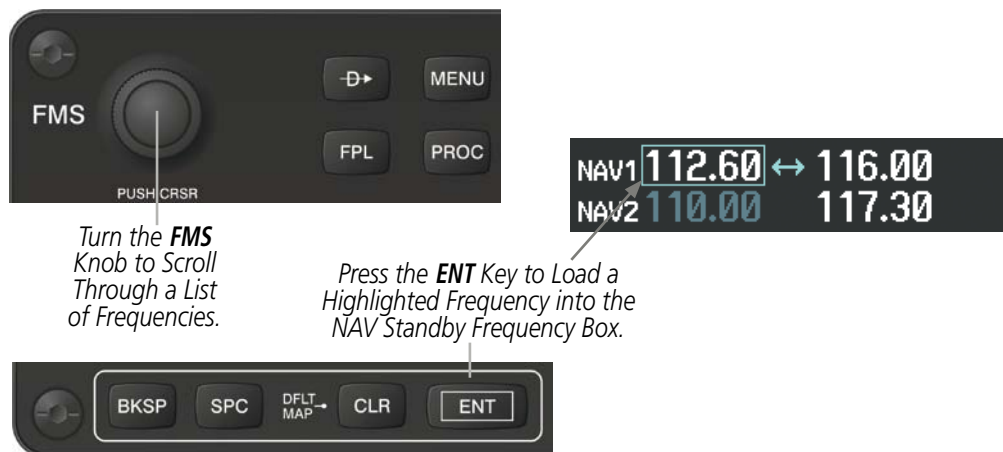

Figure 4-23 NAV Frequency Auto-Tuning from the MFD

Or:

- 1) When on the NRST pages, press the **MENU** Key on the MFD control unit to display the page menu.
- 2) Turn the large **FMS** Knob to scroll through the menu options.
- 3) Press the **ENT** Key to place the cursor in the desired window.
- 4) Scroll through the frequency selections with the **FMS** Knob.
- 5) Press the **ENT** Key to load the NAV frequency into the standby field of the selected NAV radio.
- 6) Press the **Frequency Transfer** Key to transfer the frequency to the NAV Active Frequency Field.

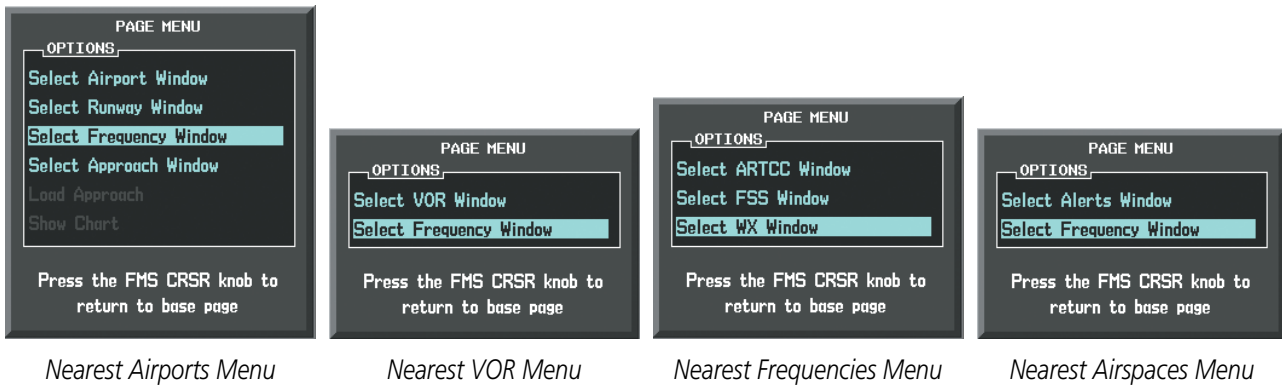
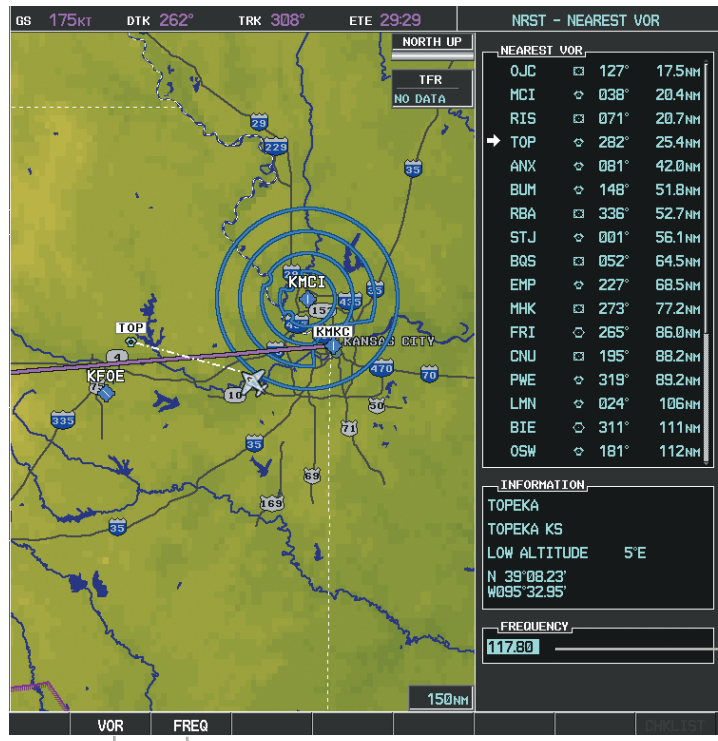

Figure 4-24 Nearest Pages Menus

In the example shown, the VOR list is selected with the **VOR** Softkey or from the page menu. The **FMS** Knob or **ENT** Key is used to scroll through the list. The cursor is placed on the frequency with the **FREQ** Softkey and loaded into the NAV Tuning Box with the **ENT** Key.



Press the **ENT** Key to Load the Frequency into the NAV Standby Field.

Select the **VOR** Softkey to Place the Cursor on the VOR Identifier

Select the **FREQ** Softkey to Place the Cursor on the VOR Frequency

Figure 4-25 Loading the NAV Frequency from the NRST – Nearest VOR Page

While enroute, NAV frequencies can also be auto-tuned from the NRST – Nearest Airports, WPT – Airport Information, WPT – VOR Information, and NRST – Nearest Frequencies Pages on the MFD in a similar manner using the appropriate softkeys or **MENU** Key, the **FMS** Knob, and the **ENT** Key.

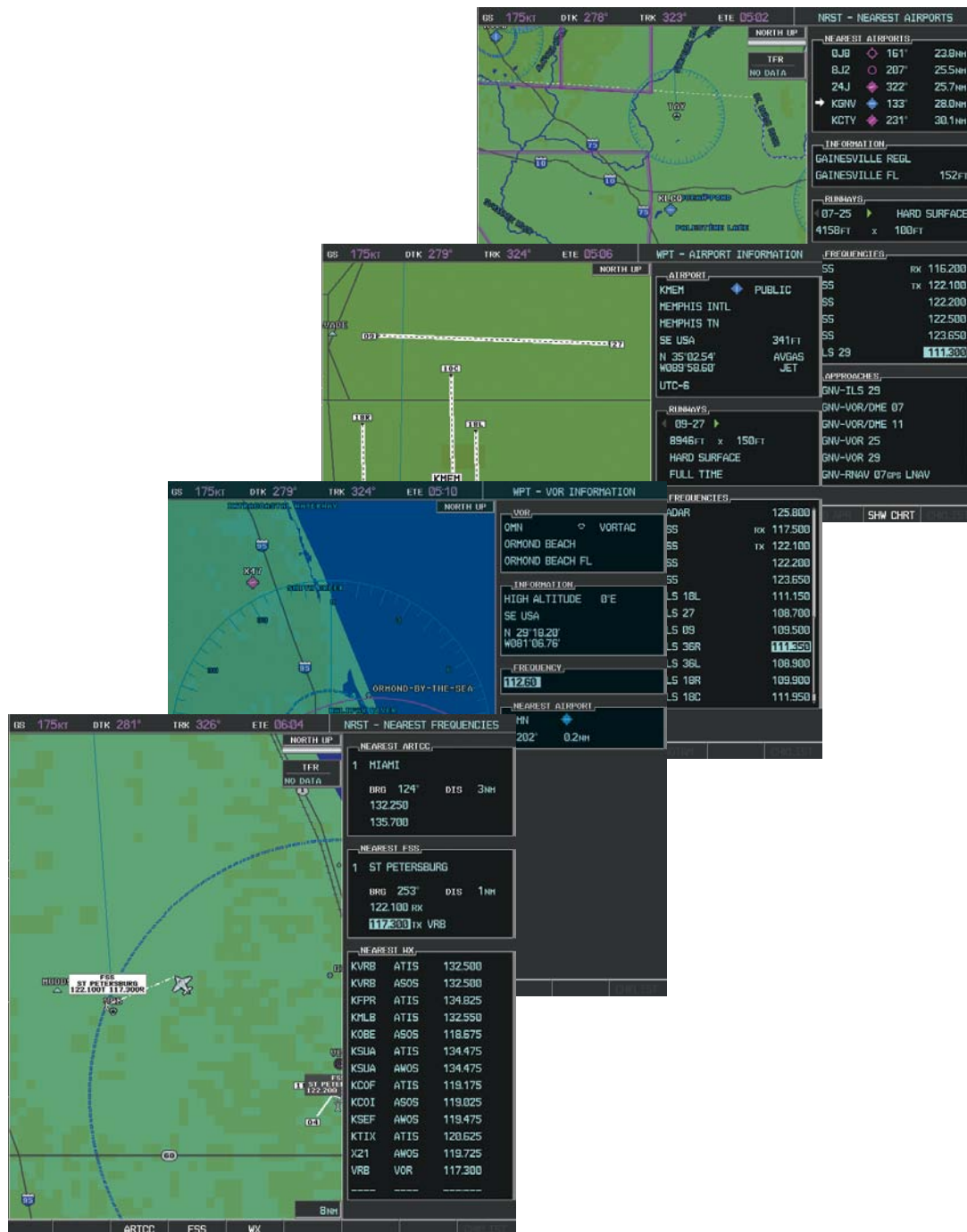

Figure 4-26 NRST – Nearest Frequencies, WPT – VOR Information, WPT – Airport Information, and NRST – Nearest Airports Pages

AUTO-TUNING NAV FREQUENCIES ON APPROACH ACTIVATION



NOTE: *The primary NAV frequency is auto-tuned upon loading a VOR or ILS/Localizer approach.*



NOTE: *When an ILS/LOC approach has been activated in GPS Mode, the system switches to NAV Mode as the final approach course is intercepted (within 15 nm of the FAF). See the Flight Management Section for details.*

NAV frequencies are automatically loaded into the NAV Frequency Box on approach activation, on both PFD1 and PFD2.

When loading or activating a VOR or ILS/LOC approach, the approach frequency is automatically transferred to a NAV frequency field as follows:

- If the current CDI navigation source is GPS, the approach frequency is transferred to the NAV1 or NAV2 active frequency fields. The frequency that was previously in the NAV1 or NAV2 active frequency fields are transferred to standby.
- If the current CDI navigation source is GPS, and if the approach frequency is already loaded into the NAV1 or NAV2 standby frequency field, the standby frequency is transferred to active.
- If the current CDI navigation source is NAV1 or NAV2, the approach frequency is transferred to the standby frequency fields of the selected CDI NAV radio.

MARKER BEACON RECEIVER



NOTE: The marker beacon indicators operate independently of marker beacon audio and cannot be turned off.

The marker beacon receiver is used as part of the ILS. The marker beacon receiver is always on and detects any marker beacon signals within the reception range of the aircraft.

The receiver detects the three marker tones – outer, middle, and inner – and provides the marker beacon annunciations located to the left of the Altimeter on the PFD.

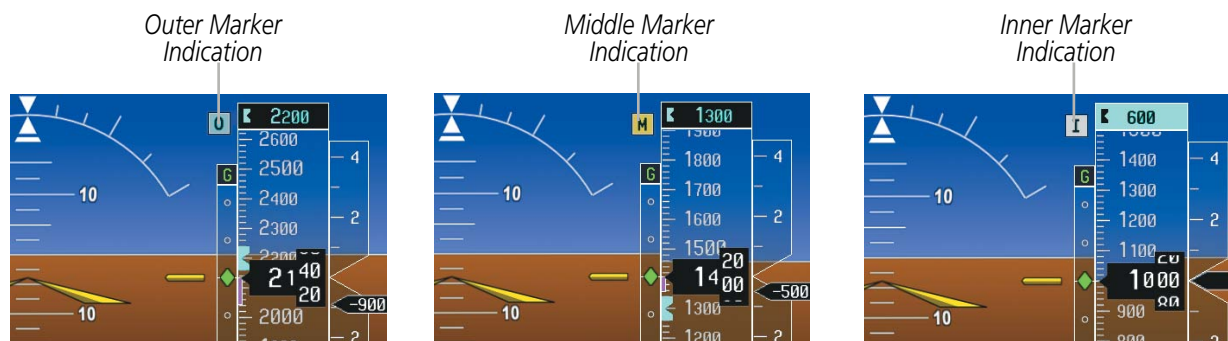

Figure 4-27 Marker Beacon Annunciations on the PFD



Figure 4-28 Marker Beacon Keys

The Audio Panels provide three different states of marker beacon operation; On, Muted, and Deselected. Pressing the **MKR/MUTE** Key selects and deselected marker beacon audio. The key annunciator indicates when marker beacon audio is selected.

During marker beacon audio reception, pressing the **MKR/MUTE** Key mutes the audio but does not affect the marker annunciations (Figure 4-27). The marker tone is silenced, then waits for the next marker tone. The **MKR/MUTE** Key Annunciator is illuminated, indicating audio muting. The audio returns when the next marker beacon signal is received. If the **MKR/MUTE** Key is pressed during signal reception (O, M, I indication) while marker beacon audio is muted, the audio is deselected and the **MKR/MUTE** Key Annunciator is extinguished.

Pressing the **HI SENS** Key switches between high and low marker beacon receiver sensitivity. The HI SENS function (annunciator illuminated) is used to provide an earlier indication when nearing a marker during an approach. The LO SENS function (annunciator extinguished) results in a narrower marker dwell while over a station.

ADF/DME TUNING

NOTE: When another auxiliary window is turned on, the ADF/DME Tuning Window is replaced on the PFD.

See the Flight Instruments Section for displaying the DME and bearing information windows (ADF) and using the ADF as the source for the bearing pointer.

The G1000 system tunes the ADF receiver (optional) and DME transceiver (optional). The ADF is tuned by entering the frequency in the ADF standby frequency field of the ADF/DME Tuning Window. (The softkey may be labeled **ADF/DME**, **ADF**, or **DME**, depending on installed equipment.)

The UHF DME frequency is tuned by pairing with a VHF NAV frequency. DME frequency pairing is automatic and only the VHF NAV frequency is shown.

The following ADF/DME information is displayed in the ADF/DME Tuning Window:

- Active and standby ADF frequencies
- ADF receiver mode
- ADF receiver volume
- DME tuning mode (DME transceiver pairing)

When the ADF/DME Tuning Window is displayed, the selection cursor is placed over the standby ADF frequency field.

Turning the large **FMS** Knob moves the selection cursor through the various fields (standby ADF frequency, ADF receiver mode, ADF radio volume, and DME tuning mode). Pressing the **FMS** Knob activates/deactivates the selection cursor in the ADF/DME Tuning Window. The ADF frequency is entered using the **FMS** Knob and the **ENT** Key.

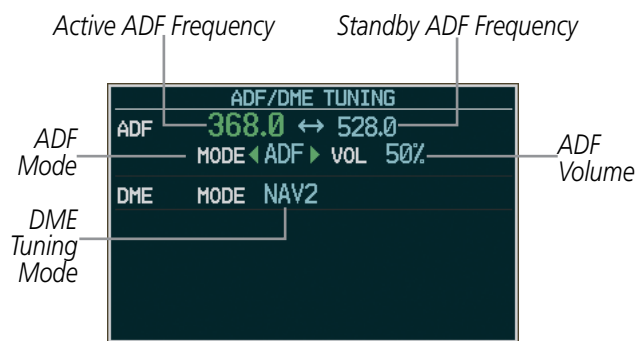

Figure 4-29 ADF/DME Tuning Window

ADF TUNING

ADF frequencies in the 190.0-kHz to 1799.5-kHz range are entered in the standby ADF frequency field of the ADF/DME Tuning Window. The G1000 System does not tune the ADF emergency frequency, 2182.0-kHz.

Tuning an ADF frequency:

- 1) Press the **ADF/DME** Softkey to display the ADF/DME Tuning Window.
- 2) Turn the large **FMS** Knob to place the selection cursor over the standby ADF frequency field.
- 3) Turn the small **FMS** Knob to begin data entry and change each digit.
- 4) Turn the large **FMS** Knob to move the cursor to the next digit position.
- 5) Press the **ENT** Key to complete data entry for the standby frequency.

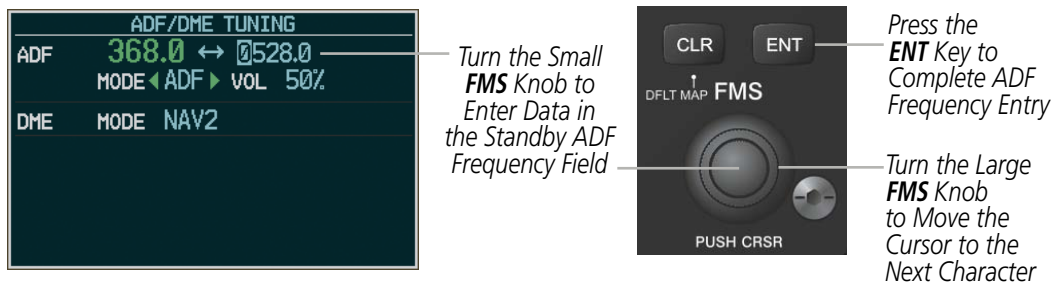

Figure 4-30 Entering ADF Standby Frequencies

Pressing the **CLR** Key before completing frequency entry cancels the frequency change and reverts back to the previously entered frequency.

Pressing the **CLR** Key when the cursor is flashing, clears the frequency and replaces the standby field with '0000.0'.

Transferring the active and standby ADF frequencies:

- 1) Turn the large **FMS** Knob to place the selection cursor over the standby ADF frequency field.
- 2) Press the **ENT** Key to complete the frequency transfer.

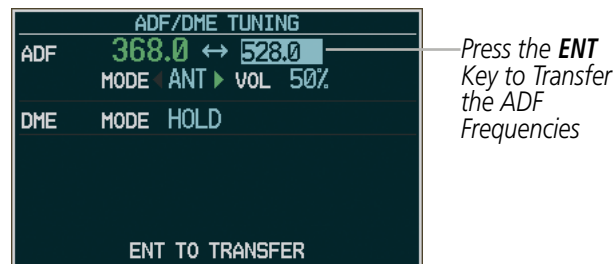

Figure 4-31 Transferring ADF Frequencies

SELECTING ADF RECEIVER MODE

The following modes can be selected: (In all modes NDB audio can be heard by pressing the **ADF** Key on the Audio Panel.)

- ANT (Antenna) – The ADF bearing pointer parks on the HSI at 90 degrees. Best mode for listening to NDB audio.
- ADF (Automatic Direction Finder) – The ADF pointer points to the relative bearing of the NDB station.
- ADF/BFO (ADF/Beat Frequency Oscillator) – The ADF pointer points to the relative bearing of the NDB station and an audible tone confirms signal reception. This mode allows identification of the interrupted carrier beacon stations used in various parts of the world.
- ANT/BFO (Antenna/Beat Frequency Oscillator) – The ADF bearing pointer parks on the HSI at 90 degrees while an audible tone is provided when a signal is received. This mode also allows identification of the interrupted carrier beacon stations and confirms signal reception.

Selecting an ADF receiver mode:

- 1) Turn the large **FMS** Knob to place the selection cursor over the ADF mode field.
- 2) Turn the small **FMS** Knob to select the desired ADF receiver mode.

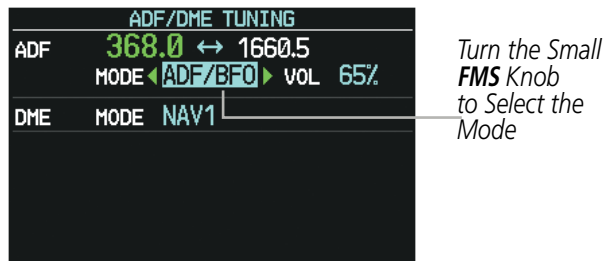

Figure 4-32 Selecting ADF Receiver Mode

ADF receiver volume level can be adjusted in the tuning window from 0 to 100%. The default volume level is set to 50%. The ADF volume level is the same for both Audio Panels.

Adjusting ADF receiver volume:

- 1) Turn the large **FMS** Knob to place the selection cursor over the ADF volume field.
- 2) Turn the small **FMS** Knob to adjust volume as desired.

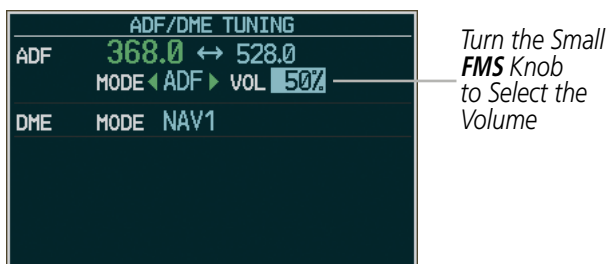

Figure 4-33 Adjusting ADF Receiver Volume

DME TUNING



NOTE: When turning on the G1000 for use, the system remembers the last frequency used for DME tuning and the NAV1, NAV2, or HOLD state prior to shutdown.

The DME transceiver is tuned by selecting NAV1, NAV2, or HOLD in the ADF/DME Tuning Window.

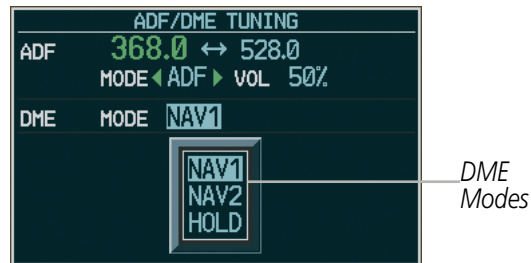

Figure 4-34 ADF/DME Tuning Window, DME Modes

The following DME transceiver pairings can be selected:

- NAV1 – Pairs the DME frequency from the selected NAV1 frequency.
- NAV2 – Pairs the DME frequency from the selected NAV2 frequency.
- HOLD – When in the HOLD position, the DME frequency remains paired with the last selected NAV frequency.

Selecting DME transceiver pairing:

- 1) Press the **ADF/DME** Softkey to display the ADF/DME Tuning Window.
- 2) Turn the small **FMS** Knob to select the DME tuning mode.
- 3) Press the **ENT** Key to complete the selection.

Pressing the **CLR** Key or **FMS** Knob while in the process of DME pairing cancels the data entry and reverts back to the previously selected DME tuning state. Pressing the **FMS** Knob activates/deactivates the cursor in the ADF/DME Tuning Window.

4.4 GTX 33/33D MODE S TRANSPONDERS

The GTX 33 Mode S Transponder and GTX 33D Diversity Mode S Transponder provide Mode A, Mode C, and Mode S interrogation and reply capabilities. Diversity incorporates antennas mounted on the top and bottom of the aircraft for dependable operation while maneuvering. Selective addressing or Mode Select (Mode S) capability includes the following features:

- Level-2 reply data link capability (used to exchange information between aircraft and ATC facilities)
- Surveillance identifier capability
- Flight ID (Flight Identification) reporting – The Mode S Transponder reports aircraft identification as either the aircraft registration or a unique Flight ID.
- Altitude reporting
- Airborne status determination
- Transponder capability reporting
- Mode S Enhanced Surveillance (EHS) requirements
- Acquisition squitter – Acquisition squitter, or short squitter, is the transponder 24-bit identification address. The transmission is sent periodically, regardless of the presence of interrogations. The purpose of acquisition squitter is to enable Mode S ground stations and aircraft equipped with a Traffic Avoidance System (TAS) to recognize the presence of Mode S-equipped aircraft for selective interrogation.

The Hazard Avoidance Section provides more details on traffic avoidance systems.

TRANSPONDER CONTROLS

Transponder function is displayed on three levels of softkeys on the PFD: Top-level, Mode Selection, and Code Selection. When the top-level **XPDR** Softkey is pressed, the Mode Selection softkeys appear: **XPDR1**, **XPDR2**, **STBY**, **ON**, **ALT**, **VFR**, **CODE**, **IDENT**, **BACK**.

When the **CODE** Softkey is pressed, the number softkeys appear: **0**, **1**, **2**, **3**, **4**, **5**, **6**, **7**, **IDENT**, **BKSP**, **BACK**. The digits 8 and 9 are not used for code entry. Pressing the numbered softkeys in sequence enters the transponder code. If an error is made, pressing the **BKSP** Softkey moves the code selection cursor to the previous digit. Pressing the **BKSP** Softkey again moves the cursor to the next previous digit.

Pressing the **BACK** Softkey during code selection reverts to the Mode Selection Softkeys. Pressing the **BACK** Softkey during mode selection reverts to the top-level softkeys.

The code can also be entered with the **FMS** Knob on either PFD. Code entry must be completed with either the softkeys or the **FMS** Knob, but not a combination of both.

Pressing the **IDENT** Softkey while in Mode or Code Selection initiates the ident function and reverts to the top-level softkeys.

After 45 seconds of transponder control inactivity, the system reverts back to the top-level softkeys.

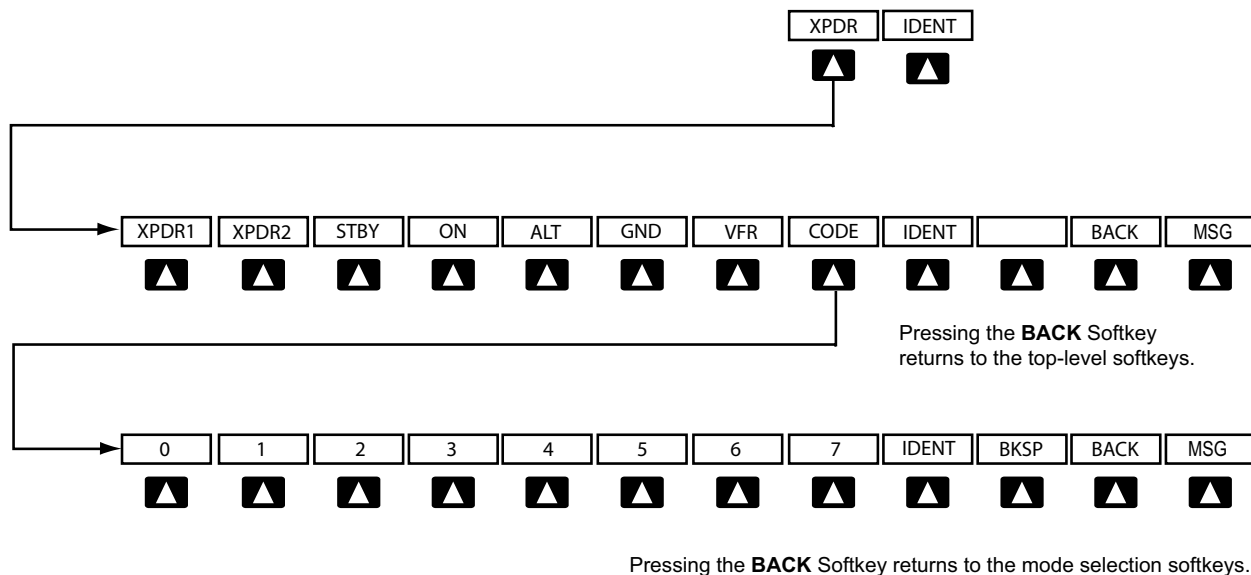

Figure 4-35 Transponder Softkeys (PFD)

Selecting and activating Transponder 1 or Transponder 2:

- 1) Press the **XPDR** Softkey to display the Transponder Mode Selection Softkeys.
- 2) Press the **XPDR1** or **XPDR2** Softkey to select and activate the other transponder.

When turning on the G1000 for use, the system activates Transponder 1 as the default unit, regardless of which transponder was active prior to shutdown. When switching between Transponder 1 and Transponder 2, the code and mode remain the same. If a new code is entered in the active transponder, switching transponders does not bring back the previous code.

TRANSPONDER MODE SELECTION

Mode selection can be automatic (Ground and Altitude Modes) or manual (Standby, ON, and Altitude Modes). The **STBY**, **ON**, and **ALT** Softkeys can be accessed by pressing the **XPDR** Softkey.

Selecting a transponder mode:

- 1) Press the **XPDR** Softkey to display the Transponder Mode Selection Softkeys.
- 2) Press the desired softkey to activate the transponder mode.

GROUND MODE

Ground Mode is normally selected automatically when the aircraft is on the ground. The transponder powers up in the last mode it was in when shut down. Ground Mode can be overridden by pressing any one of the Mode Selection Softkeys. A green GND indication and transponder code appear in the mode field of the Transponder Data Box. In Ground Mode, the transponder does not allow Mode A and Mode C replies, but it does permit acquisition squitter and replies to discretely addressed Mode S interrogations.

When Standby Mode has been selected on the ground, the transponder can be returned to Ground Mode by pressing the **GND** Softkey.



Figure 4-36 Ground Mode

STANDBY MODE (MANUAL)

NOTE: In Standby Mode, the IDENT function is inhibited.

Standby Mode can be selected at any time by pressing the **STBY** Softkey. In Standby, the transponder does not reply to interrogations, but new codes can be entered. When Standby is selected, a white STBY indication and transponder code appear in the mode field of the Transponder Data Box. In all other modes, these fields appear in green.



Figure 4-37 Standby Mode

MANUAL ON MODE

ON Mode can be selected at any time by pressing the **ON** Softkey. ON Mode generates Mode A and Mode S replies, but Mode C altitude reporting is inhibited. In ON Mode, a green ON indication and transponder code appear in the mode field of the Transponder Data Box.

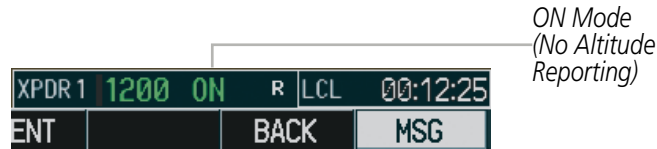

Figure 4-38 ON Mode

ALTITUDE MODE (AUTOMATIC OR MANUAL)

Altitude Mode is automatically selected when the aircraft becomes airborne. Altitude Mode may also be selected manually by pressing the **ALT** Softkey.

If Altitude Mode is selected, a green ALT indication and transponder code appear in the mode field of the Transponder Data Box, and all transponder replies requesting altitude information are provided with pressure altitude information.



Figure 4-39 Altitude Mode

REPLY STATUS

When the transponder sends replies to interrogations, a white R indication appears momentarily in the reply status field of the Transponder Data Box.



Figure 4-40 Reply Indication

ENTERING A TRANSPONDER CODE

Entering a transponder code with softkeys:

- 1) Press the **XPDR** Softkey to display the Transponder Mode Selection Softkeys.
- 2) Press the **CODE** Softkey to display the Transponder Code Selection Softkeys, for digit entry.
- 3) Press the digit softkeys to enter the code in the code field. When entering the code, the next softkey in sequence must be pressed within 10 seconds, or the entry is cancelled and restored to the previous code. Pressing the **BKSP** Softkey moves the code selection cursor to the previous digit. Five seconds after the fourth digit has been entered, the transponder code becomes active.



Figure 4-41 Entering a Code

Entering a transponder code with the PFD FMS Knob:

- 1) Press the **XPDR** and the **CODE** Softkeys as in the previous procedure to enable code entry.
- 2) Turn the small **FMS** Knob on the PFD to enter the first two code digits.
- 3) Turn the large **FMS** Knob to move the cursor to the next code field.
- 4) Enter the last two code digits with the small **FMS** Knob.
- 5) Press the **ENT** Key to complete code digit entry.

Pressing the **CLR** Key or small **FMS** Knob before code entry is complete cancels code entry and restores the previous code. Waiting for 10 seconds after code entry is finished activates the code automatically.

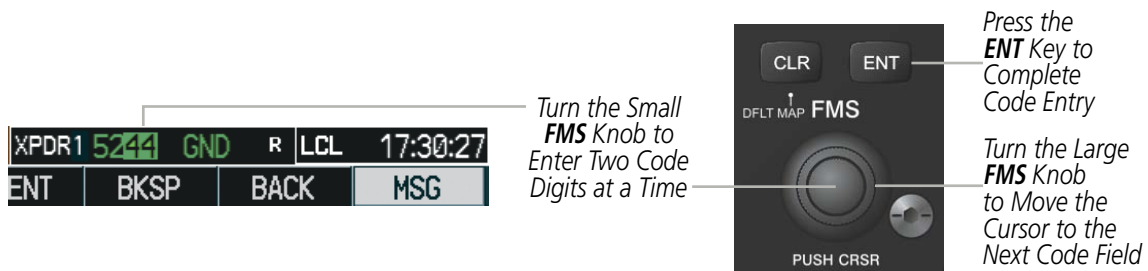

Figure 4-42 Entering a Code with the FMS Knob

VFR CODE

The VFR code can be entered either manually or by pressing the **XPDR** Softkey, then the **VFR** Softkey. When the **VFR** Softkey is pressed, the pre-programmed VFR code is automatically displayed in the code field of the Transponder Data Box. Pressing the **VFR** Softkey again restores the previous identification code.

The pre-programmed VFR Code is set at the factory to 1200. If a VFR code change is required, contact a Garmin-authorized service center for configuration.

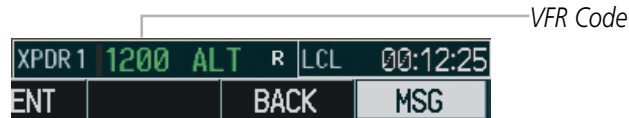

Figure 4-43 VFR Code

IDENT FUNCTION

NOTE: In Standby Mode, the **IDENT** Softkey is inoperative.

Pressing the **IDENT** Softkey sends a distinct identity indication to Air Traffic Control (ATC). The indication distinguishes the identifying transponder from all the others on the air traffic controller's screen. The **IDENT** Softkey appears on all levels of transponder softkeys. When the **IDENT** Softkey is pressed, a green IDNT indication is displayed in the mode field of the Transponder Data Box for a duration of 18 seconds.

After the **IDENT** Softkey is pressed while in Mode or Code Selection, the system reverts to the top-level softkeys.



Figure 4-44 IDENT Softkey and Indication

FLIGHT ID REPORTING

NOTE: *If the Flight ID is required but the system is not configured for it, contact a Garmin-authorized service center for configuration.*

When the Flight ID must be entered before flight operation, the identifier is placed in the Timer/References Window on the PFD. The system allows entry of up to eight characters. No space is needed when entering Flight ID. When a Flight ID contains a space, the system automatically removes it upon completion of Flight ID entry.

Entering a Flight ID:

- 1) Press the **TMR/REF** Softkey to display the Timer/References Window.
- 2) Press the **FMS** Knob to activate the selection cursor, if not already activated.
- 3) Turn the large **FMS** Knob to scroll down to the Flight ID.
- 4) Turn the small **FMS** Knob to enter the desired Flight ID.
- 5) Press the **ENT** Key to complete Flight ID entry.

If an error is made during Flight ID entry, pressing the **CLR** Key returns to the original Flight ID entry. While entering a Flight ID, turning the **FMS** Knob counterclockwise moves the cursor back one space for each detent of rotation. If an incorrect Flight ID is discovered after the unit begins operation, reenter the correct Flight ID using the same procedure.



Figure 4-45 Timer/References Window, Entering Flight ID

4.5 ADDITIONAL AUDIO PANEL FUNCTIONS

POWER-UP

The Audio Panels perform a self-test during power-up. During the self-test all Audio Panel annunciator lights illuminate for approximately two seconds. Once the self-test is completed, most of the settings are restored to those in use before the unit was last turned off. The exceptions are the cabin and intercom, which are always selected during power up.

MONO/STEREO HEADSETS

Stereo headsets are recommended for use in this aircraft.

Using a monaural headset in a stereo jack shorts the right headset channel output to ground. While this does not damage the Audio Panel, a person listening on a monaural headset hears only the left channel in both ears. If a monaural headset is used at one of the passenger positions, any other passenger using a stereo headset hears audio in the left ear only.

SPEAKER

Each Audio Panel controls a separate cabin speaker. Pressing the **SPKR** Key selects and deselects the on-side speaker.

All of the radios can be heard over the cabin speakers. Speaker audio is muted when the PTT is pressed. Certain aural alerts and warnings (autopilot, traffic, altitude) are always heard on the speaker, even when the speaker is not selected.

The speaker volume is adjustable within a nominal range. Contact a Garmin-authorized service center for volume adjustment.



Figure 4-46 Music and Speaker Keys

INTERCOM

Pressing the **INTR COM** Key on either Audio Panel selects and deselects the intercom on both Audio Panels. The annunciator is lit when the intercom is active. The intercom connects the pilot and copilot together. Either the pilot or copilot may select or deselect the intercom.

The **CABIN** Key initiates two way communication between the pilot or copilot and the passengers in the cabin. The annunciator is lit when the cabin intercom is active on either Audio Panel.

The **MAN SQ** Key allows either automatic or manual control of the intercom squelch setting. Pressing the **MAN SQ** Key enables manual squelch control, indicated by the MAN SQ annunciator.

- When the MAN SQ Annunciator is extinguished (Automatic Squelch is on), the **ICS** Knob controls only the volume (pressing the **ICS** Knob has no effect on the VOL/SQ selection).
- When the MAN SQ Annunciator is illuminated (Manual Squelch), the **ICS** Knob controls either volume or squelch (selected by pressing the **ICS** Knob and indicated by the VOL or SQ annunciation).

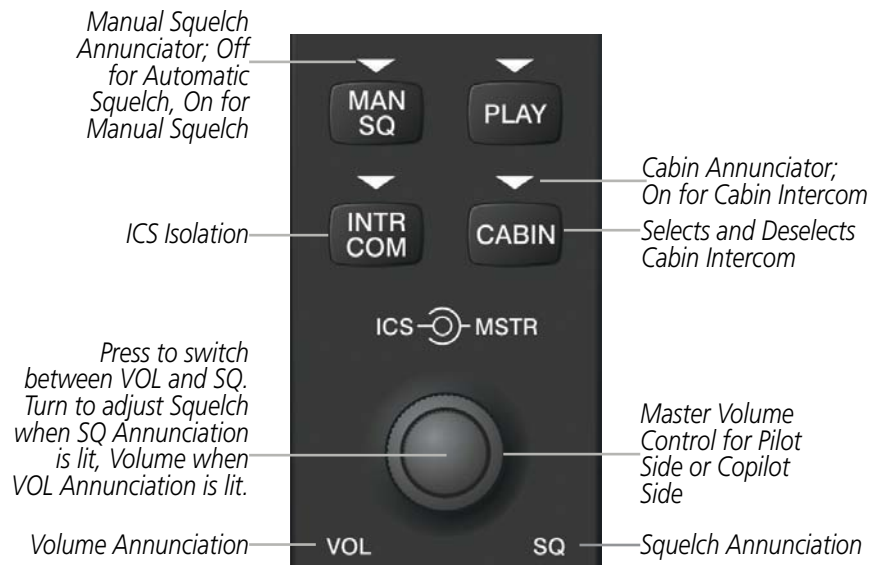

Figure 4-47 Intercom Controls

PASSENGER ADDRESS (PA) SYSTEM

A passenger address system is provided by pressing the **PA** Key to deliver messages to the passengers. The message is heard by the other pilot on the headset only if the other pilot's **PA** Key is enabled. PA messages are one way from the flight deck to the passengers.

A Push-to-talk (PTT) must be pressed to deliver PA announcements to the passengers over their headphones.

When PA is selected on the Audio Panel, the annunciator flashes about once per second while pressing the PTT, the COM MIC annunciator is no longer lit, and the active COM frequency for that Audio Panel changes to white, indicating that there is no COM selected.

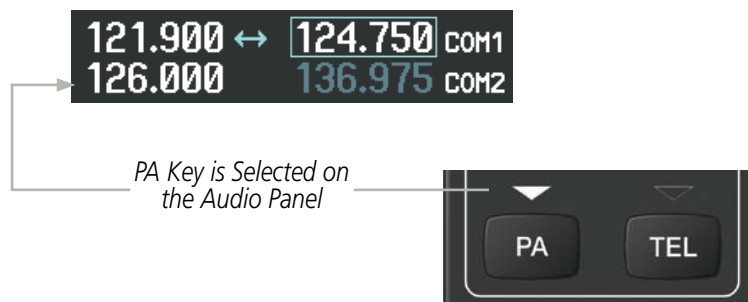



Figure 4-48 PA Key Selected for Cabin Announcements

SIMULTANEOUS COM OPERATION

Both the pilot and the copilot can transmit and receive simultaneously over separate COM radios. The selected COM MIC Annunciator flashes when either pilot's microphone PTT is pressed.

If both pilots select the same COM radio, the pilot has priority on COM1 and the copilot has priority on COM2.

CLEARANCE RECORDER AND PLAYER

 **NOTE:** Pressing the play key on the pilot's Audio Panel plays recorded audio to the Pilot. Pressing the play key on the Copilot's Audio Panel plays recorded audio to the Copilot.

The Audio Panel contains a digital clearance recorder that records up to 2.5 minutes of the selected COM radio signal. Recorded COM audio is stored in separate memory blocks. Once 2.5 minutes of recording time have been reached, the recorder begins recording over the stored memory blocks, starting from the oldest block.

The **PLAY** Key controls the play function. The PLAY annunciator flashes to indicate when play is in progress. The PLAY annunciator turns off after playback is finished.

Pressing the **PLAY** Key once plays the latest recorded memory block and then returns to normal operation. Pressing the **PLAY** Key again during play of a memory block stops play. If a COM input signal is detected during play of a recorded memory block, play is halted.

Pressing the **PLAY** Key twice within one-half second while audio is playing plays the previous block of recorded audio. Each subsequent two presses of the **PLAY** Key within one-half second backtracks through the recorded memory blocks to reach and play any recorded block.

Powering off the unit automatically clears all recorded blocks.

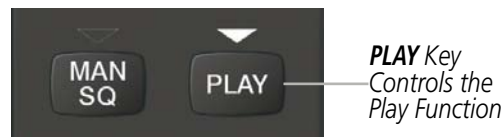

Figure 4-49 Clearance Recorder PLAY Key

ENTERTAINMENT INPUTS



NOTE: *MUSIC 1 and MUSIC 2 inputs cannot be completely turned off. Audio level for MUSIC 1 and MUSIC 2 can be adjusted by a Garmin-authorized service center.*

The Audio Panel provides two stereo auxiliary entertainment inputs: MUSIC 1 and MUSIC 2. These inputs are compatible with popular portable entertainment devices such as MP3 and CD players. Two 3.5-mm stereo phone jacks are installed in convenient locations for audio connection. The headphone outputs of the entertainment devices are plugged into the MUSIC 1 or MUSIC 2 jacks.

MUSIC 1

MUSIC 1 can be heard by the pilot and copilot when the **MUSIC** Key is selected.

MUSIC 1 MUTING

MUSIC 1 muting occurs when aircraft radio or marker beacon activity is heard. MUSIC 1 is always soft muted when an interruption occurs from an aircraft radio. Soft muting is the gradual return of MUSIC 1 to its original volume level. The time required for MUSIC 1 volume to return to normal is between one-half and four seconds.

MUSIC 1 MUTING ENABLE/DISABLE

Pressing and holding the **MUSIC** Key for three seconds switches MUSIC 1 muting on and off. When switching, either one or two beeps are heard; one beep indicates that music muting is enabled, two beeps indicate music muting is disabled.

MUSIC 1 muting is independent for each Audio Panel. Pressing the **MUSIC** Key on one Audio Panel does not enable/disable MUSIC 1 muting on the opposite side. MUSIC 1 muting is reset (enabled) during power up.

MUSIC 2

MUSIC 2 can be heard only by the passengers and is never muted.

SIRIUSXM RADIO ENTERTAINMENT

SiriusXM Satellite Radio audio from the Data Link Receiver may be heard by the pilot and passengers simultaneously (optional: requires subscription to SiriusXM Satellite Radio Service). Refer to the Additional Features Section for more details on the Data Link Receiver.

Connecting a stereo input to either MUSIC 1 or MUSIC 2 jacks removes the SiriusXM Satellite Radio Audio from that input. For example, if passengers prefer their own music while the pilot listens to the SiriusXM Satellite Radio, the entertainment audio should be connected to the MUSIC 2 jack.

4.6 AUDIO PANELS PREFLIGHT PROCEDURE

NOTE: If the pilot and/or copilot are using headsets that have a high/low switch or volume control knob, verify that the switch is in the high position and the volume control on the headsets are at maximum volume setting. On single-pilot flights, verify that all other headsets are not connected to avoid excess noise in the audio system.

NOTE: Adjusting the PILOT volume control affects ICS audio that is heard in the headset for the flight crew member that is performing the adjustment. Keep in mind that the intercom volumes on the Audio Panels are independent of one another, but the radio volumes are not.

NOTE: When the **MAN SQ** Key is pressed, the ICS squelch can be set manually by the pilot and copilot. If manual squelch is set to full open (SQ annunciated and the knobs turned counterclockwise) background noise is heard in the ICS system as well as during COM transmissions.

After powering up the G1000 System, the following steps aid in maximizing the use of the Audio Panels as well as prevent pilot and copilot induced issues. These preflight procedures should be performed each time a pilot boards the aircraft to insure awareness of all audio levels in the Audio Panel and radios.



Figure 4-50 Audio Panel Controls

Independent radio volume adjustments made using the PFD controls affect only the audio output for each radio selected for adjustment. Radio volume adjustment affects both crew positions equally for each radio that is adjusted. Turning the master volume control located on either Audio Panel affects only the audio heard in the corresponding crew position headset. Thus, radio volume adjustments may be overridden by each crew position independently using the master volume control on the Audio Panel for the respective crew position. The master volume control for each Audio Panel affects all other system audio output for the pilot or copilot headset.

Setting the Audio Panels during preflight:

- 1) Verify that the **INTR COM** Key is selected.
- 2) Verify manual squelch is set to minimum.
- 3) Turn the **MSTR** Knob (Master Volume Control) on both Audio Panels clockwise two full turns. This sets the headset audio level to max volume (least amount of attenuation).
- 4) Adjust radio volume levels (COM, NAV, etc.) to a suitable level.
- 5) Adjust the **ICS** volume Knob on each Audio Panel to the desired intercom level.
- 6) Reset squelch to automatic, or adjust to the appropriate level manually.

Once this procedure has been completed, the master volume controls on both Audio Panels may now be adjusted. The flight crew can change settings, keeping in mind the notes above.

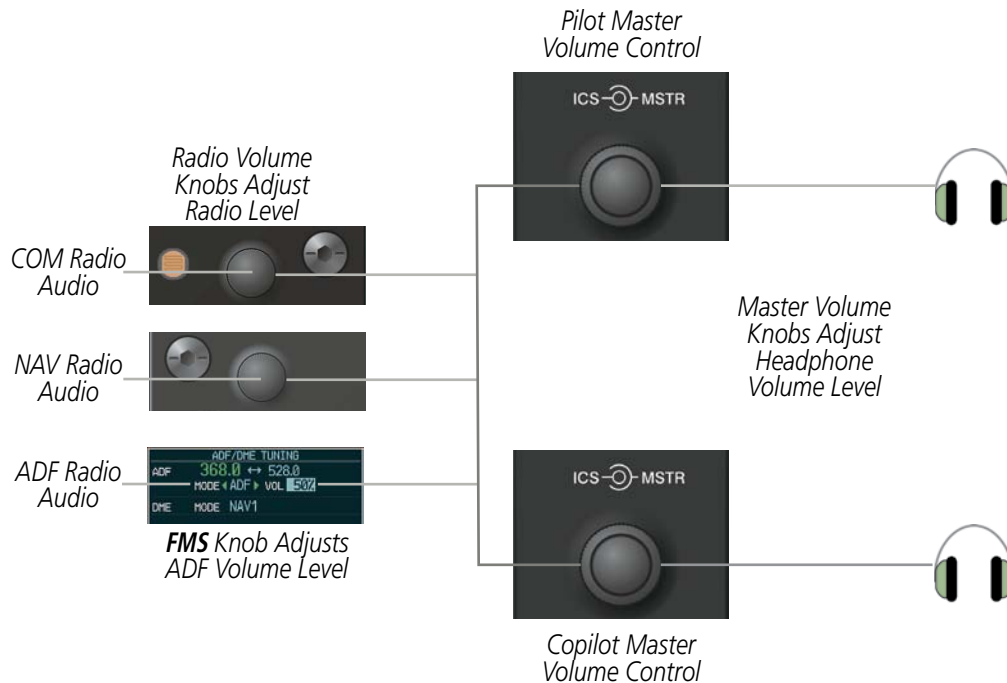

Figure 4-51 Radio and Headphone Volume Controls

4.7 ABNORMAL OPERATION

Abnormal operation of the G1000 includes equipment failures of the G1000 components and failure of associated equipment, including switches and external devices.

STUCK MICROPHONE

If the push-to-talk (PTT) Key becomes stuck, the COM transmitter stops transmitting after 35 seconds of continuous operation. An alert appears on the PFD to advise the crew of a stuck microphone.

The **COM1 MIC** or **COM2 MIC** Key Annunciator on the Audio Panel flashes as long as the PTT Key remains stuck.

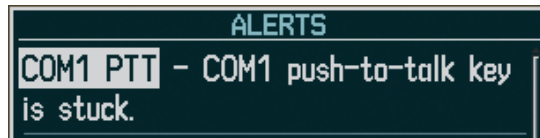

Figure 4-52 Stuck Microphone Alert

COM TUNING FAILURE

In case of a COM system tuning failure, the emergency frequency (121.500 MHz) is automatically tuned in the radio in which the tuning failure occurred. Depending on the failure mode, a red X may appear on the frequency display.



Figure 4-53 COM Tuning Failure

PFD FAILURE

If PFD1 fails, COM1 and NAV1 display a red X on both remaining displays. NAV1 is unavailable. COM1 automatically tunes 121.500 MHz, but the frequency is not shown. The COM1 emergency frequency is available to both the copilot and pilot.



Figure 4-54 Frequency Section of PFD2 Display after PFD1 Failure

If PFD2 fails, COM2 and NAV2 display a red X on the remaining PFD display. NAV2 is unavailable. COM2 tunes 121.500 MHz, but the frequency is not shown. The COM2 emergency frequency is available to both the copilot and pilot.



Figure 4-55 PFD1 Display after PFD2 Failure

AUDIO PANEL FAIL-SAFE OPERATION

If there is a failure of both Audio Panels, a fail-safe circuit connects the pilot's headset and microphone directly to the COM1 transceiver and the copilot's headset directly to the COM2 transceiver. Audio is not available on the speakers. If there is a failure of one Audio Panel, that side only has access to their respective on-side fail-safe COM.

If there is a failure of one Audio Panel, the remaining one does not have access to the other side's COM and NAV. For example, if the pilot side Audio Panel fails, the copilot side Audio Panel has access to all the radios except for COM1 and NAV1.

REVERSIONARY MODE

The red **DISPLAY BACKUP** Button selects the Reversionary Mode. See the System Overview Section for more information on Reversionary Mode.



Figure 4-56 Reversionary Mode Button

BLANK PAGE

SECTION 5 FLIGHT MANAGEMENT

5.1 INTRODUCTION

The G1000 is an integrated flight, engine, communication, navigation and surveillance system. This section of the Pilot's Guide explains GPS navigation using the G1000.

The most prominent part of the G1000 are the three full color displays: two Primary Flight Displays (PFD) and a Multi Function Display (MFD). The information to successfully navigate the aircraft using the GPS sensors is displayed on the PFD and the MFD. See examples in the Figure 5-1 and Figure 5-2. Detailed descriptions of GPS navigation functions are discussed later in this section.

A brief description of the GPS navigation data on the PFD and MFD follows.

Navigation mode indicates which sensor is providing the course data (e.g., GPS, VOR) and the flight plan phase (e.g., Departure (DPRT), Terminal (TERM), Enroute (ENR), Oceanic (OCN), Approach (LNAV, LNAV+V, L/VNAV, or LPV), or Missed Approach (MAPR)).

The Inset Map is a small version of the MFD Navigation Map and can be displayed in the lower left corner of the PFD. When the system is in reversionary mode, the Inset Map is displayed in the lower right corner. The Inset Map is displayed by pressing the **INSET** Softkey. Pressing the **INSET** Softkey again, then pressing the **OFF** Softkey removes the Inset Map.

The Navigation Map displays aviation data (e.g., airports, VORs, airways, airspaces), geographic data (e.g., cities, lakes, highways, borders), topographic data (map shading indicating elevation), and hazard data (e.g., traffic, terrain, weather). The amount of displayed data can be reduced by selecting the **DCLTR** Softkey. The Navigation Map can be oriented four different ways: North Up (NORTH UP), Track Up (TRK UP), Desired Track Up (DTK UP), or Heading Up (HDG UP).

An aircraft icon is placed on the Navigation Map at the location corresponding to the calculated present position. The aircraft position and the flight plan legs are accurately based on GPS calculations. The basemap upon which these are placed are from a source with less resolution, therefore the relative position of the aircraft to map features is not exact. The leg of the active flight plan currently being flown is shown as a magenta line on the navigation map. The other legs are shown in white.

There are 28 different map ranges available, from 500 feet to 2000 nm. The current range is indicated in the lower right corner of the map and represents the top-to-bottom distance covered by the map. To change the map range on any map, turn the **Joystick** counter-clockwise to zoom in (-, decreasing), or clockwise to zoom out (+, increasing).

The Direct-to Window, the Flight Plan Window, the Procedures Window, and the Nearest Airports Window can be displayed in the lower right corner of the PFD. Details of these windows are discussed in detail later in the section.



Figure 5-1 GPS Navigation Information on the PFD



Figure 5-2 GPS Navigation Information on the MFD Navigation Page

NAVIGATION STATUS BOX

The Navigation Status Box located at the top of the PFD contains two fields displaying the following information:



- Active flight plan leg (e.g., ‘D-> KICT’ or ‘KIXD -> KCOS’) **or** flight plan annunciations (e.g., ‘Turn right to 021° in 8 seconds’)
- Distance (DIS) and Bearing (BRG) to the next waypoint **or** flight plan annunciations (e.g., ‘TOD within 1 minute’)

The symbols used in the PFD status bar are:

Symbol	Description
	Active Leg
	Direct-to
	Right Procedure Turn
	Left Procedure Turn
	Right Holding Pattern
	Left Holding Pattern
	Vector to Final
	Right DME Arc
	Left DME Arc

The Navigation Status Box located at the top of the MFD contains four data fields, each displaying one of the following items:

- Bearing (BRG)
- Distance (DIS)
- Desired Track (DTK)
- Endurance (END)
- Enroute Safe Altitude (ESA)
- Estimated Time of Arrival (ETA)
- Estimated Time Enroute (ETE)
- Fuel on Board (FOB)
- Fuel over Destination (FOD)
- Ground Speed (GS)
- Minimum Safe Altitude (MSA)
- True Air Speed (TAS)
- Track Angle Error (TKE)
- Track (TRK)
- Vertical Speed Required (VSR)
- Crosstrack Error (XTK)

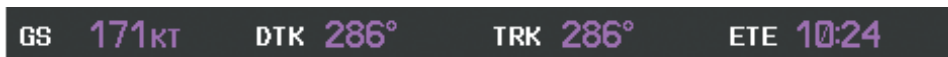

MFD Navigation Status Box

The navigation information displayed in the four data fields can be selected on the MFD Data Bar Fields Box on the AUX - System Setup Page. The default selections (in order left to right) are GS, DTK, TRK, and ETE.

Changing a field in the MFD Navigation Status Box:

- 1) Select the System Setup Page.
- 2) Press the **FMS** Knob momentarily to activate the flashing cursor.
- 3) Turn the large **FMS** Knob to highlight the desired field number in the MFD Data Bar Fields Box.
- 4) Turn the small **FMS** Knob to display and scroll through the data options list.
- 5) Select the desired data.
- 6) Press the **ENT** Key. Selecting the **DFLTS** Softkey returns all fields to the default setting.

5.2 USING MAP DISPLAYS

Map displays are used extensively in the G1000 to provide situational awareness in flight. Most G1000 maps can display the following information:

- Airports, NAVAIDs, airspaces, airways, land data (highways, cities, lakes, rivers, borders, etc.) with names
- Map Pointer information (distance and bearing to pointer, location of pointer, name, and other pertinent information)
- Map range
- Wind direction and speed
- Map orientation
- Icons for enabled map features
- Aircraft icon (representing present position)
- Nav range ring
- Fuel range ring
- Flight plan legs
- User waypoints
- Track vector
- Topography scale
- Topography data
- Obstacle data

The information in this section applies to the following maps unless otherwise noted:

- All Map Group Pages (MAP)
- All Waypoint Group Pages (WPT)
- AUX - Trip Planning
- All Nearest Group Pages (NRST)
- Flight Plan Pages (FPL)
- Direct-to Window
- PFD Inset Map
- Procedure Loading Pages

MAP ORIENTATION

Maps are shown in one of four different orientation options, allowing flexibility in determining aircraft position relative to other items on the map (north up) or for determining where map items are relative to where the aircraft is going (track up, desired track up, or heading up). The map orientation is shown in the upper right corner of the map.

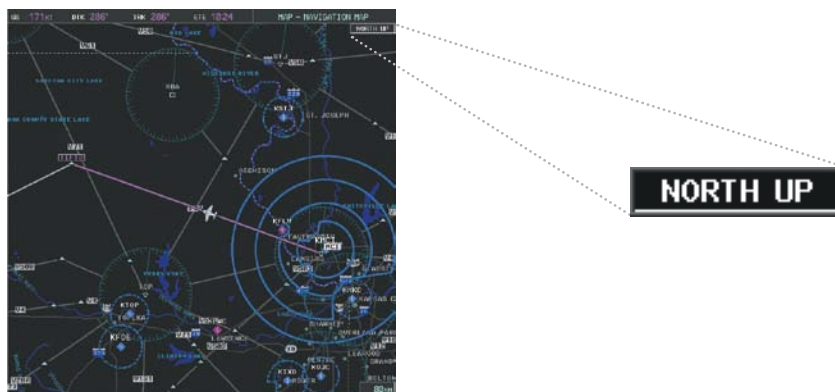

Figure 5-3 Map Orientation

- North up (NORTH UP) aligns the top of the map display to north (default setting).
- Track up (TRK UP) aligns the top of the map display to the current ground track.
- Desired track up (DTK UP) aligns the top of the map display to the desired course.
- Heading up (HDG UP) aligns the top of the map display to the current aircraft heading.

NOTE: When panning or reviewing active flight plan legs in a non-North Up orientation, the map does not show the map orientation nor the wind direction and speed.

NOTE: Map orientation can only be changed on the Navigation Map Page. Any other displays that show navigation data reflect the orientation selected for the Navigation Map Page.

Changing the Navigation Map orientation:

- 1) With the Navigation Map Page displayed, press the **MENU** Key. The cursor flashes on the 'Map Setup' option.

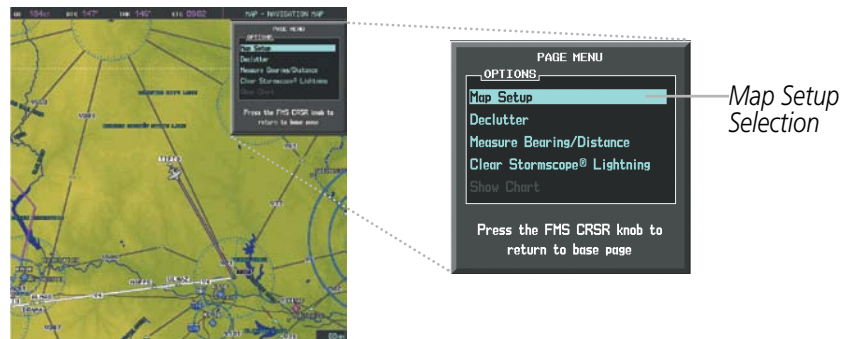

Figure 5-4 Navigation Map Page Menu Window

- 2) Press the **ENT** Key to display the Map Setup Window.
- 3) Turn the large **FMS** Knob, or press the **ENT** Key once, to select the 'ORIENTATION' field.



Figure 5-5 Map Setup Menu Window - Map Group

- 4) Turn the small **FMS** Knob to select the desired orientation.
- 5) Press the **ENT** Key to select the new orientation.
- 6) Press the **FMS** Knob to return to the base page.

MAP RANGE

There are 28 different map ranges available, from 500 feet to 2000 nm. The current range is indicated in the lower right corner of the map and represents the top-to-bottom distance covered by the map. When the map range is decreased to a point that exceeds the capability of the G1000 to accurately represent the map, a magnifying glass icon is shown to the left of the map range. To change the map range turn the **Joystick** counter-clockwise to decrease the range, or clockwise to increase the range.

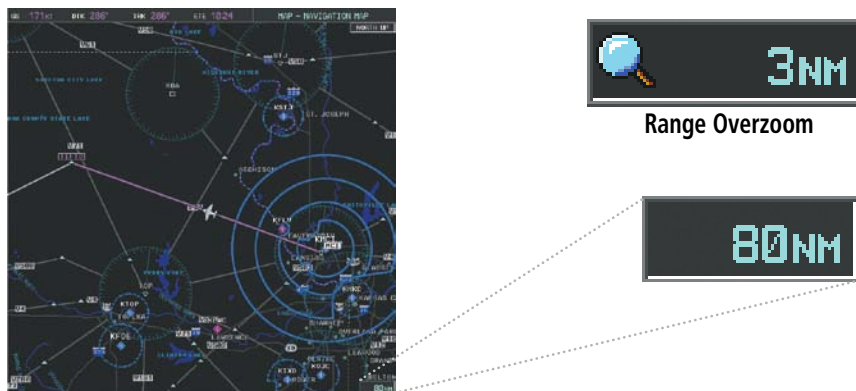

Figure 5-6 Map Range

AUTO ZOOM

Auto zoom allows the G1000 to change the map display range to the smallest range clearly showing the active waypoint. Auto zoom can be overridden by adjusting the range with the Joystick, and remains until the active waypoint changes, a terrain or traffic alert occurs, the aircraft takes off, or the manual override times out (timer set on Map Setup Window).

If a terrain caution or warning occurs, any map page displaying TAWS/TERRAIN data automatically adjusts to the smallest map range clearly showing the highest priority alert. If a new traffic advisory alert occurs, any map page capable of displaying traffic advisory alerts automatically adjusts to the smallest map range clearly showing the traffic advisory. When terrain or traffic alerts clear, the map returns to the previous auto zoom range based on the active waypoint.

The auto zoom function can be turned on or off independently for the PFD and MFD. Control of the ranges at which the auto zoom occurs is done by setting the minimum and maximum 'look forward' times (set on the Map Setup Window for the Map Group). These settings determine the minimum and maximum distance to display based upon the aircraft's ground speed.

- Waypoints that are long distances apart cause the map range to increase to a point where many details on the map are decluttered. If this is not acceptable, lower the maximum look ahead time to a value that limits the auto zoom to an acceptable range.
- Waypoints that are very short distances apart cause the map range to decrease to a point where situational awareness may not be what is desired. Increase the minimum look ahead time to a value that limits the auto zoom to a minimum range that provides acceptable situational awareness.
- Flight plans that have a combination of long and short legs cause the range to increase and decrease as waypoints sequence. To avoid this, auto zoom can be disabled or the maximum/minimum times can be adjusted.
- The 'time out' time (configurable on the Map Setup Page for the Map Group) determines how long auto zoom is overridden by a manual adjustment of the range knob. At the expiration of this time, the auto zoom range is restored. Setting the 'time out' value to zero causes the manual override to never time out.
- When the maximum 'look forward' time is set to zero, the upper limit becomes the maximum range available (2000 nm).
- When the minimum 'look forward' time is set to zero, the lower limit becomes 1.5 nm.

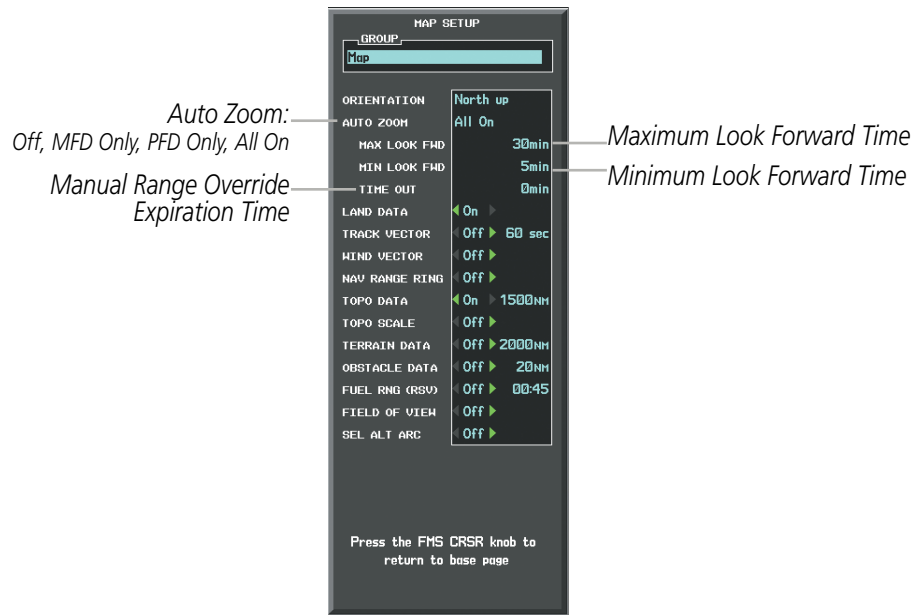

Figure 5-7 Map Setup Menu Window - Map Group, Auto Zoom

Configuring automatic zoom:

- 1) Press the **MENU** Key with the Navigation Map Page displayed. The cursor flashes on the 'Map Setup' option.
- 2) Press the **ENT** Key. The Map Setup Menu is displayed.
- 3) Select the 'Map' group.
- 4) Press the **ENT** Key.
- 5) Highlight the 'AUTO ZOOM' field.
- 6) Select 'Off', 'MFD Only', 'PFD Only', or 'ALL On'.
- 7) Press the **ENT** Key to accept the selected option. The flashing cursor highlights the 'MAX LOOK FWD' field. Times are from zero to 999 minutes.
- 8) Use the **FMS** Knobs to set the time. Press the **ENT** Key.
- 9) Repeat step 8 for 'MIN LOOK FWD' (zero to 99 minutes) and 'TIME OUT' (zero to 99 minutes).
- 10) Press the **FMS** Knob to return to the Navigation Map Page.

MAP PANNING

Map panning allows the pilot to:

- View parts of the map outside the displayed range without adjusting the map range
- Highlight and select locations on the map
- Review information for a selected airport, NAVAID or user waypoint
- Designate locations for use in flight planning
- View airspace and airway information

When the panning function is selected by pressing the **Joystick**, the Map Pointer flashes on the map display. A window also appears at the top of the map display showing the latitude/longitude position of the pointer, the bearing and distance to the pointer from the aircraft's present position, and the elevation of the land at the position of the pointer.

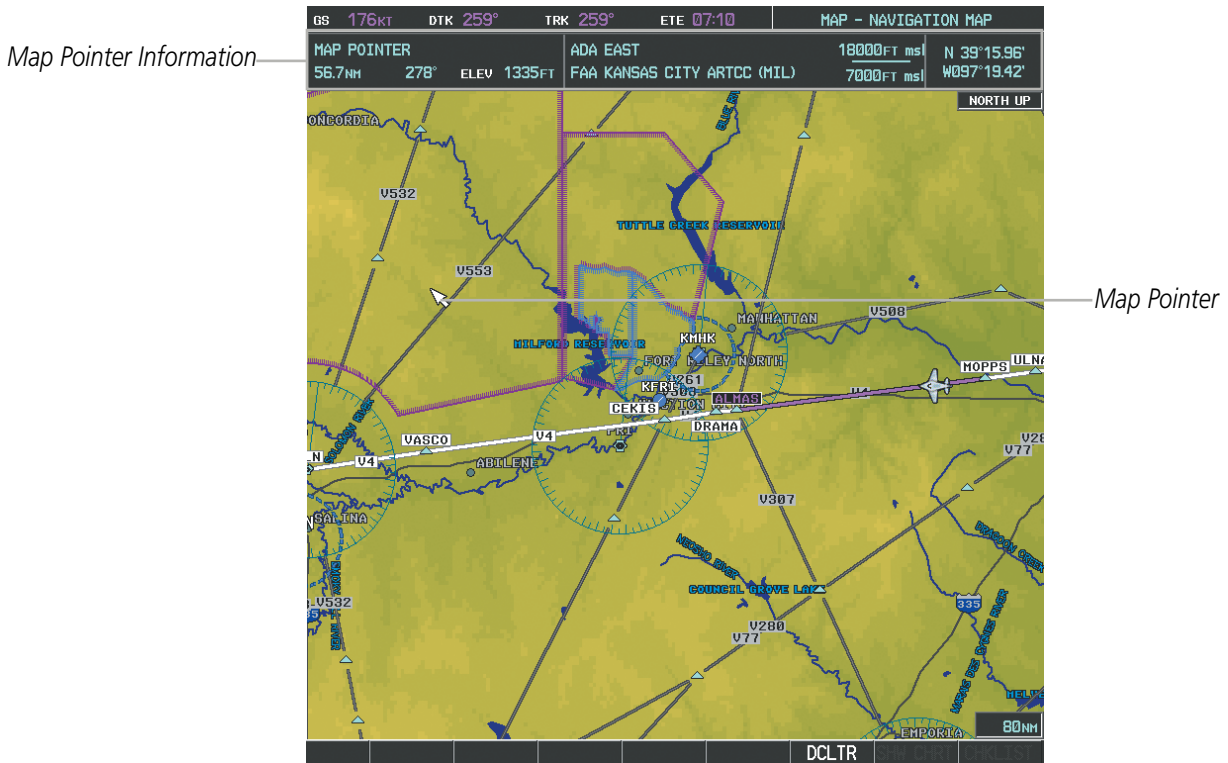

Figure 5-8 Navigation Map - Map Pointer Activated



NOTE: The map is normally centered on the aircraft's position. If the map has been panned and there has been no pointer movement for about 60 seconds, the map reverts back to centered on the aircraft position and the flashing pointer is removed.

When the Map Pointer is placed on an object, the name of the object is highlighted (even if the name was not originally displayed on the map). When any map feature or object is selected on the map display, pertinent information is displayed.

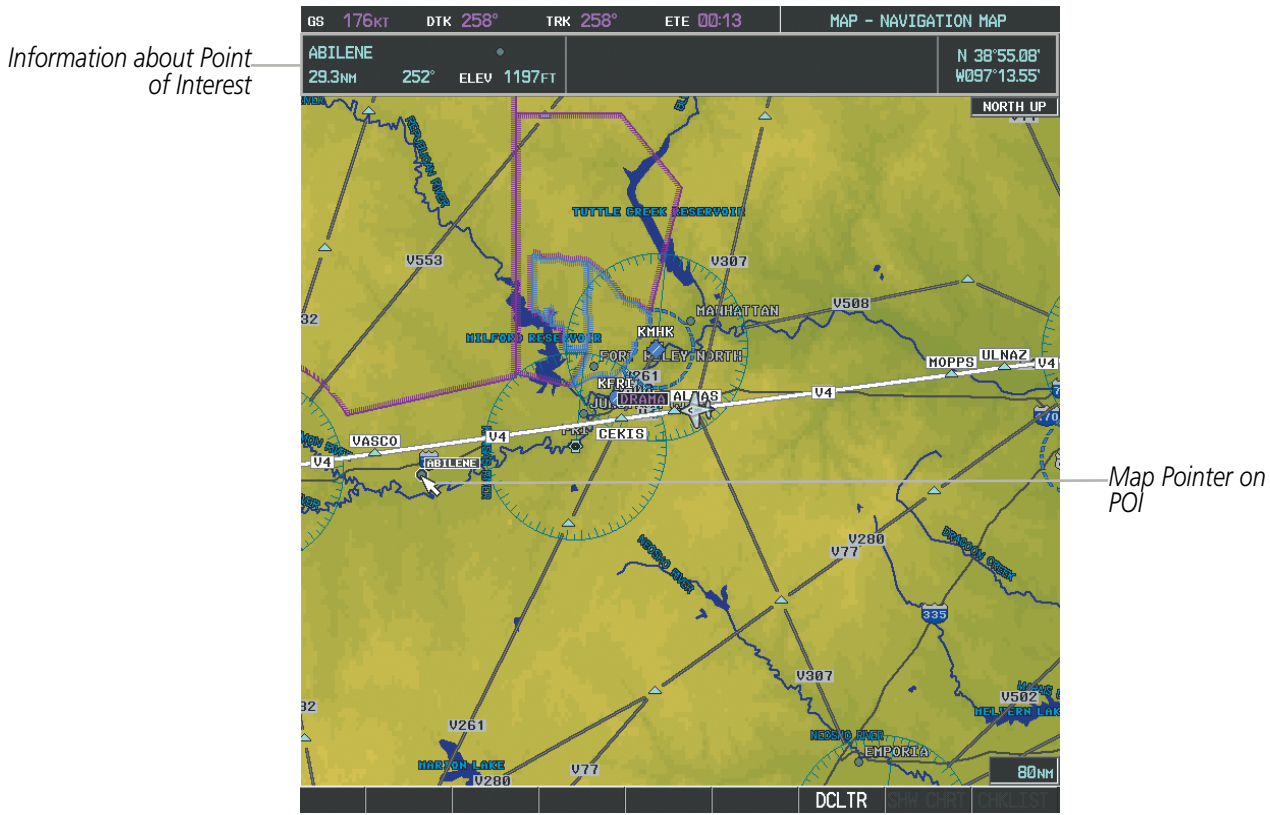

Figure 5-9 Navigation Map - Map Pointer on Point of Interest

When the Map Pointer crosses an airspace boundary, the boundary is highlighted and airspace information is shown at the top of the display. The information includes the name and class of airspace, the ceiling in feet above Mean Sea Level (MSL), and the floor in feet MSL.

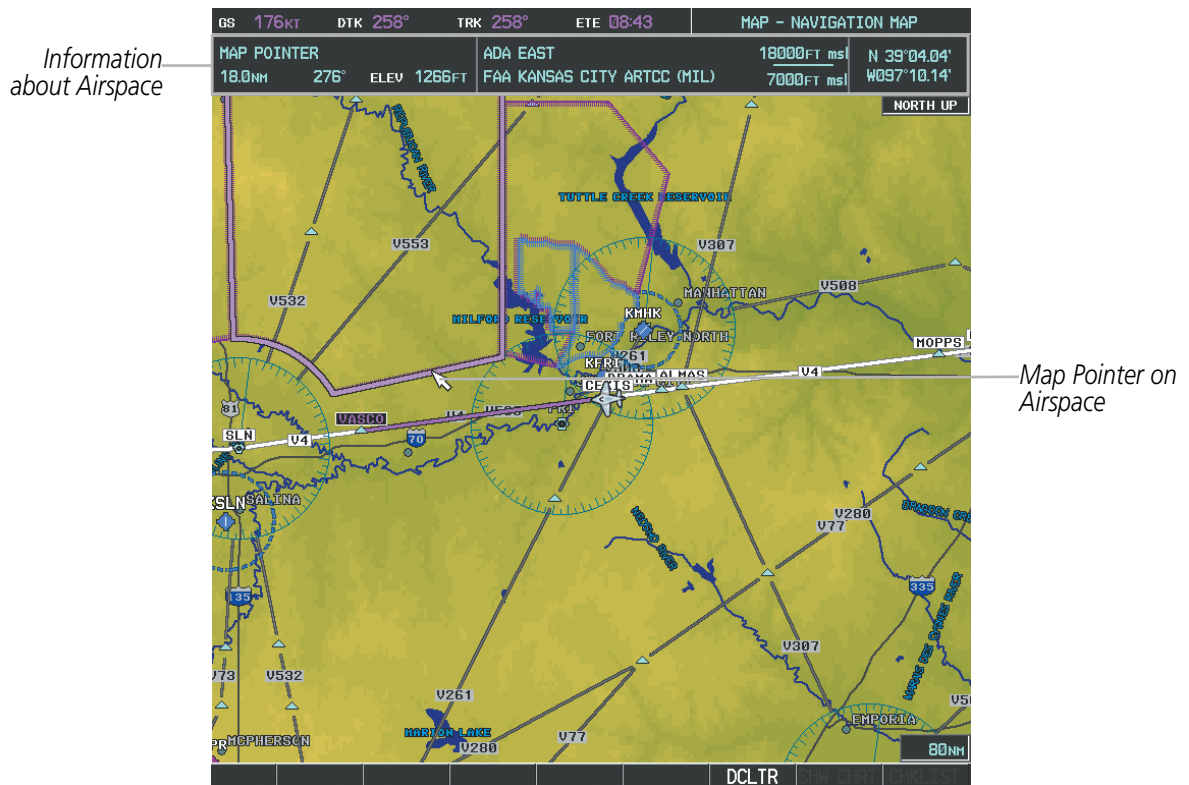

Figure 5-10 Navigation Map - Map Pointer on Airspace

Panning the map:

- 1) Press the **Joystick** to display the Map Pointer.
- 2) Move the **Joystick** to move the Map Pointer around the map.
- 3) Press the **Joystick** to remove the Map Pointer and recenter the map on the aircraft's current position.

Reviewing information for an airport, NAVAID, or user waypoint:

- 1) Place the Map Pointer on a waypoint.
- 2) Press the **ENT** Key to display the Waypoint Information Page for the selected waypoint.
- 3) Select the **GO BACK** Softkey, the **CLR** Key, or the **ENT** Key to exit the Waypoint Information Page and return to the Navigation Map showing the selected waypoint.

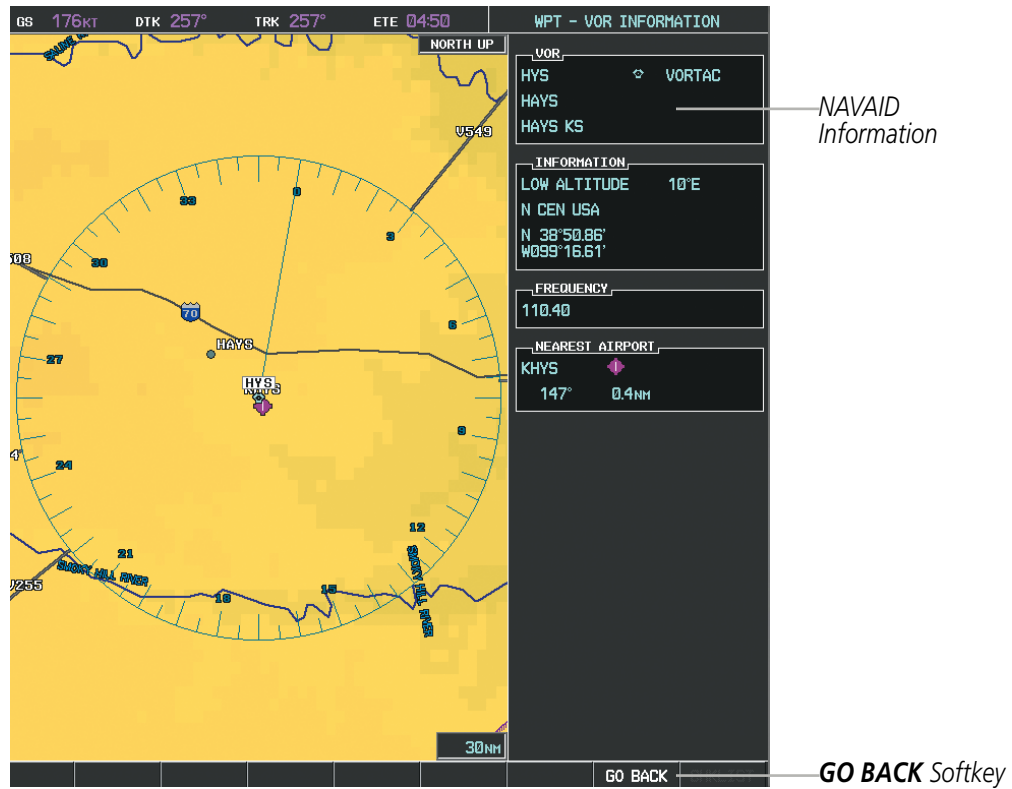

Figure 5-11 Navigation Map - Information Window - NAVAID

Viewing airspace information for a special-use or controlled airspace:

- 1) Place the Map Pointer on an open area within the boundaries of an airspace.
- 2) Press the **ENT** Key to display an options menu.
- 3) 'Review Airspaces' should already be highlighted, if not select it. Press the **ENT** Key to display the Airspace Information Page for the selected airspace.
- 4) Press the **CLR** or **ENT** Key to exit the Airspace Information Page.

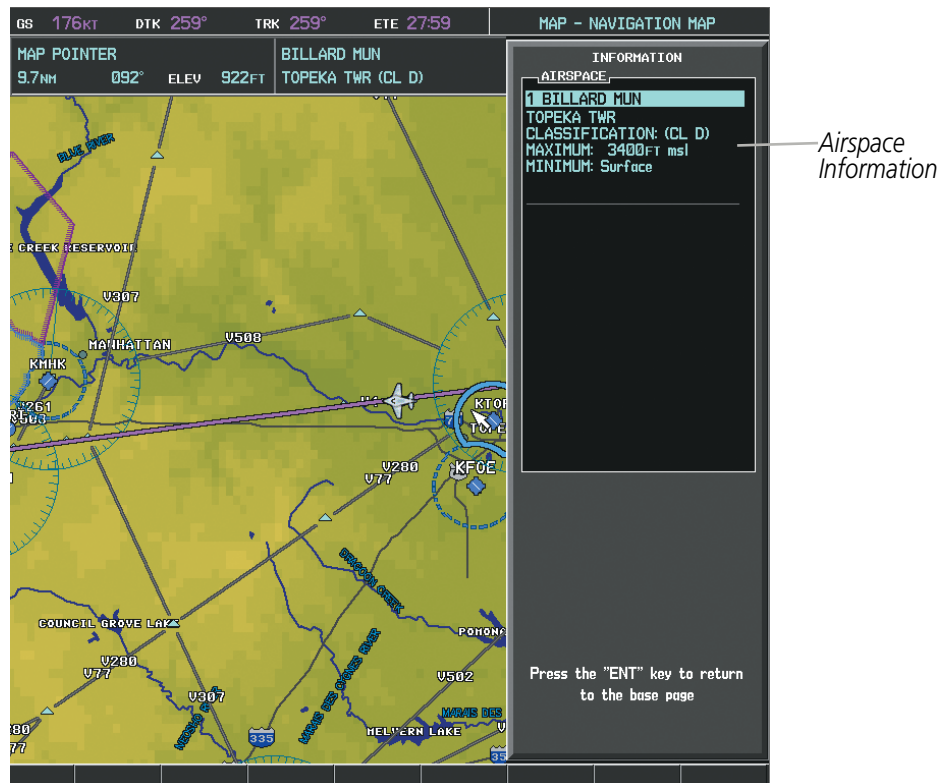

Figure 5-12 Navigation Map - Information Window - Airspace

MEASURING BEARING AND DISTANCE

Distance and bearing from the aircraft's present position to any point on the viewable navigation map may be calculated using the 'Measure Bearing and Distance' selection from Navigation Map page menu. The bearing and distance tool displays a dashed Measurement Line and a Measure Pointer to aid in graphically identifying points with which to measure. Lat/Long, distance and elevation data for the Measure Pointer is provided in a window at the top of the navigation map.

Measuring bearing and distance between any two points:

- 1) Press the **MENU** Key (with the Navigation Map Page displayed).
- 2) Highlight the 'Measure Bearing/Distance' field.
- 3) Press the **ENT** Key. A Measure Pointer is displayed on the map at the aircraft's present position.
- 4) Move the **Joystick** to place the reference pointer at the desired location. The bearing and distance are displayed at the top of the map. Elevation at the current pointer position is also displayed. Pressing the **ENT** Key changes the starting point for measuring.
- 5) To exit the Measure Bearing/Distance option, press the **Joystick**; or select 'Stop Measuring' from the Page Menu and press the **ENT** Key.

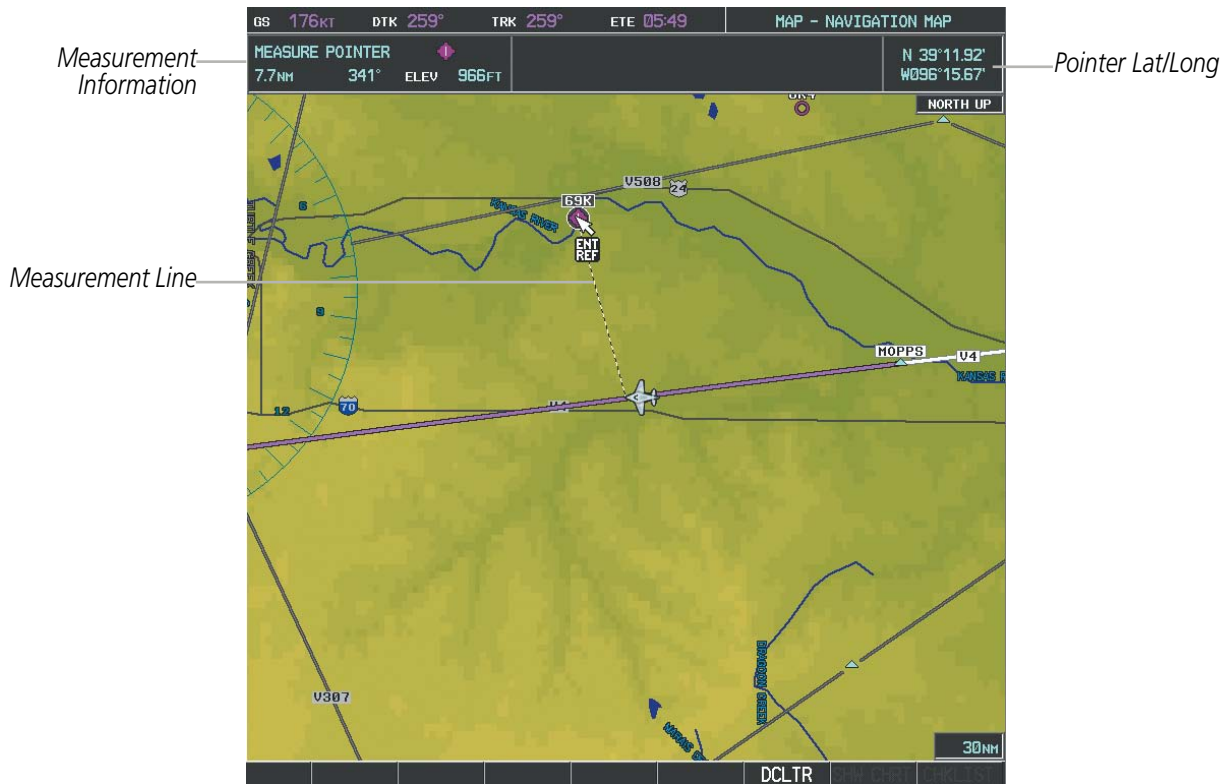

Figure 5-13 Navigation Map - Measuring Bearing and Distance

TOPOGRAPHY

All navigation maps can display various shades of topography colors representing land elevation, similar to aviation sectional charts. Topographic data can be displayed or removed as described in the following procedures.

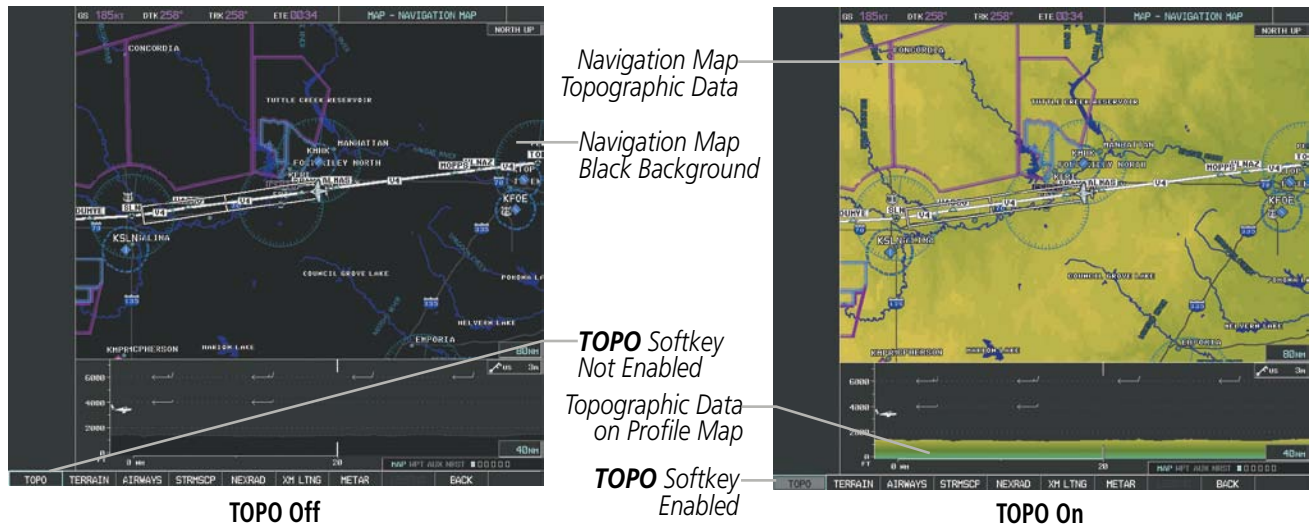

Figure 5-14 Navigation Map - Topographic Data

Displaying/removing topographic data on all pages displaying navigation maps:

- 1) Select the **MAP** Softkey (the **INSET** Softkey for the PFD Inset Map).
- 2) Select the **TOPO** Softkey.
- 3) Select the **TOPO** Softkey again to remove topographic data from the Navigation Map. When topographic data is removed from the page, all navigation data is presented on a black background.

Displaying/removing topographic data (TOPO DATA) using the Navigation Map Page Menu:

- 1) Press the **MENU** Key with the Navigation Map Page displayed. The cursor flashes on the 'Map Setup' option.
- 2) Press the **ENT** Key. The Map Setup Menu is displayed.
- 3) Select the 'Map' group.
- 4) Press the **ENT** Key.
- 5) Highlight the 'TOPO DATA' field.
- 6) Select 'On' or 'Off'.
- 7) Press the **FMS** Knob to return to the Navigation Map Page.

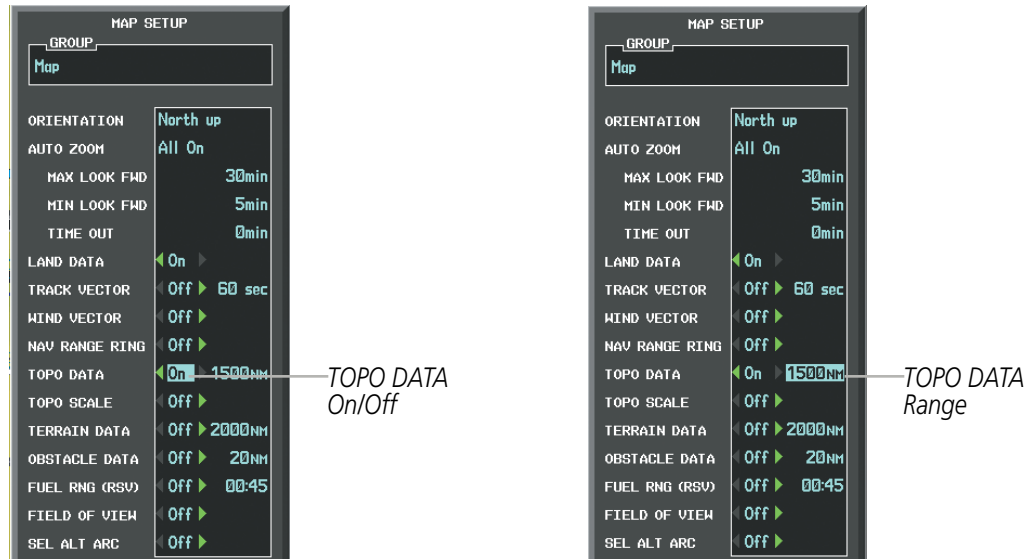

Figure 5-15 Navigation Map Setup Menu - TOPO DATA Setup

The topographic data range is the maximum map range on which topographic data is displayed.



NOTE: Since the PFD Inset Map is much smaller than the MFD navigation maps, items are removed on the PFD Inset Map two range levels smaller than the range selected in the Map Setup pages (e.g., a setting of 100 nm removes the item at ranges above 100 nm on MFD navigation maps, while the PFD Inset Map removes the same item at 50 nm).

Selecting a topographical data range (TOPO DATA):

- 1) Press the **MENU** Key with the Navigation Map Page displayed. The cursor flashes on the 'Map Setup' option.
- 2) Press the **ENT** Key. The Map Setup Menu is displayed.
- 3) Select the 'Map' group.
- 4) Press the **ENT** Key.
- 5) Highlight the 'TOPO DATA' range field. TOPO ranges are from 500 ft to 2000 nm.
- 6) To change the TOPO range setting, turn the small **FMS** Knob to display the range list.
- 7) Select the desired range using the small **FMS** Knob.
- 8) Press the **ENT** Key.
- 9) Press the **FMS** Knob to return to the Navigation Map Page.

In addition, the Navigation Map can display a topographic scale (located in the lower right hand side of the map) showing a scale of the terrain elevation and current elevation values.

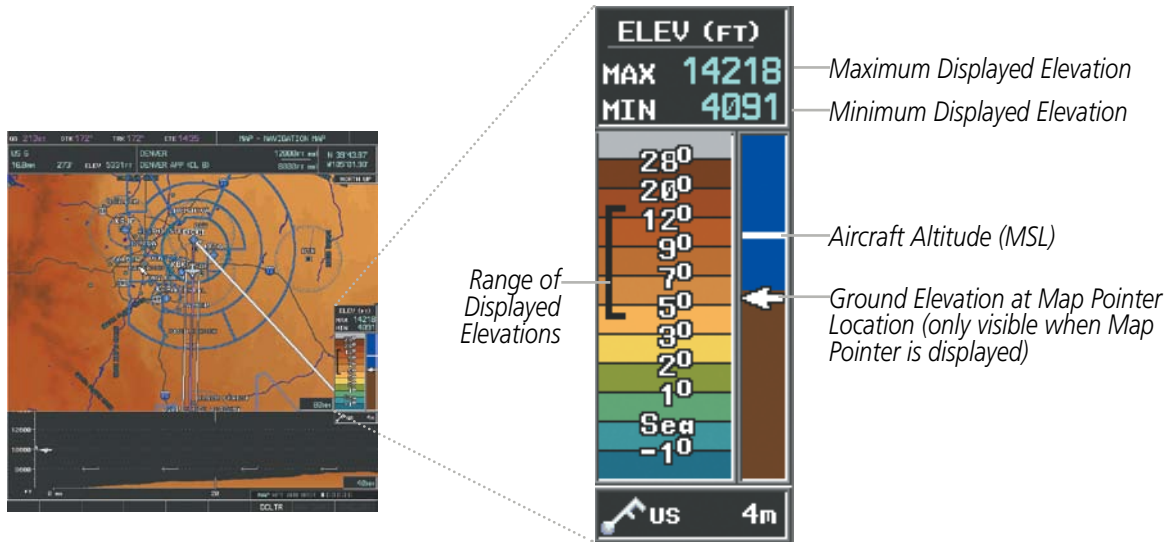

Figure 5-16 Navigation Map - TOPO SCALE

Displaying/removing the topographic scale (TOPO SCALE):

- 1) Press the **MENU** Key with the Navigation Map Page displayed. The cursor flashes on the 'Map Setup' option.
- 2) Press the **ENT** Key. The Map Setup Menu is displayed.
- 3) Select the 'Map' group and press the **ENT** Key.
- 4) Highlight the 'TOPO SCALE' field.
- 5) Select 'On' or 'Off'.
- 6) Press the **FMS** Knob to return to the Navigation Map Page.

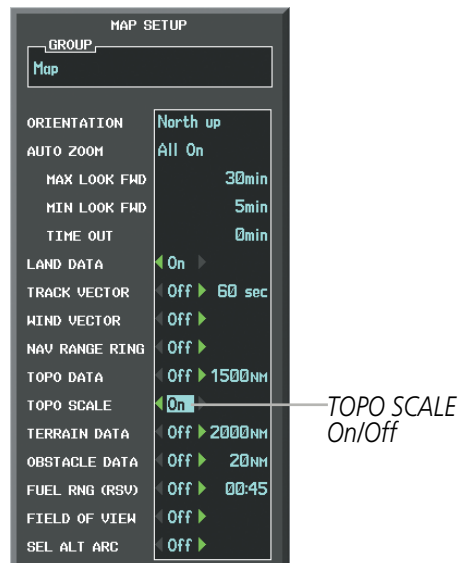

Figure 5-17 Navigation Map Setup Menu - TOPO SCALE Setup

MAP SYMBOLS

This section discusses the types of land and aviation symbols that can be displayed. Each listed type of symbol can be turned on or off, and the maximum range to display each symbol can be set. The decluttering of the symbols from the map using the **DCLTR** Softkey is also discussed.

LAND SYMBOLS

The following items are configured on the land menu:













Land Symbols <i>(Text label size can be None, Small, Medium (Med), or Large (Lrg))</i>	Symbol	Default Range (nm)	Maximum Range (nm)
Latitude/Longitude (LAT/LON)		Off	2000
Highways and Roads			
Interstate Highway (FREEWAY)		300	800
International Highway (FREEWAY)		300	800
US Highway (NATIONAL HWY)		30	80
State Highway (LOCAL HWY)		15	30
Local Road (LOCAL ROAD)	N/A	8	15
Railroads (RAILROAD)		15	30
LARGE CITY (> 200,000)		800	1500
MEDIUM CITY (> 50,000)		100	200
SMALL CITY (> 5,000)		20	50
States and Provinces (STATE/PROV)		800	1500
Rivers and Lakes (RIVER/LAKE)		200	500
USER WAYPOINT		150	300

Table 5-1 Land Symbol Information

AVIATION SYMBOLS

The following items are configured on the aviation menu:

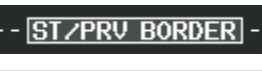
Aviation Symbols <i>(Text label size can be None, Small, Medium (Med), or Large (Lrg))</i>	Symbol	Default Range (nm)	Maximum Range (nm)
Active Flight Plan Leg (ACTIVE FPL)		2000	2000
Non-active Flight Plan Leg (ACTIVE FPL)		2000	2000
Active Flight Plan Waypoint (ACTIVE FPL WPT)	See Airports, NAVAIDs	2000	2000
Large Airports (LARGE APT)		250	500
Medium Airports (MEDIUM APT)		150	300
Small Airports (SMALL APT)		50	100
Taxiways (SAFETAXI)	See Additional Features	3	20
Runway Extension (RWY EXTENSION)	N/A	Off	100
Intersection (INT WAYPOINT)		15	30
Non-directional Beacon (NDB WAYPOINT)		15	30
VOR (VOR WAYPOINT)		150	300
Class B Airspace/TMA (CLASS B/TMA)		200	500
Class C Airspace/TCA (CLASS C/TCA)		200	500
Class D Airspace (CLASS D)		150	300
Restricted Area (RESTRICTED)		200	500
Military Operations Area [MOA(MILITARY)]		200	500
Other/Air Defense Interdiction Zone (OTHER/ADIZ)		200	500
Temporary Flight Restriction (TFR)		500	2000

Table 5-2 Aviation Symbol Information

SYMBOL SETUP

All pages with maps can display land symbols (roads, lakes, borders, etc). Land symbols can be removed totally (turned off).

Displaying/removing all land symbols:

- 1) Press the **MENU** Key with the Navigation Map Page displayed. The Page Menu is displayed and the cursor flashes on the 'Map Setup' option.
- 2) Press the **ENT** Key. The Map Setup Group Menu is displayed and the cursor flashes on the 'Map' option.
- 3) Highlight the 'LAND DATA' field.
- 4) Select 'On' or 'Off'.
- 5) Press the **FMS** Knob to return to the Navigation Map Page.

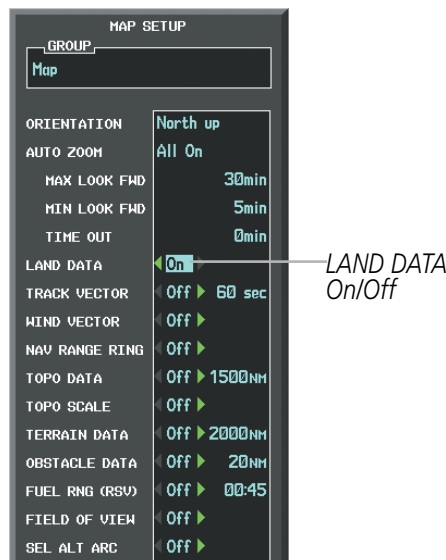

Figure 5-18 Navigation Map Setup Menu - LAND DATA Setup

The label size (TEXT) sets the size at which labels appear on the display (none, small, medium, and large). The range (RNG) sets the maximum range at which items appear on the display.

Selecting a 'Land' or 'Aviation' group item text size and range:

- 1) Press the **MENU** Key with the Navigation Map Page displayed. The cursor flashes on the 'Map Setup' option.
- 2) Press the **ENT** Key. The Map Setup Menu is displayed.
- 3) Select the 'Land' or 'Aviation' group.
- 4) Press the **ENT** Key. The cursor flashes on the first field.
- 5) Select the desired land option.
- 6) Select the desired text size.
- 7) Press the **ENT** Key to accept the selected size.

- 8) Select the desired range.
- 9) Press the **ENT** Key to accept the selected range.
- 10) Press the **FMS** Knob to return to the Navigation Map Page.

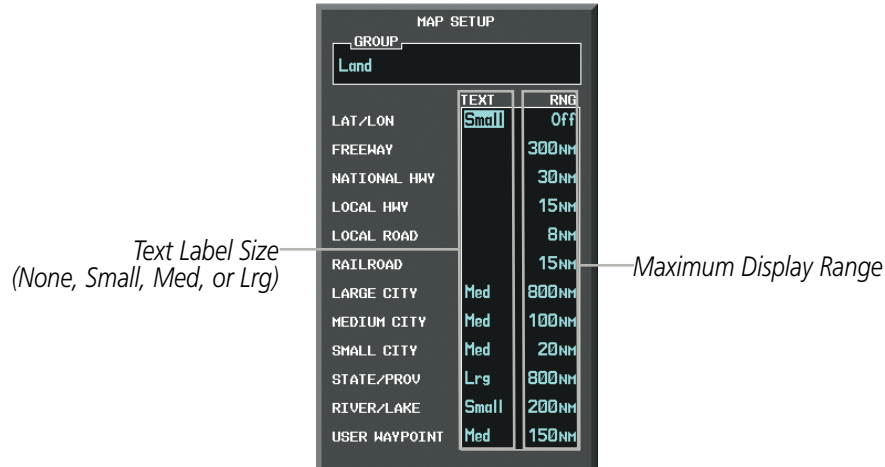

Figure 5-19 Navigation Map Setup Menu - LAND GROUP Setup

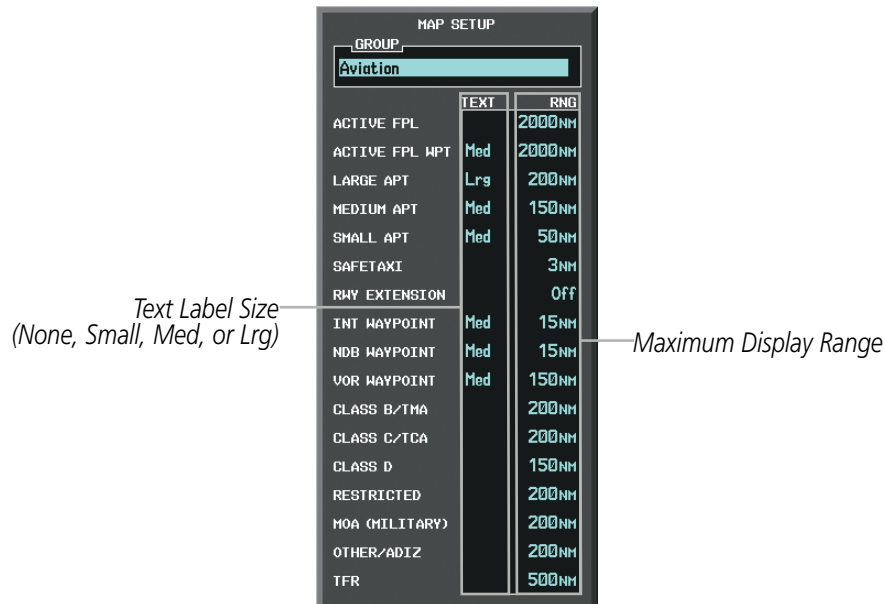

Figure 5-20 Navigation Map Setup Menu - AVIATION GROUP Setup



NOTE: Since the PFD Inset Map is much smaller than the MFD navigation maps, items are removed on the PFD Inset Map two range levels smaller than the range selected in the Map Setup pages (e.g., a setting of 100 nm removes the item at ranges above 100 nm on MFD navigation maps, while the PFD Inset Map removes the same item at 50 nm).

MAP DECLUTTER

The declutter feature allows the pilot to progressively step through four levels of removing map information. The declutter level is displayed in the **DCLTR** Softkey and next to the Declutter Menu Option.

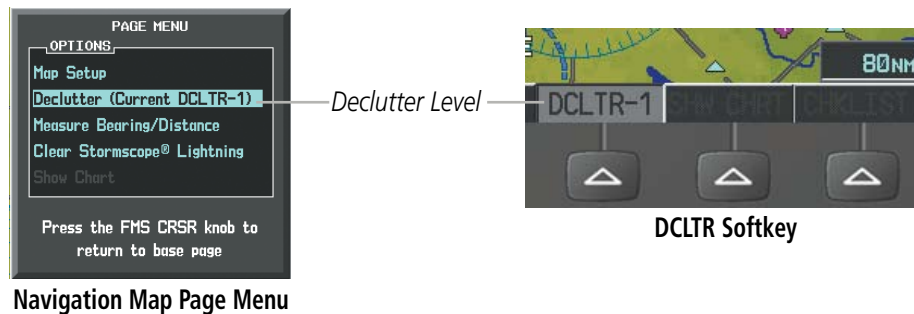

Figure 5-21 Navigation Map - Declutter Level Indications

Decluttering the map:

Select the **DCLTR** Softkey with the Navigation Map Page displayed. The current declutter level is shown. With each softkey selection, another level of map information is removed.

Or:

- 1) Press the **MENU** Key with the Navigation Map Page displayed.
- 2) Select 'Declutter'. The current declutter level is shown.
- 3) Press the **ENT** Key.

Decluttering the PFD Inset Map:

- 1) Press the **INSET** Softkey.
- 2) Press the **DCLTR** Softkey. The current declutter level is shown. With each selection, another level of map information is removed.

Table 5-3 lists the items displayed at each declutter level. The 'X' represents map items displayed for the various levels of declutter.

Item	No Declutter	Declutter-1	Declutter-2	Declutter-3
Flight Plan Route Lines	X	X	X	X
Flight Plan Route Waypoints	X	X	X	X
Rivers/Lakes	X	X	X	X
Topography Data	X	X	X	X
International Borders	X	X	X	X
Track Vector	X	X	X	X
Navigation Range Ring	X	X	X	X
Fuel Range Ring	X	X	X	X
Terrain Data	X	X	X	X
Traffic	X	X	X	X
Airways	X	X	X	X
NEXRAD	X	X	X	
XM Lightning Data	X	X	X	
Airports	X	X	X	
Runway Labels	X	X	X	
Restricted	X	X	X	
MOA (Military)	X	X	X	
User Waypoints	X	X		
Latitude/Longitude Grid	X	X		
NAVAIDs	X	X		
Class B Airspaces/TMA	X	X		
Class C Airspaces/TCA	X	X		
Class D Airspaces	X	X		
Other Airspaces/ADIZ	X	X		
TFRs	X	X		
Obstacles	X	X		
Land/Country Text	X			
Cities	X			
Roads	X			
Railroads	X			
State/Province Boundaries	X			
River/Lake Names	X			

Table 5-3 Navigation Map Items Displayed by Declutter Level

AIRWAYS

This airways discussion is based upon the North American airway structure. The airway structure in places other than North America vary by location, etc. and are not discussed in this book. Low Altitude Airways (or Victor Airways) primarily serve smaller piston-engine, propeller-driven airplanes on shorter routes and at lower altitudes. Airways are eight nautical miles wide and start 1,200 feet above ground level (AGL) and extend up to 18,000 feet mean sea level (MSL). Low Altitude Airways are designated with a “V” before the airway number (hence the name “Victor Airways”) since they run primarily between VORs.

High Altitude Airways (or Jet Routes) primarily serve airliners, jets, turboprops, and turbocharged piston aircraft operating above 18,000 feet MSL. Jet Routes start at 18,000 feet MSL and extend upward to 45,000 feet MSL (altitudes above 18,000 feet are called “flight levels” and are described as FL450 for 45,000 feet MSL). Jet Routes are designated with a “J” before the route number.

Low Altitude Airways are drawn in gray (the same shade used for roads). High Altitude Airways are drawn in green. When both types of airways are displayed, High Altitude Airways are drawn on top of Low Altitude Airways.

When airways are selected for display on the map, the airway waypoints (VORs, NDBs and Intersections) are also displayed.

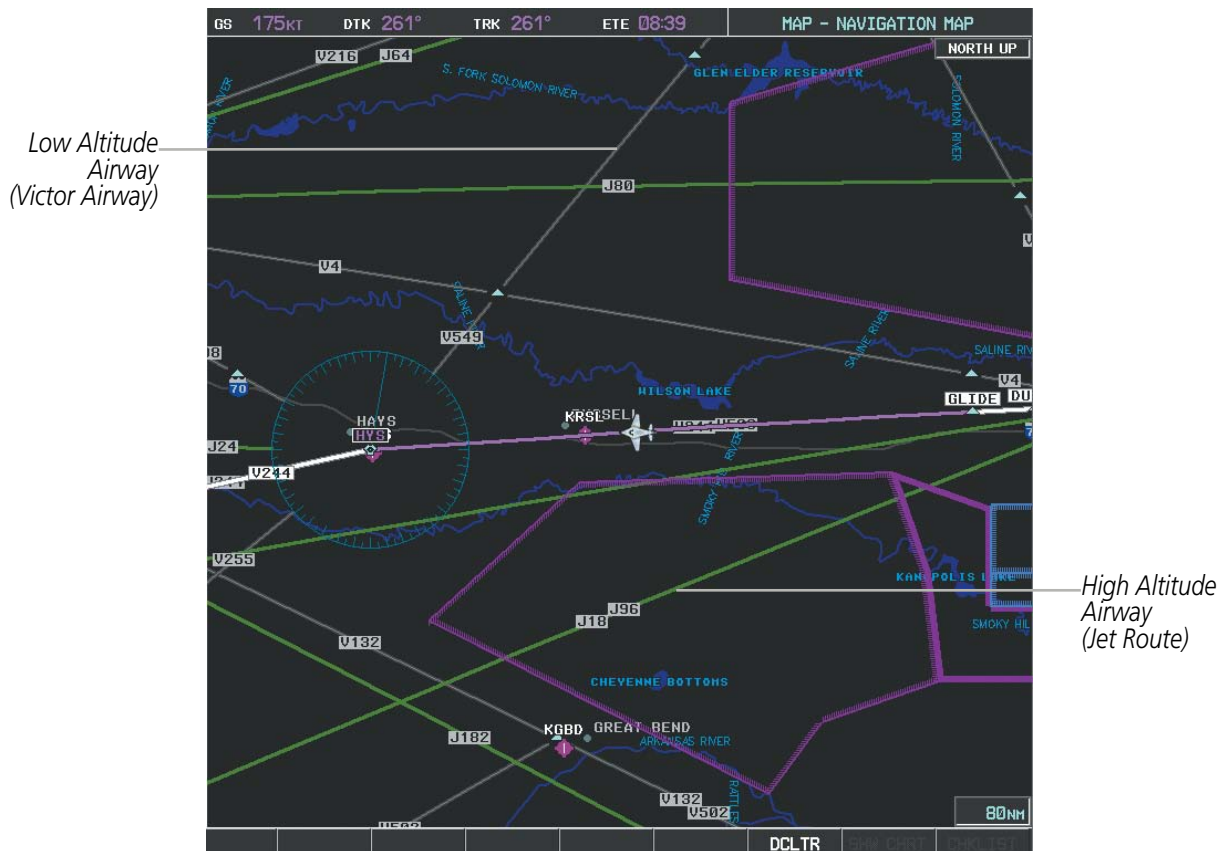

Figure 5-22 Airways on MFD Navigation Page

Airways may be displayed on the map at the pilot's discretion using either a combination of **AIRWAYS** Softkey selections, or menu selections using the **MENU** Key from the Navigation Map Page. The Airway range can also be programmed to only display Airways on the MFD when the map range is at or below a specific number.

Displaying/removing airways:

- 1) Select the **MAP** Softkey.
- 2) Select the **AIRWAYS** Softkey. Both High and Low Altitude Airways are displayed (AIRWY ON).
- 3) Select the softkey again to display Low Altitude Airways only (AIRWY LO).
- 4) Select the softkey again to display High Altitude Airways only (AIRWY HI).
- 5) Select the softkey again to remove High Altitude Airways. No airways are displayed (AIRWAYS).

Or:

- 1) Press the **MENU** Key with the Navigation Map Page displayed. The cursor flashes on the 'Map Setup' option.
- 2) Press the **ENT** Key. The Map Setup Menu is displayed.
- 3) Turn the small **FMS** Knob to select the 'Airways' group, and press the **ENT** Key.
- 4) Turn the large **FMS** Knob to highlight the 'AIRWAYS' field.
- 5) Turn the **FMS** Knob to select 'Off', 'All', 'LO Only', or 'HI Only', and press the **ENT** Key.
- 6) Press the **FMS** Knob to return to the Navigation Map Page.



Figure 5-23 Navigation Map Setup Menu - AIRWAYS Setup

The airway range is the maximum map range on which airways are displayed.

Selecting an airway range (LOW ALT AIRWAY or HI ALT AIRWAY):

- 1) Press the **MENU** Key with the Navigation Map Page displayed. The cursor flashes on the 'Map Setup' option.
- 2) Press the **ENT** Key. The Map Setup Menu is displayed.
- 3) Turn the small **FMS** Knob to select the 'Airways' group, and press the **ENT** Key.
- 4) Highlight the 'LOW ALT AIRWAY' or 'HI ALT AIRWAY' range field.
- 5) To change the range setting, turn the small **FMS** Knob to display the range list.
- 6) Select the desired range using the small **FMS** Knob.
- 7) Press the **ENT** Key.
- 8) Press the **FMS** Knob to return to the Navigation Map Page.

The following range items are configurable on the airways menu:



Airway Type	Symbol	Default Range (nm)	Maximum Range (nm)
Low Altitude Airway (LOW ALT AIRWAY)		200	500
High Altitude Airway (HI ALT AIRWAY)		300	500

Table 5-4 Airway Range Information

TRACK VECTOR

The Navigation Map can display a track vector that is useful in minimizing track angle error. The track vector is a solid light blue line segment extended to a predicted location. The track vector look-ahead time is selectable (30 sec, 60 sec (default), 2 min, 5 min, 10 min, 20 min) and determines the length of the track vector. The track vector shows up to 90 degrees of a turn for the 30 and 60 second time settings.

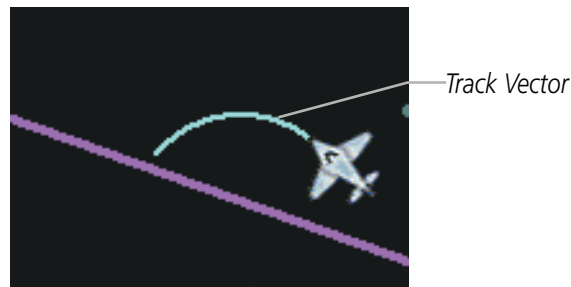

Figure 5-24 Navigation Map -Track Vector

Displaying/removing the track vector:

- 1) Press the **MENU** Key with the Navigation Map Page displayed. The cursor flashes on the 'Map Setup' option.
- 2) Press the **ENT** Key. The Map Setup Menu is displayed.
- 3) Select the 'Map' group.
- 4) Press the **ENT** Key.
- 5) Highlight the 'TRACK VECTOR' field.
- 6) Select 'On' or 'Off'. Press the **ENT** Key to accept the selected option. The flashing cursor highlights the look ahead time field. Use the **FMS** Knob to select the desired time. Press the **ENT** Key.
- 7) Press the **FMS** Knob to return to the Navigation Map Page.

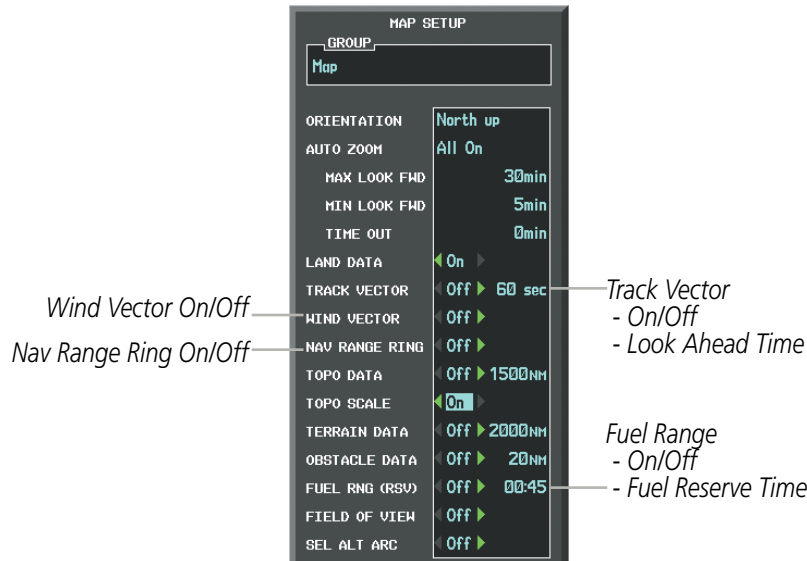

Figure 5-25 Navigation Map Setup Menu -TRACK VECTOR, WIND VECTOR, NAV RANGE RING, FUEL RANGE RING Setup

WIND VECTOR

The map displays a wind vector arrow in the upper right-hand portion of the screen. Wind vector information is displayed as a white arrow pointing in the direction in which the wind is moving for wind speeds greater than or equal to 1 kt.



Figure 5-26 Navigation Map - Wind Vector



NOTE: The wind vector is not displayed until the aircraft is moving. It is not displayed on the Waypoint Information pages.

Displaying/removing the wind vector:

- 1) Press the **MENU** Key with the Navigation Map Page displayed. The cursor flashes on the 'Map Setup' option.
- 2) Press the **ENT** Key. The Map Setup Menu is displayed.
- 3) Select the 'Map' group.
- 4) Press the **ENT** Key.
- 5) Highlight the 'WIND VECTOR' field.
- 6) Select 'On' or 'Off'.
- 7) Press the **FMS** Knob to return to the Navigation Map Page.

NAV RANGE RING

The Nav Range Ring shows the direction of travel (ground track) on a rotating compass card. The range is determined by the map range. The range is 1/4 of the map range (e.g., 37.5 nm on a 150 nm map).

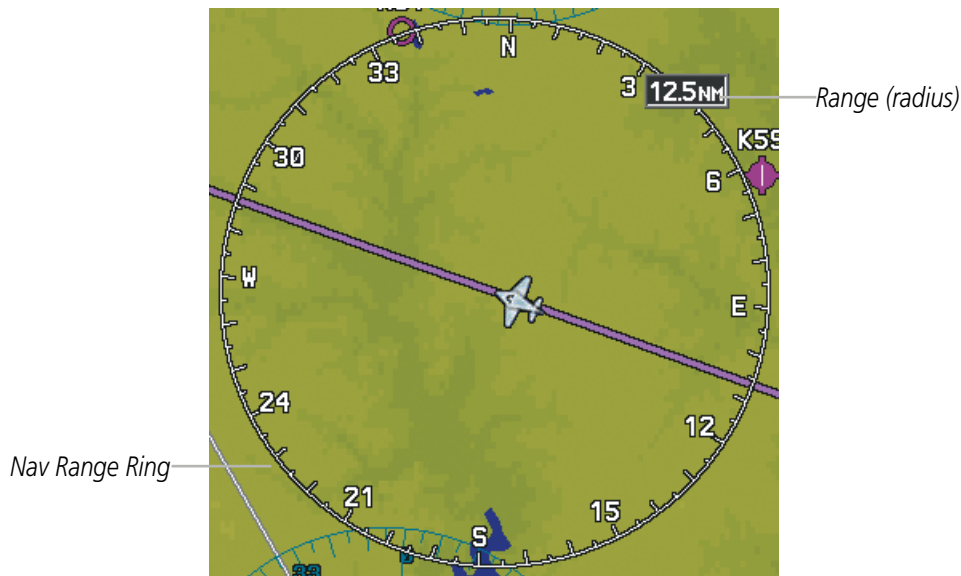

Figure 5-27 Navigation Map - Nav Range Ring



NOTE: The Nav Range Ring is not displayed on the Waypoint Information pages, Nearest pages, or Direct-to Window map.

Displaying/removing the Nav Range Ring:

- 1) Press the **MENU** Key with the Navigation Map Page displayed. The cursor flashes on the 'Map Setup' option.
- 2) Press the **ENT** Key. The Map Setup Menu is displayed.
- 3) Select the 'Map' group.
- 4) Press the **ENT** Key.
- 5) Highlight the 'NAV RANGE RING' field.
- 6) Select 'On' or 'Off'.
- 7) Press the **FMS** Knob to return to the Navigation Map Page.



NOTE: The Nav Range Ring is referenced to either magnetic or true north, based on the selection on the AUX - System Setup Page.

FUEL RANGE RING

The map can display a fuel range ring which shows the remaining flight distance. A dashed green circle indicates the selected range to reserve fuel. A solid green circle indicates the total endurance range. If only reserve fuel remains, the range is indicated by a solid yellow circle.

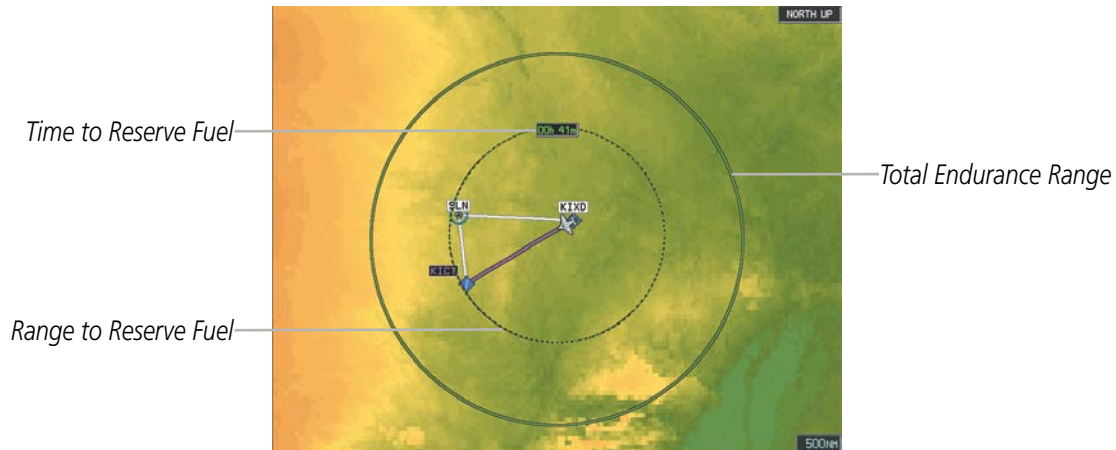

Figure 5-28 Navigation Map - Fuel Range Ring

Displaying/removing the fuel range ring and selecting a fuel range time:

- 1) Press the **MENU** Key with the Navigation Map Page displayed. The cursor flashes on the 'Map Setup' option.
- 2) Press the **ENT** Key. The Map Setup Menu is displayed.
- 3) Select the 'Map' group.
- 4) Press the **ENT** Key.
- 5) Highlight the 'FUEL RNG (RSV)' field.
- 6) Select 'On' or 'Off'.
- 7) Highlight the fuel reserve time field. This time should be set to the amount of flight time equal to the amount of fuel reserve desired.
- 8) To change the reserve fuel time, enter a time (00:00 to 23:59; hours:minutes). The default setting is 00:45 minutes.
- 9) Press the **ENT** Key.
- 10) Press the **FMS** Knob to return to the Navigation Map Page.

FIELD OF VIEW (SVS)

The map can display the boundaries of the PFD Synthetic Vision System (SVS) lateral field of view. The field of view is shown as two dashed lines forming a V shape in front of the aircraft symbol on the map. This is only available if SVS is installed on the aircraft.

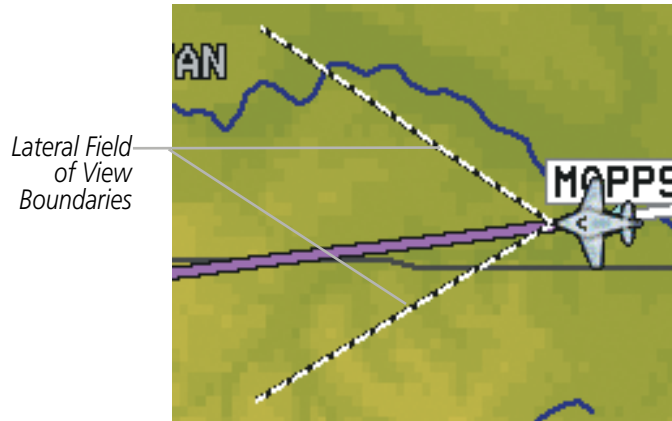

Figure 5-29 Navigation Map - Field of View

Displaying/removing the field of view:

- 1) Press the **MENU** Key with the Navigation Map Page displayed. The cursor flashes on the 'Map Setup' option.
- 2) Press the **ENT** Key. The Map Setup Menu is displayed.
- 3) Select the 'Map' group.
- 4) Press the **ENT** Key.
- 5) Highlight the 'FIELD OF VIEW' field.
- 6) Select 'On' or 'Off'.
- 7) Press the **FMS** Knob to return to the Navigation Map Page.

SELECTED ALTITUDE INTERCEPT ARC

The map can display the location along the current track where the aircraft will intercept the selected altitude. The location will be shown as a light blue arc when the aircraft is actually climbing or descending.

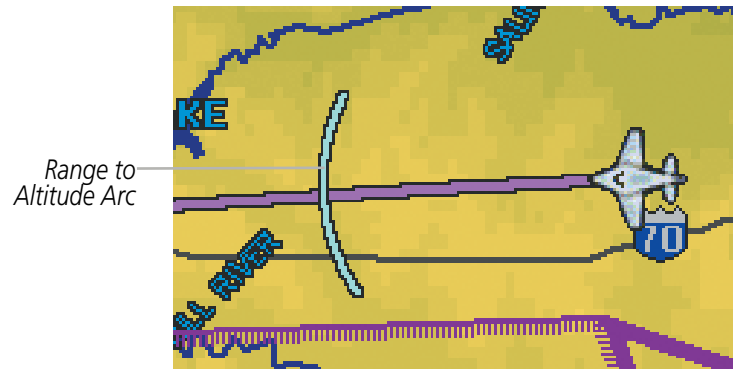

Figure 5-30 Navigation Map - Range to Altitude Arc

Displaying/removing the selected altitude intercept arc:

- 1) Press the **MENU** Key with the Navigation Map Page displayed. The cursor flashes on the 'Map Setup' option.
- 2) Press the **ENT** Key. The Map Setup Menu is displayed.
- 3) Select the 'Map' group.
- 4) Press the **ENT** Key.
- 5) Highlight the 'SEL ALT ARC' field.
- 6) Select 'On' or 'Off'.
- 7) Press the FMS Knob to return to the Navigation Map Page.

5.3 WAYPOINTS

Waypoints are predetermined geographical positions (internal database) or pilot-entered positions, and are used for all phases of flight planning and navigation.

Communication and navigation frequencies can be tuned “automatically” from various Waypoint Information (WPT) pages, Nearest (NRST) pages, and the Nearest Airports Window (on PFD). This auto-tuning feature simplifies frequency entry over manual tuning. Refer to the Audio Panel and CNS section for details on auto-tuning.

Waypoints can be selected by entering the ICAO identifier, entering the name of the facility, or by entering the city name. See the System Overview section for detailed instructions on entering data in the G1000. As a waypoint identifier, facility name, or location is entered, the G1000’s Spell’N’Find™ feature scrolls through the database, displaying those waypoints matching the characters which have been entered to that point. A direct-to navigation leg to the selected waypoint can be initiated by pressing the **Direct-to** Key on any of the waypoint pages.



Figure 5-31 Waypoint Information Window

If duplicate entries exist for the entered facility name or location, additional entries may be viewed by continuing to turn the small **FMS** Knob during the selection process. If duplicate entries exist for an identifier, a Duplicate Waypoints Window is displayed when the **ENT** Key is pressed.



Figure 5-32 Waypoint Information Window - Duplicate Identifier

AIRPORTS



NOTE: 'North Up' orientation on the Airport Information Page cannot be changed; the pilot needs to be aware of proper orientation if the Navigation Map orientation is different from the Airport Information Page Map.

The Airport Information Page is the first page in WPT group and allows the pilot to view airport information, load frequencies (COM, NAV, and lighting), review runways, and review instrument procedures that may be involved in the flight plan. See the Audio Panel and CNS Section for more information on loading frequencies (auto-tuning). After engine startup, the Airport Information Page defaults to the airport where the aircraft is located. After a flight plan has been loaded, it defaults to the destination airport. On a flight plan with multiple airports, it defaults to the airport which is the current active waypoint.

In addition to displaying a map of the currently selected airport and surrounding area, the Airport Information Page displays airport information in three boxes labeled 'AIRPORT', 'RUNWAYS', and 'FREQUENCIES'. For airports with multiple runways, information for each runway is available. This information is viewed on the Airport Information Page by pressing the INFO softkey until **INFO-1** is displayed.

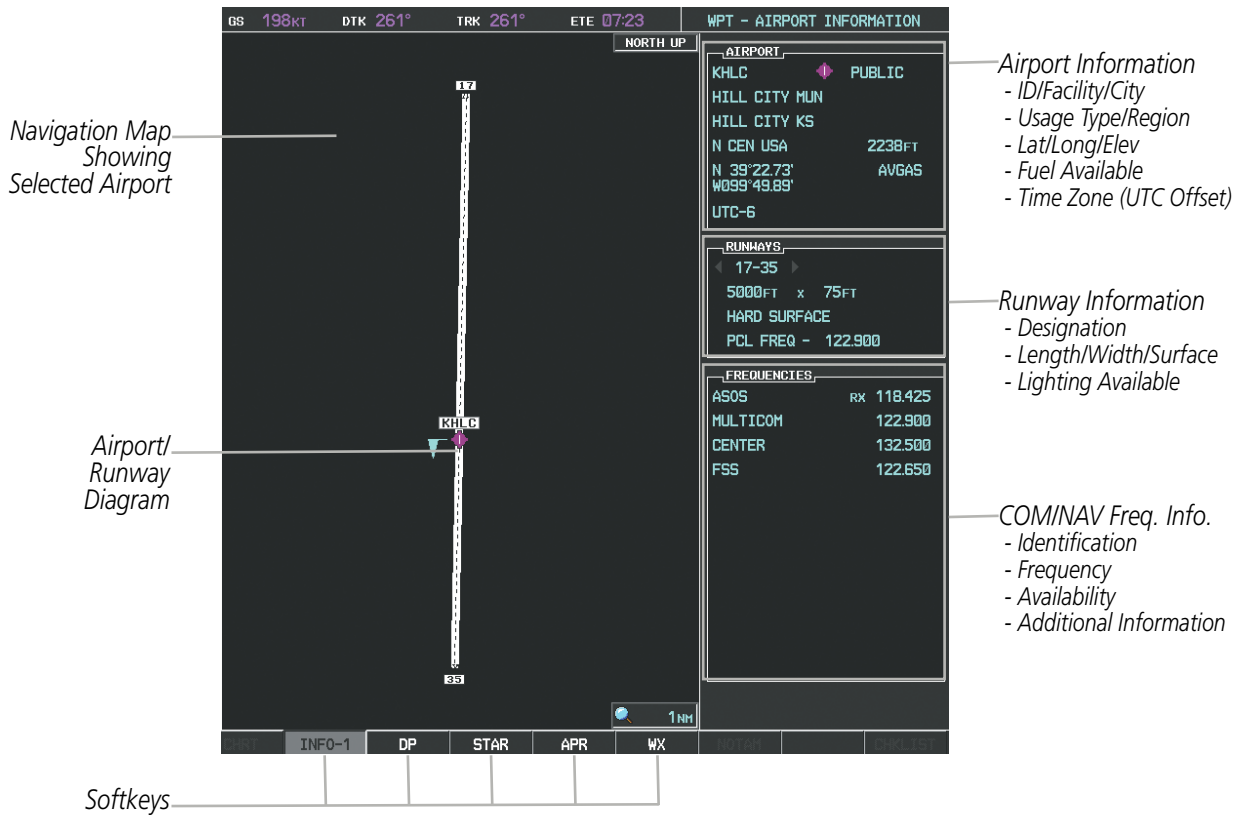

Figure 5-33 Airport Information Page

The following descriptions and abbreviations are used on the Airport Information Page:

- Usage type: Public, Military, Private, or Heliport
- Runway surface type: Hard, Turf, Sealed, Gravel, Dirt, Soft, Unknown, or Water
- Runway lighting type: No Lights, Part Time, Full Time, Unknown, or PCL Freq (for pilot-controlled lighting)
- COM Availability: TX (transmit only), RX (receive only), PT (part time), i (additional information available)

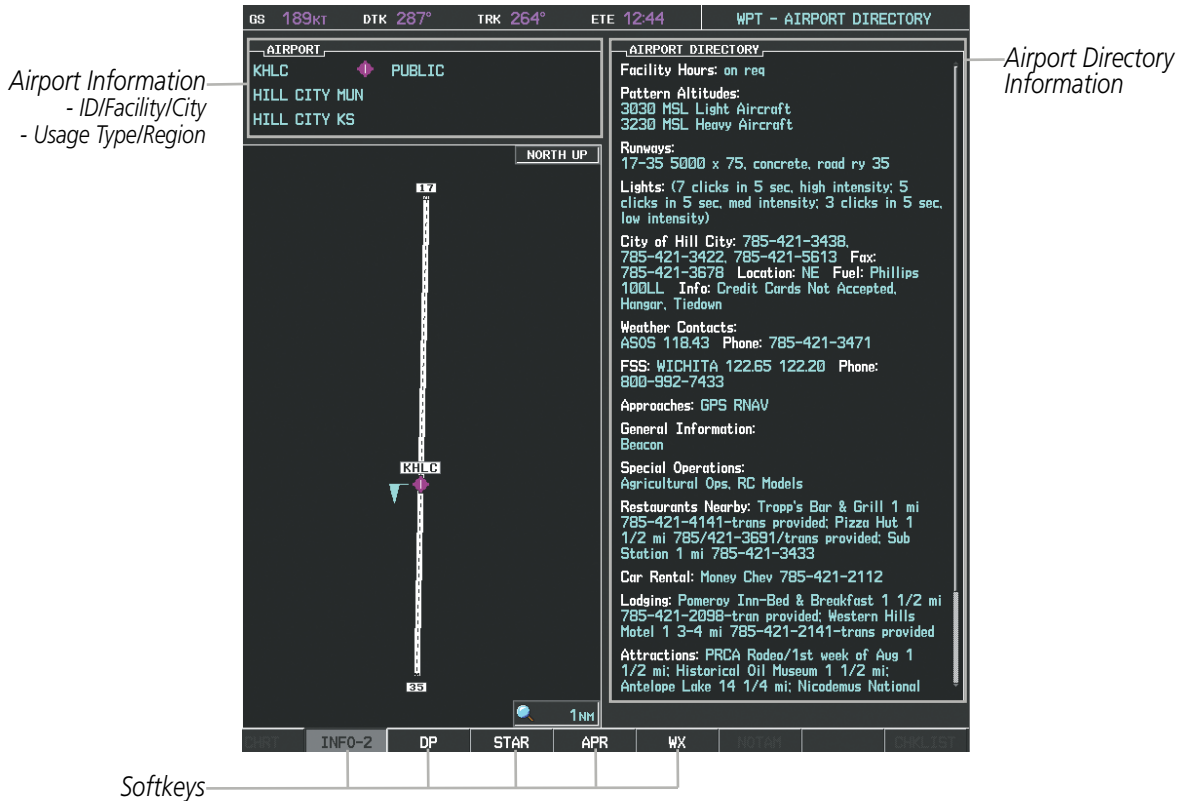

Figure 5-34 Airport Directory Page Example

The AOPA directory information is viewed on the Airport Directory Page by pressing the INFO softkey until **INFO-2** is displayed. The following are types of AOPA airport directory information shown (if available) on the Airport Directory Page:

- **Airport:** Identifier, Site Number, Name, City, State
- **Phones:** Phone/Fax Numbers
- **Hours:** Facility Hours, Light Hours, Tower Hours, Beacon Hours
- **Location:** Sectional, Magnetic Variation
- **Frequencies:** Type/Frequency
- **Transportation:** Ground Transportation Type Available
- **Approach:** Approach Facility Name, Frequency, Frequency Parameter
- **Traffic Pattern Altitudes (TPA):** Aircraft Class/Altitude
- **Weather:** Service Type, Frequency, Phone Number
- **Flight Service Station (FSS):** FSS Name, Phone Numbers
- **Instrument Approaches:** Published Approach, Frequency
- **NAVAIDS:** Type, Identifier, Frequency, Radial, Distance
- **Noise:** Noise Abatement Procedures
- **Charts:** Low Altitude Chart Number
- **Runway:** Headings, Length, Width, Obstructions, Surface
- **Obstructions:** General Airport Obstructions
- **Special Operations at Airport**
- **Services Available:** Category, Specific Service
- **Notes:** Airport Notes
- **Pilot Controlled Lighting:** High/Med/Low Clicks/Second
- **FBO:** Type, Frequencies, Services, Fees, Fuel, Credit Cards, Phone/Fax Numbers

Selecting an airport for review by identifier, facility name, or location:

- 1) From the Airport Information Page, press the **FMS** Knob.
- 2) Use the **FMS** Knobs and enter an identifier, facility name, or location.
- 3) Press the **ENT** Key.
- 4) Press the **FMS** Knob to remove the cursor.

Selecting a runway:

- 1) With the Airport Information Page displayed, press the **FMS** Knob to activate the cursor.
- 2) Turn the large **FMS** Knob to place the cursor in the 'RUNWAYS' Box, on the runway designator.
- 3) Turn the small **FMS** Knob to display the desired runway (if more than one) for the selected airport.
- 4) To remove the flashing cursor, press the **FMS** Knob.

Viewing a destination airport:

From the Airport Information Page press the **MENU** Key. Select 'View Destination Airport'. The Destination Airport is displayed.

The Airport Frequencies Box uses the descriptions and abbreviations listed in the following table:

Communication Frequencies			Navigation Frequencies
Approach *	Control	Pre-Taxi	ILS
Arrival *	CTA *	Radar	LOC
ASOS	Departure *	Ramp	
ATIS	Gate	Terminal *	
AWOS	Ground	TMA *	
Center	Helicopter	Tower	
Class B *	Multicom	TRSA *	
Class C *	Other	Unicom	
Clearance			
* May include Additional Information			

Table 5-5 Airport Frequency Abbreviations

A departure, arrival, or approach can be loaded using the softkeys on the Airport Information Page. See the Procedures section for details. METARs or TAFs applicable to the selected airport can be selected for display (see the Hazard Avoidance section for details about weather).

The G1000 provides a **NRST** Softkey on the PFD, which gives the pilot quick access to nearest airport information (very useful if an immediate landing is required). The Nearest Airports Window displays a list of up to 25 nearest airports (three entries can be displayed at one time). If there are more than three they are displayed in a scrollable list. If there are no nearest airports available, "NONE WITHIN 200NM" is displayed.



Figure 5-35 Nearest Airports Window on PFD

Pressing the **ENT** Key displays the PFD Airport Information Window for the highlighted airport. Pressing the **ENT** Key again returns to the Nearest Airports Window with the cursor on the next airport in the list. Continued presses of the **ENT** Key sequences through the information pages for all airports in the Nearest Airports list.

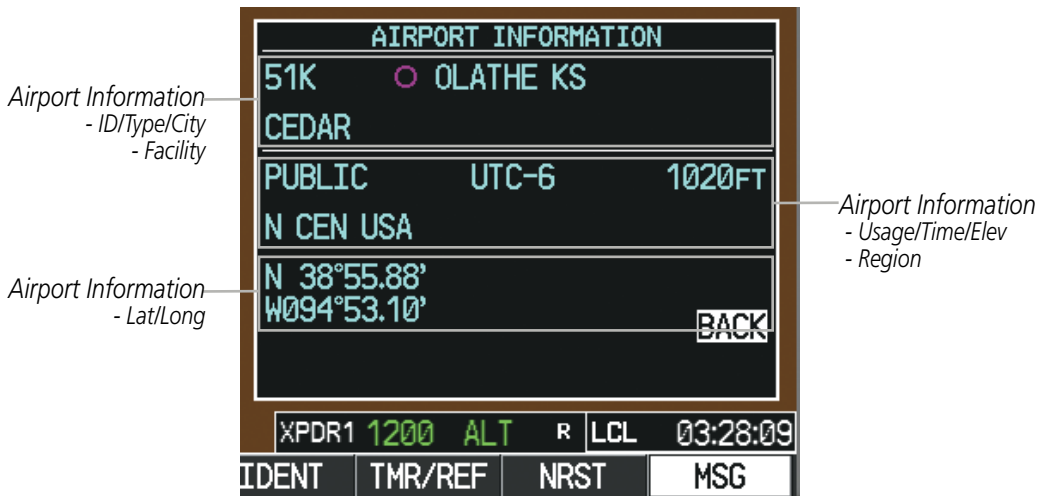

Figure 5-36 Airport Information Window on PFD

The Nearest Airports Page on the MFD is first in the group of NRST pages because of its potential use in the event of an in-flight emergency. In addition to displaying a map of the currently selected airport and surrounding area, the page displays nearest airport information in five boxes labeled 'NEAREST AIRPORTS', 'INFORMATION', 'RUNWAYS', 'FREQUENCIES', and 'APPROACHES'.

The selected airport is indicated by a white arrow, and a dashed white line is drawn on the navigation map from the aircraft position to the nearest airport. Up to four nearest airports, one runway, up to six frequencies, and up to six approaches are visible at one time. If there are more than can be shown, each list can be scrolled. If there are no items for display in a boxed area, text indicating that fact is displayed. The currently selected airport remains in the list until it is unselected.

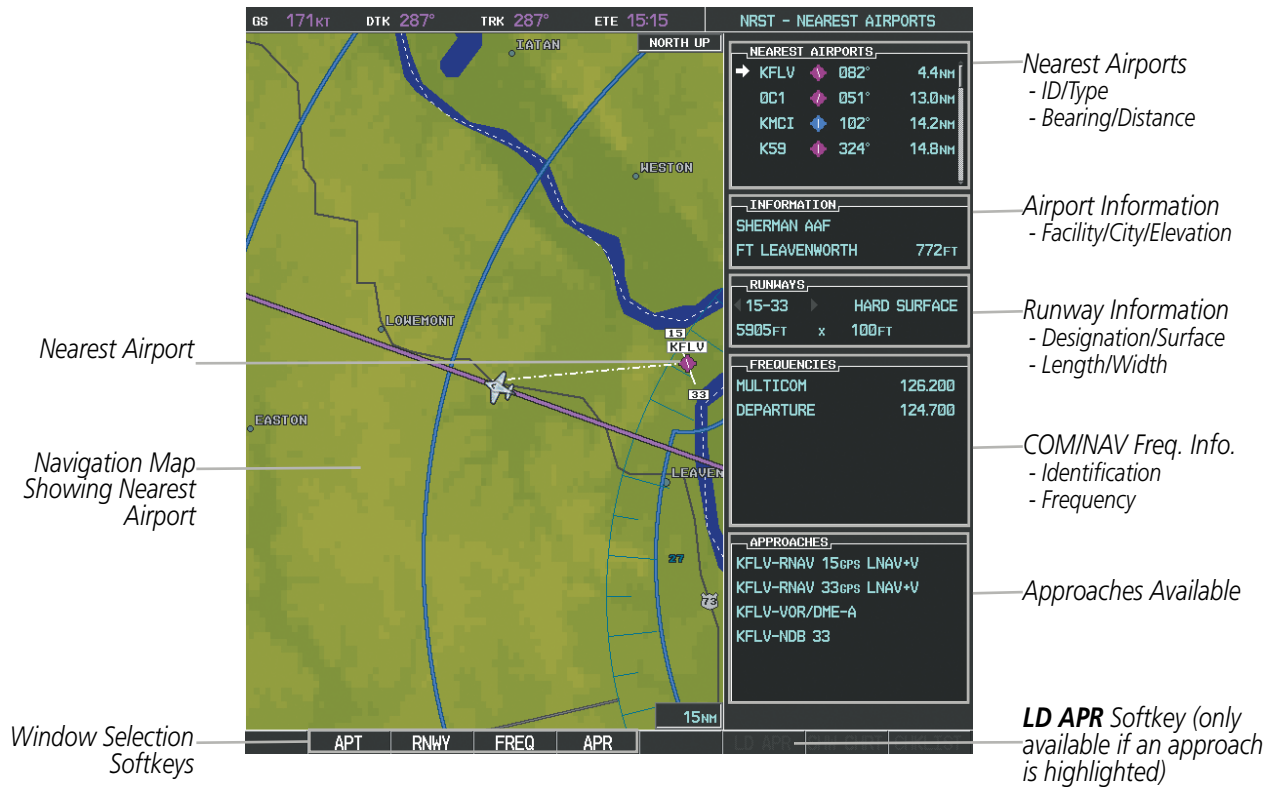

Figure 5-37 Nearest Airport Page

Viewing information for a nearest airport on the PFD:

- 1) Press the **NRST** Softkey to display the Nearest Airports Window. Press the **FMS** Knob to activate the cursor.
- 2) Highlight the airport identifier with the **FMS** Knob and press the **ENT** Key to display the Airport Information Window.
- 3) To return to the Nearest Airports Window press the **ENT** Key (with the cursor on 'BACK') or press the **CLR** Key. The cursor is now on the next airport in the nearest airports list. (Repeatedly pressing the **ENT** Key moves through the airport list, alternating between the Nearest Airports Window and the Airport Information Window.)
- 4) Press the **CLR** Key or the **NRST** Softkey to close the PFD Nearest Airports Window.

Viewing information for a nearest airport on the MFD:

- 1) Turn the large **FMS** Knob to select the NRST page group.
- 2) Turn the small **FMS** Knob to select the Nearest Airports Page (it is the first page of the group, so it may already be selected). If there are no Nearest Airports available, "NONE WITHIN 200 NM" is displayed.
- 3) Select the **APT** Softkey; or press the **FMS** Knob; or press the **MENU** Key, highlight 'Select Airport Window' and press the **ENT** Key. The cursor is placed in the 'NEAREST AIRPORTS' Box. The first airport in the nearest airports list is highlighted.
- 4) Turn the **FMS** Knob to highlight the desired airport. (Pressing the **ENT** Key also moves to the next airport.)
- 5) Press the **FMS** Knob to remove the flashing cursor.

Viewing runway information for a specific airport:

- 1) With the Nearest Airports Page displayed, select the **RNWX** Softkey; or press the **MENU** Key, highlight 'Select Runway Window'; and press the **ENT** Key. The cursor is placed in the 'RUNWAYS' Box.
- 2) Turn the small **FMS** Knob to select the desired runway.
- 3) Press the **FMS** Knob to remove the flashing cursor.

See the Audio Panel and CNS Section for frequency selection and the Procedures section for approaches.

The Nearest Airports Box on the System Setup Page defines the minimum runway length and surface type used when determining the 25 nearest airports to display on the MFD Nearest Airports Page. A minimum runway length and/or surface type can be entered to prevent airports with small runways or runways that are not appropriately surfaced from being displayed. Default settings are 0 feet (or meters) for runway length and "HARD/SOFT" for runway surface type.

Selecting nearest airport surface matching criteria:

- 1) Use the **FMS** Knob to select the System Setup Page.
- 2) Press the **FMS** Knob momentarily to activate the flashing cursor.
- 3) Turn the large **FMS** Knob to highlight the runway surface field in the Nearest Airports Box.
- 4) Turn the small **FMS** Knob to select the desired runway option (ANY, HARD ONLY, HARD/SOFT, WATER).
- 5) Press the **ENT** Key.
- 6) Press the **FMS** Knob to remove the flashing cursor.

Selecting nearest airport minimum runway length matching criteria:

- 1) Use the **FMS** Knob to select the System Setup Page.
- 2) Press the **FMS** Knob momentarily to activate the flashing cursor.
- 3) Turn the large **FMS** Knob to highlight the minimum length field in the Nearest Airport Box.
- 4) Use the **FMS** Knob to enter the minimum runway length (zero to 25,000 feet) and press the **ENT** Key.
- 5) Press the **FMS** Knob to remove the flashing cursor.

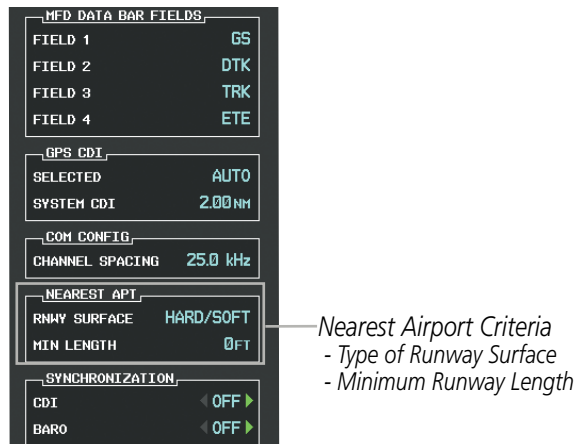

Figure 5-38 System Setup Page - Nearest Airport Selection Criteria

INTERSECTIONS



NOTE: The VOR displayed on the Intersection Information Page is the nearest VOR, not necessarily the VOR used to define the intersection.

The Intersection Information Page is used to view information about intersections. In addition to displaying a map of the currently selected intersection and surrounding area, the Intersection Information Page displays intersection information in three boxes labeled 'INTERSECTION', 'INFORMATION', and 'NEAREST VOR'.

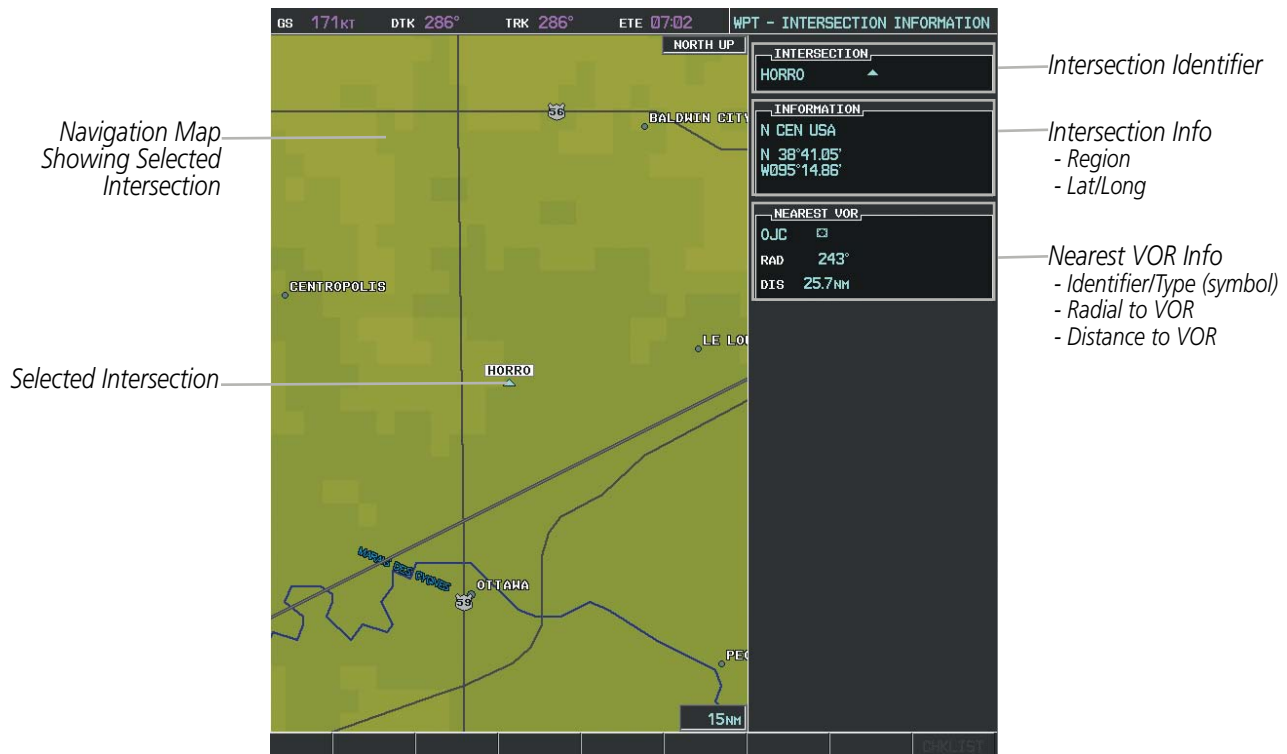

Figure 5-39 Intersection Information Page

Selecting an intersection:

- 1) With the Intersection Information Page displayed, enter an identifier in the Intersection Box.
- 2) Press the **ENT** Key.
- 3) Press the **FMS** Knob to remove the flashing cursor.

Or:

- 1) With the Nearest Intersections Page displayed, press the **FMS** Knob.
- 2) Press the **ENT** Key or turn either **FMS** Knob to select an identifier in the Nearest Intersection Box.
- 3) Press the **FMS** Knob to remove the flashing cursor.

The Nearest Intersections Page can be used to quickly find an intersection close to the flight path. In addition to displaying a map of the surrounding area, the page displays information for up to 25 nearest intersections in three boxes labeled 'NEAREST INT', 'INFORMATION', and 'REFERENCE VOR'.

The selected intersection is indicated by a white arrow. Up to seventeen intersections are visible at a time. If there are more than can be shown, the list can be scrolled. If there are no items for display, text indicating that fact is displayed



NOTE: The list only includes waypoints that are within 200 nm.

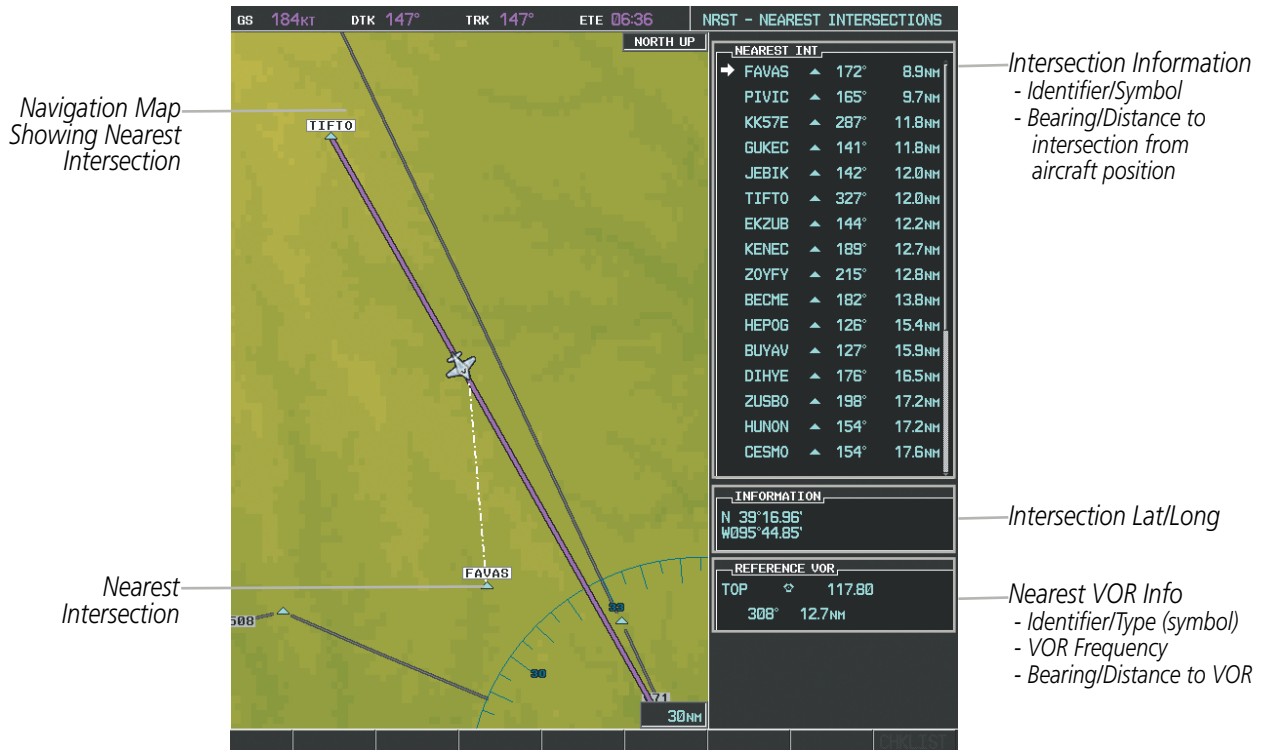

Figure 5-40 Nearest Intersections Page

NDBs

The NDB Information Page is used to view information about NDBs. In addition to displaying a map of the currently selected NDB and surrounding area, the page displays NDB information in four boxes labeled 'NDB', 'INFORMATION', 'FREQUENCY', and 'NEAREST AIRPORT'.

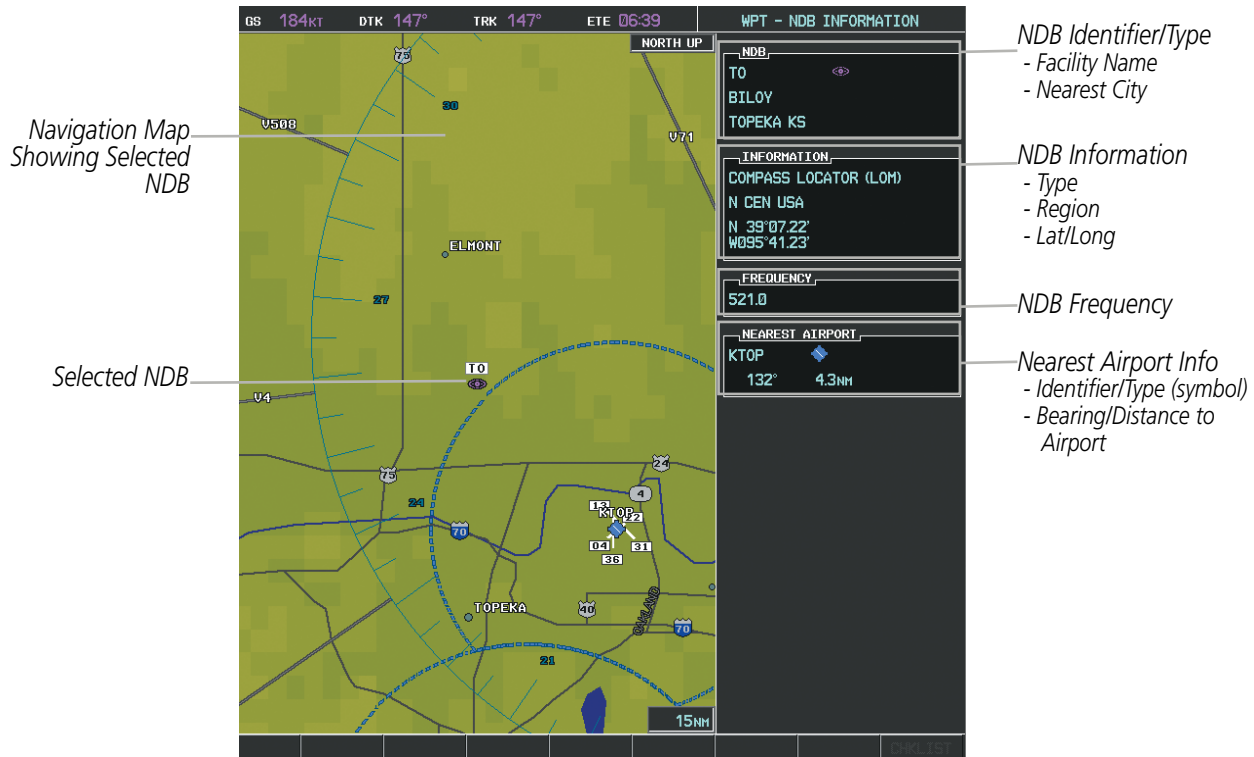

Figure 5-41 NDB Information Page



NOTE: Locator Outer Marker (LOM), Locator Middle Marker (LMM): a low power, low or medium frequency radio beacon installed in conjunction with the instrument landing system. When LOM is used, the locator is at the Outer Marker; when LMM is used, the locator is at the Middle Marker.

Selecting an NDB:

- 1) With the NDB Information Page displayed, enter an identifier, the name of the NDB, or the city in which it's located in the NDB Box.
 - 2) Press the **ENT** Key.
 - 3) Press the **FMS** Knob to remove the flashing cursor.
- Or:**
- 1) With the Nearest NDB Page displayed, press the **FMS** Knob.
 - 2) Press the **ENT** Key or turn either **FMS** Knob to select an identifier in the Nearest NDB Box.
 - 3) Press the **FMS** Knob to remove the flashing cursor.

The Nearest NDB Page can be used to quickly find a NDB close to the flight path. In addition to displaying a map of the surrounding area, the page displays information for up to 25 nearest NDBs in three boxes labeled 'NEAREST NDB', 'INFORMATION', and 'FREQUENCY'.

A white arrow before the NDB identifier indicates the selected NDB. Up to sixteen NDBs are visible at a time. If there are more than can be shown, each list can be scrolled. The list only includes waypoints that are within 200nm. If there are no NDBs in the list, text indicating that there are no nearest NDBs is displayed. If there are no nearest NDBs in the list, the information and frequency fields are dashed.

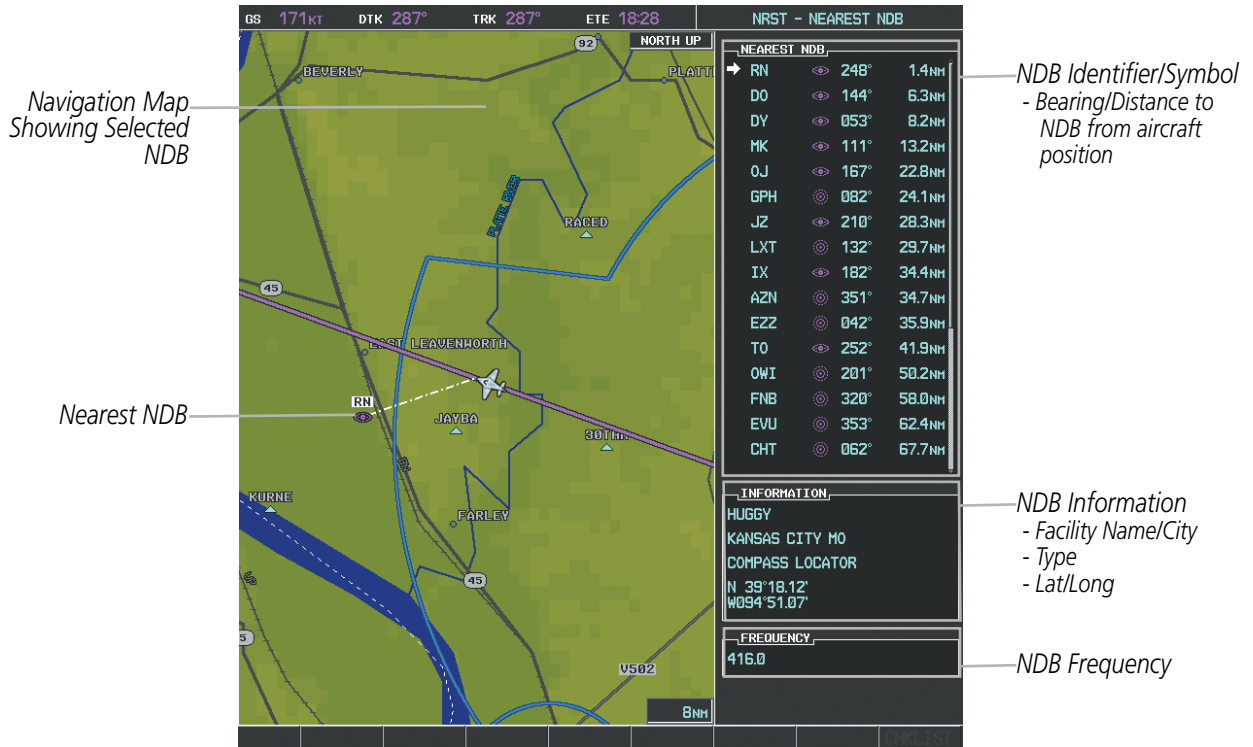

Figure 5-42 Nearest NDB Page

VORs

The VOR Information Page can be used to view information about VOR and ILS signals (since ILS signals can be received on a NAV receiver), or to quickly auto-tune a VOR or ILS frequency. Localizer information cannot be viewed on the VOR Information Page. If a VOR station is combined with a TACAN station it is listed as a VORTAC on the VOR Information Page and if it includes only DME, it is displayed as VOR-DME.

In addition to displaying a map of the currently selected VOR and surrounding area, the VOR Information Page displays VOR information in four boxes labeled 'VOR', 'INFORMATION', 'FREQUENCY', and 'NEAREST AIRPORT'.

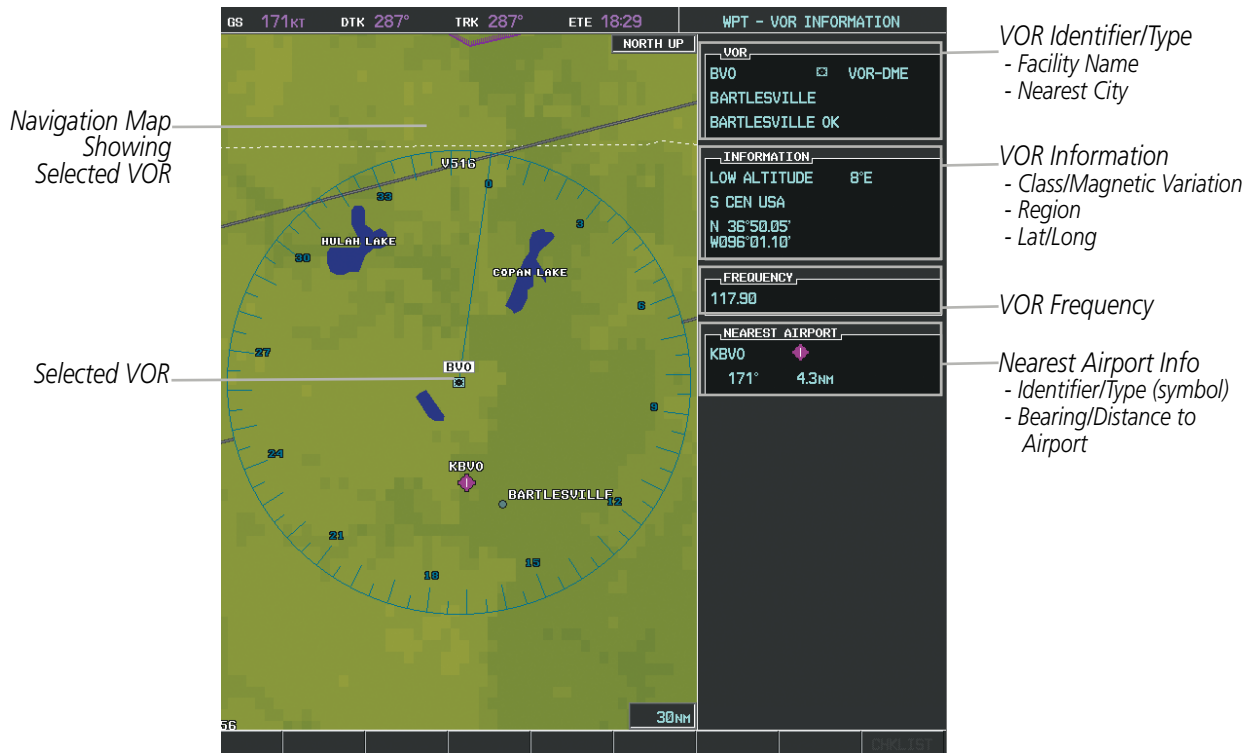

Figure 5-43 VOR Information Page

The VOR classes used in the VOR information box are: LOW ALTITUDE, HIGH ALTITUDE, and TERMINAL.

Selecting a VOR:

- 1) With the VOR Information Page displayed, enter an identifier, the name of the VOR, or the city in which it's located in the VOR Box.
 - 2) Press the **ENT** Key.
 - 3) Press the **FMS** Knob to remove the flashing cursor.
- Or:**
- 1) With the Nearest VOR Page displayed, press the **FMS** Knob or select the **VOR** Softkey.
 - 2) Press the **ENT** Key or turn either **FMS** Knob to select an identifier in the Nearest VOR Box.
 - 3) Press the **FMS** Knob to remove the flashing cursor.

Or:

- 1) With the Nearest VOR Page displayed, press the **MENU** Key.
- 2) Highlight 'Select VOR Window', and press the **ENT** Key.
- 3) Press the **ENT** Key or turn either **FMS** Knob to select an identifier in the Nearest VOR Box.
- 4) Press the **FMS** Knob to remove the flashing cursor.

The Nearest VOR Page can be used to quickly find a VOR station close to the aircraft. Also, a NAV frequency from a selected VOR station can be loaded from the Nearest VOR Page. In addition to displaying a map of the surrounding area, the Nearest VOR Page displays information for up to 25 nearest VOR stations in three boxes labeled 'NEAREST VOR', 'INFORMATION', and 'FREQUENCY'. The list only includes waypoints that are within 200 nm.

A white arrow before the VOR identifier indicates the selected VOR. Up to sixteen VORs are visible at a time. If there are more than can be shown, each list can be scrolled. If there are no VORs in the list, text indicating that there are no nearest VORs is displayed. If there are no nearest VORs in the list, the information is dashed.



Figure 5-44 Nearest VOR Page

USER WAYPOINTS

The G1000 can create and store up to 1,000 user-defined waypoints. User waypoints can be created from any map page (except PFD Inset Map, AUX-Trip Planning Page, or Procedure Pages) by selecting a position on the map using the **Joystick**, or from the User Waypoint Information Page by referencing a bearing/distance from an existing waypoint, bearings from two existing waypoints, or latitude and longitude. Once a waypoint has been created, it can be renamed, deleted, or moved. Temporary user waypoints are erased upon system power down.

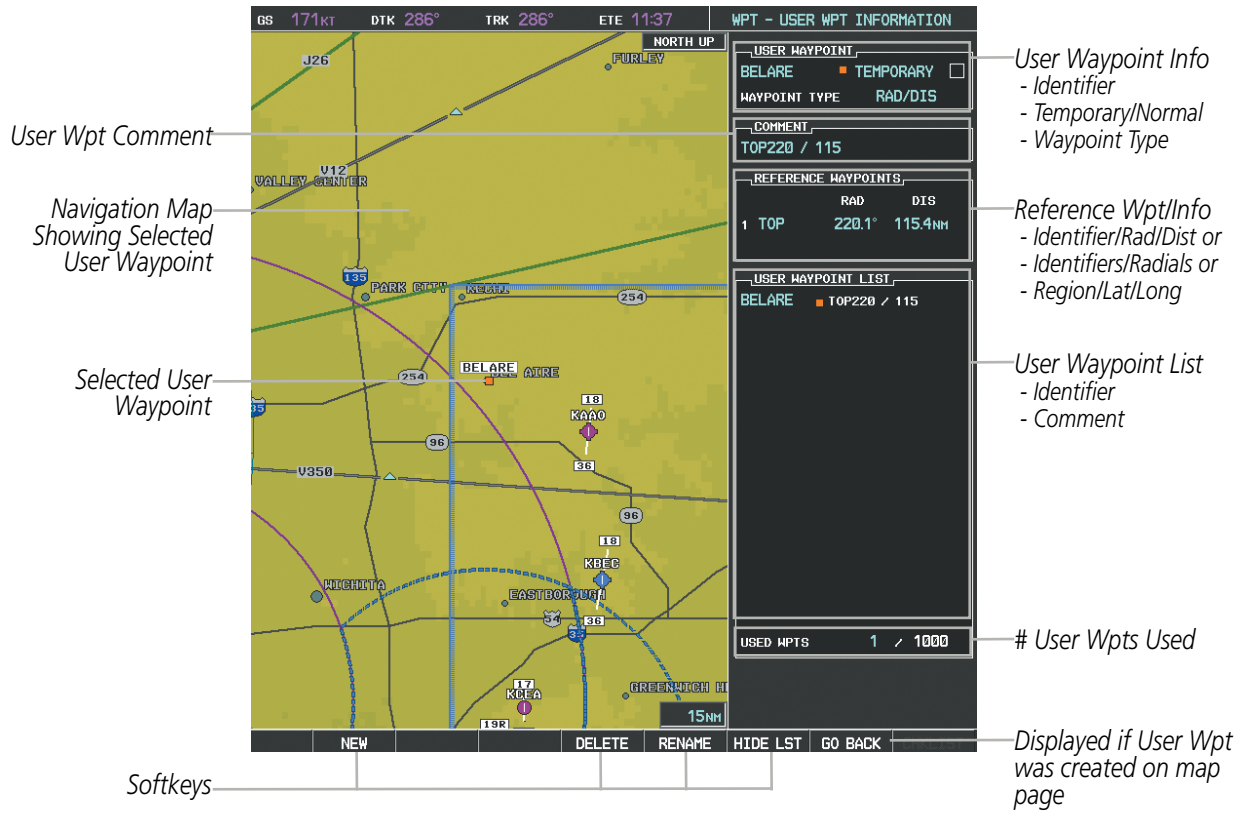

Figure 5-45 User Waypoint Information Page

Selecting a User Waypoint:

- 1) With the User Waypoint Information Page displayed, enter the name of the User Waypoint, or scroll to the desired waypoint in the User Waypoint List using the large **FMS** Knob.
 - 2) Press the **ENT** Key.
 - 3) Press the **FMS** Knob to remove the flashing cursor.
- Or:**
- 1) With the Nearest User Waypoints Page displayed, press the **FMS** Knob.
 - 2) Press the **ENT** Key or turn either **FMS** Knob to select an identifier in the Nearest USR Box.
 - 3) Press the **FMS** Knob to remove the flashing cursor.

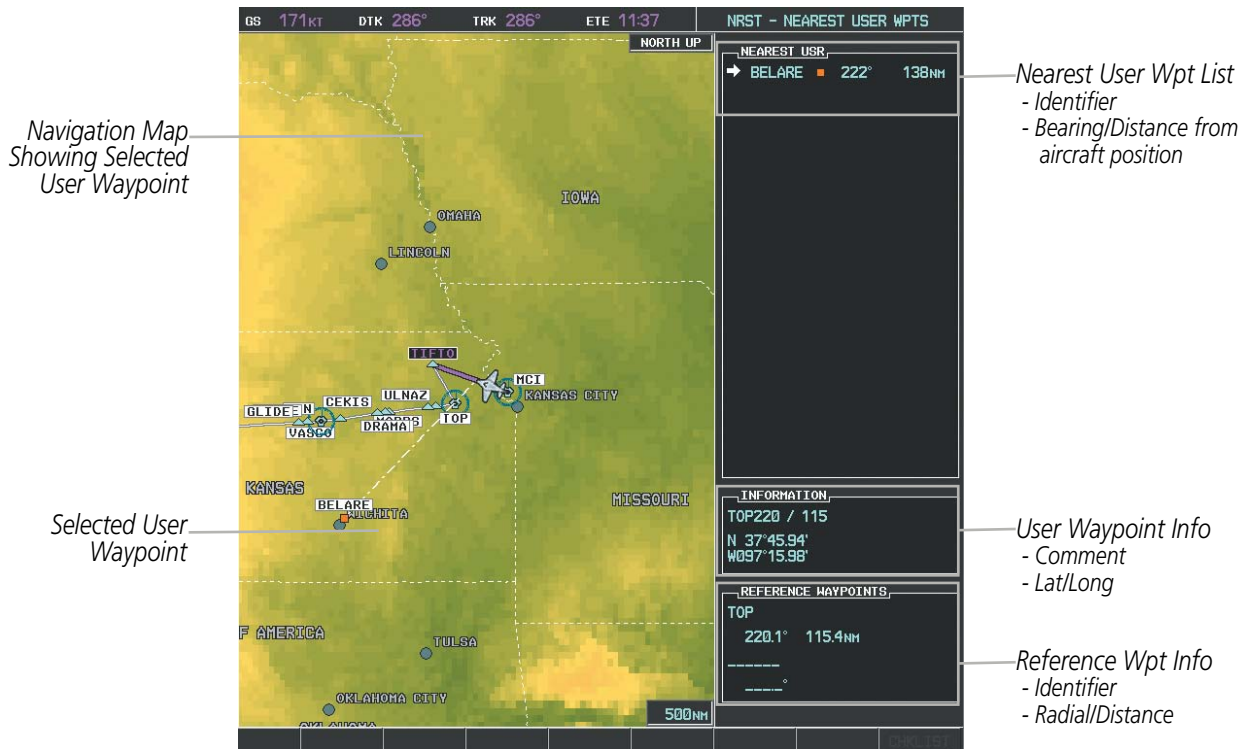

Figure 5-46 Nearest User Waypoint Page

CREATING USER WAYPOINTS

User waypoints can be created from the User Waypoint Information Page in the following ways:

Creating user waypoints from the User Waypoint Information Page:

- 1) Select the **NEW** Softkey, or press the **MENU** Key and select 'Create New User Waypoint'.
- 2) Enter a user waypoint name (up to six characters).
- 3) Press the **ENT** Key. The current aircraft position is the default location of the new waypoint.
- 4) If desired, define the type and location of the waypoint in one of the following ways:
 - a) Select "RAD/RAD" using the small **FMS** Knob, press the **ENT** Key, and enter the two reference waypoint identifiers and radials into the REFERENCE WAYPOINTS window using the **FMS** Knobs.
 - Or:
 - b) Select "RAD/DIS" using the small **FMS** Knob, press the **ENT** Key, and enter the reference waypoint identifier, the radial, and the distance into the REFERENCE WAYPOINTS window using the **FMS** Knobs.
 - Or:
 - c) Select "LAT/LON" using the small **FMS** Knob, press the **ENT** Key, and enter the latitude and longitude into the INFORMATION window using the **FMS** Knobs.
- 5) Press the **ENT** Key to accept the new waypoint.

- 6) If desired, change the storage method of the waypoint to "TEMPORARY" or "NORMAL" by moving the cursor to "TEMPORARY" and selecting the **ENT** Key to check or uncheck the box.
- 7) Press the **FMS** Knob to remove the flashing cursor.
 - Or:**
 - 1) Press the **FMS** Knob to activate the cursor.
 - 2) Enter a user waypoint name (up to six characters).
 - 3) Press the **ENT** Key. The message 'Are you sure you want to create the new User Waypoint AAAAAA?' is displayed.
 - 4) With 'YES' highlighted, press the **ENT** Key.
 - 5) If desired, define the type and location of the waypoint in one of the following ways:
 - a) Select "RAD/RAD" using the small **FMS** Knob, press the **ENT** Key, and enter the two reference waypoint identifiers and radials into the REFERENCE WAYPOINTS window using the **FMS** Knobs.
 - Or:**
 - b) Select "RAD/DIS" using the small **FMS** Knob, press the **ENT** Key, and enter the reference waypoint identifier, the radial, and the distance into the REFERENCE WAYPOINTS window using the **FMS** Knobs.
 - Or:**
 - c) Select "LAT/LON" using the small **FMS** Knob, press the **ENT** Key, and enter the latitude and longitude into the INFORMATION window using the **FMS** Knobs.
 - 6) Press the **ENT** Key to accept the new waypoint.
 - 7) If desired, change the storage method of the waypoint to "TEMPORARY" or "NORMAL" by moving the cursor to "TEMPORARY" and selecting the **ENT** Key to check or uncheck the box.
 - 8) Press the **FMS** Knob to remove the flashing cursor.

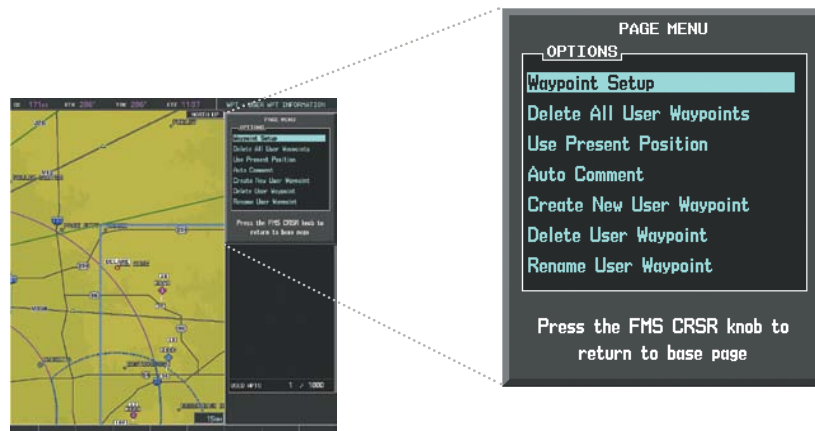

Figure 5-47 User Waypoint Information Page Menu

Creating user waypoints from map pages:

- 1) Press the **Joystick** to activate the panning function and pan to the map location of the desired user waypoint.
- 2) Press the **ENT** Key. The User Waypoint Information Page is displayed with the captured position.



NOTE: If the pointer has highlighted a map database feature, one of three things happens upon pressing the **ENT** Key: 1) information about the selected feature is displayed instead of initiating a new waypoint, 2) a menu pops up allowing a choice between 'Review Airspaces' or 'Create User Waypoint', or 3) a new waypoint is initiated with the default name being the selected map item.

- 3) Enter a user waypoint name (up to six characters).
- 4) Press the **ENT** Key to accept the selected name. The first reference waypoint box is highlighted.
- 5) If desired, define the type and location of the waypoint in one of the following ways:
 - a) Select "RAD/RAD" using the small **FMS** Knob, press the **ENT** Key, and enter the two reference waypoint identifiers and radials into the REFERENCE WAYPOINTS window using the **FMS** Knobs.
Or:
 - b) Select "RAD/DIS" using the small **FMS** Knob, press the **ENT** Key, and enter the reference waypoint identifier, the radial, and the distance into the REFERENCE WAYPOINTS window using the **FMS** Knobs.
Or:
 - c) Select "LAT/LON" using the small **FMS** Knob, press the **ENT** Key, and enter the latitude and longitude into the INFORMATION window using the **FMS** Knobs.
- 6) Press the **ENT** Key to accept the new waypoint.
- 7) If desired, change the storage method of the waypoint to "TEMPORARY" or "NORMAL" by moving the cursor to "TEMPORARY" and selecting the **ENT** Key to check or uncheck the box.
- 8) Press the **FMS** Knob to remove the flashing cursor.
- 9) Press the **GO BACK** Softkey to return to the map page.

EDITING USER WAYPOINTS

Editing a user waypoint comment or location:

- 1) With the User Waypoint Information Page displayed, press the **FMS** Knob to activate the cursor.
- 2) Select a user waypoint in the User Waypoint List, if required, and press the **ENT** Key.
- 3) Move the cursor to the desired field.
- 4) Turn the small **FMS** Knob to make any changes.
- 5) Press the **ENT** Key to accept the changes.
- 6) Press the **FMS** Knob to remove the flashing cursor.

Renaming user waypoints:

- 1) Highlight a user waypoint in the User Waypoint List. Select the **RENAME** Softkey, or press the **MENU** Key and select 'Rename User Waypoint'.
- 2) Enter a new name.
- 3) Press the **ENT** Key. The message 'Do you want to rename the user waypoint AAAAAA toBBBBBB?' is displayed.
- 4) With 'YES' highlighted, press the **ENT** Key.
- 5) Press the **FMS** Knob to remove the flashing cursor.

Changing the location of an existing waypoint to the aircraft present position:

- 1) Enter a waypoint name or select the waypoint in the User Waypoint List, then press the **ENT** Key.
- 2) Press the **MENU** Key.
- 3) Select 'Use Present Position'.
- 4) Press the **ENT** Key twice. The new waypoint's location is saved.
- 5) Press the **FMS** Knob to remove the flashing cursor.

A system generated comment for a user waypoint incorporates the reference waypoint identifier, bearing, and distance. If a system generated comment has been edited, a new comment can be generated.

Resetting the comment field to the system generated comment:

- 1) Enter a waypoint name or select the waypoint in the User Waypoint List, then press the **ENT** Key.
- 2) Press the **MENU** Key.
- 3) Select 'Auto Comment'.
- 4) Press the **ENT** Key. The generated comment is based on the reference point used to define the waypoint.

The default type of user waypoint (normal or temporary) can be changed using the user waypoint information page menu. Temporary user waypoints are automatically deleted upon the next power cycle.

Changing the user waypoint storage duration default setting:

- 1) With the User Waypoint Information Page displayed, press the **MENU** Key.
- 2) Move the cursor to select 'Waypoint Setup', and press the **ENT** Key.
- 3) Select 'NORMAL' or 'TEMPORARY' as desired, and press the **ENT** Key.
- 4) Press the **FMS** Knob to remove the flashing cursor and return to the User Waypoint Information Page.

DELETING USER WAYPOINTS

Deleting a single user waypoint:

- 1) Highlight a User Waypoint in the User Waypoint List, or enter a waypoint in the User Waypoint field.
- 2) Select the **DELETE** Softkey or press the **CLR** Key. 'Yes' is highlighted in the confirmation window.
- 3) Press the **ENT** Key.
- 4) Press the **FMS** Knob to remove the flashing cursor.

Or:

- 1) Highlight a User Waypoint in the User Waypoint List, or enter a waypoint in the User Waypoint field.
- 2) Press the **MENU** Key.
- 3) Select 'Delete User Waypoint'.
- 4) Press the **ENT** Key twice to confirm the selection.
- 5) Press the **FMS** Knob to remove the flashing cursor.



NOTE: *The option to 'Delete All User Waypoints' is not available while the aircraft is in flight.*

Deleting all user waypoints:

- 1) Highlight a User Waypoint in the User Waypoint List.
- 2) Press the **MENU** Key.
- 3) Select 'Delete All User Waypoints'.
- 4) Press the **ENT** Key twice to confirm the selection.
- 5) Press the **FMS** Knob to remove the flashing cursor.

5.4 AIRSPACES

The G1000 can display the following types of airspaces: Class B/TMA, Class C/TCA, Class D, Restricted, MOA (Military), Other Airspace, Air Defense Interdiction Zone (ADIZ), and Temporary Flight Restriction (TFR).

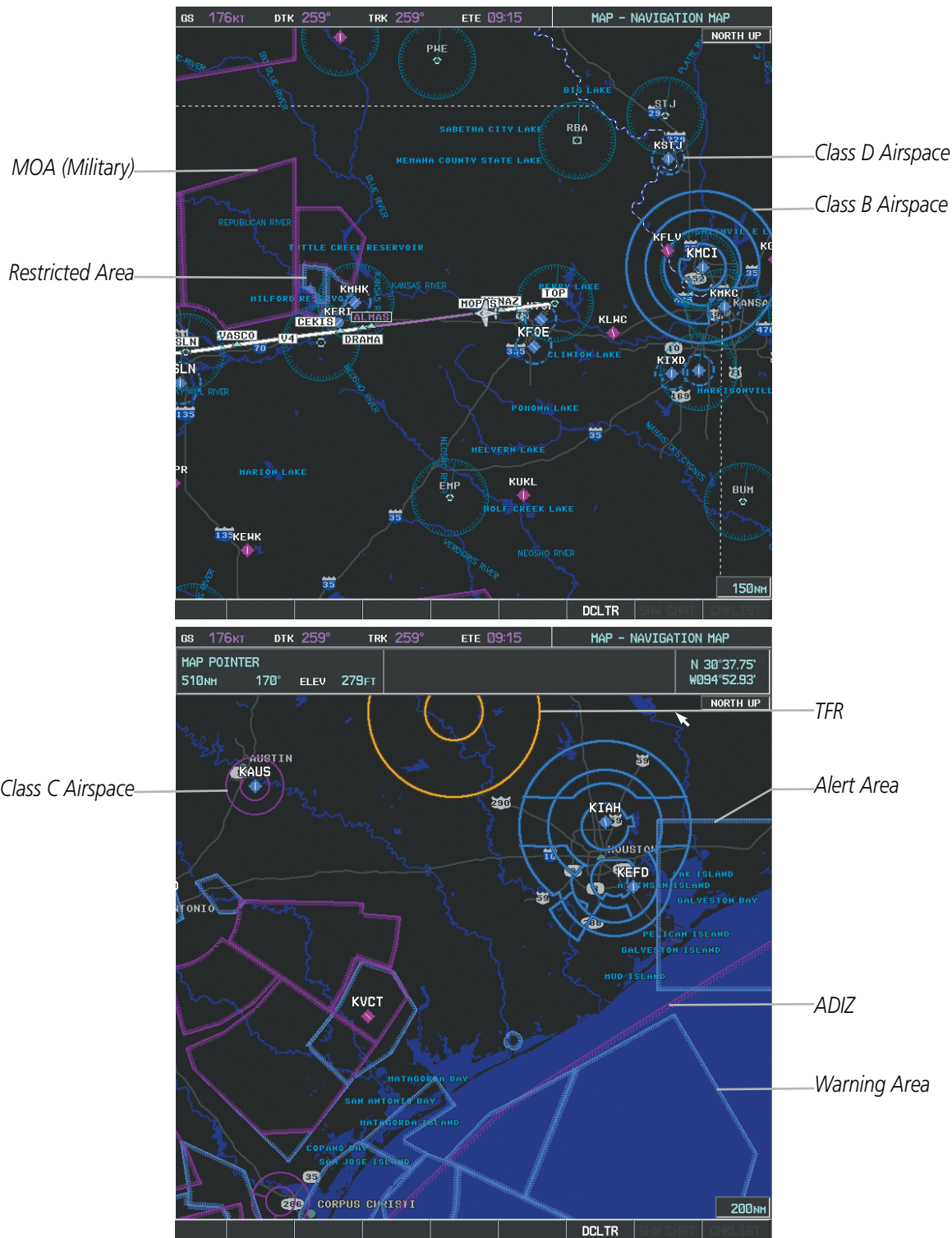

Figure 5-48 Airspaces

The Nearest Airspaces Page, Airspace Alerts Window, and Airspace Alerts on the PFD provide additional information about airspaces and the location of the aircraft in relationship to them.

The Airspace Alerts Box allows the pilot to turn the controlled/special-use airspace message alerts on or off. This does not affect the alerts listed on the Nearest Airspaces Page or the airspace boundaries depicted on the Navigation Map Page. It simply turns on/off the warning provided when the aircraft is approaching or near an airspace.

An altitude buffer is also provided which “expands” the vertical range above or below an airspace. For example, if the buffer is set at 500 feet, and the aircraft is more than 500 feet above/below an airspace, an alert message is not generated, but if the aircraft is less than 500 feet above/below an airspace and projected to enter it, the pilot is notified with an alert message. The default setting for the altitude buffer is 200 feet.

Changing the altitude buffer distance setting:

- 1) Use the **FMS** Knob to select the AUX - System Setup Page.
- 2) Press the **FMS** Knob momentarily to activate the flashing cursor.
- 3) Turn the large **FMS** Knob to highlight the altitude buffer field in the Airspace Alerts Box.
- 4) Use the **FMS** Knob to enter an altitude buffer value and press the **ENT** Key.
- 5) Press the **FMS** Knob to remove the flashing cursor.

Turning an airspace alert on or off:

- 1) Use the **FMS** Knob to select the AUX - System Setup Page.
- 2) Press the **FMS** Knob momentarily to activate the flashing cursor.
- 3) Turn the large **FMS** Knob to highlight the desired field in the Airspace Alerts Box.
- 4) Turn the small **FMS** Knob clockwise to turn the airspace alert ON or counterclockwise to turn the alert OFF.
- 5) Press the **FMS** Knob to remove the flashing cursor.

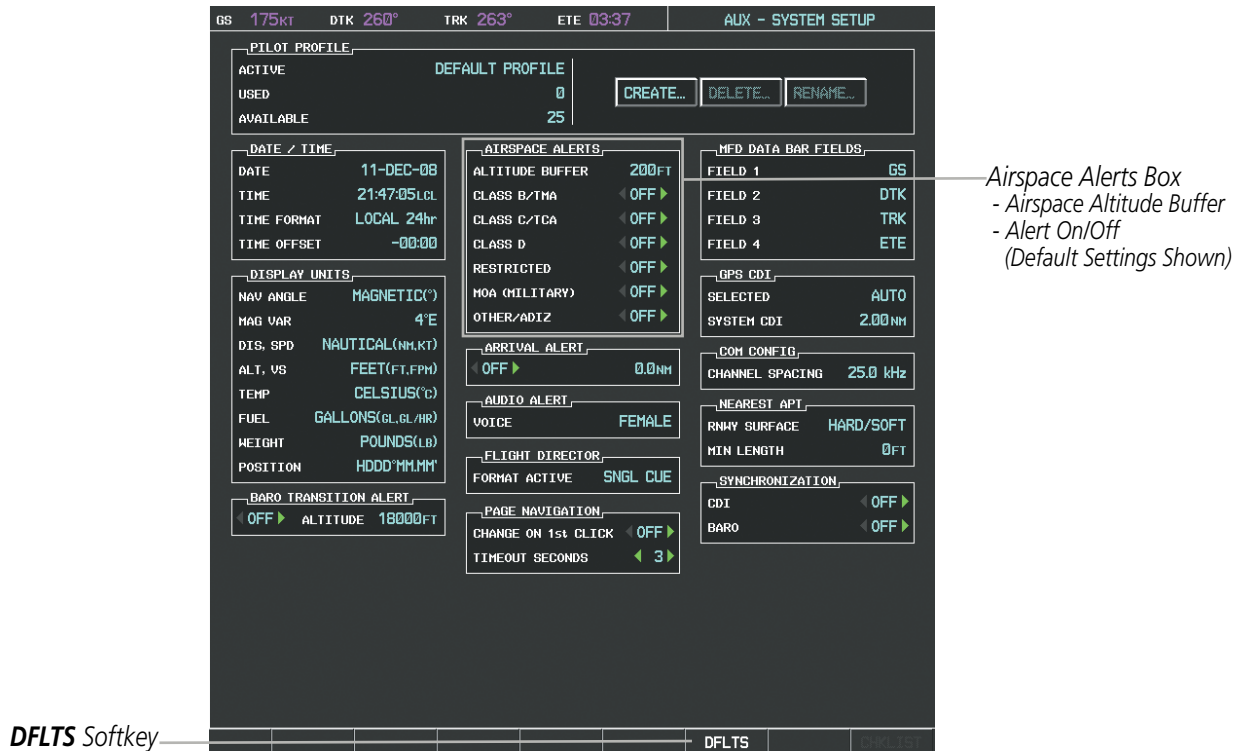

Figure 5-49 System Setup Page - Airspace Alerts

Map ranges for the airspace boundaries are selected from the Aviation Group in the Map Setup Menu. See Table 5-2 for the default and maximum ranges for each type of airspace and the symbol used to define the airspace area.

The Nearest Airspaces Page can be used to quickly find airspaces close to the flight path. In addition, a selected frequency associated with the airspace can be loaded from the Nearest Airspaces Page. In addition to displaying a map of airspace boundaries and surrounding area, the Nearest Airspaces Page displays airspace information in four boxes labeled 'AIRSPACE ALERTS', 'AIRSPACE, AGENCY', 'VERTICAL LIMITS', and 'FREQUENCIES'.

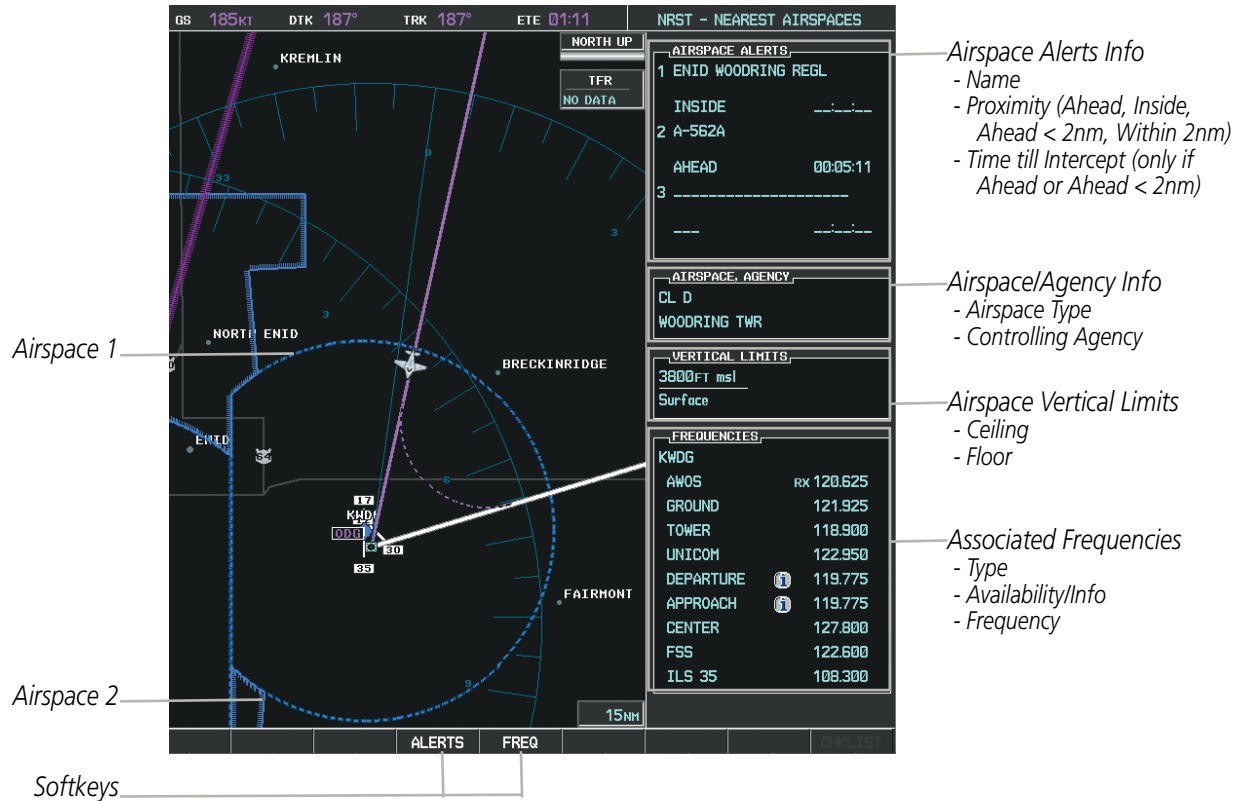

Figure 5-50 Nearest Airspaces Page

Airspace alerts and associated frequencies are shown in scrollable lists on the Nearest Airspaces Page. The **ALERTS** and **FREQ** softkeys place the cursor in the respective list. The **FREQ** Softkey is enabled only if one or more frequencies exist for a selected airspace.

Selecting and viewing an airspace alert with its associated information:

- 1) Select the Nearest Airspaces Page.
- 2) Select the **ALERTS** Softkey; or press the **FMS** Knob; or press the **MENU** Key, highlight 'Select Alerts Window', and press the **ENT** Key. The cursor is placed in the 'AIRSPACE ALERTS' Box.
- 3) Select the desired airspace.
- 4) Press the **FMS** Knob to remove the flashing cursor.

Pressing the PFD **MSG** Softkey displays the message window on the PFD. The following airspace alerts are displayed in the message window:

Message	Comments
INSIDE ARSPC – Inside airspace.	The aircraft is inside the special use airspace.
ARSPC AHEAD – Airspace ahead – less than 10 minutes.	Special use airspace is ahead of aircraft. The aircraft penetrates the airspace within 10 minutes.
ARSPC NEAR – Airspace near and ahead.	Special use airspace is near and ahead of the aircraft position.
ARSPC NEAR – Airspace near – less than 2 nm.	Special use airspace is within 2 nm of the aircraft position.

Table 5-6 PFD Airspace Alert Messages

5.5 DIRECT-TO-NAVIGATION

The Direct-to method of navigation, initiated by pressing the **Direct-to** Key on either the MFD or PFD, is quicker to use than a flight plan when the desire is to navigate to a single point such as a nearby airport.

Once a direct-to is activated, the G1000 establishes a point-to-point course line from the present position to the selected direct-to destination. Course guidance is provided until the direct-to is replaced with a new direct-to or flight plan, or cancelled.

A vertical navigation (VNV) direct-to creates a descent path (and provides guidance to stay on the path) from the current altitude to a selected altitude at the direct-to waypoint. Vertical navigation is based on barometric altitudes, not on GPS altitude, and is used for cruise and descent phases of flight.

The Direct-to Window allows selection and activation of direct-to navigation. The Direct-to Window displays selected direct-to waypoint data on the PFD and the MFD.

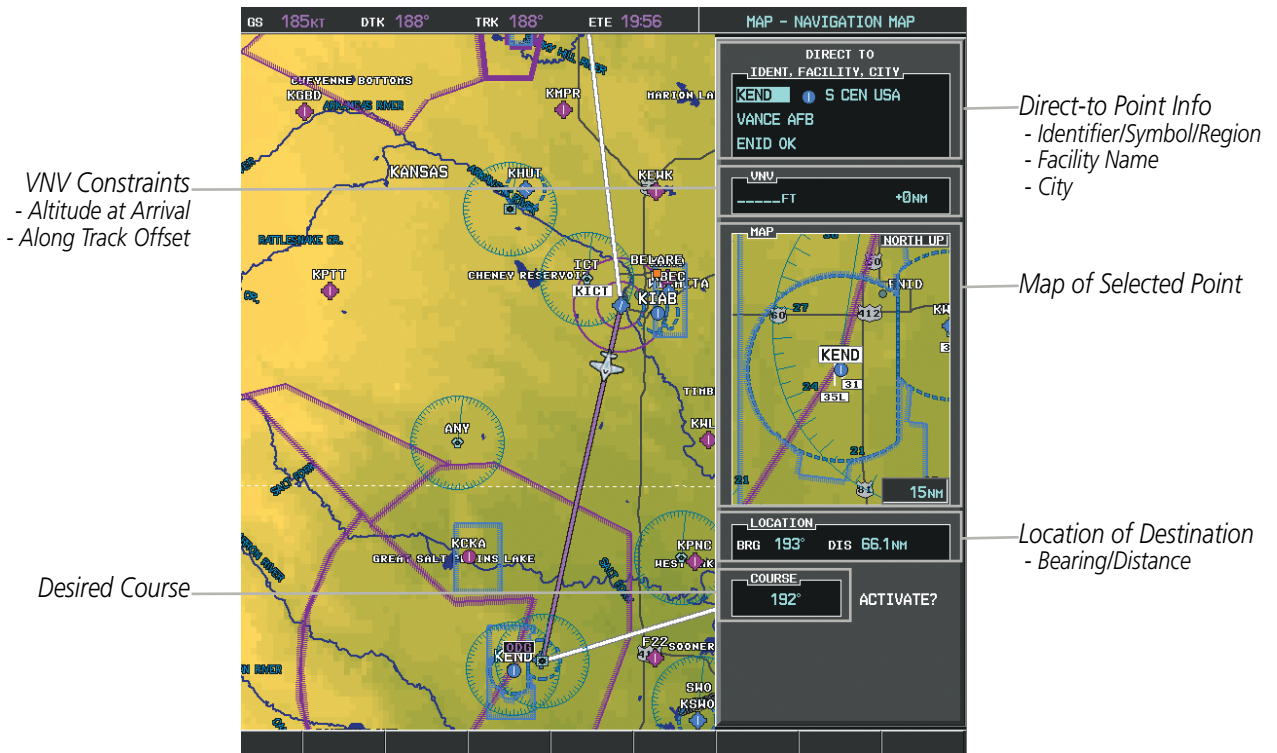

Figure 51 Direct-to Window - MFD

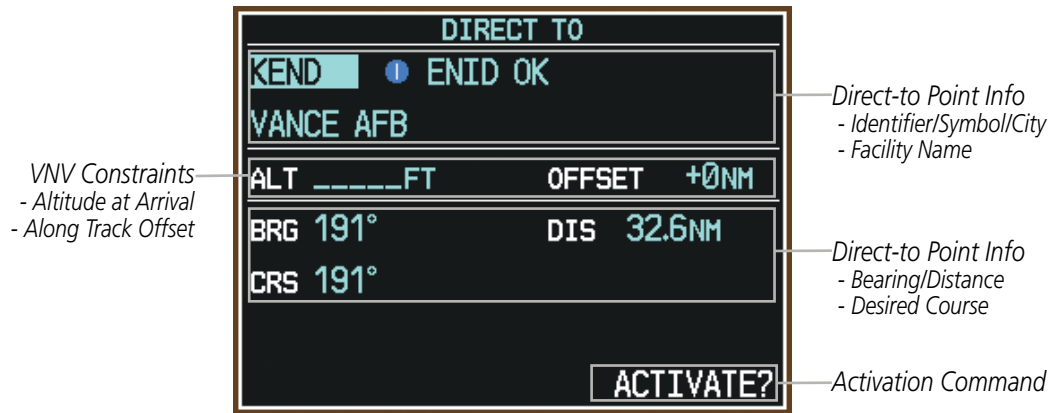

Figure 5-52 Direct-to Window - PFD

Any waypoint can be entered as a direct-to destination from the Direct-to Window.

Entering a waypoint identifier, facility name, or city as a direct-to destination:

- 1) Press the **Direct-to** Key. The Direct-to Window is displayed (with the active flight plan waypoint as the default selection or a blank waypoint field if no flight plan is active).
- 2) Turn the small **FMS** Knob clockwise to begin entering a waypoint identifier (turning it counter-clockwise brings up the waypoint selection submenu - press the **CLR** Key to remove it), or turn the large **FMS** Knob to select the facility name, or city field and turn the small **FMS** Knob to begin entering a facility name or city. If duplicate entries exist for the entered facility or city name, additional entries can be viewed by turning the small **FMS** Knob during the selection process.
- 3) Press the **ENT** Key. The 'Activate?' field is highlighted.
- 4) Press the **ENT** Key to activate the direct-to.

Any waypoint contained in the active flight plan can be selected as a direct-to waypoint from the Direct-to Window, the Active Flight Plan Page, or the Active Flight Plan Window.

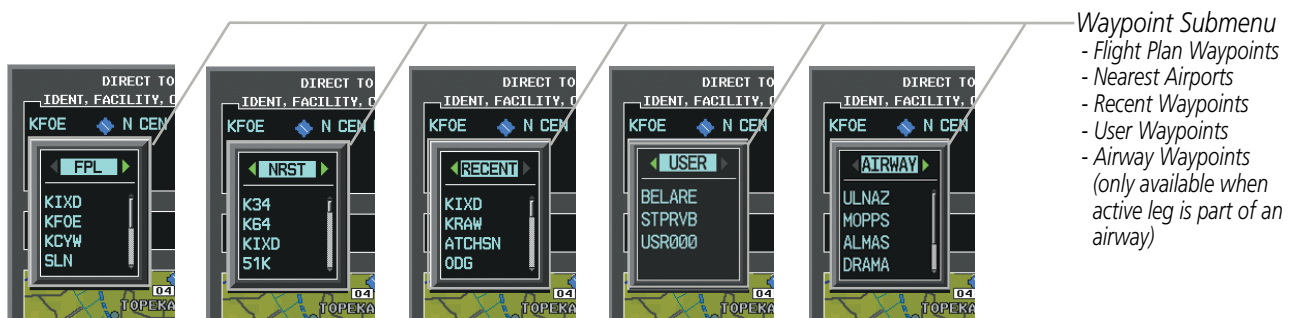

Figure 5-53 Waypoint Submenu

Selecting an active flight plan waypoint as a direct-to destination:

- 1) While navigating an active flight plan, press the **Direct-to** Key. The Direct-to Window is displayed with the active flight plan waypoint as the default selection.
- 2) Turn the small **FMS** Knob counter-clockwise to display a list of flight plan waypoints (the FPL list is populated only when navigating a flight plan).

- 3) Select the desired waypoint.
- 4) Press the **ENT** Key. The cursor is now displayed on 'ACTIVATE?'
- 5) Press the **ENT** Key again to activate the direct-to.

Or:

- 1) Select the Active Flight Plan Page on the MFD, or the Active Flight Plan Window on the PFD.
- 2) Select the desired waypoint.
- 3) Press the **Direct-to** Key.
- 4) Press the **ENT** Key. The cursor is now displayed on 'ACTIVATE?'
- 5) Press the **ENT** Key again to activate the direct-to.

Any NRST, RECENT, USER, or AIRWAY waypoint can be selected as a direct-to destination in the Direct-to Window.

Selecting a NRST, RECENT, USER, or AIRWAY waypoint as a direct-to destination:

- 1) Press the **Direct-to** Key. The Direct-to Window is displayed (with the active flight plan destination as the default selection or a blank destination if no flight plan is active).
- 2) Turn the small **FMS** Knob counter-clockwise to display a list of flight plan waypoints (the FPL list is populated only when navigating a flight plan).
- 3) Turn the small **FMS** Knob clockwise to display the NRST, RECENT, USER, or AIRWAY waypoints.
- 4) Turn the large **FMS** Knob clockwise to select the desired waypoint.
- 5) Press the **ENT** Key. The cursor is now displayed on 'ACTIVATE?'
- 6) Press the **ENT** Key again to activate the direct-to.

The Direct-to Window can be displayed from any page and allows selection and activation of direct-to navigation. If the direct-to is initiated from any page except the WPT pages, the default waypoint is the active flight plan waypoint (if a flight plan is active) or a blank waypoint field. Direct-to requests on any WPT page defaults to the displayed waypoint.

Selecting any waypoint as a direct-to destination:

- 1) Select the page or window containing the desired waypoint type and select the desired waypoint.
- 2) Press the **Direct-to** Key to display the Direct-to Window with the selected waypoint as the direct-to destination.
- 3) Press the **ENT** Key. The cursor is now displayed on 'ACTIVATE?'
- 4) Press **ENT** again to activate the direct-to.

Selecting a nearby airport as a direct-to destination:

- 1) Press the **NRST** Softkey on the PFD; or turn the **FMS** Knob to display the Nearest Airports Page and press the **FMS** Knob.
- 2) Select the desired airport (the nearest one is already selected).

- 3) Press the **Direct-to** Key.
- 4) Press the **ENT** Key. The cursor is now displayed on 'ACTIVATE?'.
- 5) Press the **ENT** Key again to activate the direct-to.

Direct-to destinations may also be selected by using the pointer on the navigation map pages. If no airport, NAVAID, or user waypoint exists at the desired location, a temporary waypoint named 'MAPWPT' is automatically created at the location of the map arrow.

Selecting a waypoint as a direct-to destination using the pointer:

- 1) From a navigation map page, press the **Joystick** to display the pointer.
- 2) Move the **Joystick** to place the pointer at the desired destination location.
- 3) If the pointer is placed on an existing airport, NAVAID, or user waypoint, the waypoint name is highlighted.
- 4) Press the **Direct-to** Key to display the Direct-to Window with the selected point entered as the direct-to destination.
- 5) Press the **ENT** Key. The cursor is now displayed on 'ACTIVATE?'.
- 6) Press the **ENT** Key again to activate the direct-to.

Cancelling a Direct-to:

- 1) Press the **Direct-to** Key to display the Direct-to Window.
- 2) Press the **MENU** Key.
- 3) With 'Cancel Direct-To NAV' highlighted, press the **ENT** Key. If a flight plan is still active, the G1000 resumes navigating the flight plan along the closest leg.

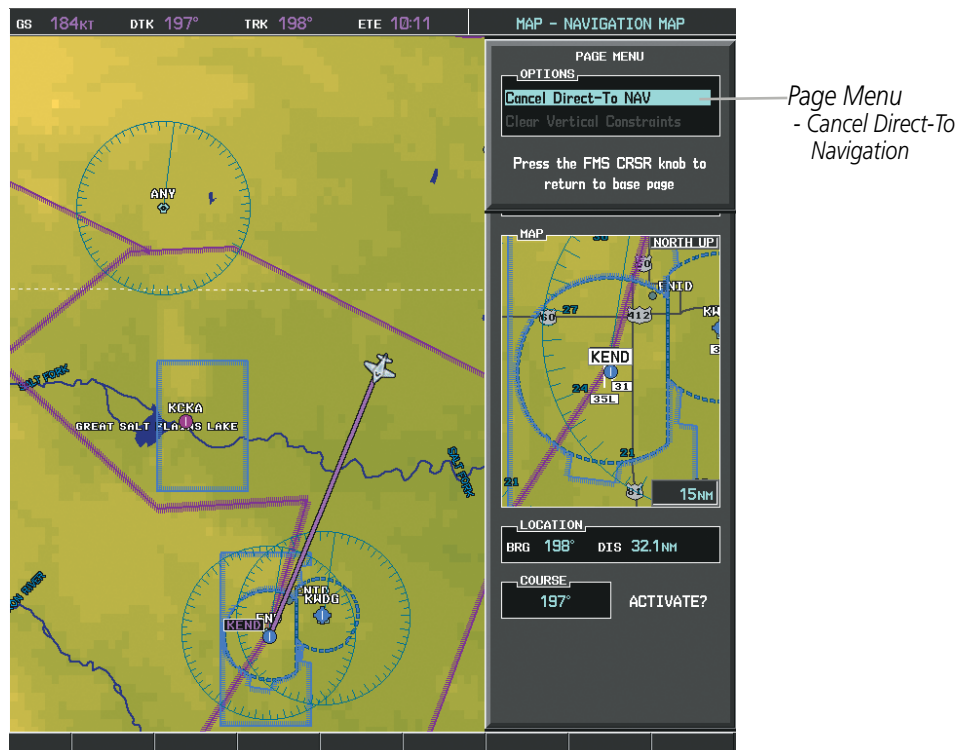

Figure 5-54 Direct-to Window - Cancelling Direct-to Navigation

When navigating a direct-to, the G1000 sets a direct great circle course to the selected destination. The course to a destination can also be manually selected using the course field ('COURSE') on the Direct-to Window.

Selecting a manual direct-to course:

- 1) Press the **Direct-to** Key. The Direct-to Window is displayed with the destination field highlighted.
- 2) Highlight the course field.
- 3) Enter the desired course.
- 4) Press the **ENT** Key. The cursor is now displayed on 'ACTIVATE?'
- 5) Press the **ENT** Key again to activate the direct-to.

Reselecting the direct course from the current position:

- 1) Press the **Direct-to** Key. The Direct-to Window is displayed with the destination field highlighted.
- 2) Press the **ENT** Key. The cursor is now displayed on 'ACTIVATE?'
- 3) Press the **ENT** Key again to activate the direct-to.

A direct-to with altitude constraints creates a descent path (and provides guidance to stay on the path) from the aircraft's current altitude to the altitude of the direct-to waypoint. The altitude is reached at the waypoint, or at the specified distance along the flight path if an offset distance has been entered. All VNV altitudes prior to the direct-to destination are removed from the active flight plan upon successful activation of the direct-to. All VNV altitudes following the direct-to waypoint are retained. See the section on Vertical Navigation for more information regarding the use and purpose of VNV altitudes and offset distances.

Entering a VNV altitude and along-track offset for the waypoint:

- 1) Press the **Direct-to** Key to display the Direct-to Window.
- 2) Turn the large **FMS** Knob to place the cursor over the 'VNV' altitude field.
- 3) Enter the desired altitude.
- 4) Press the **ENT** Key. The option to select MSL or AGL is now displayed.
- 5) Turn the small **FMS** Knob to select 'MSL' or 'AGL'.
- 6) Press the **ENT** Key. The cursor is now flashing in the VNV offset distance field.
- 7) Enter the desired along-track distance before the waypoint.
- 8) Press the **ENT** Key. The 'Activate?' field is highlighted.
- 9) Press the **ENT** Key to activate.

Removing a VNV altitude constraint:

- 1) Press the **Direct-to** Key to display the Direct-to Window.
- 2) Press the **MENU** Key.
- 3) With 'Clear Vertical Constraints' highlighted, press the **ENT** Key.

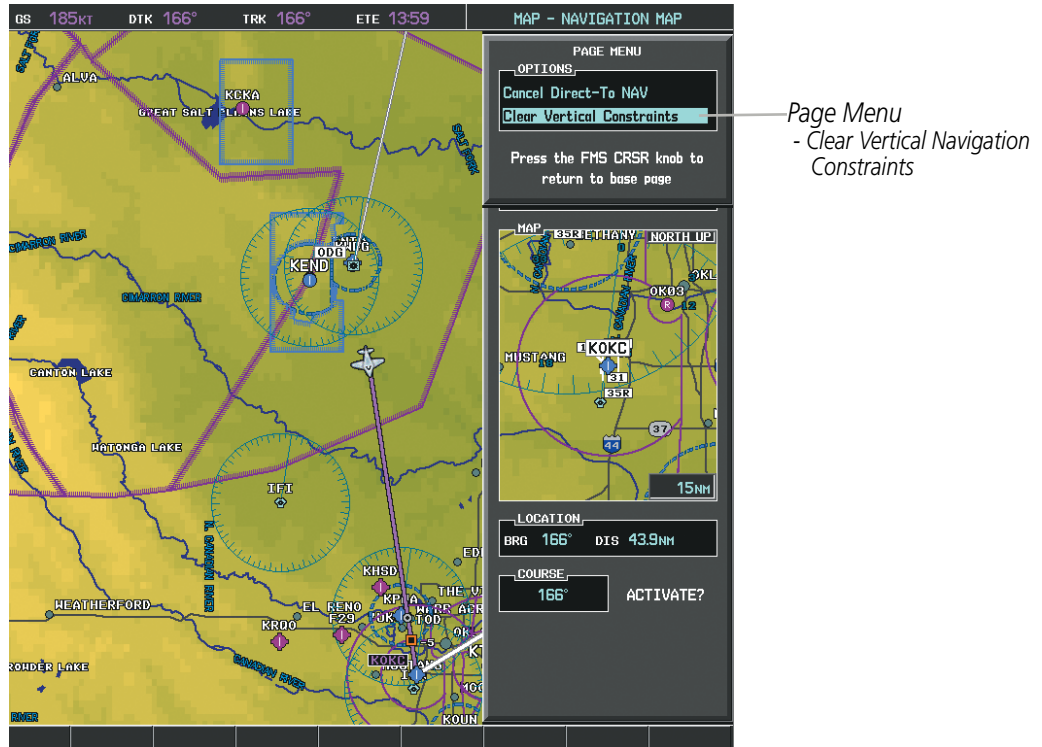

Figure 5-55 Direct-to Window - Clearing Vertical Constraints

5.6 FLIGHT PLANNING

Flight planning on the G1000 consists of building a flight plan by entering waypoints one at a time, adding waypoints along airways, and inserting departures, airways, arrivals, or approaches as needed. The G1000 allows flight planning information to be entered from either the MFD or PFD. The flight plan is displayed on maps using different line widths, colors, and types, based on the type of leg and the segment of the flight plan currently being flown (departure, enroute, arrival, approach, or missed approach).





Flight Plan Leg Type	Symbol
Active non-heading Leg	
Active heading Leg	
Non-heading Leg in the current flight segment	
Heading Leg not in the current flight segment	
Non-heading Leg not in the active flight segment	
Turn Anticipation Arc	

Table 5-7 Flight Plan Leg Symbols

Up to 99 flight plans with up to 99 waypoints each can be created and stored in memory. One flight plan can be activated at a time and becomes the active flight plan. The active flight plan is erased when the system is turned off and overwritten when another flight plan is activated. When storing flight plans with an approach, departure, or arrival, the G1000 uses the waypoint information from the current database to define the waypoints. If the database is changed or updated, the G1000 automatically updates the information if the procedure has not been modified. If an approach, departure, or arrival procedure is no longer available, the procedure is deleted from the affected stored flight plan(s), and an alert is displayed (see Miscellaneous Messages in Appendix A) advising that one or more stored flight plans need to be edited.

Whenever an approach, departure, or arrival procedure is loaded into the active flight plan, a set of approach, departure, or arrival waypoints is inserted into the flight plan along with a header line describing the instrument procedure the pilot selected. The original enroute portion of the flight plan remains active (unless an instrument procedure is activated) when the procedure is loaded.

When the database is updated, the airways need to be reloaded also. Each airway segment is reloaded from the database given the entry waypoint, the airway identifier and the exit waypoint. This reloads the sequence of waypoints between the entry and exit waypoints (the sequence may change when the database is updated). The update of an airway can fail during this process. If that happens, the airway waypoints are changed to regular (non-airway) flight plan waypoints, and an alert is displayed (see Miscellaneous Messages in Appendix A).

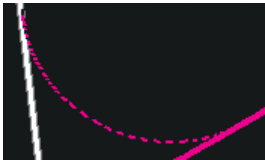
The following could cause the airway update to fail:

- Airway identifier, entry waypoint or exit waypoint not found in the new database.
- Airway entry/exit waypoint is not an acceptable waypoint for the airway – either the waypoint is no longer on the airway, or there is a new directional restriction that prevents it being used.
- Loading the new airway sequence would exceed the capacity of the flight plan.

FLIGHT PLAN CREATION

There are three methods to create or modify a flight plan:

- Active Flight Plan Page on the MFD (create/modify the active flight plan)
- Active Flight Plan Window on the PFD (create/modify the active flight plan)
- Flight Plan Catalog Page on the MFD (create/modify a stored flight plan)

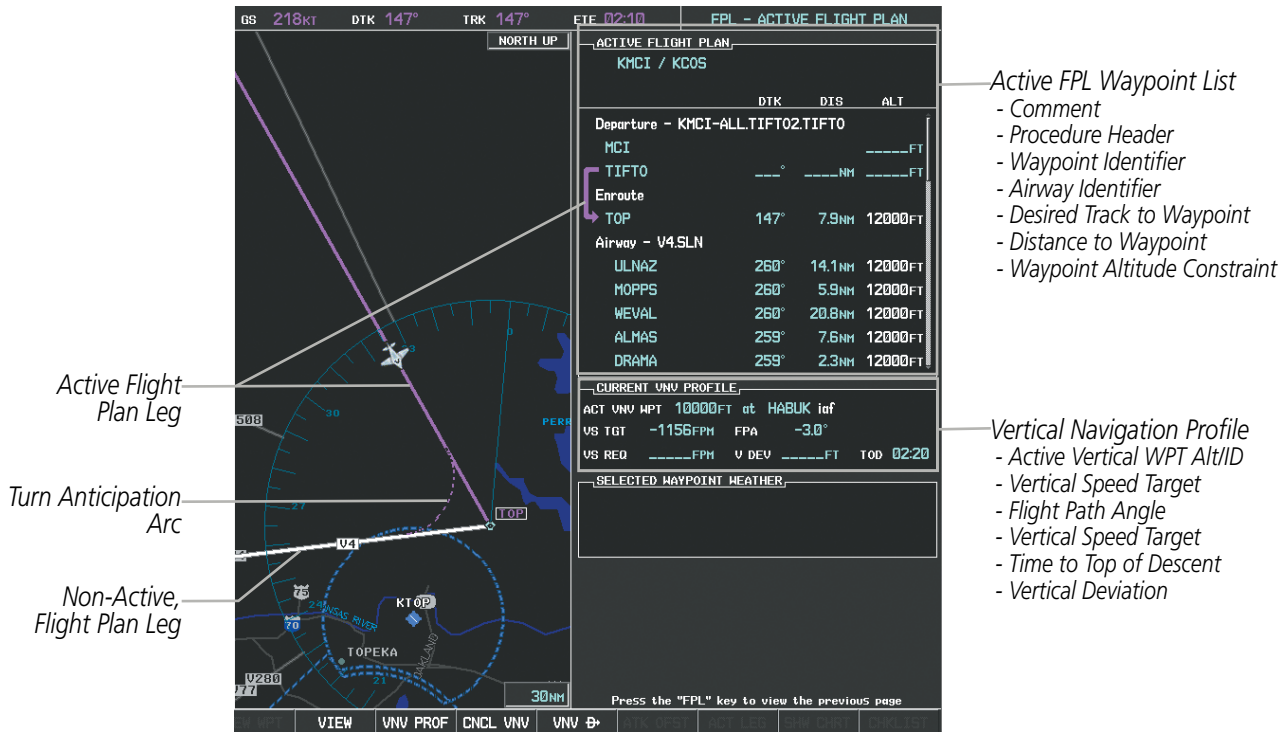

Figure 5-56 Active Flight Plan Page

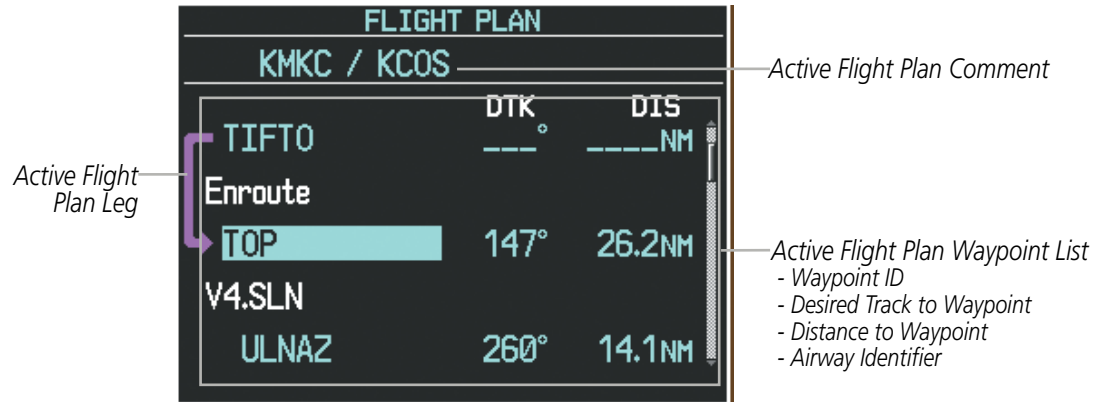

Figure 5-57 Active Flight Plan Window on PFD

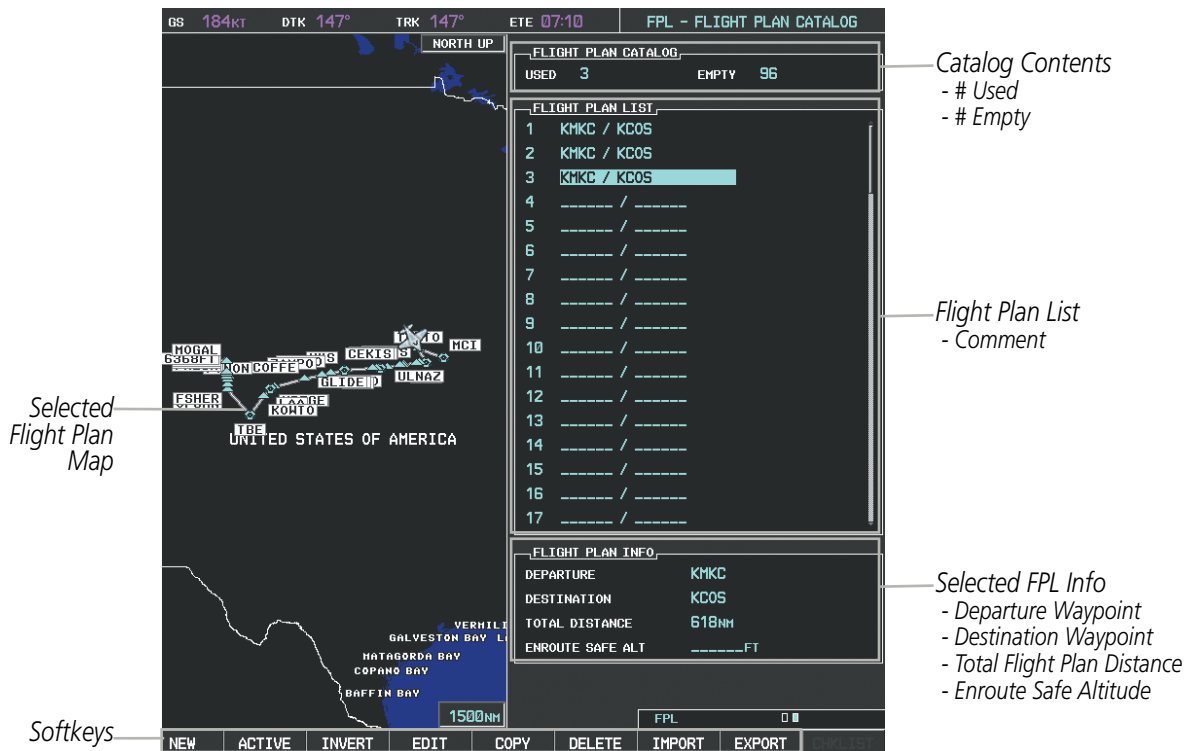

Figure 5-58 Flight Plan Catalog Page

The active flight plan is listed on the active Flight Plan Page on the MFD, and in the Active Flight Plan Window on the PFD. It is the flight plan to which the G1000 is currently providing guidance, and is shown on the navigation maps. Stored flight plans are listed on the Flight Plan Catalog Page, and are available for activation (becomes the active flight plan).

Creating an active flight plan:

- 1) Press the **FPL** Key.
- 2) Press the **FMS** Knob to activate the cursor (only on MFD).
- 3) Turn the small **FMS** Knob to display the Waypoint Information Window. (Turning it clockwise displays a blank Waypoint Information Window, turning it counter-clockwise displays the Waypoint Information Window with a waypoint selection submenu allowing selection of active flight plan, nearest, recent, user, or airway waypoints).
- 4) Enter the identifier, facility, or city name of the departure waypoint or select a waypoint from the submenu of waypoints and press the **ENT** Key. The active flight plan is modified as each waypoint is entered.
- 5) Repeat step numbers 3 and 4 to enter each additional flight plan waypoint.
- 6) When all waypoints have been entered, press the **FMS** Knob to remove the cursor.

Creating a stored flight plan:

- 1) Press the **FPL** Key.
- 2) Turn the small **FMS** Knob clockwise to display the Flight Plan Catalog Page.
- 3) Select the **NEW** Softkey; or press the **MENU** Key, highlight 'Create New Flight Plan', and press the **ENT** Key to display a blank flight plan for the first empty storage location.
- 4) Turn the small **FMS** Knob to display the Waypoint Information Window. (Turning it clockwise displays a blank Waypoint Information Window, turning it counter-clockwise displays the Waypoint Information Window with a waypoint selection submenu allowing selection of active flight plan, nearest, recent, user, or airway waypoints).
- 5) Enter the identifier, facility, or city name of the departure waypoint or select a waypoint from the submenu of waypoints and press the **ENT** Key.
- 6) Repeat step numbers 4 and 5 to enter each additional flight plan waypoint.
- 7) When all waypoints have been entered, press the **FMS** Knob to return to the Flight Plan Catalog Page. The new flight plan is now in the list.

Flight plans can be imported from an SD Card or exported to an SD Card from the Stored Flight Plan Page.

Importing a Flight Plan from an SD Card

- 1) Insert the SD card containing the flight plan in the top card slot on the MFD.
- 2) Press the **FPL** Key to display the Active Flight Plan Page on the MFD.
- 3) Turn the small **FMS** Knob to select the Flight Plan Catalog Page.
- 4) Press the **FMS** Knob to activate the cursor.
- 5) Turn either **FMS** Knob to highlight an empty or existing flight plan.
- 6) Press the **IMPORT** Softkey; or press the **MENU** Key, select "Import Flight Plan", and press the **ENT** Key.

If an empty slot is selected, a list of the available flight plans on the SD card will be displayed.

Or:

If an existing flight plan is selected, an "Overwrite existing flight plan? OK or CANCEL" prompt is displayed. Press the **ENT** Key to choose to overwrite the selected flight plan and see the list of available flight plans on the SD card. If overwriting the existing flight plan is not desired, select "CANCEL" using the **FMS** Knob, press the **ENT** Key, select another flight plan slot, and press the **IMPORT** Softkey again.

- 7) Turn the small **FMS** Knob to highlight the desired flight plan for importing.
- 8) Press the **ENT** Key to initiate the import.
- 9) Press the **ENT** Key again to confirm the import.

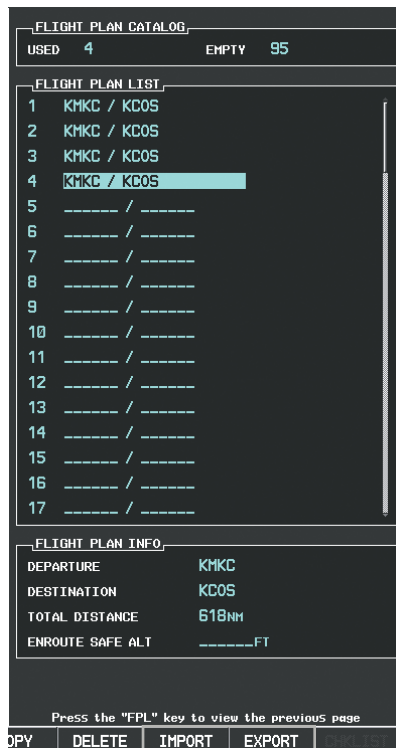

Import/Export Softkeys

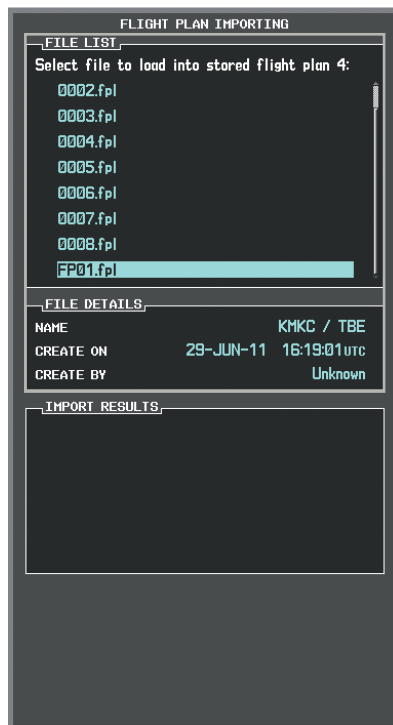

List of Flight Plans to Import & Details for the Selected File

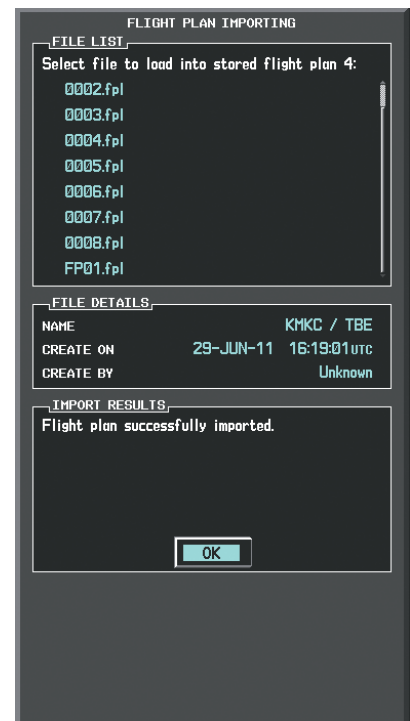

Import Successful

Figure 5-59 Flight Plan Import



NOTE: If the imported flight plan contains a waypoint with a name that duplicates the name of a waypoint already stored on the system, the system compares the coordinates of the imported waypoint with those of the existing waypoint. If the coordinates are different, the imported waypoint is automatically renamed by adding characters to the end of the name.

Exporting a Flight Plan to an SD Card

- 1) Insert the SD card into the top card slot on the MFD.
- 2) Press the **FPL** Key to display the Active Flight Plan Page on the MFD.
- 3) Turn the small **FMS** Knob to select the Flight Plan Catalog Page.
- 4) Press the **FMS** Knob to activate the cursor.
- 5) Turn the large **FMS** Knob to highlight the flight plan to be exported.
- 6) Press the **EXPORT** Softkey; or press the **MENU** Key, select "Export Flight Plan".
- 7) If desired, change the name for the exported file by turning the large **FMS** Knob to the left to highlight the name, then use the small and large **FMS** knobs to enter the new name, and press the **ENT** Key.
- 8) Press the **ENT** Key to initiate the export.
- 9) Press the **ENT** Key to confirm the export.



NOTE: The exported flight plan will not contain any procedures or airways.



Import/Export Softkeys

Stored Flight Plan to be Exported & Exported Flight Plan Name

Export Successful

Figure 5-60 Flight Plan Export

ADDING WAYPOINTS TO AN EXISTING FLIGHT PLAN

Waypoints can be added to the active flight plan or any stored flight plan. Choose the flight plan, select the desired point of insertion, enter the waypoint, and it is added in front of the selected waypoint. Flight plans are limited to 99 waypoints (including waypoints within airways and procedures). If the number of waypoints in the flight plan exceeds 99, the message “Flight plan is full. Remove unnecessary waypoints.” appears and the new waypoint(s) are not added to the flight plan.

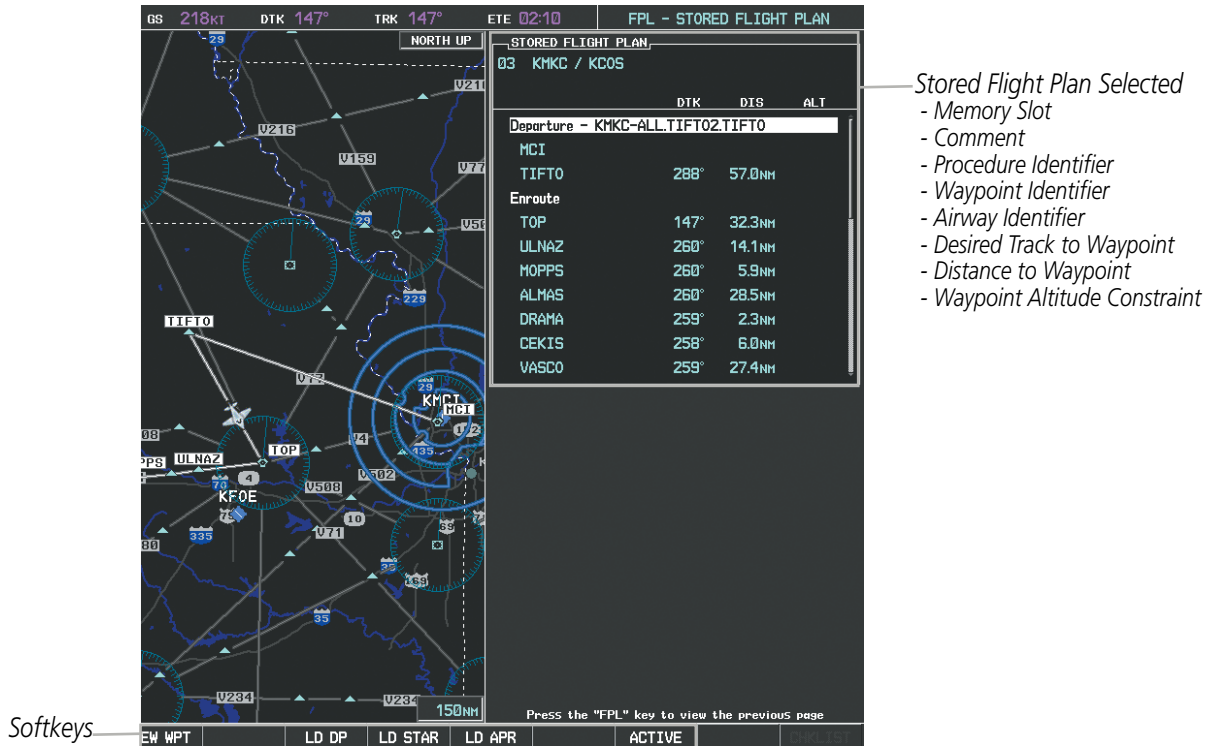

Figure 5-61 Stored Flight Plan Page

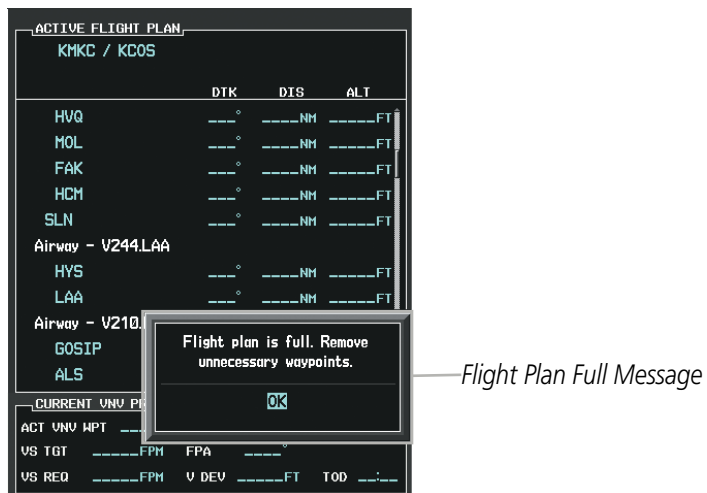

Figure 5-62 Active Flight Plan Page - FPL Full

Adding a waypoint to a stored flight plan:

- 1) On the Flight Plan Catalog Page, press the **FMS** Knob to activate the cursor.
- 2) Highlight the desired flight plan.
- 3) Select the **EDIT** Softkey; or press the **ENT** Key, turn the large **FMS** Knob clockwise to select "EDIT" and press the **ENT** Key. The Stored Flight Plan Page is displayed.
- 4) Select the point in the flight plan to add the new waypoint. The new waypoint is placed directly in front of the highlighted waypoint.
- 5) Turn the small **FMS** Knob to display the Waypoint Information Window. (Turning it clockwise displays a blank Waypoint Information Window, turning it counter-clockwise displays the Waypoint Information Window with a waypoint selection submenu allowing selection of active flight plan, nearest, recent, user, or airway waypoints).
- 6) Enter the identifier, facility, or city name of the waypoint or select a waypoint from the submenu of waypoints and press the **ENT** Key. The new waypoint now exists in the flight plan.



NOTE: If the identifier entered in the Waypoint Information Window has duplicates, a Duplicate Waypoint Window is displayed. Use the FMS Knob to select the correct waypoint.

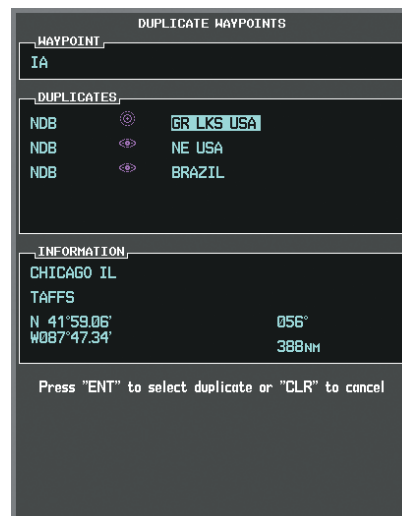

Figure 5-63 Duplicate Waypoints Window

Adding a waypoint to the active flight plan:

- 1) Press the **FPL** Key.
- 2) Press the **FMS** Knob to activate the cursor (not required on the PFD).
- 3) Select the point in the flight plan before which to add the new waypoint. The new waypoint is placed directly in front of the highlighted waypoint.

- 4) Turn the small **FMS** Knob to display the Waypoint Information Window. (Turning it clockwise displays a blank Waypoint Information Window, turning it counter-clockwise displays the Waypoint Information Window with a waypoint selection submenu allowing selection of active flight plan, nearest, recent, user, or airway waypoints).
- 5) Enter the identifier, facility, or city name of the waypoint or select a waypoint from the submenu of waypoints and press the **ENT** Key. The active flight plan is modified as each waypoint is entered.

Creating and adding user waypoints to the active flight plan:

- 1) Press the **Joystick** to activate the panning function on the Active Flight Plan Page and pan to the map location of the desired user waypoint.
- 2) Select the **LD WPT** Softkey; or press the **MENU** Key, select 'Load Waypoint', and press the **ENT** Key. The user waypoint is created with a name of USRxxx (using the next available in sequence) and is added to the end of the active flight plan.

ADDING AIRWAYS TO A FLIGHT PLAN

Airways can be added to the active flight plan or any stored flight plan. Choose a flight plan (add the desired airway entry point if not already in the flight plan), select the waypoint after the desired airway entry point, select the airway, and it is added in front of the selected waypoint. An airway can only be loaded if there is a waypoint in the flight plan that is part of the desired airway and is not part of an arrival or approach procedure. The G1000 also anticipates the desired airway and exit point based on loaded flight plan waypoints.

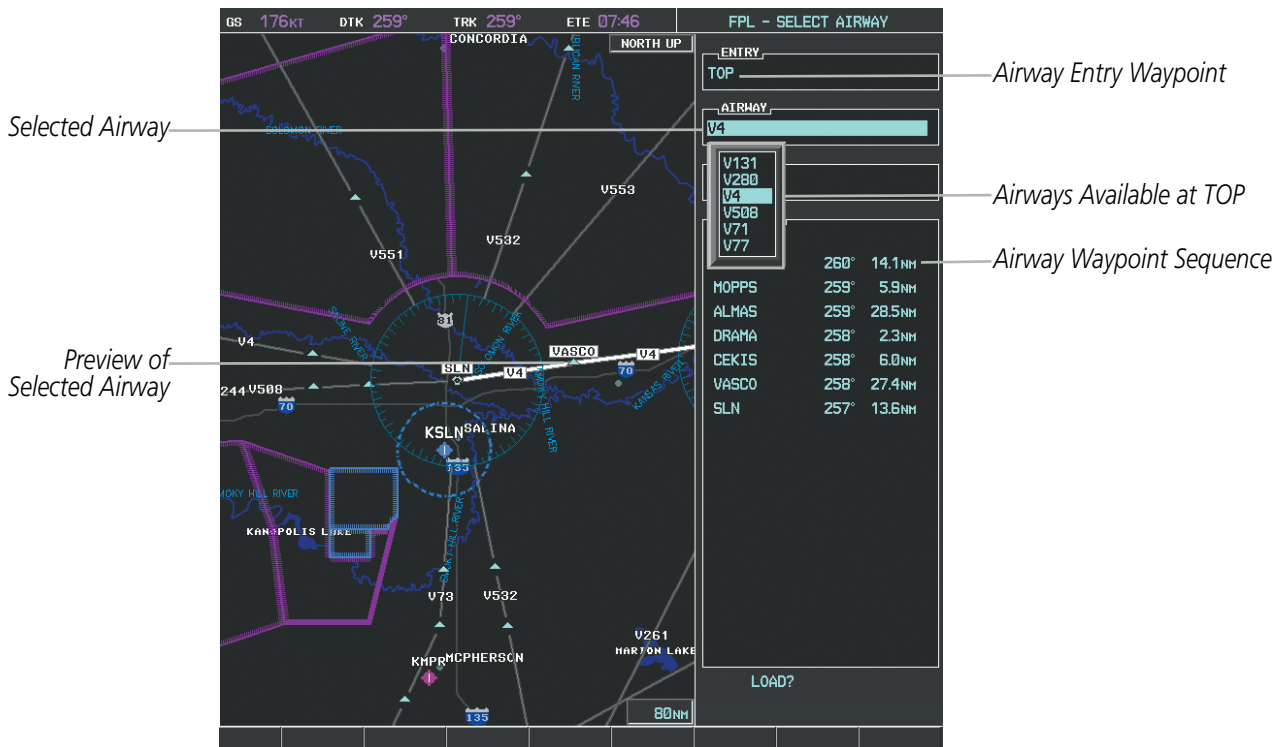

Figure 5-64 Select Airway Page - Selecting Airway

Adding an airway to a flight plan:

- 1) Press the **FPL** Key.
- 2) Press the **FMS** Knob to activate the cursor (not required on the PFD).
- 3) Turn the large **FMS** Knob to highlight the waypoint after the desired airway entry point. If this waypoint is not a valid airway entry point, a valid entry point should be entered at this time.
- 4) Turn the small **FMS** Knob one click clockwise and select the **LD AIRWY** Softkey, or press the **MENU** Key and select "Load Airway". The Select Airway Page is displayed. The **LD AIRWY** Softkey or the "Load Airway" menu item is available only when a valid airway entry waypoint has been chosen (the waypoint ahead of the cursor position).
- 5) Turn the **FMS** Knob to select the desired airway from the list, and press the **ENT** Key. Low altitude airways are shown first in the list, followed by "all" altitude airways, and then high altitude airways.
- 6) Turn the **FMS** Knob to select the desired airway exit point from the list, and press the **ENT** Key. 'LOAD?' is highlighted.
- 7) Press the **ENT** Key. The system returns to editing the flight plan with the new airway inserted.

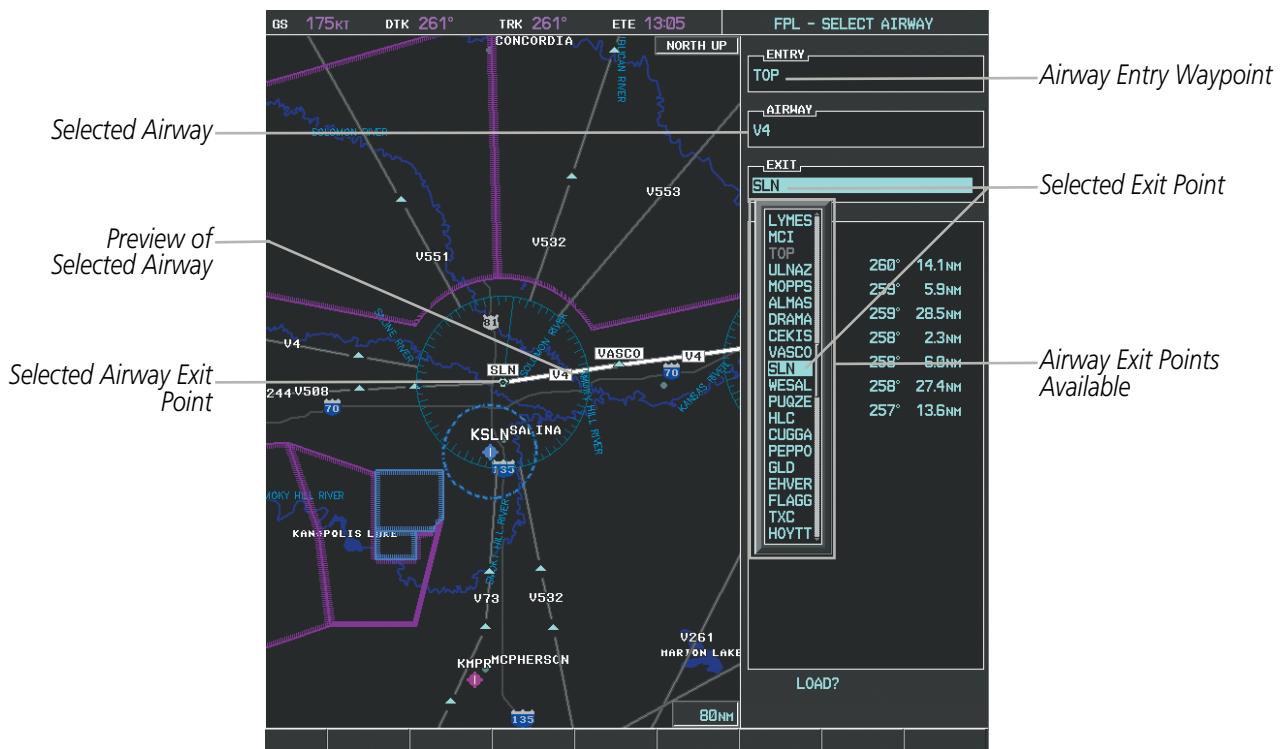

Figure 5-65 Select Airway Page - Selecting Exit Point

ACTIVE FLIGHT PLAN			
KMCI / KCOS			
	DTK	DIS	ALT
Departure - KMCI-ALL.TIFT02.TIFT0			
MCI			_____FT
TIFT0	___°	____NM	_____FT
Enroute			
TOP	147°	7.9NM	12000FT
Airway - V4.SLN			
ULNAZ	260°	14.1NM	12000FT
MOPPS	260°	5.9NM	12000FT
WEVAL	260°	20.8NM	12000FT
ALMAS	259°	7.6NM	12000FT
DRAMA	259°	2.3NM	12000FT

CURRENT UNV PROFILE			
ACT UNV HPT	10000FT	at	HABUK iaf
VS TGT	-1156FPM	FPA	-3.0°
VS REQ	_____FPM	V DEV	_____FT
			TOD 02:20

SELECTED WAYPOINT WEATHER			

Inserted Airway Header
 - Airway Identifier: [airway identifier].[exit waypoint identifier] (e.g., V4.SLN)

Figure 5-66 Active Flight Plan Page - Airway Inserted

RESTRICTIONS ON ADDING AIRWAYS

Some airways have directional restrictions on all or part of the route. Airway “A2” in Europe has a directional restriction over the whole route such that it can be flown only in the direction MTD-ABB-BNE-DEVAL.

Airway “UR975” in North Africa has more complicated directional restrictions within the list of airway waypoints AMANO, VAKOR, LIBRO, NELDA, DIRKA, GZO, KOSET, and SARKI:

- Starting from AMANO, the airway can be flown only to LIBRO.
- Starting from SARKI, the airway can be flown only to LIBRO.
- Between NELDA and GZO, the airway can be flown in either direction.

In the US, airways that are “one-way” for specified hours of operation are not uncommon. These airways are always bidirectional in the G1000 database.

The system only allows correct airway sequences to be inserted. If the pilot subsequently inverts the flight plan, the system inverts the airway waypoint sequence and removes the airway header.

ADDING PROCEDURES TO A STORED FLIGHT PLAN

The G1000 allows the pilot to insert pre-defined instrument procedures from the navigation database into a flight plan. The procedures are designed to facilitate routing of traffic leaving an airport (departure), arriving at an airport (arrival), and landing at an airport (approach). See the procedures section for more details.

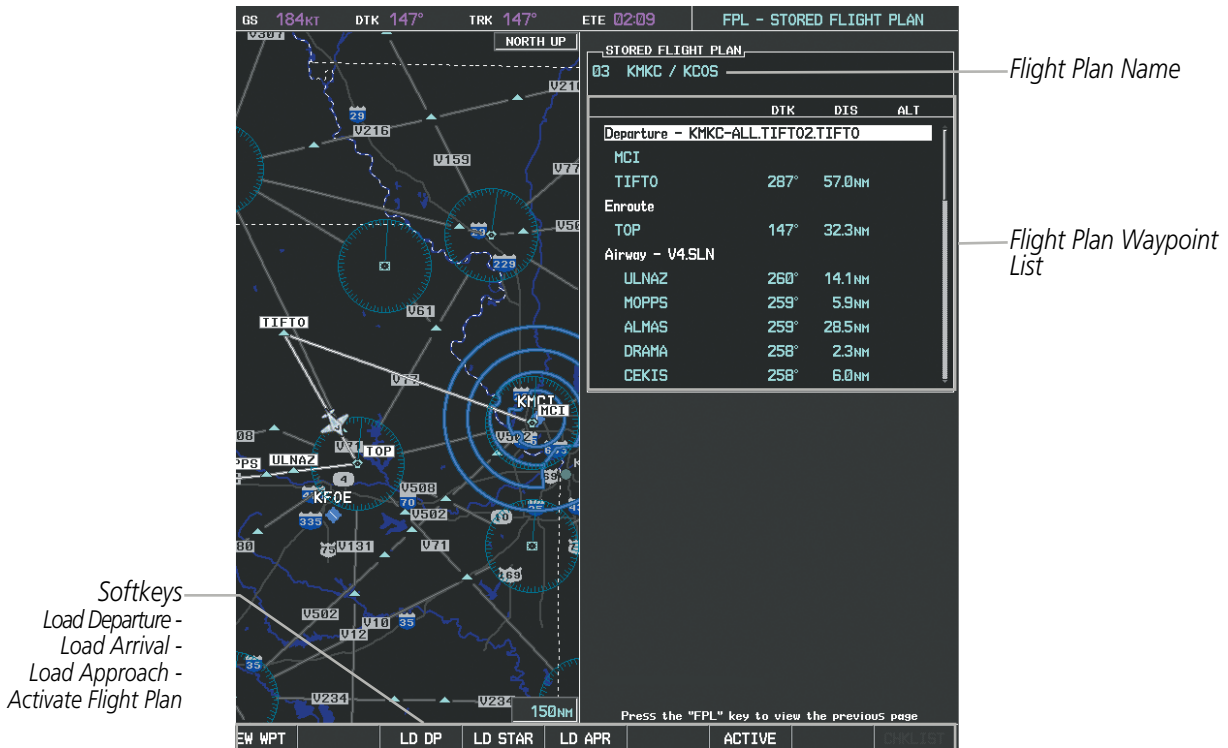

Figure 5-67 Stored Flight Plan Page

DEPARTURE (DP)

A Departure Procedure (DP) is loaded at the departure airport in the flight plan. Only one departure can be loaded at a time in a flight plan. The route is defined by selection of a departure, the transition waypoints, and a runway.

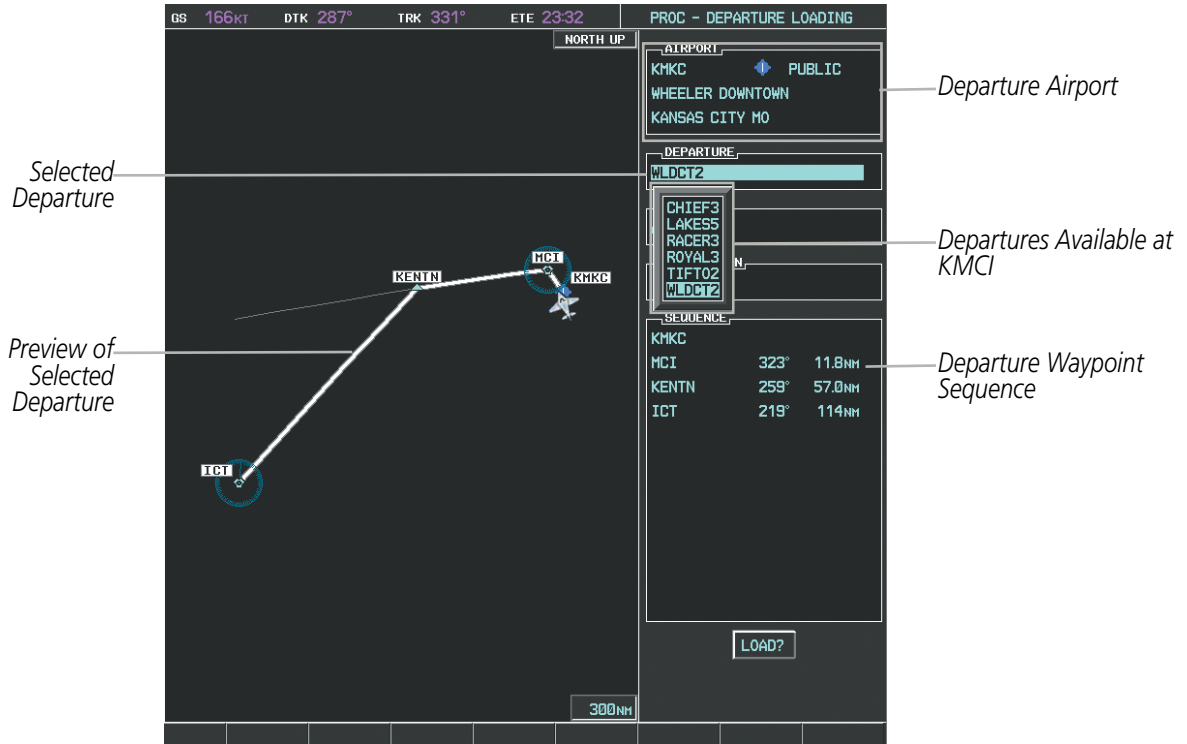

Figure 5-68 Departure Loading Page - Selecting the Departure

Loading a departure procedure into a stored flight plan:

- 1) Select a stored flight plan from the Flight Plan Catalog Page.
- 2) Select the **EDIT** Softkey; or press the **MENU** Key, select 'Edit Flight Plan', and press the **ENT** Key. The Stored Flight Plan Page is displayed.
- 3) Select the **LD DP** Softkey; or press the **MENU** Key, select "Load Departure", and press the **ENT** Key. The Departure Loading Page is displayed.
- 4) Select a departure. Press the **ENT** Key.
- 5) Select a runway served by the selected departure, if required. Press the **ENT** Key.
- 6) Select a transition for the selected departure. Press the **ENT** Key.
- 7) Press the **ENT** Key to load the selected departure procedure.

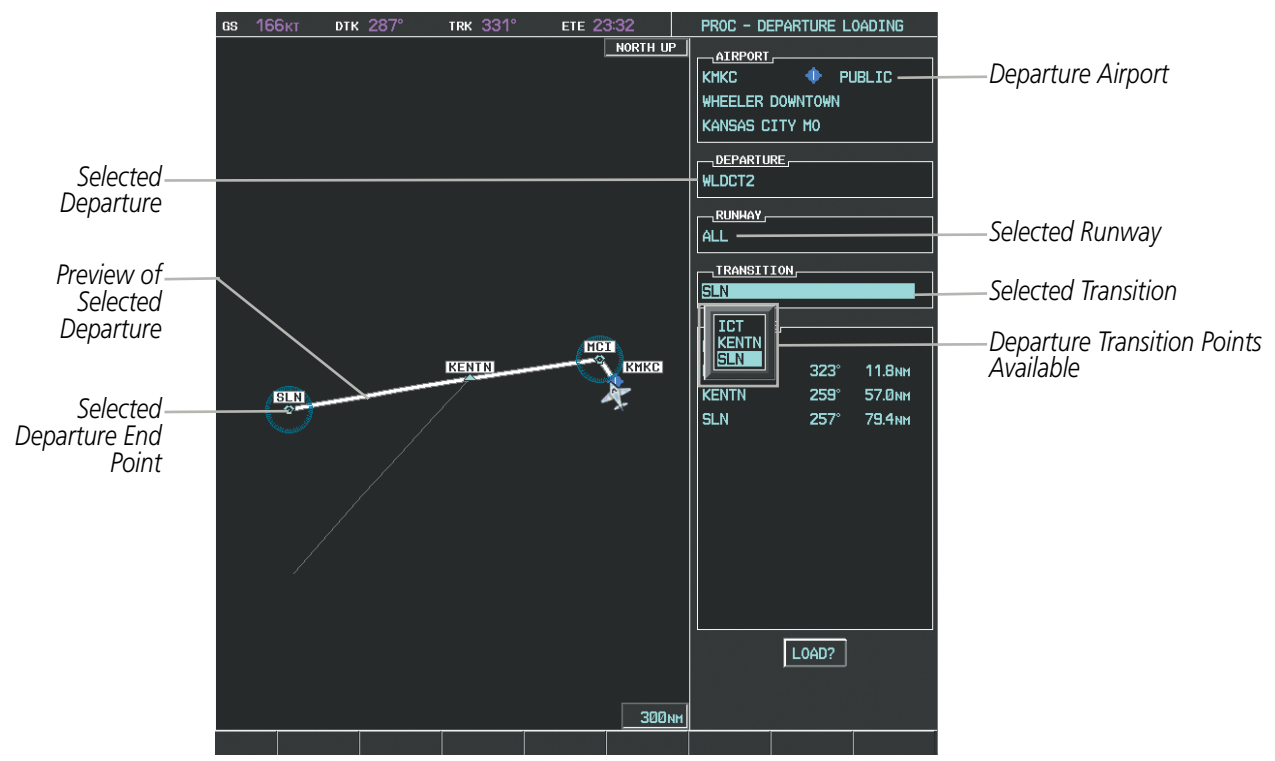

Figure 5-69 Departure Loading Page - Selecting Transition

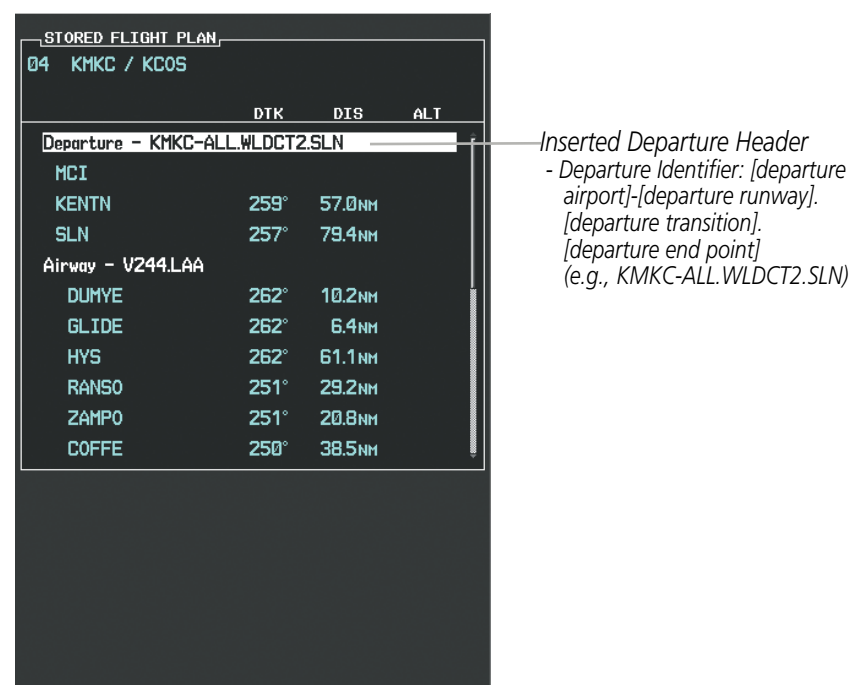

Figure 5-70 Stored Flight Plan Page - Departure Inserted

ARRIVAL (STAR)

A Standard Terminal Arrival (STAR) is loaded at the destination airport in the flight plan. Only one arrival can be loaded at a time in a flight plan. The route is defined by selection of an arrival, the transition waypoints, and a runway.

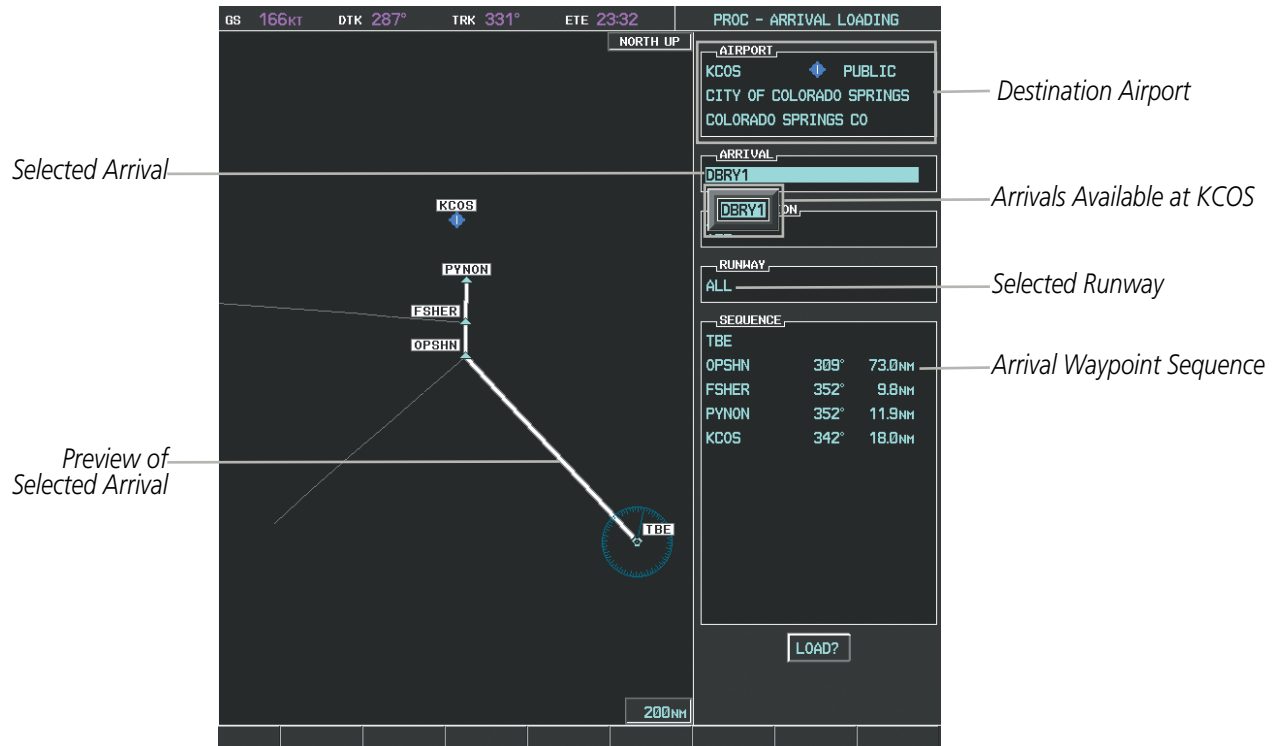

Figure 5-71 Arrival Loading Page - Selecting the Arrival

Loading an arrival procedure into a stored flight plan:

- 1) Select a stored flight plan from the Flight Plan Catalog Page.
- 2) Select the **EDIT** Softkey; or press the **MENU** Key, select 'Edit Flight Plan', and press the **ENT** Key. The Stored Flight Plan Page is displayed.
- 3) Select the **LD STAR** Softkey; or press the **MENU** Key, select "Load Arrival", and press the **ENT** Key. The Arrival Loading Page is displayed.
- 4) Select an arrival. Press the **ENT** Key.
- 5) Select a transition for the selected arrival. Press the **ENT** Key.
- 6) Select a runway served by the selected arrival, if required. Press the **ENT** Key.
- 7) Press the **ENT** Key to load the selected arrival procedure.

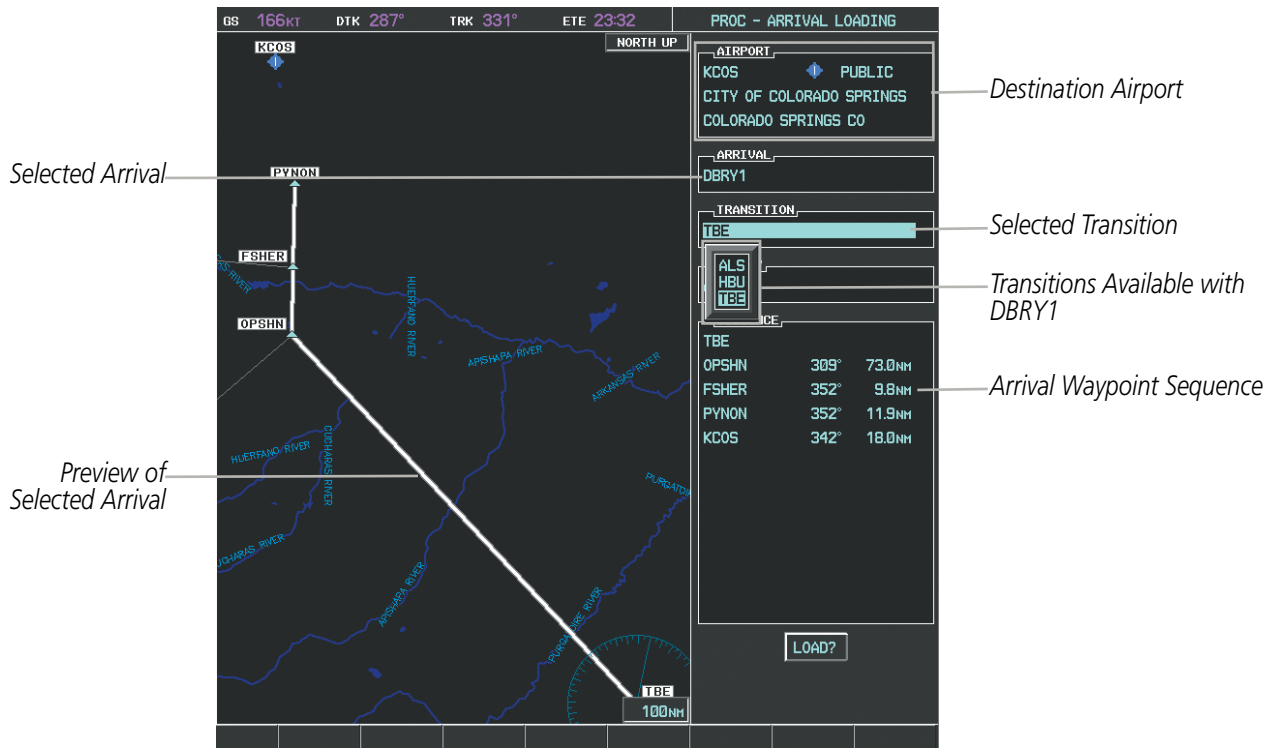

Figure 5-72 Arrival Loading Page - Selecting the Transition

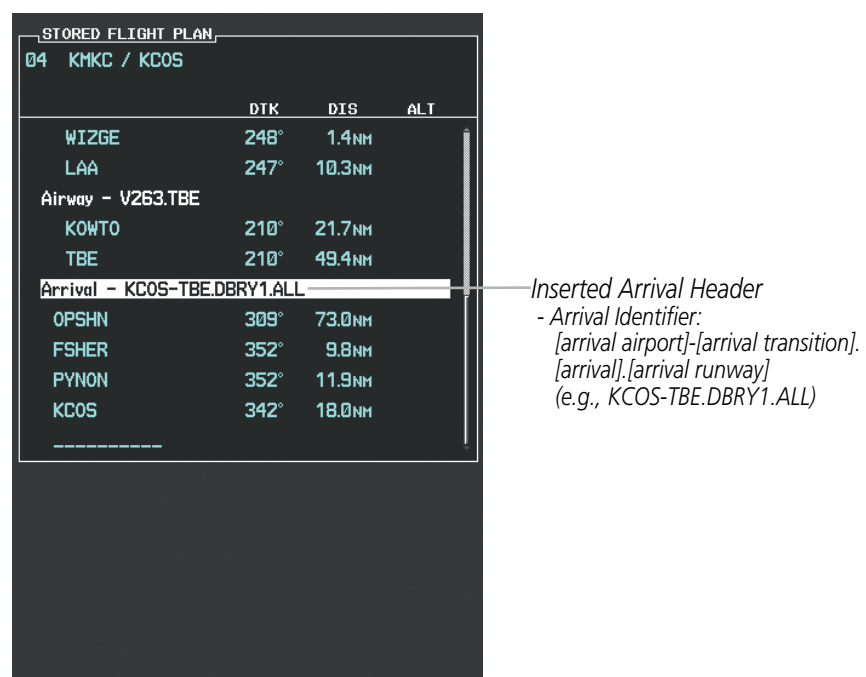

Figure 5-73 Stored Flight Plan Page - Arrival Inserted

APPROACH (APPR)

An Approach Procedure (APPR) can be loaded at any airport that has an approach available. Only one approach can be loaded at a time in a flight plan. The route for a selected approach is defined by designating transition waypoints.

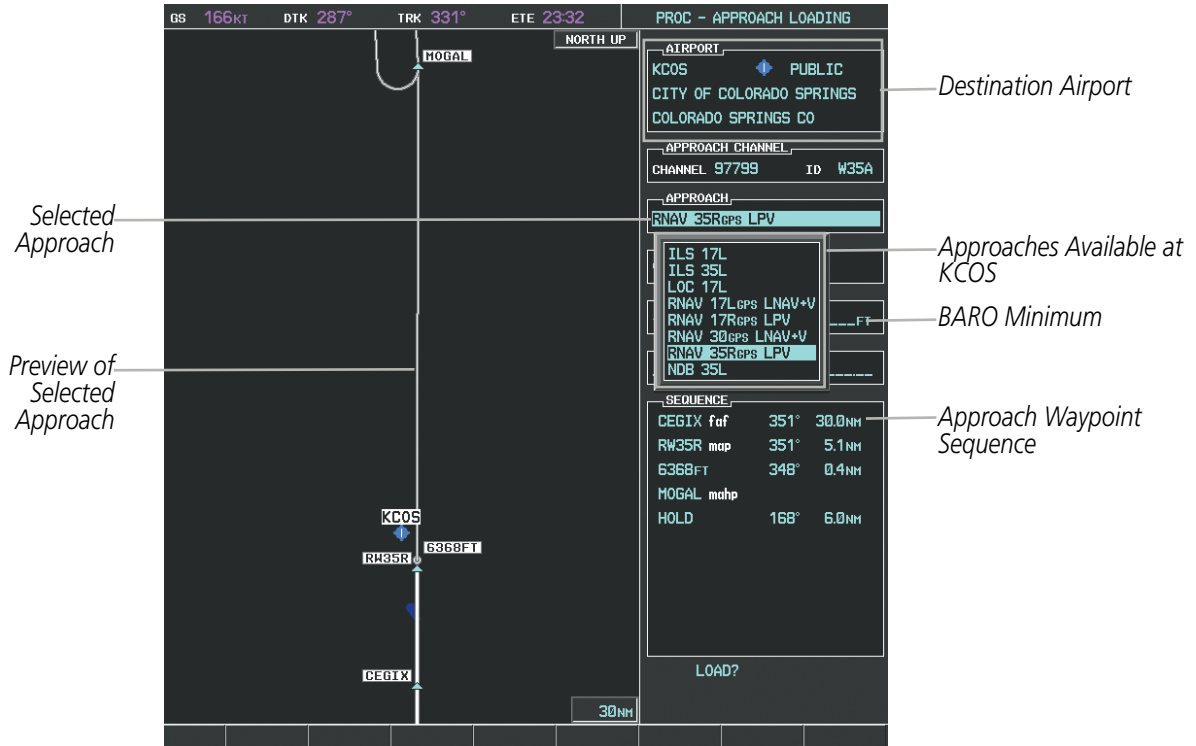

Figure 5-74 Approach Loading Page - Selecting the Approach

Loading an approach procedure into a stored flight plan:

- 1) Select a stored flight plan from the Flight Plan Catalog Page.
- 2) Select the **EDIT** Softkey; or press the **MENU** Key, select 'Edit Flight Plan', and press the **ENT** Key. The Stored Flight Plan Page is displayed.
- 3) Select the **LD APR** Softkey; or press the **MENU** Key, select "Load Approach", and press the **ENT** Key. The Approach Loading Page is displayed.
- 4) Select an approach. Press the **ENT** Key.
- 5) Select a transition for the selected approach. Press the **ENT** Key.
- 6) Press the **ENT** Key to load the selected approach procedure.

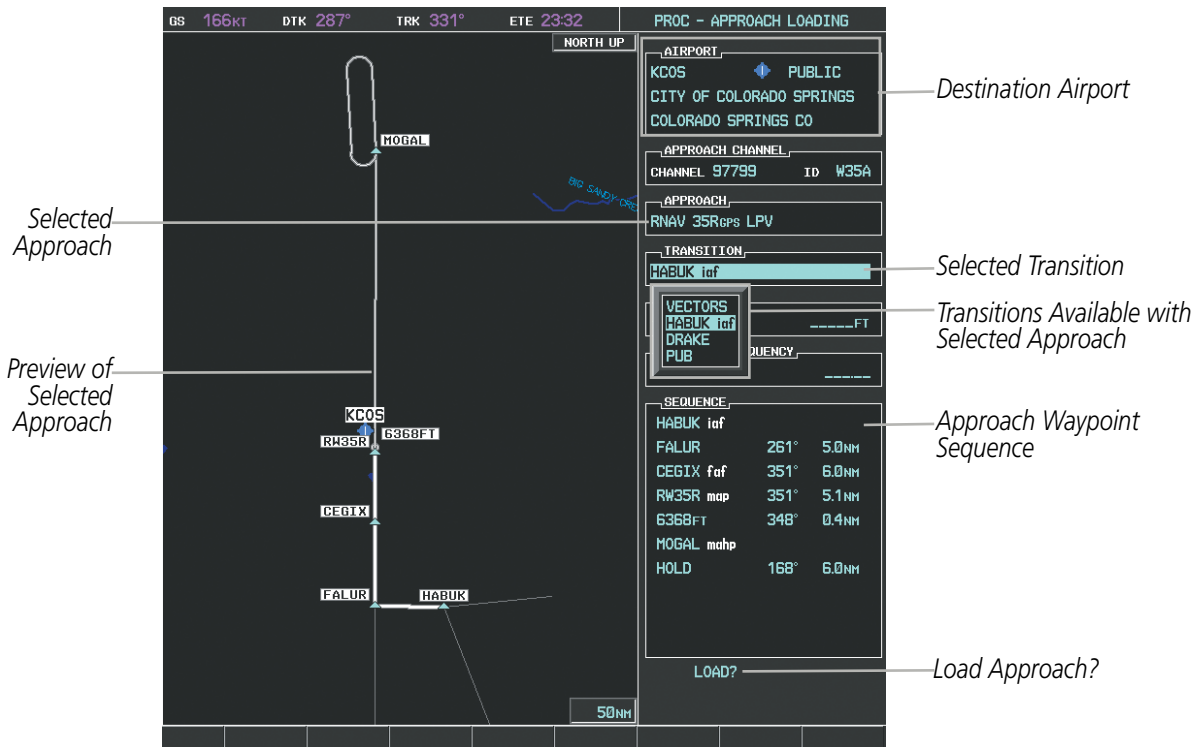

Figure 5-75 Approach Loading Page - Selecting the Transition

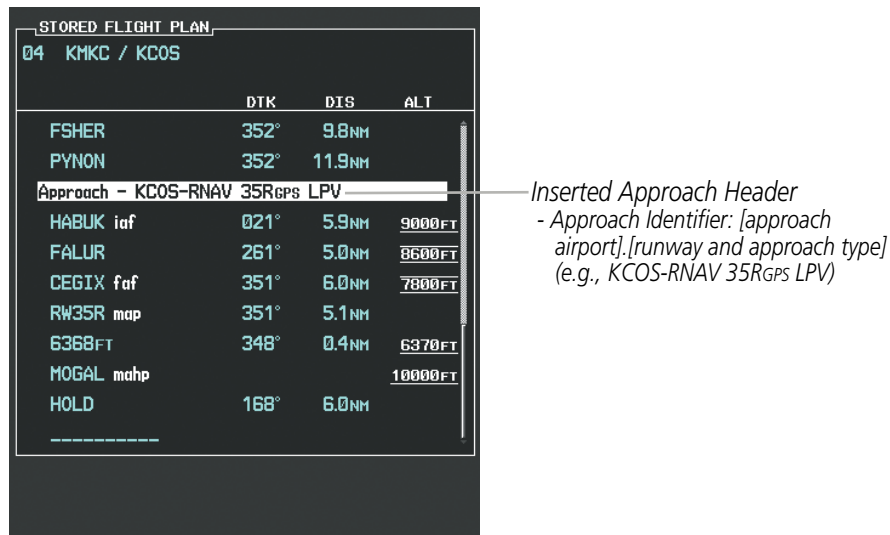

Figure 5-76 Stored Flight Plan Page - Approach Inserted

FLIGHT PLAN STORAGE

The G1000 can store up to 99 flight plans, numbered 1 through 99. The active flight plan is erased when the G1000 is powered off or when another flight plan is activated. Details about each stored flight plan can be viewed on the Flight Plan Catalog Page and on the Stored Flight Plan Page.

Viewing information about a stored flight plan:

- 1) Press the **FPL** Key on the MFD to display the Active Flight Plan Page.
- 2) Turn the small **FMS** Knob clockwise one click to display the Flight Plan Catalog Page.
- 3) Press the **FMS** Knob to activate the cursor and turn the **FMS** Knob to highlight the desired flight plan.
- 4) The Flight Plan Information is displayed showing departure, destination, total distance, and enroute safe altitude information for the selected Flight Plan.
- 5) Select the **EDIT** Softkey to open the Stored Flight Plan Page and view the waypoints in the flight plan.
- 6) Press the **FMS** Knob to exit the Stored Flight Plan Page.

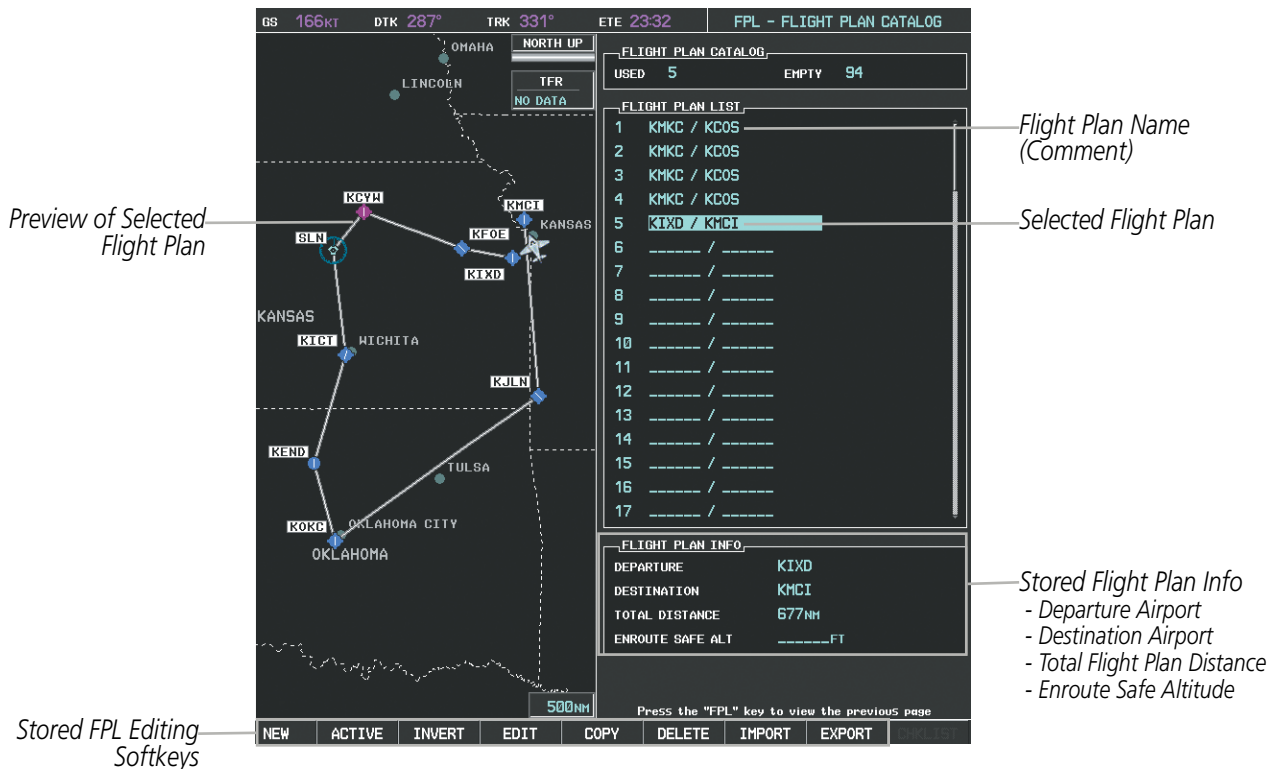

Figure 5-77 Stored Flight Plan Information

Storing an active flight plan from the Active Flight Plan Page or the Active Flight Plan Window:

- 1) Press the **MENU** Key.
- 2) Highlight 'Store Flight Plan'.
- 3) Press the **ENT** Key.
- 4) With 'OK' highlighted, press the **ENT** Key. The flight plan is stored in the next available position in the flight plan list on the Flight Plan Catalog Page.

ACTIVATE A FLIGHT PLAN

Activating a stored flight plan erases the active flight plan and replaces it with the flight plan being activated. Inverting a stored flight plan reverses the waypoint order, erases the active flight plan, and replaces it with the flight plan being activated (the stored flight plan is not changed)

Activating a stored flight plan on the MFD:

- 1) Press the **FPL** Key and turn the small **FMS** Knob to display the Flight Plan Catalog Page.
- 2) Press the **FMS** Knob to activate the cursor, and turn the **FMS** Knob to highlight the desired flight plan.
- 3) Select the **ACTIVE** Softkey; or press the **ENT** Key twice; or press the **MENU** Key, highlight 'Activate Flight Plan', and press the **ENT** Key. The 'Activate Stored Flight Plan?' window is displayed.
- 4) With 'OK' highlighted, press the **ENT** Key. To cancel the request, press the **CLR** Key, or highlight 'CANCEL' and press the **ENT** Key.

Inverting and activating a stored flight plan on the MFD:

- 1) Press the **FPL** Key and turn the small **FMS** Knob to display the Flight Plan Catalog Page.
- 2) Press the **FMS** Knob to activate the cursor, and turn the **FMS** Knob to highlight the desired flight plan.
- 3) Select the **INVERT** Softkey; or press the **MENU** Key, highlight 'Invert & Activate FPL?', and press the **ENT** Key. The 'Invert and activate stored flight plan?' window is displayed.
- 4) With 'OK' highlighted, press the **ENT** Key. To cancel the request, press the **CLR** Key, or highlight 'CANCEL' and press the **ENT** Key.

COPY A FLIGHT PLAN

The G1000 allows copying a flight plan into a new flight plan memory slot, allowing editing, etc., without affecting the original flight plan. This can be used to duplicate an existing stored flight plan for use in creating a modified version of the original stored flight plan.

Copying a stored flight plan on the MFD:

- 1) Press the **FPL** Key and turn the small **FMS** Knob to display the Flight Plan Catalog Page.
- 2) Press the **FMS** Knob to activate the cursor, and turn the **FMS** Knob to highlight the desired flight plan.
- 3) Select the **COPY** Softkey; or press the **MENU** Key, highlight 'Copy Flight Plan', and press the **ENT** Key. The 'Copy to Flight Plan XX?' window is displayed.
- 4) With 'OK' highlighted, press the **ENT** Key to copy the flight plan. To cancel the request, press the **CLR** Key, or highlight 'CANCEL' and press the **ENT** Key.

DELETE A STORED FLIGHT PLAN

Individual or all stored flight plans can be deleted from the G1000 memory.

Deleting a stored flight plan:

- 1) Press the **FPL** Key and turn the small **FMS** Knob to display the Flight Plan Catalog Page.
- 2) Press the **FMS** Knob to activate the cursor, and turn the **FMS** Knob to highlight the desired flight plan.
- 3) Select the **DELETE** Softkey; press the **CLR** Key; or press the **MENU** Key, highlight 'Delete Flight Plan', and press the **ENT** Key. The 'Delete Flight Plan XX?' window is displayed.
- 4) With 'OK' highlighted, press the **ENT** Key to delete the flight plan. To cancel the request, press the **CLR** Key, or highlight 'CANCEL' and press the **ENT** Key.



NOTE: The option to delete all stored flight plans is not available while the aircraft is in flight.

Deleting all stored flight plans:

- 1) Press the **FPL** Key and turn the small **FMS** Knob to display the Flight Plan Catalog Page.
- 2) Press the **MENU** Key.
- 3) Highlight 'Delete All' and press the **ENT** Key. A 'Delete all flight plans?' confirmation window is displayed.
- 4) With 'OK' highlighted, press the **ENT** Key to delete all flight plans. To cancel the request, press the **CLR** Key, or highlight 'CANCEL' and press the **ENT** Key.

FLIGHT PLAN EDITING

The active flight plan or any stored flight plan can be edited. The edits made to the active flight plan affect navigation as soon as they are entered.

DELETING THE ACTIVE FLIGHT PLAN

The G1000 allows deleting an active flight plan. Deleting the active flight plan suspends navigation by the G1000.

Deleting the active flight plan:

- 1) Press the **FPL** Key to display the Active Flight Plan Page (MFD) or the Active Flight Plan Window (PFD).
- 2) Press the **MENU** Key, highlight 'Delete Flight Plan', and press the **ENT** Key. The 'Delete all waypoints in flight plan?' window is displayed.
- 3) With 'OK' highlighted, press the **ENT** Key to delete the active flight plan. To cancel the request, press the **CLR** Key, or highlight 'CANCEL' and press the **ENT** Key.

DELETING FLIGHT PLAN ITEMS

Individual waypoints, entire airways, and entire procedures can be deleted from a flight plan. Some waypoints in the final approach segment (such as the FAF or MAP) can not be deleted individually. Attempting to delete a waypoint that is not allowed results in a window displaying 'Invalid flight plan modification.'

Deleting an individual waypoint from the active flight plan:

- 1) Press the **FPL** Key to display the Active Flight Plan Page (MFD) or the Active Flight Plan Window (PFD).
- 2) Press the **FMS** Knob to activate the cursor (not required on the PFD) and turn the large **FMS** Knob to highlight the waypoint to be deleted.
- 3) Press the **CLR** Key. The 'Remove XXXXX?' window is displayed.
- 4) With 'OK' highlighted, press the **ENT** Key. To cancel the request, press the **CLR** Key, or highlight 'CANCEL' and press the **ENT** Key.
- 5) Press the **FMS** Knob to remove the flashing cursor.

Deleting an entire airway from the active flight plan:

- 1) Press the **FPL** Key to display the Active Flight Plan Page (MFD) or the Active Flight Plan Window (PFD).
- 2) Press the **FMS** Knob to activate the cursor (not required on the PFD) and turn the large **FMS** Knob to highlight the white header of the airway to be deleted.
- 3) Press the **CLR** Key. The 'Remove <airway name>?' window is displayed.
- 4) With 'OK' highlighted, press the **ENT** Key. To cancel the request, press the **CLR** Key, or highlight 'CANCEL' and press the **ENT** Key.
- 5) Press the **FMS** Knob to remove the flashing cursor.

Deleting an entire procedure from the active flight plan:

- 1) Press the **FPL** Key to display the Active Flight Plan Page (MFD) or the Active Flight Plan Window (PFD).
- 2) Press the **FMS** Knob to activate the cursor (not required on the PFD) and turn the large **FMS** Knob to highlight the white header of the procedure to be deleted.
- 3) Press the **CLR** Key. The 'Remove <procedure name> from flight plan?' window is displayed.
- 4) With 'OK' highlighted, press the **ENT** Key. To cancel the request, press the **CLR** Key, or highlight 'CANCEL' and press the **ENT** Key.
- 5) Press the **FMS** Knob to remove the flashing cursor.

Or:

- 1) Press the **FPL** Key to display the Active Flight Plan Page (MFD) or the Active Flight Plan Window (PFD).
- 2) Press the **MENU** Key to display the Page Menu and turn the **FMS** Knob to highlight 'Remove <procedure>'.
3) Press the **ENT** Key. The 'Remove <procedure name> from flight plan?' window is displayed.
- 4) With 'OK' highlighted, press the **ENT** Key. To cancel the request, press the **CLR** Key, or highlight 'CANCEL' and press the **ENT** Key.

Deleting an individual waypoint from a stored flight plan:

- 1) Press the **FPL** Key to display the Active Flight Plan Page.
- 2) Turn the small **FMS** Knob clockwise one click to display the Flight Plan Catalog Page.
- 3) Press the **FMS** Knob to activate the cursor and turn the **FMS** Knob to highlight the flight plan to be edited.
- 4) Select the **EDIT** Softkey; or press the **MENU** Key, select 'Edit Flight Plan' and press the **ENT** Key. The Stored Flight Plan Page is displayed.
- 5) Turn the large **FMS** Knob to highlight the waypoint to be deleted.
- 6) Press the **CLR** Key. The 'Remove XXXXX?' window is displayed.
- 7) With 'OK' highlighted, press the **ENT** Key. To cancel the request, press the **CLR** Key, or highlight 'CANCEL' and press the **ENT** Key.
- 8) Press the **FMS** Knob to remove the flashing cursor.

Deleting an entire airway from a stored flight plan:

- 1) Press the **FPL** Key to display the Active Flight Plan Page.
- 2) Turn the small **FMS** Knob clockwise one click to display the Flight Plan Catalog Page.
- 3) Press the **FMS** Knob to activate the cursor and turn the **FMS** Knob to highlight the flight plan to be edited.
- 4) Select the **EDIT** Softkey; or press the **MENU** Key, select 'Edit Flight Plan' and press the **ENT** Key. The Stored Flight Plan Page is displayed.
- 5) Turn the large **FMS** Knob to highlight the white header of the airway to be deleted.
- 6) Press the **CLR** Key. The 'Remove <airway name>?' window is displayed.
- 7) With 'OK' highlighted, press the **ENT** Key. To cancel the request, press the **CLR** Key, or highlight 'CANCEL' and press the **ENT** Key.
- 8) Press the **FMS** Knob to remove the flashing cursor.

Deleting an entire procedure from a stored flight plan:

- 1) Press the **FPL** Key to display the Active Flight Plan Page.
- 2) Turn the small **FMS** Knob clockwise one click to display the Flight Plan Catalog Page.
- 3) Press the **FMS** Knob to activate the cursor and turn the **FMS** Knob to highlight the flight plan to be edited.
- 4) Select the **EDIT** Softkey; or press the **MENU** Key, select 'Edit Flight Plan' and press the **ENT** Key. The Stored Flight Plan Page is displayed.
- 5) Turn the large **FMS** Knob to highlight the white header of the procedure to be deleted.
- 6) Press the **CLR** Key. The 'Remove <procedure name> from flight plan?' window is displayed.
- 7) With 'OK' highlighted, press the **ENT** Key. To cancel the request, press the **CLR** Key, or highlight 'CANCEL' and press the **ENT** Key.
- 8) Press the **FMS** Knob to remove the flashing cursor.

Or:

- 1) Press the **FPL** Key to display the Active Flight Plan Page.
- 2) Turn the small **FMS** Knob clockwise one click to display the Flight Plan Catalog Page.
- 3) Press the **FMS** Knob to activate the cursor and turn the **FMS** Knob to highlight the flight plan to be edited.
- 4) Select the **EDIT** Softkey; or press the **MENU** Key, select 'Edit Flight Plan' and press the **ENT** Key. The Stored Flight Plan Page is displayed.
- 5) Press the **MENU** Key to display the Page Menu and turn the **FMS** Knob to highlight 'Remove <procedure>'.
6) Press the **ENT** Key. The 'Remove <procedure name> from flight plan?' window is displayed.
- 7) With 'OK' highlighted, press the **ENT** Key. To cancel the request, press the **CLR** Key, or highlight 'CANCEL' and press the **ENT** Key.
- 8) Press the **FMS** Knob to remove the flashing cursor.

CHANGING FLIGHT PLAN COMMENTS (NAMES)

The comment field (or name) of each flight plan can be changed to something that is useful for identification and sorting.

Changing the active flight plan comment:

- 1) Press the **FPL** Key to display the Active Flight Plan Page.
- 2) Press the **FMS** Knob to activate the cursor and turn the large **FMS** Knob to highlight the comment field.
- 3) Use the **FMS** Knobs to edit the comment.
- 4) Press the **ENT** Key to accept the changes.
- 5) Press the **FMS** Knob to remove the flashing cursor.

Changing a stored flight plan comment:

- 1) Press the **FPL** Key to display the Active Flight Plan Page.
- 2) Turn the small **FMS** Knob clockwise one click to display the Flight Plan Catalog Page.
- 3) Press the **FMS** Knob to activate the cursor and turn the **FMS** Knob to highlight the flight plan to be edited.
- 4) Select the **EDIT** Softkey; or press the **MENU** Key, select 'Edit Flight Plan' and press the **ENT** Key. The Stored Flight Plan Page is displayed.
- 5) Turn the large **FMS** Knob to highlight the comment field.
- 6) Use the **FMS** Knobs to edit the comment.
- 7) Press the **ENT** Key to accept the changes.
- 8) Press the **FMS** Knob to remove the flashing cursor.

ALONG TRACK OFFSETS

A waypoint having an "along track offset" distance from an existing waypoint can be entered into a flight plan. Along track offset waypoints lie along the path of the existing flight plan, and can be used to make the system reach a specified altitude before or after reaching the specified flight plan waypoint. Offset distances can be

entered from 1 to 99 nm in increments of 1 nm. Entering a negative offset distance results in an along track offset waypoint inserted before the selected waypoint, whereas entering a positive offset distance results in an along track offset waypoint inserted after the selected waypoint. Multiple offset waypoints are allowed.

A waypoint must be adjacent to its parent waypoint in the flight plan, so the system limits the along-track distance to less than the length of the leg before or after the selected waypoint. If the selected waypoint is the active waypoint, the distance is limited to less than the distance to go to the active waypoint. Assigning an along track offset to a leg with indeterminate length is not permitted. An along track offset is not allowed at or after the final approach fix of an approach.

An along track offset distance cannot be modified once entered. If the along track offset distance must be changed, the existing along track offset waypoint must be deleted and a new one created with the new offset distance.

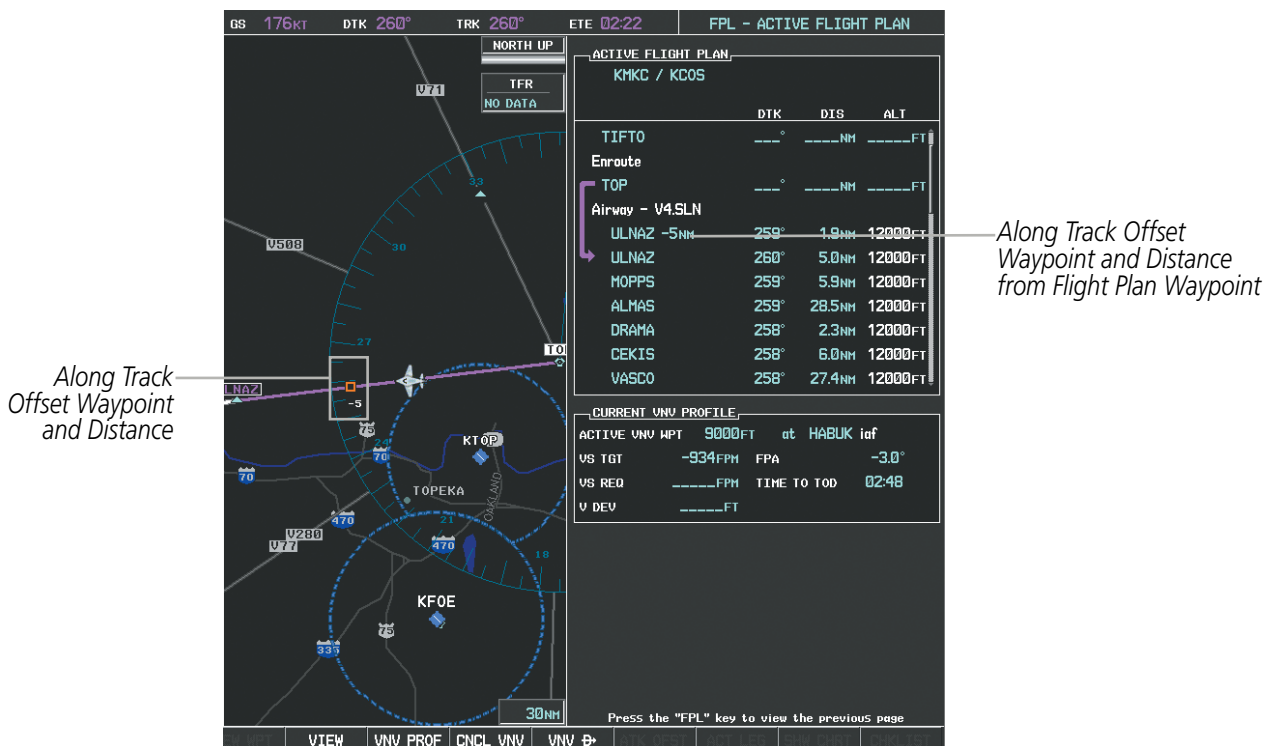

Figure 5-78 Along Track Offset

Entering an along track offset distance:

- 1) Press the **FPL** Key to display the Active Flight Plan Page (MFD) or the Active Flight Plan Window (PFD).
- 2) Press the **FMS** Knob to activate the cursor (not required on the PFD) and turn the large **FMS** Knob to highlight the waypoint for the along track offset.
- 3) Select the **ATK OFST** Softkey (MFD only); or press the **MENU** Key, highlight 'Create ATK Offset Waypoint', and press the **ENT** Key.
- 4) Enter a positive or negative offset distance in the range of +/- 1 to 99 nm (limited by leg distances).
- 5) Press the **ENT** Key to create the offset waypoint.
- 6) Press the **FMS** Knob to remove the flashing cursor.

PARALLEL TRACK

The Parallel Track (PTK) feature allows creation of a parallel course offset of 1 to 50 nm left or right of the current flight plan. When Parallel Track is activated, the course line drawn on the map pages shows the parallel course, and waypoint names have a lower case “p” placed after the identifier.

Using direct-to, loading an approach, a holding pattern, or editing and activating the flight plan automatically cancels Parallel Track. Parallel Track is also cancelled if a course change occurs greater than 120° or the parallel tracks overlap as a result of the course change.



NOTE: Vertical navigation is unavailable while the Parallel Track feature is active.

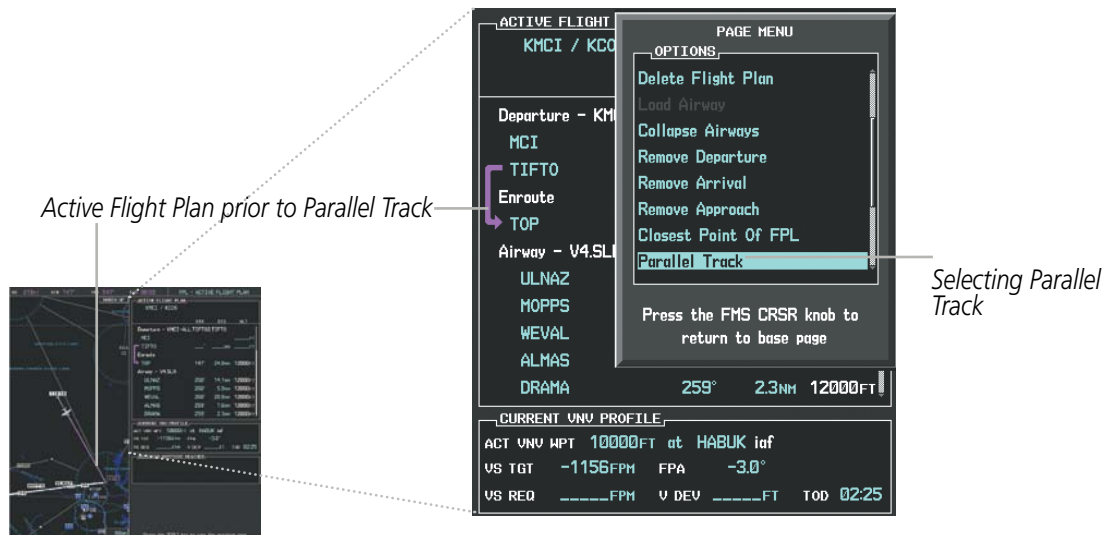

Figure 5-79 Active Flight Plan Window - Selecting Parallel Track

Activating parallel track:

- 1) Press the **FPL** Key to display the Active Flight Plan Page (MFD) or the Active Flight Plan Window (PFD)
- 2) Press the **MENU** Key, highlight 'Parallel Track', and press the **ENT** Key. The Parallel Track Window is displayed with the direction field highlighted.
- 3) Turn the small **FMS** Knob to select 'Left' or 'Right' and press the **ENT** Key. The 'DISTANCE' field is highlighted.
- 4) Turn the small **FMS** Knob to enter a distance from 1-99 nm and press the **ENT** Key. 'ACTIVATE PARALLEL TRACK' is highlighted.
- 5) Press the **ENT** Key to activate parallel track. Press the **FMS** Knob or the **CLR** Key to cancel the parallel track activation.

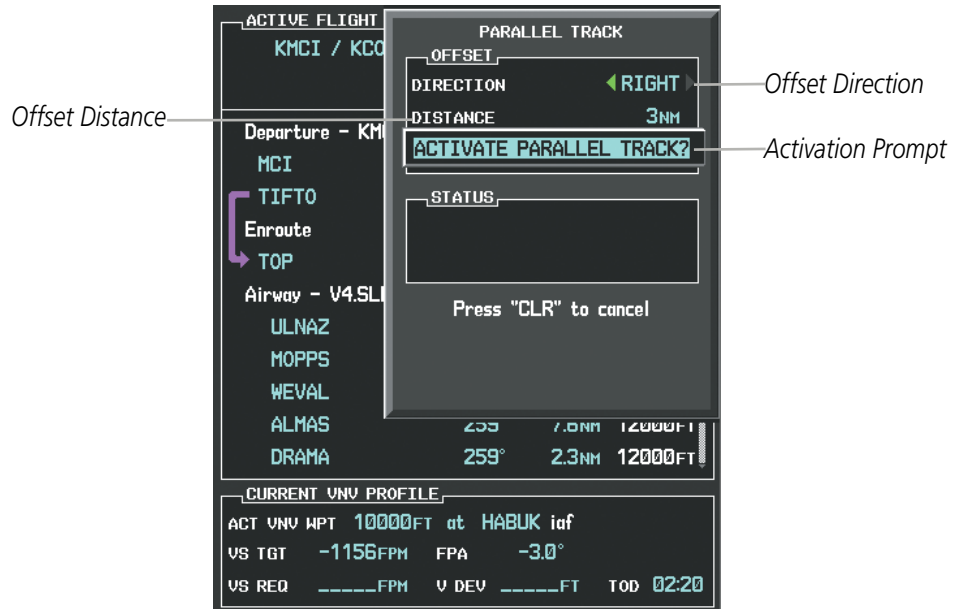

Figure 5-80 Parallel Track Window

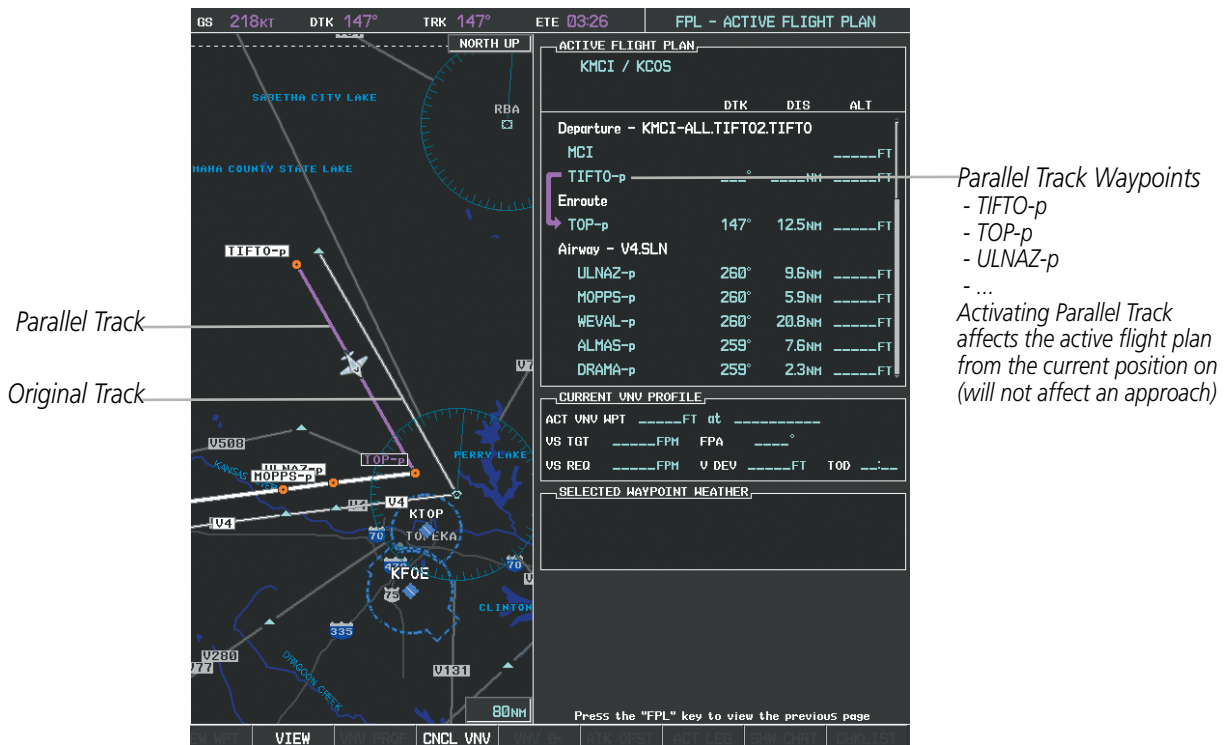

Figure 5-81 Parallel Track Active

If the parallel track proposed by the offset direction and distance is not allowed by the system, the activation prompt is displayed, but disabled. Parallel Track cannot be activated if a course is set using direct-to or if the active leg is the first leg of the departure procedure. Attempting to activate parallel track with these conditions results in the message ‘Parallel Track Unavailable Invalid Route Geometry’. If an approach leg is active the status indicates that the system is unable to activate the parallel track with the message ‘Parallel Track Unavailable

Approach Leg Active'. If the offset direction and distance results in an unreasonable route geometry the status indicates that the system is unable to activate the parallel track because of invalid geometry.

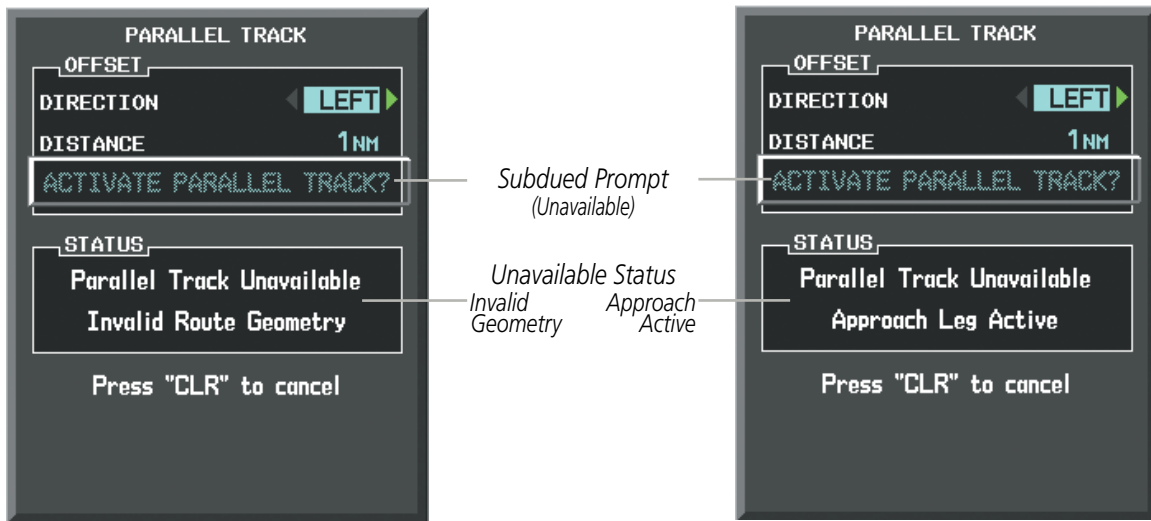

Figure 5-82 Parallel Track Unavailable

If the active leg is not a track between two fixes (TF) or a course to a fix (DF) leg, the status indicates that the system is unable to activate the parallel track because parallel track is not available for the active leg type.

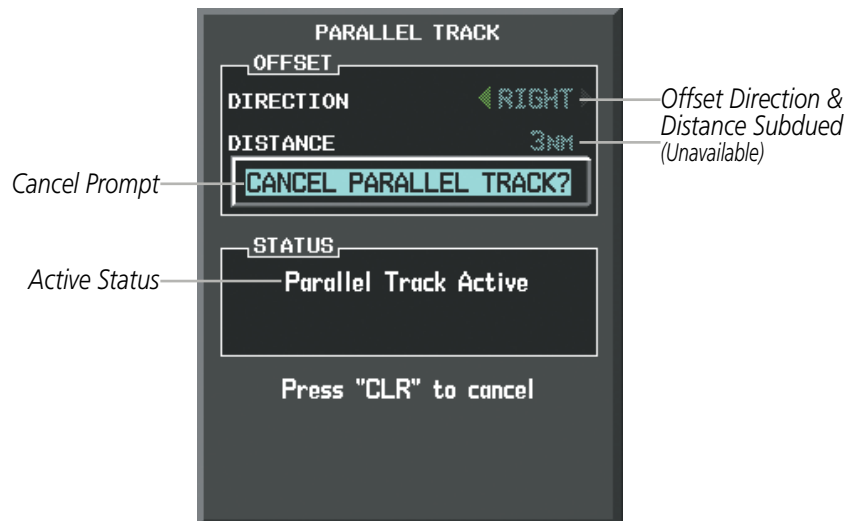

Figure 5-83 Cancelling Parallel Track

Cancelling parallel track:

- 1) Press the **FPL** Key to display the Active Flight Plan Page (MFD) or the Active Flight Plan Window (PFD)
- 2) Press the **MENU** Key, highlight 'Parallel Track', and press the **ENT** Key. The Parallel Track Window is displayed with 'CANCEL PARALLEL TRACK?' highlighted.
- 3) Press the **ENT** Key.

ACTIVATING A FLIGHT PLAN LEG

The G1000 allows selection of a highlighted leg as the “active leg” (the flight plan leg which is currently used for navigation guidance).

Activating a flight plan leg:

- 1) Press the **FPL** Key to display the Active Flight Plan Page (MFD) or the Active Flight Plan Window (PFD)
- 2) Press the **FMS** Knob to activate the cursor (not required on the PFD) and turn the large **FMS** Knob to highlight the destination waypoint for the desired leg.
- 3) Select the **ACT LEG** Softkey (MFD only); or press the **MENU** Key, highlight ‘Activate Leg’, and press the **ENT** Key. A confirmation window is displayed with ‘ACTIVATE’ highlighted.
- 4) Press the **ENT** Key to activate the flight plan leg. To cancel, press the **CLR** Key, or highlight ‘CANCEL’ and press the **ENT** Key.
- 5) Press the **FMS** Knob to remove the flashing cursor.

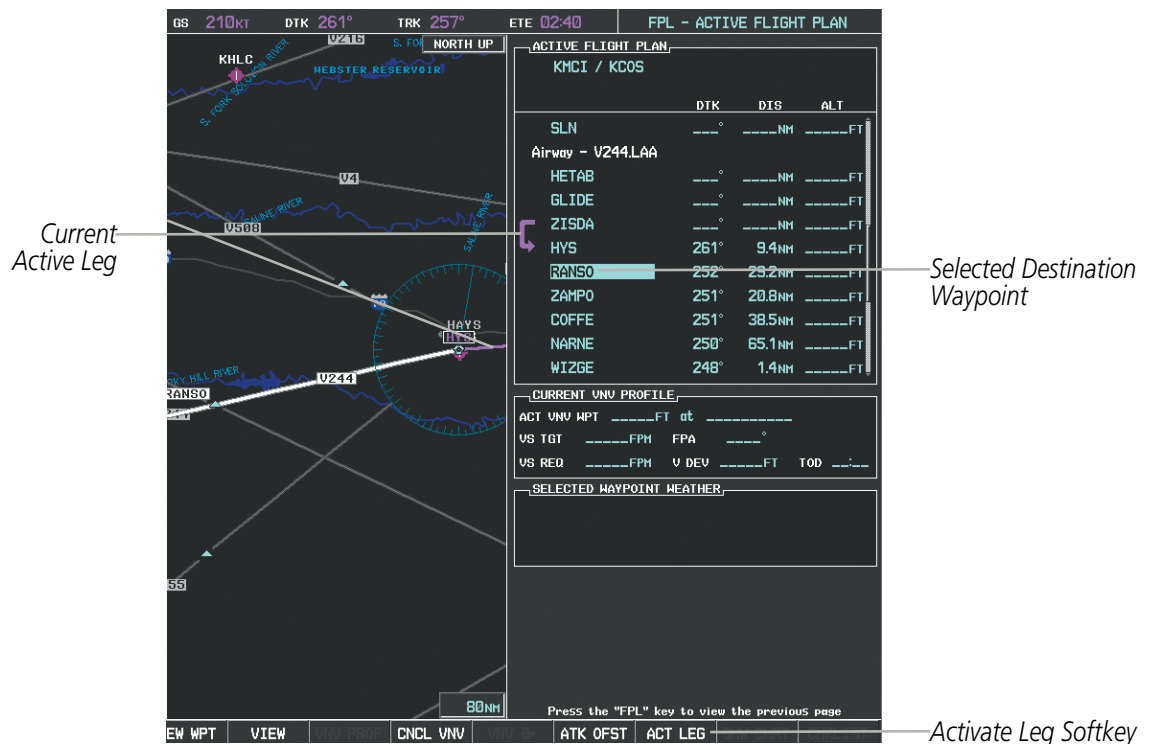

Figure 5-84 Active Flight Plan Page - Selecting the Leg Destination Waypoint



Figure 5-85 Active Flight Plan Page - New Active Leg

INVERTING A FLIGHT PLAN

Any flight plan may be inverted (reversed) for navigation back to the original departure point.

Inverting the active flight plan:

- 1) Press the **FPL** Key to display the Active Flight Plan Page (MFD) or the Active Flight Plan Window (PFD)
- 2) Press the **MENU** Key, highlight 'Invert Flight Plan', and press the **ENT** Key. An 'Invert Active Flight Plan?' confirmation window is displayed.
- 3) Select 'OK'.
- 4) Press the **ENT** Key to invert and activate the active flight plan. To cancel, press the **CLR** Key, or highlight 'CANCEL' and press the **ENT** Key.

Inverting and activating a stored flight plan:

- 1) Press the **FPL** Key and turn the small **FMS** Knob to display the Flight Plan Catalog Page.
- 2) Press the **FMS** Knob to activate the cursor, and turn the **FMS** Knob to highlight the desired flight plan.
- 3) Select the **INVERT** Softkey; or press the **MENU** Key, highlight 'Invert & Activate FPL?', and press the **ENT** Key. The 'Invert and activate stored flight plan?' window is displayed.
- 4) With 'OK' highlighted, press the **ENT** Key. To cancel the request, press the **CLR** Key, or highlight 'CANCEL' and press the **ENT** Key.

FLIGHT PLAN VIEWS

Information about flight plans can be viewed in more than one way. The active flight plan can be configured to show cumulative distance over the length of the flight plan or the distance for each leg of the flight plan; and the active flight plan can be viewed in a narrow or wide view. In the wide view, additional information is displayed: Fuel Remaining (FUEL REM), Estimated Time Enroute (ETE), Estimated Time of Arrival (ETA), and Bearing to the waypoint (BRG).

Switching between leg-to-leg waypoint distance and cumulative waypoint distance:

- 1) Press the **FPL** Key on the MFD to display the Active Flight Plan Page.
- 2) Select the **VIEW** Softkey to display the **CUM** and **LEG-LEG** Softkeys.
- 3) Select the **CUM** Softkey to view cumulative waypoint distance, or select the **LEG-LEG** Softkey to view leg-to-leg waypoint distance.
- 4) Select the **BACK** Softkey to return to the top level active flight plan softkeys.

Active Flight Plan Leg to Leg Distance

Active Flight Plan Cumulative Distance



WIDE Softkey, NARROW Softkey, LEG-LEG Softkey, CUM Softkey

Figure 5-86 Active Flight Plan - Leg to Leg vs. Cumulative Distance

Switching between wide and narrow view:

- 1) Press the **FPL** Key on the MFD to display the Active Flight Plan Page.
- 2) Select the **VIEW** Softkey to display the **WIDE** and **NARROW** Softkeys.
- 3) Select the **WIDE** Softkey to display the wide view, or select the **NARROW** Softkey to display the narrow view.
- 4) Select the **BACK** Softkey to return to the top level active flight plan softkeys.

Active Flight Plan Narrow View

Active Flight Plan Wide View

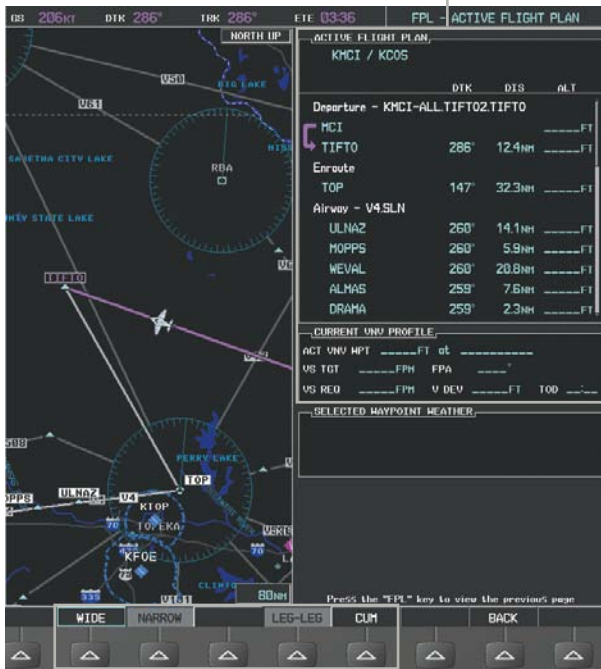

WIDE Softkey, NARROW Softkey, LEG-LEG Softkey, CUM Softkey

Figure 5-87 Active Flight Plan - Wide vs. Narrow View

COLLAPSING AIRWAYS

The G1000 allows airways on the active flight plan to be collapsed or expanded from the Active Flight Plan Page/Window. When airways have been collapsed, it is indicated on the airway heading.

When airways are collapsed, leg-to-leg computed values such as DIS or ETE shown for the exit waypoint reflect the total of all the legs on the airway that have been hidden in the collapsed display. The DTK value is inhibited because it is not usable in this context.

The Active Flight Plan Page always keeps the following three waypoints visible: “From” waypoint, “To” waypoint, and “Next” waypoint. To prevent one or more of these waypoints from being hidden in a collapsed airway segment, the airway segment that contains either the “To” or the “Next” waypoint is automatically expanded. When an airway is loaded, airways are automatically expanded to facilitate flight plan review.

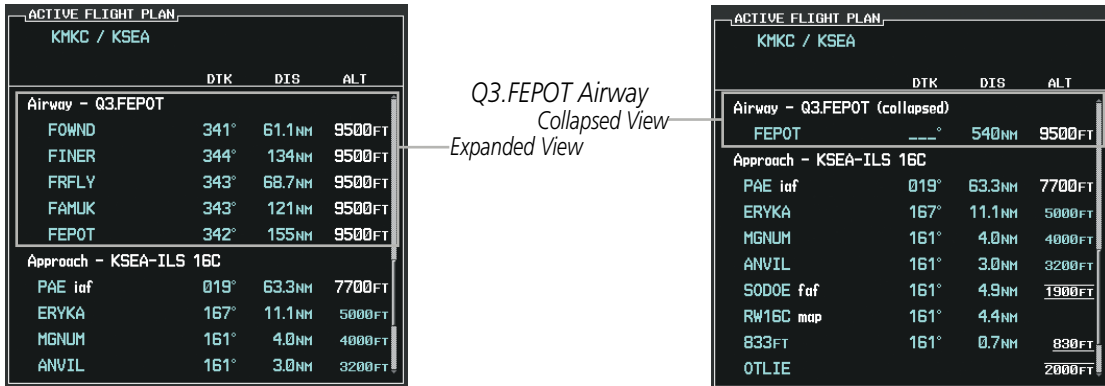

Figure 5-88 Expanded/Collapsed Airways

Collapsing/expanding the airways in the active flight plan:

- 1) Press the **FPL** Key to display the Active Flight Plan Page (MFD) or the Active Flight Plan Window (PFD).
- 2) Press the **MENU** Key, highlight 'Collapse Airways' or 'Expand Airways', and press the **ENT** Key. The airways are collapsed/expanded.

CLOSEST POINT OF FPL

'Closest Point of FPL' calculates the bearing and closest distance at which a flight plan passes a reference waypoint, and creates a new user waypoint along the flight plan at the location closest to a chosen reference waypoint.

Determining the closest point along the active flight plan to a selected waypoint:

- 1) Press the **FPL** Key to display the Active Flight Plan Page (MFD) or the Active Flight Plan Window (PFD).
- 2) Press the **MENU** Key, highlight 'Closest Point Of FPL', and press the **ENT** Key. A window appears with the reference waypoint field highlighted.
- 3) Enter the identifier of the reference waypoint and press the **ENT** Key. The G1000 displays the bearing (BRG) and distance (DIS) to the closest point along the flight plan to the selected reference waypoint and creates a user waypoint at this location. The name for the new user waypoint is derived from the identifier of the reference waypoint.

5.7 VERTICAL NAVIGATION



NOTE: The G1000 supports vertical navigation for all lateral leg types except for CA, CI, FA, FM, HA, HM, PI, VA, VD, VI, VR, and VM. Vertical constraints are not retained in stored flight plans.

The G1000 system Vertical Navigation (VNV) feature provides vertical profile guidance during the enroute and terminal phases of flight. Guidance based on specified altitudes at waypoints in the active flight plan or to a direct-to waypoint is provided. It includes vertical path guidance to a descending path, which is provided as a linear deviation from the desired path. The desired path is defined by a line joining two waypoints with specified altitudes or as a vertical angle from a specified waypoint/altitude. The vertical waypoints are integrated into the active flight plan. Both manual and autopilot-coupled guidance are supported.

Current Vertical Navigation Profile
Disabled (fields dashed)

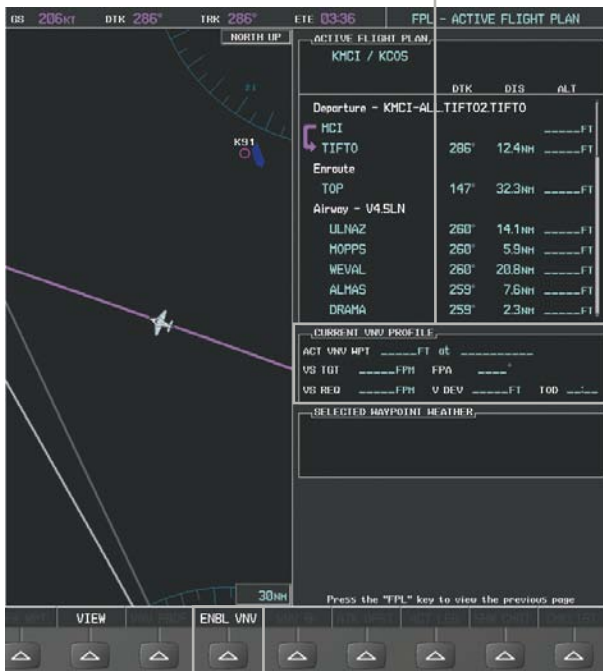

ENBL VNV Softkey

Current Vertical Navigation Profile
Enabled (valid data)

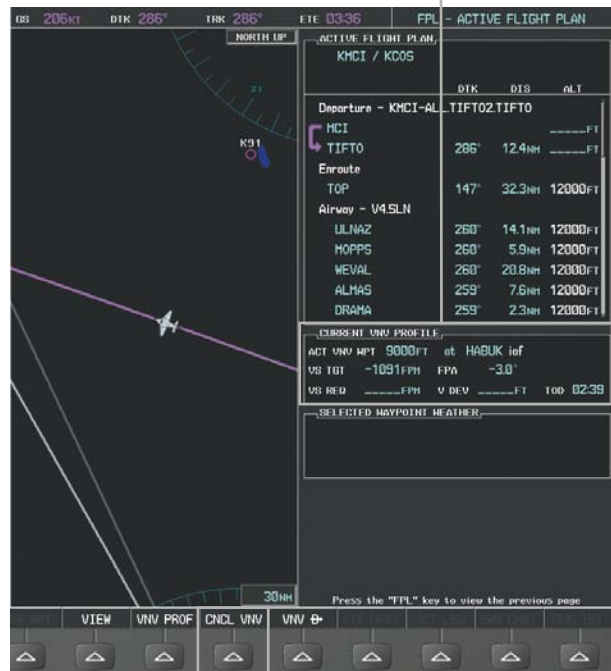

CNCL VNV Softkey

Figure 5-89 Enabling/Disabling Vertical Navigation

Enabling VNV guidance:

- 1) Press the **FPL** Key to display the Active Flight Plan Page on the MFD.
- 2) Select the **ENBL VNV** Softkey; or press the **MENU** Key, highlight 'Enable VNV', and press the **ENT** Key. Vertical navigation is enabled, and vertical guidance begins with the waypoint shown in the CURRENT VNV PROFILE box (defaults first waypoint in the active flight plan with an altitude enabled for vertical navigation (e.g., HABUK)).

Disabling VNV guidance:

- 1) Press the **FPL** Key to display the Active Flight Plan Page on the MFD.
- 2) Select the **CNCL VNV** Softkey; or press the **MENU** Key, highlight 'Cancel VNV', and press the **ENT** Key. Vertical navigation is disabled.

Canceling vertical navigation results in vertical deviation (V DEV), vertical speed required (VS REQ), and time to top of descent/bottom of descent (TIME TO TOD/BOD) going invalid. The Vertical Deviation Indicator (VDI) and Vertical Speed Required Indication (VSRI) on the PFD are removed, and the V DEV, VS REQ, and TIME TO TOD items displayed in the CURRENT VNV PROFILE box are dashed. VNV remains disabled until manually enabled. Vertical guidance in reversionary mode can only be enabled for a direct-to waypoint.

The G1000 allows a vertical navigation direct-to to any waypoint in the active flight plan with an altitude constraint “designated” for vertical guidance. Selecting the **VNV Direct-to** Softkey on the Active Flight Plan Page allows the flight plan to be flown, while vertical guidance based on the altitude constraint at the VNV direct-to waypoint is provided. The altitude change begins immediately and is spread along the flight plan from current position to the vertical direct-to waypoint, not just along the leg for the direct-to waypoint. A direct-to with altitude constraint activated by pressing the **Direct-to** Key also provides vertical guidance, but would bypass flight plan waypoints between the current position in the flight plan and the direct-to waypoint. A top of descent (TOD) point is computed based on the default flight path angle; descent begins once the TOD is reached.

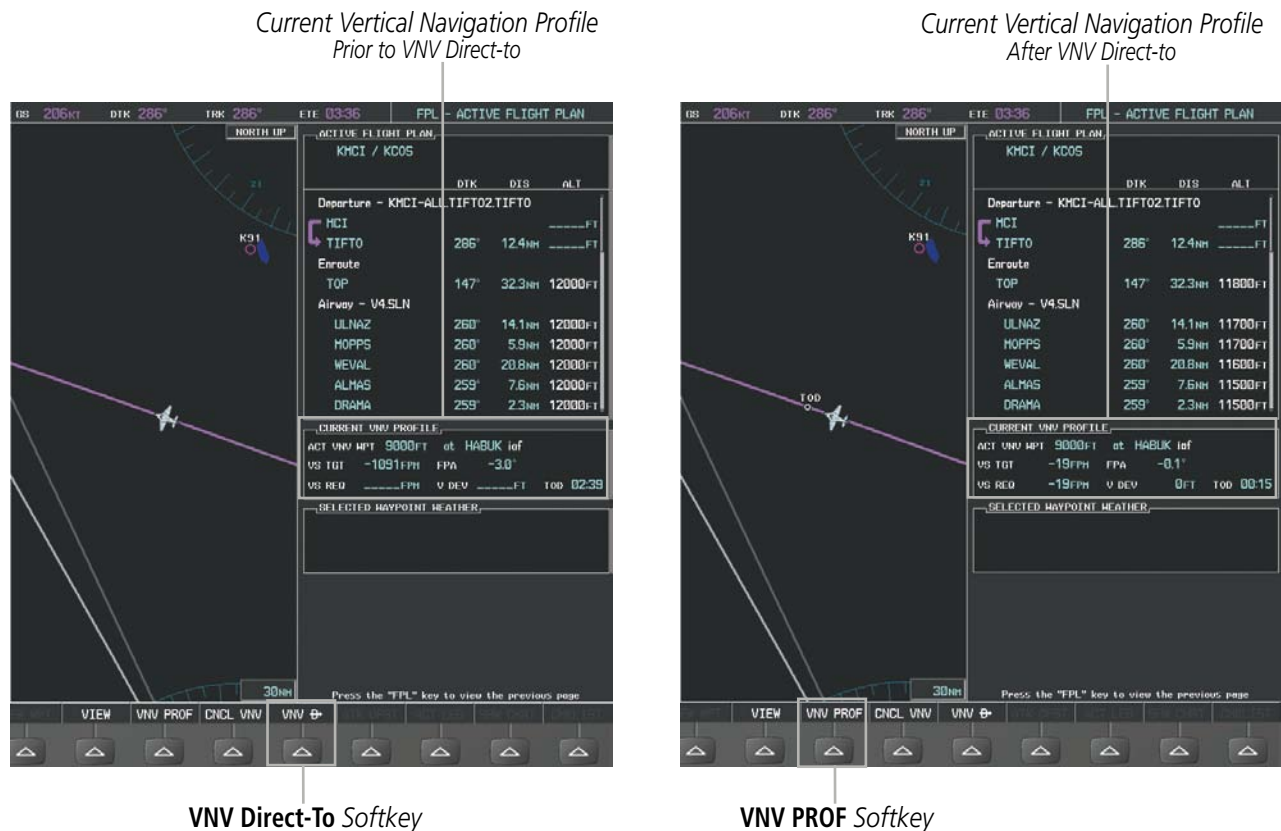

Figure 5-90 Vertical Navigation Direct-To

Activating a vertical navigation direct-to:

- 1) Press the **FPL** Key to display the Active Flight Plan Page on the MFD.
- 2) Press the **FMS** Knob to activate the cursor and turn the **FMS** Knob to highlight the desired waypoint.



NOTE: The selected waypoint must have a designated altitude constraint (light blue number) to be used. If not, the first waypoint in the flight plan with a designated altitude constraint is selected.

- 3) Select the **VNV Direct-To** Softkey; or press the **MENU** Key, highlight 'VNV Direct-To', and press the **ENT** Key. An 'Activate vertical Direct-to to: NNNNNFT at XXXXXX?' confirmation window is displayed.
- 4) Press the **ENT** Key. Vertical guidance begins to the altitude constraint for the selected waypoint.
- 5) Press the **FMS** Knob to remove the flashing cursor.

The vertical navigation profile can be modified by directly entering a vertical speed target (VS TGT) and/or flight path angle (FPA) in the CURRENT VNV PROFILE box.

Modifying the VS TGT and FPA:

- 1) Press the **FPL** Key to display the Active Flight Plan Page on the MFD.
- 2) Select the **VNV PROF** Softkey; or press the **MENU** Key, highlight 'Select VNV Profile Window', and press the **ENT** Key. The cursor is now located in the CURRENT VNV PROFILE box.
- 3) Turn the **FMS** Knobs as needed to edit the values.
- 4) Press the **FMS** Knob to remove the flashing cursor.

ALTITUDE CONSTRAINTS

The G1000 system can use altitude constraints associated with lateral waypoints to give guidance for vertical navigation. These altitudes are, depending on the specific instance, manually entered or retrieved from the published altitudes in the navigation database. The navigation database only contains altitudes for procedures that call for "Cross at" altitudes. If the procedure states "Expect to cross at," then the altitude is not in the database. In this case the altitude may be entered manually.

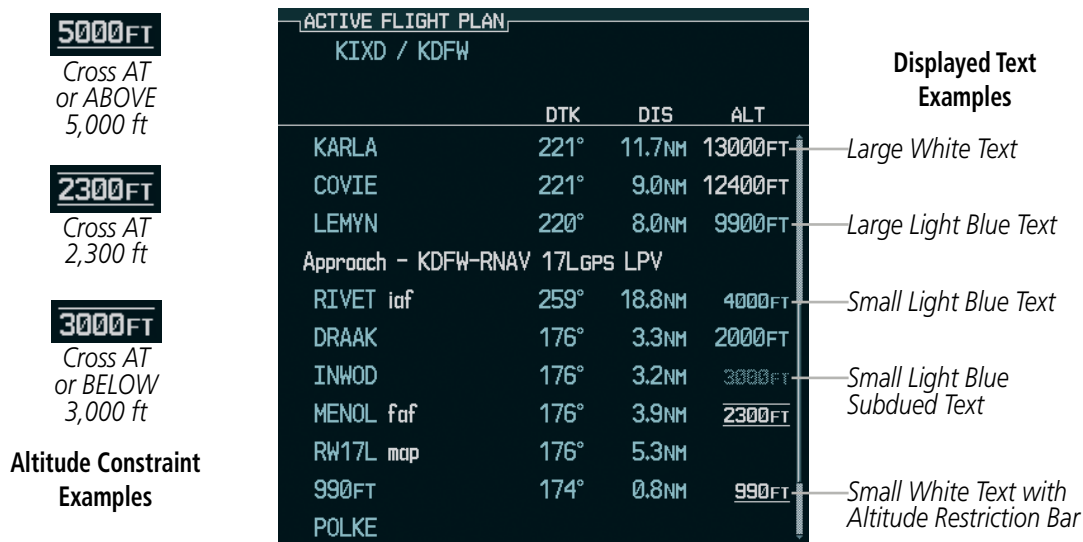

Figure 5-91 Waypoint Altitude Constraints

	White Text	Light Blue Text	Light Blue Subdued Text
Large Text	Altitude calculated by the system estimating the altitude of the aircraft as it passes over the navigation point. This altitude is provided as a reference and is not designated to be used in determining vertical speed and deviation guidance.	Altitude has been entered manually. Altitude is designated for use in giving vertical speed and deviation guidance. Altitude does not match the published altitude in navigation database or no published altitude exists.	The system cannot use this altitude in determining vertical speed and deviation guidance because of an invalid constraint condition.
Small Text	Altitude is not designated to be used in determining vertical speed and deviation guidance. Altitude has been retrieved from the navigation database and is provided as a reference.	Altitude is designated for use in giving vertical speed and deviation guidance. Altitude has been retrieved from the navigation database or has been entered manually and matches a published altitude in the navigation database.	The system cannot use this altitude in determining vertical speed and deviation guidance because of an invalid constraint condition.

Table 5-8 Altitude Constraint Size and Color Coding

Altitudes associated with arrival and approach procedures are not “auto-designated”. This means the system does not automatically use the altitudes loaded with the arrival or approach for giving vertical speed and deviation guidance. Note that these altitudes are displayed as white text up to, but not including, the FAF. The FAF is always a “reference only” altitude and cannot be designated, unless the selected approach does not provide vertical guidance. In this case, the FAF altitude can be designated.

Altitudes that have been designated for use in vertical guidance can be “un-designated” using the **CLR** Key. The altitude is now displayed only as a reference. It is not used to give vertical guidance. Other displayed altitudes may change due to re-calculations or be rendered invalid as a result of manually changing an altitude to a non-designated altitude.

Designating a waypoint altitude to be used for vertical guidance:

- 1) Press the **FPL** Key to display the Active Flight Plan Page on the MFD.
- 2) Press the **FMS** Knob, and turn to highlight the desired waypoint altitude.
- 3) Turn the small **FMS** Knob to enter editing mode.
- 4) Press the **ENT** Key. The altitude is now shown in blue, indicating it is usable for vertical guidance.

Designating a procedure waypoint altitude to be used for vertical guidance:

- 1) Press the **FPL** Key to display the Active Flight Plan Page on the MFD.
- 2) Press the **FMS** Knob, and turn to highlight the desired waypoint altitude.
- 3) Press the **ENT** Key. The altitude is now shown in blue, indicating it is usable for vertical guidance.

Altitude constraints are displayed and entered in feet mean sea level (MSL) values to the nearest hundred. An altitude constraint in feet above ground level (AGL) format is supported for airports. When a database altitude restriction is displayed, the G1000 allows entry of a different altitude when creating a waypoint, effectively overriding the database restriction (only before the FAF). When a database altitude restriction of type “AT or ABOVE” or “AT or BELOW” is activated, the system uses the “AT” portion of the restriction to define the vertical profile.

An altitude constraint is invalid if:

- Meeting the constraint requires the aircraft to climb
- Meeting the constraint requires the maximum flight path angle or maximum vertical speed to be exceeded
- The altitude constraint results in a TOD behind the aircraft present position
- The constraint is within a leg type for which altitude constraints are not supported
- The altitude constraint is added to the FAF of an approach that provides vertical guidance (i.e., ILS or GPS SBAS approach)
- The altitude constraint is added to a waypoint past the FAF

Entering/modifying an altitude constraint:

- 1) Press the **FPL** Key to display the Active Flight Plan Page on the MFD.
- 2) Press the **FMS** Knob, and turn to highlight the desired waypoint altitude constraint.
- 3) Enter an altitude constraint value using the **FMS** Knobs. To enter altitudes as a flight level, turn the small **FMS** Knob counter-clockwise past zero or clockwise past 9 on the first character, and the system automatically changes to show units of Flight Level. Turn the large **FMS** Knob clockwise to highlight the first zero and enter the three digit flight level.
- 4) Press the **ENT** Key to accept the altitude constraint; if the selected waypoint is an airport, an additional choice is displayed. Turn the small **FMS** Knob to choose 'MSL' or 'AGL', and press the **ENT** Key to accept the altitude.

Altitude constraints can be modified or deleted after having been added to the flight plan. In the event an altitude constraint is deleted and the navigation database contains an altitude restriction for the lateral waypoint, the G1000 displays the altitude restriction from the database provided no predicted altitude can be provided. The G1000 also provides a way to reinstate a published altitude constraint that has been edited.

Deleting (un-designating) an altitude constraint provided by the navigation database:

- 1) Press the **FPL** Key to display the Active Flight Plan Page on the MFD.
- 2) Press the **FMS** Knob, and turn to highlight the desired waypoint altitude constraint.
- 3) Press the **CLR** Key. A 'Remove VNV altitude constraint?' confirmation window is displayed.
- 4) Select 'OK' and press the **ENT** Key.

Deleting an altitude constraint that has been manually entered:

- 1) Press the **FPL** Key to display the Active Flight Plan Page on the MFD.
- 2) Press the **FMS** Knob, and turn to highlight the desired waypoint altitude constraint.
- 3) Press the **CLR** Key. A 'Remove or Revert to published VNV altitude of nnnnnFT?' confirmation window is displayed.
- 4) Select 'REMOVE' and press the **ENT** Key. The manually entered altitude is deleted (it is replaced by a system calculated altitude, if available).

Reverting a manually entered altitude constraint back to the navigation database value:

- 1) Press the **FPL** Key to display the Active Flight Plan Page on the MFD.
- 2) Press the **FMS** Knob, and turn to highlight the desired waypoint altitude constraint.
- 3) Press the **CLR** Key. A 'Remove or Revert to published VNV altitude of nnnnnFT?' confirmation window is displayed.
- 4) Select 'REVERT' and press the **ENT** Key. The altitude is changed to the navigation database value.
- 5) Press the **FMS** Knob to remove the flashing cursor.

Modifying a system calculated altitude constraint:

- 1) Press the **FPL** Key to display the Active Flight Plan Page on the MFD.
- 2) Press the **FMS** Knob, and turn to highlight the desired waypoint altitude constraint.
- 3) Press the **CLR** Key. An 'Edit or Revert to published VNV altitude of nnnnnFT?' confirmation window is displayed.
- 4) Select 'EDIT' and press the **ENT** Key.
- 5) Edit the value using the **FMS** Knobs, and press the **ENT** Key.
- 6) Press the **FMS** Knob to remove the flashing cursor.

5.8 PROCEDURES

The G1000 can access the whole range of instrument procedures available. Departures (DPs), arrivals (STARs), and non-precision and precision approaches (APPRs) are stored within the database and can be loaded using the Procedures (**PROC**) Key.

The selected procedure for the departure or arrival airport is added to the active flight plan. No waypoints are required to be in the active flight plan to load procedures; however, if the departure and arrival airport are already loaded, the procedure loading window defaults to the appropriate airport, saving some time selecting the correct airport on the Procedure Loading Page. Whenever an approach is selected, the choice to either “load” or “activate” is given. “Loading” adds the approach to the end of the flight plan without immediately using it for navigation guidance. This allows continued navigation via the intermediate waypoints in the original flight plan, but keeps the procedure available on the Active Flight Plan Page for quick activation when needed. “Activating” also adds the procedure to the end of the flight plan but immediately begins to provide guidance to the first waypoint in the approach.

DEPARTURES

A Departure Procedure (DP) is loaded at the departure airport in the flight plan. Only one departure can be loaded at a time in a flight plan. If a departure is loaded when another departure is already in the active flight plan, the new departure replaces the previous departure. The route is defined by selection of a departure, the transition waypoints, and a runway.

LOADING A DEPARTURE INTO THE ACTIVE FLIGHT PLAN

Loading a departure into the active flight plan using the **PROC** Key:

- 1) Press the **PROC** Key. The Procedures Window is displayed.
- 2) Highlight ‘SELECT DEPARTURE’.
- 3) Press the **ENT** Key. The Departure Loading Page is displayed.
- 4) Use the **FMS** Knob to select an airport and press the **ENT** Key.
- 5) Select a departure from the list and press the **ENT** Key.
- 6) Select a runway (if required) and press the **ENT** Key.
- 7) Select a transition (if required) and press the **ENT** Key. ‘LOAD?’ is highlighted.
- 8) Press the **ENT** Key to load the departure procedure.



Figure 5-92 Departure Selection



Figure 5-93 Departure Loading

Viewing available departures at an airport:

- 1) From the Airport Information Page (first page in the WPT group), select the **DP** Softkey. The Departure Information Page is displayed, defaulting to the airport displayed on the Airport information Page.
- 2) To select another airport, press the **FMS** Knob to activate the cursor, enter an identifier/facility name/city, and press the **ENT** Key.
- 3) Turn the large **FMS** Knob to highlight the Departure. The departure is previewed on the map.
- 4) Turn the small **FMS** Knob to view the available departures. Press the **ENT** Key to select the departure. The cursor moves to the Runway box. The departure is previewed on the map.
- 5) Turn the small **FMS** Knob to view the available runways. Press the **ENT** Key to select the runway. The cursor moves to the Transition box (only if there are available transitions). The departure is previewed on the map.
- 6) Turn the small **FMS** Knob to view the available transitions. Press the **ENT** Key to select the transition. The cursor moves to the Sequence box. The departure is previewed on the map.
- 7) Select the **INFO-x** Softkey to return to the Airport Information Page.

REMOVING A DEPARTURE FROM THE ACTIVE FLIGHT PLAN

When plans change while flying IFR, departures can be easily removed from the Active Flight Plan.

Removing a departure procedure from the active flight plan:

- 1) Press the **FPL** Key to display the Active Flight Plan Page (MFD) or the Active Flight Plan Window (PFD)
- 2) Press the **MENU** Key, and highlight 'Remove Departure'.
- 3) Press the **ENT** Key. A confirmation window is displayed listing the departure procedure.
- 4) With 'OK' highlighted, press the **ENT** Key. To cancel the removal request, highlight 'CANCEL' and press the **ENT** Key.

Or:

- 1) Press the **FPL** Key to display the Active Flight Plan Page (MFD) or the Active Flight Plan Window (PFD)
- 2) Press the **FMS** Knob, and turn to highlight the departure header in the active flight plan.
- 3) Press the **CLR** Key. A confirmation window is displayed listing the departure procedure.
- 4) With 'OK' highlighted, press the **ENT** Key. To cancel the removal request, highlight 'CANCEL' and press the **ENT** Key.
- 5) Press the **FMS** Knob to remove the flashing cursor.

ARRIVALS

A Standard Terminal Arrival (STAR) can be loaded at any airport that has one available. Only one arrival can be loaded at a time in a flight plan. If an arrival is loaded when another arrival is already in the active flight plan, the new arrival replaces the previous arrival. The route is defined by selection of an arrival, the transition waypoints, and a runway.

LOADING AN ARRIVAL INTO THE ACTIVE FLIGHT PLAN

Loading an arrival into the active flight plan using the PROC Key:

- 1) Press the **PROC** Key. The Procedures Window is displayed.
- 2) Highlight 'SELECT ARRIVAL'.
- 3) Press the **ENT** Key. The Arrival Loading Page is displayed.
- 4) Use the **FMS** Knob to select an airport and press the **ENT** Key.
- 5) Select an arrival from the list and press the **ENT** Key.
- 6) Select a transition (if required) and press the **ENT** Key.
- 7) Select a runway (if required) and press the **ENT** Key. 'LOAD?' is highlighted.
- 8) Press the **ENT** Key to load the arrival procedure.



Figure 5-94 Arrival Selection

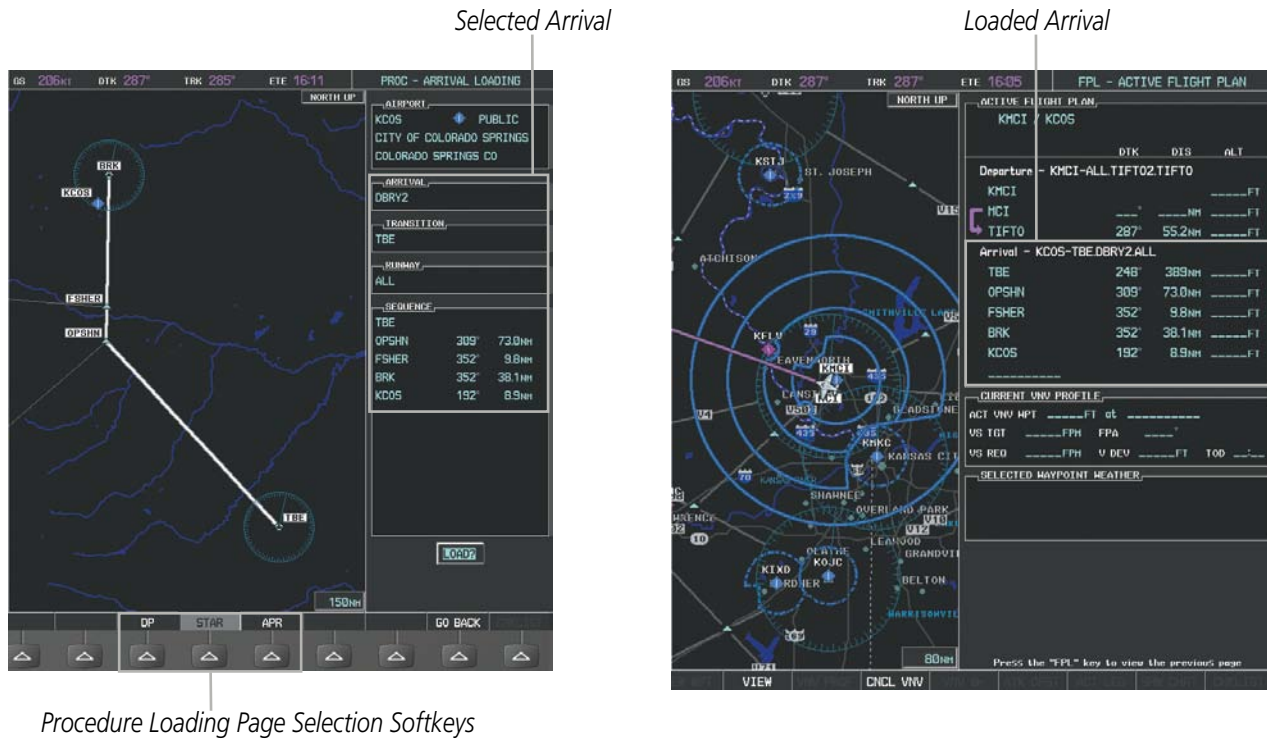

Figure 5-95 Arrival Loading

Viewing available arrivals at an airport:

- 1) From the Airport Information Page (first page in the WPT group), select the **STAR** Softkey. The Arrival Information Page is displayed, defaulting to the airport displayed on the Airport Information Page.
- 2) To select another airport, press the **FMS** Knob to activate the cursor, enter an identifier/facility name/city, and press the **ENT** Key.
- 3) Turn the large **FMS** Knob to highlight the Arrival. The arrival is previewed on the map.
- 4) Turn the small **FMS** Knob to view the available arrivals. Press the **ENT** Key to select the arrival. The cursor moves to the Transition box. The arrival is previewed on the map.
- 5) Turn the small **FMS** Knob to view the available transitions. Press the **ENT** Key to select the transition. The cursor moves to the Runway box. The arrival is previewed on the map.
- 6) Turn the small **FMS** Knob to view the available runways. Press the **ENT** Key to select the runway. The cursor moves to the Sequence box. The arrival is previewed on the map.
- 7) Select the **INFO-x** Softkey to return to the Airport Information Page.

REMOVING AN ARRIVAL FROM THE ACTIVE FLIGHT PLAN

When plans change while flying IFR, arrivals can be easily removed from the Active Flight Plan.

Removing an arrival from the active flight plan:

- 1) Press the **FPL** Key to display the Active Flight Plan Page (MFD) or the Active Flight Plan Window (PFD)
- 2) Press the **MENU** Key, and highlight 'Remove Arrival'.
- 3) Press the **ENT** Key. A confirmation window is displayed listing the arrival procedure.
- 4) With 'OK' highlighted, press the **ENT** Key. To cancel the removal request, highlight 'CANCEL' and press the **ENT** Key.

Or:

- 1) Press the **FPL** Key to display the Active Flight Plan Page (MFD) or the Active Flight Plan Window (PFD)
- 2) Press the **FMS** Knob, and turn to highlight the arrival header in the active flight plan.
- 3) Press the **CLR** Key. A confirmation window is displayed listing the arrival procedure.
- 4) With 'OK' highlighted, press the **ENT** Key. To cancel the removal request, highlight 'CANCEL' and press the **ENT** Key.
- 5) Press the **FMS** Knob to remove the flashing cursor.

APPROACHES



NOTE: *If certain GPS parameters (SBAS, RAIM, etc.) are not available, some published approach procedures for the desired airport may not be displayed in the list of available approaches.*

An Approach Procedure (APPR) can be loaded at any airport that has one available, and provides guidance for non-precision and precision approaches to airports with published instrument approach procedures. Only one approach can be loaded at a time in a flight plan. If an approach is loaded when another approach is already in the active flight plan, the new approach replaces the previous approach. The route is defined by selection of an approach and the transition waypoints.

Whenever an approach is selected, the choice to either "load" or "activate" is given. "Loading" adds the approach to the end of the flight plan without immediately using it for navigation guidance. This allows continued navigation via the intermediate waypoints in the original flight plan, but keeps the procedure available on the Active Flight Plan Page for quick activation when needed. "Activating" also adds the procedure to the end of the flight plan but immediately begins to provide guidance to the first waypoint in the approach.

When selecting an approach, a "GPS" designation to the right of the procedure name indicates the procedure can be flown using the GPS receiver. Some procedures do not have this designation, meaning the GPS receiver can be used for supplemental navigation guidance only. If the GPS receiver cannot be used for primary guidance, the appropriate navigation receiver must be used for the selected approach (e.g., VOR or ILS). The final course segment of ILS approaches, for example, must be flown by tuning the NAV receiver to the proper frequency and selecting that NAV receiver on the CDI.

The G1000 SBAS GPS allows for flying LNAV, LNAV/VNAV, and LPV approaches according to the published chart. LNAV+V is a standard LNAV approach with advisory vertical guidance provided for assistance in maintaining a constant vertical glidepath similar to an ILS glideslope on approach. This guidance is displayed on the G1000 PFD in the same location as the ILS glideslope using a magenta diamond. In all cases where LNAV+V is indicated by the system during an approach, LNAV minima are used. The active approach type is annunciated on the HSI as shown in the following table:

HSI Annunciation	Description	Example on HSI
LNAV	GPS approach using published LNAV minima	
LNAV+V	GPS approach using published LNAV minima. Advisory vertical guidance is provided	
L/VNAV	GPS approach using published LNAV/VNAV minima	
LPV	GPS approach using published LPV minima	

Table 5-9 Approach Types

LOADING AN APPROACH INTO THE ACTIVE FLIGHT PLAN

Loading an approach into the active flight plan using the PROC Key:

- 1) Press the **PROC** Key. The Procedures Window is displayed.
- 2) Highlight 'SELECT APPROACH', and press the **ENT** Key. The Approach Loading Page is displayed.
- 3) Use the **FMS** Knob to select an airport and press the **ENT** Key.
- 4) Select an approach from the list and press the **ENT** Key.
- 5) Select a transition (if required) and press the **ENT** Key.
- 6) Minimums
 - a) To set 'MINIMUMS', turn the small **FMS** Knob to select 'BARO' or 'RAD ALT', and press the **ENT** Key. Turn the small **FMS** Knob to select the altitude, and press the **ENT** Key.
 - Or:
 - b) To skip setting minimums, press the **ENT** Key.
- 7) Press the **ENT** Key with 'LOAD?' highlighted to load the approach procedure; or turn the large **FMS** Knob to highlight 'ACTIVATE' and press the **ENT** Key to load and activate the approach procedure.



NOTE: When GPS is not approved for the selected final approach course, the message 'NOT APPROVED FOR GPS' is displayed. GPS provides guidance to the approach, but the HSI must to be switched to a NAV receiver to fly the final course of the approach.

Available Procedure Actions

Destination Airport

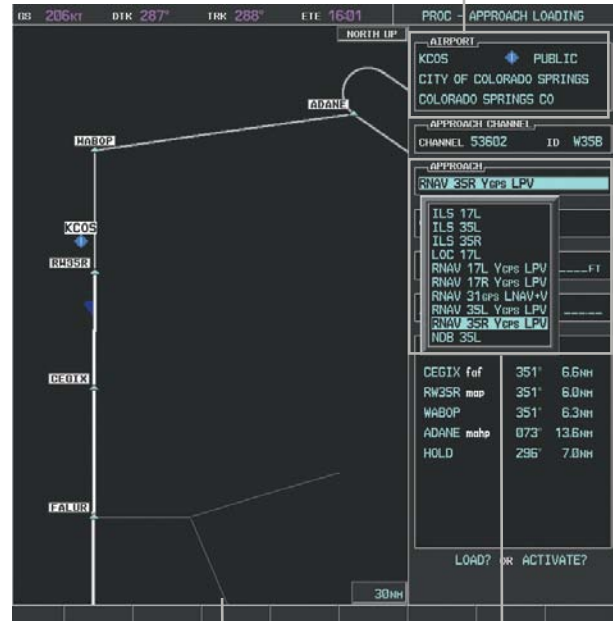
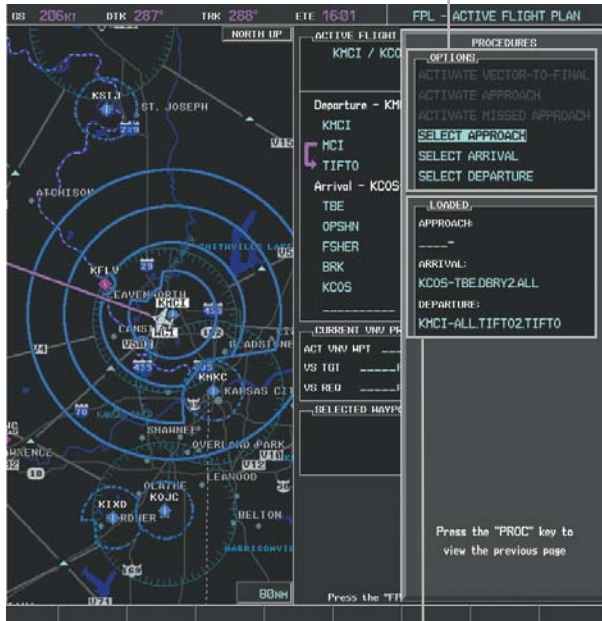

Loaded Procedures

Approach Preview

Approach Choices

Figure 5-96 Approach Selection

Selected Approach

Loaded Approach

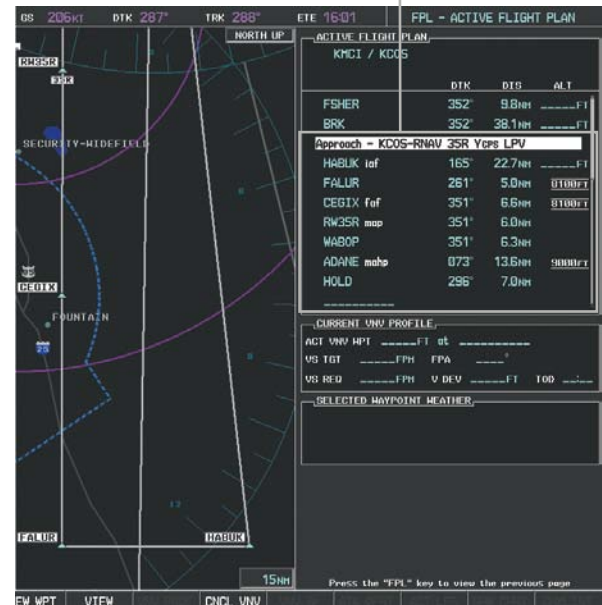
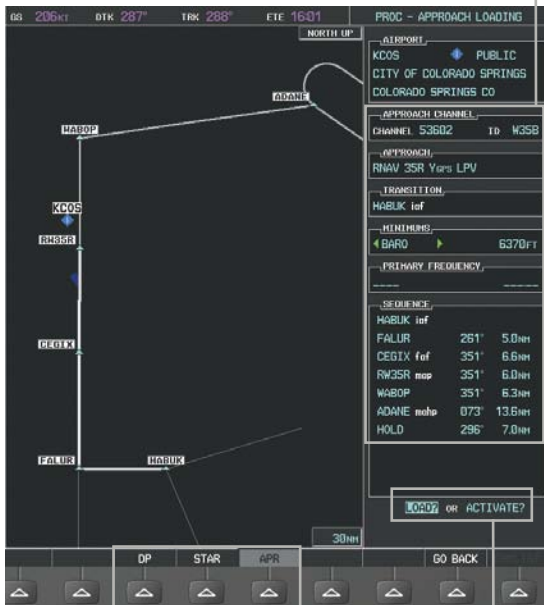

Procedure Loading Page Selection Softkeys

LOAD or ACTIVATE? Annunciator

Figure 5-97 Approach Loading

Viewing available approaches at an airport:

- 1) From the Airport Information Page (first page in the WPT group), select the **APR** Softkey. The Approach Information Page is displayed, defaulting to the airport displayed on the Airport information Page.
- 2) To select another airport, press the **FMS** Knob to activate the cursor, enter an identifier/facility name/city, and press the **ENT** Key.
- 3) Press the **FMS** Knob, then turn the large **FMS** Knob to highlight the Approach. The approach is previewed on the map.
- 4) Turn the small **FMS** Knob to view the available approaches. Press the **ENT** Key to select the approach. The cursor moves to the Transition box. The approach is previewed on the map.
- 5) Turn the small **FMS** Knob to view the available transitions. Press the **ENT** Key to select the transition. The cursor moves to the Minimums box. The approach is previewed on the map.
- 6) Turn the small **FMS** Knob to select BARO (or optional RAD ALT) minimums on or off. Press the **ENT** Key.
 - a) When minimums are selected on, the cursor moves to the minimum altitude field. Use the small **FMS** Knob to select the altitude. Press the **ENT** Key. The cursor moves to the Sequence box. The approach is previewed on the map.
Or:
 - b) When minimums are selected off, the cursor moves to the Sequence box. The approach is previewed on the map.
- 7) Press the **INFO-x** Softkey to return to the Airport Information Page.

Loading an approach into the active flight plan from the Nearest Airport Page:

- 1) Select the Nearest Airports Page.
- 2) Press the **FMS** Knob, then turn the large **FMS** Knob to highlight the desired nearest airport. The airport is previewed on the map.
- 3) Select the **APR** Softkey; or press the **MENU** Key, highlight 'Select Approach Window', and press the **ENT** Key.
- 4) Turn the **FMS** Knob to highlight the desired approach.
- 5) Select the **LD APR** Softkey; or press the **MENU** Key, highlight 'Load Approach', and press the **ENT** Key. The Approach Loading Page is displayed with the transitions field highlighted.
- 6) Turn the **FMS** Knob to highlight the desired transition, and press the **ENT** Key.
- 7) Minimums
 - a) To set 'MINIMUMS', turn the small **FMS** Knob to select 'BARO' or 'RAD ALT', and press the **ENT** Key. Turn the small **FMS** Knob to select the altitude, and press the **ENT** Key.
Or:
 - b) To skip setting minimums, press the **ENT** Key. The 'LOAD?' field is highlighted.
- 8) Press the **ENT** Key with 'LOAD?' highlighted to load the approach procedure; or turn the large **FMS** Knob to highlight 'ACTIVATE' and press the **ENT** Key to load and activate the approach procedure. The G1000 continues navigating the current flight plan until the approach is activated. When GPS is not approved for the selected final approach course, the message 'NOT APPROVED FOR GPS' is displayed. GPS provides guidance to the approach, but the HSI must to be switched to a NAV receiver to fly the final course of the approach.

ACTIVATING AN APPROACH

A previously loaded approach can be activated from the Procedures Window.

Activating a previously loaded approach:

- 1) Press the **PROC** Key. The Procedures Window is displayed with 'Activate Approach' highlighted.
- 2) Press the **ENT** Key to activate the approach.

In many cases, it may be easiest to “load” the full approach while still some distance away, enroute to the destination airport. Later, if vectored to final, use the steps above to select 'Activate Vector-To-Final' — which makes the inbound course to the FAF waypoint active.

Activating a previously loaded approach with vectors to final:

- 1) Press the **PROC** Key to display the Procedures Window.
- 2) Highlight 'ACTIVATE VECTOR-TO-FINAL' and press the **ENT** Key.

Loading and activating an approach using the MENU Key:

- 1) From the Approach Loading Page, press the **MENU** Key. The page menu is displayed with 'Load & Activate Approach' highlighted.
- 2) Press the **ENT** Key. When GPS is not approved for the selected final approach course, the message 'NOT APPROVED FOR GPS' is displayed. GPS provides guidance to the approach, but the HSI must be switched to a NAV receiver to fly the final course of the approach.

REMOVING AN APPROACH FROM THE ACTIVE FLIGHT PLAN

When plans change while flying IFR, approaches can be easily removed from the Active Flight Plan.

Removing an approach from the active flight plan:

- 1) Press the **FPL** Key to display the Active Flight Plan Page (MFD) or the Active Flight Plan Window (PFD)
- 2) Press the **MENU** Key, and highlight 'Remove Approach'.
- 3) Press the **ENT** Key. A confirmation window is displayed listing the approach procedure.
- 4) With 'OK' highlighted, press the **ENT** Key. To cancel the removal, highlight 'CANCEL' and press the **ENT** Key.

Or:

- 1) Press the **FPL** Key to display the Active Flight Plan Page (MFD) or the Active Flight Plan Window (PFD)
- 2) Press the **FMS** Knob, and turn to highlight the approach header in the active flight plan.
- 3) Press the **CLR** Key. A confirmation window is displayed listing the approach procedure.
- 4) With 'OK' highlighted, press the **ENT** Key. To cancel the removal, highlight 'CANCEL' and press the **ENT** Key.
- 5) Press the **FMS** Knob to remove the flashing cursor.

MISSED APPROACH

Activating a missed approach in the active flight plan:

- 1) Press the **PROC** Key.
- 2) Turn the **FMS** Knob to highlight 'ACTIVATE MISSED APPROACH'.
- 3) Press the **ENT** Key. The aircraft automatically sequences to the MAHP.

Or:

Press the Go-Around Button.

COURSE TO ALTITUDE

In this missed approach procedure, the altitude immediately following the MAP (in this case '6368ft') is not part of the published procedure. It is simply a Course to Altitude (CA) leg which guides the aircraft along the runway centerline until the altitude required to safely make the first turn toward the MAHP is exceeded. This altitude is provided by Jeppesen, and may be below, equal to, or above the published minimums for this approach. In this case, if the aircraft altitude is below the specified altitude (6,368 feet) after crossing the MAP, a direct-to is established to provide a course on runway heading until an altitude of 6,368 feet is reached. After reaching 6,368 feet, a direct-to is established to the published MAHP (in this case MOGAL). If the aircraft altitude is above the specified altitude after crossing the MAP, a direct-to is established to the published fix (MOGAL) to begin the missed approach procedure.

In some missed approach procedures this Course to Altitude leg may be part of the published procedure. For example, a procedure may dictate a climb to 5,500 feet, then turn left and proceed to the Missed Approach Hold Point (MAHP). In this case, the altitude would appear in the list of waypoints as '5500ft'. Again, if the aircraft altitude is lower than the prescribed altitude, a direct-to is established on a Course to Altitude leg when the missed approach procedure is activated.

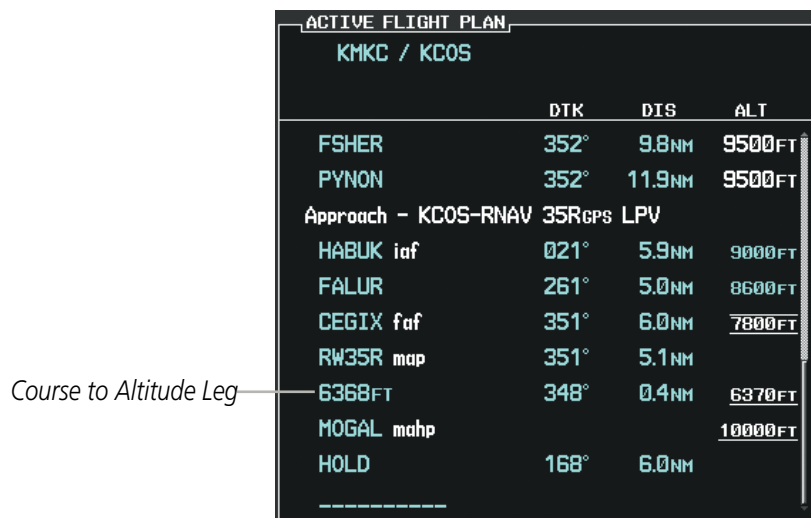

Figure 5-98 Course to Altitude

5.9 TRIP PLANNING

The G1000 allows the pilot to view trip planning information, fuel information, and other information for a specified flight plan or flight plan leg based on automatic data, or based on manually entered data. Weight planning is also available, based on fuel sensor data and the active flight plan (to estimate remaining fuel).

TRIP PLANNING

All of the input of data needed for calculation and viewing of the statistics is done on the Trip Planning Page located in the AUX Page Group.

Selected Flight Plan Segment
 - FPL Number/Cumulative Legs (CUM or REM) or Leg Number (NN)
 - Waypoints Defining Selected Flight Plan/Flight Plan Leg

INPUT DATA

GS 169KT DTK 287° TRK 304° ETE 18:50 AUX - TRIP PLANNING

PAGE MODE - AUTOMATIC

FPL 03 LEG CUM
 KHKC → KCOS

DEP TIME 16:05 LCL
 GS 169KT
 FUEL FLOW 16.0 GL/HR
 FUEL ONBOARD 217 GL

CALIBRATED AS 175KT
 IND ALTITUDE 12000 FT
 PRESSURE 29.92 IN
 TOTAL AIR TEMP 0°C

TRIP STATS

DTK ---°
 DIS 580 NM
 ETE 03:26
 ETA 19:31 LCL
 ESA --- FT
 SUNRISE 12:44 LCL
 SUNSET 01:00 LCL

FUEL STATS

EFFICIENCY 10.5
 TOTAL ENDUR 13:34
 REM FUEL 162 GL
 REM ENDUR 10:07
 FUEL REQ 55.0 GL
 TOTAL RANGE 2290 NM

OTHER STATS

DENSITY ALT --- FT
 TRUE AIRSPEED 175 KT

SOFTKEYS: AUTO, MANUAL, FPL, WPTS, ENROUTE

Annotations:

- Preview of Selected Flight Plan/Flight Plan Leg
- Trip Statistics: Desired Track, Distance, Est. Time Enroute, Est. Time of Arrival, Enroute Safe Altitude, Sunrise Time (local), Sunset Time (local)
- Fuel Statistics: Efficiency, Total Endurance, Remaining Fuel, Remaining Endurance, Fuel Required, Total Range
- Other Statistics: Density Altitude, True Airspeed (TAS)
- Trip Planning Page Mode - Automatic/Manual
- Trip Input Data (sensor/pilot): Departure Time (local), Ground Speed, Fuel Flow, Fuel On Board Aircraft, Calibrated Airspeed, Indicated Altitude, Barometric Pressure, Total Air Temperature
- Softkeys: Automatic/Manual Page Mode, Flight Plan/Waypoint Mode

Figure 5-99 Trip Planning Page

The trip planning inputs are based on sensor inputs (automatic page mode) or on pilot inputs (manual page mode). Some additional explanation of the sources for some of the inputs is as follows:

- Departure time (DEP TIME) - This defaults to the current time in automatic page mode. The computations are from the aircraft present position, so the aircraft is always just departing.

- Calibrated airspeed (CALIBRATED AS) - The primary source is from the air data system, and the secondary source of information is GPS ground speed.
- Indicated altitude (IND ALTITUDE) - The primary source is the barometric altitude, and the secondary source of information is GPS altitude.

TRIP STATISTICS

The trip statistics are calculated based on the selected starting and ending waypoints and the trip planning inputs.

In flight plan mode (FPL) with a stored flight plan selected (NN), and the entire flight plan (CUM) selected, the waypoints are the starting and ending waypoints of the selected flight plan.

In flight plan mode (FPL) with a stored flight plan selected (NN), and a specific leg (NN) selected, the waypoints are the endpoints of the selected leg.

In flight plan mode (FPL) with the active flight plan selected (00), and the remaining flight plan (REM) selected, the 'from' waypoint is the present position of the aircraft and the 'to' waypoint is the endpoint of the active flight plan.

In flight plan mode (FPL) with the active flight plan selected (00), and a specific leg (NN) selected, the 'from' waypoint is the current aircraft position and the 'to' waypoint is the endpoint of the selected leg.

In waypoint (WPTS) mode these are manually selected waypoints (if there is an active flight plan, these default to the endpoints of the active leg).

Some of the calculated trip statistics are dashed when the selected leg of the active flight plan has already been flown.

- Desired Track (DTK) - DTK is shown as nnn° and is the desired track between the selected waypoints. It is dashed unless only a single leg is selected.
- Distance (DIS) - The distance is shown in tenths of units up to 99.9, and in whole units up to 9999.
- Estimated time enroute (ETE) - ETE is shown as hours:minutes until less than an hour, then it is shown as minutes:seconds.
- Estimated time of arrival (ETA) - ETA is shown as hours:minutes and is the local time at the destination.
 - If in waypoint mode then the ETA is the ETE added to the departure time.
 - If a flight plan other than the active flight plan is selected it shows the ETA by adding to the departure time all of the ETEs of the legs up to the selected leg. If the entire flight plan is selected, then the ETA is calculated as if the last leg of the flight plan was selected.
 - If the active flight plan is selected the ETA reflects the current position of the aircraft and the current leg being flown. The ETA is calculated by adding to the current time the ETEs of the current leg up to and including the selected leg. If the entire flight plan is selected, then the ETA is calculated as if the last leg of the flight plan was selected.
- Enroute safe altitude (ESA) - The ESA is shown as nnnnnFT
- Destination sunrise and sunset times (SUNRISE, SUNSET) - These times are shown as hours:minutes and are the local time at the destination.

FUEL STATISTICS

The fuel statistics are calculated based on the selected starting and ending waypoints and the trip planning inputs. Some of the calculated trip statistics are dashed when the selected leg of the active flight plan has already been flown.

- Fuel efficiency (EFFICIENCY) - This value is calculated by dividing the current ground speed by the current fuel flow.
- Time of fuel endurance (TOTAL ENDUR) - This time is shown as hours:minutes. This value is obtained by dividing the amount of fuel on board by the current fuel flow.
- Fuel on board upon reaching end of selected leg (REM FUEL) - This value is calculated by taking the amount of fuel onboard and subtracting the fuel required to reach the end of the selected leg.
- Fuel endurance remaining at end of selected leg (REM ENDUR) - This value is calculated by taking the time of fuel endurance and subtracting the estimated time enroute to the end of the selected leg.
- Fuel required for trip (FUEL REQ) - This value is calculated by multiplying the time to go by the fuel flow.
- Total range at entered fuel flow (TOTAL RANGE) - This value is calculated by multiplying the time of fuel endurance by the ground speed.

OTHER STATISTICS

These statistics are calculated based on the system sensor inputs or the manual trip planning inputs.

- Density altitude (DENSITY ALT)
- True airspeed (TRUE AIRSPEED)

The pilot may select automatic (AUTO) or manual (MANUAL) page mode, and flight plan (FPL) or waypoint (WPTS) mode. In automatic page mode, only the FPL, LEG, or waypoint IDs are editable (based on FPL/WPTS selection).

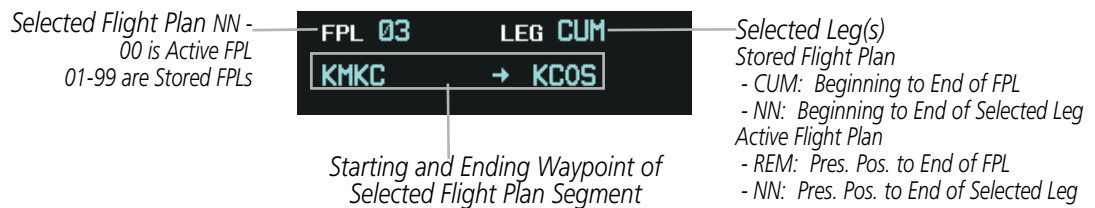

Figure 5-100 Trip Planning Page - Flight Plan Mode

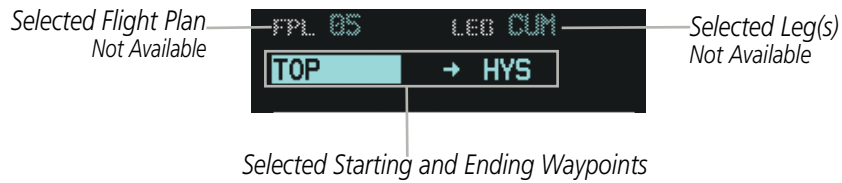

Figure 5-101 Trip Planning Page - Waypoint Mode

Selecting automatic or manual page mode:

Select the **AUTO** Softkey or the **MANUAL** Softkey; or press the **MENU** Key, highlight 'Auto Mode' or 'Manual Mode', and press the **ENT** Key.

Selecting flight plan or waypoint mode:

Select the **FPL** Softkey or the **WPTS** Softkey; or press the **MENU** Key, highlight 'Flight Plan Mode' or 'Waypoints Mode', and press the **ENT** Key.

Selecting a flight plan and leg for trip statistics:

- 1) Press the **FMS** Knob to activate the cursor in the flight plan number field.
- 2) Turn the small **FMS** Knob to select the desired flight plan number.
- 3) Turn the large **FMS** Knob to highlight 'CUM' or 'REM'. The statistics for each leg can be viewed by turning the small **FMS** Knob to select the desired leg. The Inset Map also displays the selected data.

Selecting waypoints for waypoint mode:

- 1) Select the **WPTS** Softkey; or press the **MENU** Key, highlight 'Waypoints Mode', and press the **ENT** Key. The cursor is positioned in the waypoint field directly below the FPL field.
- 2) Turn the **FMS** knobs to select the desired waypoint (or select from the Page Menu 'Set WPT to Present Position' if that is what is desired), and press the **ENT** Key. The cursor moves to the second waypoint field.
- 3) Turn the **FMS** knobs to select the desired waypoint, and press the **ENT** Key. The statistics for the selected leg are displayed.

In manual page mode, the other eight trip input data fields must be entered by the pilot, in addition to flight plan and leg selection.

Entering manual data for trip statistics calculations:

- 1) Select the **MANUAL** Softkey or select 'Manual Mode' from the Page Menu, and press the **ENT** Key. The cursor may now be positioned in any field in the top right two boxes.
- 2) Turn the **FMS** Knobs to move the cursor onto the DEP TIME field and enter the desired value. Press the **ENT** Key. The statistics are calculated using the new value and the cursor moves to the next entry field. Repeat until all desired values have been entered.

WEIGHT PLANNING

NOTE: All weight planning page data fields displays data rounded to the nearest 10 pounds or 5 kilograms.

Figure 5-102 Weight Planning Page

Entering basic empty weight:

- 1) Select the **EMPTY WT** Softkey; or press the **MENU** Key, highlight 'Set Basic Empty Weight', and press the **ENT** Key to select the 'BASIC EMPTY WEIGHT' field.
- 2) Turn the small **FMS** Knob to enter the basic empty weight.
- 3) Press the **ENT** Key to confirm the entry.
- 4) Press the **FMS** Knob to remove the flashing cursor.

Entering a pilot and stores weight:

- 1) Press the **FMS** Knob to activate the cursor and highlight the 'PILOT AND STORES' field.
- 2) Turn the small **FMS** Knob to enter the pilot and stores weight.
- 3) Press the **ENT** Key to confirm the entry.
- 4) Press the **FMS** Knob to remove the flashing cursor.

The basic operating weight is calculated by adding the basic empty weight and the pilot and stores weight.

Entering the number of passengers:

- 1) Press the **FMS** Knob to activate the cursor and highlight the 'PASSENGERS #' field.
- 2) Turn the small **FMS** Knob to enter the number of passengers.
- 3) Press the **ENT** Key to confirm the entry.
- 4) Press the **FMS** Knob to remove the flashing cursor.

Entering the average passenger weight:

- 1) Press the **FMS** Knob to activate the cursor and highlight the passenger weight field.
- 2) Turn the small **FMS** Knob to enter the average passenger weight.
- 3) Press the **ENT** Key to confirm the entry.
- 4) Press the **FMS** Knob to remove the flashing cursor.

The total weight of passengers is calculated by multiplying the number of passengers by the average passenger weight.

Entering the cargo weight:

- 1) Press the **FMS** Knob to activate the cursor and highlight the 'CARGO' field.
- 2) Turn the small **FMS** Knob to enter the cargo weight.
- 3) Press the **ENT** Key to confirm the entry.
- 4) Press the **FMS** Knob to remove the flashing cursor.

The 'ZERO FUEL WEIGHT' is calculated by adding the basic empty, pilot and stores, passenger, and cargo weights.

Entering a fuel on board weight:

- 1) Press the **FMS** Knob to activate the cursor and highlight the 'FUEL ON BOARD' field.
- 2) Turn the small **FMS** Knob to enter the fuel on board.
- 3) Press the **ENT** Key to confirm the entry.
- 4) Press the **FMS** Knob to remove the flashing cursor.

Entering fuel reserve:

- 1) Press the **FMS** Knob to activate the cursor and highlight the 'FUEL RESERVES' field.
- 2) Turn the small **FMS** Knob to enter the fuel reserves amount.
- 3) Press the **ENT** Key to confirm the entry.
- 4) Press the **FMS** Knob to remove the flashing cursor.

Synchronizing the fuel on board with the actual measured fuel on board:

Select the **FOB SYNC** Softkey; or press the **MENU** Softkey, highlight 'Synchronize Fuel on Board', and press the **ENT** Key. The actual measured fuel on board is displayed in the 'FUEL ON BOARD' field.

When the aircraft is in the air and a destination waypoint has been entered, the fuel calculations can be completed.

- Estimated landing weight = zero fuel weight + estimated landing fuel weight.
- Estimated landing fuel weight = fuel on board weight - (fuel flow x ETE)
- Excess fuel weight = estimated landing fuel weight - fuel reserves weight

If the aircraft is on the ground or a destination waypoint has not been entered, the following fields display invalid values consisting of six dashes:

- Estimated landing weight
- Estimated landing fuel weight
- Excess fuel weight

WEIGHT CAUTION AND WARNING CONDITIONS

If the zero fuel weight is greater than the maximum allowable zero fuel weight, then the zero fuel weight is displayed in amber.

If the aircraft weight is greater than the maximum allowable takeoff weight, then the aircraft weight is displayed in amber.

If the estimated landing weight is greater than the maximum allowable landing weight, then the estimated landing weight is displayed in amber.

If the estimated landing fuel weight is positive, but less than or equal to the fuel reserves weight, the following values are displayed in amber:

- Estimated fuel at landing weight
- Excess fuel weight

If the estimated landing fuel weight is zero or negative, then the following values are displayed in red:

- Estimated fuel at landing weight
- Excess fuel weight

5.10 RAIM PREDICTION

RAIM (Receiver Autonomous Integrity Monitoring) is a GPS receiver function that performs a consistency check on all tracked satellites. RAIM ensures that the available satellite geometry allows the receiver to calculate a position within a specified RAIM protection limit (2.0 nm for oceanic, 2.0 nm for enroute, 1.0 nm for terminal, and 0.3 nm for non-precision approaches). During oceanic, enroute, and terminal phases of flight, RAIM is available nearly 100% of the time. The RAIM prediction function also indicates whether RAIM is available at a specified date and time. RAIM computations predict satellite coverage within ± 15 min of the specified arrival date and time. Because of the tighter protection limit on approaches, there may be times when RAIM is not available. RAIM prediction must be initiated manually if there is concern over SBAS coverage at the destination or some other reason that compromises navigation precision. If RAIM is not predicted to be available for the final approach course, the approach does not become active. If RAIM is not available when crossing the FAF, the missed approach procedure must be flown.



Figure 5-103 RAIM Prediction

Predicting RAIM availability at a selected waypoint:

- 1) Select the AUX-GPS Status Page.
- 2) Press the **FMS** Knob. The RAIM Prediction 'WAYPOINT' field is highlighted.
- 3) Turn the small **FMS** Knob to display the Waypoint Information Window. (Turning it clockwise displays a blank Waypoint Information Window, turning it counter-clockwise displays the Waypoint Information Window with a waypoint selection submenu allowing selection of active flight plan, nearest, recent, user, or airway waypoints).
- 4) Enter the identifier, facility, or city name of the departure waypoint; or select a waypoint from the submenu of waypoints and press the **ENT** Key to accept the waypoint entry.
- 5) Turn the FMS Knobs to enter an arrival time and press the **ENT** Key.
- 6) Turn the FMS Knobs to enter an arrival date and press the **ENT** Key.
- 7) Press the **ENT** Key with 'COMPUTE RAIM?' highlighted to begin the computation.

Predicting RAIM availability at the aircraft present position:

- 1) Select the AUX-GPS Status Page.
- 2) Press the **FMS** Knob. The RAIM Prediction 'WAYPOINT' field is highlighted.
- 3) Press the **MENU** Key, highlight 'Set WPT to Present Position', and press the **ENT** Key.
- 4) Press the **ENT** Key to accept the waypoint entry.
- 5) Turn the FMS Knobs to enter an arrival time and press the **ENT** Key.
- 6) Turn the FMS Knobs to enter an arrival date and press the **ENT** Key.
- 7) Press the **ENT** Key with 'COMPUTE RAIM?' highlighted to begin the computation.

Status of the RAIM computation for the selected waypoint, time, and date is displayed at the bottom of the RAIM PREDICTION Box as follows:

- 'COMPUTE RAIM?' - RAIM has not been computed.
- 'COMPUTING AVAILABILITY' - RAIM calculation is in progress.
- 'RAIM AVAILABLE' - RAIM is predicted to be available.
- 'RAIM NOT AVAILABLE' - RAIM is predicted to be unavailable.

The Satellite Based Augmentation System (SBAS) provides increased navigation accuracy when available. SBAS can be enabled or disabled manually on the GPS Status Page.



Figure 5-104 SBAS Display - Active

Enabling/Disabling SBAS:

- 1) Select the AUX-GPS Status Page.
- 2) Press the **SBAS** softkey.
- 3) Press the **FMS** Knob, and turn the large FMS Knob to highlight 'EGNOS', 'MSAS' or 'WAAS'.
- 4) Press the **ENT** Key to disable SBAS. Press the **ENT** Key again to enable SBAS.

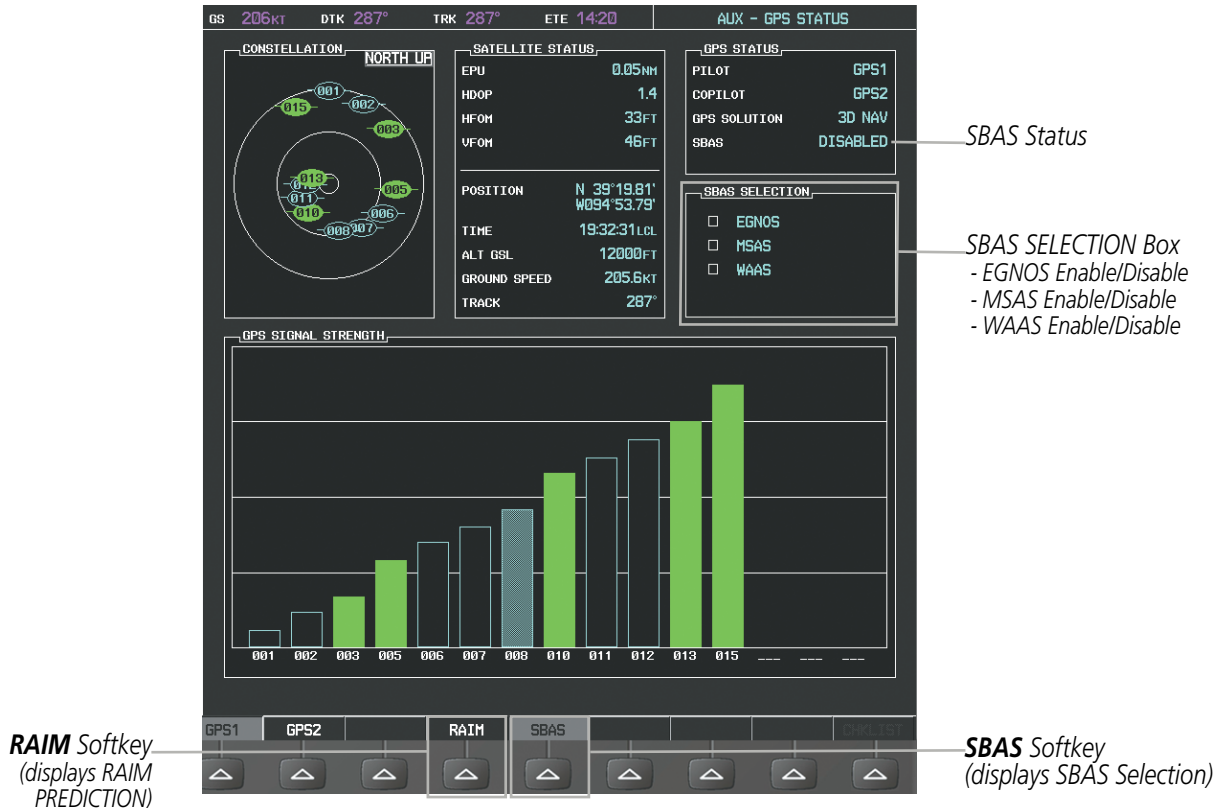

Figure 5-105 SBAS Display - Disabled

5.11 NAVIGATING A FLIGHT PLAN

The following discussion is an example of navigating a flight plan with the SBAS capable GPS system while the G1000 provides vertical guidance through descents. A lateral flight plan (LNAV) would be navigated in much the same way, but would not include vertical guidance when the final approach course is active.



NOTE: The following example flight plan is for instructional purposes only. All database information depicted should be considered not current.

The example is a flight plan from KMKC to KCOS filed using the TIFTO2 departure, various Victor Airways, and the DBRY1 arrival with the transition at TBE. The flight plan includes an enroute altitude of 12,000 feet, an LPV (WAAS) approach selected for runway 35R, and a missed approach executed at the Missed Approach Point (MAP). A few enroute changes are demonstrated.

- 1) Prior to departure, the TIFTO2 departure, the airways, and the DBRY1 arrival at KCOS are loaded. See the Procedures section for loading departures and arrivals. Note the magenta arrow in Figure 5-106 indicating the active departure leg.

After takeoff, ATC assigns a heading of 240°.

- 2) Figure 5-106 shows the aircraft on the assigned heading of 240°. 'TERM' (Terminal) is the current CDI flight phase displayed on the HSI indicating 1.0 nm CDI scaling.

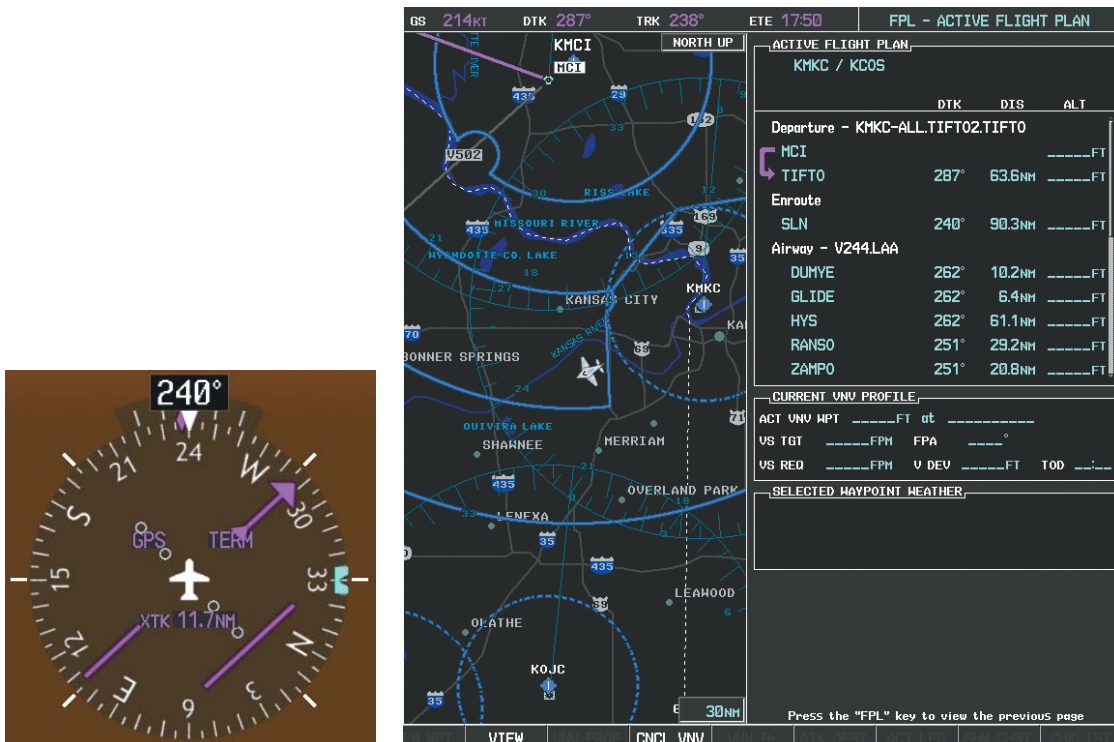

Figure 5-106 Assigned Heading of 240°

- 3) ATC now assigns routing to join V4. A heading of 290° is assigned to intercept V4. The aircraft turns to heading 290° as seen in Figure 5-107.

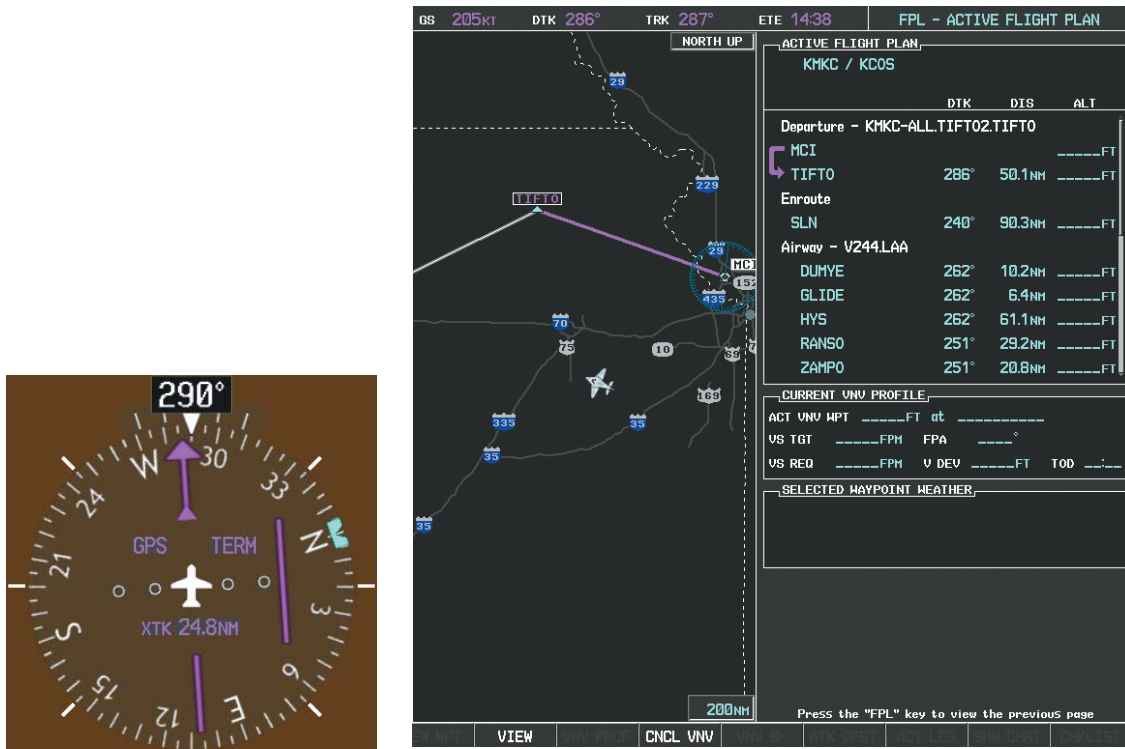

Figure 5-107 Assigned Heading of 290°

- 4) Enter V4 into the flight plan.
 - a) Press the **FMS** Knob to activate the cursor.

b) The desired entry point for V4 (TOP) must be entered. Turn the large **FMS** Knob to highlight the desired flight plan insertion point (SLN) as shown in Figure 5-108. When the V4 entry point (TOP) is inserted, it is placed immediately above the highlighted waypoint (SLN).

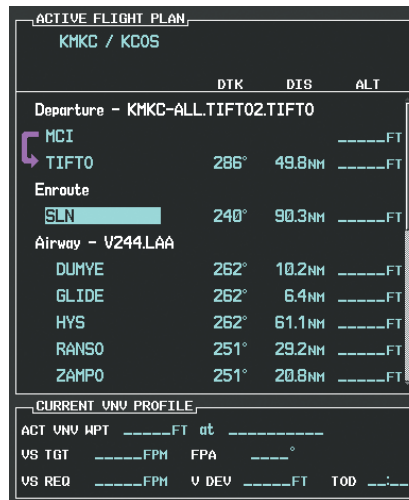

Figure 5-108 Begin Adding V4 to the Flight Plan

c) Turn the small **FMS** Knob to display the Waypoint Information Window. Enter the desired entry point for V4, Topeka VOR (TOP), as shown in Figure 5-109.



Figure 5-109 Entering V4 Entry Point

d) Press the **ENT** Key. TOP is inserted into the flight plan as in Figure 5-110.

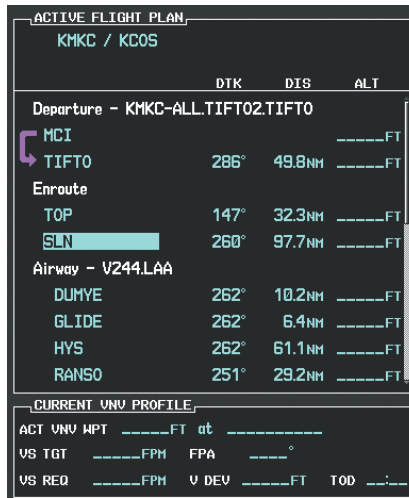

Figure 5-110 TOP Inserted into the Flight Plan

e) With SLN still highlighted as in Figure 5-110, turn the small **FMS** Knob clockwise. The Waypoint Information Page is displayed and the **LD AIRWY** Softkey is now available.

f) Select the **LD AIRWY** Softkey to display the list of available airways for TOP as seen in Figure 5-111.

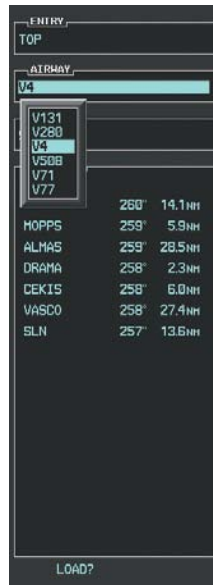

Figure 5-111 List of Available Airways for TOP

g) Turn either **FMS** Knob to highlight V4 in the list as seen in Figure 5-111.

h) Press the **ENT** Key. The list of available exits for V4 is now displayed as in Figure 5-112.

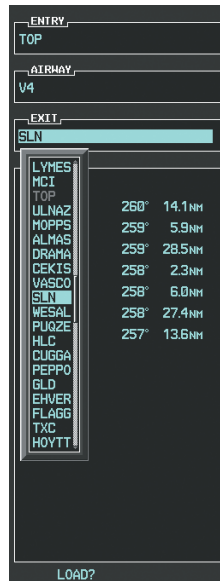

Figure 5-112 List of Available Exits for V4

i) If necessary, turn either **FMS** Knob to select the desired exit. In this case Salina VOR (SLN) is selected as in Figure 5-112.

j) Press the **ENT** Key. The selected airway and exit are displayed, and the prompt "LOAD?" highlighted as in Figure 5-113.

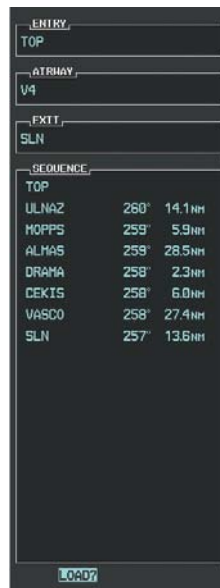

Figure 5-113 Ready to Load V4

k) Press the **ENT** Key.

I) V4 is now loaded into the flight plan as shown in Figure 5-114.

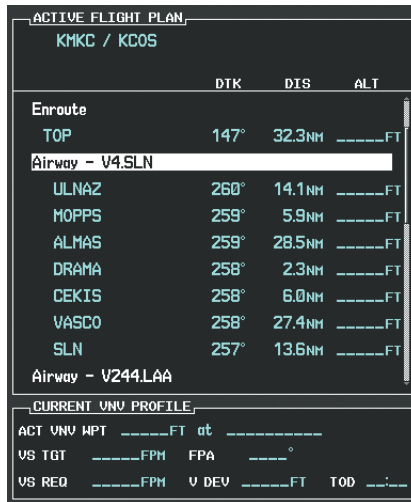

Figure 5-114 V4 is Loaded in the Flight Plan

- 5) Making V4 the active leg of the flight plan.
 - a) Press the **FMS** Knob to activate the cursor.
 - b) Turn the large **FMS** Knob to highlight ULNAZ. The TO waypoint of the leg is selected in order to activate the leg.
 - c) Select the **ACT LEG** Softkey. The confirmation window is now displayed as in Figure 5-115. Note the TOP to ULNAZ leg is actually part of V4.



Figure 5-115 Confirm Active Leg

- d) Verify the displayed leg is the desired leg and press the **ENT** Key. Note in Figure 5-116, the magenta arrow in the flight plan window and magenta line on the map indicating V4 is now the active flight plan leg.

Note the phase of flight remained in Terminal (TERM) mode up to this point because a departure leg was active. Since a leg after the departure is now active, the current CDI flight phase is ENR (Enroute) and CDI scaling has changed to 2.0 nm.

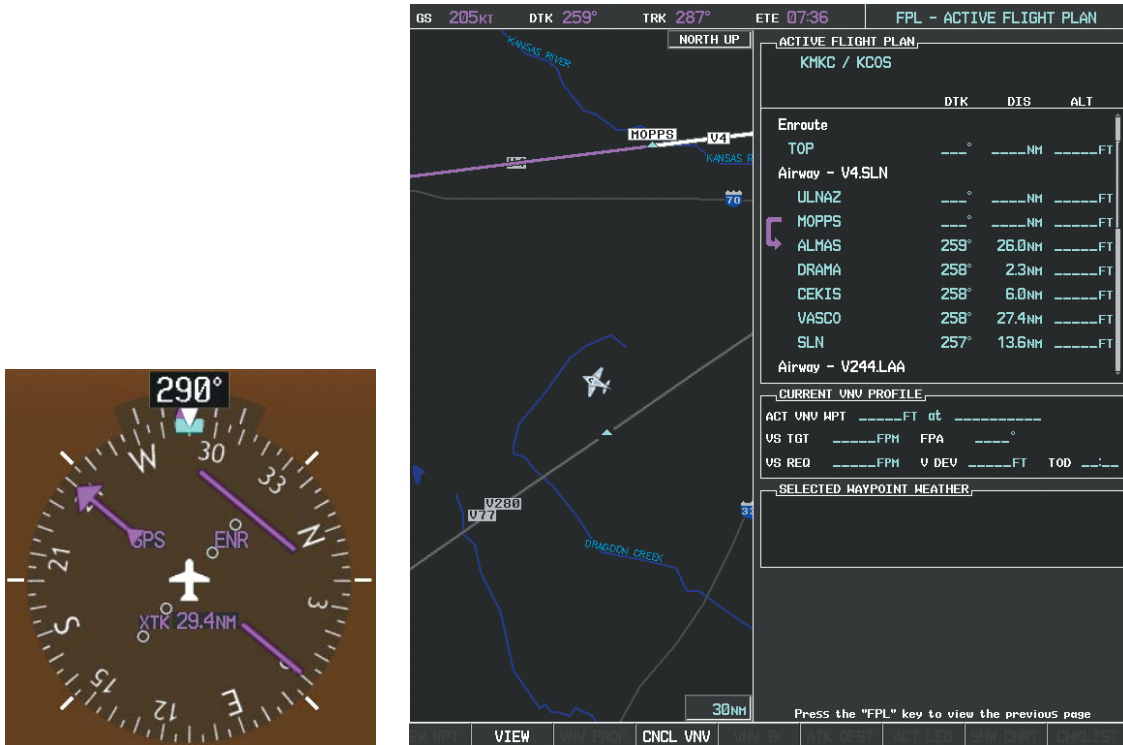

Figure 5-116 V4 Now Active Leg

- 6) The aircraft continues on heading 290°. When crosstrack distance is less than 2.0 nm, the XTK disappears from the HSI and the CDI is positioned on the last dot indicating a 2.0 nm distance from the centerline of the next course.

7) As the CDI approaches center, the aircraft turns onto the active leg as seen in Figure 5-117.

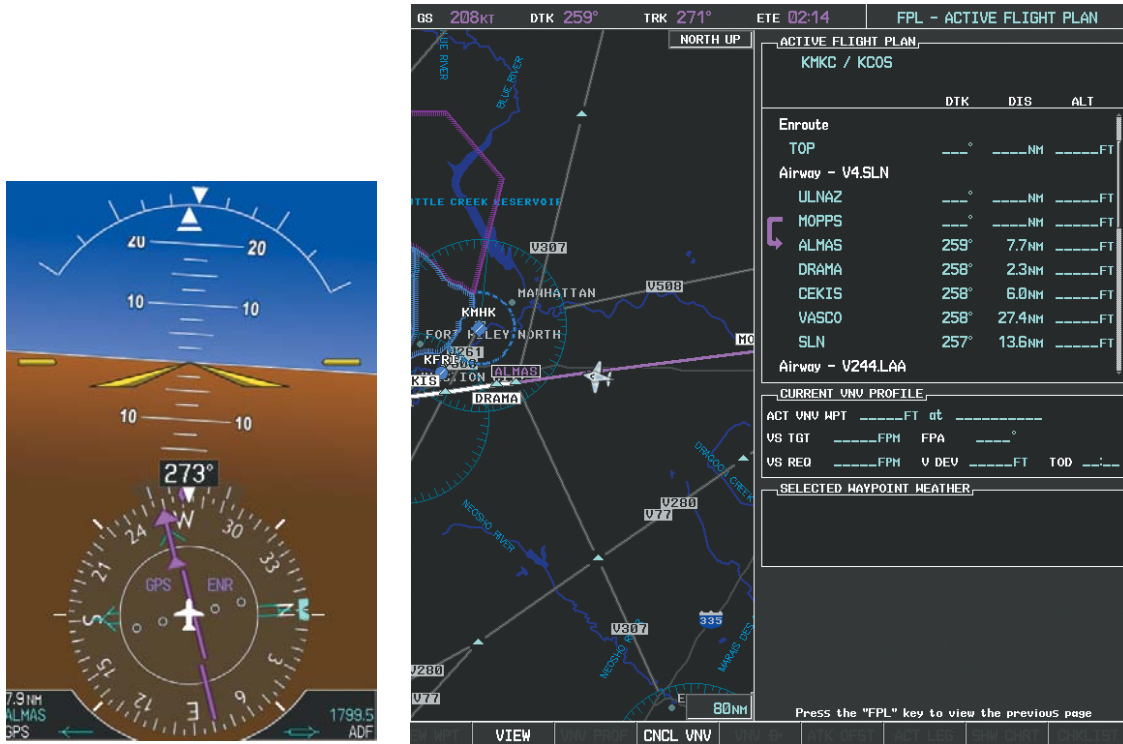

Figure 5-117 Turn on to Active Leg

8) At SLN, Victor Airway 244 (V244) is intercepted. Turn prompts are displayed in the PFD Navigation Status Box as seen in Figure 5-118.

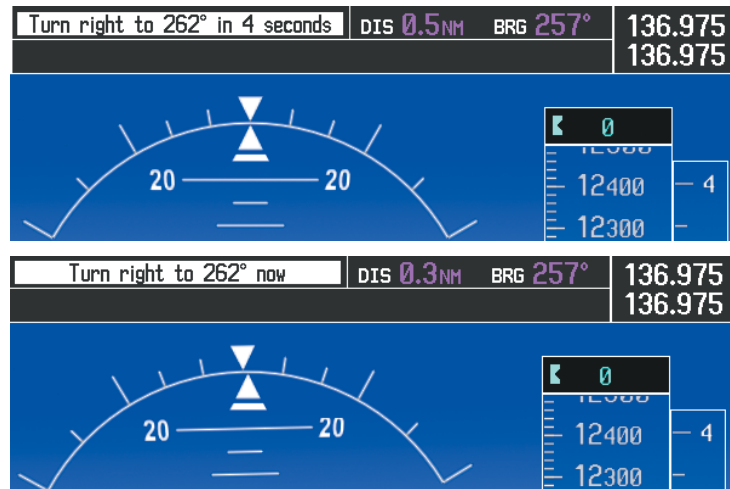

Figure 5-118 Turn to Intercept V244

9) As seen in Figure 5-119, V244 is now the active flight plan leg.

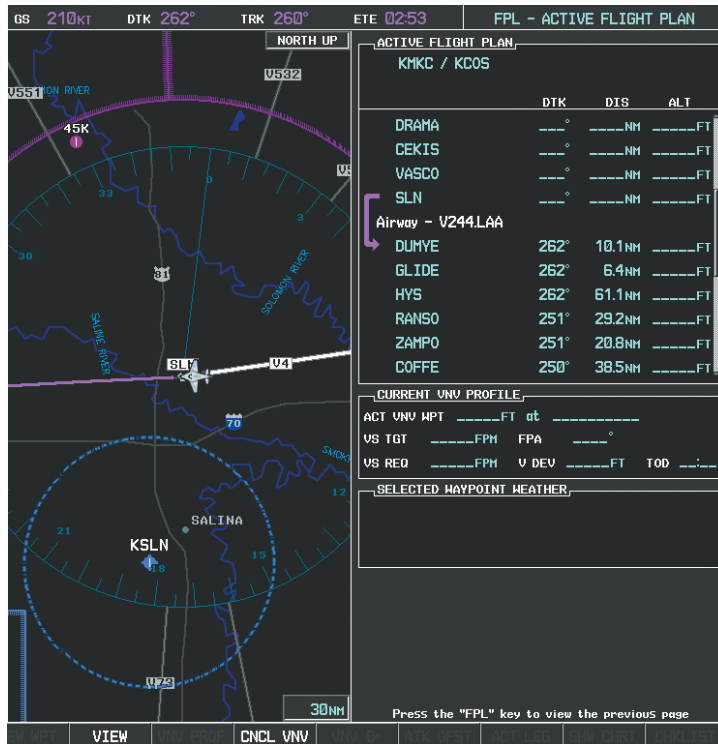

Figure 5-119 V244 Now Active Leg

10) At Lamar VOR (LAA) V263 is intercepted. See Figure 5-120.

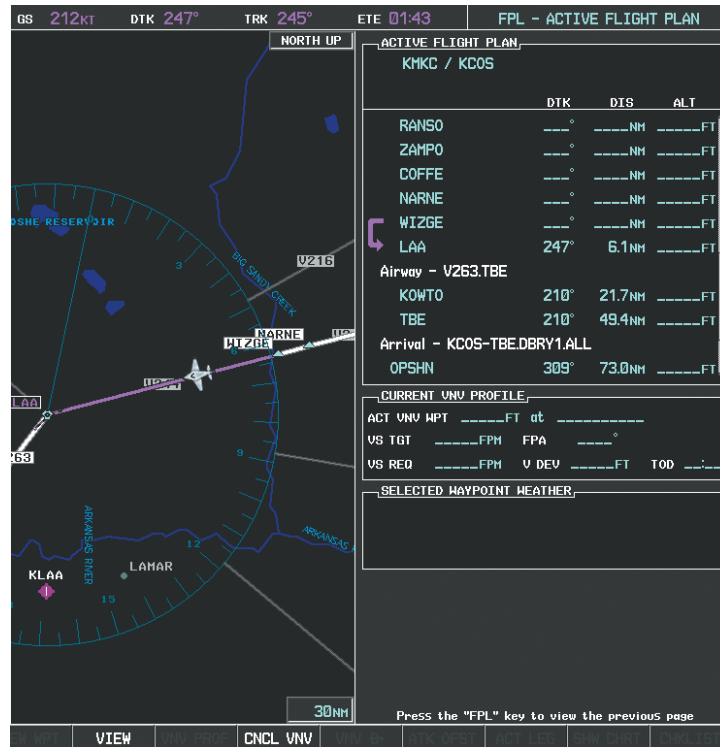

Figure 5-120 HYS to LAA Leg Active

11) ATC grants clearance to proceed direct to the OPRSHN intersection to begin the arrival procedure. ATC advises to expect an altitude of 10,000 feet at OPRSHN.

- a) Press the **FMS** Knob to activate the cursor.
- b) Turn the large **FMS** Knob to select OPRSHN in the flight plan list.
- c) Press the **Direct-to** (D➔) Key. The Direct-to Window is now displayed as shown in Figure 5-121.

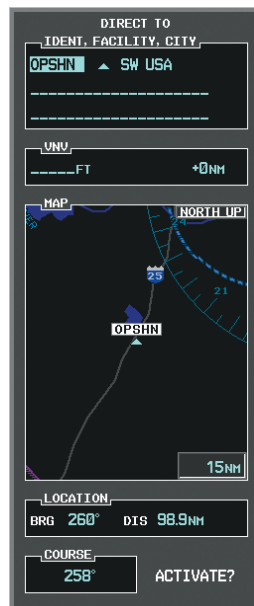

Figure 5-121 Direct To OPRSHN

d) Turn the large **FMS** Knob to place the cursor in the VNV altitude field as shown in Figure 5-122.

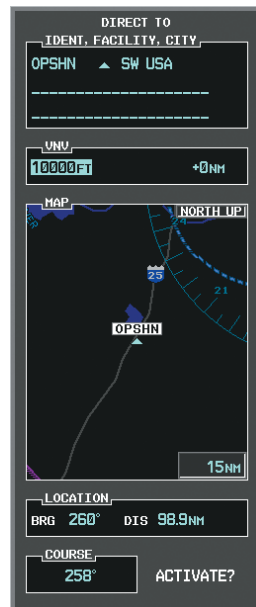

Figure 5-122 Enter VNV Altitude

e) An altitude of 10,000 feet is entered as requested by ATC.

f) Press the **ENT** Key. The cursor is now displayed in the VNV offset field as shown in Figure 5-123.

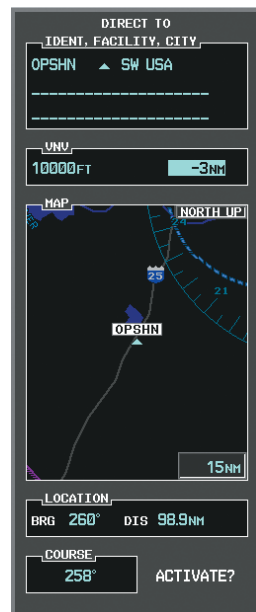

Figure 5-123 Enter VNV Offset Distance

g) Enter the offset, or distance from the waypoint at which to reach the pressed altitude. In this case, three miles prior to OPSHN is entered. In other words, the G1000 gives vertical guidance so the aircraft arrives at an altitude of 10,000 feet three miles prior to OPSHN.

h) Press the **ENT** Key twice to activate the direct-to. Note, in Figure 5-124, the magenta arrow indicating the direct-to OPSHN after the offset waypoint for OPSHN. The preceding offset waypoint indicates the offset distance and altitude that were previously entered. The remaining waypoints in the loaded arrival procedure have no database specified altitudes, therefore, dashes are displayed. Keep the CDI centered and maintain a track along the magenta line to OPSHN.

Note the Direct-to waypoint is within the loaded arrival procedure, therefore, phase of flight scaling for the CDI changes to Terminal Mode and is annunciated by displaying 'TERM' on the HSI.



NOTE: If the loaded arrival procedure has waypoints with altitude constraints retrieved from the database to be used as is, the altitude must be manually accepted by placing the cursor over the desired altitude, then pressing the ENT Key. The altitude is now displayed as light blue meaning it is used by the system to determine vertical speed and deviation guidance.

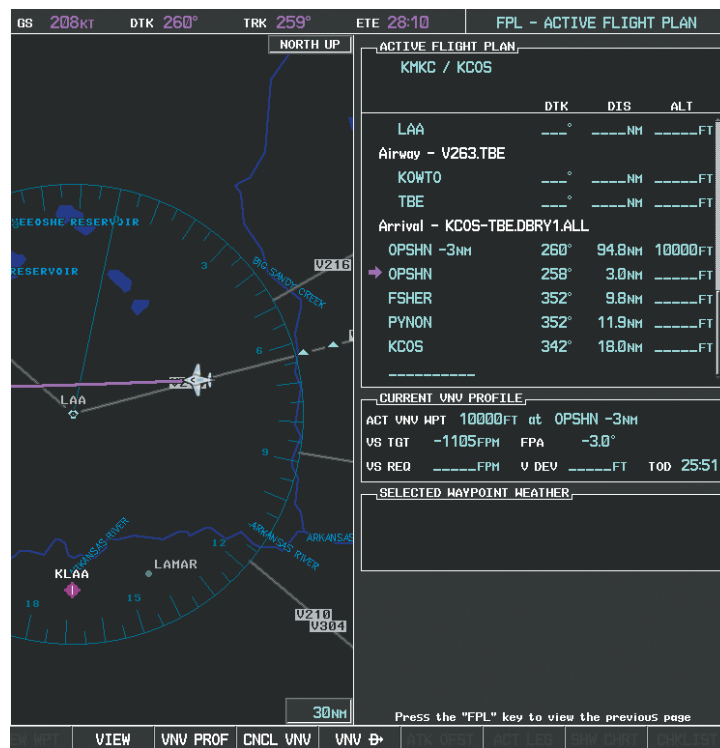

Figure 5-124 Direct-to Active

- 12) The aircraft is proceeding to OPSHN. The expected approach is the RNAV LPV approach to runway 35R, so it is selected.
 - a) Press the **PROC** Key to display the Procedures Window.

b) 'SELECT APPROACH' should be highlighted as shown in Figure 5-125.

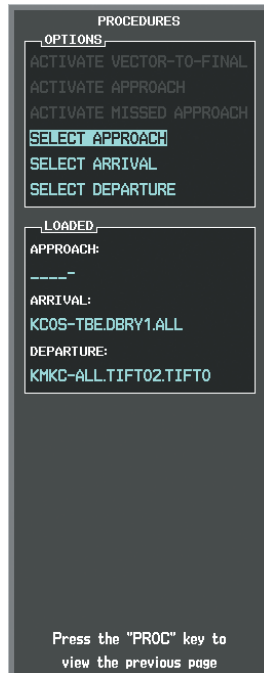

Figure 5-125 Procedures Window

c) Press the **ENT** Key. A list of available approaches for the destination airport is displayed as in Figure 5-126.

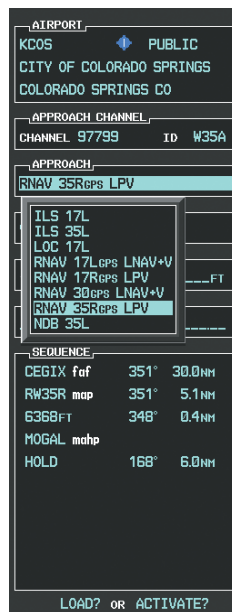

Figure 5-126 List of Available Approaches

d) Turn either **FMS** Knob to select the LPV approach for 35R as shown in Figure 5-126.

e) Press the **ENT** Key. A list of available transitions for the selected approach is displayed as in Figure 5-127.

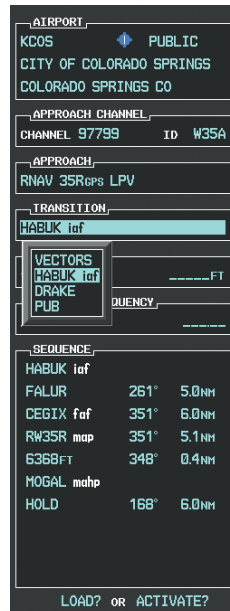

Figure 5-127 List of Available Transitions

f) Turn either **FMS** Knob to select the desired transition. In this case, the Initial Approach Fix (IAF) at HABUK is used.

g) Press the **ENT** Key.

h) Barometric Minimums

To set 'MINIMUMS', turn the small **FMS** Knob to select 'BARO', and press the **ENT** Key. Turn the small **FMS** Knob to select the altitude, and press the **ENT** Key.

Or:

To skip setting minimums, press the **ENT** Key.

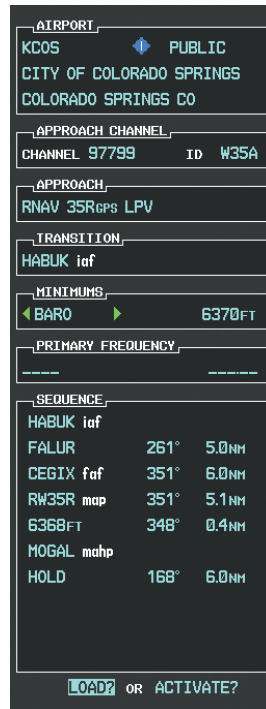

Figure 5-128 Barometric Minimums Set

- i) With 'LOAD?' highlighted, again press the **ENT** Key. The selected approach is added to the flight plan as seen in Figure 5-129.

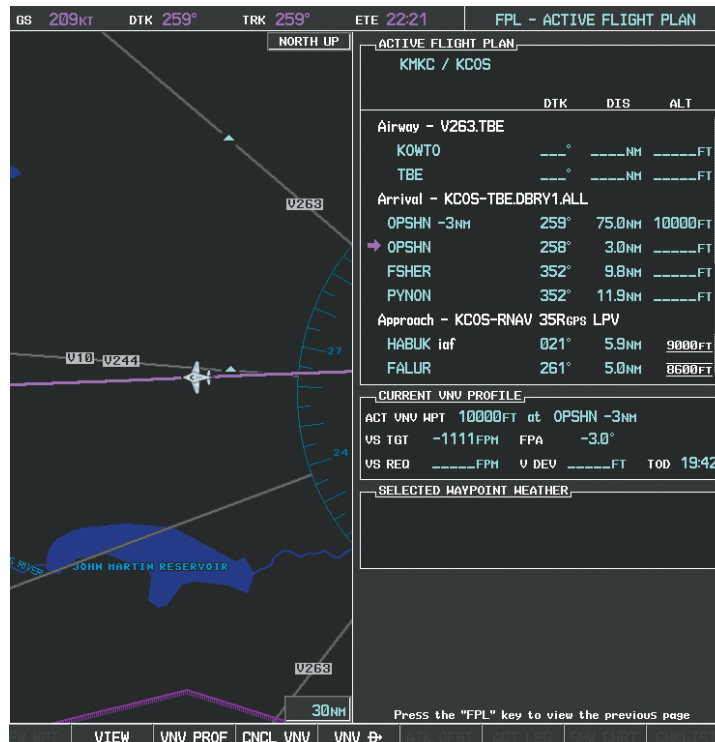

Figure 5-129 Loaded Approach

- 13) Note the altitude constraints associated with each of the approach waypoints as seen in Figure 5-130. These altitudes are loaded from the database and are initially displayed as white text, indicating these values are not used in computing vertical deviation guidance. The altitude values must be designated for use by the pilot if they are to be used in computing vertical guidance.
 - a) Press the **FMS** Knob to activate the cursor.
 - b) Turn the large **FMS** Knob to place the cursor in the altitude field associated with the IAF at HABUK as in Figure 5-130.

ACTIVE FLIGHT PLAN			
KMKC / KCOS			
	DTK	DIS	ALT
Airway - V263.TBE			
KOWTO	---	---	---
TBE	---	---	---
Arrival - KCOS-TBE.DBRV1.ALL			
OPSHN -3NM	259°	75.0NM	10000FT
→ OPSHN	258°	3.0NM	---
FSHER	352°	9.8NM	---
PYNON	352°	11.9NM	---
Approach - KCOS-RNAV 35R _{GPS} LPV			
HABUK iaf	021°	5.9NM	9000FT
FALUR	261°	5.0NM	8500FT
CURRENT UNV PROFILE			
ACT UNV HPT 10000FT at OPSHN -3NM			
VS TGT	-1111FPM	FPA	-3.0°
VS REQ	---	V DEV	---
TOD 19:42			

Figure 5-130 Designate HABUK Altitude Constraint

- c) Press the **ENT** Key. Note the altitude is now displayed as light blue text, indicating that the value is now used in computing vertical guidance. The G1000 is using baro corrected altitude when giving vertical guidance to these waypoints.
- d) Turn the large **FMS** Knob to select the altitude constraint associated with FALUR as seen in Figure 5-131.

ACTIVE FLIGHT PLAN			
KMKC / KCOS			
	DTK	DIS	ALT
Airway - V263.TBE			
KOWTO	---	---	---
TBE	---	---	---
Arrival - KCOS-TBE.DBRV1.ALL			
OPSHN -3NM	259°	75.0NM	10000FT
→ OPSHN	258°	3.0NM	10000FT
FSHER	352°	9.8NM	10000FT
PYNON	352°	11.9NM	10000FT
Approach - KCOS-RNAV 35R _{GPS} LPV			
HABUK iaf	021°	5.9NM	9000FT
FALUR	261°	5.0NM	8500FT
CURRENT UNV PROFILE			
ACT UNV HPT 10000FT at OPSHN -3NM			
VS TGT	-1111FPM	FPA	-3.0°
VS REQ	---	V DEV	---
TOD 19:42			

Figure 5-131 Designate FALUR Altitude Constraint

- e) Press the **ENT** Key to designate this altitude constraint value for use in computing vertical guidance. This altitude value is now displayed as light blue text. Note that altitude values are now filled in for waypoints back to where the previous altitude value was entered for OPSHN.

Altitude constraint values associated with the Final Approach Fix (FAF) and waypoints beyond the FAF cannot be designated for vertical guidance. These altitude values are always displayed as white text. Vertical guidance from the FAF and on to the Missed Approach Point (MAP) is given using the WAAS GPS altitude source, therefore, the displayed altitude values are for reference only.

ACTIVE FLIGHT PLAN			
KMKC / KCOS			
	DTK	DIS	ALT
FSHER	352°	9.8NM	10000FT
PYNON	352°	11.9NM	10000FT
Approach - KCOS-RNAV 3SRGPS LPV			
HABUK idf	021°	5.9NM	9000FT
FALUR	261°	5.0NM	8600FT
DEGIX faf	351°	6.0NM	7800FT
RW35R map	351°	5.1NM	
6368FT	348°	0.4NM	6370FT
HOGAL mahp			10000FT
HOLD	168°	6.0NM	

CURRENT UNV PROFILE			
ACT UNV HPT 10000FT at OPSHN -3NM			
VS TGT	-1111FPM	FPA	-3.0°
VS REQ	-----FPM	V DEV	-----FT
			TOD 19:42

Figure 5-132 Vertical Guidance is Active to the FAF

- 14) As the aircraft approaches OPSHN, it may be desirable to adjust the speed, or steepness of the upcoming descent. The default Flight Path Angle (FPA) is -3.0 degrees and a required vertical speed is computed to maintain the -3.0 FPA. To change the vertical flight path, perform the following steps.
 - a) Select the **VNV PROF** Softkey to place the cursor in the target vertical speed field (VS TGT) as shown in Figure 5-133.
 - b) At this point, the descent vertical speed can be selected, or the FPA can be selected. Turn the large **FMS** Knob to select the desired selection field, then turn the small **FMS** Knob to enter the desired value.

Note the information now displayed in the 'CURRENT VNV PROFILE' box. Also, note the offset waypoint (orange box) and gray circle are now displayed on the map. The gray circle marks the Top of Descent (TOD). In this example, vertical guidance is provided at the TOD that results in a -3.0 degree FPA descent to an altitude of 10,000 feet upon reaching the offset waypoint.

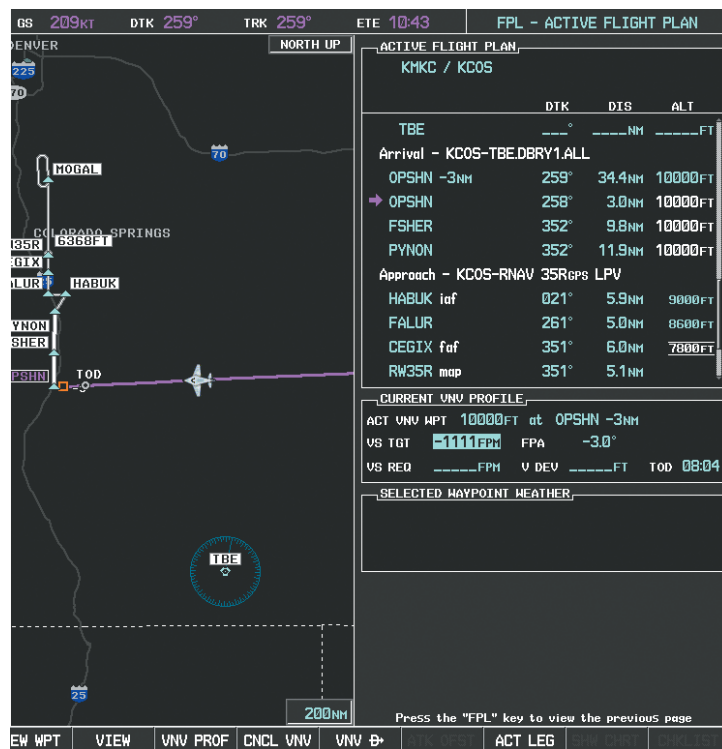

Figure 5-133 Adjusting the Descent

- c) Press the **ENT** Key.

15) As seen in Figure 5-134, the aircraft is approaching TOD. Note the target vertical speed required to reach the selected altitude. The Vertical Deviation Indicator (VDI) and the Required Vertical Speed Indicator (RVSI) are now displayed on the PFD as shown in Figure 5-135. When the aircraft is within one minute of the TOD, it is annunciated as shown in Figure 5-135, and an aural alert 'Vertical track' will be heard.

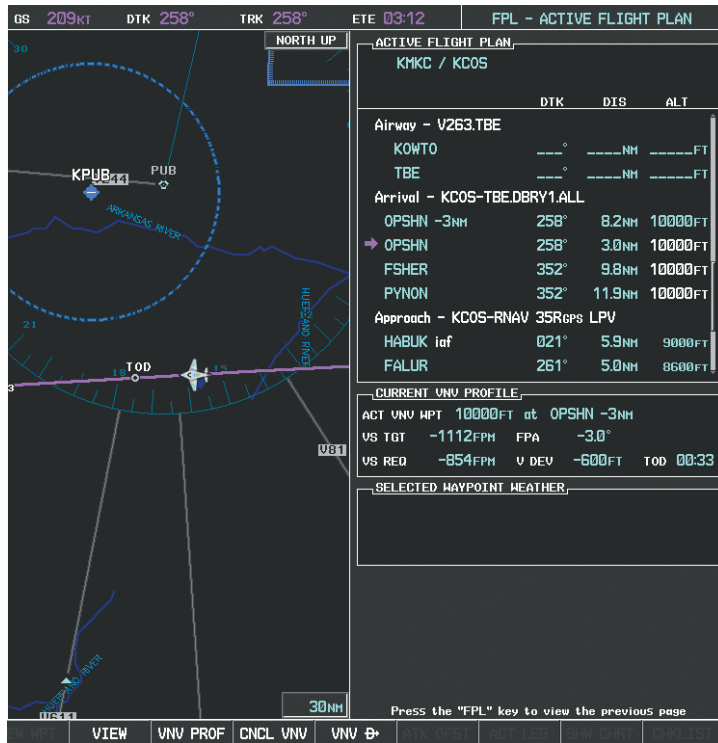

Figure 5-134 Approaching Top of Descent (TOD)

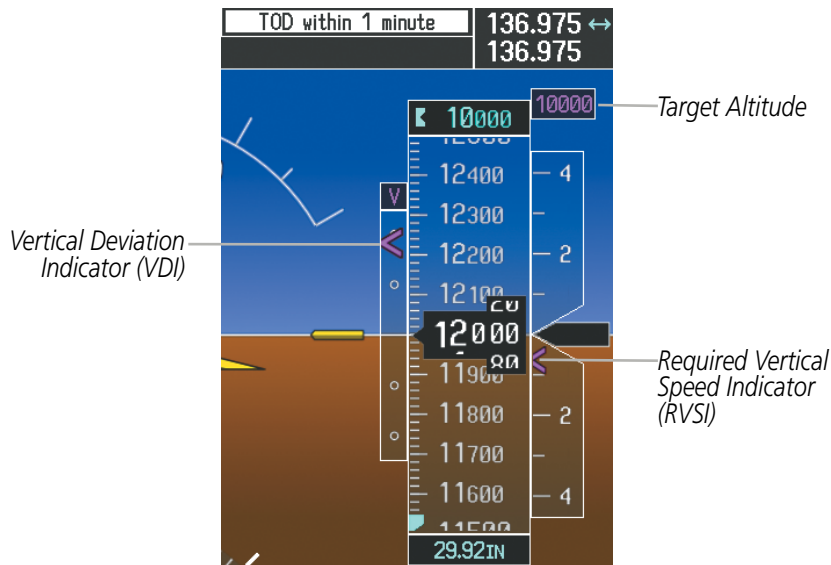

Figure 5-135 VDI & RVSI When Approaching Top of Descent (TOD)

- 16) Upon reaching TOD, a descent vertical speed is established by placing the VSI pointer in line with the RVSI as shown in Figure 5-136.

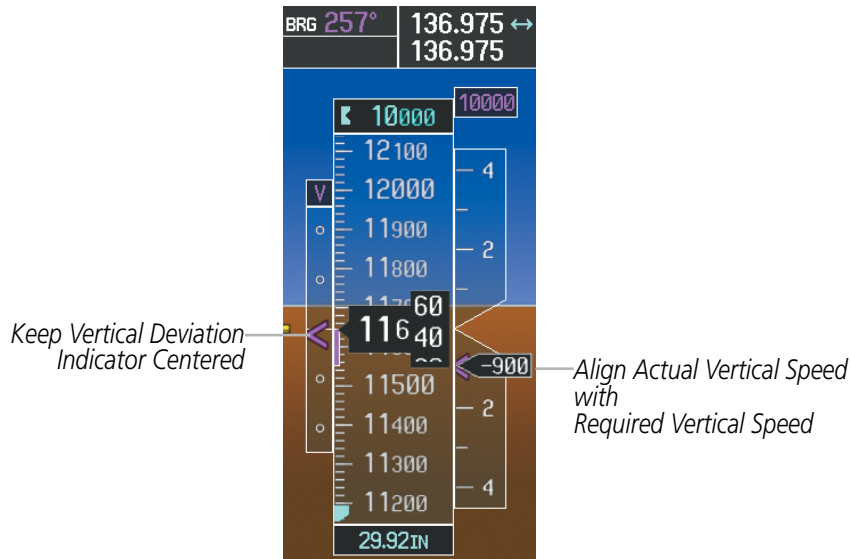

Figure 5-136 VDI & RVSI Showing Correctly Established Descent

- 17) When the aircraft is one minute from the bottom of descent (BOD) it is annunciated as shown in Figure 5-137. Upon reaching the offset waypoint for OPSHN, the aircraft is at 10,000 feet.

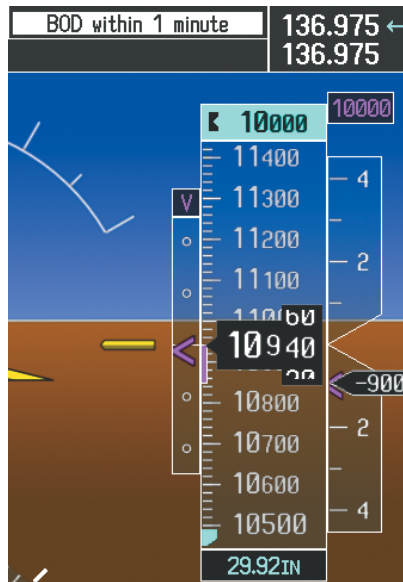

Figure 5-137 Approaching Bottom of Descent (BOD) at OPSHN Offset Waypoint

- 18) The aircraft is approaching OPSHN. The upcoming turn and next heading are annunciated at the top left of the PFD as seen in Figure 5-138. Initiate the turn and maneuver the aircraft on a track through the turn radius to intercept the magenta line for the OPSHN to FSHER leg and center the CDI.

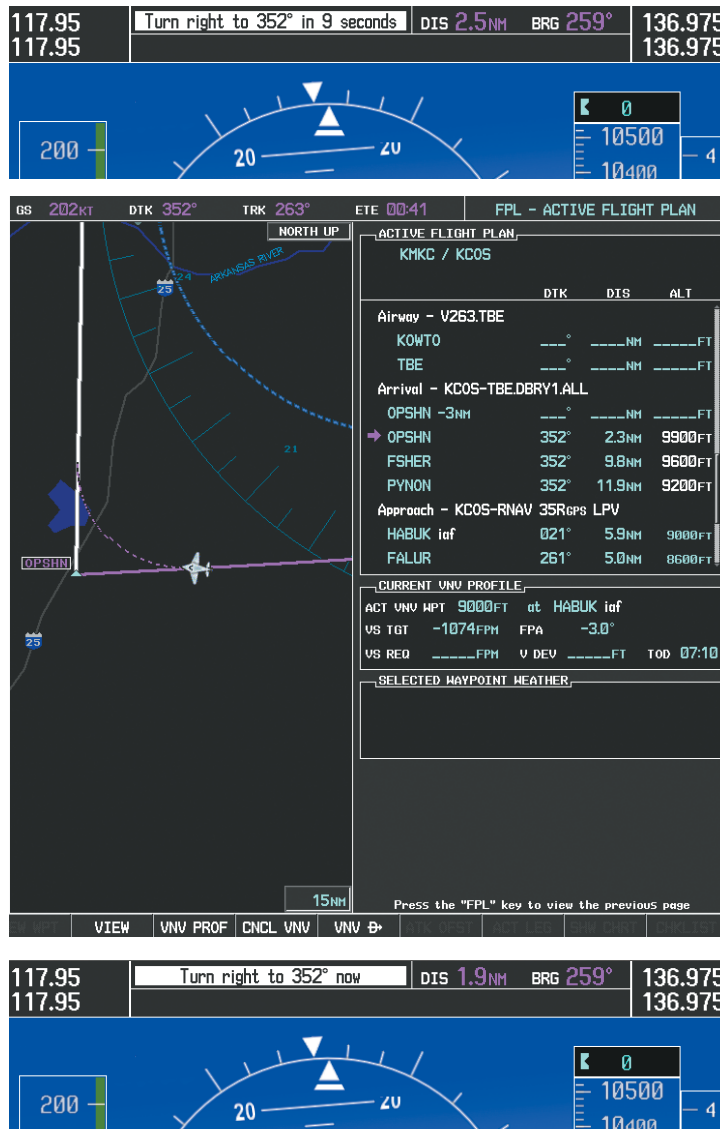

Figure 5-138 Turn to intercept OPSHN to FSHER Leg

- 19) After passing OPSHN, the next leg of the arrival turns magenta as shown in Figure 5-139. The magenta arrow in the flight plan list now indicates the OPSHN to FSHER leg of the arrival procedure is now active.

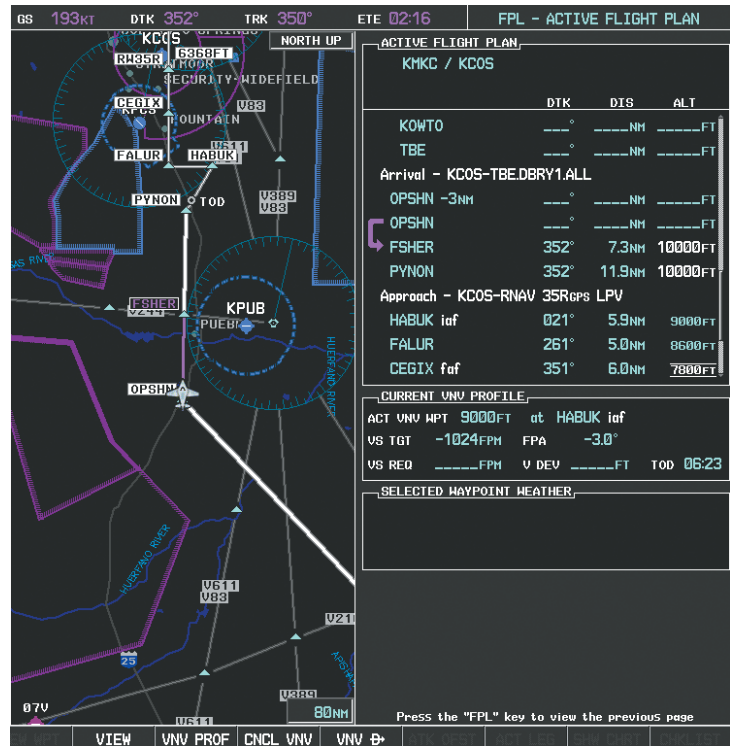

Figure 5-139 Tracking the OPSHN to FSHER Leg

- 20) The flight continues through the arrival procedure to PYNON (see Figure 5-140). At a point 31 nm from the destination airport, the phase of flight scaling for the CDI changes to Terminal Mode and is annunciated by displaying 'TERM' on the HSI.

A descent to HABUK is in the next leg. Note the TOD point on the map. Annunciations for the upcoming turn and descent, as well as the VDI and RVSI, appear on the PFD as the flight progresses.

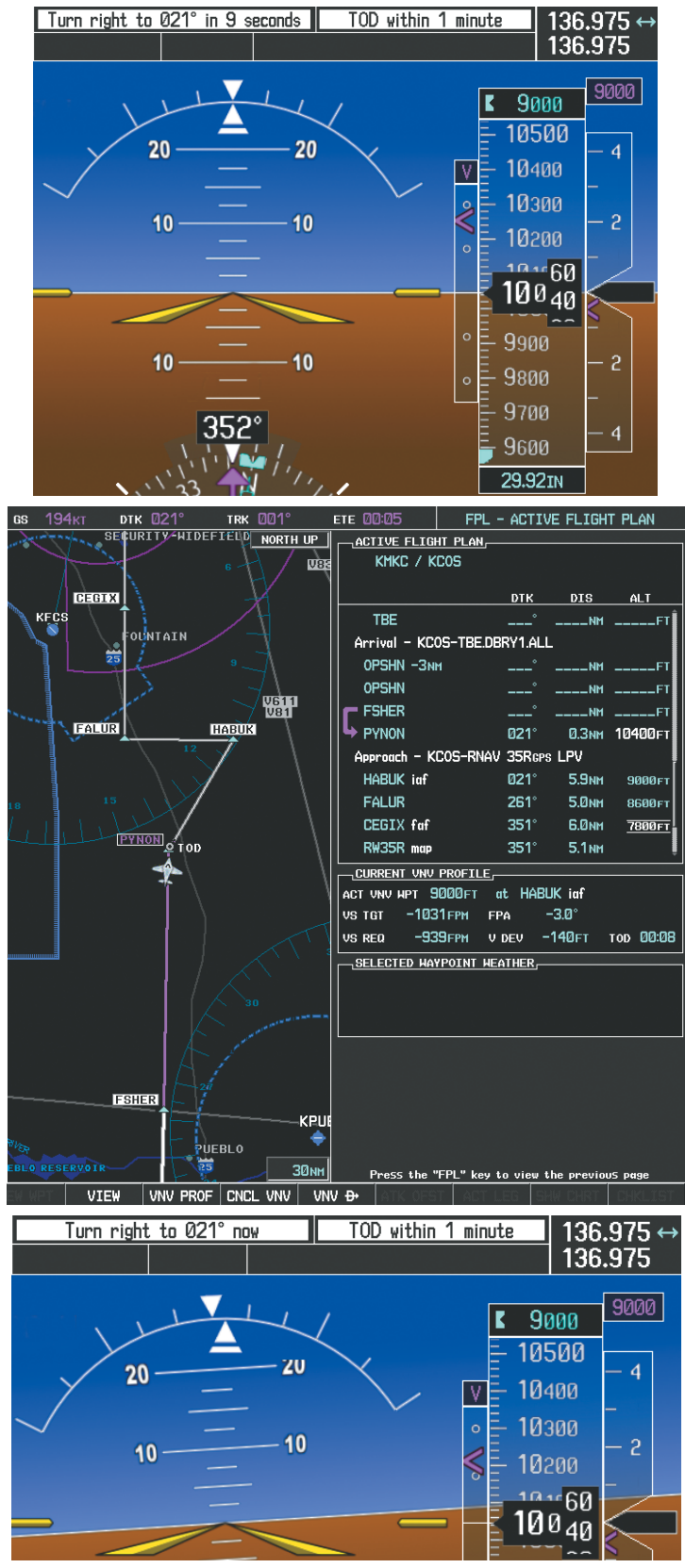

Figure 5-140 Approaching PYNON

- 21) Upon passing PYNON the approach procedure automatically becomes active. The approach may be activated at any point to proceed directly to the IAF. In this example, the aircraft has progressed through the final waypoint of the arrival and the flight plan has automatically sequenced to the IAF as the active leg, activating the approach procedure (see Figure 5-141).

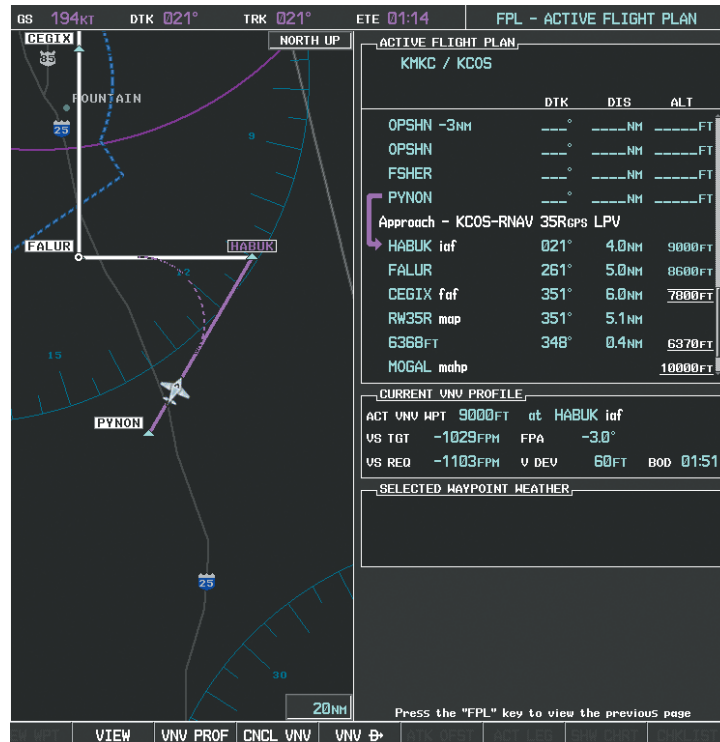

Figure 5-141 Approach is Now Active

Note: To manually activate the approach procedure, perform the following steps:

- Press the **PROC** Key.
- Turn the large **FMS** Knob to highlight 'ACTIVATE APPROACH' as shown in Figure 5-142.
- Press the **ENT** Key to activate the approach.

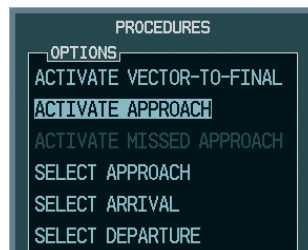

Figure 5-142 Manually Activate Approach

22) The IAF is the next waypoint. At the TOD, establish a descent vertical speed as previously discussed in Step 16. The aircraft altitude is 9,000 feet upon reaching HABUK.

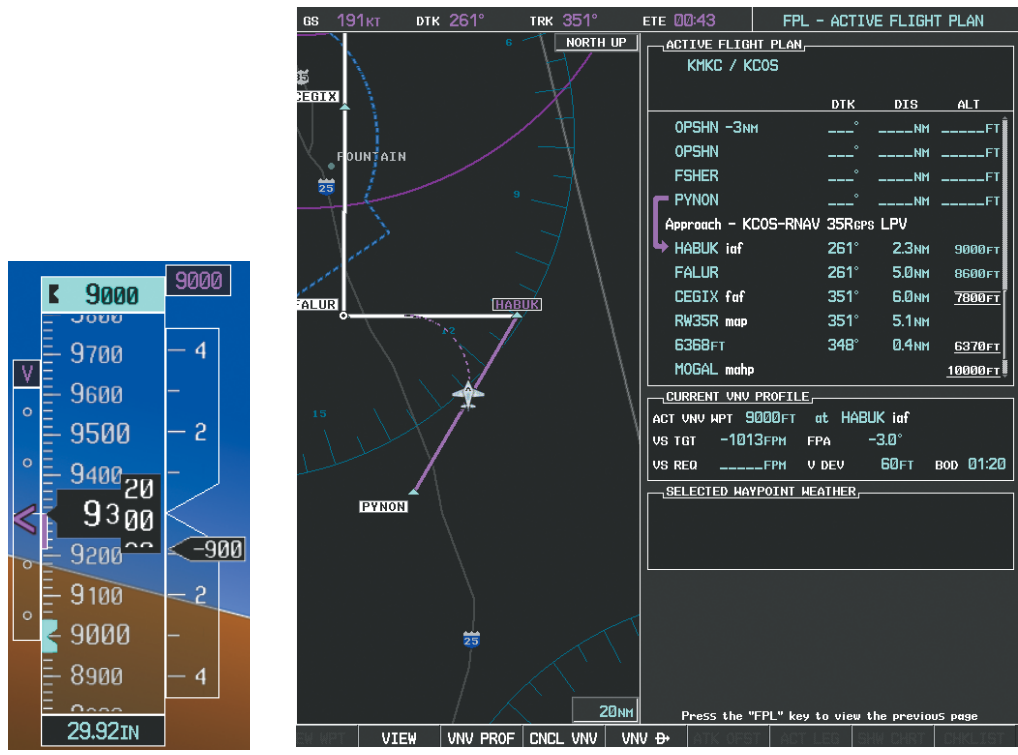

Figure 5-143 Descending Turn to the Initial Approach Fix (IAF)

- 23) After crossing FALUR the next waypoint is the FAF. The flight phase changes to LPV on the HSI indicating the current phase of flight is in Approach Mode and the approach type is LPV. CDI scaling changes accordingly and is used much like a localizer when flying an ILS approach. The RVSI is no longer displayed and the VDI changes to the Glidepath Indicator (as shown in Figure 5-144) when the final approach course becomes active.

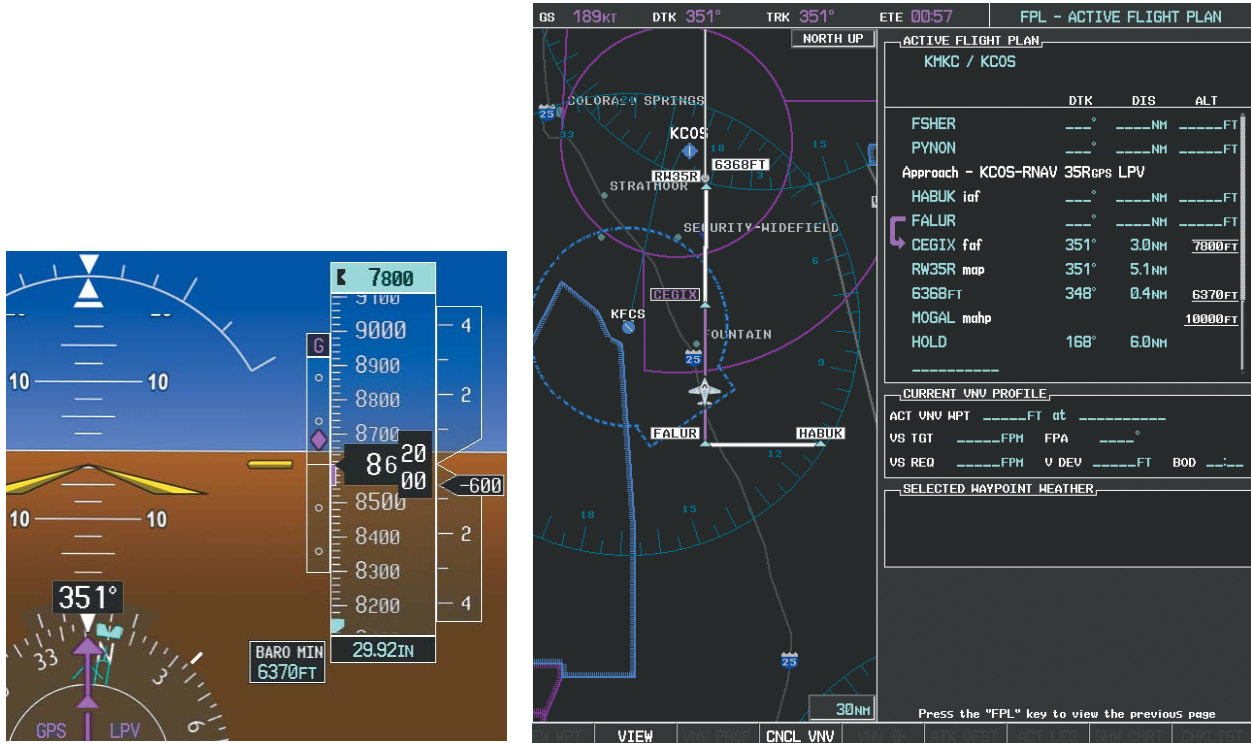

Figure 5-144 Descending to the FAF

The descent continues through the FAF (CEGIX) using the Glidepath Indicator, as one would use a glideslope indicator, to obtain an altitude "AT" 7,800 feet at the FAF. Note the altitude restriction lines over and under (At) the altitude in the 'ALT' field in Figure 5-143.

- 24) After crossing CEGIX, the aircraft continues following the glidepath to maintain the descent to "AT or ABOVE" 6,370 feet at the Missed Approach Point (MAP) (RW35R) as seen in Figure 5-145.

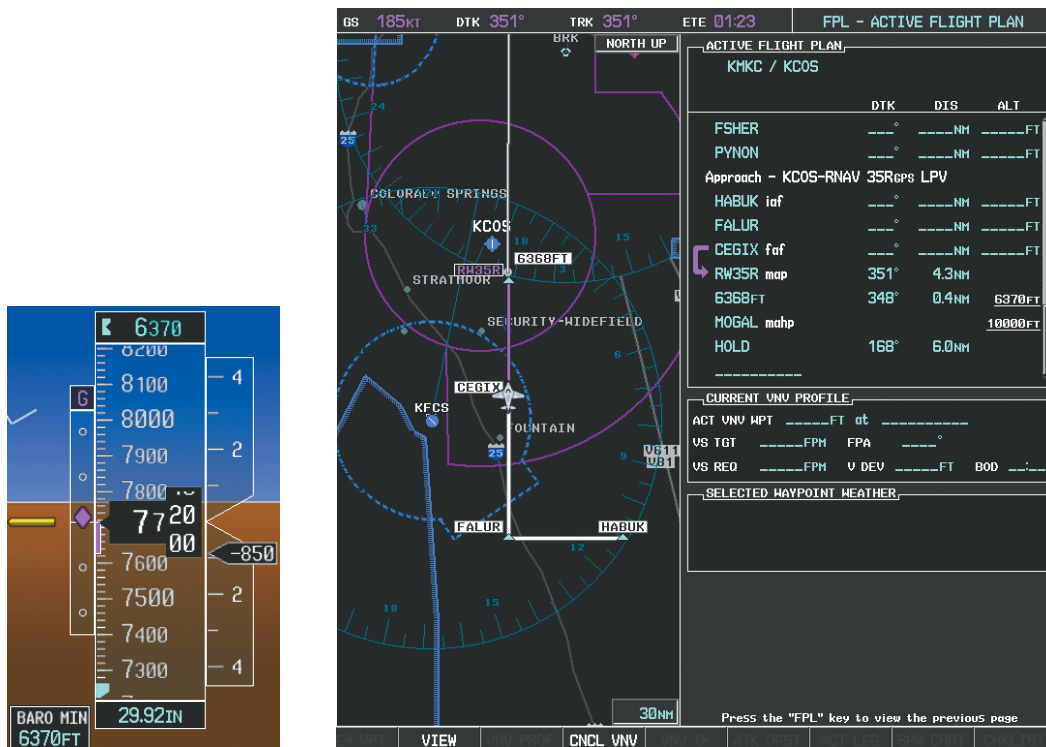

Figure 5-145 Descending to the Missed Approach Point

In this missed approach procedure, the altitude immediately following the MAP (in this case '6368ft') is not part of the published procedure. It is simply a Course to Altitude (CA) leg which guides the aircraft along the runway centerline until the altitude required to safely make the first turn toward the MAHP is exceeded. This altitude is provided by Jeppesen, and may be below, equal to, or above the published minimums for this approach. In this case, if the aircraft altitude is below the specified altitude (6,368 feet) after crossing the MAP, a direct-to is established to provide a course on runway heading until an altitude of 6,368 feet is reached. After reaching 6,368 feet, a direct-to is established to the published MAHP (in this case MOGAL). If the aircraft altitude is above the specified altitude after crossing the MAP, a direct-to is established to the published fix (MOGAL) to begin the missed approach procedure.

In some missed approach procedures this Course to Altitude leg may be part of the published procedure. For example, a procedure may dictate a climb to 5,500 feet, then turn left and proceed to the Missed Approach Hold Point (MAHP). In this case, the altitude would appear in the list of waypoints as '5500ft'. Again, if the aircraft altitude is lower than the prescribed altitude, a direct-to is established on a Course to Altitude leg when the missed approach procedure is activated.

- 25) Upon reaching the MAP, it is decided to execute a missed approach. Automatic waypoint sequencing is suspended past the MAP. Press the **SUSP** Softkey on the PFD to resume automatic waypoint sequencing through the missed approach procedure.

A direct-to is initiated to MOGAL, which is the Missed Approach Hold Point (MAHP) as seen in Figure 5-146. The aircraft is climbing to 10,000 feet. The CDI flight phase now changes from LPV to MAPR as seen on the HSI.

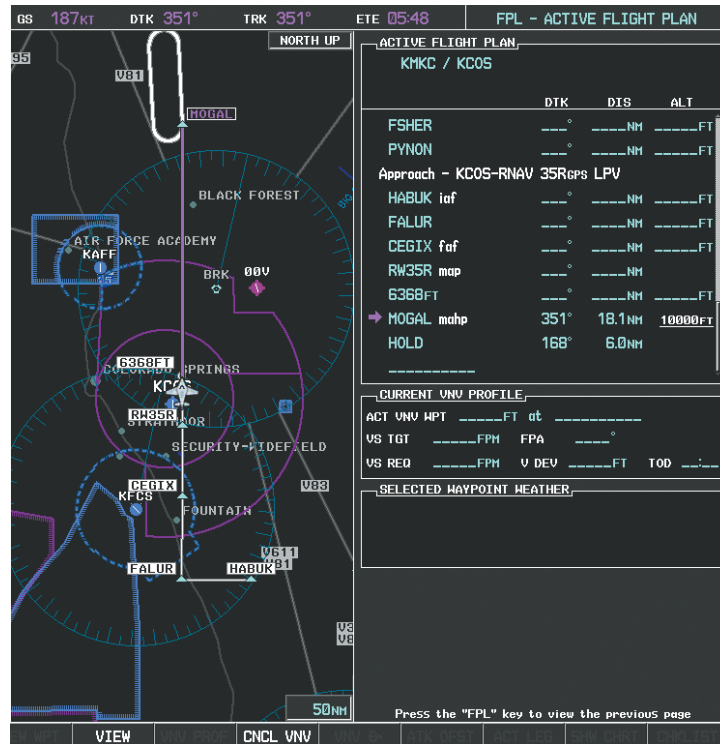

Figure 5-146 Missed Approach Active

26) The aircraft continues climbing to "AT or ABOVE" 10,000 feet at MOGAL. A holding pattern is established at the MAHP (MOGAL) as shown in Figure 5-147.

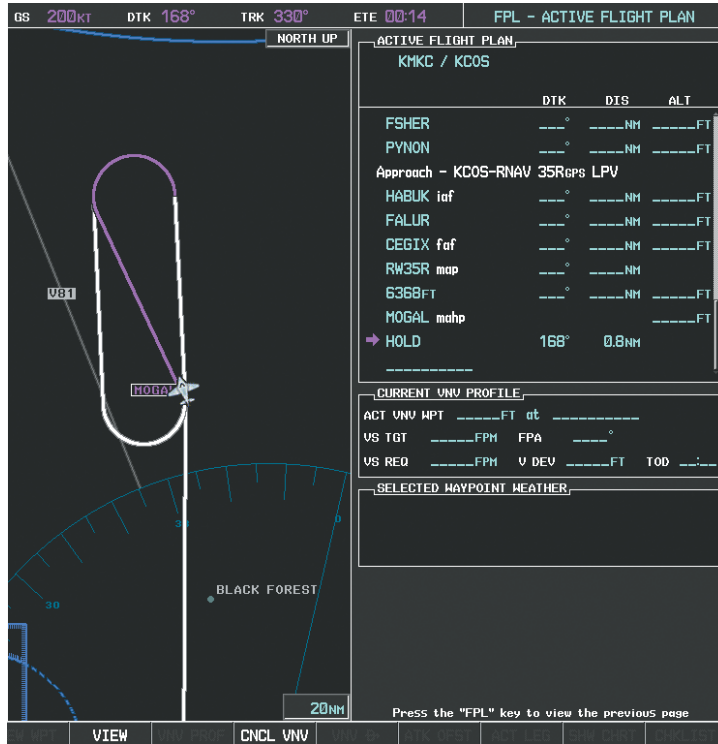

Figure 5-147 Establishing the Holding Pattern

27) The aircraft maintains 10,000 feet while following the magenta line through the hold as in Figure 5-148.

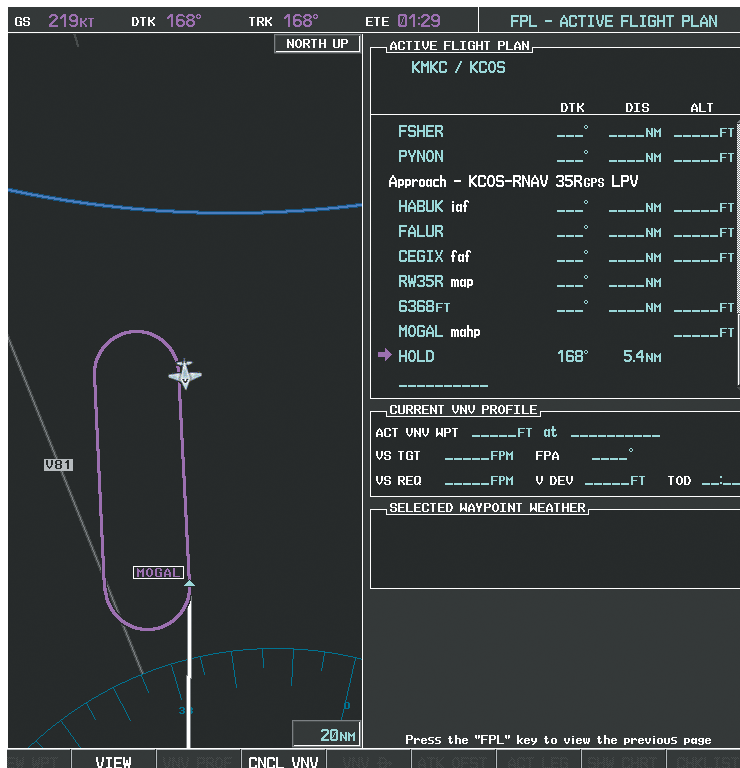

Figure 5-148 Hold Established

5.12 ABNORMAL OPERATION

This section discusses the Dead Reckoning mode of operation and the subsequent indications.



NOTE: *Dead Reckoning Mode only functions in Enroute (ENR) or Oceanic (OCN) phase of flight. In all other phases, an invalid GPS solution produces a "NO GPS POSITION" annunciation on the map and the G1000 stops using GPS.*

While in Enroute or Oceanic phase of flight, if the G1000 detects an invalid GPS solution or is unable to calculate a GPS position, the system automatically reverts to Dead Reckoning (DR) Mode. In DR Mode, the G1000 uses its last-known position combined with continuously updated airspeed and heading data (when available) to calculate and display the aircraft's current estimated position.

It is important to note that estimated navigation data supplied by the G1000 in DR Mode may become increasingly unreliable and must not be used as a sole means of navigation. If while in DR Mode airspeed and/or heading data is also lost or not available, the DR function may not be capable of accurately tracking estimated position and, consequently, the system may display a path that is different than the actual movement of the aircraft. Estimated position information displayed by the G1000 through DR while there is no heading and/or airspeed data available should not be used for navigation.

DR Mode is inherently less accurate than the standard GPS/SBAS Mode due to the lack of satellite measurements needed to determine a position. Changes in wind speed and/or wind direction compound the relative inaccuracy of DR Mode. Because of this degraded accuracy, other navigation equipment must be relied upon for position awareness until GPS-derived position data is restored.

DR Mode is indicated on the G1000 by the appearance of the letters 'DR' superimposed in yellow over the 'own aircraft' symbol as shown in Figure 5-149. In addition, 'DR' is prominently displayed in yellow on the HSI slightly above and to the right of the aircraft symbol on the CDI as shown in Figure 5-149. The CDI deviation bar remains, but is removed from the display after 20 minutes in DR Mode. The autopilot will remain coupled in DR mode as long as the deviation info is available (20 min.) Lastly, but at the same time, a 'GPS NAV LOST' alert message appears on the PFD. Normal navigation using GPS/SBAS source data resumes automatically once a valid GPS solution is restored.

As a result of operating in DR Mode, all GPS-derived data is computed based upon an estimated position and is displayed as yellow text on the display to denote degraded navigation source information as shown in Figure 5-149.

Also, while the G1000 is in DR Mode, TAWS, Terrain SVS or Terrain Proximity are disabled. Additionally, the accuracy of all nearest information (airports, airspace, and waypoints) is questionable. Finally, airspace alerts continue to function, but with degraded accuracy.

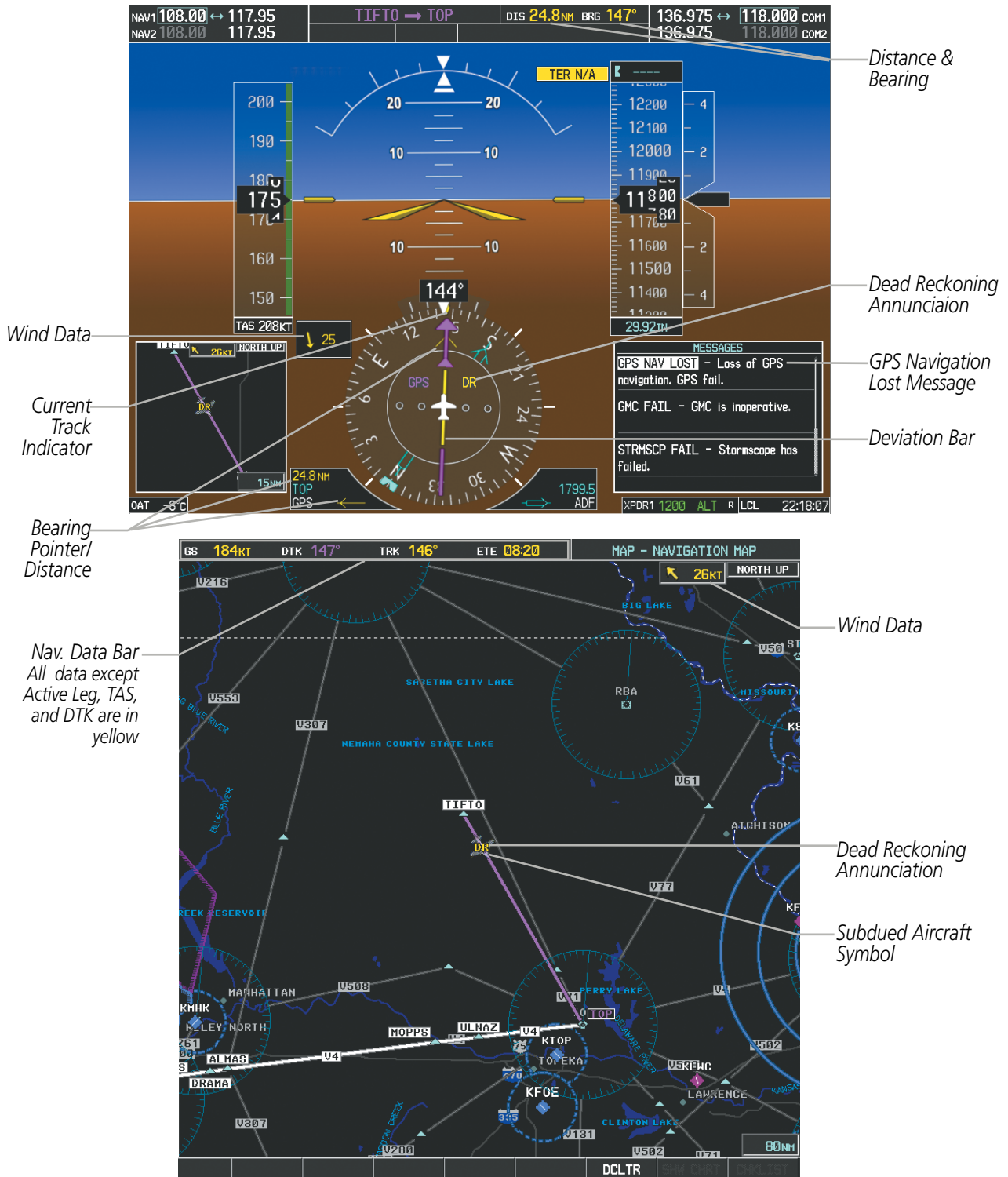

Figure 5-149 Dead Reckoning Mode - GPS Derived Data Shown in Yellow



NOTE: The Inset Map is removed from the PFD any time aircraft pitch is greater than +30° or less than -20°, or when a 65° bank angle is reached.

SECTION 6 HAZARD AVOIDANCE

The G1000 hazard avoidance features are designed to provide advisory information of potential hazards to flight safety associated with weather, terrain, and air traffic.

This section is divided into the following groups:

Weather

- GDL 69/69A XM WX Satellite Weather (Optional)
- GSR 56 Garmin Flight Data Services (GFDS) Worldwide Weather (Optional)
- GWX 68 Airborne Color Weather Radar (Optional)
- L-3 STORMSCOPE® WX-500 Series II Weather Mapping Sensor (Optional)

Terrain Avoidance

- Terrain Proximity
- Terrain-SVS (Standard with SVS Option)
- Terrain Awareness and Warning System - Class B (TAWS-B) (Optional)

Traffic

- TIS (Traffic Information Service)
- Garmin GTS 820 Traffic Advisory System (TAS) (Optional)
- Honeywell® KTA 870 TAS (Optional)

6.1 XM WX SATELLITE WEATHER



NOTE: XM WX Satellite Weather data provides information for avoiding hazardous weather. It is not meant to be used for penetrating hazardous weather.

XM WX Satellite Weather is provided through the GDL 69/69A, a remote-mounted datalink satellite receiver. Received graphical weather information and associated text is displayed on the Multi Function Display (MFD) and the Primary Flight Display (PFD) Inset Map. The GDL 69A can also receive SiriusXM Satellite Radio entertainment services. Both weather data and entertainment programming operate in the S-band frequency range to provide continuous reception capabilities at any altitude throughout North America.

XM WX services from SiriusXM are subscription-based. For more information on specific service packages, visit www.siriusxm.com.

ACTIVATING SERVICES

Before XM WX Satellite Weather and SiriusXM Satellite Radio can be used, the service must be activated. Service is activated by providing coded IDs unique to the installed GDL 69/69A. SiriusXM Satellite Radio (audio) and XM WX Satellite Weather (data) services each have coded IDs. The Data and Audio Radio IDs must be provided to activate the weather service and entertainment subscriptions, respectively. These IDs are located on:

- The label on the back of the Data Link Receiver
- The XM Information Page on the MFD (Figure 6-1)
- The XM Satellite Radio Activation Instructions included with the unit (available at www.garmin.com, P/N 190-00355-04)

Contact the installer if the Audio and Data Radio IDs cannot be located.

SiriusXM uses the coded IDs to send an activation signal that allows the system to display weather data and/or entertainment programming provided through the GDL 69/69A.

Activating XM WX Satellite Weather and SiriusXM Satellite Radio services:

- 1) Contact SiriusXM by e-mail (address listed on their website, www.siriusxm.com) or by the customer service phone number listed on the website. Follow the instructions provided by SiriusXM.
- 2) Select the XM Page in the Auxiliary Page Group.
- 3) Press the **INFO** Softkey to display the XM Information Page.
- 4) Verify that the desired services are activated.
- 5) Press the **LOCK** Softkey.
- 6) Turn the large **FMS** Knob to highlight 'YES'.
- 7) To complete activation, press the **ENT** Key.

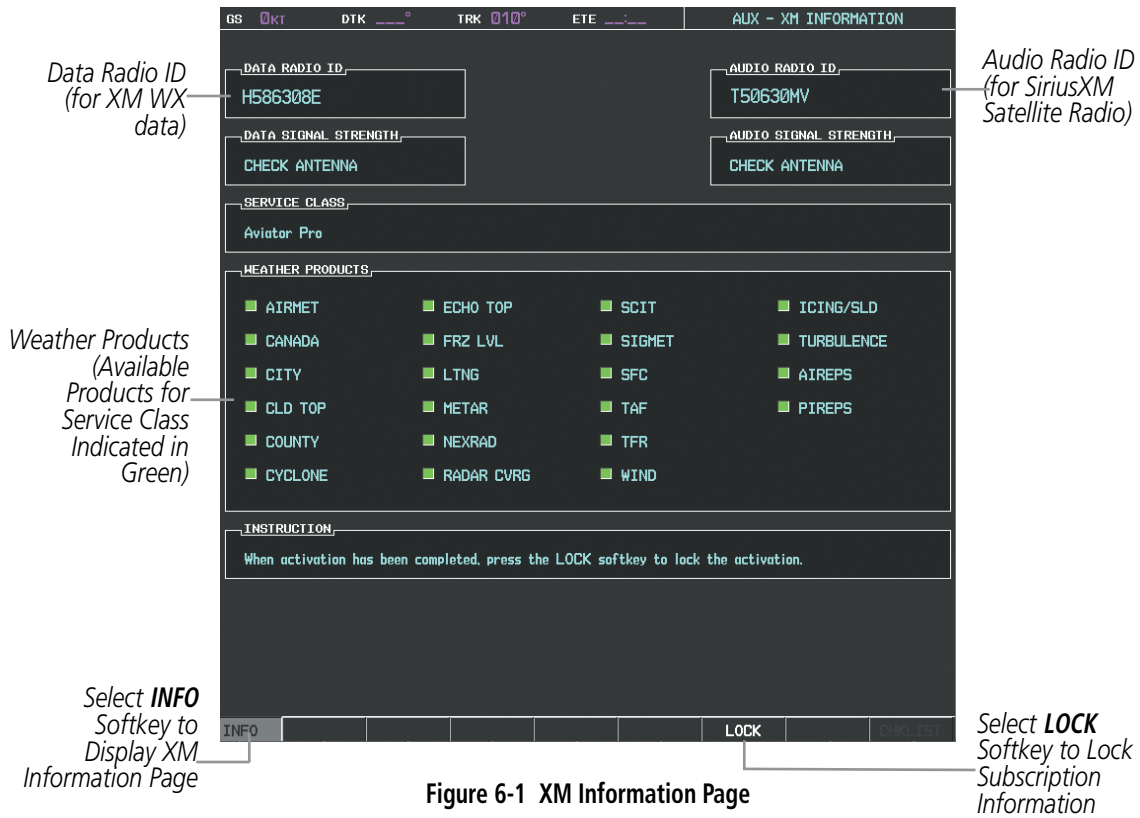

Figure 6-1 XM Information Page

USING XM WX PRODUCTS

The principal map for viewing XM WX data is the Weather Data Link (XM) Page in the Map Page Group. This is the only G1000 map display capable of showing information for all available XM WX products.

Viewing the Weather Data Link Page:

- 1) Turn the large **FMS** Knob to select the Map Page Group.
- 2) Turn the small **FMS** Knob to select the Weather Data Link (XM or GFDS) Page. If 'GFDS' is displayed in the page title, continue with this procedure to change the datalink source to XM WX.
- 3) Press the **MENU** Key.
- 4) Turn the small **FMS** Knob to select 'Display XM Weather' and press the **ENT** Key. The page title will display 'Weather Data Link (XM)' to indicate XM WX is the selected weather datalink source.

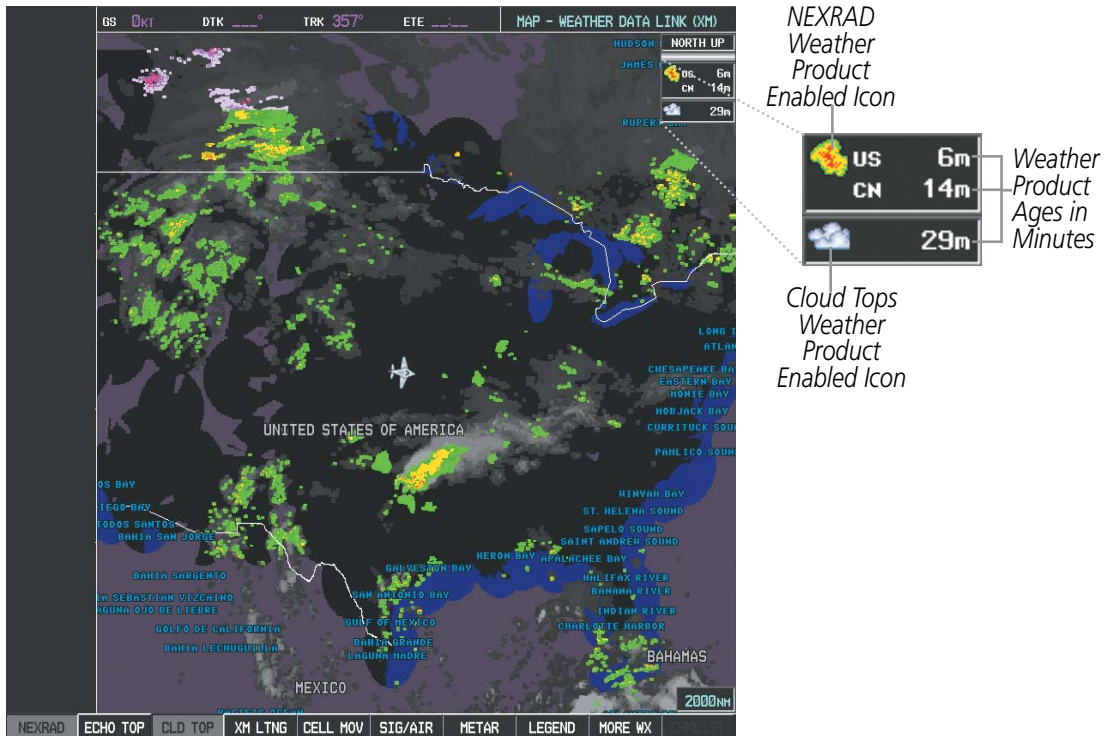

Figure 6-2 Weather Data Link Page

When a weather product is active on the Weather Data Link (XM) Page or the Navigation Map Page, the corresponding product symbol and age of the data are displayed inside a status box (Figure 6-2). The age of the product is based on the time difference between when the data was assembled on the ground and the current GPS time. Weather products are refreshed at specific intervals (defined in the Refresh Rate column in Table 6-1).

If for any reason, a weather product is not refreshed within the defined Expiration Time intervals, the data is considered expired and is removed from the display, and the weather product age is replaced by dashes. This ensures that the displayed data is consistent with what is currently being transmitted by XM WX Satellite Weather services. If more than half of the expiration time has elapsed, the color of the product age is displayed in yellow. If a weather product is not available, 'N/A' is displayed instead of the product age.

Table 6-1 shows the weather product symbols, the expiration time and the refresh rate. The refresh rate represents the interval at which SiriusXM provides new signals that may or may not contain new weather data. It does not represent the rate at which weather data is updated or new content is received by the Data Link Receiver. Weather data is refreshed at intervals that are defined and controlled by SiriusXM and its weather data suppliers, and are subject to change.

















XM WX Product	Symbol	Expiration Time (Minutes)	Minimum Refresh Rate (Minutes)
Next-generation Radar (NEXRAD)		30	5 (U.S.) 10 (Canada)
Cloud Top (CLD TOP)		60	15
Echo Top (ECHO TOP)		30	7.5
XM Lightning (LTNG)		30	5
Cell Movement (CELL MOV)		30	12
SIGMETs/AIRMETs (SIG/AIR)		60	12
Meteorological Aerodrome Report (METARs)		90	12
City Forecast (CITY)		60	12
Surface Analysis (SFC)		60	12
Freezing Levels (FRZ LVL)		60	12
Winds Aloft (WIND)		60	12
County Warnings (COUNTY)		60	5
Cyclone Warnings (CYCLONE)		60	12
Icing Potential (CIP and SLD) (ICNG)		90	12
Pilot Weather Report (PIREPs)		90	12
Air Report (AIREPs)		90	12
Turbulence (TURB)		180	12
No Radar Coverage (RADAR CVRG)	no product image	30	5
Temporary Flight Restrictions (TFRs)	no product image	60	12
Terminal Aerodrome Reports (TAFs)	no product image	60	12

Table 6-1 Weather Product Symbols and Data Timing

This table shows which XM WX products can be displayed (indicated with a '+' symbol) on specific maps.

XM WX Product	PFD Inset Map	Navigation Map Page	Weather Data Link (XM) Page	Weather Information Page	AUX - Trip Planning Page	System Page Group	Nearest Page Group	Flight Plan Pages
NEXRAD	+	+	+		+	+	+	+
Cloud Top (CLD TOP)			+					
Echo Top (ECHO TOP)			+					
XM Lightning (LTNG)	+	+	+		+	+	+	+
Cell Movement (CELL MOV)		+	+		+	+	+	+
SIGMETs/AIRMETs (SIG/AIR)			+					
METARs	+	+	+	+	+	+	+	+
City Forecast (CITY)			+					
Surface Analysis (SFC)			+					
Freezing Levels (FRZ LVL)			+					
Winds Aloft (WIND)		+	+					
County Warnings (COUNTY)			+					
Cyclone Warnings (CYCLONE)			+					
Icing Potential (ICNG)			+					
PIREPs			+	+				
AIREPs			+	+				
Turbulence (TURB)			+					
Radar Coverage	+	+	+		+	+	+	+
TFRs	+	+	+	+	+	+	+	+
TAFs			+	+				

* Winds Aloft data on Navigation Map Page displayed inside Profile View when enabled.

Table 6-2 Weather Product Display Maps (XM WX)

WEATHER SOFTKEYS ON THE WEATHER DATA LINK (XM) PAGE

Softkeys control the display of weather information on most MFD pages and the PFD Inset Map (The figure shows the weather product softkeys for the Weather Data Link (XM) Page). When a weather product is selected for display, the corresponding softkey label changes to gray to indicate the product is enabled. Unavailable weather products have subdued softkey labels (softkeys are disabled from selection).

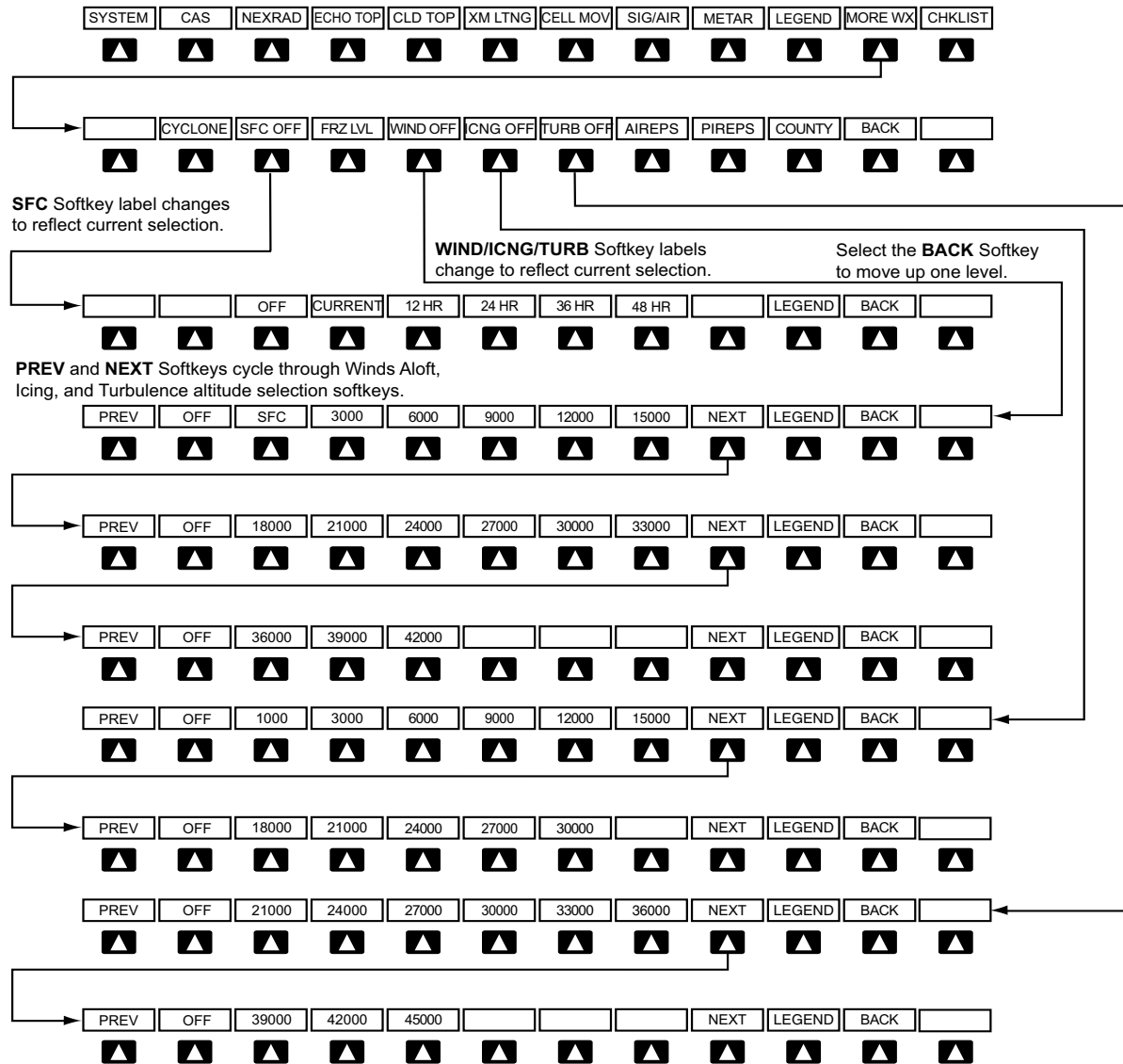

Figure 6-3 Weather Data Link Weather Product Softkeys

The setup menus for the Navigation Map Page and the Weather Data Link (XM) Page control the map range settings above which weather products data are decluttered from the display. If a map range larger than the weather product map range setting is selected, the weather product data is removed from the map. The menus also provide a means in addition to the softkeys for enabling/disabling display of weather products.

Setting up and customizing the Weather Data Link (XM) Page:

- 1) Select the Weather Data Link (XM) Page.
- 2) Press the **MENU** Key.
- 3) With 'Weather Setup' highlighted, press the **ENT** Key (Figure 6-4).
- 4) Turn the small **FMS** Knob to select 'Product Group 1' or 'Product Group 2', and press the **ENT** Key (Figure 6-5).
- 5) Turn the large **FMS** Knob or press the **ENT** Key to scroll through product selections.
- 6) Turn the small **FMS** Knob to scroll through options for each product (ON/OFF, range settings, etc.).
- 7) Press the **ENT** Key to select an option.
- 8) Press the **FMS** Knob or **CLR** Key to return to the Weather Data Link (XM) Page with the changed settings.



Figure 6-4 Weather Data Link (XM) Page Menu

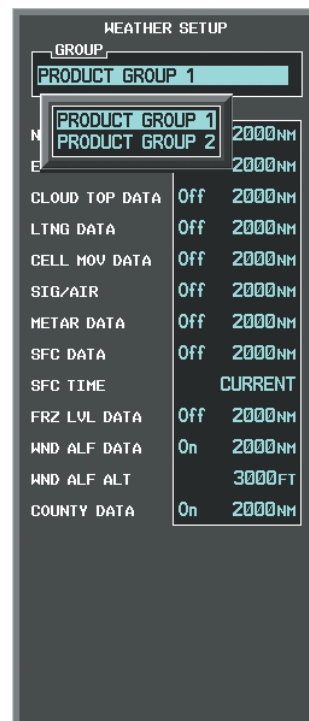

Figure 6-5 Weather Data Link (XM) Page Setup Menu

Restoring default Weather Data Link (XM) Page settings:

- 1) Select the Weather Data Link (XM) Page with the **FMS** Knob.
- 2) Press the **MENU** Key.
- 3) With Weather Setup highlighted, press the **ENT** Key.
- 4) Press the **MENU** Key.
- 5) Highlight the desired default(s) to restore (all or for selection) and press the **ENT** Key.

The G1000 supports the installation of both the GSR 56 for Garmin Flight Data Services (GFDS) Worldwide Weather and the GDL69A for XM WX Satellite Weather. Only one set of datalink weather products (GFDS or XM WX) can be selected for display at a time.

Switching between GFDS and XM WX datalink sources:

- 1) Turn the large **FMS** Knob on the MFD to select the MAP page group.
- 2) Turn the small **FMS** Knob to select the Weather Data Link (XM or GFDS) Page.
- 3) Press the MENU Key.
- 4) Turn the large **FMS** Knob to select 'Display XM Weather' or 'Display GFDS' Weather' (choice dependent on current weather source) and press the **ENT** Key.

If both XM WX and GFDS datalink weather services are installed, customizing the display settings for the corresponding weather products shown in Table 6-3 will result in identical settings for both services.

XM WX Product	GFDS Worldwide Weather Product
Next-generation Radar (NEXRAD)	Precipitation (PRECIP)
Cloud Top (CLD TOP)	Infrared Satellite (IR SAT)
XM Lightning (XM LTNG)	GFDS Lightning (DL LTNG)
SIGMETs/AIRMETs (SIG/AIR)	SIGMETs/AIRMETs (SIG/AIR)
Meteorological Aerodrome Report (METARs)	Meteorological Aerodrome Report (METARs)
Winds Aloft (WIND)	Winds Aloft (WIND)
Pilot Weather Report (PIREPs)	Pilot Weather Report (PIREPs)
Temporary Flight Restriction (TFR)	Temporary Flight Restriction (TFR)

Table 6-3 Corresponding XM and GFDS Weather Products

Maps other than the Weather Data Link (XM) Page use settings based on those selected for the Navigation Map Page.

Setting up and customizing weather data for the Navigation Map Page:

- 1) Select the Navigation Map Page.
- 2) Press the **MENU** Key.
- 3) With Map Setup highlighted, press the **ENT** Key (Figure 6-6).
- 4) Turn the small **FMS** Knob to select the Weather Group and press the **ENT** Key (Figure 6-7).
- 5) Turn the large **FMS** Knob or press the **ENT** Key to scroll through product selections (Figure 6-8).

- 6) Turn the small **FMS** Knob to scroll through options for each product (ON/OFF, range settings).
- 7) Press the **ENT** Key to select an option.
- 8) Press the **FMS** Knob or **CLR** Key to return to the Navigation Map Page with the changed settings.

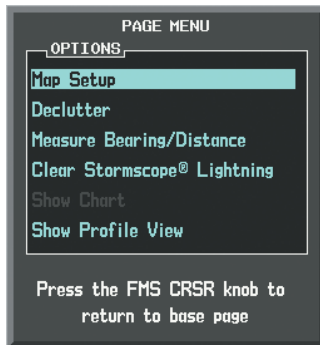

Figure 6-6 Navigation Map Page Menu

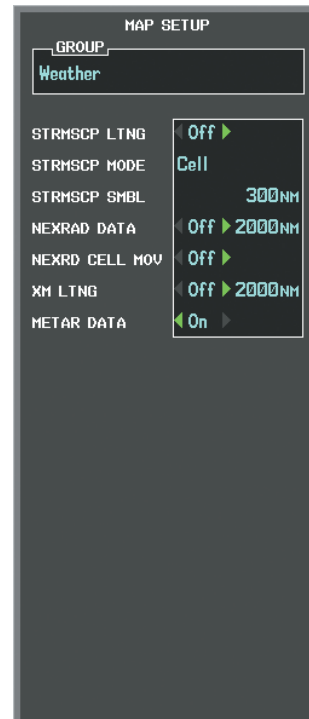

Figure 6-8 Navigation Map Page Setup Menu, Weather Group



Figure 6-7 Navigation Map Page Setup Menu

When an XM WX product is enabled for display on the PFD Inset Map, the weather product information box (with the product icon and age) can be displayed inside the PFD Inset Map.

Viewing the weather product information box on the PFD Inset Map:

- 1) On the PFD, press the **INSET** Softkey.
- 2) Press the **WX LGND** Softkey.
- 3) To remove the weather product information box, press the **WX LGND** Softkey again or deselect all active XM weather products on the PFD Inset Map.

Each active weather product has an associated legend which can be displayed on the Weather Data Link (XM) Page.

Viewing legends for displayed weather products on the Weather Data Link (XM) Page:

- 1) Select the Weather Data Link (XM) Page with the **FMS** Knob.
- 2) Select the **LEGEND** Softkey to display the legends for the displayed weather products.

Or:

- 1) Press the **MENU** Key.

- 2) Select Weather Legend and press the **ENT** Key.
- 3) Turn the **FMS** Knob to scroll through the legends if more are available than fit in the window.
- 4) To remove the Legend Window, select the **LEGEND** Softkey, the **ENT** or the **CLR** Key, or press the **FMS** Knob.

Additional information about the following can be displayed by panning over the display on the map:

- Echo Tops
- Cell Movement
- SIGMETs
- AIRMETs
- METARs
- County Warnings
- TFRs

The map panning feature is enabled by pressing the **RANGE** Knob. The map range is adjusted by turning the **RANGE** Knob. If the map range is adjusted while panning is enabled, the map is re-centered on the Map Pointer.

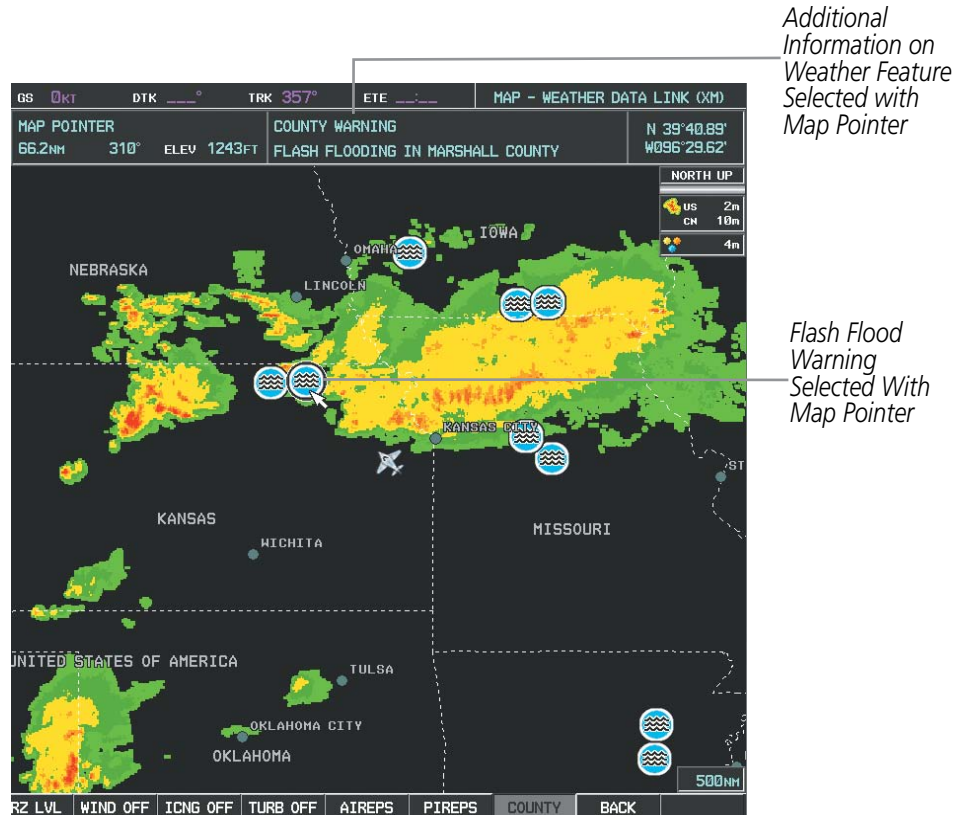

Figure 6-9 Panning on the Weather Data Link (XM) Page

NEXRAD



NOTE: NEXRAD data cannot be displayed at the same time as terrain, echo tops, turbulence, or icing data is displayed.

WSR-88D, or NEXRAD (NEXt-generation RADar), is a network of 158 high-resolution Doppler radar systems that are operated by the National Weather Service (NWS). NEXRAD data provides centralized meteorological information for the continental United States and selected overseas locations. The maximum range of a single NEXRAD radar site is 250 nm. In addition to a wide array of services, the NEXRAD network provides important information about severe weather for air traffic safety.

NEXRAD data is not real-time. The lapsed time between collection, processing, and dissemination of NEXRAD images can be significant and may not reflect the current radar synopsis. Due to the inherent delays and the relative age of the data, it should be used for long-range planning purposes only. Never use NEXRAD data or any radar data to penetrate hazardous weather. Instead, use it in an early-warning capacity of pre-departure and enroute evaluation.

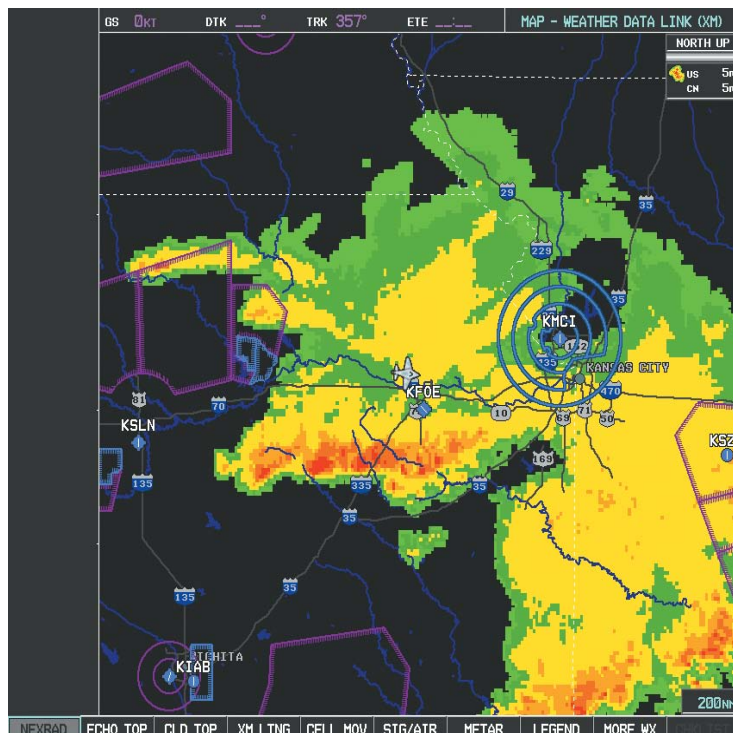

Figure 6-10 NEXRAD Data on the Weather Data Link Page

NEXRAD data can be displayed on the following maps:

- PFD Inset Map
- Navigation Map Page
- Weather Data Link Page
- Airport Information Page
- Trip Planning Page
- Nearest Pages
- Flight Plan Pages

Displaying NEXRAD weather information:

- 1) Select the **MAP** Softkey (for the PFD Inset Map, select the **INSET** Softkey). This step is not necessary on the Weather Data Link (XM) Page.
- 2) Select the **NEXRAD** Softkey.

Composite data from all the NEXRAD radar sites in the United States is shown. This data is composed of the maximum reflectivity from the individual radar sweeps. The display of the information is color-coded to indicate the weather severity level. All weather product legends can be viewed on the Weather Data Link (XM) Page. For the NEXRAD legend, select the **LEGEND** Softkey when NEXRAD is selected for display.

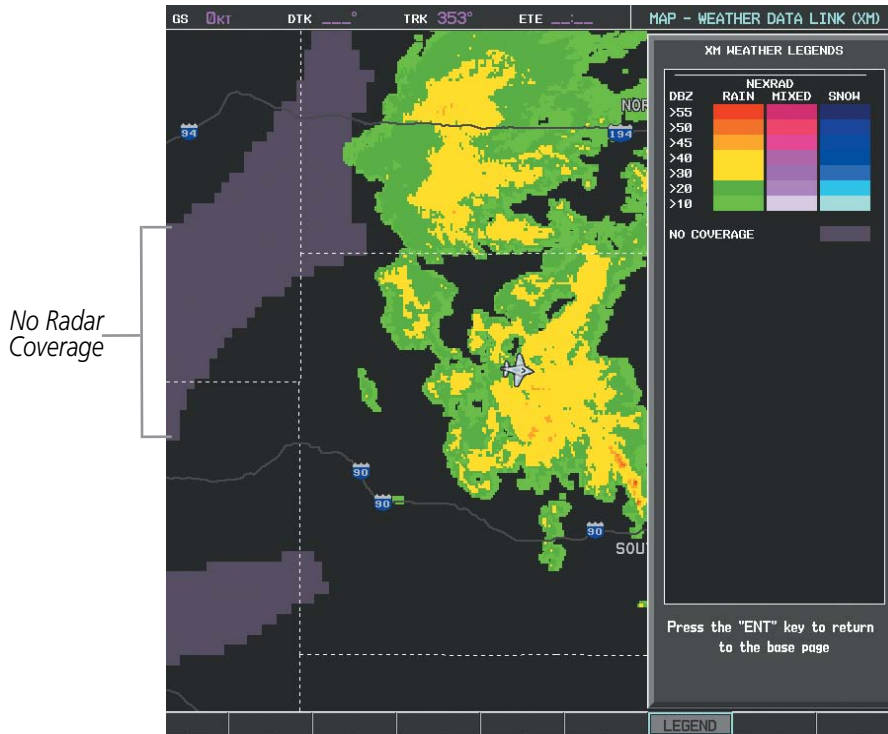

Figure 6-11 NEXRAD Data with Legend

The display of radar coverage is always active when either NEXRAD or Echo Tops is selected. Areas where NEXRAD radar coverage and Echo Tops information is not currently available or is not being collected are indicated in a gray shade of purple.

REFLECTIVITY

Reflectivity is the amount of transmitted power returned to the radar receiver. Colors on the NEXRAD display directly correlate to the level of detected reflectivity. Reflectivity as it relates to hazardous weather can be very complex.

The role of radar is essentially to detect moisture in the atmosphere. Simply put, certain types of weather reflect radar better than others. The intensity of a radar reflection is not necessarily an indication of the weather hazard level. For instance, wet hail returns a strong radar reflection, while dry hail does not. Both wet and dry hail can be extremely hazardous.

The different NEXRAD echo intensities are measured in decibels (dB) relative to reflectivity (Z). NEXRAD measures the radar reflectivity ratio, or the energy reflected back to the radar receiver (designated by the letter Z). The value of Z increases as the returned signal strength increases.

NEXRAD LIMITATIONS

NEXRAD radar images may have certain limitations:

- NEXRAD base reflectivity does not provide sufficient information to determine cloud layers or precipitation characteristics. For example, it is not possible to distinguish between wet snow, wet hail, and rain.
- NEXRAD base reflectivity is sampled at the minimum antenna elevation angle. An individual NEXRAD site cannot depict high altitude storms at close ranges. It has no information about storms directly over the site.
- When zoomed in to a range of 30 nm, each square block on the display represents an area of four square kilometers. The intensity level reflected by each square represents the highest level of NEXRAD data sampled within the area.
- Any unknown precipitation type below 52°N is displayed as rain.

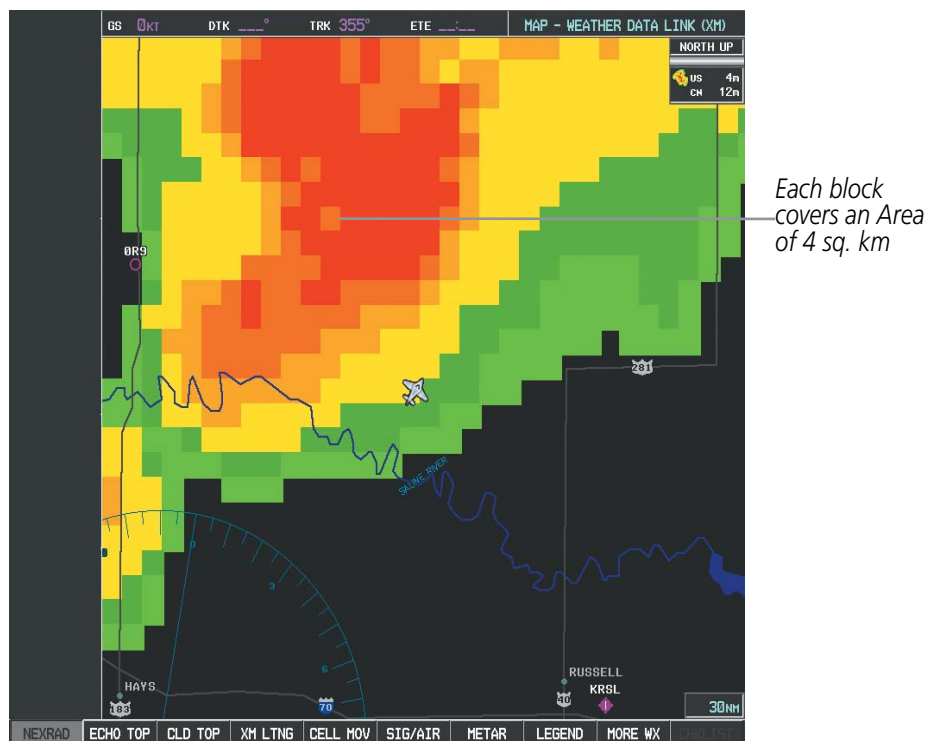

Figure 6-12 NEXRAD Data - Zoomed

The following may cause abnormalities in displayed NEXRAD radar images:

- Ground clutter
- Strokes and spurious radar data
- Sun strokes (when the radar antenna points directly at the sun)
- Interference from buildings or mountains, which may cause shadows
- Metallic dust from military aircraft, which can cause alterations in radar scans

NEXRAD LIMITATIONS (CANADA)

- Radar coverage extends to 55°N.
- Any precipitation displayed between 52°N and 55°N is displayed as mixed.

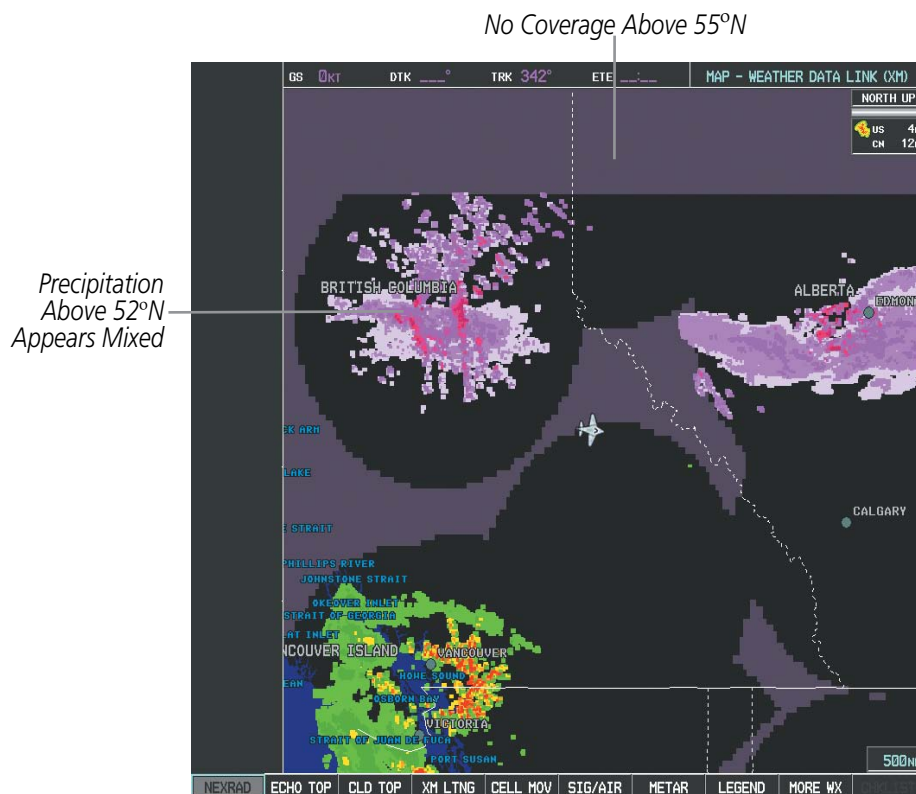

Figure 6-13 NEXRAD Data - Canada

ECHO TOPS



NOTE: Echo tops cannot be displayed at the same time as NEXRAD or Cloud Tops are selected for display.

Echo Tops data (Figure 6-14) shows the location, elevation, and direction of the highest radar echo. The highest radar echo does not indicate the top of a storm or clouds; rather it indicates the highest altitude at which precipitation is detected. Information is derived from NEXRAD data.

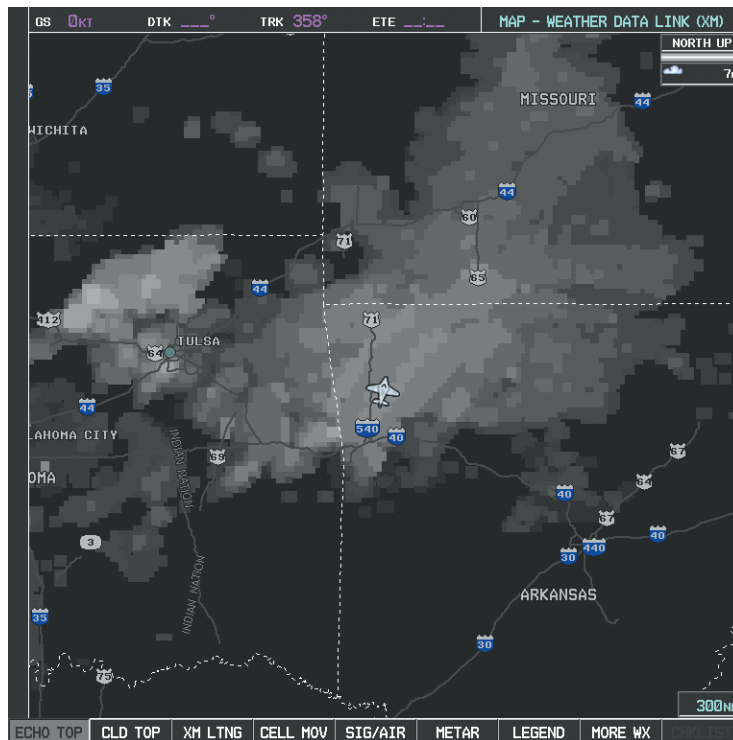

Figure 6-14 Echo Tops Data

Displaying Echo Tops information:

- 1) Select the Weather Data Link (XM) Page with the **FMS** Knob.
- 2) Select the **ECHO TOP** Softkey.

To display the Echo Tops legend, select the **LEGEND** Softkey when Echo Tops is selected for display. Since Echo Tops and Cloud Tops use the same color scaling to represent altitude, display of these weather products is mutually exclusive. When Echo Tops is activated, NEXRAD and Cloud Tops data are removed.

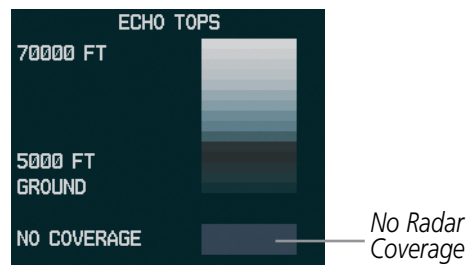

Figure 6-15 Echo Tops Legend

The display of radar coverage is always active when either NEXRAD or Echo Tops is selected. Areas where NEXRAD radar coverage and Echo Tops information is not available or is not being collected are indicated in a gray shade of purple.

CLOUD TOPS



NOTE: *Cloud Tops and Echo Tops cannot be displayed at the same time.*

Cloud Tops data (Figure 6-16) depicts cloud top altitudes as determined from satellite imagery.

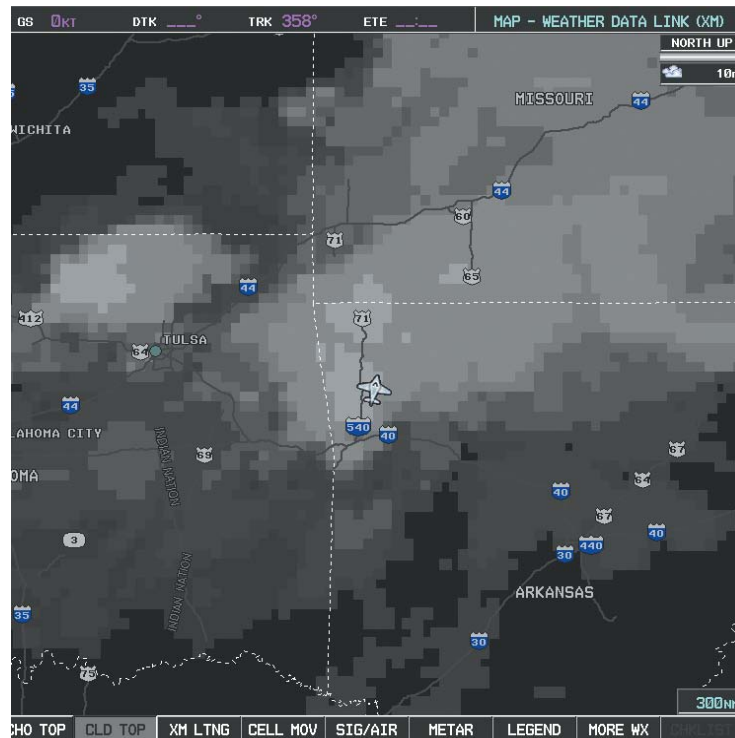

Figure 6-16 Cloud Tops Data

Displaying Cloud Tops information:

- 1) Select the Weather Data Link (XM) Page with the **FMS** Knob.
- 2) Select the **CLD TOP** Softkey.

To display the Cloud Tops legend, select the **LEGEND** Softkey when Cloud Tops is selected for display. Since Cloud Tops and Echo Tops use the same color scaling to represent altitude, display of these weather products is mutually exclusive. When Cloud Tops is activated, Echo Tops data is removed.

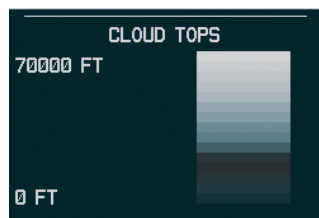

Figure 6-17 Cloud Tops Legend

XM LIGHTNING



NOTE: XM Lightning cannot be displayed at the same time as optional L-3 STORMSCOPE® WX-500 Lightning data.

Lightning data (Figure 6-18) shows the approximate location of cloud-to-ground lightning strikes. A strike icon represents a strike that has occurred within a two-kilometer region. The exact location of the lightning strike is not displayed.

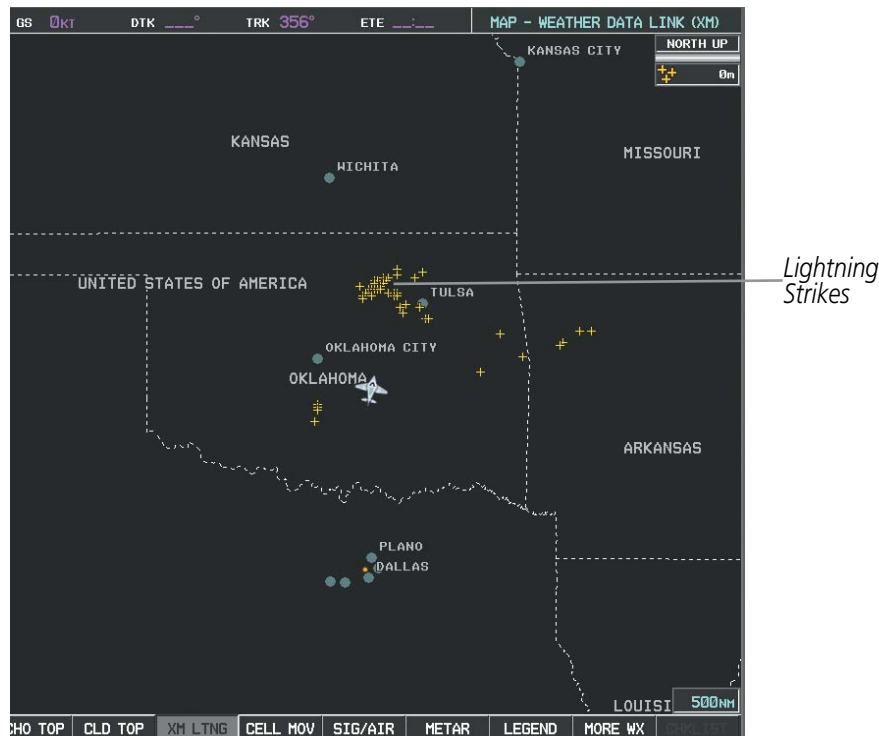

Figure 6-18 Lightning Data

XM Lightning data displays on the following maps:

- PFD Inset Map
- Navigation Map Page
- Weather Data Link Page
- Trip Planning Page
- Nearest Pages
- Flight Plan Pages

Displaying XM Lightning information:

- 1) Select the **MAP** Softkey (for the PFD Inset Map, select the **INSET** Softkey). This step is not necessary on the Weather Data Link (XM) Page.
- 2) Select the **XM LTNG** Softkey.

To display the XM Lightning legend on the Weather Data Link (XM) Page, select the **LEGEND** Softkey when XM Lightning is selected for display.

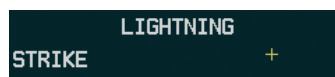

Figure 6-19 Lightning Legend

CELL MOVEMENT

Cell Movement data (Figure 6-20) shows the location and movement of storm cells as identified by the ground-based system. Cells are represented by yellow squares, with direction of movement indicated with short, orange arrows.

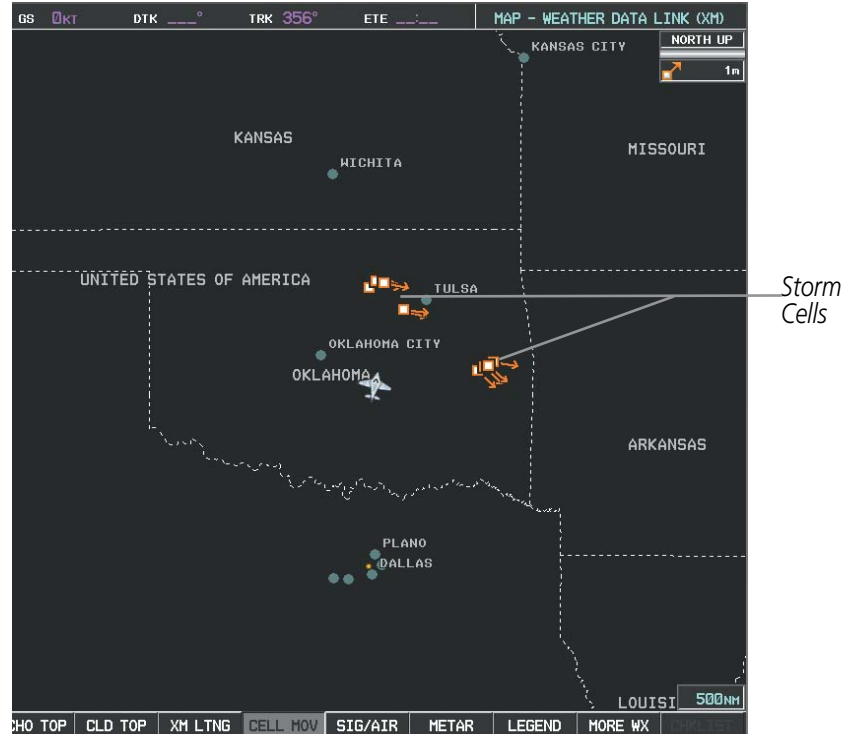

Figure 6-20 Cell Movement Data

On most applicable maps, Cell Movement data is selected for display along with NEXRAD. On the Weather Data Link (XM) Page, Cell Movement data can be selected independently. Cell Movement data can be displayed on the following maps:

- PFD Inset Map
- AUX - Trip Planning Page
- Navigation Map
- Nearest Pages

Displaying Cell Movement information:

- 1) Select the **MAP** Softkey (for the PFD Inset Map, select the **INSET** Softkey). This step is not necessary on the Weather Data Link (XM) Page.
- 2) Select the NEXRAD Softkey (CEL MOV Softkey on the Weather Data Link (XM) Page). For Cell Movement to be displayed on maps other than the Weather Data Link (XM) Page, Cell Movement must be turned on in the Navigation Map Setup Menu (see "Setting up and customizing weather data for the Navigation Map Page").

To display the Cell Movement legend on the Weather Data Link (XM) Page, select the **LEGEND** Softkey when Cell Movement is selected for display.

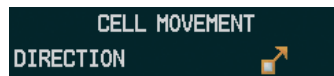

Figure 6-21 Cell Movement Legend

SIGMETS AND AIRMETS

SIGMETs (SIGnificant METeorological Information) and AIRMETs (AIRmen’s METeorological Information) are broadcast for potentially hazardous weather. A Convective SIGMET is issued for hazardous convective weather. A localized SIGMET is a significant weather condition occurring at a localized geographical position.

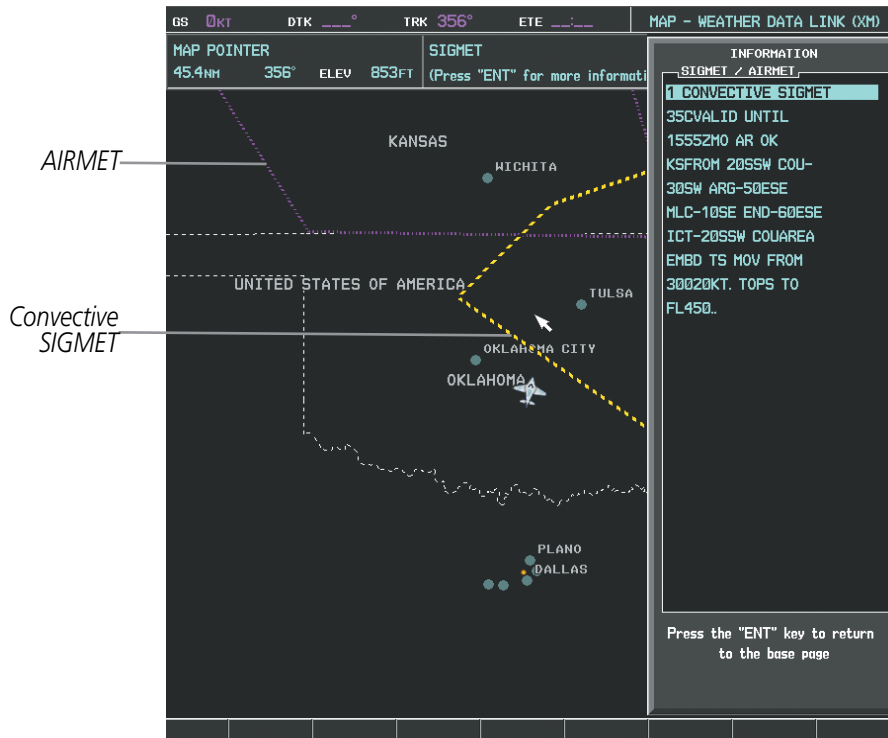

Figure 6-22 SIGMET/AIRMET Data

Displaying SIGMETs and AIRMETs:

- 1) Select the Weather Data Link (XM) Page with the **FMS** Knob.
- 2) Select the **SIG/AIR** Softkey.
- 3) To view the text of the SIGMET or AIRMET, press the **RANGE** Knob and move the Map Pointer over the icon.
- 4) Press the **ENT** key. The figure below shows a sample of SIGMET text.

To display the SIGMET and AIRMET legend, select the **LEGEND** Softkey when SIGMETs and AIRMETs are selected for display.



Sample SIGMET Text

SIGMET/AIRMET Legend

Figure 6-23 SIGMET/AIRMET Text and Legend

METARS AND TAFS

NOTE: Atmospheric pressure reported for METARs is given in hectopascals (hPa), except in the United States, where it is reported in inches of mercury (in Hg). Temperatures are reported in Celsius.

NOTE: METAR information is only displayed within the installed navigation database service area.

METARs (METeorological Aerodrome Reports) typically contain information about the temperature, dewpoint, wind, precipitation, cloud cover, cloud heights, visibility, and barometric pressure at an airport or observation station. They can also contain information on precipitation amounts, lightning, and other critical data. METARs reflect hourly observations; non-routine updates include the code “SPECI” in the report. METARs are shown as colored flags at airports that provide them.

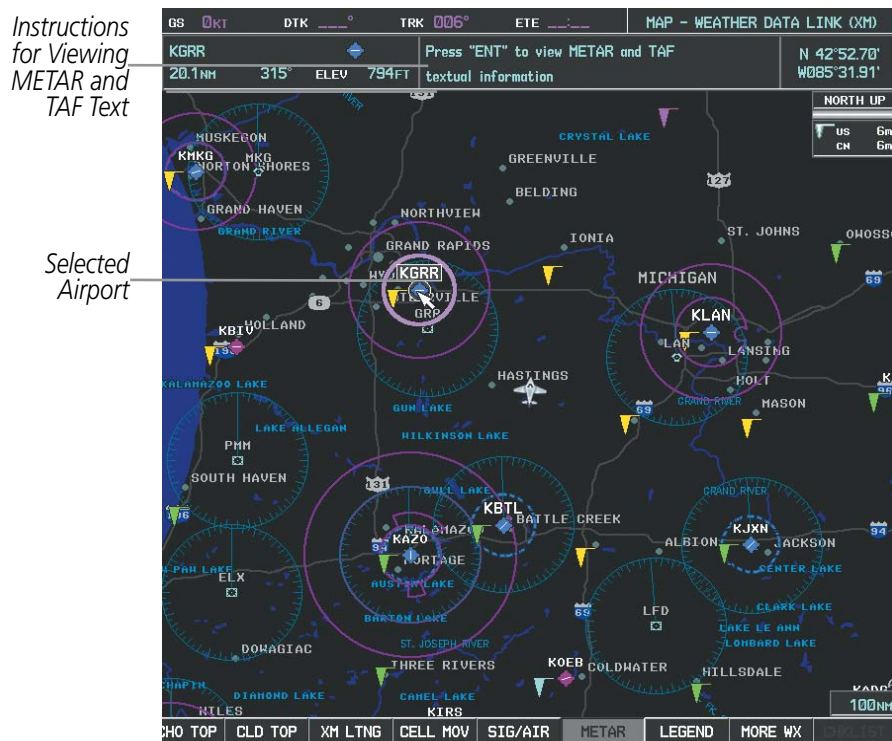

Figure 6-24 METAR Flags on the Weather Data Link Page

TAFs (Terminal Aerodrome Forecasts) are weather predictions for specific airports within a 24- hour period, and may span up to 36 hours. TAFs typically include forecast wind, visibility, weather phenomena, and sky conditions using METAR codes.

METAR and TAF text are displayed on the Weather Information Page. METAR data is displayed first in a decoded fashion, then as raw text. TAF information is displayed only in its raw form when it is available

Displaying METAR and TAF text:

- 1) On the Weather Data Link (XM) Page, select the **METAR** Softkey
- 2) Select the **RANGE** Knob and pan to the desired airport.

- 3) Press the **ENT** Key. The Weather Information Page is shown with METAR and TAF text.
 - 4) Use the **FMS** Knob or the **ENT** Key to scroll through the METAR and TAF text. METAR text is placed ahead of the TAF text.
 - 5) Press the **FMS** Knob or the **CLR** Key to return to the Weather Data Link (XM) Page.
- Or:**
- 1) Select the Weather Information Page.
 - 2) Select the **WX** Softkey to select the Weather Information Page.
 - 3) Press the **FMS** Knob to display the cursor.
 - 4) Using the **FMS** Knob, enter the desired airport and press the **ENT** Key.
 - 5) Scroll through the METAR and TAF text with the **FMS** Knob or the **ENT** Key. Scroll through all of the METAR text to get to the TAF text.

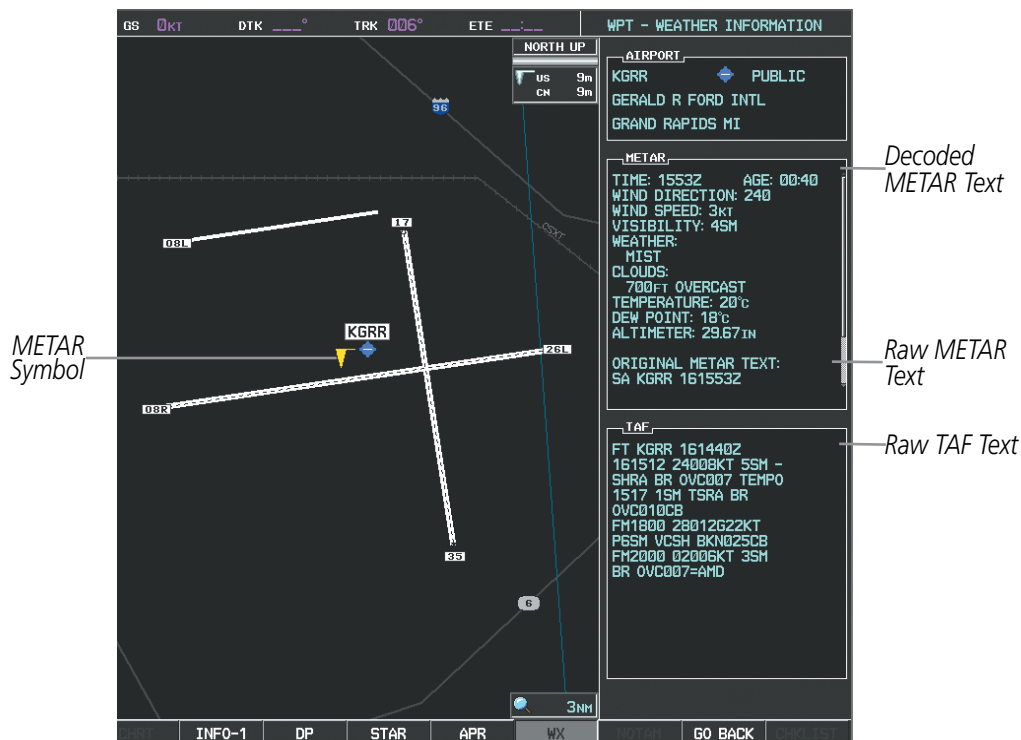

Figure 6-25 METAR and TAF with Text

Raw METAR text is also accessible while panning the map cursor over a METAR flag on any map page on which a METAR is displayed. The METAR text is shown in a box near the METAR flag.

In addition, METAR flags and their associated text are displayed on the Active Flight Plan Page on the MFD. METAR flags appear next to waypoints in the flight plan with an associated METAR.

Displaying raw METAR text on the Active Flight Plan Page:

- 1) Select the Active Flight Plan Page on the MFD.
- 2) Press the **FMS** Knob to activate the cursor.
- 3) Turn the large **FMS** Knob to highlight a waypoint with an associated METAR. The METAR text will appear in the 'SELECTED WAYPOINT WEATHER' window below.
- 4) When finished, press the **FMS** Knob to remove the cursor or press the **FPL** Key to exit the Active Flight Plan Page.

To display the METAR legend on the Weather Data Link (XM) Page, select the **LEGEND** Softkey when METARs are selected for display.

The METAR flag color is determined by the information in the METAR text. The METAR flag is gray when the METAR text does not contain adequate information.



Figure 6-26 METAR Legend

SURFACE ANALYSIS AND CITY FORECAST



NOTE: Surface Analysis and City Forecast data are displayed only within the installed navigation database service area.

Surface Analysis and City Forecast information (Figure 6-27) is available for current and forecast weather conditions. Forecasts are available for intervals of 12, 24, 36, and 48 hours.

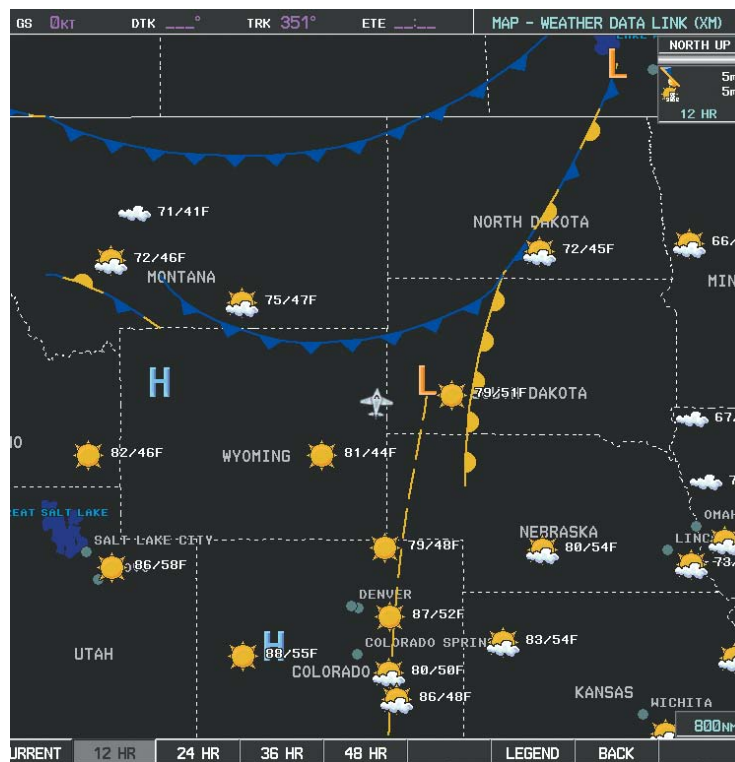

Figure 6-27 Surface Analysis Data - 12-Hour

Displaying Surface Analysis and City Forecast information:

- 1) Select the Weather Data Link (XM) Page with the **FMS** Knob.
- 2) Select the **MORE WX** Softkey.
- 3) Select the **SFC** Softkey.
- 4) Select the forecast time: **CURRENT**, **12 HR**, **24 HR**, **36 HR**, or **48 HR**. The **SFC** Softkey label changes to indicate selected the forecast time.

To display the Surface Analysis and City Forecast legend, select the **LEGEND** Softkey when Surface Analysis and City Forecast are selected for display.



Figure 6-28 Surface Analysis and City Forecast Legend

FREEZING LEVEL

Freezing Level data (Figure 6-29) shows the color-coded contour lines for the altitude and location at which the first isotherm is found. When no data is displayed for a given altitude, the data for that altitude has not been received, or is out of date and has been removed from the display. New data appears at the next update.

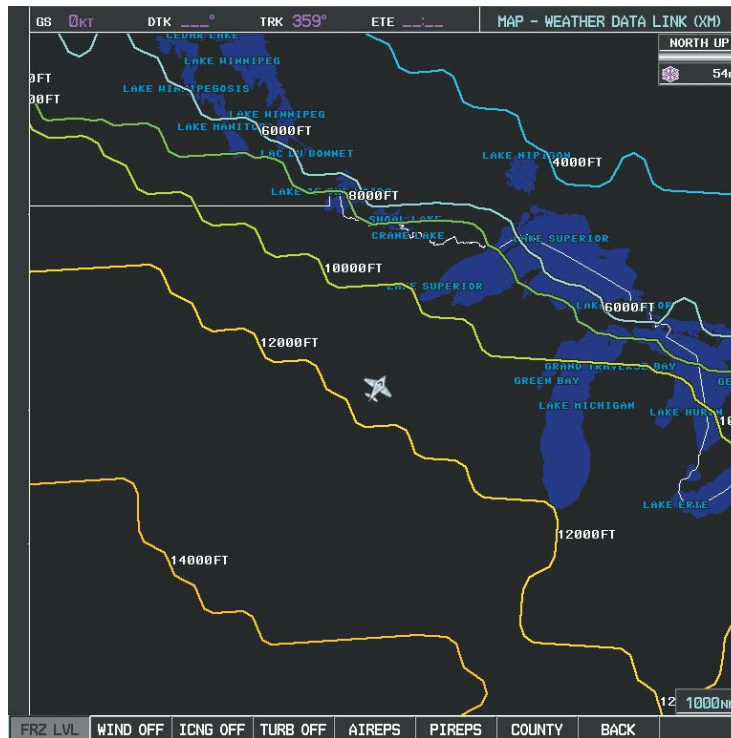

Figure 6-29 Freeze Level Data

Displaying Freezing Level information:

- 1) Select the Weather Data Link (XM) Page with the **FMS** Knob.
- 2) Select the **MORE WX** Softkey.
- 3) Select the **FRZ LVL** Softkey.

To display the Freezing Level legend (Figure 6-30), select the **LEGEND** Softkey when Freezing Level data is selected to be displayed.



Figure 6-30 Freezing Level Legend

WINDS ALOFT

Winds Aloft data (Figure 6-31) shows the forecast wind speed and direction at the surface and at selected altitudes. Altitude can be displayed in 3000-foot increments up to 42,000 feet MSL.

Displaying Winds Aloft data:

- 1) Select the Weather Data Link (XM) Page with the **FMS** Knob.
- 2) Select the **MORE WX** Softkey.
- 3) Select the **WIND** Softkey.
- 4) Select the desired altitude level: SFC (surface) up to 42,000 feet. Select the **NEXT** or **PREV** Softkey to cycle through the altitude softkeys. The **WIND** Softkey label changes to reflect the altitude selected.

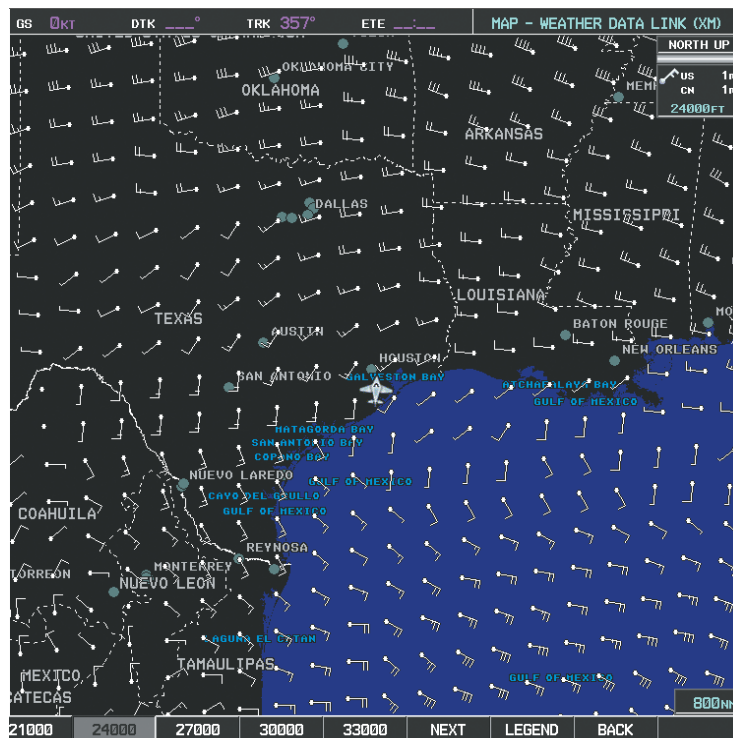

Figure 6-31 Winds Aloft at 24,000 Feet

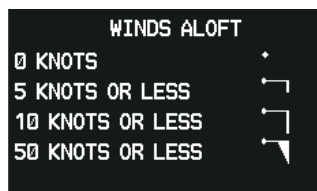

Figure 6-32 Winds Aloft Data with Legend

Headwind and tailwind components aloft are available inside the Profile View on the Navigation Map Page (Figure 6-33). The displayed components are relative to current aircraft altitude and track, but not to aircraft speed.

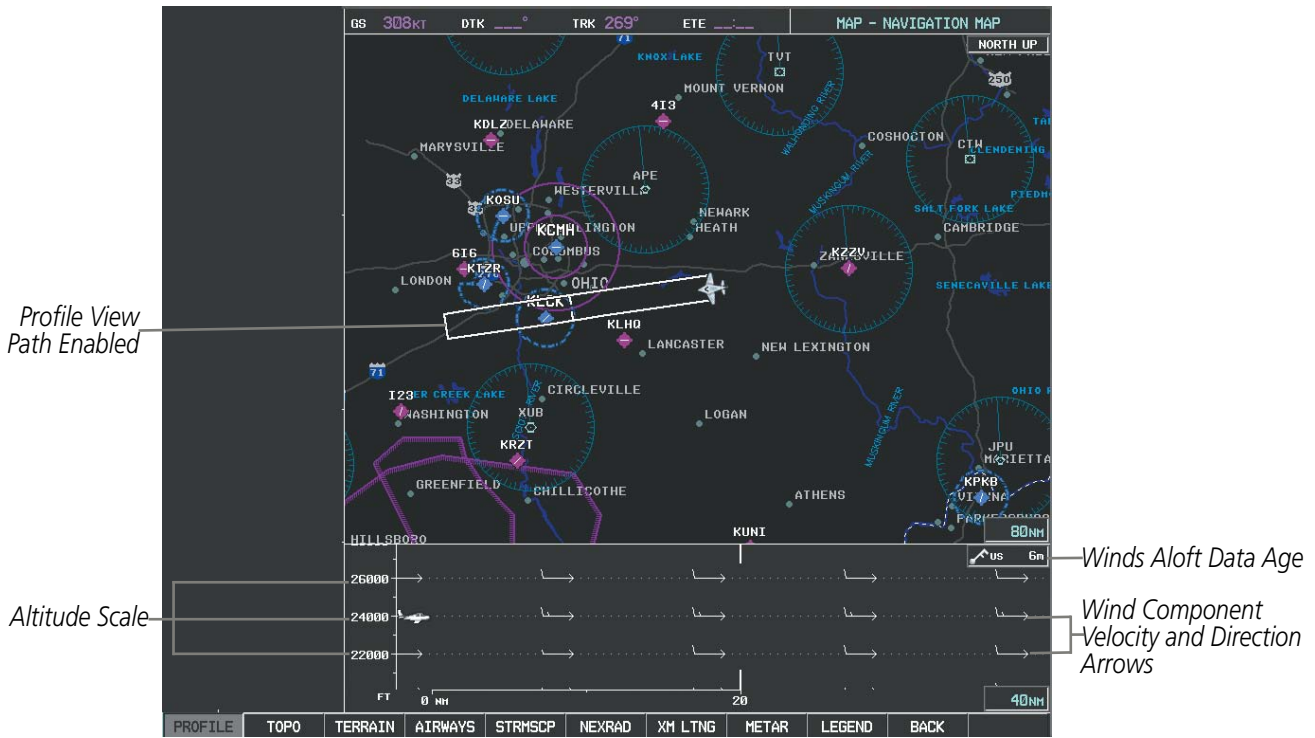

Figure 6-33 Navigation Map Page with Winds Aloft Data on Profile View

Arrows pointing to the left indicate headwind components; tailwind component arrows point to the right, as shown in Table 6-4.







Headwind Symbol	Tailwind Symbol	Headwind/Tailwind Component
None	None	Less than 5 knots
		5 knots
		10 knots
		50 knots

Table 6-4 Profile View Headwind/Tailwind Component Symbols

Showing/Hiding Profile View (containing winds aloft data)

- 1) Select the Navigation Map Page.
- 2) Select the **PROFILE** Softkey.

Or:

- 1) Press the **MENU** Key.

- 2) Turn the large FMS Knob to highlight 'Show Profile View' or 'Hide Profile View' (choice dependent on current state) and press the **ENT** Key.

Winds Aloft data inside the Profile View is enabled by default when the Profile View is displayed on the Navigation Map Page. This behavior can be changed on the Navigation Map Page.

Enabling/disabling winds aloft data display in Profile View:

- 1) Select the Navigation Map Page.
- 2) Press the **MENU** Key.
- 3) With Map Setup highlighted, press the **ENT** Key (Figure 6-34).
- 4) Turn the small **FMS** Knob to select the Profile Group and press the **ENT** Key (Figure 6-35).
- 5) Turn the large **FMS** Knob to select 'Profile Winds' (Figure 6-36).
- 6) Turn the small **FMS** Knob to select 'On' or 'Off'.
- 7) Press the **FMS** Knob or **CLR** Key to return to the Navigation Map Page with the changed settings.

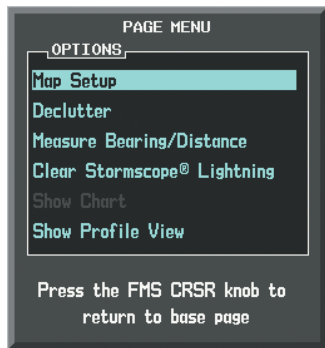

Figure 6-34 Navigation Map Page Menu



Figure 6-36 Navigation Map Page Setup Menu, Weather Group



Figure 6-35 Navigation Map Page Setup Menu

To display the Winds Aloft legend (Figure 6-37), select the **LEGEND** Softkey when Winds Aloft is selected for display.

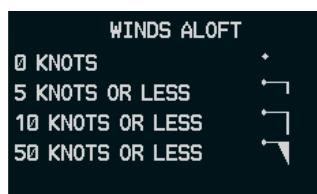

Figure 6-37 Winds Aloft Data with Legend

COUNTY WARNINGS

County data (Figure 6-38) provides specific public awareness and protection weather warnings from the National Weather Service (NWS). This can include information on severe thunderstorms, tornadoes, and flood conditions.



Figure 6-38 County Warnings

Displaying County Warning information:

- 1) Select the Weather Data Link (XM) Page with the **FMS** Knob.
- 2) Select the **MORE WX** Softkey.
- 3) Select the **COUNTY** Softkey.

To display the County Warnings legend (Figure 6-39), select the **LEGEND** Softkey when County Warnings are selected to be displayed.

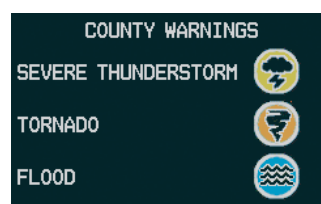

Figure 6-39 County Warnings Legend

CYCLONE

The Cyclone weather product (Figure 6-40) shows the current location of cyclones (hurricanes), tropical storms, and their projected tracks.

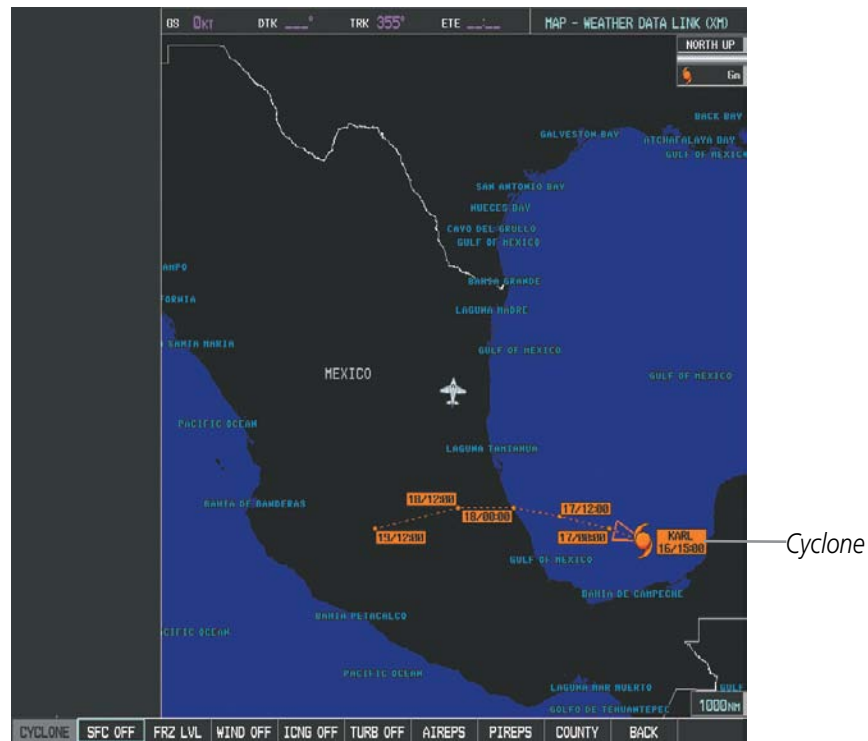

Figure 6-40 Cyclone Data Selected for Display

Displaying cyclone (hurricane) track information:

- 1) Select the Weather Data Link (XM) Page with the **FMS** Knob.
- 2) Select the **MORE WX** Softkey.
- 3) Select the **CYCLONE** Softkey.

To display the Cyclone legend (Figure 6-41), select the **LEGEND** Softkey when Cyclones are selected to be displayed.

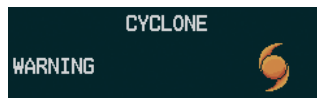

Figure 6-41 Cyclone Legend

ICING (CIP & SLD)

Current Icing Product (CIP) data (Figure 6-42) shows a graphical view of the current icing environment. Icing severity is displayed in four categories: light, moderate, severe, and extreme (not specific to aircraft type). The CIP product is not a forecast, but a presentation of the current conditions at the time of the analysis.

Supercooled Large Droplet (SLD) icing conditions are characterized by the presence of relatively large, super cooled water droplets indicative of freezing drizzle and freezing rain aloft. SLD threat areas are depicted as magenta dots over the CIP colors.

Displaying Icing data:

- 1) Select the Weather Data Link (XM) Page.
- 2) Select the **MORE WX** Softkey.
- 3) Select the **ICNG** Softkey.
- 4) Select the desired altitude level: 1,000 feet up to 30,000 feet. Select the **NEXT** or **PREV** Softkey to cycle through the altitude softkeys. The **ICNG** Softkey label changes to reflect the altitude selected.

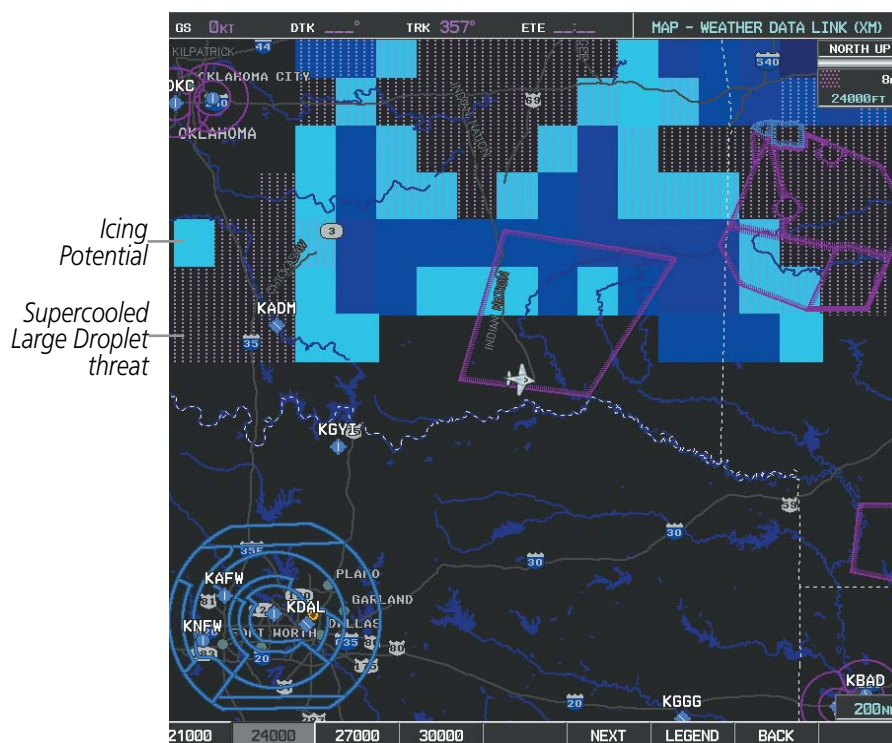

Figure 6-42 Icing Data at 24,000 Feet

To display the Icing Potential legend (Figure 6-43), select the **LEGEND** Softkey when Icing is selected for display.

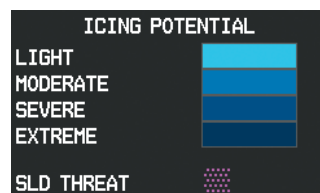

Figure 6-43 Icing Potential Legend

TURBULENCE

Turbulence data (Figure 6-44) identifies the potential for erratic movement of high-altitude air mass associated winds. Turbulence is classified as light, moderate, severe or extreme, at altitudes between 21,000 and 45,000 feet. Turbulence data is intended to supplement AIRMETs and SIGMETs.

Displaying Turbulence data:

- 1) Select the Weather Data Link (XM) Page.
- 2) Select the **MORE WX** Softkey.
- 3) Select the **TURB** Softkey.
- 4) Select the desired altitude level: 21,000 feet up to 45,000 feet. Select the **NEXT** or **PREV** Softkey to cycle through the altitude softkeys. The **TURB** Softkey label changes to reflect the altitude selected.

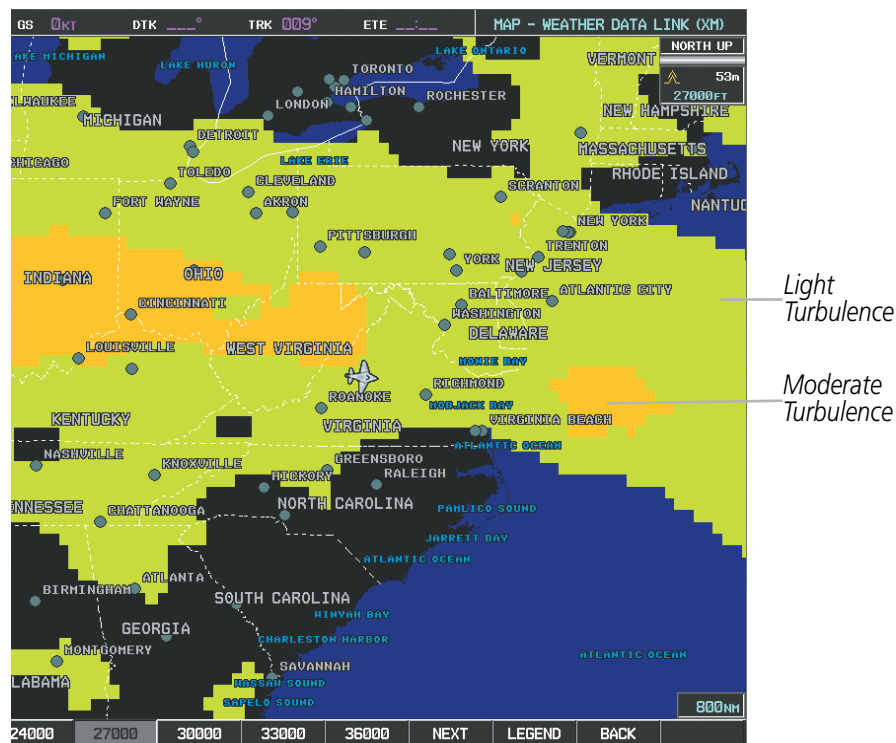

Figure 6-44 Turbulence Data at 27,000 Feet

To display the Turbulence legend (Figure 6-45), select the **LEGEND** Softkey when Turbulence is selected for display.

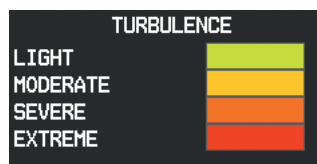

Figure 6-45 Turbulence Legend

PIREPS AND AIREPS

Pilot Weather Reports (PIREPs) (Figure 6-46) provide timely weather information for a particular route of flight. When significant weather conditions are reported or forecast, Air Traffic Control (ATC) facilities are required to solicit PIREPs. A PIREP may contain unforecast adverse weather conditions, such as low in-flight visibility, icing conditions, wind shear, and turbulence. PIREPs are issued as either Routine (UA) or Urgent (UUA).

Another type of PIREP is an Air Report (AIREP). AIREPs are used almost exclusively by commercial airlines.

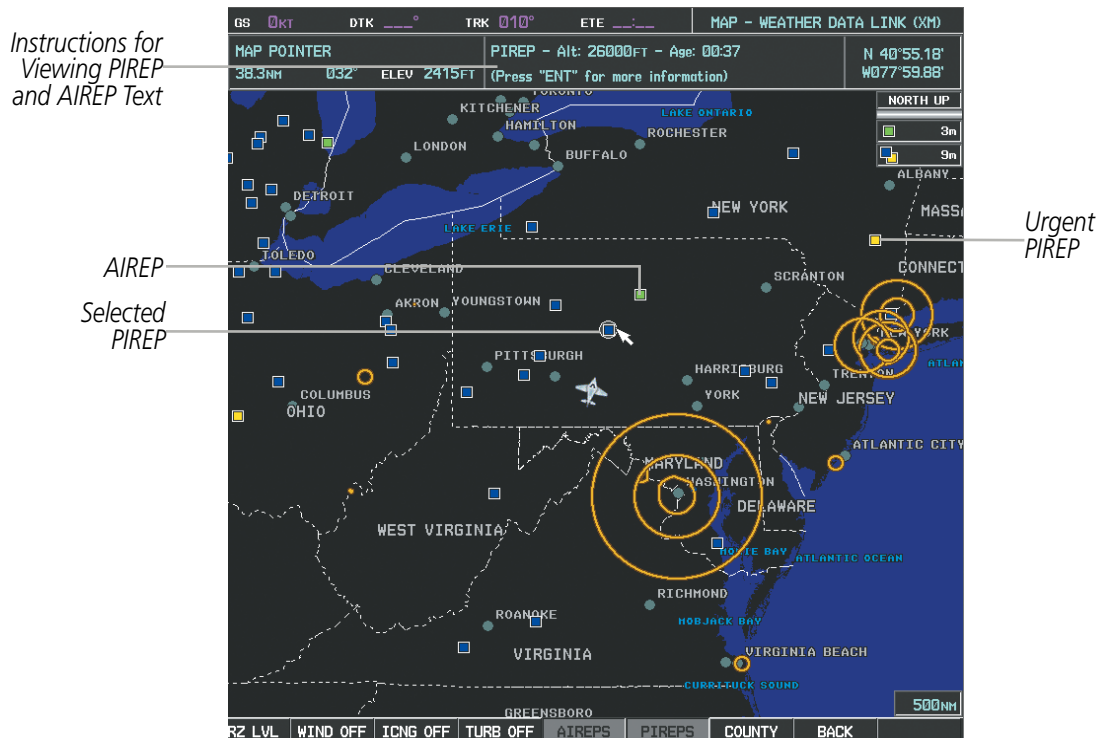

Figure 6-46 AIREPs and PIREPs on the Weather Data Link Page

Displaying PIREP and AIREP text:

- 1) Select the Weather Data Link (XM) Page.
- 2) Select the **MORE WX** Softkey.
- 3) Select the **AIREPS** or **PIREPS** Softkey.
- 4) Press the **RANGE** Knob and pan to the desired weather report. A gray circle will appear around the weather report when it is selected.
- 5) Press the **ENT** Key. The Weather Information Page is shown with PIREP or AIREP text. The data is first displayed in a decoded fashion, then as raw text.
- 6) Use the **FMS** Knob or the **ENT** Key to scroll through the PIREP or AIREP text.
- 7) Press the **FMS** Knob or the **CLR** Key to return to the Weather Data Link Page.

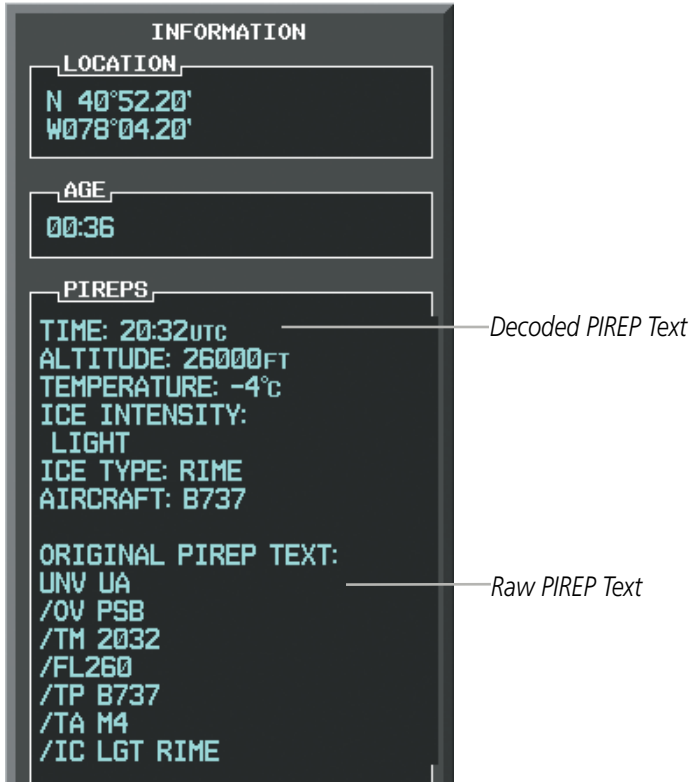

Figure 6-47 PIREP Text on the Weather Data Link Page

To display the PIREP or AIREP legend (Figure 6-48), select the **LEGEND** Softkey when PIREPs or AIREPs are selected for display.

The PIREP color is determined by the type (routine or urgent).



Figure 6-48 AIREPs & PIREPs Legend

TFRS

The FAA issues Temporary Flight Restrictions (TFRs) to designate areas where flight is restricted. TFRs are issued to restrict flight for a variety of reasons including national security, law enforcement, firefighting, natural disasters, airshows, and large sporting events. TFRs may be issued at any time, and TFR data displayed on the G1000 is only intended to supplement official TFR information obtained from Flight Service Stations (FSS), and air traffic control.

The age of TFR data is not shown; however, if TFR data is not available or has expired, the system displays 'TFR N/A' in the upper-left corner of maps on which TFRs can be displayed.

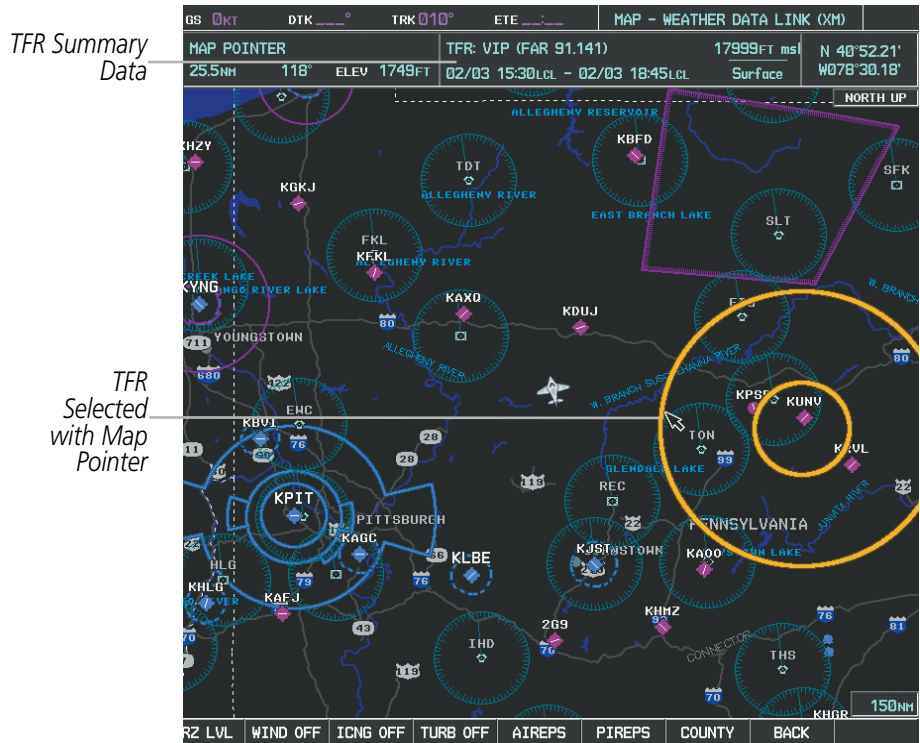

Figure 6-49 TFR Data on the Weather Data Link (XM) Page

Displaying TFR Data:

- 1) Select the Weather Data Link (XM) Page or Navigation Map Page.
- 2) Press the **RANGE** Knob and pan the map pointer over a TFR to highlight it. The system displays TFR summary information above the map.
- 3) Press the **ENT** Key. The system displays a pop-up menu.
- 4) If necessary, turn the **FMS** Knob to select 'Review Airspaces' and press the **ENT** Key. The system displays the TFR Information window.
- 5) Press the **FMS** Knob or the **CLR** Key to remove the TFR Information window.

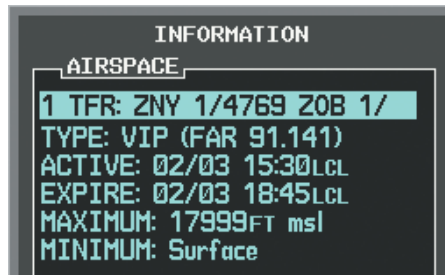

Figure 6-50 Full Text for Selected TFR

The setup menus for the Navigation Map Page control the map range settings above which TFR data is decluttered from the display. If a map range larger than the TFR product map range setting is selected, the TFR product data is removed from the map.

Maps other than the Navigation Map Page use settings based on those selected for the Navigation Map Page.

Setting up and customizing TFR data for maps on which TFR data can be displayed:

- 1) Select the Navigation Map Page.
- 2) Press the **MENU** Key.
- 3) With Map Setup highlighted, press the **ENT** Key (Figure 6-51).
- 4) Turn the small **FMS** Knob to select the Aviation Group and press the **ENT** Key (Figure 6-52).
- 5) Turn the large **FMS** Knob to scroll to the TFR product range setting (Figure 6-53).
- 6) Turn the small **FMS** Knob to scroll through options (Off, range settings).
- 7) Press the **ENT** Key to select an option.
- 8) Press the **FMS** Knob or **CLR** Key to return to the Navigation Map Page with the changed settings.

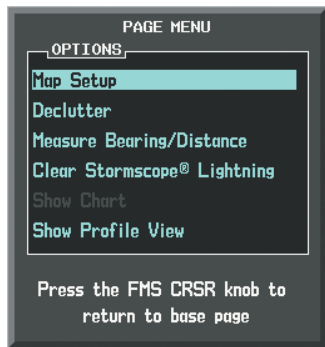

Figure 6-51 Navigation Map Page Menu



Figure 6-52 Navigation Map Page Setup Menu

	TEXT	RNG
ACTIVE FPL		2000NM
ACTIVE FPL WPT	Med	2000NM
LARGE APT	Lrg	200NM
MEDIUM APT	Med	150NM
SMALL APT	Med	50NM
SAFETAXI		3NM
RWY EXTENSION		Off
INT WAYPOINT	Med	15NM
NDB WAYPOINT	Med	15NM
VOR WAYPOINT	Med	150NM
CLASS B/TMA		200NM
CLASS C/TCA		200NM
CLASS D		150NM
RESTRICTED		200NM
MOA (MILITARY)		200NM
OTHER/ADIZ		200NM
TFR		Off

Figure 6-53 Navigation Map Page Setup Menu, Weather Group

6.2 GFDS WORLDWIDE WEATHER



NOTE: Garmin Flight Data Services (GFDS) Worldwide Weather provides information for avoiding hazardous weather. Do not use GFDS weather information to penetrate hazardous weather.



NOTE: Availability of specific GFDS weather products varies by region. Refer to fly.garmin.com/fly-garmin/gfds-weather for GFDS product coverage information.

Garmin Flight Data Services (GFDS) provides Worldwide Weather reception capabilities to the G1000 through the optional GSR 56 Iridium satellite datalink. Graphical weather information and associated text are displayed on the Multi Function Display (MFD) and the Primary Flight Display (PFD) Inset Map.

The system provides GFDS weather data after the pilot initiates either a manual or automatic GFDS data request on the Weather Data Link (GFDS) Page on the MFD.

In order to receive GFDS Worldwide Weather data, an account must first be established with Garmin Flight Data Services. Refer to Section 8.10, Satellite Telephone & SMS Messaging Service, for more information.

REGISTERING THE SYSTEM FOR GARMIN FLIGHT DATA SERVICES

When an account is established, Garmin Flight Data services provides an Access Code which must be entered on the G1000 in order to complete the registration process.

Registering the system to receive GFDS Weather:

- 1) With the aircraft outside and having a clear view of the sky, turn the large **FMS** Knob on the MFD to select the MAP page group.
- 2) Turn the small **FMS** Knob to select the MAP-WEATHER DATA LINK (GFDS or XM) Page. If 'XM' is displayed in the page title, it will be necessary to change the datalink source to GFDS before continuing. Refer to 'Viewing the Weather Data Link (GFDS) Page' procedure to change the datalink source to GFDS prior to registration.
- 3) If the system displays the 'Garmin Flight Data Service Registration' window, proceed to step 7. Otherwise, press the **MENU** Key. The Page Menu window is now displayed as seen in Figure 6-54.



Figure 6-54 Select Register With GFDS

- 5) Turn the large **FMS** Knob to select 'Register With GFDS' in the menu list.
- 6) Press the **ENT** Key. The Garmin Flight Data Service Registration window is displayed as shown in Figure 6-55.

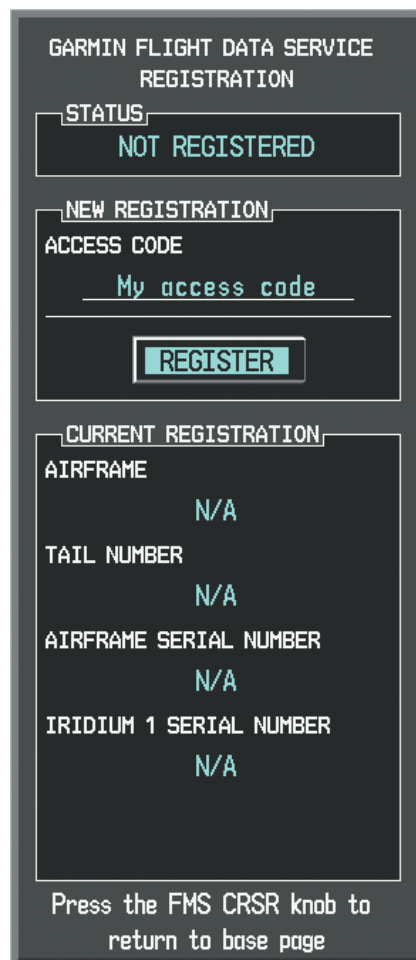

Figure 6-55 Enter Access Code

- 7) Enter the access code provided by Garmin Flight Data Services in the ACCESS CODE field.
- 8) Press the **ENT** Key. 'REGISTER' will now be highlighted as in Figure 6-55.
- 9) Press the **ENT** Key. The system will contact Garmin Flight Data Services. System registration is complete when 'REGISTERED' is displayed in the STATUS field.

ACCESSING GFDS WORLDWIDE WEATHER PRODUCTS

The principal map for viewing GFDS Weather data is the Weather Data Link (GFDS) Page in the Map Page Group (Figure 6-56). This is the only map display capable of showing information for all available GFDS Worldwide Weather products. No weather data is displayed until the first GFDS Weather Data Request is made.

Viewing the Weather Data Link (GFDS) Page:

- 1) Turn the large **FMS** Knob to select the Map Page Group.
- 2) Turn the small **FMS** Knob to select the Weather Data Link (GFDS or XM) Page. If the page title contains 'XM', continue with the procedure in order change the weather datalink source to GFDS.
- 3) Press the **MENU** Key.
- 4) Turn the small **FMS** Knob to select 'Display GFDS Weather' and press the **ENT** Key. The page title displays 'Weather Data Link (GFDS)' to indicate GFDS is the selected weather datalink source.

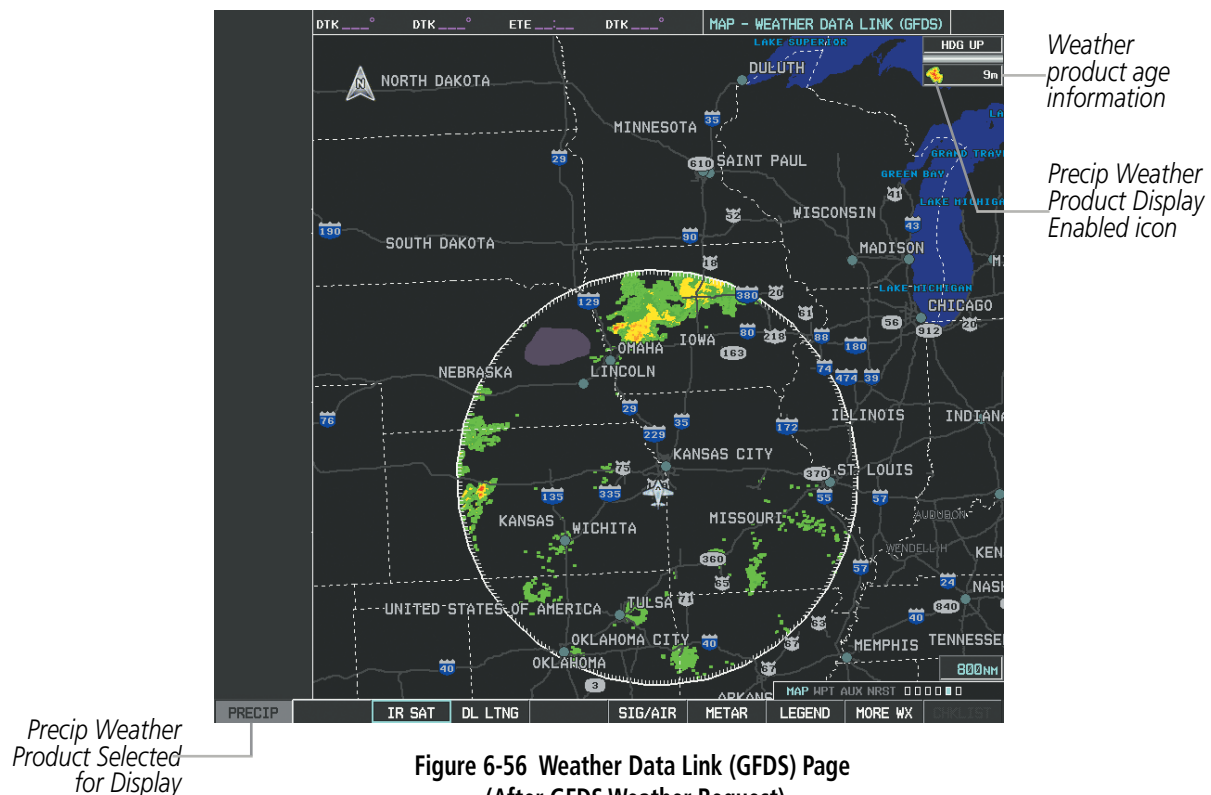

When a weather product is selected for display on the Weather Data Link (GFDS) Page, a box containing a symbol for the product and its age (in minutes) are shown in the upper right (Figure 6-56). If weather data has







not been requested yet or is not available, 'N/A' is shown next to the product symbol instead of age. The age of the weather product is based on the time difference between when the data was assembled on the ground and the current GPS time. Weather products are updated continuously or refreshed at specific intervals (defined in the **Refresh Rate** column in Table 6-5).

If for any reason, a weather product is not refreshed within the defined **Expiration Time** intervals (see Table 6-5), the data is considered expired and is removed from the display. The age of the expired product is replaced by dashes. If more than half of the expiration time has elapsed, the color of the product age changes to yellow.

Table 6-5 shows the GFDS weather product symbols, the expiration time and the refresh rates. The refresh rate represents the interval at which the GFDS servers make available the most current known weather data. It does not necessarily represent the rate at which new content is received from weather sources.



NOTE: *The availability of specific weather products varies from region to region. This Pilot's Guide shows all weather products, regardless of availability in a specific area.*

GFDS Weather Product	Symbol	Expiration Time (Minutes)	Refresh Rate (Minutes)
Radar Precipitation (PRECIP)		30	U.S.: 3* Canada: 3** Europe: 15 Australia: 15^
Infrared Satellite (IR SAT)		60	30
Datalink Lightning (DL LTNG)		30	Continuous
SIGMETs/AIRMETs (SIG/AIR)		60	Continuous
Meteorological Aerodrome Report (METARs)		90	Continuous
Winds Aloft (WIND)		60	Continuous
Pilot Weather Report (PIREPs)		90	Continuous
Temporary Flight Restrictions (TFRs)	no product image	60	Continuous
Terminal Aerodrome Reports (TAFs)	no product image	60	Continuous

* The composite precipitation image is updated every 3 minutes, but individual radar sites may take between 3 and 10 minutes to provide new data.

† Canadian radar precipitation data provided by Environment Canada.

^ Australian radar precipitation data provided by the Australian Bureau of Meteorology.

Table 6-5 GFDS Weather Product Symbols and Data Timing

Table 6-6 shows which GFDS Weather products can be displayed (indicated with a '+' symbol) on specific G1000 maps.

GFDS Weather Product	PFD Inset Map	Navigation Map Page	Weather Data Link (GFDS) Page	Weather Information Page	AUX - Trip Planning Page	System Page Group	Nearest Page Group	Flight Plan Pages
Precipitation (PRECIP)	+	+	+		+	+	+	+
Infrared Satellite (IR SAT)			+					
Datalink Lightning (LTNG)	+	+	+		+	+	+	+
SIGMETs/AIRMETs (SIG/AIR)			+					
METARs	+	+	+	+	+	+	+	+
Winds Aloft (WIND)		+*	+					
PIREPs			+	+				
Radar Coverage	+	+	+			+	+	+
TFRs	+	+	+	+	+	+	+	+
TAFs			+	+				

* Winds Aloft data on Navigation Map Page displayed inside Profile View when enabled.

Table 6-6 GFDS Weather Product Display Maps

Softkeys control the display of weather information on most MFD pages and the PFD Inset Map (Figure 6-57 shows the weather product softkeys for the Weather Data Link (GFDS) Page). When a weather product is selected for display, the corresponding softkey label changes to gray to indicate the product display is enabled.

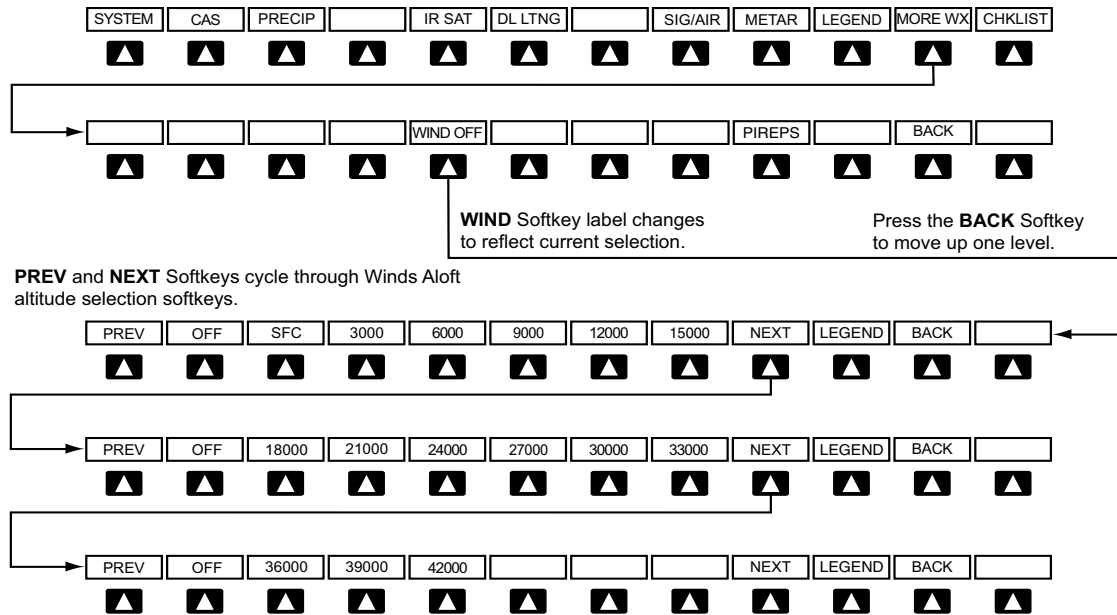

Figure 6-57 Weather Data Link (GFDS) Page Softkeys (MFD)

The setup menus for the Navigation Map Page and the Weather Data Link (GFDS) Page control the map range settings above which weather products data are decluttered from the display. If a map range larger than the weather product map range setting is selected, the weather product data is removed from the map. The menus also provide a means in addition to the softkeys for enabling/disabling display of weather products.

Setting up and customizing the Weather Data Link (GFDS) Page:

- 1) Select the Weather Data Link (GFDS) Page.
- 2) Press the **MENU** Key.
- 3) With 'Weather Setup' highlighted, press the **ENT** Key (Figure 6-58).
- 4) Turn the small **FMS** Knob to select 'Product Group 1' or 'Product Group 2', and press the **ENT** Key (Figure 6-59).
- 5) Turn the large **FMS** Knob or press the **ENT** Key to scroll through product selections.
- 6) Turn the small **FMS** Knob to scroll through options for each product (ON/OFF, range settings, etc.).
- 7) Press the **ENT** Key to select an option.
- 8) Press the **FMS** Knob or **CLR** Key to return to the Weather Data Link (GFDS) Page with the changed settings.



Figure 6-58 Weather Data Link (GFDS) Page Menu



Figure 6-59 Weather Data Link (GFDS) Page Setup Menu

Restoring default Weather Data Link (GFDS) Page settings:

- 1) Select the Weather Data Link (GFDS) Page.
- 2) Press the **MENU** Key.
- 3) With 'Weather Setup' highlighted, press the **ENT** Key.
- 4) Press the **MENU** Key.
- 5) Highlight the desired default(s) to restore (all or for selection) and press **ENT** Key.

The G1000 supports dual datalink installation of both the GSR 56 for GFDS Worldwide Weather and the GDL69A for XM WX Satellite Weather. Only one set of datalink weather products (GFDS or XM WX) can be displayed at a time.

Switching between GFDS and XM WX datalink sources:

- 1) Turn the large **FMS** Knob on the MFD to select the MAP page group.
- 2) Turn the small **FMS** Knob to select the GFDS (or XM) Weather Data Link Page.
- 3) Press the **MENU** Key.
- 4) Turn the large **FMS** Knob to select 'Display GFDS Weather' or 'Display XM' Weather' (choice dependent on current weather source) and press the **ENT** Key.

If both GFDS and XM WX weather services are installed, customizing the display settings for the corresponding weather products shown in Table 6-7 will result in identical settings for both services.

XM WX Product	GFDS Worldwide Weather Product
Next-generation Radar (NEXRAD)	Precipitation (PRECIP)
Cloud Top (CLD TOP)	Infrared Satellite (IR SAT)
XM Lightning (XM LTNG)	GFDS Lightning (DL LTNG)
SIGMETs/AIRMETs (SIG/AIR)	SIGMETs/AIRMETs (SIG/AIR)
Meteorological Aerodrome Report (METARs)	Meteorological Aerodrome Report (METARs)
Winds Aloft (WIND)	Winds Aloft (WIND)
Pilot Weather Report (PIREPs)	Pilot Weather Report (PIREPs)

Table 6-7 Corresponding XM WX and GFDS Weather Products

Maps besides the Weather Data Link (GFDS) Page use settings based on those selected for the Navigation Map Page.

Setting up and customizing weather data for the Navigation Map Page:

- 1) Select the Navigation Map Page.
- 2) Press the **MENU** Key.
- 3) With 'Map Setup' highlighted, press the **ENT** Key (Figure 6-60).
- 4) Turn the small **FMS** Knob to select the 'Weather' Group and press the **ENT** Key (Figure 6-61).
- 5) Turn the large **FMS** Knob or press the **ENT** Key to scroll through product selections (Figure 6-62).
- 6) Turn the small **FMS** Knob to scroll through options for each product (ON/OFF, range settings).
- 7) Press the **ENT** Key to select an option.
- 8) Press the **FMS** Knob or **CLR** Key to return to the Navigation Map Page with the changed settings.

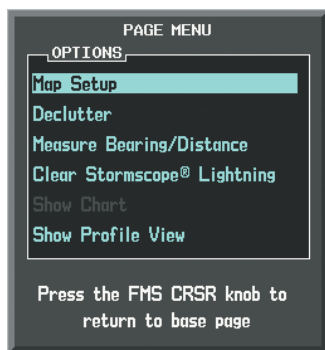

Figure 6-60 Navigation Map Page Menu



Figure 6-61 Navigation Map Page Setup Menu

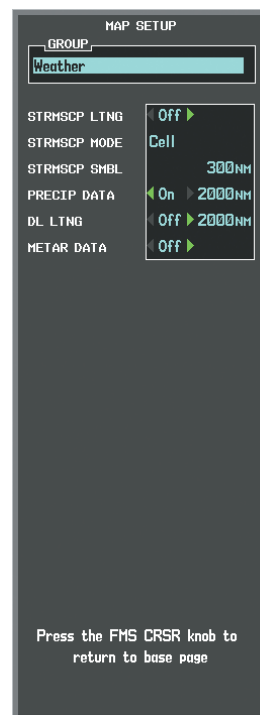

Figure 6-62 Navigation Map Page Setup Menu, Weather Group

Each active weather product has an associated legend which can be displayed on the Weather Data Link (GFDS) Page. If no weather product softkeys are selected, the **LEGEND** Softkey will be unavailable.

Viewing legends for displayed weather products

- 1) Select the Weather Data Link (GFDS) Page.
- 2) Press the **LEGEND** Softkey to display the legends for the displayed weather products.
 - Or:
 - a) Press the **MENU** Key.
 - b) Select 'Weather Legend' and press the **ENT** Key.
- 3) Turn the **FMS** Knob to scroll through the legends if more are available than fit in the window.
- 4) To remove the Legend Window, select the **LEGEND** Softkey, the **ENT** or the **CLR** Key, or press the **FMS** Knob.

When an GFDS weather product is enabled for display on the PFD Inset Map, the weather product information box (with the product icon and age) can be displayed inside the PFD Inset Map.

Viewing the weather product information box on the PFD Inset Map:

- 1) On the PFD, press the **INSET** Softkey.
- 2) Press the **WX LGND** Softkey.
- 3) To remove the weather product information box, press the **WX LGND** Softkey again or deselect all active GFDS weather products on the PFD Inset Map.

Additional information about the following can be displayed by panning over the display on the map:

- Infrared Satellite (IR SAT)
- SIGMETs
- AIRMETs
- METARs
- TFRs
- PIREPs

The map panning feature is enabled by pressing the **RANGE** Knob. The map range is adjusted by turning the **RANGE** Knob. If the map range is adjusted while panning is enabled, the map is re-centered on the Map Pointer.

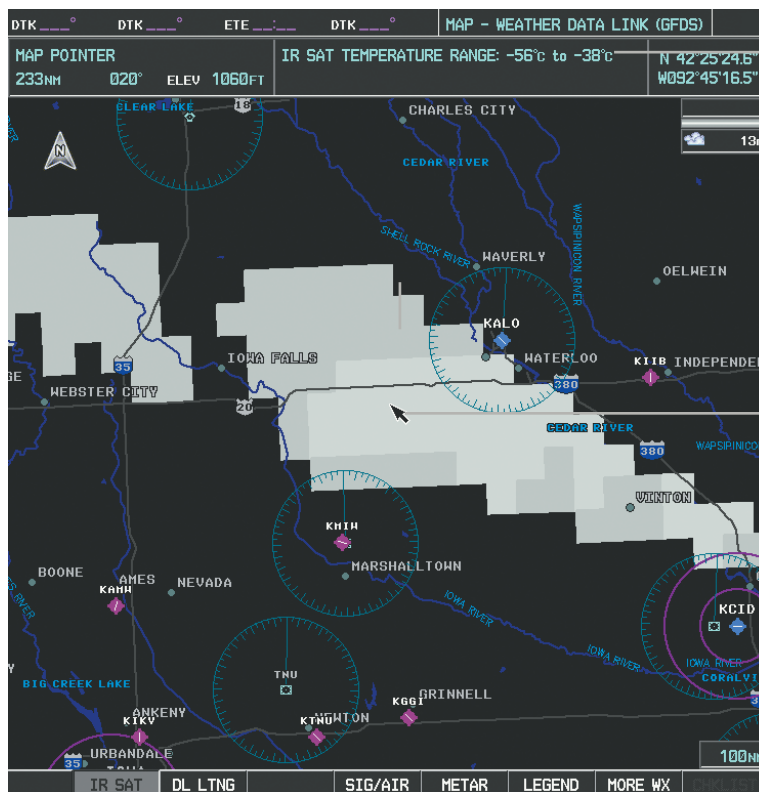

Additional Information on Infrared Satellite Data Selected with Map Pointer

Infrared Satellite Data Selected with Map Pointer

Figure 6-63 Panning on the GFDS Data Link Page

GFDS WEATHER DATA REQUESTS

The GFDS Data Request window provides the flight crew with the options to enable or disable the requested weather coverage area(s), choose automatic weather update intervals (if desired), and the ability to send or cancel weather data requests. The status of the GFDS data request process is also displayed.

Before a GFDS data request can occur, a valid request coverage area must be defined from which all currently available GFDS weather products will be retrieved. At a minimum, either the aircraft's present position or a waypoint (as part of a flight plan or entered directly in the 'WAYPOINT' coverage field) must be part of the request coverage area, otherwise the request status window will indicate 'INVALID COVERAGE AREA' and the system will not allow a request to occur.

It is not necessary for a destination (based on an active flight plan), a flight plan, or waypoint to be specified prior to enabling these coverage areas; however no weather data will be retrieved for these option(s) until a flight plan or waypoint is provided, respectively.

Requesting GFDS weather data manually:

- 1) Select the Weather Data Link (GFDS) Page.
- 2) Press the **MENU** Key.
- 3) With 'GFDS Data Request' highlighted, press the **ENT** Key (Figure 6-64).
- 4) Turn the large **FMS** Knob to highlight the desired coverage option(s) and press the **ENT** Key to check or uncheck one of more of the following coverage selections (Figures 6-65, 6-66):
 - **PRESENT POSITION** – Requests data based on current location.
 - **DESTINATION** – Requests data based on the active flight plan destination (Direct-To destinations excluded). See the Flight Management section for more information about entering and activating flight plans.
 - **FPL** – Requests data along an active flight plan, if one exists. Turn the small **FMS** Knob to select the desired flight plan look-ahead distance option (or choose 'REMAINING FPL' to request the remainder of the flight plan), then press the **ENT** Key.
 - **WAYPOINT** – Requests data based on a waypoint (which may be off-route). Turn the large and small **FMS** Knobs to enter a waypoint, then press the **ENT** Key.
- 5) Turn the large **FMS** Knob highlight to the 'DIAMETER / RTE WIDTH' (diameter/route width) distance field and turn the small **FMS** Knob to select the desired diameter and route width of the request, then press the **ENT** Key.
- 6) Turn the large **FMS** Knob until the 'SEND REQ' button is highlighted. Press the **ENT** Key to initiate the request immediately or press the **FMS** Knob to return to the Weather Data Link (GFDS) Page without requesting weather data.



Figure 6-64 Weather Data Link (GFDS) Page Menu

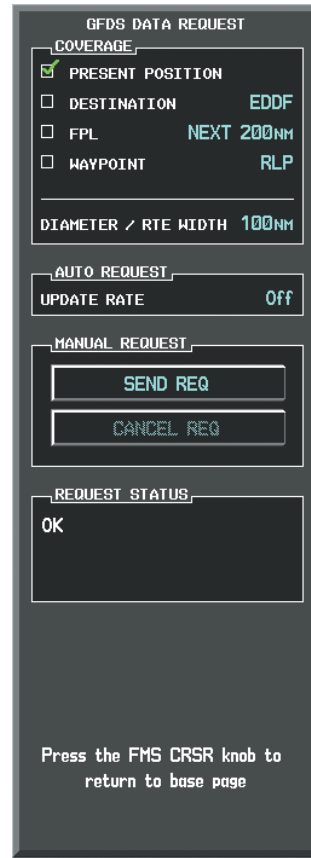

Figure 6-65 GFDS Data Request Window

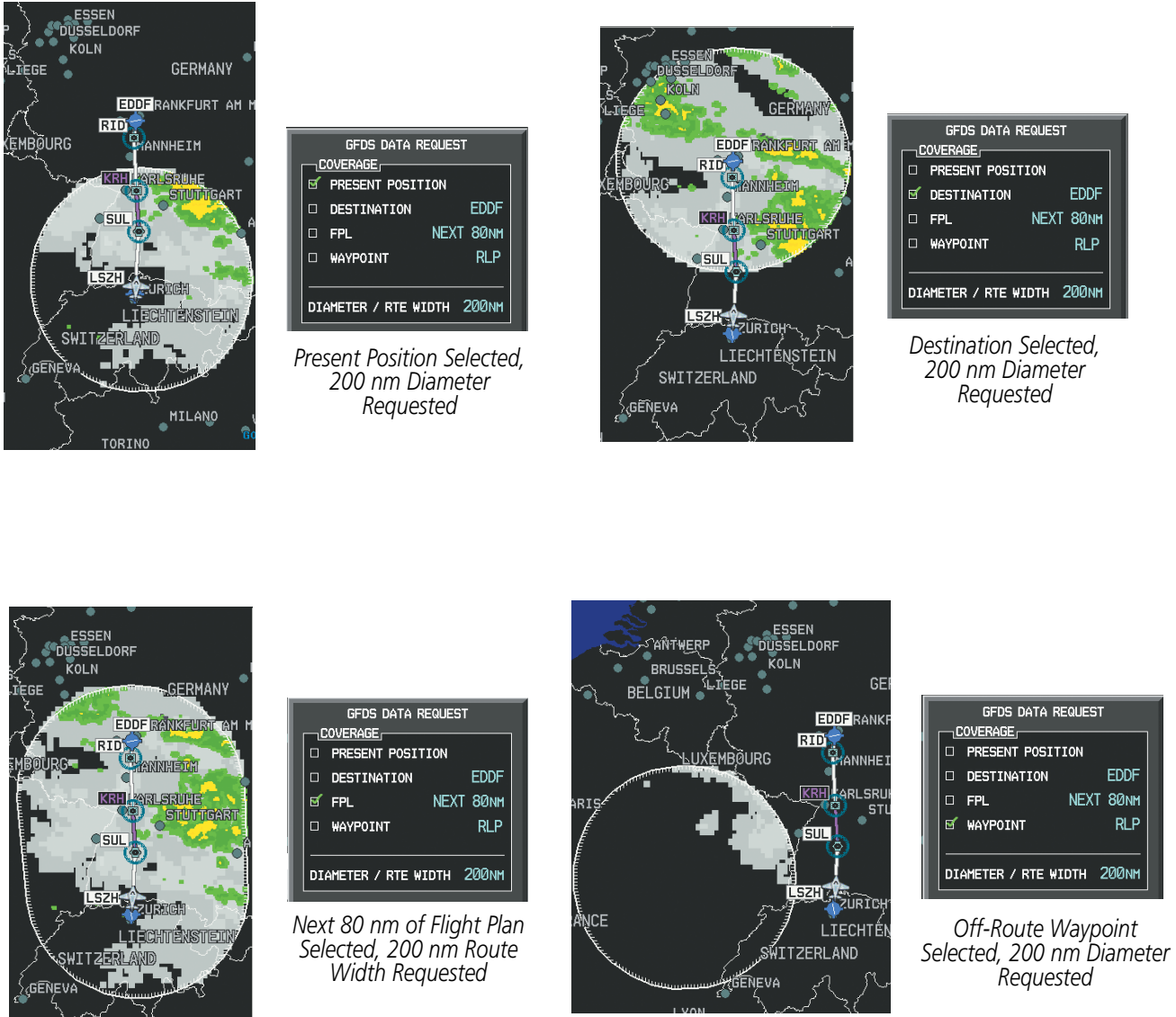

Figure 6-66 GFDS Weather Data Request Results with Precipitation and Infrared Satellite Displayed

During a GFDS Data Request, the Request Status box displays “Processing...” and the ‘CANCEL REQ’ button is highlighted. A countdown timer will display the estimated time remaining for the data request. If desired, the GFDS Data Request window may be closed while the data request is processing by pressing the **FMS** Knob; the data request will continue to process in the background. GFDS Data Requests typically take between 1 to 3 minutes to complete depending on the size of the selected weather coverage area and Iridium signal connection quality.

The G1000 retrieves all available Worldwide Weather products within the selected coverage area during an initial GFDS Data Request, regardless of which products (if any) are currently enabled for display. On subsequent requests, previously retrieved textual data (such as METARs and TAFS) is retained if it has not expired, while new textual weather data matching the current coverage area and all graphical weather data is downloaded during every data request.

At the completion of a successful weather data request, the request status window (if still open) will indicate 'OK'.

Canceling a GFDS Weather Data Request in Progress:

- 1) Select the Weather Data Link (GFDS) Page.
- 2) Press the **MENU** Key.
- 3) With 'GFDS Data Request' highlighted, press the **ENT** Key.
- 4) Turn the large **FMS** Knob to select 'CANCEL REQ' and press the **ENT** Key. The request status box indicates 'Request Cancelled'.
- 5) Press the **FMS** Knob to return to the GFDS Weather Datalink Page.

The pilot can schedule GFDS data requests to recur automatically. Auto requests remain enabled until the pilot disables them, or the G1000 power is cycled. The Request Status window will indicate a countdown timer until the next automatic data request occurs.



NOTE: *If automatic GFDS data requests were enabled prior to the system entering Reversionary Mode, the automatic weather data requests will continue in Reversionary Mode, however the GFDS Data Request window and its associated options will not be available.*

Enabling/disabling automatic GFDS Data Requests:

- 1) Select the Weather Data Link (GFDS) Page.
- 2) Press the **MENU** Key.
- 3) With 'GFDS Weather Request' highlighted, press the **ENT** Key.
- 4) Choose the desired weather coverage options.
- 5) Turn the large **FMS** Knob to select the 'UPDATE RATE' setting. Then turn the small **FMS** Knob to highlight the desired automatic update frequency (OFF, 5 Min, 10 Min, 15 Min, 20 Min, 25 Min, 30 Min, 45 Min, or 60 Min), then press the **ENT** Key.
- 6) The 'SEND REQ' button is highlighted and a countdown timer is displayed in the 'REQUEST STATUS' based on the currently selected update rate. Press the **ENT** Key to immediately send an immediate GFDS Data Request.

Or:

Press the **FMS** Knob to return to the Weather Data Link (GFDS) Page.

WORLDWIDE WEATHER PRODUCTS

PRECIPITATION



NOTE: Precipitation data cannot be displayed at the same time as terrain or Stormscope.

Precipitation (PRECIP) data is not real-time. The lapsed time between collection, processing, and dissemination of radar images can be significant and may not reflect the current radar synopsis. Due to the inherent delays and the relative age of the data, it should be used for long-range planning purposes only.

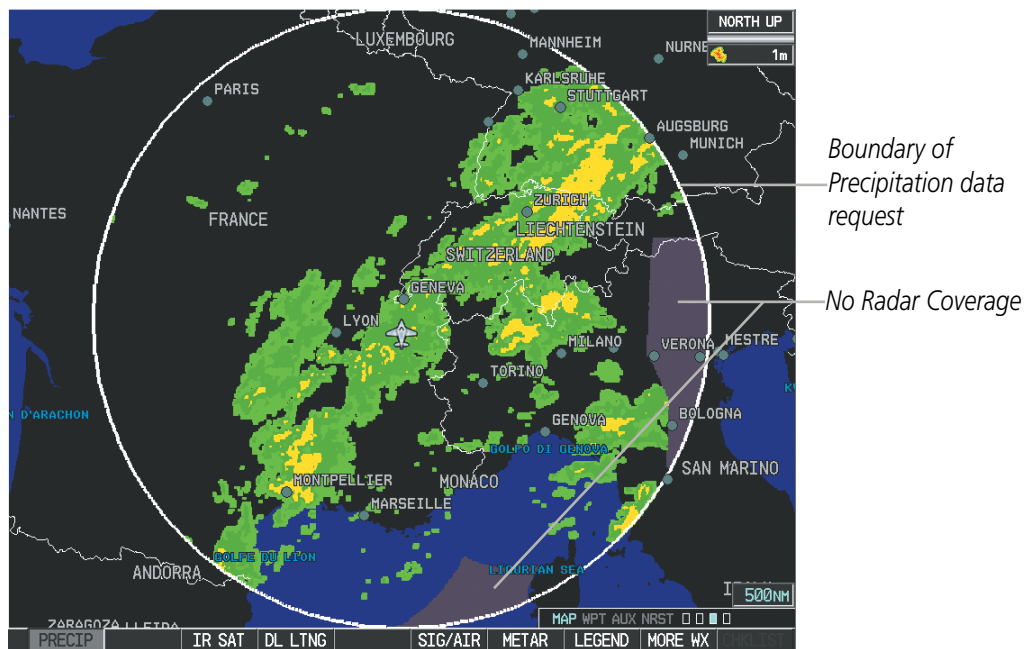

Figure 6-67 Precipitation Data on the Weather Data Link (GFDS) Page

Precipitation data can be displayed on the following maps:

- PFD Inset Map
- Navigation Map Page
- Weather Data Link Page
- Airport Information Page
- Trip Planning Page
- Nearest Pages
- Flight Plan Pages

Displaying Precipitation weather information:

- 1) Select the **MAP** Softkey (for the PFD Inset Map, select the **INSET** Softkey). This step is not necessary on the Weather Data Link (GFDS) Page.
- 2) Press the **PRECIP** Softkey.

Radar data shown represents highest level, composite reflectivity, of radar returns. The display of the information is color-coded to indicate the weather severity level. All weather product legends can be viewed on the Weather Data Link (GFDS) Page. For the Precipitation legend (Figure 6-68), select the **LEGEND** Softkey when Precipitation is selected for display.

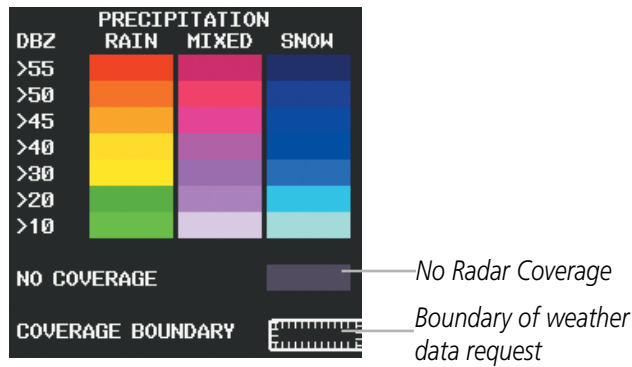

Figure 6-68 Precipitation Data Legend

The display of radar coverage is enabled active when Precipitation is selected for display. Areas where precipitation radar coverage is not currently available or is not being collected are indicated in gray shade of purple. A white boundary line depicting the selected coverage area of the GFDS weather data request encloses the precipitation data when this weather product is displayed.

REFLECTIVITY

Reflectivity is the amount of transmitted power returned to the radar receiver. Colors on the Precipitation display directly correlate to the level of detected reflectivity. Reflectivity as it relates to hazardous weather can be very complex.

The role of radar is essentially to detect moisture in the atmosphere. Simply put, certain types of weather reflect radar better than others. The intensity of a radar reflection is not necessarily an indication of the weather hazard level. For instance, wet hail returns a strong radar reflection, while dry hail does not. Both wet and dry hail can be extremely hazardous.

The different radar echo intensities are measured in decibels (dB) relative to reflectivity (Z). Weather radars measure the reflectivity ratio, or the energy reflected *back to* the radar receiver (designated by the letter Z). The value of Z increases as the returned signal strength increases.

PRECIPITATION LIMITATIONS

Radar images may have certain limitations:

- Radar composite reflectivity does not provide sufficient information to determine precipitation characteristics (wet hail vs. rain). For example, it is not possible to distinguish between wet snow, wet hail, and rain.
- The radar beam may overshoot precipitation occurring below the lowest antenna beam tilt angle (0.5°), causing no precipitation to be displayed. An individual radar site cannot depict high altitude storms at close ranges. It has no information about storms directly over the radar site.
- When zoomed in to a range of 30 nm, each square block on the display represents an area of four square kilometers.

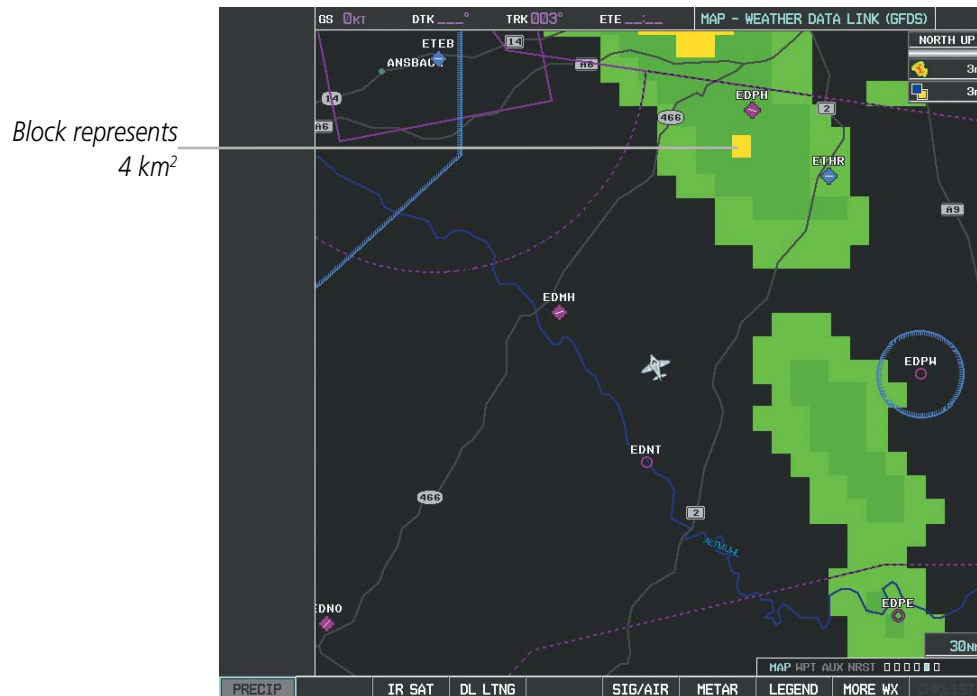

Figure 6-69 Precipitation Data - Zoomed

The following may cause abnormalities in displayed radar images:

- Ground clutter
- Strokes and spurious radar data
- Sun strokes (when the radar antenna points directly at the sun)
- Interference from buildings or mountains, which may cause shadows
- Metallic dust from military aircraft, which can cause alterations in radar scans

INFRARED SATELLITE

Infrared Satellite (IR SAT) data (Figure 6-70) depicts cloud top temperatures from satellite imagery. Brighter cloud top colors indicate cooler temperatures occurring at higher altitudes.

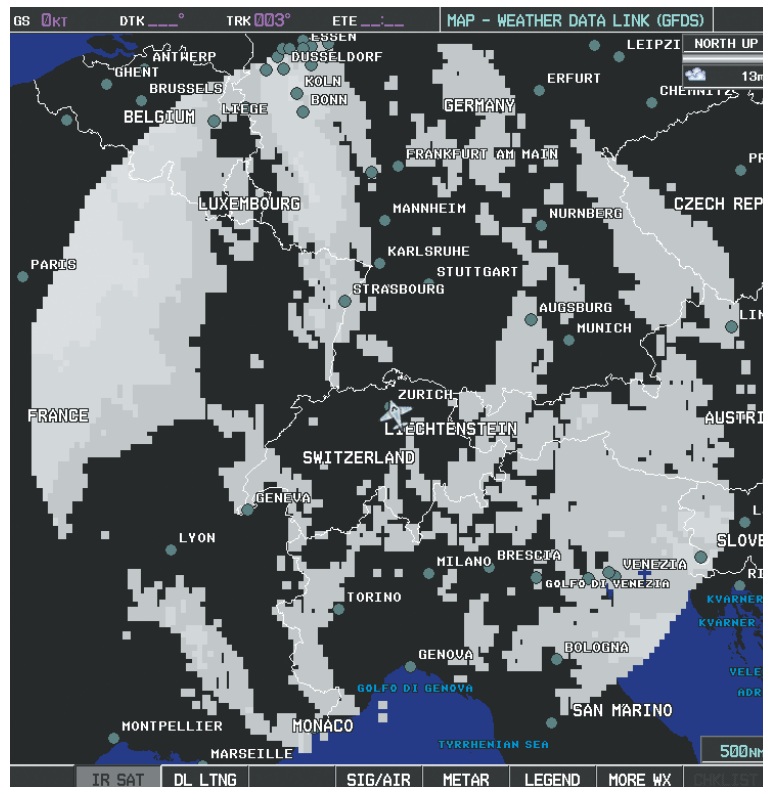

Figure 6-70 METAR Flags on the Weather Data Link Page

Displaying Cloud Tops information:

- 1) Select the Weather Data Link (GFDS) Page.
- 2) Press the **IR SAT** Softkey.

To display the Infrared Satellite legend (Figure 6-71), select the **LEGEND** Softkey when Infrared Satellite data is selected for display.



Figure 6-71 Infrared Satellite Legend

DATALINK LIGHTNING

Datalink Lightning (DL LTNG) data (Figure 6-72) shows the approximate location of cloud-to-ground lightning strikes. A strike icon represents a strike that has occurred within a two-kilometer region. Neither cloud-to-cloud nor the exact location of the lightning strike is displayed.

If the aircraft is also equipped with the L-3 WX-500 Stormscope®, only one lightning product may be enabled for display at a time.

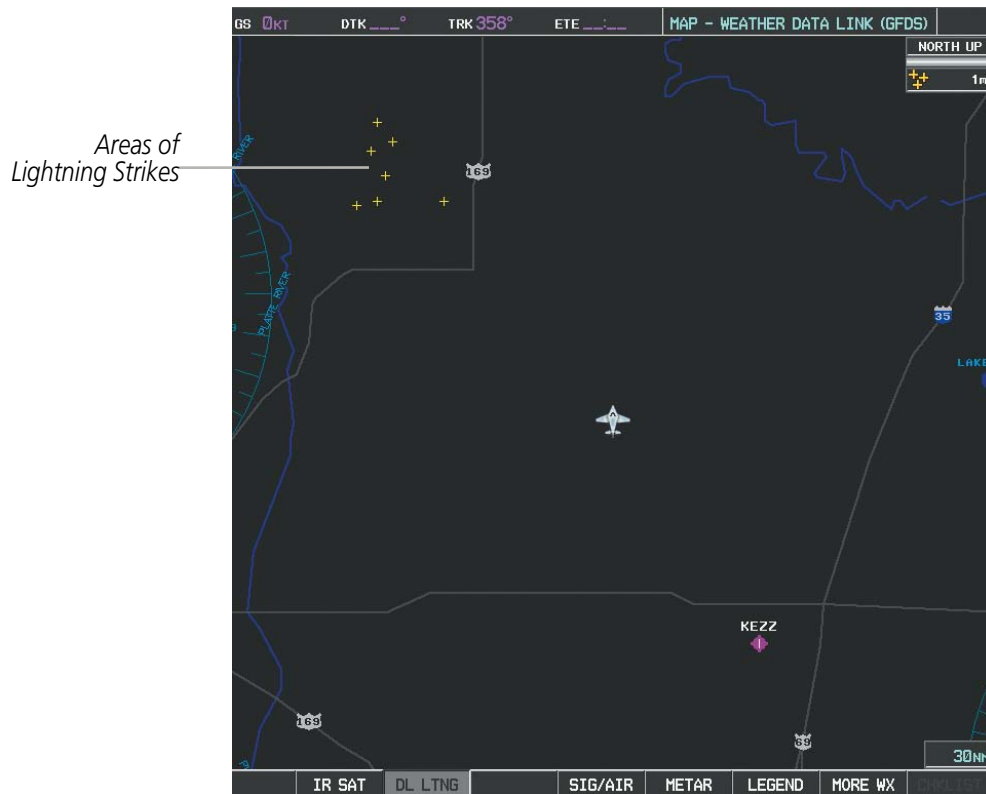

Figure 6-72 Datalink Lightning

Datalink Lightning data displayed on the following maps:

- PFD Inset Map
- Navigation Map Page
- Weather Data Link (GFDS) Page
- Trip Planning Page
- Nearest Pages
- Flight Plan Pages

Displaying Datalink Lightning information:

- 1) Press the **MAP** Softkey (for the PFD Inset Map, select the **INSET** Softkey). This step is not necessary on the Weather Data Link (GFDS) Page.
- 2) Press the **DL LTNG** Softkey.

To display the Datalink Lightning legend on the Weather Data Link (GFDS) Page (Figure 6-73), select the **LEGEND** Softkey when Datalink Lightning is selected for display.

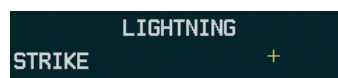

Figure 6-73 Datalink Lightning Legend

SIGMETS AND AIRMETS

SIGMETs (SIGnificant METeorological Information) and AIRMETs (AIRmen's METeorological Information) are issued for potentially hazardous weather. A Convective SIGMET is issued for hazardous convective weather such as severe or widespread thunderstorms. A localized SIGMET can be displayed when significant weather conditions are not widespread.

The entire SIGMET or AIRMET is displayed as long as any portion of it is issued within the coverage area of the GFDS data request.

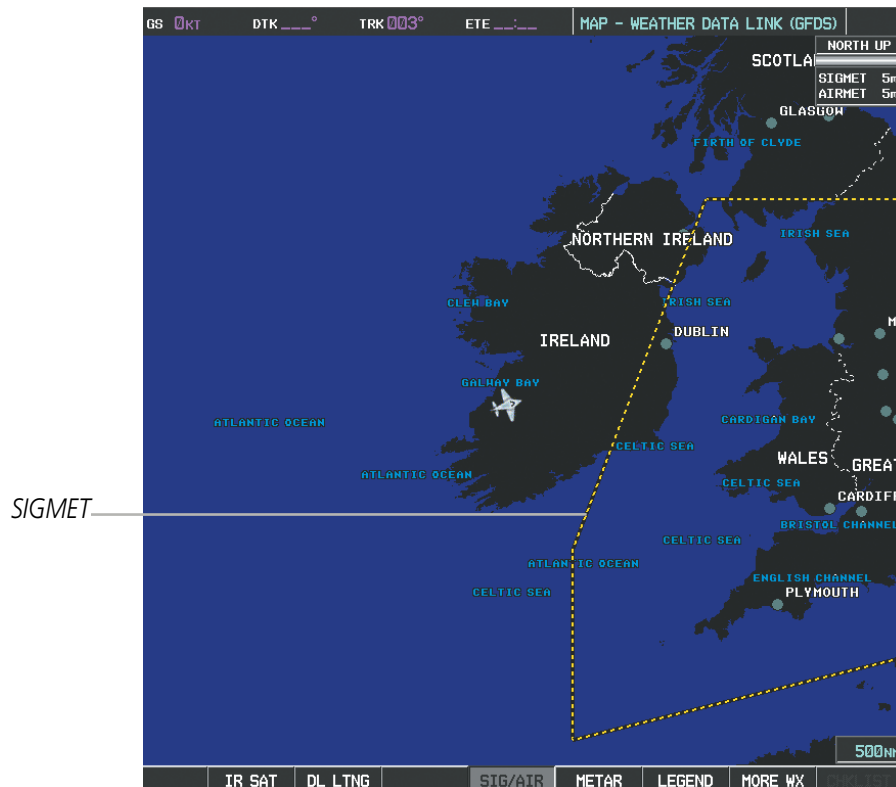

Figure 6-74 SIGMET/AIRMET Data

Displaying SIGMETs and AIRMETs:

- 1) Select the Weather Data Link (GFDS) Page.
- 2) Press the **SIG/AIR** Softkey.
- 3) To view the text of the SIGMET or AIRMET, press the **RANGE** Knob and move the Map Pointer over the icon.
- 4) Press the **ENT** key. Figure 6-75 shows sample SIGMET text.

To display the SIGMET and AIRMET legend (Figure 6-76), select the **LEGEND** Softkey when SIGMETs and AIRMETs are selected for display.

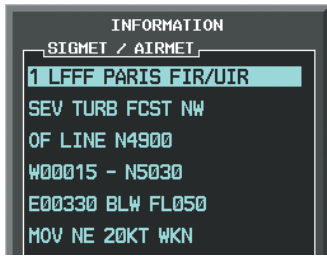

Figure 6-75 Sample SIGMET Text



Figure 6-76 SIGMET/AIRMET Legend

METARS AND TAFS



NOTE: METAR information is only displayed within the installed aviation database service area.

METARs (METeorological Aerodrome Reports) typically contain information about the temperature, dewpoint, wind, precipitation, cloud cover, cloud base heights, visibility, and barometric pressure at an airport or observation station. They can also contain information on precipitation amounts, lightning, and other critical data. METARs reflect hourly observations; non-routine updates include the code “SPECI” in the report. METARs are shown as colored flags at airports that provide them.

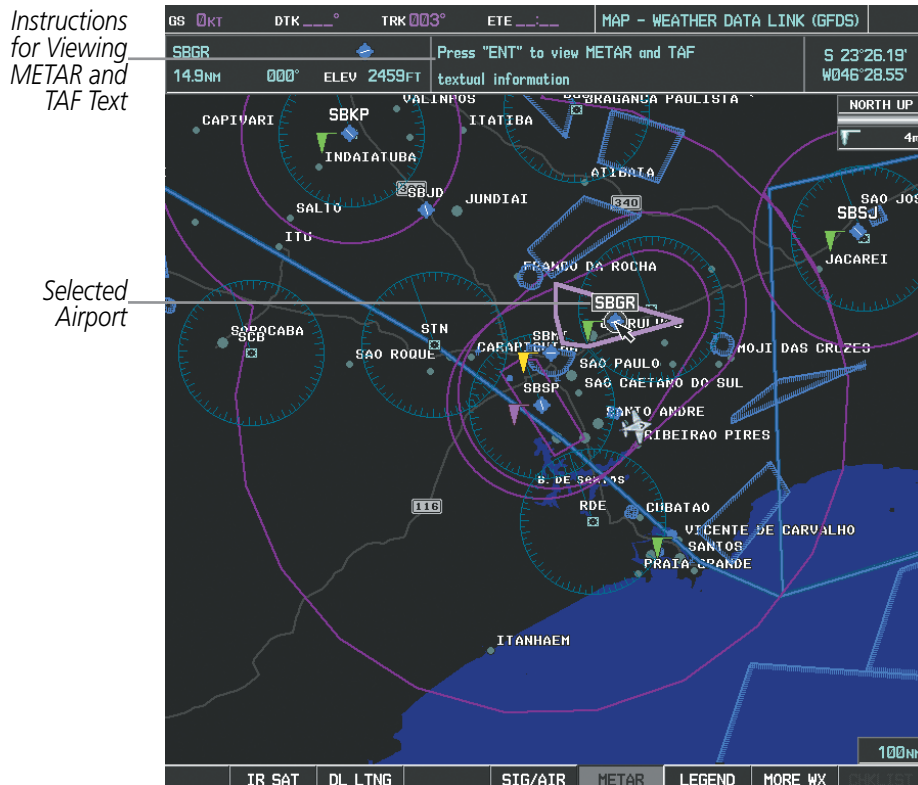

Instructions for Viewing METAR and TAF Text

Selected Airport

Figure 6-77 METAR Flags on the Weather Data Link (GFDS) Page

TAFs (Terminal Aerodrome Forecasts) are weather predictions for specific airports within a 24- hour period, and may span up to 36 hours. TAFs typically include forecast wind, visibility, weather phenomena, and sky conditions using METAR codes.

METAR and TAF text are displayed on the Weather Information Page. TAF information is displayed in its raw form when it is available.

Displaying METAR and TAF text:

- 1) On the Weather Data Link (GFDS) Page, select the **METAR** Softkey.
- 2) Press the **RANGE** Knob and pan to the desired airport.
- 3) Press the **ENT** Key. The Weather Information Page is shown with METAR and TAF text.
- 4) Use the **FMS** Knob or the **ENT** Key to scroll through the METAR and TAF text. METAR text must be completely scrolled through before scrolling through the TAF text.
- 5) Press the **FMS** Knob or the **CLR** Key to return to the Weather Data Link (GFDS) Page.

Or:

- 1) Select the Weather Information Page.
 - a) Turn the large **FMS** Knob to select the Waypoint Page Group.
 - b) Select the **WX** Softkey to select the Weather Information Page.
- 2) Press the **FMS** Knob to display the cursor.
- 3) Use the **FMS** Knob to enter the desired airport and press the **ENT** Key.
- 4) Use the **FMS** Knob or the **ENT** Key to scroll through the METAR and TAF text. Note that the METAR text must be completely scrolled through before scrolling through the TAF text.

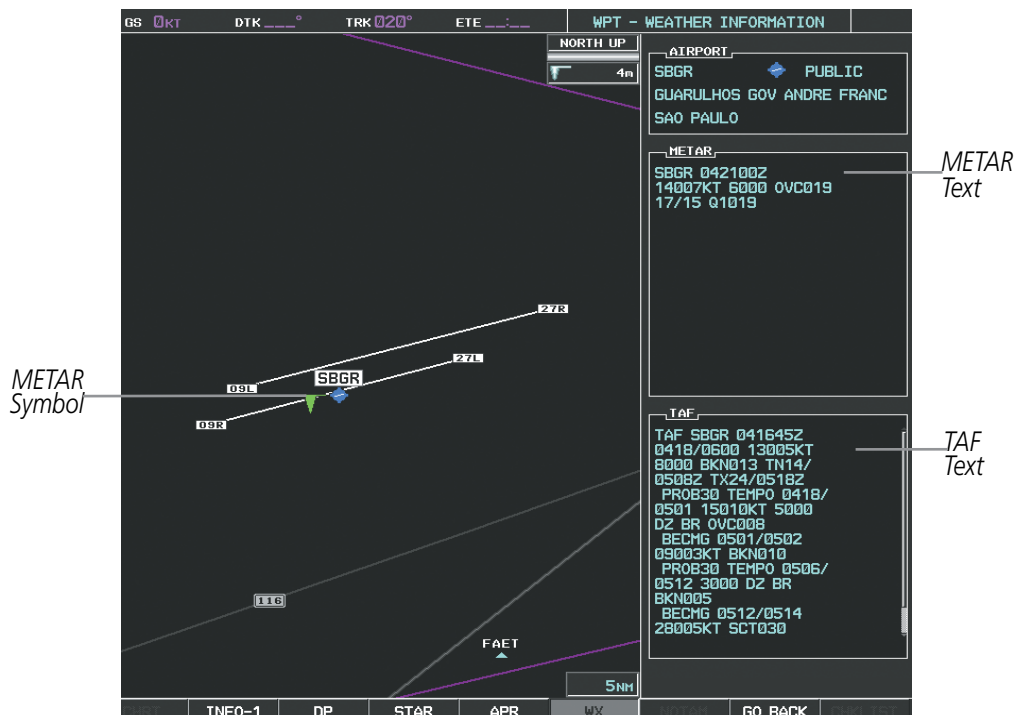

Figure 6-78 METAR and TAF Text

Raw METAR text is also accessible while panning the map cursor over a METAR flag on any map page on which a METAR is displayed. The METAR text is shown in a box near the METAR flag.

In addition, METAR flags and their associated text are displayed on the Active Flight Plan Page on the MFD. The system shows a METAR flag next to waypoints in the flight plan with an available METAR.

Displaying raw METAR text on the Active Flight Plan Page:

- 1) Select the Active Flight Plan Page on the MFD.
- 2) Press the **FMS** Knob to activate the cursor.
- 3) Turn the large **FMS** Knob to highlight a waypoint with an available METAR (indicated with a METAR flag next to it). The METAR text will appear in the 'SELECTED WAYPOINT WEATHER' window below.
- 4) When finished, press the **FMS** Knob to remove the cursor or press the **FPL** Key to exit the Active Flight Plan Page.

To display the METAR legend on the Weather Data Link (GFDS) Page (Figure 6-79), select the **LEGEND** Softkey when METARs are selected for display.

The METAR flag color is determined by the information in the METAR text. A gray METAR flag is displayed when the METAR text does not contain adequate information.



Figure 6-79 METAR Legend

WINDS ALOFT

Winds Aloft data (Figure 6-80) shows the forecasted wind speed and direction at the surface and at selected altitudes. Altitude can be displayed in 3,000-foot increments up to 42,000 feet MSL.

Displaying Winds Aloft data:

- 1) Select the Weather Data Link (GFDS) Page.
- 2) Press the **MORE WX** Softkey.
- 3) Press the **WIND** Softkey.
- 4) Select the desired altitude level: SFC (surface) up to 42,000 feet. Select the **NEXT** or **PREV** Softkey to cycle through the altitude softkeys. The **WIND** Softkey label changes to reflect the altitude selected.

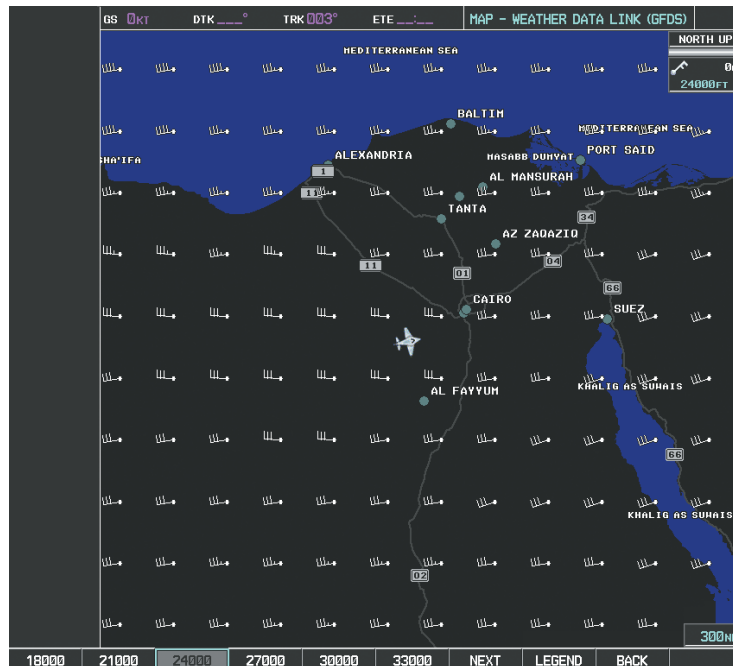

Figure 6-80 Winds Aloft at 24,000 Feet

To display the Winds Aloft legend (Figure 6-81), select the **LEGEND** Softkey when Winds Aloft is selected for display.

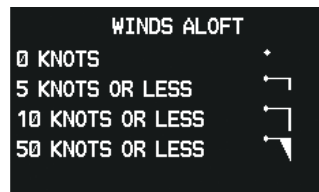

Figure 6-81 Winds Aloft Data with Legend

Headwind and tailwind components aloft are available inside the Profile View on the Navigation Map Page (Figure 6-82). The displayed components are relative to current aircraft altitude and track, but not to aircraft speed.

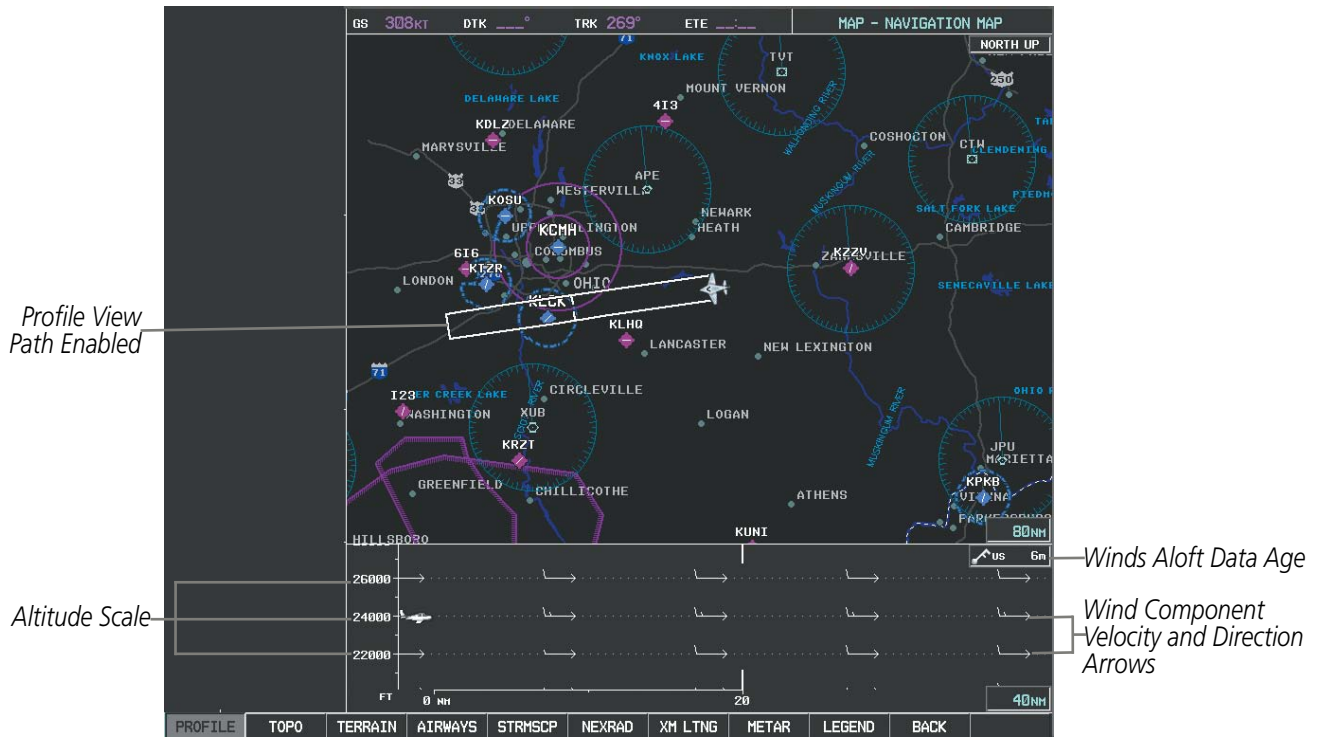

Figure 6-82 Navigation Map Page with Winds Aloft Data on Profile View

Arrows pointing to the left indicate headwind components; tailwind component arrows point to the right, as shown in Table 6-8.

Headwind Symbol	Tailwind Symbol	Headwind/Tailwind Component
None	None	Less than 5 knots
		5 knots
		10 knots
		50 knots

Table 6-8 Profile View Headwind/Tailwind Component Symbols

Showing/Hiding Profile View (containing winds aloft data)

- 1) Select the Navigation Map Page.
- 2) Select the **PROFILE** Softkey.

Or:

- 1) Press the **MENU** Key.
- 2) Turn the large FMS Knob to highlight 'Show Profile View' or 'Hide Profile View' (choice dependent on current state) and press the **ENT** Key.

Winds Aloft data inside the Profile View is enabled by default when the Profile View is displayed on the Navigation Map Page. This behavior can be changed on the Navigation Map Page.

Enabling/disabling winds aloft data display in Profile View:

- 1) Select the Navigation Map Page.
- 2) Press the **MENU** Key.
- 3) With Map Setup highlighted, press the **ENT** Key (Figure 6-83).
- 4) Turn the small **FMS** Knob to select the Profile Group and press the **ENT** Key (Figure 6-84).
- 5) Turn the large **FMS** Knob to select 'Profile Winds' (Figure 6-85).
- 6) Turn the small **FMS** Knob to select 'On' or 'Off'.
- 7) Press the **FMS** Knob or **CLR** Key to return to the Navigation Map Page with the changed settings.

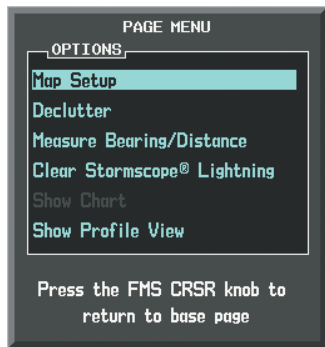

Figure 6-83 Navigation Map Page Menu

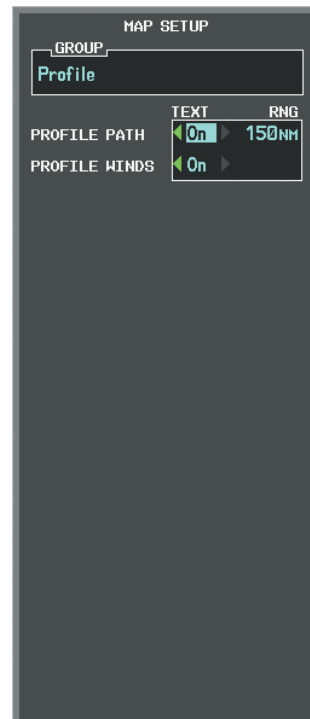

Figure 6-85 Navigation Map Page Setup Menu, Weather Group



Figure 6-84 Navigation Map Page Setup Menu

PIREPS

Pilot Weather Reports (PIREPs) describe in-flight weather encountered by pilots. A PIREP may contain unforecast adverse weather conditions, such as low in-flight visibility, icing conditions, wind shear, turbulence, and type of aircraft flown. PIREPs are issued as either Routine (UA) or Urgent (UUA).

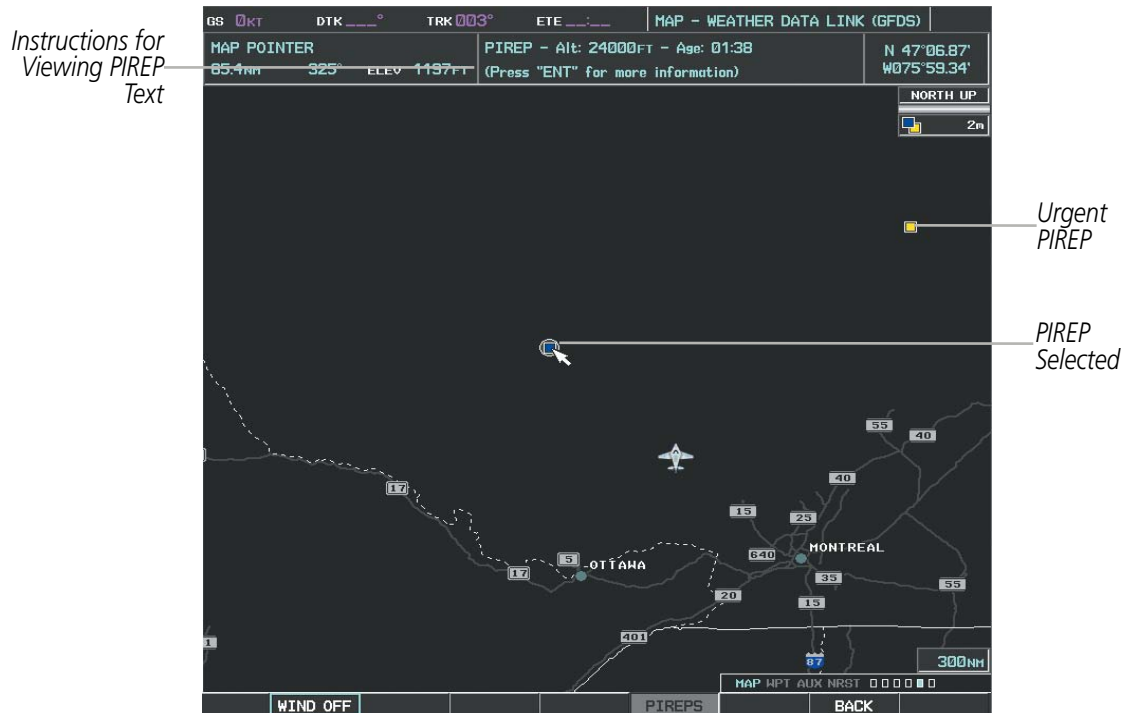

Figure 6-86 PIREPs on the Weather Data Link (GFDS) Page

Displaying PIREP text:

- 1) Select the Weather Data Link (GFDS) Page.
- 2) Press the **MORE WX** Softkey.
- 3) Press the **PIREPS** Softkey.
- 4) Press the **RANGE** Knob and pan to the desired weather report. A gray circle will appear around the weather report when it is selected.
- 5) Press the **ENT** Key. The PIREP text is first displayed in a decoded fashion, then as raw text.
- 6) Use the **FMS** Knob or the **ENT** Key to scroll through the PIREP text.
- 7) Press the **FMS** Knob or the **CLR** Key to close the PIREP text window and return to the Weather Data Link (GFDS) Page.

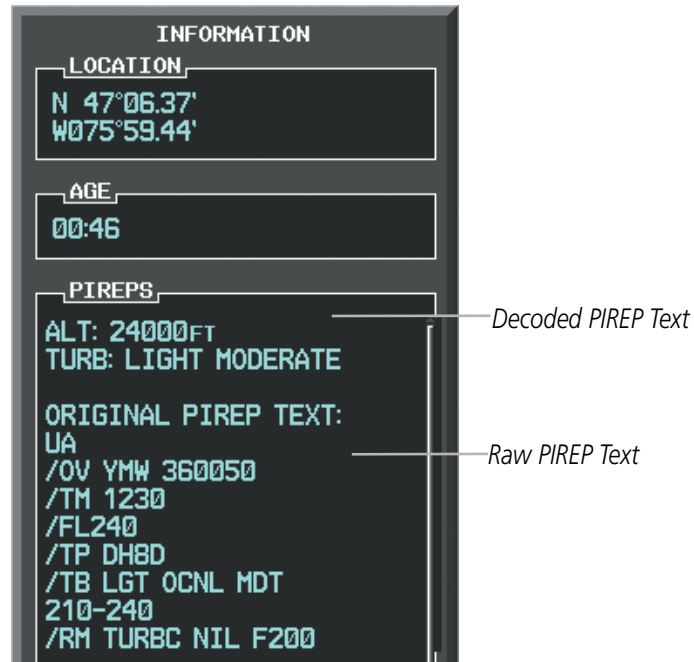

Figure 6-87 PIREP Text on the Weather Data Link (GFDS) Page

To display the PIREP legend (Figure 6-88), select the **LEGEND** Softkey when PIREPs or AIREPs are selected for display.

The PIREP color is determined by the type (routine or urgent).



Figure 6-88 PIREPs Legend

TFRS

NOTE: Temporary Flight Restriction (TFR) data from GFDS is only available in the United States (not including any U.S. territories.) Refer to fly.garmin.com/fly-garmin/gfds-weather for GFDS product coverage information.

In the United States, the FAA issues Temporary Flight Restrictions (TFRs) to designate areas where flight is restricted. TFRs are issued to restrict flight for a variety of reasons including national security, law enforcement, firefighting, natural disasters, airshows, and large sporting events. TFRs may be issued at any time, and TFR data displayed on the G1000 is only intended to supplement official TFR information obtained from Flight Service Stations (FSS), and air traffic control.

The age of TFR data is not shown; however, if TFR data is not available or has expired, the system displays 'TFR N/A' in the upper-left corner of maps on which TFRs can be displayed.

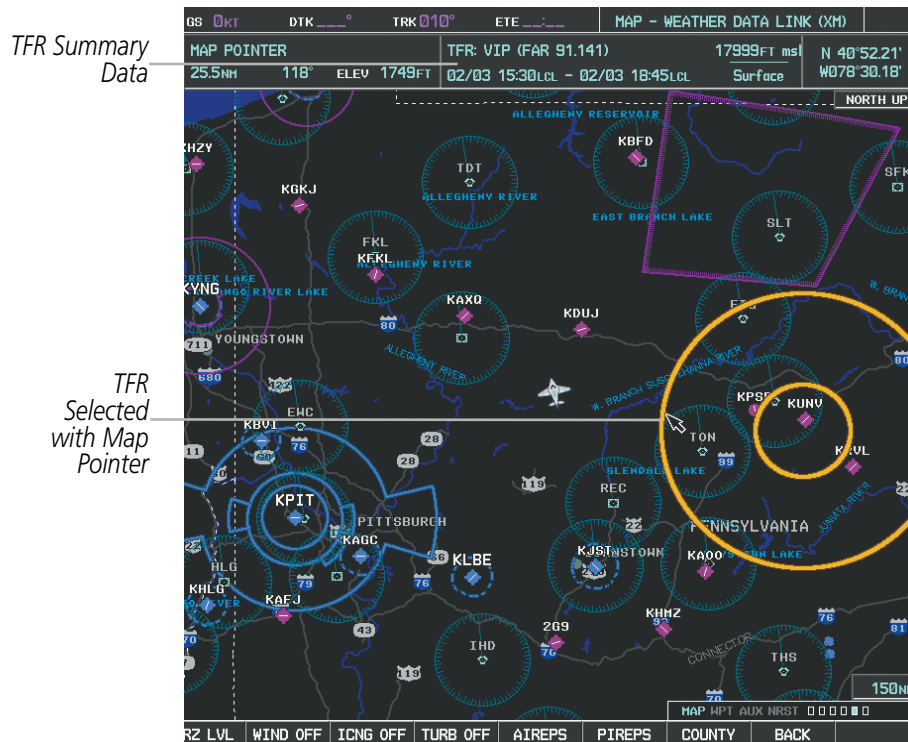

Figure 6-89 TFR Data on the Weather Data Link (GFDS) Page

Displaying TFR Data:

- 1) Select the Weather Data Link (GFDS) Page or Navigation Map Page.
- 2) Press the **RANGE** Knob and pan the map pointer over a TFR to highlight it. The system displays TFR summary information above the map.
- 3) Press the **ENT** Key. The system displays a pop-up menu.
- 4) If necessary, turn the **FMS** Knob to select 'Review Airspaces' and press the **ENT** Key. The system displays the TFR Information window.
- 5) Press the **FMS** Knob or the **CLR** Key to remove the TFR Information window.

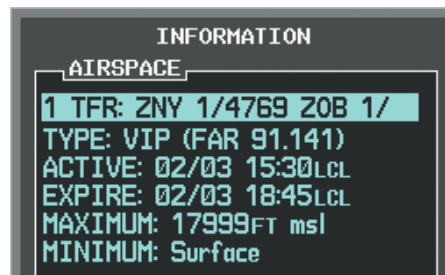

Figure 6-90 Full Text for Selected TFR

The setup menus for the Navigation Map Page control the map range settings above which TFR data is decluttered from the display. If a map range larger than the TFR product map range setting is selected, the TFR product data is removed from the map.

Maps other than the Navigation Map Page use settings based on those selected for the Navigation Map Page.

Setting up and customizing TFR data for maps on which TFR data can be displayed:

- 1) Select the Navigation Map Page.
- 2) Press the **MENU** Key.
- 3) With Map Setup highlighted, press the **ENT** Key (Figure 6-91).
- 4) Turn the small **FMS** Knob to select the Aviation Group and press the **ENT** Key (Figure 6-92).
- 5) Turn the large **FMS** Knob to scroll to the TFR product range setting (Figure 6-93).
- 6) Turn the small **FMS** Knob to scroll through options (Off, range settings).
- 7) Press the **ENT** Key to select an option.
- 8) Press the **FMS** Knob or **CLR** Key to return to the Navigation Map Page with the changed settings.

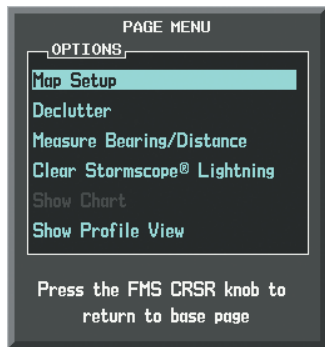

Figure 6-91 Navigation Map Page Menu



Figure 6-92 Navigation Map Page Setup Menu

	TEXT	RNG
ACTIVE FPL		2000NM
ACTIVE FPL WPT	Med	2000NM
LARGE APT	Lrg	200NM
MEDIUM APT	Med	150NM
SMALL APT	Med	50NM
SAFETAXI		3NM
RWY EXTENSION		Off
INT WAYPOINT	Med	15NM
NDB WAYPOINT	Med	15NM
VOR WAYPOINT	Med	150NM
CLASS B/TMA		200NM
CLASS C/TCA		200NM
CLASS D		150NM
RESTRICTED		200NM
MOA (MILITARY)		200NM
OTHER/ADIZ		200NM
TFR		Off

Figure 6-93 Navigation Map Page Setup Menu, Weather Group

ABNORMAL OPERATIONS

If the G1000 cannot complete a GFDS weather data request, one or more messages will appear in the request status window.

Weather Request Status Message	Description
Auto requests inhibited Send manual request to reset.	The system has disabled automatic weather data requests due to excessive errors. Automatic weather data requests have stopped. Send a manual weather data request to resume automatic updates.
Auto update retry: ## Seconds	The system will attempt another automatic weather data request after an error occurred during the previous request. Timer counts down until the next automatic request occurs.
GFDS Comm Error [2]	A communications error has occurred with the GIA. The G1000 should be serviced.
GFDS Comm Error [4]	This occurs if multiple automatic weather data requests have recently failed, or a GIA is off-line.
GFDS Comm Error [5]	This can occur if the Iridium or GFDS networks are not accessible. Check Iridium signal strength. If this error persists, the G1000 should be serviced.
GFDS Comm Error [6]	A communications error has occurred. If this error persists, the G1000 should be serviced.
GFDS Comm Error [7]	A weather data transfer has timed out. Check Iridium signal strength and re-send the data request.
GFDS Comm Error [8]	A server error has occurred or invalid data received.
GFDS Login Invalid	There is a problem with the GFDS registration. Contact Garmin Flight Data Services at 1-866-739-5687 in the United States or 913-397-8200, ext. 1135 for assistance.
GFDS Server Temporarily Inop	The GFDS weather data server is temporarily out of service, but is expected to return to service in less than 30 minutes.
GFDS Server Inop	The GFDS weather data server will be out of service for at least 30 minutes.
Invalid Coverage Area	The weather data request coverage area does not contain at least one of the following: a waypoint, a flight plan, or a flight plan destination. Verify at least one of the coverage options is enabled (checked) and contains required criteria, then re-send the data request.
NO GFDS Subscription	The system is not currently subscribed to GFDS, or the access code is incorrect. Verify the access code. Contact Garmin Flight Data Services at 1-866-739-5687 in the United States or 913-397-8200, ext. 1135 for assistance.
Reduce Request Area	The GFDS weather data request area exceeds size limits. Reduce weather coverage area and re-send data request.
Request Cancelled	The user has cancelled a GFDS weather data request.
Requested area too large. Reduce coverage area.	The size of the GFDS weather data request has exceeded limits. Reduce the size of the coverage area and try the weather data request again.
Request Failed - Try Again	The weather data request timed-out. Re-send data request.

Table 6-9 Abnormal GFDS Request Status Messages

WORLDWIDE WEATHER IN REVERSIONARY MODE

When the G1000 is operating in Reversionary Mode, only those weather products which can be displayed on the PFD Inset map will be available for display (see Table 6-6 for a list of weather products and their associated map availability).

If manual weather data requests were enabled prior to entering Reversionary Mode, no new GFDS weather data can be retrieved while operating in Reversionary Mode. If automatic weather data requests were enabled prior to Reversionary Mode operation, the system will continue the automatic data requests in Reversionary Mode (provided automatic requests have not been inhibited due to a system error).

6.3 AIRBORNE COLOR WEATHER RADAR

SYSTEM DESCRIPTION

The optional Garmin GWX 68 Airborne Color Weather Radar is a four-color digital pulsed radar with 6.5 kilowatts of output power. It combines excellent range and adjustable scanning profiles with a high-definition target display. The pulse width is four microseconds (μs) on all ranges except the 2.5 nm range. The GWX 68 uses a one μs pulse width at this range to reduce the targets smearing together on the display for better target definition at close range.

The Socata TBM 850 uses a 10-inch phased array antenna that is fully stabilized to accommodate 30° of pitch and roll.

To focus radar scanning on specific areas, Sector Scanning offers pilot-adjustable horizontal scan angles of 20°, 40°, 60°, or 90°. A vertical scanning function helps to analyze storm tops, gradients, and cell buildup activity at various altitudes.

Radar features include:

- Extended Sensitivity Time Constant (STC) logic that automatically correlates distance of the return echo with intensity, so cells do not suddenly appear to get larger as they get closer.
- WATCH® (Weather ATtenuated Color Highlight) helps identify possible shadowing effects of short-range cell activity, identifying areas where radar return signals are weakened or attenuated by intense precipitation (or large areas of lesser precipitation) and may not fully reflect the weather behind a storm.
- Weather Alert that looks ahead for intense cell activity in the 80-320 nm range, even if these ranges are not being monitored.

PRINCIPLES OF PULSED AIRBORNE WEATHER RADAR

The term RADAR is an acronym for RAdio Detecting And Ranging. Pulsed radar locates targets by transmitting a microwave pulse beam that, upon encountering a target, is reflected back to the radar receiver as a return echo. The microwave pulses are focused and radiated by the antenna, with the most intense energy in the center of the beam and decreasing intensity near the edge. The same antenna is used for both transmitting and receiving. The returned signal is then processed and displayed on the G1000 MFD.

Radar detection is a two-way process that requires 12.36 μs for the transmitted microwave pulses to travel out and back for each nautical mile of target range. It takes 123.6 μs for a transmitted pulse to make the round trip if a target is ten nautical miles away.

Airborne weather radar should be used to avoid severe weather, not for penetrating severe weather. The decision to fly into an area of radar targets depends on target intensity, spacing between the targets, aircraft capabilities, and pilot experience. Pulse type weather radar detects only precipitation, not clouds or turbulence. The display may indicate clear areas between intense returns, but this does not necessarily mean it is safe to fly between them. Only Doppler radar can detect turbulence.

Airborne weather radar has other capabilities beyond weather detection. It also has the ability to detect and provide distance to cities, mountains, coastlines, rivers, lakes, and oceans.

NEXRAD AND AIRBORNE WEATHER RADAR

Both Airborne Weather Radar and NEXRAD measure weather reflectivity in decibels (dB). A decibel is a logarithmic expression of the ratio of two quantities. Airborne Weather Radar measures the ratio of power against the gain of the antenna, while NEXRAD measures the energy reflected back to the radar, or the radar reflectivity ratio.

Both systems use colors to identify the different echo intensities, but the colors are not interchangeable. Airborne color radar values used by Garmin Airborne Color Weather Radar should not be confused with NEXRAD radar values.

ANTENNA BEAM ILLUMINATION

The radar beam is much like the beam of a spotlight. The further the beam travels, the wider it becomes. The radar is only capable of seeing what is inside the boundaries of the beam. The figure below depicts a radar beam's characteristics. The figure illustrates vertical dimensions of the radar beam, although the same holds true for the horizontal dimensions. In other words, the beam is as wide as it is tall. Note that it is possible to miss areas of precipitation on the radar display because of the antenna tilt setting. With the antenna tilt set to zero in this illustration, the beam overshoots the precipitation at 15 nautical miles.

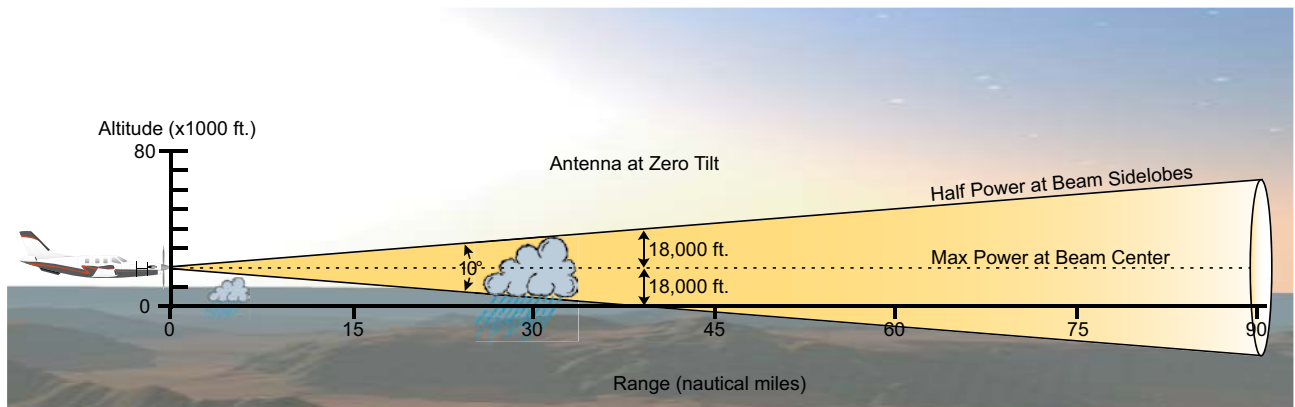

Figure 6-94 Radar Beam from a 10 inch Antenna

The curvature of the earth can also be a factor in missing areas of precipitation, especially at range settings of 150 nautical miles or more. Here the beam overshoots the precipitation at less than 320 nautical miles.

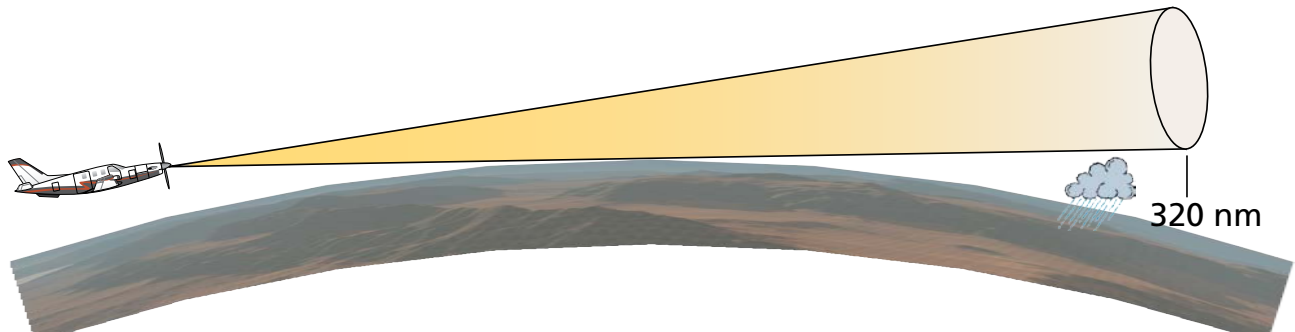

Figure 6-95 Radar Beam in Relation to the Curvature of the Earth

RADAR SIGNAL ATTENUATION

The phenomenon of radar signal attenuation affects the operation of weather radar. When the radar signal is transmitted, it is progressively absorbed and scattered, making the signal weaker. This weakening, or attenuation, is caused by two primary sources, distance and precipitation.

Attenuation because of distance is due to the fact that the radar energy leaving the antenna is inversely proportional to the square of the distance. The reflected radar energy from a target 40 miles away that fills the radar beam is one fourth the energy reflected from an equivalent target 20 miles away. This would appear to the operator that the storm is gaining intensity as the aircraft gets closer. Internal signal processing within the GWX 68 system compensates for much of this distance attenuation.

Attenuation due to precipitation is not as predictable as distance attenuation. It is also more intense. As the radar signal passes through moisture, a portion of the radar energy is reflected back to the antenna. However, much of the energy is absorbed. If precipitation is very heavy, or covers a large area, the signal may not reach completely through the area of precipitation. The weather radar system cannot distinguish between an attenuated signal and an area of no precipitation. If the signal has been fully attenuated, the radar displays a radar shadow. This appears as an end to the precipitation when, in fact, the heavy rain may extend much further. A cell containing heavy precipitation may block another cell located behind the first, preventing it from being displayed on the radar. Never fly into these shadowed areas and never assume that all of the heavy precipitation is being displayed unless another cell or a ground target can be seen beyond the heavy cell. The WATCH® feature of the GWX 68 Weather Radar system can help in identifying these shadowed areas. Areas in question appear as shadowed or gray on the radar display. Proper use of the antenna tilt control can also help detect radar shadows.

Attenuation can also be due to poor maintenance or degradation of the radome. Even the smallest amount of wear and scratching, pitting, and pinholes on the radome surface can cause damage and system inefficiency.

RADAR SIGNAL REFLECTIVITY

PRECIPITATION

Precipitation or objects more dense than water, such as the surface of the earth or solid structures, are detected by the weather radar. The weather radar does not detect clouds, thunderstorms, or turbulence directly. It detects precipitation associated with clouds, thunderstorms, and turbulence. The best radar signal reflectors are raindrops, wet snow, or wet hail. The larger the raindrop, the better the reflectivity. The size of the precipitation droplet is the most important factor in radar reflectivity. Because large drops in a small concentrated area are characteristic of a severe thunderstorm, the radar displays the storm as a strong return. Ice crystals, dry snow, and dry hail have low levels of reflectivity as shown in the illustration, and often is not displayed by the radar. Additionally, a cloud that contains only small raindrops, such as fog or drizzle, does not reflect enough radar energy to produce a measurable target return.

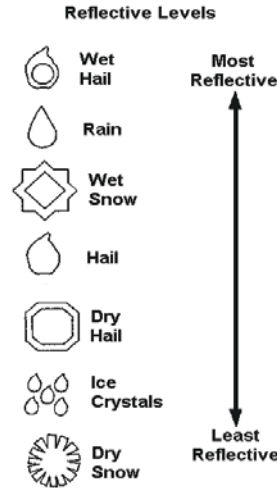

Figure 6-96 Precipitation Type and Reflectivity

GROUND RETURNS

The intensity of ground target returns depends upon the angle at which the radar beam strikes the ground target (Angle of Incidence) and the reflective properties of that target. The gain can be adjusted so shorelines, rivers, lakes, and cities are well-defined. Increasing the gain too much causes the display to fill in between targets, thus obscuring some landmarks.

Cities normally provide a strong return signal. While large buildings and structures provide good returns, small buildings can be shadowed from the radar beam by the taller buildings. As the aircraft approaches and shorter ranges are selected, details become more noticeable as the highly reflective regular lines and edges of the city become more defined.

Bodies of water such as lakes, rivers, and oceans are not good reflectors and normally do not provide good returns. The energy is reflected in a forward scatter angle with inadequate energy being returned. They can appear as dark areas on the display. However, rough or choppy water is a better reflector and provides stronger returns from the downwind sides of the waves.

Mountains also provide strong return signals to the antenna, but also block the areas behind. However, over mountainous terrain, the radar beam can be reflected back and forth in the mountain passes or off canyon walls, using up all or most of the radar energy. In this case, no return signal is received from this area, causing the display to show a dark spot which could indicate a pass where no pass exists.

ANGLE OF INCIDENCE

The angle at which the radar beam strikes the target is called the Angle of Incidence. The figure illustrates the incident angle (θ). This directly affects the detectable range, the area of illumination, and the intensity of the displayed target returns. A large incident angle gives the radar system a smaller detectable range and lower display intensity due to minimized reflection of the radar energy.

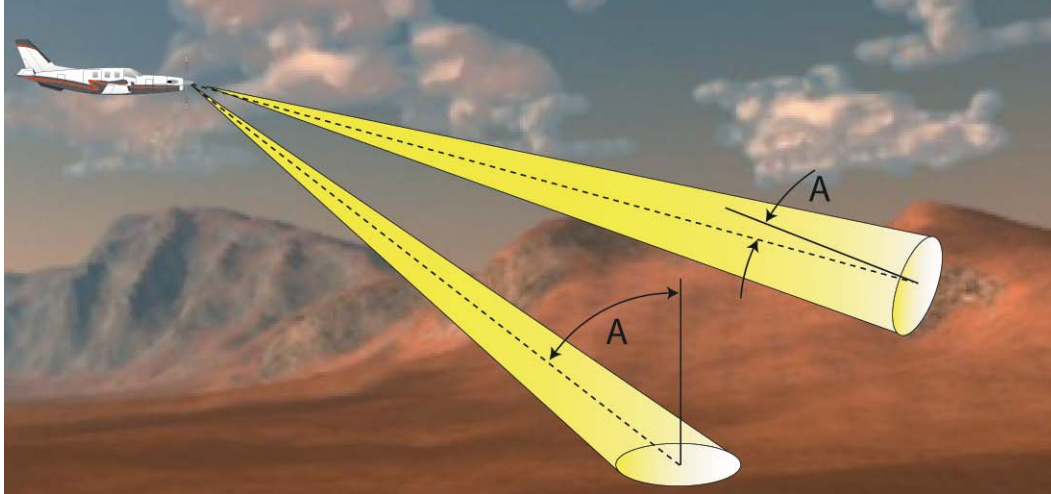

Figure 6-97 Angle of Incidence

A smaller incident angle gives the radar a larger detectable range of operation and the target display shows a higher intensity. Since more radar energy is reflected back to the antenna with a low incident angle, the resulting detectable range is increased for mountainous terrain.

SAFE OPERATING DISTANCE

The following information establishes a minimum safe distance from the antenna for personnel near operating weather radar. The minimum safe distance is based on the FCC's exposure limit at 9.3 to 9.5 GHz for general population/uncontrolled environments, which is 1 mW/cm². See Advisory Circular 20-68B for more information on safe distance determination.

MAXIMUM PERMISSIBLE EXPOSURE LEVEL (MPEL)

The zone in which the radiation level exceeds the US Government standard of 1 mW/cm² is the semicircular area of at least 9.16 feet from the 10-inch antenna. All personnel must remain outside of this zone. With a scanning or rotating beam, the averaged power density at the MPEL boundary is significantly reduced.

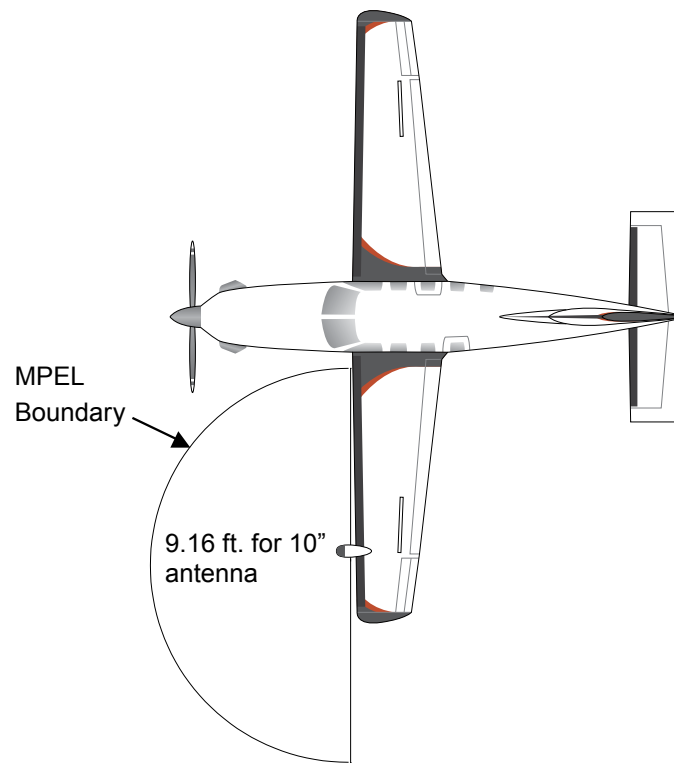

Figure 6-98 MPEL Boundary

BASIC ANTENNA TILT SETUP

The following discussion is a simple method for setting up the weather radar antenna tilt for most situations. It is not to be considered an all encompassing setup that works in all situations, but this method does provide good overall parameters for the monitoring of threats. Ultimately, it is desired to have the antenna tilted so that the bottom of the radar beam is four degrees below parallel with the ground. The following example explains one way of achieving this.

With the aircraft flying level, adjust the antenna tilt so ground returns are displayed at a distance that equals the aircraft's current altitude (AGL) divided by 1,000. For example, if the aircraft is at 14,000 feet, adjust the tilt so the front edge of ground returns are displayed at 14 nautical miles. Note this antenna tilt angle setting. Now, raise the antenna tilt 6 degrees above this setting. The bottom of the radar beam is now angled down 4° from parallel with the ground.

PRACTICAL APPLICATION USING THE BASIC TILT SETUP

With the antenna tilt set as previously described, any displayed target return should be scrutinized when flying at altitudes between 2,000 and 30,000 feet AGL. If the displayed target advances on the screen to within 5 nautical miles of the aircraft, avoid it. This may be either weather or ground returns that are 2,000 feet or less below the aircraft. Raising the antenna tilt 4 degrees can help separate ground returns from weather returns in relatively flat terrain. This aligns the bottom of the radar beam parallel with the ground. Return the antenna tilt to the previous setting after a few sweeps.

If the aircraft is above 29,000 feet, be cautious of any target return that gets to within 30 nautical miles. This is likely a thunderstorm that has a top high enough that the aircraft cannot fly over it safely.

If the aircraft altitude is 15,000 feet or lower, setting the displayed range to 60 miles may be more helpful. Closely monitor anything that enters the display.

Also, after setting up the antenna tilt angle as described previously, ground returns can be monitored for possible threats. The relationship between antenna tilt angle, altitude, and distance is one degree of tilt equals 100 feet of altitude for every one nautical mile.

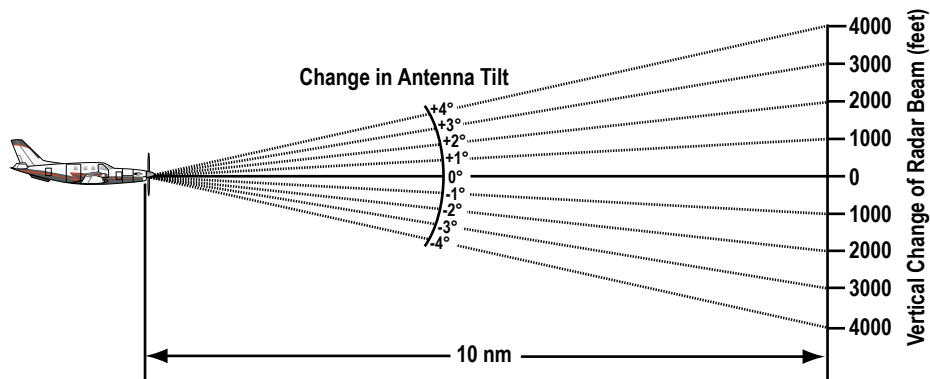

Figure 6-99 Vertical Change in Radar Beam per Nautical Mile

Therefore, with the antenna tilt set so that the bottom of the beam is four degrees below parallel with the ground, a target return at 10 nm is approximately 4,000 feet below the aircraft; at 20 nm, 8,000 feet; at 50 nm, 20,000 feet. In other words, at this tilt setting, a ground return (such as a mountain peak) being displayed at 10 nm would have a maximum distance below the aircraft of 4,000 feet. When that ground target return moves to 5 nm, the maximum distance below the aircraft is 2,000 feet.

This setup provides a good starting point for practical use of the GWX 68. There are many other factors to consider in order to become proficient at using weather radar in all situations.

WEATHER MAPPING AND INTERPRETATION

WEATHER DISPLAY INTERPRETATION

When evaluating various target returns on the weather radar display, the colors denote precipitation intensity and rates shown in the table.

Weather Mode Color	Intensity	Approximate Precipitation Rate (in/hr.)
Black	< 23 dBZ	< .01.
Green	23 dBZ to < 32 dBZ	.01 - 0.1.
Yellow	32 dBZ to < 41 dBZ	0.1 - 0.5
Red	41 dBZ to < 50 dBZ	0.5 - 2
Magenta	50 dBZ and greater	> 2

Table 6-10 Precipitation Intensity Levels

THUNDERSTORMS

Updrafts and downdrafts in thunderstorms carry water through the cloud. The more severe the drafts, the greater the number and size of the precipitation droplets. With this in mind, the following interpretations can be made from what is displayed on the weather radar. Avoid these areas by an extra wide margin.

- In areas where the displayed target intensity is red or magenta (indicating large amounts of precipitation), the turbulence is considered severe.
- Areas that show steep color gradients (intense color changes) over thin bands or short distances suggest irregular rainfall rate and strong turbulence.
- Areas that show red or magenta are associated with hail or turbulence, as well as heavy precipitation. Vertical scanning and antenna tilt management may be necessary to identify areas of maximum intensity.

Along squall lines (multiple cells or clusters of cells in a line) individual cells may be in different stages of development. Areas between closely spaced, intense targets may contain developing clouds not having enough moisture to produce a return. However, these areas could have strong updrafts or downdrafts. Targets showing wide areas of green are generally precipitation without severe turbulence. Targets showing irregular shapes are generally hazardous.

Irregularities in the target return may also indicate turbulence, appearing as hooks, fingers, or scalloped edges. These irregularities may be present in green areas with no yellow, red, or magenta areas and should be treated as highly dangerous areas. Avoid these areas as if they are red or magenta.

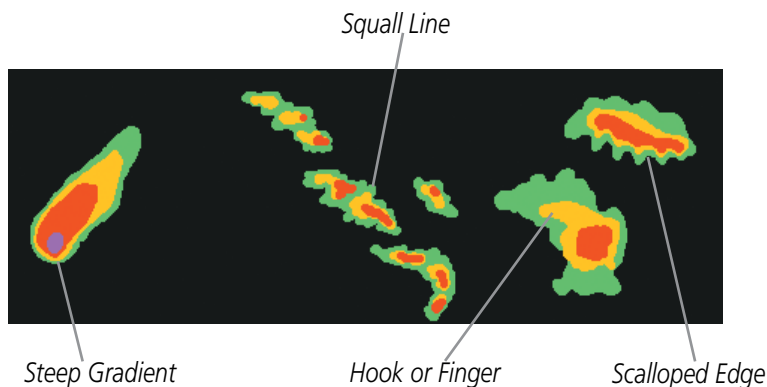

Figure 6-100 Cell Irregularities

Thunderstorm development is rapid. A course may become blocked within a short time. When displaying shorter ranges, periodically select a longer range to see if problems are developing further out. That can help prevent getting trapped in a blind alley or an area that is closed at one end by convective weather.

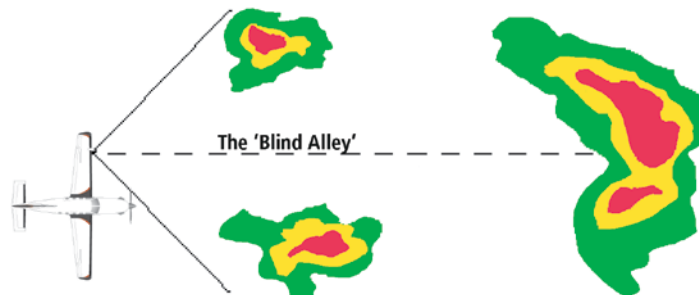
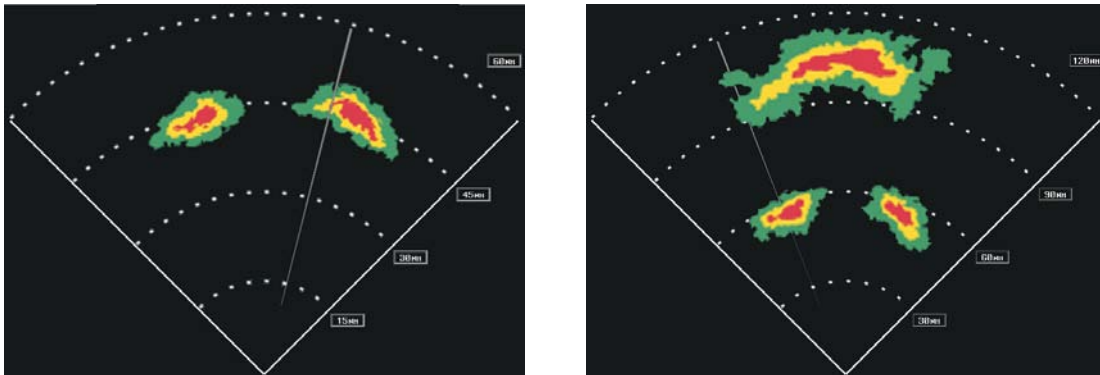

Figure 6-101 The Blind Alley - Horizontal Scan

In areas of multiple heavy cells, use the Vertical Scan feature along with antenna tilt management to examine the areas. Remember to avoid shadowed areas behind targets.



The Blind Alley at Close Range

The Large Storm Behind

Figure 6-102 The Blind Alley

TORNADOES

There are no conclusive radar target return characteristics which identify a tornado. However, tornadoes may be present if the following characteristics are observed:

- A narrow, finger-like portion extends and in a short time curls into a hook and closes on itself.
- A hook, which may be in the general shape of the numeral 6 (or 9 in the southern hemisphere), especially if bright and projecting from the southwest quadrant (northeast quadrant in the southern hemisphere) of a major thunderstorm.
- V-shaped notches.
- Doughnut shapes.

These shapes do not always indicate tornadoes, and tornado returns are not limited to these characteristics. Confirmed radar observations of tornadoes most often have not shown shapes different from those of a normal thunderstorm display.

HAIL

Hail results from updrafts carrying water high enough to freeze. Therefore, the higher the top of a thunderstorm, the greater the probability that it contains hail. Vertically scanning the target return can give the radar top of a thunderstorm that contains hail. Radar top is the top of a storm cell as detected by radar. It is not the actual top, or true top of the storm. The actual top of a storm cell is seen with the eyes in clear air and may be much higher than the radar top. The actual top does not indicate the top of the hazardous area.

Hail can fall below the minimum reflectivity threshold for radar detection. It can have a film of water on its surface, making its reflective characteristics similar to a very large water droplet. Because of this film of water, and because hail stones usually are larger than water droplets, thunderstorms with large amounts of wet hail return stronger signals than those with rain. Some hail shafts are extremely narrow (100 yards or less) and make poor radar targets. In the upper regions of a cell where ice particles are dry (no liquid coating), target returns are less intense.

Hail shafts are associated with the same radar target return characteristics as tornados. U-shaped cloud edges three to seven miles across can also indicate hail. These target returns appear quite suddenly along any edge of the cell outline. They also change in intensity and shape in a matter of seconds, making vigilant monitoring essential.

OPERATION IN WEATHER MODE



WARNING: Begin transmitting only when it is safe to do so. When transmitting while the aircraft is on the ground, no personnel or objects should be within 9.16 feet of the antenna.



CAUTION: In Standby mode, the antenna is parked at the center line. It is always a good idea to put the radar in Standby mode before taxiing the aircraft to prevent the antenna from bouncing on the bottom stop and possibly causing damage to the radar assembly.

When the weather radar system is in the Weather or Ground Map mode, the system automatically switches to Standby mode on landing.

In Reversionary mode, the weather radar system automatically switches to Standby mode. The system remains in Standby mode until both displays are restored. In Reversionary mode, the weather radar system cannot be controlled.

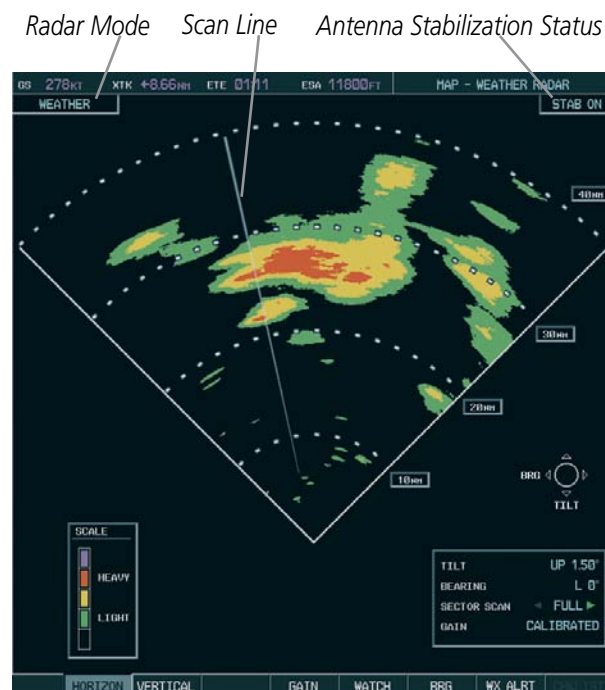

Figure 6-103 Horizontal Scan Display

Displaying weather on the Weather Radar Page:

- 1) Select the Weather Radar Page in the Map Page Group with the **FMS** Knob.
- 2) Select the **MODE** Softkey.
- 3) While on the ground, select the **STANDBY** Softkey. A one-minute warm-up period is initiated (countdown is displayed on the screen). After the warm-up is complete, the radar enters the Standby Mode.
 - a) Select the **WEATHER** Softkey. A confirmation window is displayed.

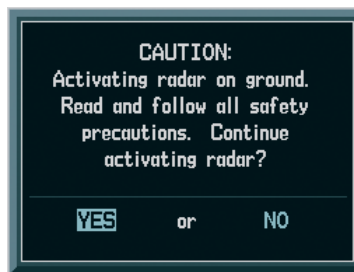

Figure 6-104 Confirming Activating Radar

- b) Turn the small **FMS** Knob to highlight YES and press the **ENT** Key to continue radar activation.
- OR:**
- If the aircraft is airborne, select the **WEATHER** Softkey. A one-minute warm-up period is initiated (countdown is displayed on the screen). After the warm-up is complete, the radar begins transmitting.
- 4) Turn the **RANGE** Knob to select the desired map range.
 - 5) The horizontal scan is initially displayed (Figure 6-103). If desired, select the **VERTICAL** Softkey to change to vertical scanning.

Vertically scanning a storm cell:



NOTE: Vertical scanning of a storm cell should be done with the aircraft wings level to avoid constant adjustment of the Bearing Line.

- 1) While in the Horizontal Scan view, select the **BRG** Softkey. This places the cursor in the BEARING field and displays the Bearing Line.

If the Bearing Line is not displayed, press the **MENU** Key and turn the large **FMS** Knob to select Show Bearing Line. Press the **ENT** Key.

- 2) Press the **ENT** Key.
- 3) Turn the small **FMS** Knob to place the Bearing Line on the desired storm cell or other area to be vertically scanned.

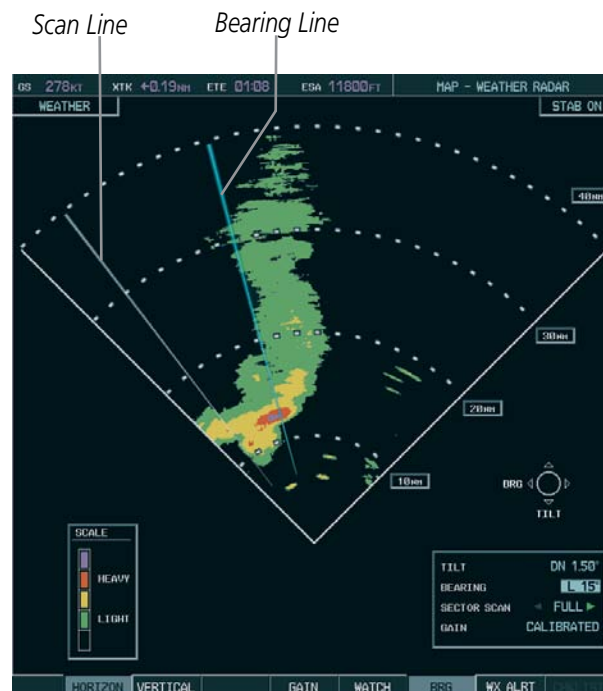

Figure 6-105 Bearing Line on Horizontal Scan

- 4) Select the **VERTICAL** Softkey. A vertical scan of the selected area is now displayed (Figure 6-106).
- 5) The small **FMS** Knob may be used to move the scanned bearing line a few degrees right or left.
- 6) Turn the **RANGE** Knob to adjust the range.
- 7) Press the **FMS** Knob to remove the cursor.
- 8) To select a new area to be vertically scanned, select the **HORIZON** Softkey to return to the Horizontal Scan view and repeat the previous steps.

The **RANGE** Knob can also be used to adjust bearing from left to right.

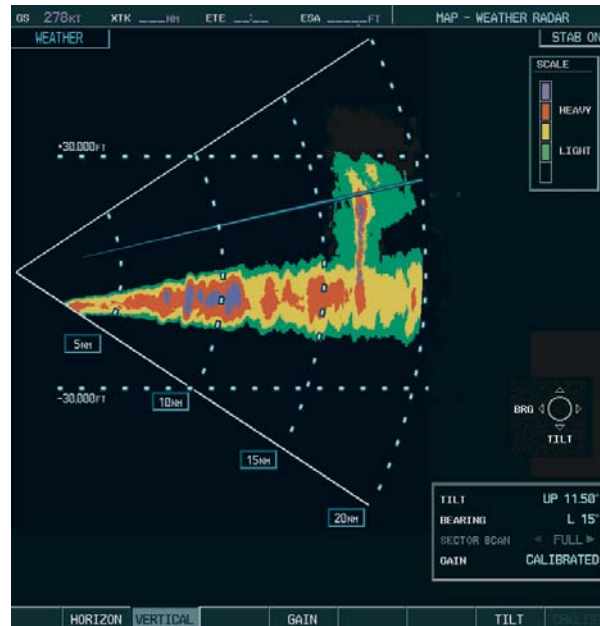

Figure 6-106 Vertical Scan Display

ADJUSTING ANTENNA TILT ANGLE

In order to make an accurate interpretation of a storm cell, the radar beam should be pointed at the wet part of the weather cell to record the proper rainfall intensity (color level). The ideal aiming point is just below the freezing level of the storm. The best way to find this point is to use the Vertical Scan feature. The antenna tilt angle can be centered on the strongest return area in the vertical scan to get a more accurate view of the coverage and intensity of the target in the horizontal scan.

Adjusting antenna tilt on the Horizontal Scan display:

- 1) Press the **FMS** Knob to activate the cursor in the TILT field.
- 2) Turn the small **FMS** Knob to select the desired antenna tilt angle.
- 3) Press the **ENT** Key.
- 4) Press the **FMS** Knob to remove the cursor.

The **RANGE** Knob can also be used to adjust tilt up and down.

Adjusting antenna tilt on the Vertical Scan display:

- 1) Select the **TILT** Softkey to activate the cursor in the TILT field and display the Tilt Line.

If the Tilt Line is not displayed, press the **MENU** Key and turn the large **FMS** Knob to select Show Tilt Line. Press the **ENT** Key.

- 2) Turn the small **FMS** Knob to adjust the antenna tilt angle. The selected tilt angle is implemented when Horizontal Scan is again selected.

The **RANGE** Knob can also be used to adjust tilt.

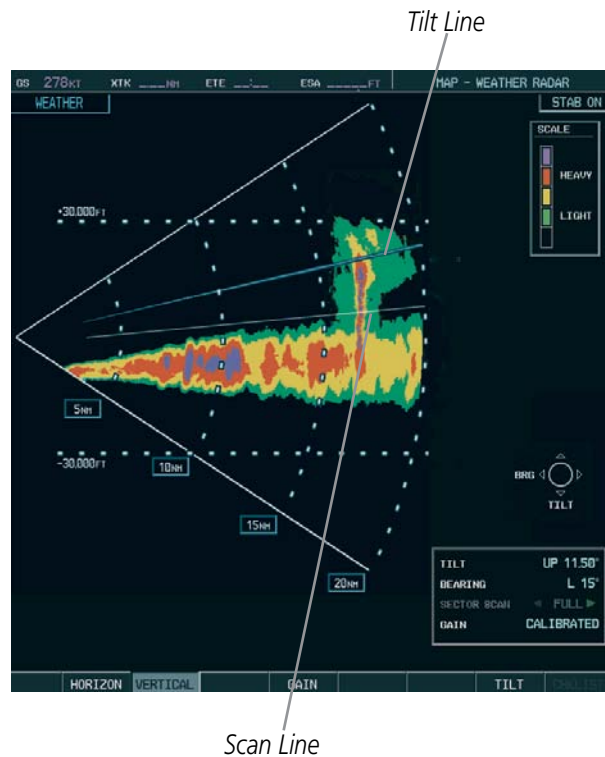

Figure 6-107 Adjusting Tilt on Vertical Scan Display

Adjusting Gain:



WARNING: Changing the gain in weather mode causes precipitation intensity to be displayed as a color not representative of the true intensity. Remember to return the gain setting to Calibrated for viewing the actual intensity of precipitation.

- 1) Select the **GAIN** Softkey to activate the cursor in the GAIN field.
- 2) Turn the small **FMS** Knob to adjust the gain for the desirable level. The gain setting is visible in the GAIN field as a movable horizontal bar in a flashing box. The line pointer is a reference depicting the calibrated position.
- 3) Press the **FMS** Knob to remove the cursor.
- 4) Select the **GAIN** Softkey again to recalibrate the gain. CALIBRATED is displayed in the GAIN field.

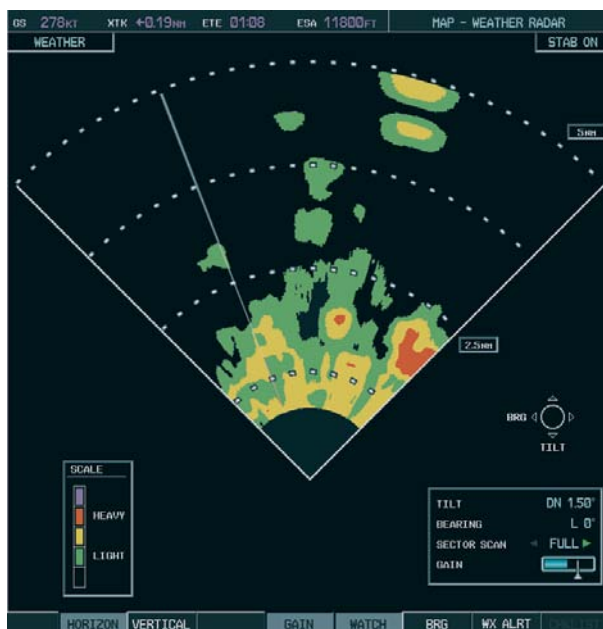

Manual Gain Set Below Calibrated

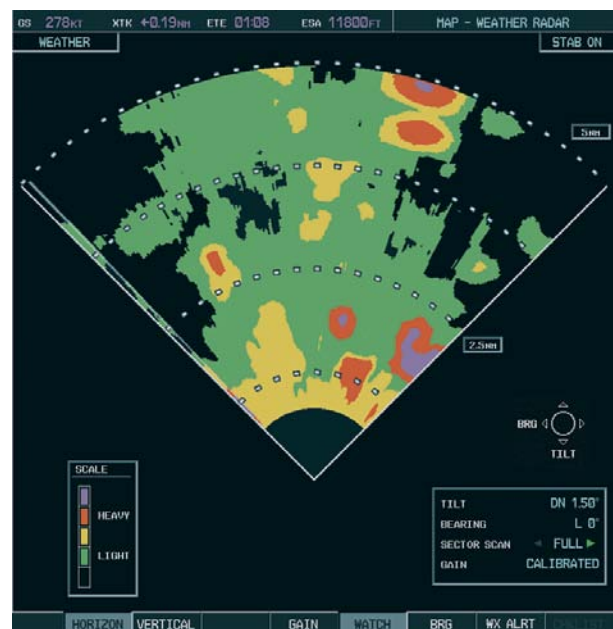

Calibrated Gain

Figure 6-108 Gain Calibration

Sector Scan:

- 1) While in horizontal scan mode, select the **BRG** Softkey to display the Bearing Line and place the cursor in the BEARING field. If the Bearing Line is not displayed, press the **MENU** Key and turn the large **FMS** Knob to select Show Bearing Line.
- 2) Press the **ENT** Key.

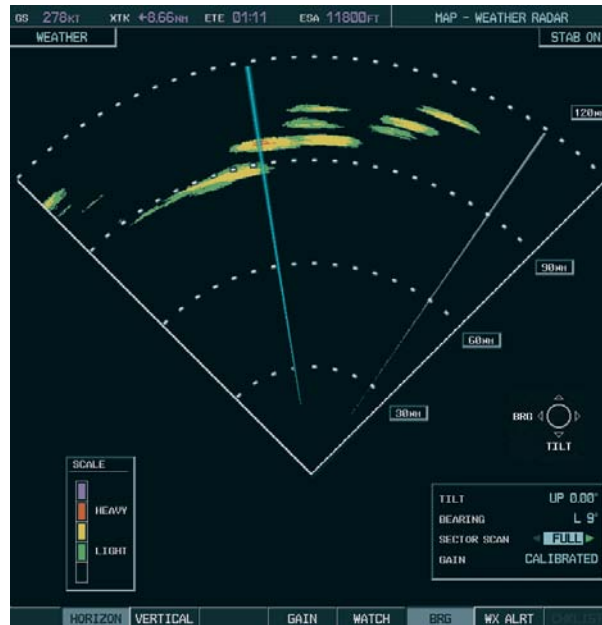

Figure 6-109 Selecting Sector Scan Position

- 3) Turn the small **FMS** Knob to place the Bearing Line in the desired position. The location of the Bearing Line becomes the center point of the Sector Scan.
- 4) Turn the large **FMS** Knob to place the cursor in the SECTOR SCAN field.
- 5) Turn the small **FMS** Knob to select FULL, 60°, 40°, or 20° scan.
- 6) If desired, readjust the Bearing Line as discussed previously to change the center of the Sector Scan.
- 7) Select the **BRG** Softkey again to remove the Bearing Line and cursor. The bearing reference is also reset to 0°.

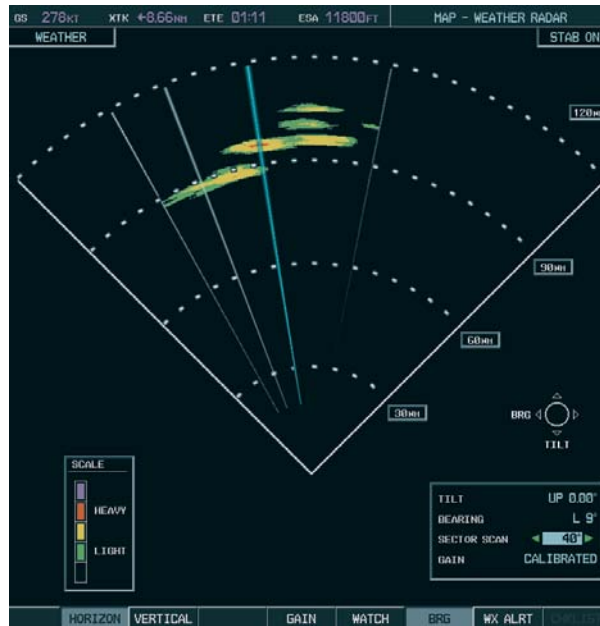

Figure 6-110 40° Sector Scan

Antenna Stabilization:

- 1) To activate or deactivate the antenna stabilization, select the **MODE** Softkey.
- 2) Select the **STAB ON** Softkey to activate antenna stabilization or select the **STAB OFF** Softkey to deactivate. The current stabilization condition is shown in the upper right of the weather radar display.

WEATHER ATTENUATED COLOR HIGHLIGHT (WATCH®)

While in horizontal scan mode, this feature can be used as a tool to determine areas of possible inaccuracies in displayed intensity due to weakening of the radar energy. This weakening is known as attenuation. The radar energy weakens as it passes through areas of intense precipitation, large areas of lesser precipitation, and distance. Issues with the radome also attenuates the radar energy. All these factors have an effect on the return intensity. The more energy that dissipates, the lesser the displayed intensity of the return. Accuracy of the displayed intensity of returns located in the shaded areas are suspect. Make maneuvering decisions with this information in mind. Proper antenna tilt management should still be employed to determine the extent of attenuation in a shaded area.

To activate or deactivate the WATCH® feature, select the **WATCH** Softkey.

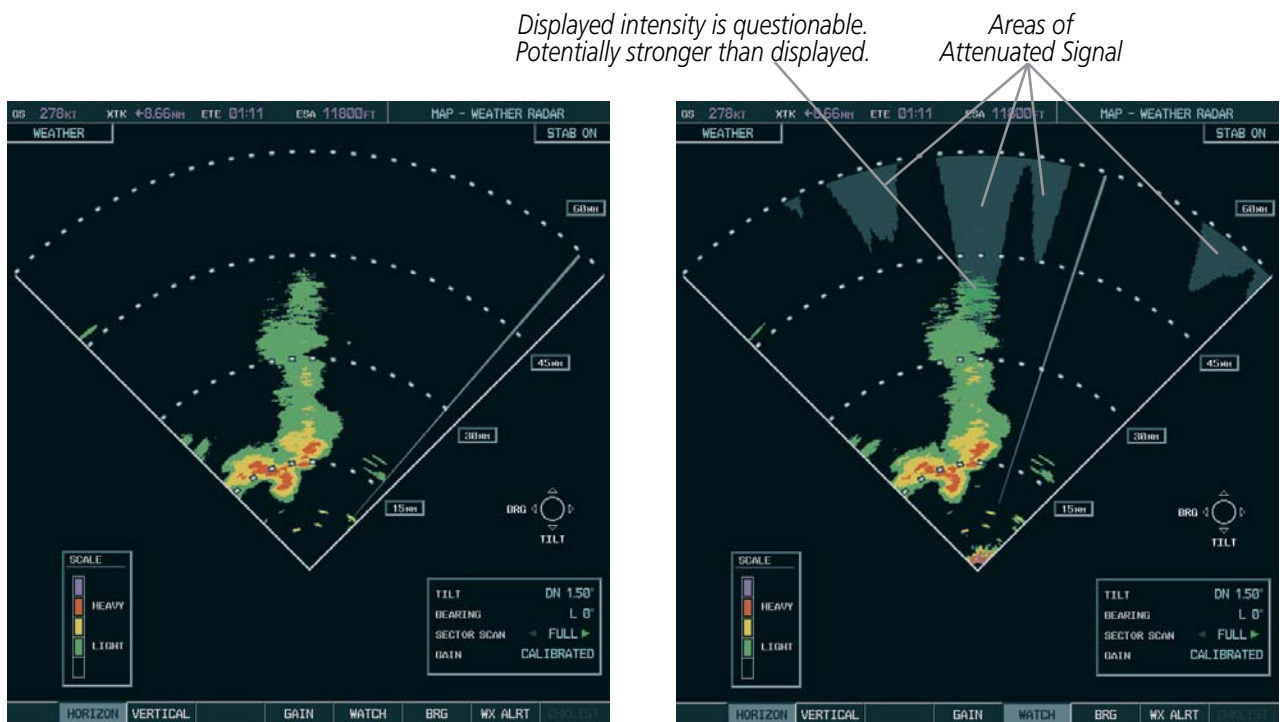

Horizontal Scan Without WATCH®

Horizontal Scan With WATCH®

Figure 6-111 Horizontal Scan Without and With WATCH™

WEATHER ALERT

The Weather Alert feature indicates the presence of heavy precipitation between the ranges of 80 and 320 nm regardless of the currently displayed range. Weather Alert targets appear as red bands along the outer range ring at the approximate azimuth of the detected returns.

If a Weather Alert is detected within $\pm 10^\circ$ of the aircraft heading, an alert is displayed on the PFD in the Messages Window.

If the antenna tilt is adjusted too low, a weather alert can be generated by ground returns. To avoid unwanted weather alerts, deselect the **WX ALRT** Softkey.

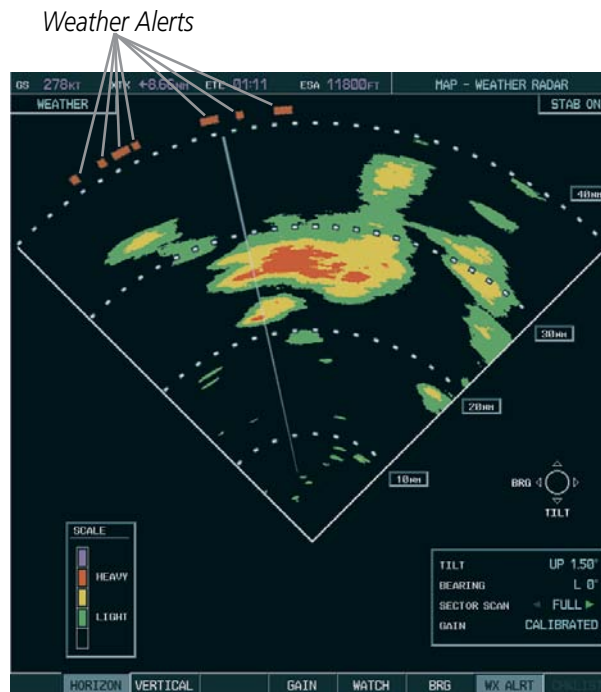

Figure 6-112 Weather Alert Indications

To activate or deactivate Weather Alerts, select the **WX ALRT** Softkey. Activating and deactivating also enables or inhibits the alert on the PFD.

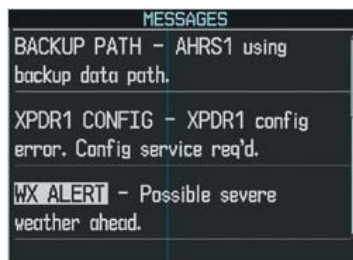

Figure 6-113 Weather Alert on PFD

GROUND MAPPING AND INTERPRETATION

A secondary use of the weather radar system is for the presentation of terrain. This can be a useful tool for verifying aircraft position. A picture of the ground is represented much like a topographical map that can be used as a supplement to the navigation map on the MFD.

Ground Map mode uses a different gain range than Weather mode. Different colors are also used to represent the intensity levels. The displayed intensity of ground target returns are defined in the table below. Use of the **GAIN** and **TILT** controls helps improve contrast so that specific ground targets can be recognized more easily. As previously discussed, the type and orientation of the target in relation to the aircraft affects the intensity displayed.

When the weather radar system is in either the Weather or Ground Map mode, the system automatically switches to Standby mode upon landing.

Ground Map Mode Color	Intensity
Black	0 dB
Light blue	> 0 dB to < 9 dB
Yellow	9 dB to < 18 dB
Magenta	18 dB to < 27 dB
Blue	27 dB and greater

Table 6-11 Ground Target Return Intensity Levels

Operation in Ground Map Mode

- 1) Select the **MODE** Softkey.
- 2) Select the **GROUND** Softkey to place the radar in Ground Map mode.
- 3) Select the **BACK** Softkey.
- 4) Press the **FMS** Knob to activate the cursor.
- 5) Turn the large **FMS** Knob to place the cursor in the TILT field.
- 6) Adjust the antenna tilt angle by turning the small **FMS** Knob to display ground returns at the desired distance.
- 7) Press the **FMS** Knob to remove the cursor.

6.4 STORMSCOPE

 **NOTE:** The L-3 STORMSCOPE® WX-500 Lightning detection system is not intended for hazardous thunderstorm penetration. Weather information on the G1000 MFD is approved for weather avoidance only. Refer to the WX-500 User’s Guide for a detailed description of Stormscope operation.

 **NOTE:** Stormscope lightning data cannot be displayed at the same time as XM WX lightning data or GFDS lightning data.

The following pages can display Stormscope data:

- PFD Inset Map
- Stormscope Page
- Navigation Map
- AUX - Trip Planning Page
- Nearest Pages

The Map - Stormscope Page is the principal page for viewing Stormscope data. Stormscope data can be displayed on other map pages as an additional reference. To display Stormscope data on any map besides the Stormscope Page, select the **MAP** Softkey (or the **INSET** Softkey for the PFD Inset Map), then select the **STRMSCP** Softkey. These pages can also display cell or strike data using the yellow lightning strike symbology shown in Table 6-12.





Lightning Age	Symbol
Strike is less than 6 seconds old	
Strike is between 6 and 60 seconds old	
Strike is between 1 and 2 minutes old	
Strike is between 2 and 3 minutes old	

Table 6-12 Lightning Age and Symbols

SETTING UP STORMSCOPE ON THE NAVIGATION MAP

Setting up Stormscope options on the Navigation Map:

- 1) On the Navigation Map Page, press the **MENU** Key.
- 2) With 'Map Setup' selected (Figure 6-114), press the **ENT** Key.
- 3) Turn the small **FMS** Knob to display the group selection window. Turn the small **FMS** Knob to select 'Weather', and press the **ENT** Key.
- 4) Turn the large **FMS** Knob to highlight and move between the product selections.
- 5) When an item is highlighted, turn the small **FMS** Knob to select the option.
- 6) Press the **ENT** Key.
- 7) Press the **FMS** Knob to return to the Navigation Map Page (Figure 6-116).

The following Stormscope options are available (Figure 6-115):

- **STRMSCP LTNG** – Turns the display of Stormscope data on or off.
- **STRMSCP MODE** – Selects the CELL or STRIKE mode of lightning activity. Cell mode identifies clusters or cells of electrical activity. Strike mode indicates the approximate location of lightning strikes.
- **STRMSCP SMBL** – Selects the range at which Stormscope data displays. Stormscope data is removed when a map range greater than the STRMSCP SMBL value is selected.



Figure 6-114 Page Menu

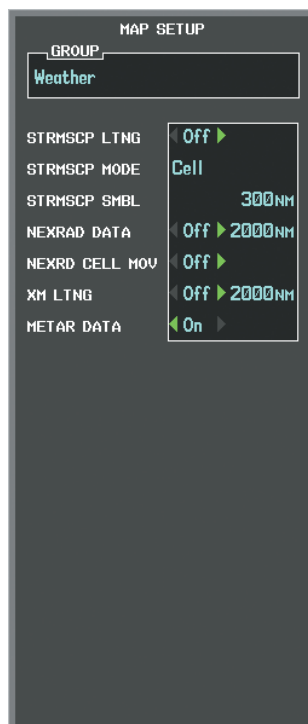

Figure 6-115 Map Setup Menu

CELL AND STRIKE MODE ON THE NAVIGATION MAP

On the Navigation Map, cell mode identifies cells of lightning activity (Figure 6-116). Stormscope identifies clusters of electrical activity that indicate cells. Strike mode indicates the approximate location of lightning strikes.

Selecting the 'cell' or 'strike' mode on the Navigation Map:

- 1) Press the **MENU** Key.
- 2) With 'Map Setup' selected, press the **ENT** Key.
- 3) Select the 'Weather' group.
- 4) Press the **ENT** Key. The cursor flashes on 'STRMSCP LTNG'.
- 5) Turn the large **FMS** Knob to select 'STRMSCP MODE'.
- 6) Turn the small **FMS** Knob to change between 'CELL' and 'STRIKE' options. When an item is selected, press the **ENT** Key.
- 7) Press the **FMS** knob to return to the Navigation Map Page.

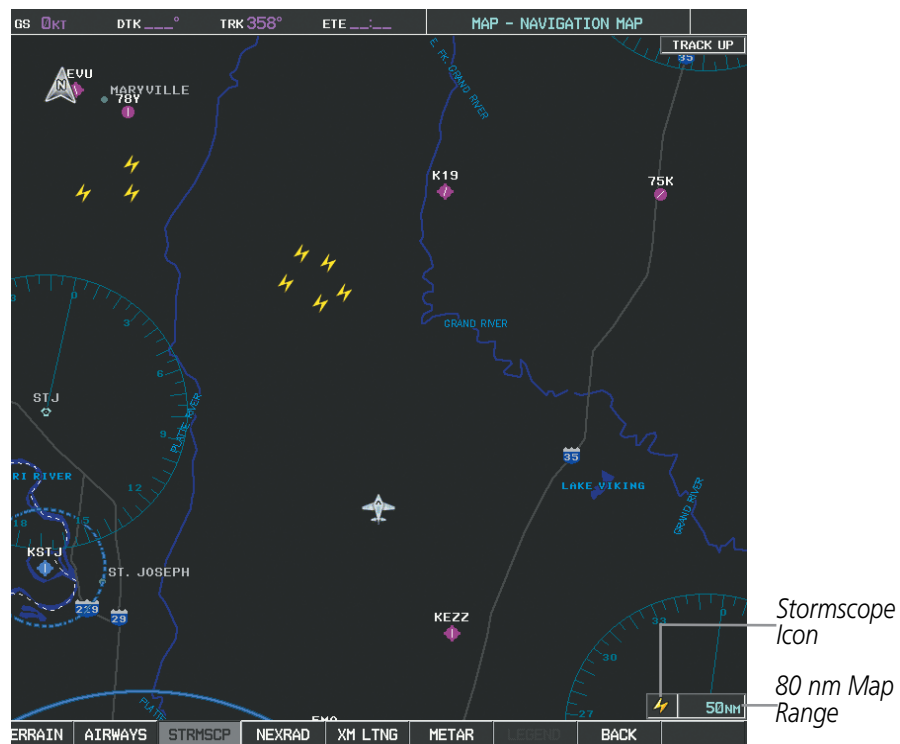

Figure 6-116 Navigation Map Page with Stormscope Lightning Data

If heading input is lost, strikes and/or cells must be cleared manually after the execution of each turn. This is to ensure that the strike and/or cell positions are depicted accurately in relation to the nose of the aircraft.

Manually clearing Stormscope data on the Navigation Map:

- 1) Press the **MENU** Key.
- 2) Select 'Clear Stormscope® Lightning' (Figure 6-117).
- 3) Press the **ENT** Key.

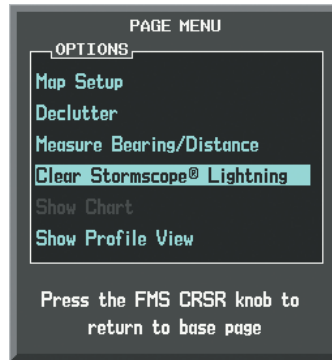

Figure 6-117 Navigation Map Page Options Menu

ZOOM RANGE ON THE NAVIGATION MAP

Stormscope lightning data can be displayed up to 800 nm zoom range (in North Up orientation) on the Navigation Map Page. However, in Track Up orientation at the 500 nm range, a portion of Stormscope lightning data can be behind the aircraft and therefore not visible on the Navigation Map. Since the range for Stormscope data is 400 nm diameter total (200 nm in front and 200 nm behind), the 500 nm range in North Up orientation shows all the data.

At a map range of less than 25 nm, Stormscope lightning data is not displayed, but can still be present.

The maximum zoom range can also be set on the Navigation Map. Note that Stormscope data above the selected maximum zoom range is decluttered.

Selecting a Stormscope range on the Navigation Map:

- 1) Press the **MENU** Key.
- 2) Select 'MAP SETUP'.
- 3) Select the 'Weather' group.
- 4) Press the **ENT** Key.
- 5) Turn the large **FMS** Knob to select 'STRMSCP SMBOL'.
- 6) Turn the small **FMS** Knob to select the maximum display range.
- 7) Press the **ENT** Key.
- 8) Press the **FMS** Knob to return to the Navigation Map Page.

To change the display range on the Navigation Map Page, turn the **RANGE** Knob clockwise to zoom out or counter-clockwise to zoom in.

SELECTING THE STORMSCOPE PAGE

Stormscope lightning data can be displayed at the ranges of 25 nm, 50 nm, 100 nm, and 200 nm.

Adjusting the Stormscope Map Range:

- 1) Turn the large **FMS** Knob to select the Map Page Group.
- 2) Turn the small **FMS** Knob to select the Stormscope Page.
- 3) To change the map range, turn the **RANGE** Knob clockwise to zoom out or counter-clockwise to zoom in.



Figure 6-118 Stormscope Page

Changing between 'cell' and 'strike' mode:

- 1) Select the Stormscope Page.
- 2) Select the **MODE** Softkey. The **CELL** and **STRIKE** softkeys are displayed.
- 3) Select the **CELL** Softkey to display 'CELL' data or select the **STRIKE** Softkey to display 'STRIKE' data. 'CELL' or 'STRIKE' is displayed in the mode box in the upper left corner of the Stormscope Page.
- 4) Select the **BACK** Softkey to return to the Stormscope Page.

Or:

- 1) Select the Stormscope Page.
- 2) Press the **MENU** Key.
- 3) Turn the small **FMS** Knob to choose between 'CELL' and 'STRIKE' options.
- 4) When an item is selected, press the **ENT** Key.

If heading input is lost, strikes and/or cells must be cleared manually after the execution of each turn (Figure 6-119). This is to ensure that the strike and/or cell positions are depicted accurately in relation to the nose of the aircraft.

Manually clearing Stormscope data:

- 1) Select the Stormscope Page.
- 2) Press the **MENU** Key.
- 3) Select 'Clear Lightning Data'.
- 4) Press the **ENT** Key.

Or:

- 1) Select the Stormscope Page.
- 2) Select the **CLEAR** Softkey.

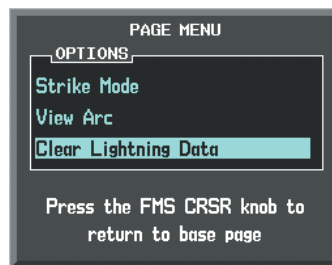

Figure 6-119 Stormscope Page Options Menu

Changing the viewing mode between 360° and 120°:

- 1) Select the Stormscope Page.
- 2) Select the **VIEW** Softkey. The **360** and **ARC** softkeys are displayed.
- 3) Select the **360** Softkey to display a 360° viewing area or select the **ARC** Softkey to display a 120° viewing area.
- 4) Select the **BACK** Softkey to return to the Stormscope Page.

Or:

- 1) Select the Stormscope Page.
- 2) Press the **MENU** Key.
- 3) Turn the small **FMS** Knob to choose between 'View Arc' and 'View 360°' options.
- 4) When an item is selected, press the **ENT** Key.

6.5 TERRAIN PROXIMITY



WARNING: Do not use Terrain Proximity information for primary terrain avoidance. Terrain Proximity is intended only to enhance situational awareness.



NOTE: Terrain data is not displayed when the aircraft is outside of the terrain database coverage area.



NOTE: Terrain Proximity is disabled when the Terrain-SVS or TAWS-B options are installed.

G1000 Terrain Proximity is a terrain awareness system that does not comply with TSO-C151b certification standards. It increases situational awareness and aids in reducing controlled flight into terrain (CFIT). Do not confuse Terrain Proximity with Terrain Awareness and Warning System (TAWS). TAWS is more sophisticated and robust, and it is TSO-C151b certified. Terrain Proximity does not provide warning annunciations or voice alerts. It only provides color indications on map displays when terrain and obstacles are within a certain altitude threshold from the aircraft. Although the terrain and obstacle color map displays are the same, TAWS uses more sophisticated algorithms to assess aircraft distance from terrain and obstacles.

Terrain Proximity requires the following components to operate properly:

- Valid 3-D GPS position
- Valid terrain/obstacle database

Terrain Proximity displays altitudes of terrain and obstructions relative to the aircraft position and altitude with reference to a database that may contain inaccuracies. Terrain and obstructions are shown only if they are in the database. Terrain and obstacle information should be used as an aid to situational awareness. They should never be used to navigate or maneuver around terrain.

Note that all obstructions may not be available in the terrain and obstacle database. No terrain and obstacle information is shown without a valid 3-D GPS position.

The G1000 GPS receiver provides the horizontal position and altitude. GPS altitude is derived from satellite position. GPS altitude is then converted to the height above geodetic sea level (GSL), which is the height above mean sea level calculated geometrically. GSL altitude is used to determine terrain and obstacle proximity. GSL altitude accuracy is affected by satellite geometry, but is not subject to variations in pressure and temperature that normally affect pressure altitude sensors. GSL altitude does not require local altimeter settings to determine MSL altitude. It is a widely-used MSL altitude source.

Terrain and obstacle databases are referenced to GSL. Using the GPS position and altitude, the Terrain Proximity feature portrays a 2-D picture of the surrounding terrain and obstacles relative to the position and altitude of the aircraft. GPS position and GSL altitude are used to calculate and predict the aircraft's flight path in relation to the surrounding terrain and obstacles. In this way, the pilot can view predicted dangerous terrain and obstacle conditions.

DISPLAYING TERRAIN PROXIMITY DATA

The Map - Terrain Proximity Page is the principal page for viewing terrain and obstacle information. The symbols and colors in the figure and table below are used to represent obstacles and aircraft altitude when the Terrain Proximity Page is selected for display. Terrain Proximity uses black, yellow, and red to represent terrain information relative to aircraft altitude. The color of each obstacle is associated with the altitude of the aircraft.

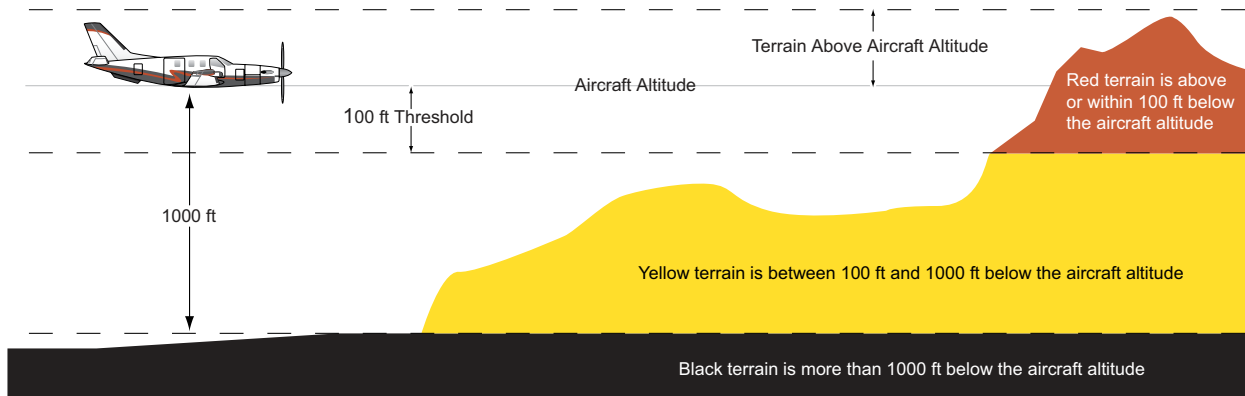

Figure 6-120 Terrain Altitude/Color Correlation for Terrain Proximity

Unlighted Obstacle		Lighted Obstacle		Obstacle Location
< 1000' AGL	> 1000' AGL	< 1000' AGL	> 1000' AGL	
				Red obstacle is above or within 100 ft below the aircraft altitude
				Yellow obstacle is between 100 ft and 1000 ft below the aircraft altitude

Table 6-13 Terrain Proximity Terrain/Obstacle Colors and Symbology

Terrain and obstacle information can be displayed on the following pages:

- PFD Inset Map
- Navigation Map Page
- Terrain Proximity Page
- Trip Planning Page
- Flight Plan Page

Displaying terrain and obstacle information (maps other than the Terrain Proximity Page):

- 1) Select the **MAP** Softkey (for the PFD Inset Map, select the **INSET** Softkey).
- 2) Select the **TERRAIN** Softkey to display terrain and obstacle data.

When Terrain Proximity is selected on maps other than the Terrain Proximity Page, an icon to indicate the feature is enabled for display and a legend for Terrain Proximity colors are shown (Figure 6-124).

The Navigation Map Page Setup Menu provides a means in addition to the softkey for enabling/disabling display of terrain and obstacles. The setup menu also controls the map range settings above which terrain and obstacle data are decluttered from the display. If a map range larger than the map range setting is selected, the data is removed from the map.

Terrain data can be selected for display independently of obstacle data; however, obstacles recognized by Terrain Proximity as yellow or red are shown when terrain is selected for display and the map range is within the setting limit.

Maps besides the Terrain Proximity Page use settings based on those selected for the Navigation Map Page. The maximum display ranges for obstacles on each map are dependent on the range setting made for the Navigation Map. If the maximum range for obstacle display on the Navigation Map is adjusted to below 20 nm, the highest obstacle display range settings on the other applicable maps are also adjusted proportionally.

Customizing terrain and obstacle display on the Navigation Map Page:

- 1) Select the Navigation Map Page.
- 2) Press the **MENU** Key.
- 3) With 'Map Setup' highlighted, press the **ENT** Key (Figure 6-121).
- 4) Turn the small **FMS** Knob to select the 'Map' Group and press the **ENT** Key (Figure 6-122).
- 5) Turn the large **FMS** Knob or press the **ENT** Key to scroll through product selections (Figure 6-123).
 - TERRAIN DATA – Turns the display of terrain data on or off and sets maximum range at which terrain is shown
 - OBSTACLE DATA – Turns the display of obstacle data on or off and sets maximum range at which obstacles are shown
- 6) Turn the small **FMS** Knob to scroll through options for each product (ON/OFF, range settings).
- 7) Press the **ENT** Key to select an option.
- 8) Press the **FMS** Knob or **CLR** Key to return to the Navigation Map Page with the changed settings.

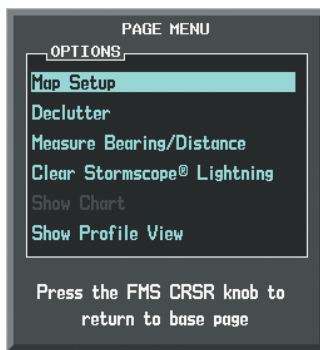

Figure 6-121 Navigation Map Page Menu

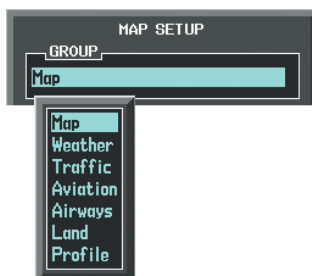

Figure 6-122 Navigation Map Page Setup Menu

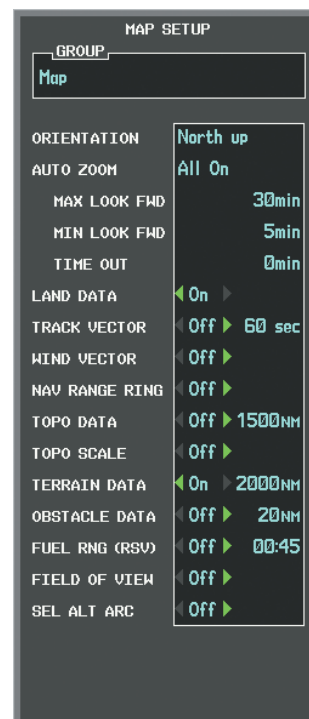

Figure 6-123 Navigation Map Page Setup Menu, Map Group

Additional information about obstacles can be displayed by panning over the display on the map. The map panning feature is enabled by pressing the **RANGE** Knob. The map range is adjusted by turning the **RANGE** Knob. If the map range is adjusted while panning is enabled, the map is re-centered on the Map Pointer.

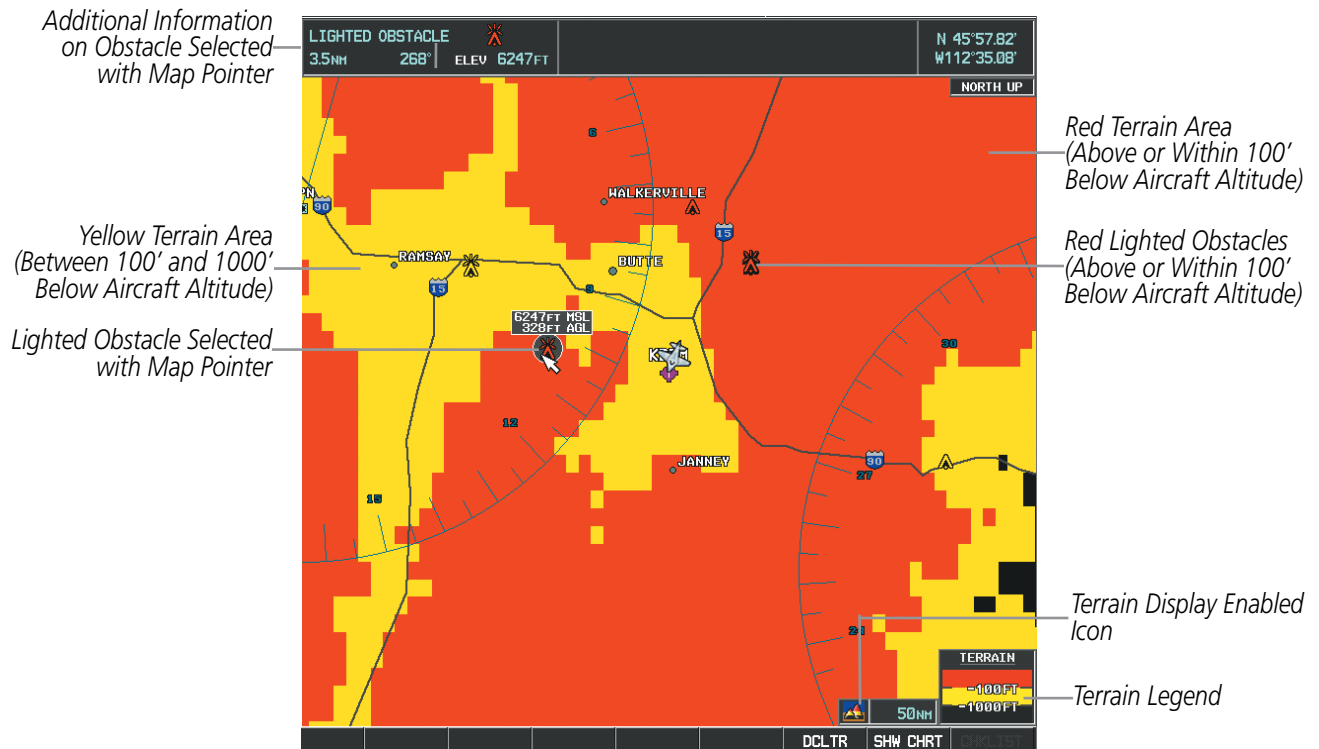

Figure 6-124 Terrain Information on the Navigation Map Page

TERRAIN PROXIMITY PAGE

The Map - Terrain Proximity Page is the principal page for showing terrain and obstacle data in relation to the aircraft's current altitude, without clutter from the basemap. Aviation data (airports, VORs, and other NAVAIDs) can be displayed for reference.

Aircraft orientation on this map is always heading up unless there is no valid heading. Two views are available relative to the position of the aircraft: the 360° default display and the radar-like ARC (120°) display. Map range is adjustable with the **RANGE** Knob from 1 to 200 nm, as indicated by the map range rings (or arcs).

Displaying the Terrain Proximity Page:

- 1) Turn the large **FMS** Knob to select the Map Page Group.
 - 2) Turn the small **FMS** Knob to select the Terrain Proximity Page.
 - 3) To change the view,
 - a) Select the **VIEW** Softkey.
 - b) Select the **360** or **ARC** Softkey to select the desired view.
- Or:**
- a) Press the **MENU** Key.
 - b) Select 'View Arc' or 'View 360°' (choice dependent on current state) and press the **ENT** Key to change the view.

Showing/hiding aviation information on the Terrain Proximity Page:

- 1) Press the **MENU** Key.
- 2) Select 'Show Aviation Data' or 'Hide Aviation Data' (choice dependent on current state) and press the **ENT** Key.

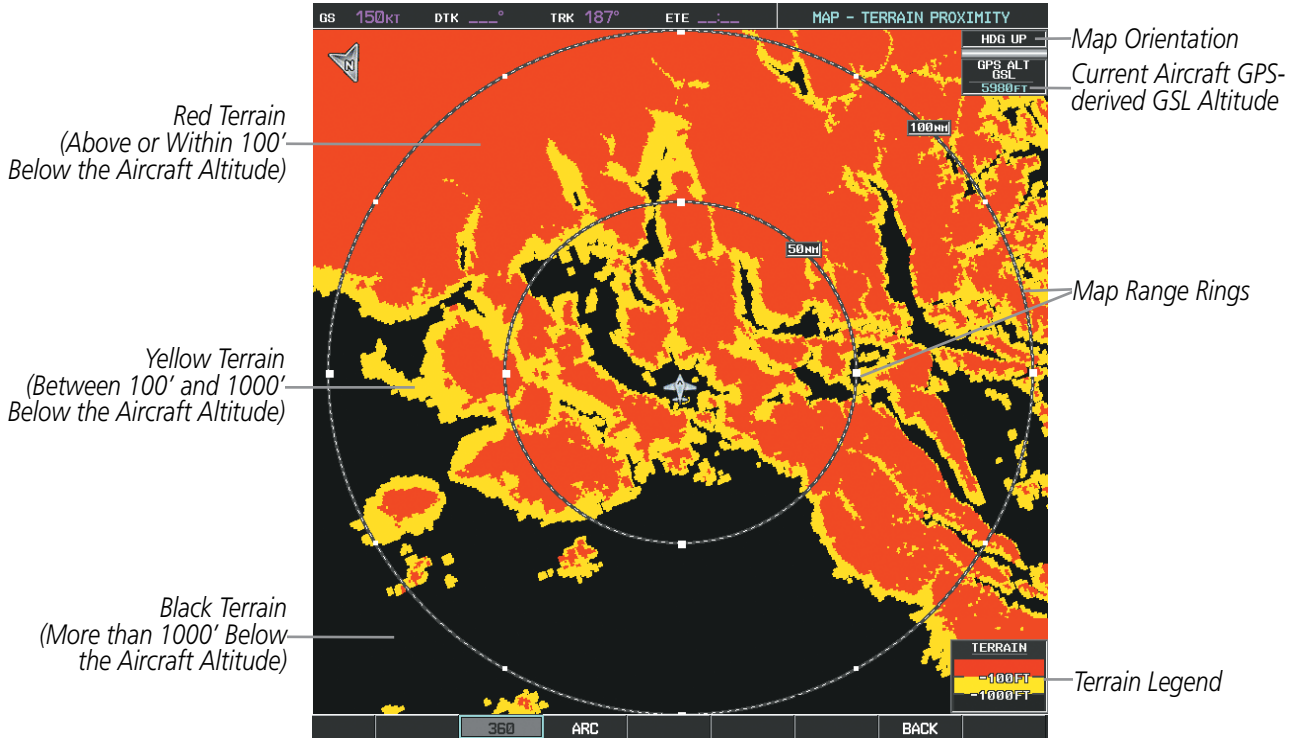

Figure 6-125 Terrain Proximity Page

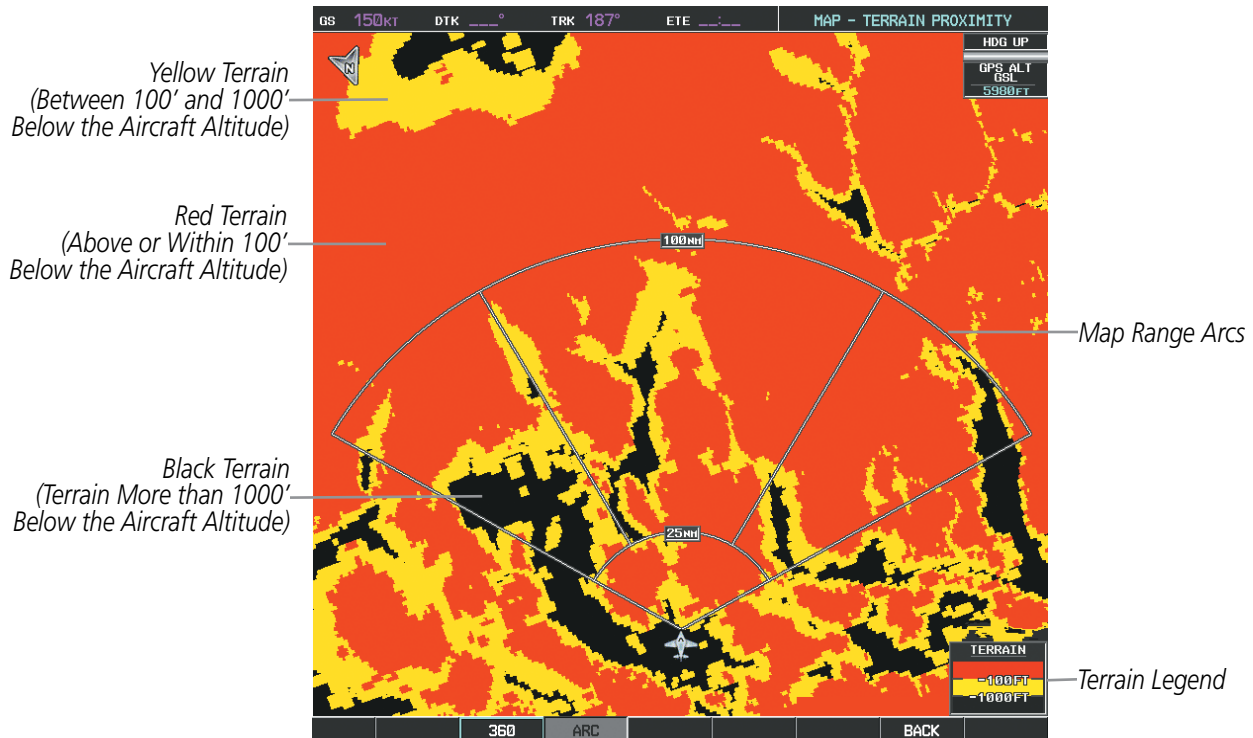

Figure 6-126 Terrain Proximity Page (ARC View)

6.6 TERRAIN-SVS



WARNING: Do not use Terrain-SVS information for primary terrain avoidance. Terrain-SVS is intended only to enhance situational awareness.



NOTE: Terrain data is not displayed if the aircraft is outside of the terrain database coverage area.



NOTE: Terrain-SVS is standard when the Synthetic Vision System (SVS) option is installed. The TAWS-B option will take precedence over the Terrain-SVS and Terrain Proximity features.

G1000 Terrain-SVS is a terrain awareness system available with the Synthetic Vision System (SVS). SVS functionality is offered as an optional enhancement. Optional Terrain Awareness and Warning System - Class B (TAWS-B) or standard Terrain-SVS is integrated within SVS to provide visual and auditory alerts to indicate the presence of threatening terrain relevant to the projected flight path. For detailed information regarding SVS, refer to the Synthetic Vision System (SVS) section of the G1000 Pilot's Guide.

Terrain-SVS does not comply with TSO-C151b certification standards. It increases situational awareness and aids in reducing controlled flight into terrain (CFIT). Do not confuse Terrain-SVS with Terrain Awareness and Warning System (TAWS). TAWS is more sophisticated and robust, and it is TSO-C151b certified. Although the terrain and obstacle color map displays are the same, TAWS uses more sophisticated algorithms to assess aircraft distance from terrain and obstacles.

Terrain-SVS does not provide the following:

- Premature Descent Alerting (PDA)
- Excessive Descent Rate (EDR)
- Negative Climb Rate (NCR)
- Descent to 500 Feet Callout (DFC)

Terrain-SVS requires the following components to operate properly:

- Valid 3-D GPS position
- Valid terrain/obstacle database

Terrain-SVS displays altitudes of terrain and obstructions relative to the aircraft position and altitude with reference to a database that may contain inaccuracies. Terrain and obstructions are shown only if they are in the database. Terrain and obstacle information should be used as an aid to situational awareness. They should never be used to navigate or maneuver around terrain.

Note that all obstructions may not be available in the terrain and obstacle database. No terrain and obstacle information is shown without a valid 3-D GPS position.

The G1000 GPS receiver provides the horizontal position and altitude. GPS altitude is derived from satellite position. GPS altitude is then converted to the height above geodetic sea level (GSL), which is the height above mean sea level calculated geometrically. GSL altitude is used to determine terrain and obstacle proximity. GSL altitude accuracy is affected by satellite geometry, but is not subject to variations in pressure and temperature that normally affect pressure altitude sensors. GSL altitude does not require local altimeter settings to determine MSL altitude. It is a widely-used MSL altitude source.

Terrain and obstacle databases are referenced to GSL. Using the GPS position and altitude, the Terrain-SVS feature portrays a 3-D picture of the surrounding terrain and obstacles relative to the position and altitude of the aircraft. GPS position and GSL altitude are used to calculate and predict the aircraft's flight path in relation to the surrounding terrain and obstacles. In this way, the pilot can view predicted dangerous terrain and obstacle conditions.

DISPLAYING TERRAIN-SVS DATA

Terrain-SVS uses yellow (caution) and red (warning) to depict terrain and obstacles with heights greater than 200 feet above ground level, AGL. Alerts are given relative to aircraft altitude. Colors are adjusted automatically as the aircraft altitude changes. The colors and symbols shown in the figure and table below are used to represent terrain, obstacles, and potential impact points.

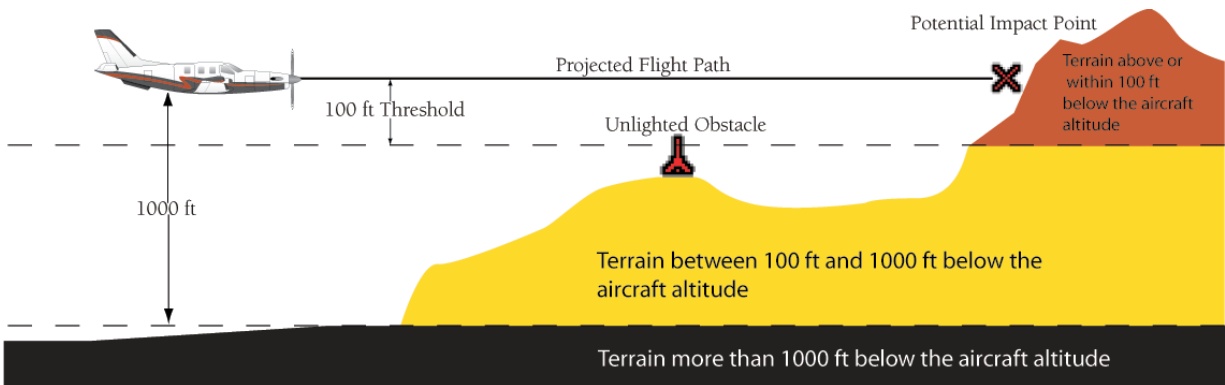

Figure 6-127 Terrain Altitude/Color Correlation for Terrain-SVS

Unlighted Obstacle		Lighted Obstacle		Obstacle Location
< 1000' AGL	> 1000' AGL	< 1000' AGL	> 1000' AGL	
				Red obstacle is above or within 100 ft below the aircraft altitude
				Yellow obstacle is between 100 ft and 1000 ft below the aircraft altitude

Table 6-14 Terrain-SVS Obstacle Colors and Symbology

Potential Impact Point Symbol	Alert Type	Example Annunciation
	Warning	
	Caution	

Table 6-15 Terrain-SVS Potential Impact Point Symbols with Alert Types

The Map - Terrain-SVS Page is the principal page for viewing terrain and obstacle information. In addition, Terrain-SVS information can be displayed on the following pages and maps for reference:

- PFD Inset Map
- Navigation Map Page
- Terrain-SVS Page
- Trip Planning Page
- Flight Plan Pages

Displaying terrain and obstacle information (maps other than the Terrain-SVS Page):

- 1) Select the **MAP** Softkey (for the PFD Inset Map, select the **INSET** Softkey).
- 2) Select the **TERRAIN** Softkey to display terrain and obstacle data.

When Terrain-SVS is selected on maps other than the Terrain-SVS Page, an icon to indicate the feature is enabled for display and a legend for Terrain-SVS terrain colors is shown. An annunciation window appears below the legend.

The Navigation Map Page Setup Menu provides a means in addition to the softkey for enabling/disabling display of terrain and obstacles. The setup menu also controls the map range settings above which terrain and obstacle data are decluttered from the display. If a map range larger than the map range setting is selected, the data is removed from the map. For terrain data, the enable/disable function applies only to the MFD, while the range setting also affects the PFD Inset Map.

Terrain data can be selected for display independently of obstacle data; however, obstacles for which warnings and cautions are issued are shown when terrain is selected for display and the map range is within the setting limit.

Maps other than the Terrain-SVS Page use settings based on those selected for the Navigation Map Page. The maximum display ranges for obstacles on each map are dependent on the range setting made for the Navigation Map. If the maximum range for obstacle display on the Navigation Map is adjusted to below 20 nm, the highest obstacle display range settings on the other applicable maps are also adjusted proportionally.

Customizing terrain and obstacle display on the Navigation Map Page:

- 1) Select the Navigation Map Page.
- 2) Press the **MENU** Key.
- 3) With Map Setup highlighted, press the **ENT** Key (Figure 6-128).
- 4) Turn the small **FMS** Knob to select the Map Group and press the **ENT** Key (Figure 6-129)
- 5) Turn the large **FMS** Knob or press the **ENT** Key to scroll through product selections (Figure 6-130).
 - TERRAIN DATA – Turns the display of terrain data on or off and sets maximum range at which terrain is shown
 - OBSTACLE DATA – Turns the display of obstacle data on or off and sets maximum range at which obstacles are shown
- 6) Turn the small **FMS** Knob to scroll through options for each product (ON/OFF, range settings).
- 7) Press the **ENT** Key to select an option.
- 8) Press the **FMS** Knob or **CLR** Key to return to the Navigation Map Page with the changed settings.

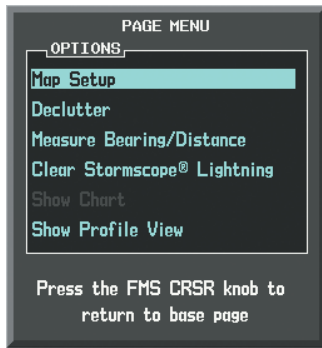

Figure 6-128 Navigation Map Page Menu



Figure 6-129 Navigation Map Page Setup Menu

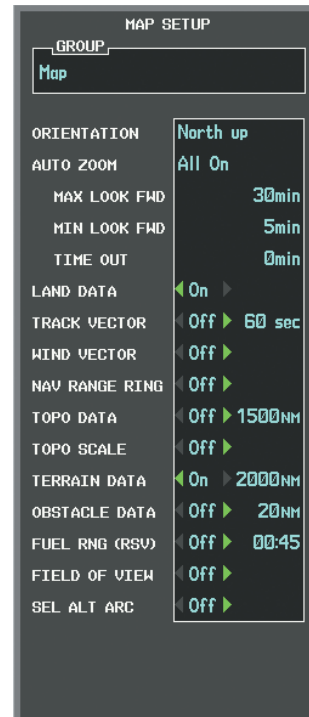

Figure 6-130 Navigation Map Page Setup Menu, Map Group

TERRAIN-SVS PAGE

The Terrain-SVS Page is specialized to show terrain, obstacle, and potential impact point data in relation to the aircraft's current altitude, without clutter from the basemap. Aviation data (airports, VORs, and other NAVAIDs) can be displayed for reference. If an obstacle and the projected flight path of the aircraft intersect, the display automatically zooms in to the closest potential point of impact on the Terrain-SVS Page.

Aircraft orientation on this map is always heading up unless there is no valid heading. Two views are available relative to the position of the aircraft; the 360° default display and the radar-like ARC (120°) display. Map range is adjustable with the **RANGE** Knob from 1 to 200 nm, as indicated by the map range rings or arcs.

Displaying the Terrain-SVS Page:

- 1) Turn the large **FMS** Knob to select the Map Page Group.
- 2) Turn the small **FMS** Knob to select the Terrain-SVS Page.

Changing the Terrain-SVS Page view:

- 1) Select the **VIEW** Softkey.
- 2) Select the **360** or **ARC** Softkey to select the desired view.

Or:

- 1) Press the **MENU** Key.
- 2) Select 'View Arc' or 'View 360°', dependent on current state, and press the **ENT** Key to change the view.

Showing/hiding aviation information on the Terrain-SVS Page:

- 1) Press the **MENU** Key.
- 2) Select 'Show Aviation Data' or 'Hide Aviation Data', dependent on current state, and press the **ENT** Key.

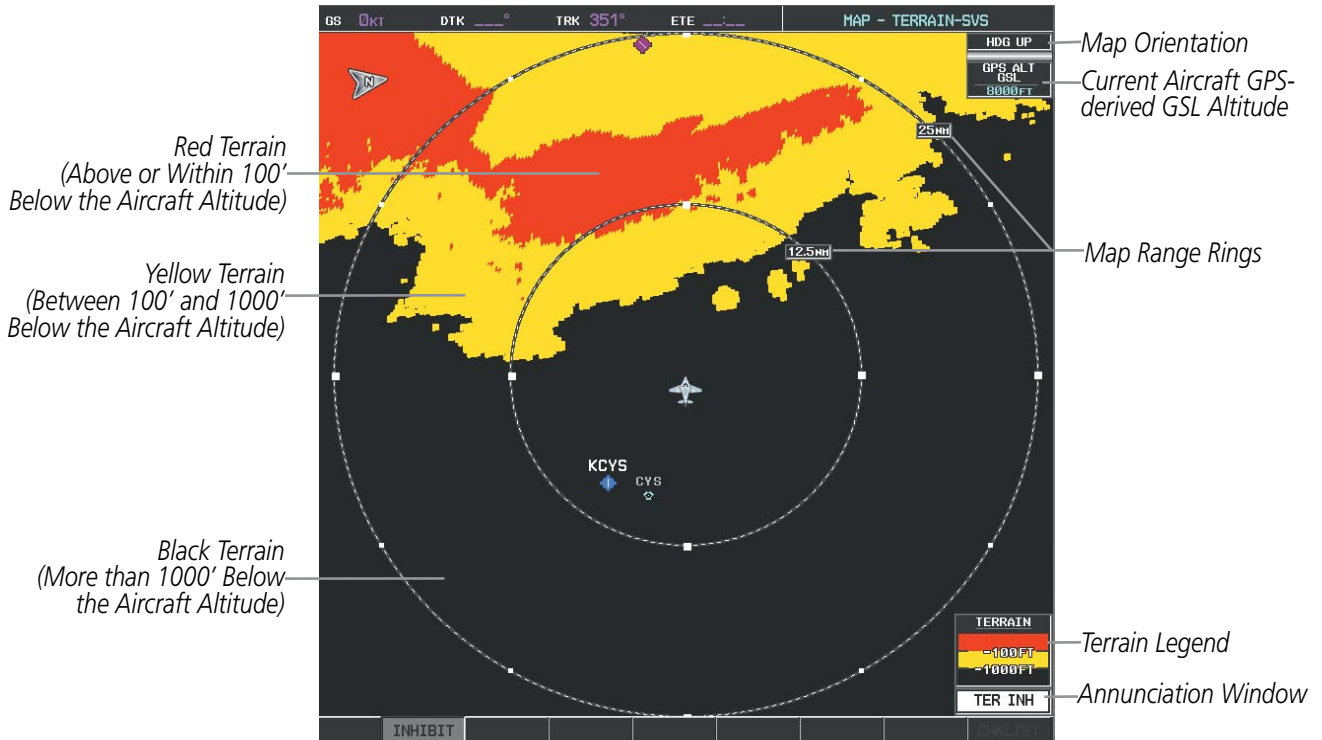

Figure 6-131 Terrain-SVS Page, 360° View

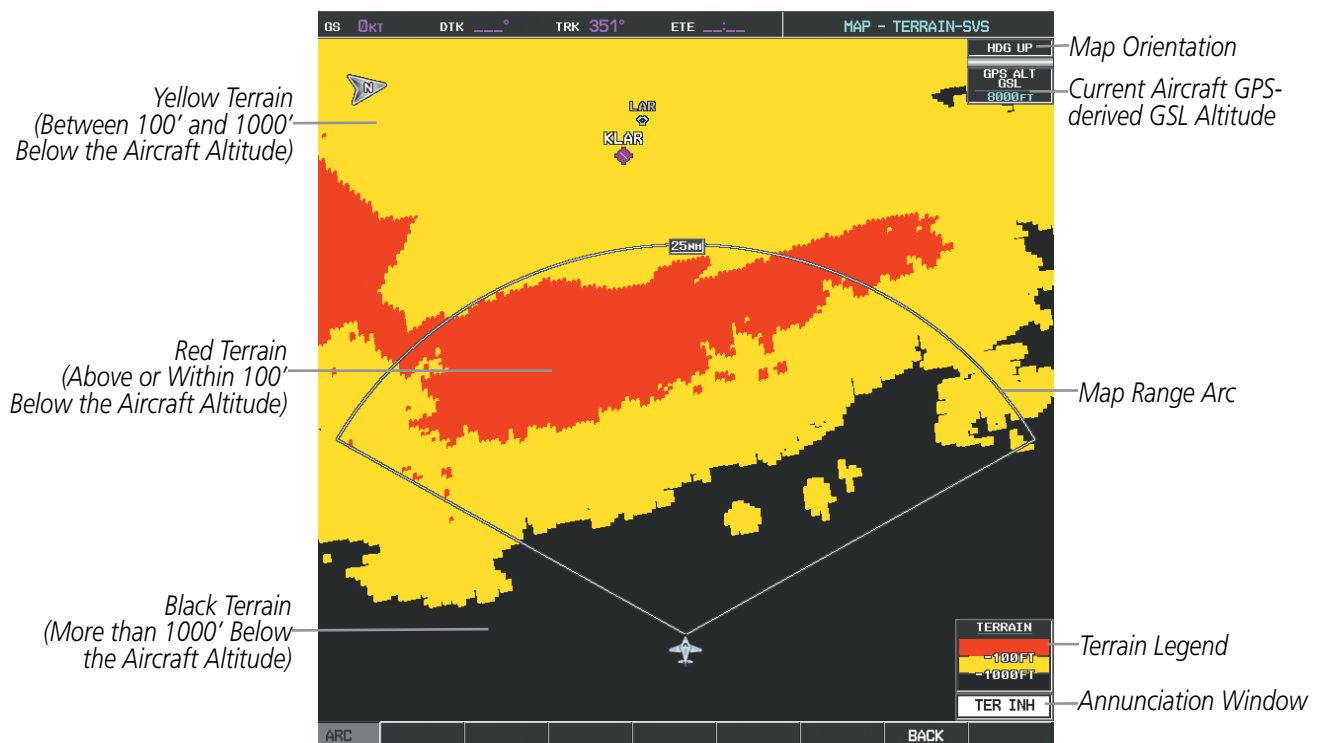

Figure 6-132 Terrain-SVS Page, ARC View

TERRAIN-SVS ALERTS

Alerts are issued when flight conditions meet parameters that are set within Terrain-SVS software algorithms. Terrain-SVS alerts typically employ a CAUTION or a WARNING alert severity level, or both. When an alert is issued, visual annunciations are displayed and aural alerts are simultaneously issued. Table 6-16 shows Terrain-SVS alert types with corresponding annunciations and aural messages.

When an alert is issued, annunciations appear on the PFD and MFD. The Terrain-SVS Alert Annunciation is shown to the upper left of the Altimeter on the PFD and below the Terrain Legend on the MFD. If the Terrain-SVS Page is not displayed at the time, a pop-up alert appears on the MFD. To acknowledge the pop-up alert:

- Press the **CLR** Key (returns to the currently viewed page), or
- Press the **ENT** Key (accesses the Terrain-SVS Page)



Figure 6-133 Alert Annunciation on the PFD

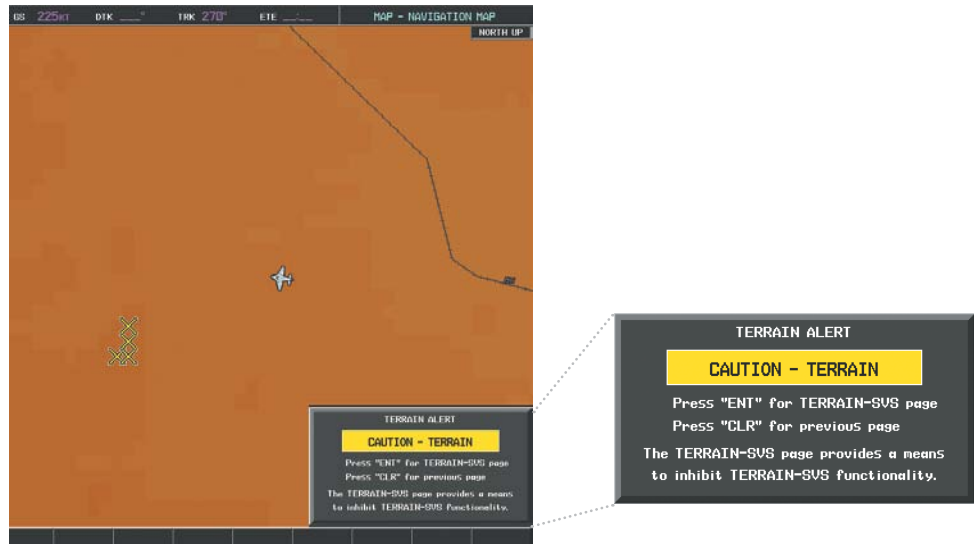

Figure 6-134 Alert Pop-up on the MFD

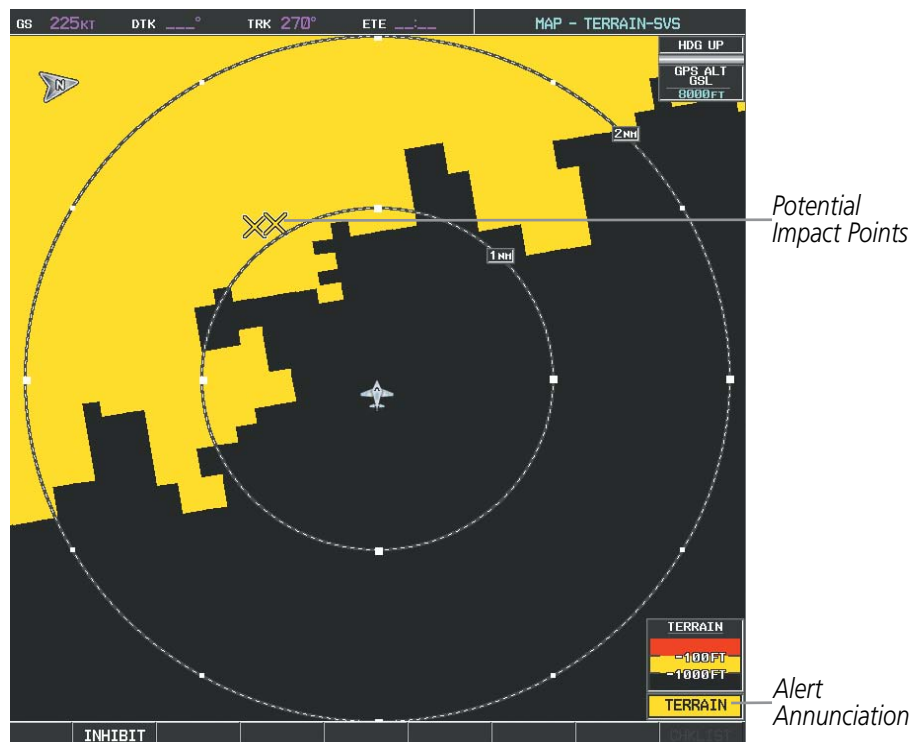

Figure 6-135 Terrain-SVS Alert Annunciation on the MFD

TERRAIN-SVS INHIBIT

Terrain-SVS aural and visual alerts can be manually inhibited. Use caution when inhibiting Terrain-SVS as the system should be enabled when appropriate. When Terrain-SVS is inhibited, the alert annunciation 'TER INH' is shown on the PFD, and on the terrain annunciation window on the MFD when terrain display is enabled.



Figure 6-136 Terrain-SVS Alerting Disabled (Terrain-SVS Inhibited) Annunciation

Inhibiting/enabling Terrain-SVS alerting:

- 1) Select the Terrain-SVS Page.
- 2) Select the **INHIBIT** Softkey to inhibit or enable Terrain-SVS (choice dependent on current state).

Or:

- a) Press the **MENU** Key.
- b) Select 'Inhibit Terrain-SVS' or 'Enable Terrain-SVS' (choice dependent on current state) and press the **ENT** Key.

If Terrain-SVS alerts are inhibited when the Final Approach Fix is the active waypoint during a GPS SBAS approach, a LOW ALT annunciation may appear on the PFD next to the altimeter if the current aircraft altitude is at least 164 feet below the prescribed altitude at the Final Approach Fix. See the Flight Instruments Section for details.

Alert Type	PFD/MFD* Alert Annunciation	MFD Pop-Up Alert (except Terrain-SVS Page)	Aural Message
Reduced Required Terrain Clearance Warning (RTC)			"Warning; Terrain, Terrain"
Imminent Terrain Impact Warning (ITI)			"Warning; Terrain, Terrain"
Reduced Required Obstacle Clearance Warning (ROC)			"Warning; Obstacle, Obstacle"
Imminent Obstacle Impact Warning (IOI)			"Warning; Obstacle, Obstacle"
Reduced Required Terrain Clearance Caution (RTC)			"Caution; Terrain, Terrain"
Imminent Terrain Impact Caution (ITI)			"Caution; Terrain, Terrain"
Reduced Required Obstacle Clearance Caution (ROC)			"Caution; Obstacle, Obstacle"
Imminent Obstacle Impact Caution (IOI)			"Caution; Obstacle, Obstacle"

* Annunciation is displayed on the MFD when terrain display is enabled.

Table 6-16 Terrain-SVS Alerts Summary

FORWARD LOOKING TERRAIN AVOIDANCE

Reduced Required Terrain Clearance (RTC) and **Reduced Required Obstacle Clearance (ROC)** alerts are issued when the aircraft flight path is above terrain, yet is projected to come within the minimum clearance values in Figure 6-137. When an RTC alert is issued, a potential impact point is displayed on the Terrain-SVS Page.

Imminent Terrain Impact (ITI) and **Imminent Obstacle Impact (IOI)** alerts are issued when the aircraft is below the elevation of a terrain or obstacle cell in the aircraft's projected path. ITI and IOI alerts are accompanied by a potential impact point displayed on the Terrain-SVS Page. The alert is annunciated when the projected vertical flight path is calculated to come within minimum clearance altitudes in Figure 6-137.

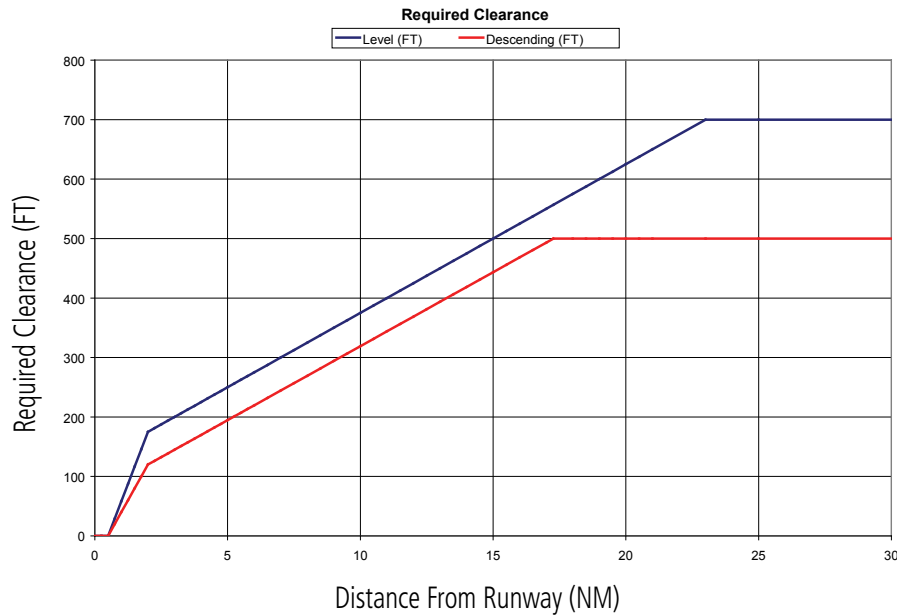

Figure 6-137 FLTA Alert Minimum Terrain and Obstacle Clearance Values

FLTA alerts are automatically inhibited when the aircraft is less than 200 feet above the destination runway elevation while within 0.5 nm of the approach runway or the aircraft is between runway ends.

SYSTEM STATUS

During power-up, Terrain-SVS conducts a self-test of its aural and visual annunciations. An aural alert is issued at test completion.

Alert Type	PFD/MFD* Alert Annunciation	Aural Message
System Test in Progress	TER TEST	None
System Test Pass	None	"Terrain System Test OK"
Terrain System Test Fail	TER FAIL	"Terrain System Failure"

* Annunciation is displayed on the MFD when terrain display is enabled.

Table 6-17 Terrain-SVS System Test Status Annunciations

Terrain-SVS continually monitors several system-critical items such as database validity, hardware status, and GPS status. If the terrain/obstacle database is not available, the aural message "**Terrain System Failure**" is generated along with the 'TER FAIL' alert annunciation.

Terrain-SVS requires a 3-D GPS navigation solution along with specific vertical accuracy minimums. Should the navigation solution become degraded or if the aircraft is out of the database coverage area, the annunciation 'TER N/A' is generated in the annunciation window and on the Terrain-SVS Page. The aural message "**Terrain System Not Available**" is generated. When the GPS signal is re-established and the aircraft is within the database coverage area, the aural message "**Terrain System Available**" is generated.

Alert Cause	PFD/MFD* Alert Annunciation	Terrain-SVS Page Center Banner Annunciation	Aural Message
MFD Terrain or Obstacle database unavailable or invalid. Terrain-SVS operating with PFD Terrain or Obstacle databases	None	TERRAIN DATABASE FAILURE	None
Terrain or Obstacle database unavailable or invalid, invalid software configuration, audio fault	TER FAIL	TERRAIN FAIL	"Terrain System Failure"
No GPS position	TER N/A	NO GPS POSITION	"Terrain System Not Available" "Terrain System Available" when GPS position returns
Excessively degraded GPS signal	TER N/A	None	"Terrain System Not Available" "Terrain System Available" when sufficient GPS signal is received
Out of database coverage area	TER N/A	None	"Terrain System Not Available" "Terrain System Available" when aircraft re-enters coverage area

* Annunciation is displayed on the MFD when terrain display is enabled.

Table 6-18 Terrain-SVS Status Annunciations

6.7 TAWS-B



WARNING: Do not use TAWS information for primary terrain avoidance. TAWS is intended only to enhance situational awareness.



NOTE: Terrain data is not displayed when the aircraft is outside of the terrain database coverage area.



NOTE: The data contained in the TAWS databases comes from government agencies. Garmin accurately processes and cross-validates the data but cannot guarantee the accuracy and completeness of the data.



NOTE: Terrain Proximity or Terrain-SVS is disabled when the TAWS-B option is installed.

TAWS-B (Terrain Awareness and Warning System - Class B) is an optional feature to increase situational awareness and aid in reducing controlled flight into terrain (CFIT). TAWS-B provides visual and aural annunciations when terrain and obstacles are within the given altitude threshold from the aircraft. The displayed alerts and warnings are advisory in nature only.

TAWS-B satisfies TSO-C151b Class B requirements for certification.

TAWS-B requires the following to operate properly:

- A valid terrain/obstacle/airport terrain database
- A valid 3-D GPS position solution

TAWS-B uses terrain and obstacle information supplied by government sources. Terrain information is based on terrain elevation information in a database that may contain inaccuracies. Individual obstructions may be shown if available in the database. The data undergoes verification by Garmin to confirm accuracy of the content, per TSO-C151b. However, the displayed information should never be understood as being all-inclusive and data may be inaccurate.

TAWS-B uses information provided from the GPS receiver to provide a horizontal position and altitude. GPS altitude is derived from satellite measurements. GPS altitude is then converted to the height above geodetic sea level (GSL), which is the height above mean sea level (MSL) calculated geometrically. GSL altitude is used to determine TAWS-B alerts. GSL altitude accuracy is affected by satellite geometry, but is not subject to variations in pressure and temperature that normally affect pressure altitude sensors. GSL altitude does not require local altimeter settings to determine MSL altitude. It is a widely-used MSL altitude source. Therefore, GSL altitude provides a highly accurate and reliable MSL altitude source to calculate terrain and obstacle alerts.

The terrain and obstacle databases used by TAWS-B are referenced to MSL. Using the GPS position and GSL altitude, TAWS-B displays a 2-D picture of the surrounding terrain and obstacles relative to the position and altitude of the aircraft. Furthermore, the GPS position and GSL altitude are used to calculate and “predict” the aircraft’s flight path in relation to the surrounding terrain and obstacles. In this manner, TAWS-B can provide advanced alerts of predicted dangerous terrain conditions.

Baro-corrected altitude (or indicated altitude) is derived by adjusting the altimeter setting for local atmospheric conditions. The most accurate baro-corrected altitude can be achieved by frequently updating the altimeter setting to the nearest reporting station along the flight path. However, because actual atmospheric conditions

seldom match the standard conditions defined by the International Standard Atmosphere (ISA) model (where pressure, temperature, and lapse rates have fixed values), it is common for the baro-corrected altitude (as read from the altimeter) to differ from the GSL altitude. This variation results in the aircraft's GSL altitude differing from the baro-corrected altitude.

DISPLAYING TAWS-B DATA

TAWS-B uses yellow (caution) and red (warning) to depict terrain and obstacles (with heights greater than 200 feet above ground level, AGL) alerts relative to aircraft altitude. Colors are adjusted automatically as the aircraft altitude changes. The colors and symbols in the figure and tables below are used to represent terrain, obstacles, and potential impact points.

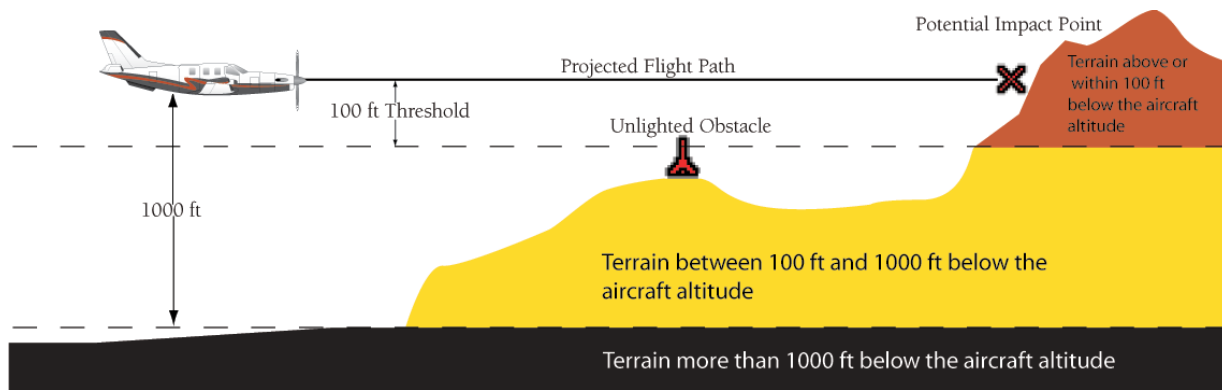

Figure 6-138 Terrain Altitude/Color Correlation for TAWS

Unlighted Obstacle		Lighted Obstacle		Obstacle Location
< 1000' AGL	> 1000' AGL	< 1000' AGL	> 1000' AGL	
				Red obstacle is above or within 100 ft below the aircraft altitude
				Yellow obstacle is between 100 ft and 1000 ft below the aircraft altitude

Table 6-19 TAWS-B Obstacle Colors and Symbology

Potential Impact Point Symbol	Alert Type	Example Annunciation
	Warning	
	Caution	

Table 6-20 TAWS-B Potential Impact Point Symbols with Alert Types

The Map - TAWS-B Page is the principal page for viewing terrain and obstacle information. TAWS-B information can also be displayed on the following pages and maps as an additional reference:

- PFD Inset Map
- Trip Planning Page
- Navigation Map Page
- Flight Plan Page

Displaying terrain and obstacle information (maps other than the TAWS-B Page):

- 1) Select the **MAP** Softkey (for the PFD Inset Map, select the **INSET** Softkey).
- 2) Select the **TERRAIN** Softkey to display terrain and obstacle data.

When TAWS-B is selected on maps other than the TAWS-B Page, an icon to indicate the feature is enabled for display and a legend with the TAWS-B terrain colors and annunciation window are shown (Figure 6-139).



Figure 6-139 TAWS-B Icon and Legend with Annunciation Window

The Navigation Map Page Setup Menu provides a means in addition to the softkey for enabling/disabling display of terrain and obstacles. The setup menu also controls the map range settings above which terrain and obstacle data are decluttered from the display. If a map range larger than the map range setting is selected, the data is removed from the map. For terrain data, the enable/disable function applies only to the MFD, while the range setting also affects the PFD Inset Map.

Terrain data can be selected for display independently of obstacle data; however, obstacles for which warnings and cautions are issued are shown when terrain is selected for display and the map range is within the setting limit.

Maps besides the TAWS-B Page use settings based on those selected for the Navigation Map Page. The maximum display ranges for obstacles on each map are dependent on the range setting made for the Navigation Map. If the maximum range for obstacle display on the Navigation Map is adjusted to below 20 nm, the highest obstacle display range settings on the other applicable maps are also adjusted proportionally.

Customizing terrain and obstacle display on the Navigation Map Page:

- 1) Select the Navigation Map Page.
- 2) Press the **MENU** Key.
- 3) With 'Map Setup' highlighted, press the **ENT** Key (Figure 6-140).
- 4) Turn the small **FMS** Knob to select the 'Map' Group and press the **ENT** Key (Figure 6-141).
- 5) Turn the large **FMS** Knob or press the **ENT** Key to scroll through product selections (Figure 6-142).

- TERRAIN DATA – Turns the display of terrain data on or off and sets maximum range at which terrain is shown
 - OBSTACLE DATA – Turns the display of obstacle data on or off and sets maximum range at which obstacles are shown
- 6) Turn the small **FMS** Knob to scroll through options for each product (ON/OFF, range settings).
 - 7) Press the **ENT** Key to select an option.
 - 8) Press the **FMS** Knob or **CLR** Key to return to the Navigation Map Page with the changed settings.

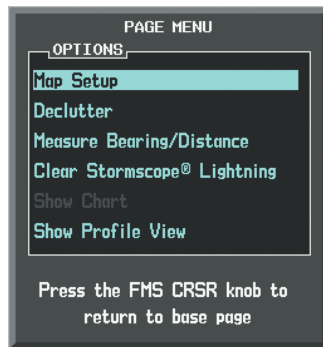

Figure 6-140 Navigation Map Page Menu



Figure 6-141 Navigation Map Page Setup Menu

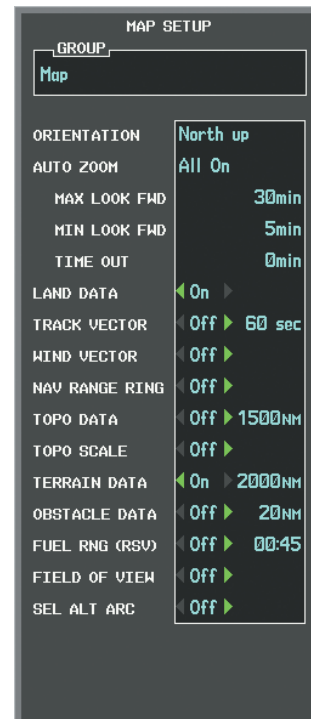

Figure 6-142 Navigation Map Page Setup Menu, Map Group

TAWS-B PAGE

The TAWS-B Page is specialized to show terrain, obstacle, and potential impact point data in relation to the aircraft's current altitude, without clutter from the basemap. Aviation data (airports, VORs, and other NAVAIDs) can be displayed for reference. If an obstacle and the projected flight path of the aircraft intersect, the display automatically zooms in to the closest potential point of impact on the TAWS-B Page.

Aircraft orientation on this map is always heading up unless there is no valid heading. Two views are available relative to the position of the aircraft: the 360° default display and the radar-like ARC (120°) display. Map range is adjustable with the **RANGE** Knob from 1 to 200 nm, as indicated by the map range rings (or arcs).

Displaying the TAWS-B Page:

- 1) Turn the large **FMS** Knob to select the Map Page Group.
- 2) Turn the small **FMS** Knob to select the TAWS-B Page.

Changing the TAWS-B Page view:

- 1) Select the **VIEW** Softkey.
- 2) Select the **360** or **ARC** Softkey to select the desired view.

Or:

- 1) Press the **MENU** Key.
- 2) Select 'View Arc' or 'View 360°' (choice dependent on current state) and press the **ENT** Key to change the view

Showing/hiding aviation information on the TAWS-B Page:

- 1) Press the **MENU** Key.
- 2) Select 'Show Aviation Data' or 'Hide Aviation Data', dependent on current state, and press the **ENT** Key.

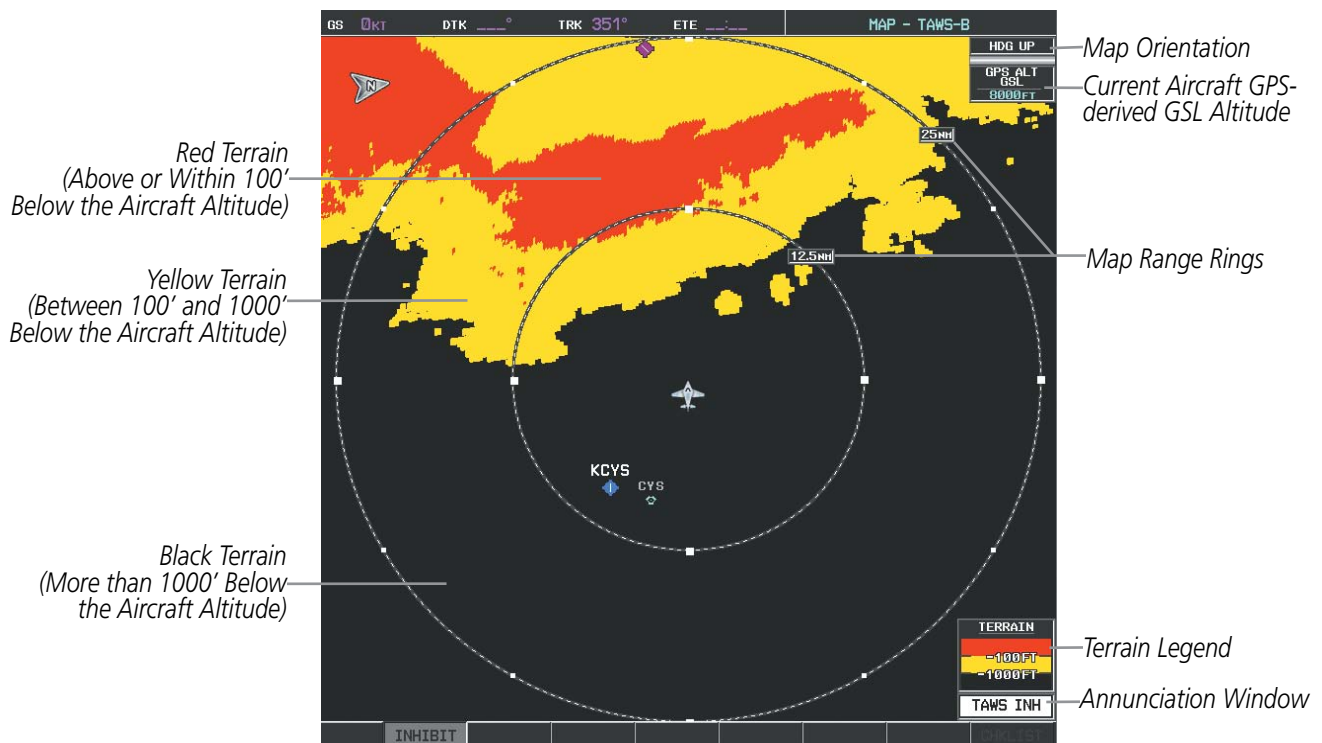

Figure 6-143 TAWS-B Page, 360° View

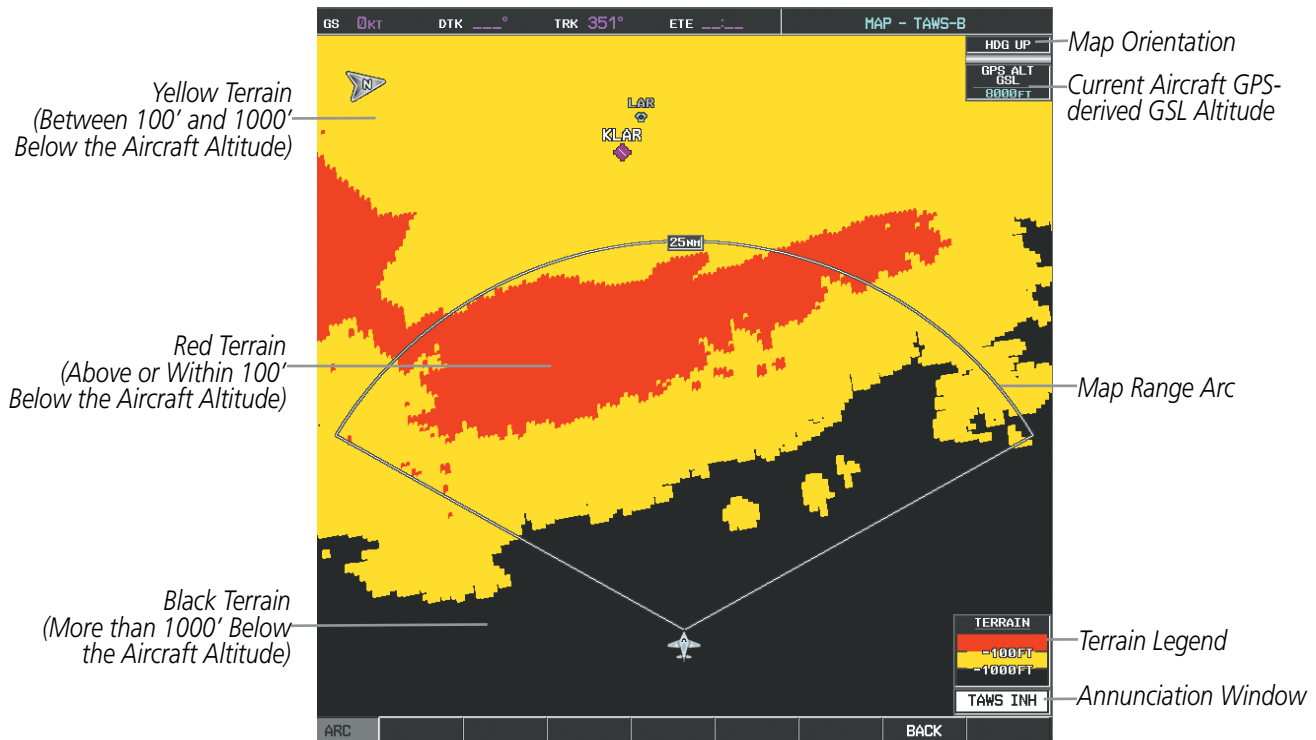

Figure 6-144 TAWS-B Page, ARC View

TAWS-B ALERTS

Alerts are issued when flight conditions meet parameters that are set within TAWS-B software algorithms. TAWS-B alerts typically employ a CAUTION or a WARNING alert severity level, or both. When an alert is issued, visual annunciations are displayed and aural alerts are simultaneously issued. Table 6-21 shows TAWS-B alert types with corresponding annunciations and aural messages.

When an alert is issued, annunciations appear on the PFD and MFD. The TAWS-B Alert Annunciation is shown to the upper left of the Altimeter on the PFD and below the Terrain Legend on the MFD. If the TAWS-B Page is not displayed at the time, a pop-up alert appears on the MFD. To acknowledge the pop-up alert:

- Press the **CLR** Key (returns to the currently viewed page), or
- Press the **ENT** Key (accesses the TAWS-B Page)

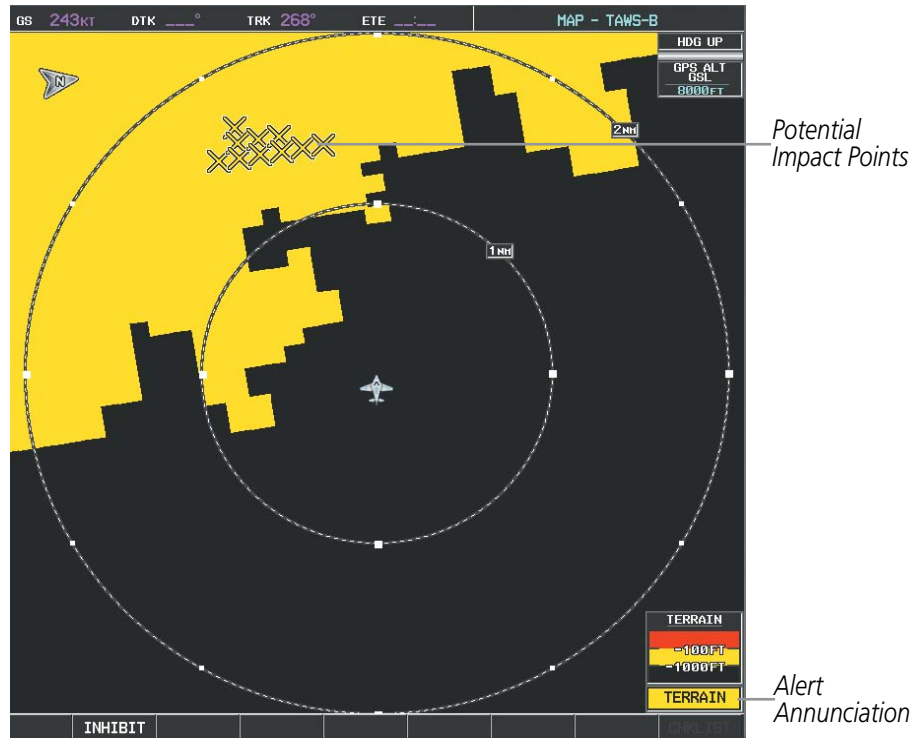

Figure 6-145 TAWS-B TERRAIN Alert Annunciation on the MFD



Figure 6-146 Alert Annunciation on the PFD

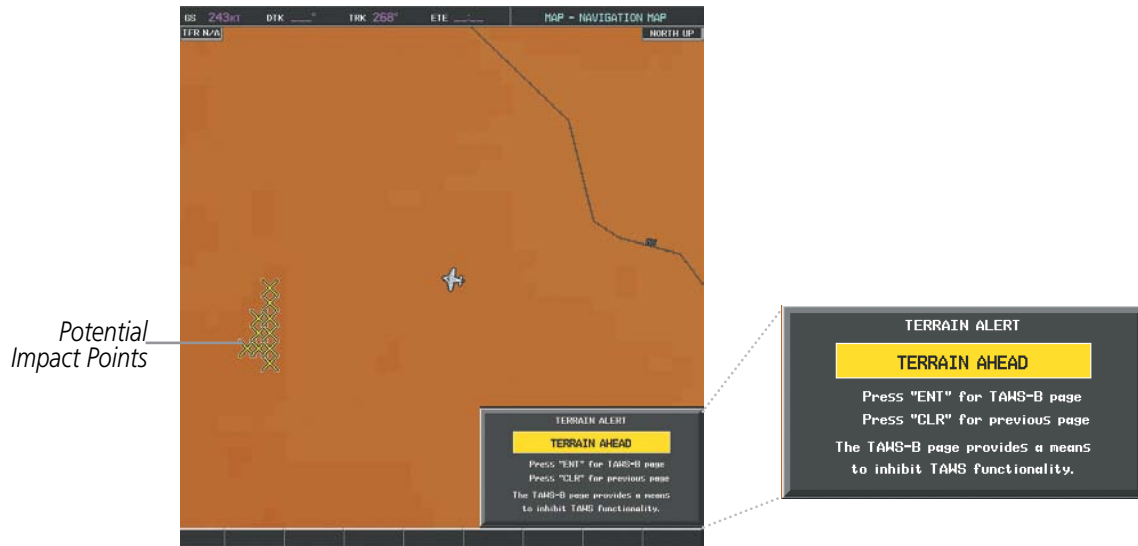

Figure 6-147 Alert Pop-up on the MFD

Alert Type	PFD/MFD** Alert Annunciation	MFD Pop-Up Alert (except TAWS-B Page)	Aural Message
Excessive Descent Rate Warning (EDR)	PULL UP	PULL-UP	"Pull Up"
Reduced Required Terrain Clearance Warning (RTC)	PULL UP	TERRAIN - PULL-UP or TERRAIN AHEAD - PULL-UP *	"Terrain, Terrain; Pull Up, Pull Up" or "Terrain Ahead, Pull Up; Terrain Ahead, Pull Up" *
Imminent Terrain Impact Warning (ITI)	PULL UP	TERRAIN - PULL-UP * or TERRAIN AHEAD - PULL-UP	"Terrain, Terrain; Pull Up, Pull Up" * or Terrain Ahead, Pull Up; Terrain Ahead, Pull Up'
Reduced Required Obstacle Clearance Warning (ROC)	PULL UP	OBSTACLE - PULL-UP or OBSTACLE AHEAD - PULL-UP *	"Obstacle, Obstacle; Pull Up, Pull Up" or "Obstacle Ahead, Pull Up; Obstacle Ahead, Pull Up" *
Imminent Obstacle Impact Warning (IOI)	PULL UP	OBSTACLE - PULL-UP * or OBSTACLE AHEAD - PULL-UP	"Obstacle, Obstacle; Pull Up, Pull Up" * or "Obstacle Ahead, Pull Up; Obstacle Ahead, Pull Up"
Reduced Required Terrain Clearance Caution (RTC)	TERRAIN	CAUTION - TERRAIN or TERRAIN AHEAD *	"Caution, Terrain; Caution, Terrain" or "Terrain Ahead; Terrain Ahead" *
Imminent Terrain Impact Caution (ITI)	TERRAIN	CAUTION - TERRAIN * or TERRAIN AHEAD	"Caution, Terrain; Caution, Terrain" * or "Terrain Ahead; Terrain Ahead"
Reduced Required Obstacle Clearance Caution (ROC)	TERRAIN	CAUTION - OBSTACLE or OBSTACLE AHEAD *	"Caution, Obstacle; Caution, Obstacle" or "Obstacle Ahead; Obstacle Ahead" *
Imminent Obstacle Impact Caution (IOI)	TERRAIN	CAUTION - OBSTACLE * or OBSTACLE AHEAD	"Caution, Obstacle; Caution, Obstacle" * or "Obstacle Ahead; Obstacle Ahead"
Premature Descent Alert Caution (PDA)	TERRAIN	TOO LOW - TERRAIN	"Too Low, Terrain"
Altitude Callout "500"	None	None	"Five-Hundred"
Excessive Descent Rate Caution (EDR)	TERRAIN	SINK RATE	"Sink Rate"
Negative Climb Rate Caution (NCR)	TERRAIN	DON'T SINK * or TOO LOW - TERRAIN	"Don't Sink" * or "Too Low, Terrain"

* Alerts with multiple messages are configurable at installation and are installation-dependent. Alerts for the default configuration when more than one option is available are indicated with asterisks.

** Annunciation is displayed on the MFD when terrain display is enabled.

Table 6-21 TAWS-B Alerts Summary

EXCESSIVE DESCENT RATE ALERT

The purpose of the **Excessive Descent Rate (EDR)** alert is to provide suitable notification when the aircraft is determined to be closing (descending) upon terrain at an excessive speed. Figure 6-148 shows the parameters for the alert as defined by TSO-C151b.

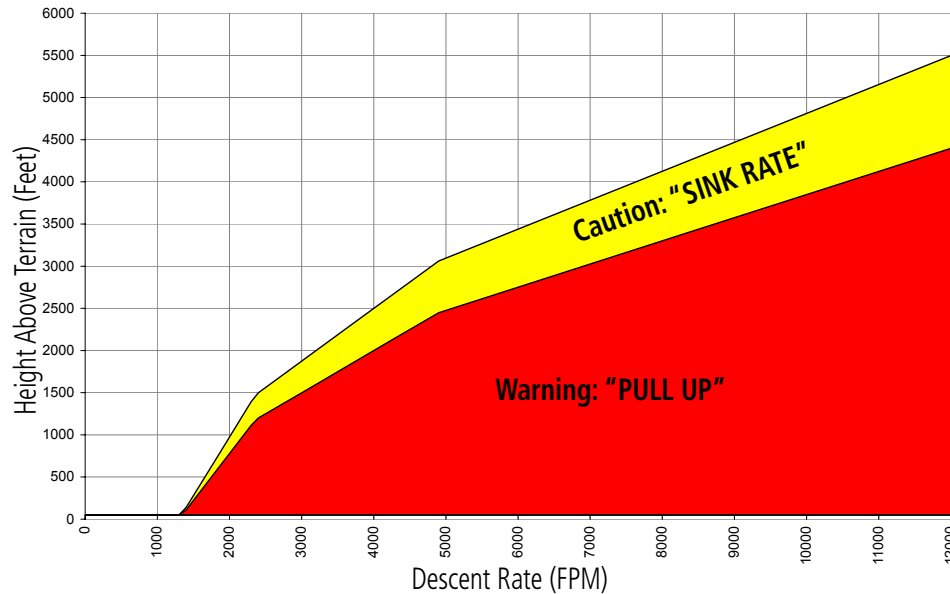

Figure 6-148 Excessive Descent Rate Alert Criteria

FORWARD LOOKING TERRAIN AVOIDANCE

Reduced Required Terrain Clearance (RTC) and **Reduced Required Obstacle Clearance (ROC)** alerts are issued when the aircraft flight path is above terrain, yet is projected to come within the minimum clearance values in Figure 6-149. When an RTC alert is issued, a potential impact point is displayed on the TAWS-B Page.

Imminent Terrain Impact (ITI) and **Imminent Obstacle Impact (IOI)** alerts are issued when the aircraft is below the elevation of a terrain or obstacle cell in the aircraft's projected path. ITI and IOI alerts are accompanied by a potential impact point displayed on the TAWS-B Page. The alert is annunciated when the projected vertical flight path is calculated to come within minimum clearance altitudes in Figure 6-149.

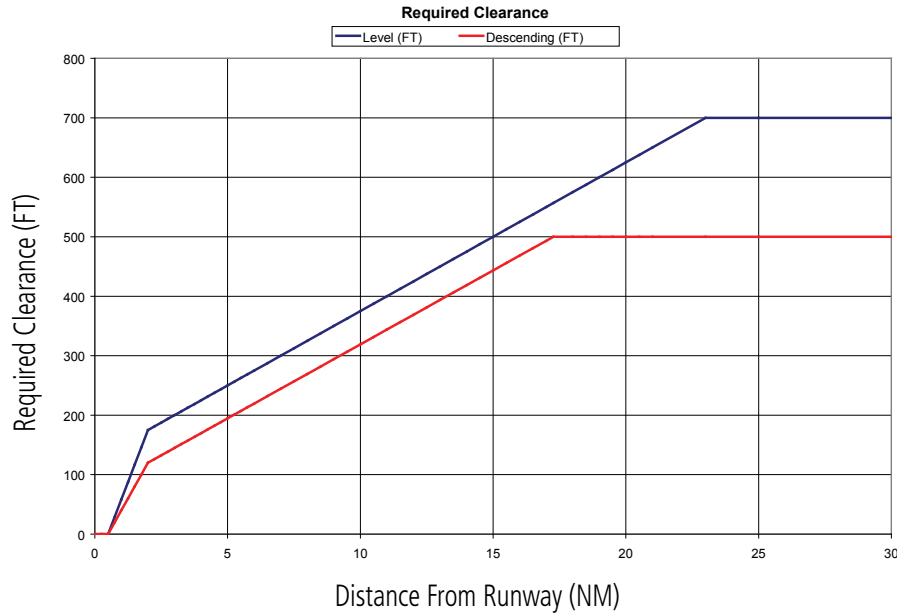

Figure 6-149 FLTA Alert Minimum Terrain and Obstacle Clearance Values

FLTA alerts are automatically inhibited when the aircraft is less than 200 feet above the destination runway elevation while within 0.5 nm of the approach runway or the aircraft is between runway ends.

PREMATURE DESCENT ALERTING

A **Premature Descent Alert (PDA)** is issued when the system detects that the aircraft is significantly below the normal approach path to a runway (Figure 6-150).

PDA alerting begins when the aircraft is below 700 feet AGL within 15 nm of the destination airport and ends when the aircraft is 0.5 nm from the runway threshold.

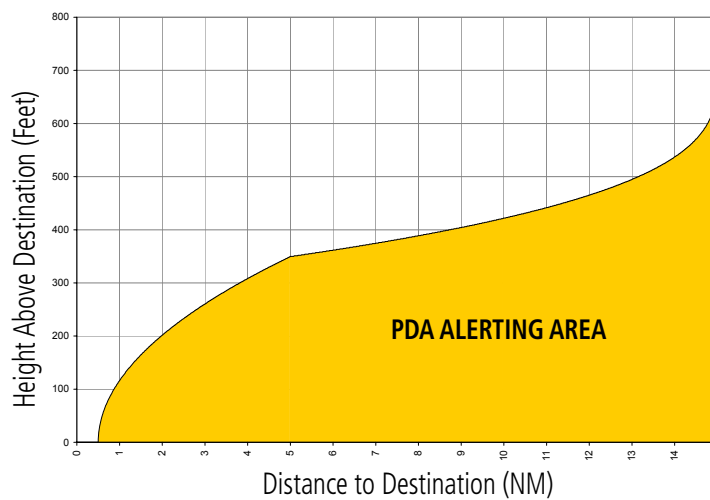

Figure 6-150 PDA Alerting Threshold

TAWS-B INHIBIT

TAWS-B PDA and FLTA aural and visual alerts can be manually inhibited. Use caution when inhibiting TAWS-B alerting as the system should be enabled when appropriate. When TAWS-B is inhibited, the alert annunciation 'TAWS INH' is shown on the PFD, and in the MFD terrain annunciation window when terrain display is enabled.

A rectangular box containing the text 'TAWS INH' in a bold, sans-serif font.

Figure 6-151 TAWS-B Alerting Disabled (TAWS-B Inhibited) Annunciation

Inhibiting/enabling TAWS-B alerting:

- 1) Select the TAWS-B Page.
- 2) Press the **MENU** Key.
- 3) Select 'Inhibit TAWS' or 'Enable TAWS', depending on the current state, and press the **ENT** Key.

Or:

Select the **INHIBIT** Softkey to inhibit TAWS.

If TAWS-B alerts are inhibited when the Final Approach Fix is the active waypoint during a GPS SBAS approach, a LOW ALT annunciation may appear on the PFD next to the altimeter if the current aircraft altitude is at least 164 feet below the prescribed altitude at the Final Approach Fix. See the Flight Instruments Section for details.

FIVE-HUNDRED AURAL ALERT

The purpose of the aural alert message “**Five-hundred**” is to provide an advisory alert of when the aircraft descends to within 500 feet above the terrain or runway threshold. When the aircraft is within 5 nm of an airport, the “**Five Hundred**” aural alert is based on the nearest runway threshold elevation. When the aircraft is more than 5 nm of the nearest airport, the “**Five Hundred**” aural alert is based on the height above terrain (as determined by the GPS altitude and Terrain Database).

There are no display annunciations or pop-up alerts that accompany the aural message.

NEGATIVE CLIMB RATE AFTER TAKEOFF ALERT (NCR)

The **Negative Climb Rate (NCR) After Takeoff** alert (also referred to as “Altitude Loss After Takeoff”) provides alerts when the system determines the aircraft is losing altitude (closing upon terrain) after takeoff. The aural message “Don’t Sink” is given for NCR alerts, accompanied by an annunciation and a pop-up terrain alert on the display. NCR alerting is only active when departing from an airport and when the following conditions are met:

- Height above the terrain is less than 700 feet
- Distance from the departure airport is 5 nm or less
- Heading change from the departure heading is less than 110 degrees

Figures 6-104 and 6-105 show the NCR alerting parameters based on Altitude Loss and Sink Rate respectively as defined by TSO-C151b.

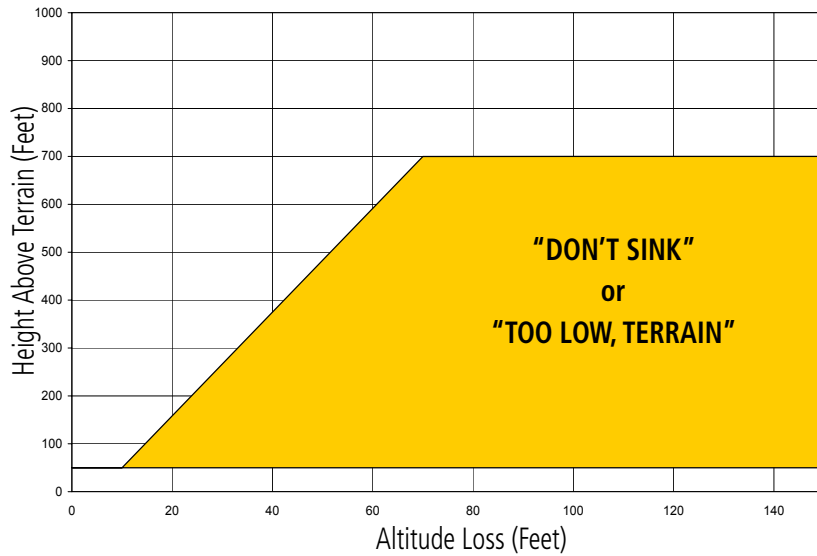

Figure 6-152 Negative Climb Rate (NCR) Altitude Loss

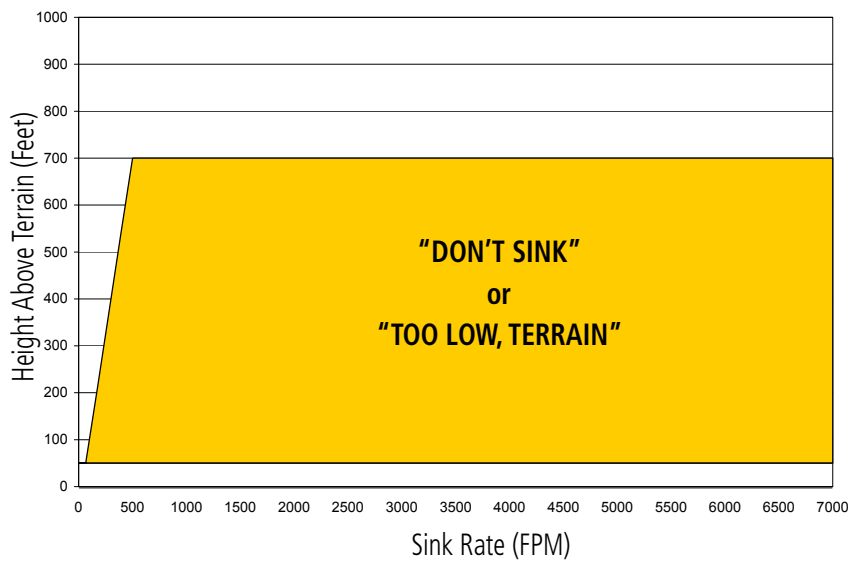

Figure 6-153 Negative Climb Rate (NCR) Sink Rate

SYSTEM STATUS

During G1000 power-up, TAWS-B conducts a self-test of its aural and visual annunciations. The system test can also be manually initiated. An aural alert is issued at test completion. TAWS-B System Testing is disabled when ground speed exceeds 30 knots.

Alert Type	PFD/MFD* Alert Annunciation	TAWS-B Page Center Banner Annunciation	Aural Message
System Test in Progress	TAWS TEST	TAWS TEST	None
System Test Pass	None	None	"TAWS System Test OK"
TAWS System Test Fail	TAWS FAIL	TAWS FAIL	"TAWS System Failure"

* Annunciation is displayed on the MFD when terrain display is enabled.

Table 6-22 TAWS-B System Test Status Annunciations

Manually testing the TAWS-B System:

- 1) Select the TAWS-B Page.
- 2) Press the **MENU** Key.
- 3) Select 'Test TAWS System' and press the **ENT** Key to confirm the selection.

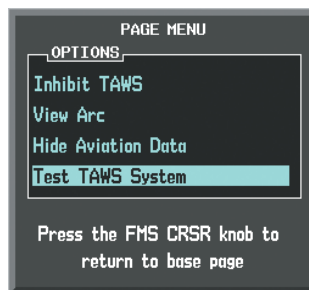

Figure 6-154 TAWS-B Page Menu

TAWS-B continually monitors several system-critical items such as database validity, hardware status, and GPS status. If the terrain/obstacle database is not available, the aural message **"TAWS System Failure"** is generated along with the 'TAWS FAIL' alert annunciation.

TAWS-B requires a 3-D GPS navigation solution along with specific vertical accuracy minimums. Should the navigation solution become degraded or if the aircraft is out of the database coverage area, the annunciation 'TAWS N/A' is generated in the annunciation window and on the TAWS-B Page. The aural message **"TAWS Not Available"** is generated. When sufficient GPS signal is returned and the aircraft is within the database coverage area, the aural message "TAWS Available" is generated.

Alert Cause	PFD/MFD* Annunciation	TAWS-B Page Annunciation Center Banner Annunciation	Aural Message
MFD Terrain or Obstacle database unavailable or invalid. TAWS-B operating with PFD Terrain or Obstacle databases	None	TERRAIN DATABASE FAILURE	None
Terrain or Obstacle database unavailable or invalid on all displays, invalid software configuration, TAWS audio fault	TAWS FAIL	TAWS FAIL	"TAWS System Failure"
No GPS position	TAWS N/A	NO GPS POSITION	"TAWS Not Available" "TAWS Available" when GPS position returns.
Excessively degraded GPS signal	TAWS N/A	None	"TAWS Not Available" "TAWS Available" when sufficient GPS signal is received.
Out of database coverage area	TAWS N/A	None	"TAWS Not Available" "TAWS Available" when aircraft re-enters database coverage area.

* Annunciation is displayed on the MFD when terrain display is enabled.

Table 6-23 TAWS-B Abnormal Conditions

6.8 PROFILE VIEW TERRAIN

The G1000 offers a Profile View of terrain and obstacles relative to the aircraft’s current flight path and altitude on the Navigation Map Page of the MFD. Profile View does not provide TAWS-B terrain or obstacle caution or warning annunciations or voice alerts systems, nor does it display potential impact points inside the Profile View. The colors and symbols in Figure 6-155 and Table 6-24 are used to represent terrain and obstacles.

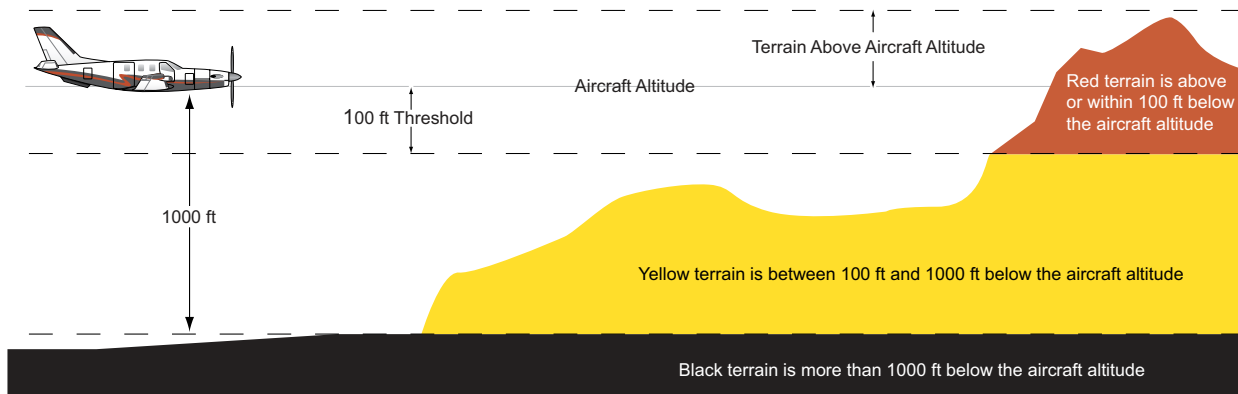

Figure 6-155 Terrain Altitude/Color Correlation for Profile View Terrain

Unlighted Obstacle		Lighted Obstacle		Obstacle Location
< 1000' AGL	> 1000' AGL	< 1000' AGL	> 1000' AGL	
				Red obstacle is above or within 100 ft below the aircraft altitude
				Yellow obstacle is between 100 ft and 1000 ft below the aircraft altitude

Table 6-24 Profile View Terrain/Obstacle Colors and Symbology

Enabling/Disabling Profile View:

- 1) Select the Navigation Map Page.
- 2) Press the **MAP** Softkey.
- 3) Press the **PROFILE** Softkey to enable or disable Profile View.

Or:

- 1) Press the **MENU** Key.
- 2) Select 'Show Profile View' or 'Hide Profile View' (choice dependent on current state) and press the **ENT** Key.

Enabling/Disabling Profile View Terrain on the Navigation Map (when Profile View is enabled):

- 1) Select the Navigation Map Page.

- 2) Press the **MAP** Softkey.
- 3) Press the **TERRAIN** Softkey.

PROFILE VIEW DISPLAY

When the Profile View is enabled, it is displayed in a window below the Navigation Map. Altitude is shown along a vertical scale, with an aircraft icon positioned at the current altitude. Distance is represented horizontally along the bottom of the Profile View, and increases from left (present position) to right.

When the Navigation Map range is adjusted with the **RANGE** Knob, the horizontal distance of the Profile View is adjusted proportionately to be 1/2 of the Navigation Map range distance down to 1 nm, at which point Profile View is no longer available ('PROFILE NOT AVAILABLE' is displayed). When Navigation Map range is adjusted to remove altitude-correlated colored terrain data (as shown in the Terrain Legend) or obstacles from the Navigation Map, these items are also removed from the Profile View; only an outline of the terrain will be displayed in black in the Profile View window. Refer to the Terrain Proximity, Terrain-SVS, or TAWS-B discussions for more information about displaying terrain or obstacles on the Navigation Map Page.

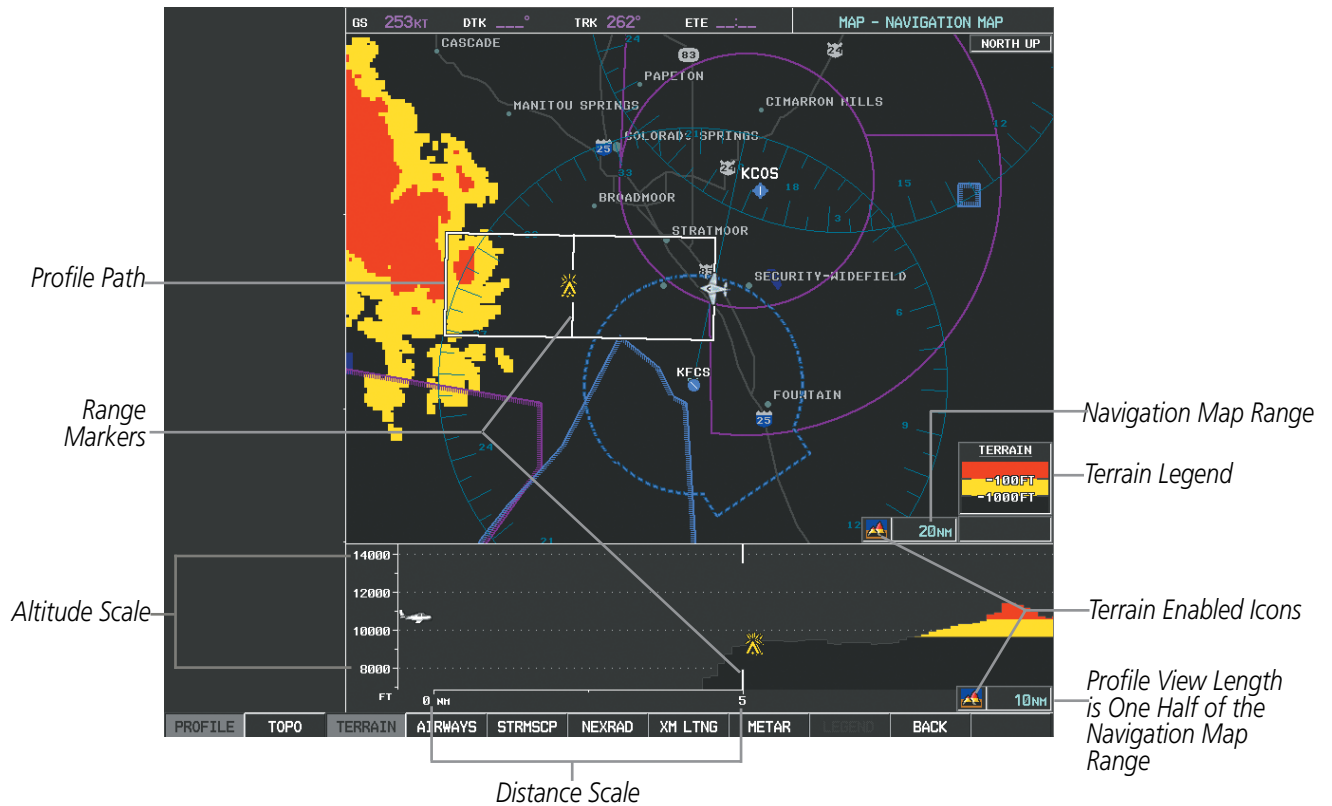

Figure 6-156 Profile View on Navigation Map with Terrain Display Enabled

The Profile View is based on the current aircraft track (or heading if track is unavailable) and shows the *highest* known terrain or obstacles within a predetermined width from the present aircraft position to the end of the profile range. The width of the Profile View is determined by the phase of flight, as annunciated on the HSI, and is widest during enroute and oceanic phases (Table 6-25).

Flight Phase	Total Profile View Width
Approach	0.6 nm
Departure	0.6 nm
Terminal	2.0 nm
Enroute	4.0 nm
Oceanic	4.0 nm

Table 6-25 Profile View Width Scale

PROFILE PATH

The Profile Path displays the horizontal and lateral boundaries of the Profile View. The path is shown as a white rectangle on the Navigation Map Page and is only available when Profile View is enabled. White range markers both edges of the Profile Path rectangle match the range markers along the distance scale inside the Profile View display window whenever the profile range is at least 4 nm (or 7.5 km if configured for metric units).

The Profile Path rectangle may be configured on or off, and the Navigation Map range at which the Profile Path is removed from map display can be changed.

Customizing the Profile Path display on the Navigation Map Page:

- 1) Select the Navigation Map Page.
- 2) Press the **MENU** Key.
- 3) With 'Map Setup' highlighted, press the **ENT** Key (Figure 6-157).
- 4) Turn the small **FMS** Knob to select the 'Profile' Group and press the **ENT** Key (Figure 6-158).
- 5) Turn the large **FMS** Knob or press the **ENT** Key to scroll through product selections (Figure 6-159).
 - PROFILE PATH – Turns the display of the Profile Path on or off and sets maximum range at which Profile Path is shown
- 6) Turn the small **FMS** Knob to scroll through options (ON/OFF, range settings).
- 7) Press the **ENT** Key to select an option.
- 8) Press the **FMS** Knob or **CLR** Key to return to the Navigation Map Page with the changed settings.



Figure 6-157 Navigation Map Page Menu



Figure 6-158 Navigation Map Page Setup Menu

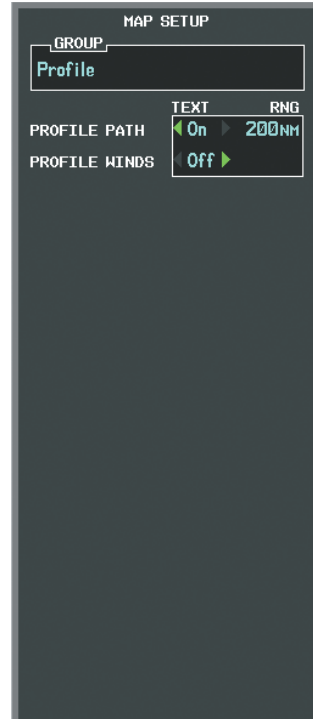

Figure 6-159 Navigation Map Page Setup Menu, Profile Group

6.9 TRAFFIC INFORMATION SERVICE (TIS)



WARNING: The Traffic Information Service (TIS) is intended for advisory use only. TIS is intended to help the pilot locate traffic visually. It is the responsibility of the pilot to see and maneuver to avoid traffic.



NOTE: TIS is available only when the aircraft is within the service volume of a TIS-capable terminal radar site. Aircraft without an operating transponder are invisible to both Traffic Advisory Systems (TAS) and TIS. Aircraft without altitude reporting capability are shown without altitude separation data or climb descent indication.



NOTE: TIS is disabled if a Traffic Advisory System (TAS) is installed.

Traffic Information Service (TIS) is designed to help in detection and avoidance of other aircraft. TIS uses the Mode S transponder for the traffic data link. TIS receives traffic information from ground stations, and is updated every 5 seconds. The G1000 displays up to eight traffic targets within a 7.5-nm radius, from 3000 feet below to 3500 feet above the requesting aircraft. Traffic is displayed according to Traffic Alert and Collision Avoidance System (TCAS) symbology.



TIS Symbol	Description
	Non-Threat Traffic
	Traffic Advisory (TA)
	Traffic Advisory Off Scale

Table 6-26 TIS Traffic Symbols

A Traffic Advisory (TA) indicates that the current track of the intruder could result in a collision. When traffic meets the advisory criteria for the TA, a solid yellow circle symbol is generated. A TA which is detected, but is outside the range of the map, is indicated with a message in the lower left corner of the map and a half TA symbol at the relative bearing of the intruder.

TIS also provides a vector line showing the direction in which the traffic is moving, to the nearest 45°. Traffic information for which TIS is unable to determine the bearing (non-bearing traffic) is displayed in the center of the Traffic Map Page (Figure 6-164) or in a banner at the lower left corner of maps other than the Traffic Map Page on which traffic can be displayed.

The altitude difference between the requesting aircraft and other intruder aircraft is displayed above/below the traffic symbol in hundreds of feet. If the other aircraft is above the requesting aircraft, the altitude separation appears above the traffic symbol; if below, the altitude separation appears below. Altitude trend is displayed as an up/down arrow (for speeds greater than 500 fpm in either direction) to the right of the target symbol. Traffic symbols for aircraft without altitude reporting capability appear without altitude separation or climb/descent information.

DISPLAYING TRAFFIC DATA

The Map - Traffic Map Page is the principal page for viewing traffic information. Additional displays of traffic information are available as map overlays while TIS is operating, and serve as additional reference to the Traffic Map Page. Traffic information can be displayed on the following maps and pages:

- PFD Inset Map
- Navigation Map Page
- Traffic Map Page
- Trip Planning Page
- Nearest Pages
- Active Flight Plan Page

Traffic information can also be displayed on the PFD when the Synthetic Vision System (SVS) option is installed and enabled. See the Additional Features Section for details.

Displaying traffic information (maps other than the Traffic Map Page):

- 1) Select the **MAP** Softkey.
- 2) Select the **TRAFFIC** Softkey to display traffic data.

When traffic is selected on maps other than the Traffic Map Page, an icon is shown to indicate the feature is enabled for display.

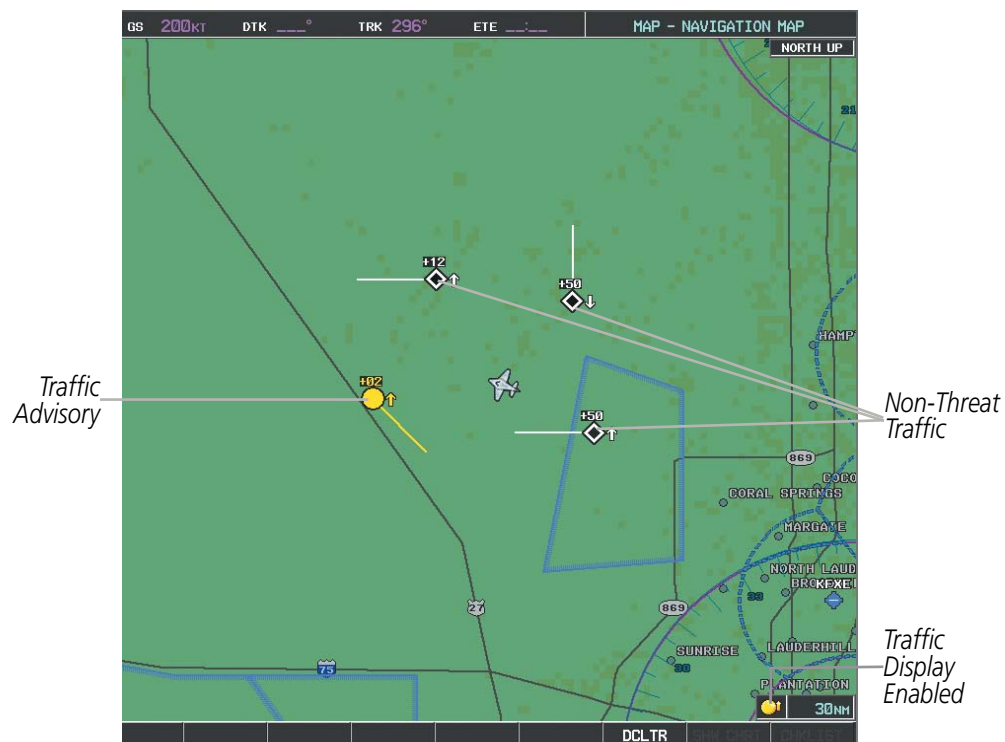

Figure 6-160 TIS Traffic on the Navigation Map Page

Displaying traffic information (PFD Inset Map):

- 1) Select the **INSET** Softkey.
- 2) Select the **TRAFFIC** Softkey to display traffic data on the inset map (TRFC-1).

- 3) Select the softkey again to display the traffic-only inset (TRFC-2).
- 4) Select the softkey again to remove traffic data.

Customizing traffic display on the Navigation Map Page:

- 1) Select the Navigation Map Page.
- 2) Press the **MENU** Key.
- 3) With 'Map Setup' highlighted, press the **ENT** Key (Figure 6-161).
- 4) Turn the small **FMS** Knob to select the 'Traffic' Group and press the **ENT** Key (Figure 6-162).
- 5) Turn the large **FMS** Knob or press the **ENT** Key to scroll through product selections (Figure 6-163).
 - TRAFFIC – Turns the display of traffic data on or off
 - TRAFFIC MODE – Selects the traffic mode for display; select from:
 - All Traffic - Displays all traffic
 - TA ONLY - Displays Traffic Alerts only
 - TRAFFIC SMBL – Selects the maximum range at which traffic symbols are shown
 - TRAFFIC LBL – Selects the maximum range at which traffic labels are shown (with the option to turn off)
- 6) Turn the small **FMS** Knob to scroll through options for each product (ON/OFF, range settings, etc.).
- 7) Press the **ENT** Key to select an option.
- 8) Press the **FMS** Knob or **CLR** Key to return to the Navigation Map Page with the changed settings.

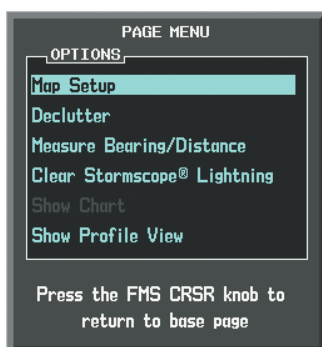

Figure 6-161 Navigation Map Page Menu

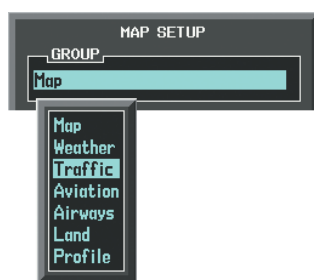

Figure 6-162 Navigation Map Page Setup Menu

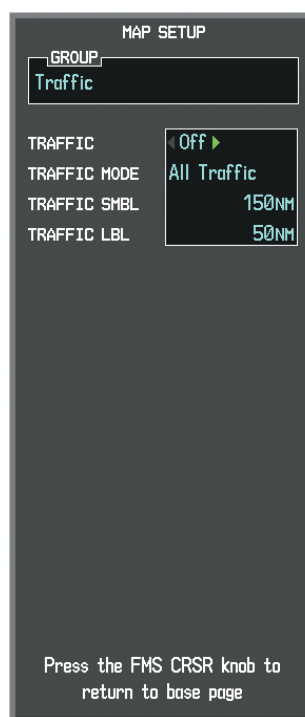

Figure 6-163 Navigation Map Page Setup Menu, Traffic Group

The Navigation Map Page Setup Menu provides a means in addition to the softkey for enabling/disabling display of traffic. The setup menu also controls the map range settings above which traffic data (symbols and labels) are decluttered from the display. If a map range larger than the map range setting is selected, the data is removed from the map. Maps besides the Traffic Map Page use settings based on those selected for the Navigation Map Page.

TRAFFIC MAP PAGE

The Traffic Map Page is specialized to show surrounding TIS traffic data in relation to the aircraft's current position and altitude, without clutter from the basemap. Aircraft orientation on this map is always heading up unless there is no valid heading. Map range is adjustable with the **RANGE** Knob from 2 to 12 nm, as indicated by the map range rings.

The traffic mode is annunciated in the upper left corner of the Traffic Map Page. When the aircraft is on the ground, TIS automatically enters Standby Mode. Once the aircraft is airborne, TIS switches from Standby to Operating Mode and the G1000 begins to display traffic information. Refer to the System Status discussion for more information.

Displaying traffic on the Traffic Map Page:

- 1) Turn the large **FMS** Knob to select the Map Page Group.
- 2) Turn the small **FMS** Knob to select the Traffic Map Page.
- 3) Confirm TIS is in Operating Mode:

Select the **OPERATE** Softkey to begin displaying traffic.

Or:

- a) Press the **MENU** Key.
- b) Select 'Operate Mode' (shown if TIS is in Standby Mode) and press the **ENT** Key.

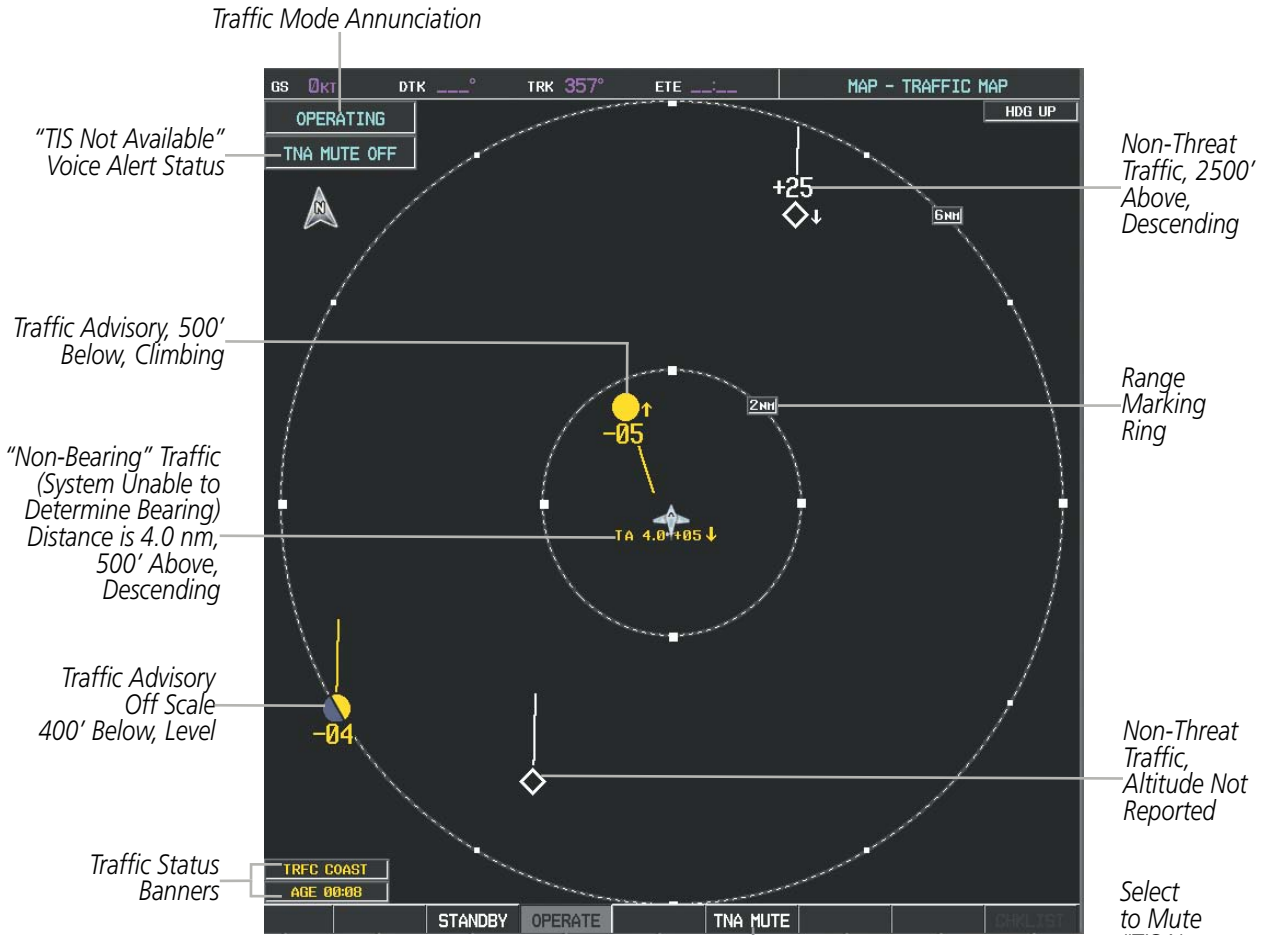

Figure 6-164 Traffic Map Page

TIS ALERTS

When the number of TAs on the Traffic Map Page increases from one scan to the next, the following occur:

- A single **“Traffic”** voice alert is generated.
- A ‘TRAFFIC’ Annunciation appears to the top left of the Attitude Indicator on the PFD, flashing for 5 seconds and remaining displayed until no TAs are detected in the area.
- The PFD Inset Map is automatically displayed with traffic.

To reduce the number of nuisance alerts due to proximate aircraft, the **“Traffic”** voice alert is generated only when the number of TAs increases. For example, when the first TA is displayed, a voice and visual annunciation are generated. As long as a single TA remains on the display, no additional voice alerts are generated. If a second TA appears on the display or if the number of TAs initially decreases and then subsequently increases, another voice alert is generated.

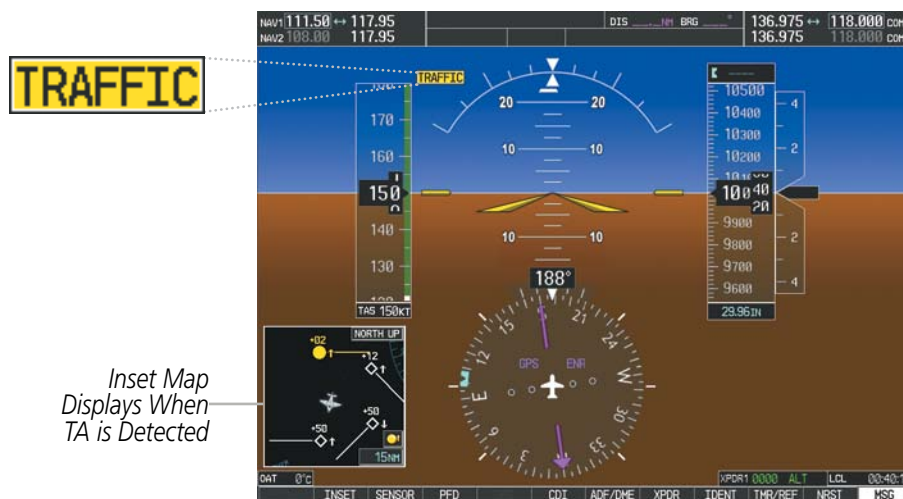

Figure 6-165 Traffic Annunciation (PFD)

A **“TIS Not Available”** (TNA) voice alert is generated when the TIS service becomes unavailable or is out of range. TIS may be unavailable in the radar coverage area due to the following:

- Radar site TIS Mode S sensor is not operational or is out of service
- Traffic or requesting aircraft is beyond the maximum range of the TIS-capable Mode S radar site.
- Traffic or requesting aircraft is above the radar site in the cone of silence and out of range of an adjacent site.
- Traffic or requesting aircraft is below radar coverage. In flat terrain, the coverage extends from about 3000 feet upward at 55 miles. Terrain and obstacles around the radar site can further decrease radar coverage in all directions.
- Traffic does not have an operating transponder.

The **“TIS Not Available”** (TNA) voice alert can be manually muted to reduce nuisance alerting. TNA muting status is shown in the upper left corner of the Traffic Map Page.

Muting the “TIS Not Available” voice alert:

- 1) Select the Traffic Map Page.
- 2) Select the **TNA MUTE** Softkey. The status is displayed in the upper left corner of the Traffic Map Page.

Or:

- a) Press the **MENU** Key.
- b) Select “Not Available” Mute On’ (shown if TNA muting is currently off) and press the **ENT** Key.

SYSTEM STATUS

The G1000 performs an automatic test of TIS during power-up. If TIS passes the test, TIS enters Standby Mode (on the ground) or Operating Mode (in the air). If TIS fails the power up test, an annunciation is shown in the center of the Traffic Map Page.

Traffic Map Page Annunciation	Description
NO DATA	Data is not being received from the transponder*
DATA FAILED	Data is being received from the transponder, but a failure is detected in the data stream*
FAILED	The transponder has failed*
UNAVAILABLE	TIS is unavailable or out of range



* Contact a service center or Garmin dealer for corrective action

Table 6-27 TIS Failure Annunciations



Figure 6-166 TIS Power-up Test Failure

The traffic mode is annunciated in the upper left corner of the Traffic Map Page. When the aircraft is on the ground, TIS automatically enters Standby Mode. If traffic is selected for display on another map while Standby Mode is selected, the traffic display enabled icon is crossed out (also the case whenever TIS has failed). Once the aircraft is airborne, TIS switches to Operating Mode and traffic information is displayed. The mode can be changed manually using softkeys or the page menu.

Mode	Traffic Mode Annunciation (Traffic Map Page)	Traffic Display Enabled Icon (Other Maps)
TIS Operating	OPERATING	
TIS Standby	STANDBY (also shown in white in center of page)	
TIS Failed*	FAIL	

* See Table 6-29 for additional failure annunciations

Table 6-28 TIS Modes

Switching between TIS modes:

- 1) Select the Traffic Map Page.
- 2) Select the **STANDBY** or **OPERATE** Softkey to switch between modes. The mode is displayed in the upper left corner of the Traffic Map Page.

Or:

- a) Press the **MENU** Key.
- b) Select 'Operate Mode' or 'Standby Mode' (choice dependent on current state) and press the **ENT** Key.

The annunciations to indicate the status of traffic information appear in a banner at the lower left corner of maps on which traffic can be displayed (Table 6-29).

Traffic Status Banner Annunciation	Description
TA OFF SCALE	A Traffic Advisory is outside the selected display range* Annunciation is removed when traffic comes within the selected display range
TA X.X ± XX ↓	System cannot determine bearing of Traffic Advisory** Annunciation indicates distance in nm, altitude separation in hundreds of feet, and altitude trend arrow (climbing/descending)
AGE MM:SS	Appears if traffic data is not refreshed within 6 seconds If after another 6 seconds data is not received, traffic is removed from the display The quality of displayed traffic information is reduced as the age increases
TRFC COAST	The displayed data is not current (6 to 12 seconds since last message) The quality of displayed traffic information is reduced when this message is displayed
TRFC RMVD	Traffic is removed because it is too old for coasting (12 to 60 seconds since last message) Traffic may exist within the selected display range, but it is not displayed
TRFC FAIL	Traffic data has failed
NO TRFC DATA	Traffic has not been detected
TRFC UNAVAIL	The traffic service is unavailable or out of range

*Shown as symbol on Traffic Map Page

**Shown in center of Traffic Map Page

Table 6-29 TIS Traffic Status Annunciations

6.10 GTS 820 TRAFFIC



WARNING: The GTS 820 Traffic Advisory System (TAS) is intended for advisory use only to aid the pilot in visually acquiring traffic. No avoidance maneuvers should be based solely upon TAS traffic information. It is the responsibility of the pilot in command to see and maneuver to avoid traffic.



NOTE: Pilots should be aware of TAS system limitations. TAS systems require transponders of other aircraft to respond to system interrogations. If the transponders do not respond to interrogations due phenomena such as antenna shading or marginal transponder performance, traffic may be displayed intermittently, or not at all. Aircraft without altitude reporting capability are shown without altitude separation data or climb descent indication. Pilots should remain vigilant for traffic at all times.



NOTE: TIS is disabled when TAS installed.

The optional Garmin GTS 820 is a Traffic Advisory System (TAS). The GTS 820 enhances flight crew situational awareness by displaying traffic information for transponder-equipped aircraft. The GTS 820 also provides visual and aural traffic alerts including voice announcements to assist in visually acquiring traffic.

The GTS 820 is capable of tracking up to 45 intruding aircraft equipped with Mode A or C transponders, and up to 30 intruders equipped with Mode S transponders. A maximum of 30 aircraft with the highest threat potential can be displayed simultaneously. No TAS surveillance is provided for aircraft without operating transponders.

THEORY OF OPERATION

When the GTS 820 is in Operating Mode, the unit interrogates the transponders of intruding aircraft while monitoring transponder replies. The GTS 820 uses this information to derive the distance, relative bearing, and if reported, the altitude and vertical trend for each aircraft within its surveillance range. The GTS 820 then calculates a closure rate to each intruder based on the projected Closest Point of Approach (CPA). If the closure rate meets the threat criteria for a Traffic Advisory (TA), visual and aural alerting is provided.

TAS SURVEILLANCE VOLUME

The GTS 820 surveillance system monitors the airspace within $\pm 10,000$ feet of own altitude. Under ideal conditions, the unit scans transponder traffic up to 40 nm in the forward direction. Range is somewhat reduced to the sides and aft of own aircraft due to the directional interrogation signal patterns. In areas of greater transponder traffic density or when TCAS II systems are detected, the GTS 820 automatically reduces its interrogation transmitter power (and therefore range) in order to limit potential interference from other signals.

TAS SYMBOLOGY

The GTS 850 uses symbology to depict intruding traffic using the symbols shown in Table 6-30.





TAS Symbol	Description
	Non-Threat Traffic
	Proximity Advisory (PA)
	Traffic Advisory (TA)
	Traffic Advisory Off Scale

Table 6-30 TAS Symbol Description

A Traffic Advisory (TA), displayed as a yellow circle, alerts the crew to a potentially hazardous intruding aircraft, if the closing rate, distance, and vertical separation meet TA criteria. A Traffic Advisory that is beyond the selected display range (off scale) is indicated by a half TA symbol at the edge of the screen at the relative bearing of the intruder.

A Proximity Advisory (PA), displayed as a solid white diamond, indicates the intruding aircraft is within ± 1200 feet and is within a 6 nm range, but is still not considered a TA threat.

A Non-threat Advisory, shown as an open white diamond, is displayed for traffic beyond 6 nm that is neither a TA or PA.

Relative altitude, when available, is displayed above or below the corresponding intruder symbol in hundreds of feet (Figure 6-167). When this altitude is above own aircraft, it is preceded by a '+' symbol; a minus sign '-' indicates traffic is below own aircraft.

A vertical trend arrow to the right of the intruder symbol (Figure 6-167) indicates climbing or descending traffic with an upward or downward-pointing arrow respectively.

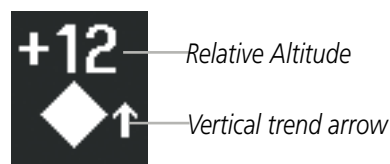

Figure 6-167 Intruder Altitude and Vertical Trend Arrow

Flight IDs may also be displayed with traffic symbols; see the Flight IDs discussion in this section for more information.

The GTS 820 automatically suppresses the display of altitude-reporting aircraft on the ground under either of the following conditions:

- On-ground aircraft is equipped with a Mode S transponder.
- On-ground aircraft is equipped with a Mode C transponder, and own aircraft's radar altimeter (if installed) is displaying 1700' AGL or less.

TA ALERTING CONDITIONS

The GTS 820 automatically adjusts its TA sensitivity level to reduce the likelihood of nuisance TA alerting during flight phases likely to be near airports. Level A (less) TA sensitivity is used when the aircraft's landing gear is extended, or when the radar altimeter (if equipped) indicates own aircraft altitude is below 2000' AGL. In all other conditions, Level B (greater) TA sensitivity is used to assess TA threats.

Sensitivity Level	Intruder Altitude Available	TA Alerting Conditions
A	Yes	Intruder closing rate provides less than 20 seconds of vertical and horizontal separation. Or: Intruder closing rate provides less than 20 seconds of horizontal separation and vertical separation is within 600 feet. Or: Intruder range is within 0.2 nm and vertical separation is within 600 feet.
A	No	Intruder closing rate provides less than 15 seconds of separation.
B	Yes	Intruder closing rate provides less than 30 seconds of vertical and horizontal separation. Or: Intruder closing rate provides less than 30 seconds of horizontal separation and vertical separation is within 800 feet. Or: Intruder range is within 0.55 nm and vertical separation is within 800 feet.
B	No	Intruder range is less than 20 seconds.

Table 6-31 TA Sensitivity Level and TA Alerting Criteria

TAS ALERTS

NOTE: Aural traffic alerts do not occur at or below 400' AGL (if a radar altimeter is installed) or when the landing gear is extended (if a radar altimeter is not installed). Only visual traffic annunciations are issued under these conditions.

When the GTS 820 detects a new TA, the following occur:

- A single **“Traffic”** voice alert is generated, followed by additional voice information about the bearing, relative altitude, and approximate distance from the intruder that triggered the TA (Table 6-32). The announcement **“Traffic! 12 o’clock, high, four miles,”** would indicate the traffic is in front of own aircraft, above own altitude, and approximately four nautical miles away.
- A TRAFFIC Annunciation appears at the top right of the airspeed on the PFD, flashing for five seconds and remains displayed until no TAs are detected in the area (Figure 6-168).
- The PFD Inset Map is automatically displayed with TA traffic.

If the bearing of TA traffic cannot be determined, a yellow text banner will be displayed in the center of the Traffic Map Page and in the lower-left of the PFD inset map instead of a TA symbol. The text will indicate “TA” followed by the distance, relative altitude, and vertical trend arrow for the TA traffic, if known.

A TA will be displayed for at least eight seconds, even if the condition(s) that initially triggered the TA are no longer present.

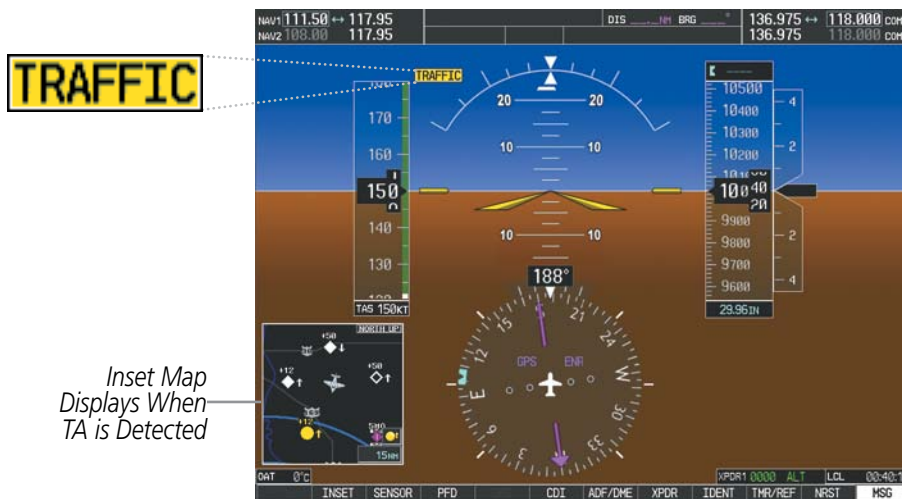

Figure 6-168 Traffic Annunciation (PFD)

Bearing	Relative Altitude	Distance (nm)
“One o’clock” through “Twelve o’clock” or “No Bearing”	“High”, “Low”, “Same Altitude” (if within 200 feet of own altitude), or “Altitude not available”	“Less than one mile”, “One Mile” through “Ten Miles”, or “More than ten miles”

Table 6-32 TA Descriptive Voice Announcements

SYSTEM TEST

NOTE: GTS 820 traffic surveillance is not available during the system test. Use caution when performing a system test during flight.

The GTS 820 provides a system test mode to verify the TAS system is operating normally. The test takes ten seconds to complete. When the system test is initiated, a test pattern of traffic symbols is displayed on the Traffic Map Page (Figure 6-169). If the system test passes, the aural announcement “**TAS System Test Passed**” is heard, otherwise the system announces “**TAS System Test Failed.**” When the system test is complete, the GTS 820 enters Standby Mode.

Testing the traffic system:

- 1) Turn the large **FMS** Knob to select the Map Page Group.
- 2) Turn the small **FMS** Knob to select the Traffic Map Page.
- 3) Turn the **Range** knob to set the range to 2/6 nm to make sure full test pattern is shown during test.
- 4) Select the **TEST** Softkey.

Or:

- 1) Press the **MENU** Key and turn the small **FMS** knob to select ‘Test Mode’.
- 2) Press the **ENT** Key.



Figure 6-169 System Test in Progress with Test Pattern

OPERATION



NOTE: The GTS 820 automatically transitions from **STANDBY** to **OPERATE** mode eight seconds after takeoff. The unit also automatically transitions from **OPERATE** to **STANDBY** mode 24 seconds after landing.

After power-up, the GTS 820 is in Standby Mode. The GTS 820 must be in Operating Mode for traffic to be displayed and for TAs to be issued.

Selecting the **OPERATE** Softkey allows the GTS 820 to switch from Standby Mode to Operating Mode as necessary. Selecting the **STANDBY** Softkey forces the unit into Standby Mode.

Switching from operating mode to standby mode:

On the Traffic Page, select the **STANDBY** Softkey

Or:

- 1) Press the **MENU** Key and turn the small **FMS** knob to select 'Standby Mode'.
- 2) Press the **ENT** Key.

Switching from standby mode to operating mode:

On the Traffic Page, select the **OPERATE** Softkey

Or:

- 1) Press the **MENU** Key and turn the small **FMS** knob to select 'Operate Mode'.
- 2) Press the **ENT** Key. The GTS 820 switches from Standby Mode to Operating Mode as necessary.

TRAFFIC MAP PAGE

The Traffic Map Page shows surrounding TAS traffic data in relation to the aircraft's current position and altitude, without basemap clutter. Aircraft orientation is always heading up unless there is no valid heading. Map range is adjustable with the **RANGE** Knob from 2 to 40 nm, as indicated by the map range rings.

The traffic mode and altitude display mode are annunciated in the upper left corner of the page.

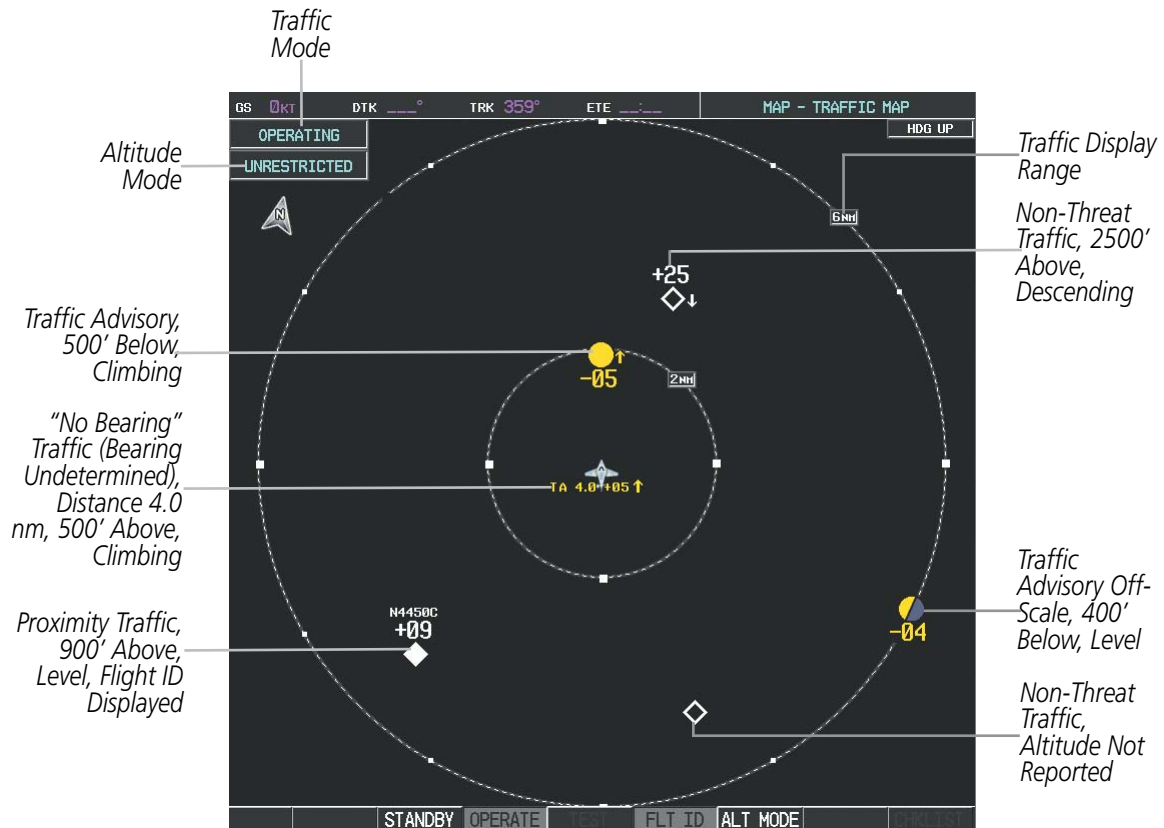

Figure 6-170 Traffic Map Page

Displaying traffic on the Traffic Map Page:

- 1) Turn the large **FMS** Knob to select the Map Page Group.
- 2) Turn the small **FMS** Knob to select the Traffic Map Page.
- 3) Select the **OPERATE** Softkey to begin displaying traffic. OPERATING is displayed in the Traffic mode field.
- 4) Select the **STANDBY** Softkey to place the system in the Standby mode. STANDBY is displayed in the Traffic mode field.
- 5) Turn the **RANGE** Knob clockwise to display a larger area or counter-clockwise to display a smaller area.

ALTITUDE DISPLAY

The pilot can select the volume of airspace in which non-threat and proximity traffic is displayed. TAs occurring outside of these limits will always be shown.

Changing the altitude range:

- 1) On the Traffic Map Page, select the **ALT MODE** Softkey.
- 2) Select one of the following Softkeys:
 - **ABOVE:** Displays non-threat and proximity traffic from 9000 feet above the aircraft to 2700 feet below the aircraft. Typically used during climb phase of flight.
 - **NORMAL:** Displays non-threat and proximity traffic from 2700 feet above the aircraft to 2700 feet below the aircraft. Typically used during enroute phase of flight.
 - **BELOW:** Displays non-threat and proximity traffic from 2700 feet above the aircraft to 9000 feet below the aircraft. Typically used during descent phase of flight.
 - **UNREST** (unrestricted): All traffic is displayed from 9900 feet above and 9900 feet below the aircraft.
- 3) To return to the Traffic Page, select the **BACK** Softkey.

Or:

- 1) Press the **MENU** Key.
- 2) Turn the small **FMS** Knob to select one of the following (see softkey description in step 2 above):
 - ABOVE
 - NORMAL
 - BELOW
 - UNRESTRICTED
- 3) Select the **ENT** Softkey.

FLIGHT ID DISPLAY

The Flight IDs of other aircraft (when available) can be enabled for display on the Traffic Map Page (Figure 6-171). When a flight ID is received, it will appear above or below the corresponding traffic symbol on the Traffic Map Page when this option is enabled.

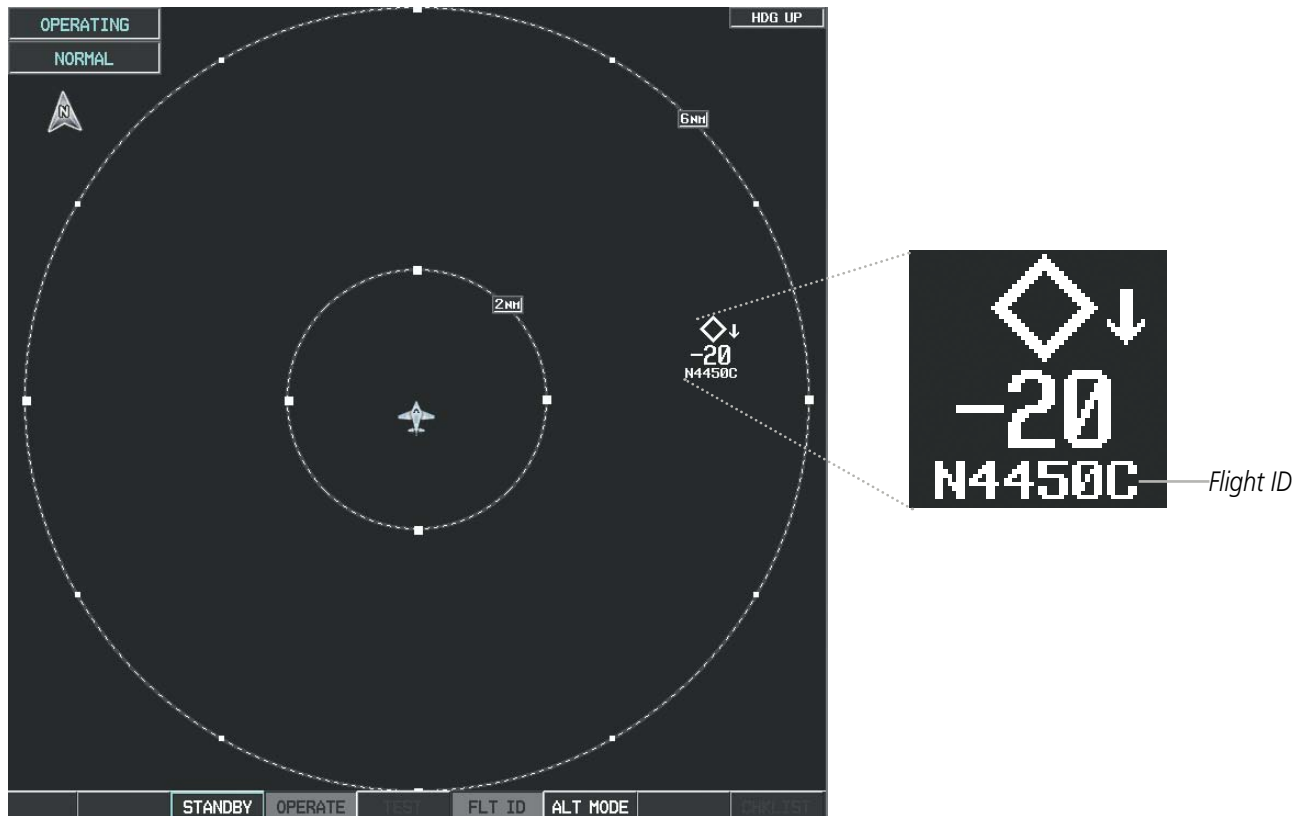

Figure 6-171 Traffic Map Page with Flight IDs Enabled

Enabling/Disabling Flight ID Display:

On the Traffic Map Page, select the **FLT ID** Softkey.

Or:

- 1) Press the **MENU** Key.
- 2) Turn the small **FMS** Knob to choose 'Show Flight IDs' or 'Hide Flight IDs' (choice dependent on current state) (Figure 6-172).
- 3) Press the **ENT** Key.



Figure 6-172 Traffic Map Page Menu

TRAFFIC MAP PAGE DISPLAY RANGE

The display range on the Traffic Map Page can be changed at any time. Map range is adjustable with the **RANGE** Knob from 2 to 40 nm, as indicated by the map range rings.

Changing the display range on the Traffic Map Page:

- 1) Turn the **RANGE** Knob.
- 2) The following range options are available:
 - 2 nm
 - 2 and 6 nm
 - 6 and 12 nm
 - 12 and 24 nm
 - 24 and 40 nm

ADDITIONAL TRAFFIC DISPLAYS

Traffic information can be displayed on the following maps on the MFD when the unit is operating:

- Navigation Map Page
- Traffic Map Page
- Trip Planning Page
- Nearest Pages
- Active Flight Plan Page
- System Pages

Traffic information can also be displayed on the PFD when the Synthetic Vision System (SVS) option is installed and enabled. See the Additional Features Section for details.

Displaying traffic information (MFD maps other than the Traffic Map Page):

- 1) Select the **MAP** Softkey.
- 2) Select the **TRAFFIC** Softkey. Traffic is now displayed on the map.

When traffic is selected on maps other than the Traffic Map Page, a traffic icon is shown to indicate traffic is enabled for display (Figure 6-173).

Displaying traffic on the Navigation Map

- 1) Ensure the TAS system is operating. With the Navigation Map displayed, select the **MAP** Softkey.
- 2) Select the **TRAFFIC** Softkey. Traffic is now displayed on the map as shown in the figure.

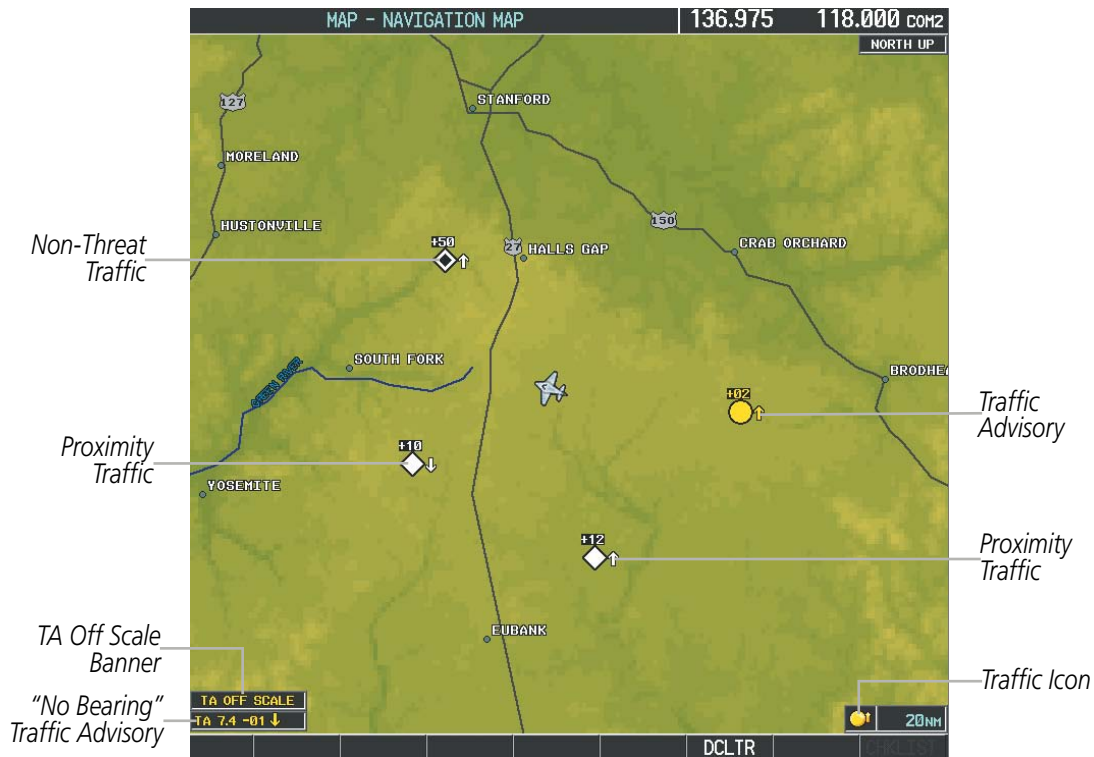

Figure 6-173 TAS Traffic on Navigation Map

Customizing the traffic display on the Navigation Map Page:

- 1) Select the Navigation Map Page.
- 2) Press the **MENU** Key.
- 3) With Map Setup highlighted, press the **ENT** Key (Figure 6-174).
- 4) Turn the small **FMS** Knob to select the Traffic Group and press the **ENT** Key (Figure 6-175).
- 5) Turn the large **FMS** Knob or press the **ENT** Key to scroll through the selections (Figure 6-176).
 - TRAFFIC – Turns the display of traffic data on or off
 - TRAFFIC MODE – Selects the traffic mode for display; select from:
 - All Traffic - Displays all traffic
 - TA/PA - Displays Traffic Advisories and Proximity Advisories
 - TA ONLY - Displays Traffic Advisories only
 - TRAFFIC SMBL – Selects the maximum range at which traffic symbols are shown
 - TRAFFIC LBL – Selects the maximum range at which traffic labels are shown with the option to turn off
- 6) Turn the small **FMS** Knob to scroll through options (ON/OFF, range settings, etc.).
- 7) Press the **ENT** Key to select an option.
- 8) Press the **FMS** Knob or **CLR** Key to return to the Navigation Map Page.

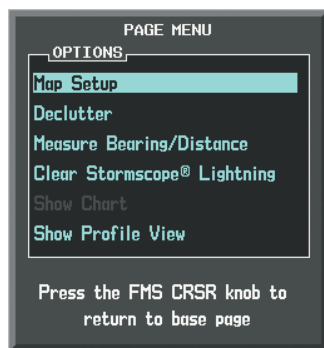

Figure 6-174 Navigation Map Page Menu



Figure 6-175 Navigation Map Page Setup Menu

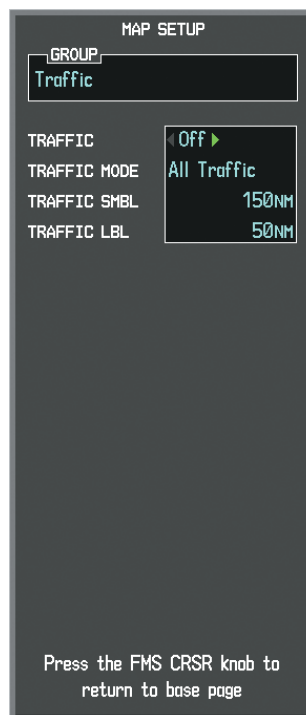

Figure 6-176 Navigation Map Page Setup Menu, Traffic Group

The Navigation Map Page Setup Menu also controls the display of traffic. The setup menu controls the map range settings. Traffic data symbols and labels can be decluttered from the display. If a map range larger than the map range setting is selected, the data is removed from the map. Maps besides the Traffic Map Page use settings based on those selected for the Navigation Map Page.

Traffic information can also be displayed on the PFD Inset Map by pressing the **INSET** Softkey. A traffic map will appear in heading up orientation. Traffic information can also be overlaid with navigation, topographic and optional weather data.

Displaying traffic information (PFD Inset Map):

- 1) Select the **INSET** Softkey.
- 2) Select the **TRAFFIC** Softkey to display traffic data on the inset map (TRFC-1).
- 3) Select the softkey again to display the traffic-only inset (TRFC-2).
- 4) Select the softkey again to remove traffic data.

SYSTEM STATUS

The traffic mode is annunciated in the upper left corner of the Traffic Map Page.

Mode	Traffic Mode Annunciation (Traffic Map Page)	Traffic Display Status Icon (Other Maps)
TAS System Test Initiated	TEST (also shown in white in center of page)	
TAS Operating	OPERATING	
TAS Standby	STANDBY (also shown in white in center of page)	
TAS Failed*	FAIL	

* See Table 6-34 for additional failure annunciations

Table 6-33 TAS Modes

If the traffic unit fails, an annunciation as to the cause of the failure is shown in the center of the Traffic Map Page. During a failure condition, the Operating Mode cannot be selected.

Traffic Map Page Annunciation	Description
NO DATA	Data is not being received from the TAS unit
DATA FAILED	Data is being received from the TAS unit, but the unit is self-reporting a failure
FAILED	Incorrect data format received from the TAS unit

Table 6-34 TAS Failure Annunciations

The annunciations to indicate the status of traffic information appear in a banner at the lower left corner of maps on which traffic can be displayed.

Traffic Status Banner Annunciation	Description
TA OFF SCALE	A Traffic Advisory is outside the selected display range*. Annunciation is removed when traffic comes within the selected display range.
TA X.X ± XX ↓	System cannot determine bearing of Traffic Advisory**. Annunciation indicates distance in nm, altitude separation in hundreds of feet, and altitude trend arrow (climbing/ descending).
TRFC FAIL	TAS unit has failed (unit is self-reporting a failure or sending incorrectly formatted data)
NO TRFC DATA	Data is not being received from the TAS unit

*Shown as symbol on Traffic Map Page

**Shown in center of Traffic Map Page

Table 6-35 TAS Traffic Status Annunciations

6.11 KTA 870 TRAFFIC



NOTE: Refer to the Honeywell® KTA 870 Pilot's Guide for a detailed discussion of the KTA 870 TAS.

TAS SYMBOLOGY

The Traffic Advisory System (TAS) is designed to help in detection and avoidance of other aircraft. TAS uses an on-board interrogator-processor and the Mode S transponder for the air-to-air traffic data link. Traffic is displayed using the symbols shown in Table 6-36.





TAS Symbol	Description
	Non-Threat Traffic
	Proximity Advisory (PA)
	Traffic Advisory (TA)
	Traffic Advisory Off Scale

Table 6-36 TAS Symbol Description

A Non-threat Advisory, shown as an open white diamond, indicates that an intruding aircraft is at greater than ± 1200 feet relative altitude or the distance is beyond 5 nm.

A Proximity Advisory indicates that the intruding aircraft is within ± 1200 feet and is within 5 nm range, but is still not considered a threat.

A Traffic Advisory (TA) alerts the crew to a potentially hazardous intruding aircraft. Closing rate, distance, and vertical separation meet TA criteria. A Traffic Advisory that is beyond the selected display range is indicated by a half TA symbol at the edge of the screen at the relative bearing of the intruder.

OPERATION



NOTE: The traffic unit may be configured to automatically change from **STANDBY** to **NORMAL** mode after takeoff or from **NORMAL** to **STANDBY** mode after landing. Refer to the KTA 870 Pilot's Guide for additional operating instructions.

Selecting the **STANDBY** Softkey forces the unit into Standby Mode. Selecting the **NORMAL** Softkey allows the KTA 870 to switch from Standby Mode to Operating Mode as necessary.

Switching from standby mode to operating mode:

On the Traffic Page, select the **NORMAL** Softkey.

Or:

- 1) Press the **MENU** Key and turn the small **FMS** knob to select Normal Mode.
- 2) Press the **ENT** Key to place the KTA 870 in the operating mode.

Switching from operating mode to standby mode:

On the Traffic Page, select the **STANDBY** Softkey.

Or:

- 1) Press the **MENU** Key and turn the small **FMS** knob to select Standby Mode.
- 2) Press the **ENT** Key to place the KTA 870 in the Standby mode.

System Self Test

- 1) Set the range to 2/6 nm to allow for display of full traffic test pattern.
- 2) Select the **TEST** Softkey.
- 3) Self test takes approximately eight seconds to complete. When completed successfully, traffic symbols are displayed and a voice alert "TAS System Test Okay" is heard. In the event that the system test fails, the system reverts to Standby Mode and a voice alert "TAS System Test Fail" is heard.

Displaying traffic on the Traffic Map Page:

- 1) Turn the large **FMS** Knob to select the Map Page Group.
- 2) Turn the small **FMS** Knob to select the Traffic Map Page.
- 3) Select the **NORMAL** Softkey to begin displaying traffic. OPERATING is displayed in the Traffic mode field.
- 4) Select the **ALT MODE** Softkey to change the altitude volume.
- 5) Select the **STANDBY** Softkey to place the system in the Standby mode. STANDBY is displayed in the Traffic mode field.
- 6) Turn the **RANGE** Knob clockwise to display a larger area or counter-clockwise to display a smaller area.



Figure 6-177 Traffic Map Page

The Traffic Map Page shows surrounding TAS traffic data in relation to the aircraft's current position and altitude, without basemap clutter. Aircraft orientation is always heading up unless there is no valid heading. Map range is adjustable with the **RANGE** Knob from 2 to 40 nm, as indicated by the map range rings.

The traffic mode and altitude display mode are annunciated in the upper left corner.

DISPLAYING TRAFFIC DATA

Traffic information can be displayed on the following maps when the KTA 870 unit is operating:

- PFD Inset Map
- Navigation Map Page
- Traffic Map Page
- Trip Planning Page
- Nearest Pages
- Active Flight Plan Page

Traffic information can also be displayed on the PFD when the Synthetic Vision System (SVS) option is installed and enabled. See the Additional Features Section for details.

Displaying traffic information (maps other than the Traffic Map Page):

- 1) Select the **MAP** Softkey.
- 2) Select the **TRAFFIC** Softkey. Traffic is now displayed on the map.

When traffic is selected on maps other than the Traffic Map Page, a traffic icon is shown to indicate TAS is enabled for display.

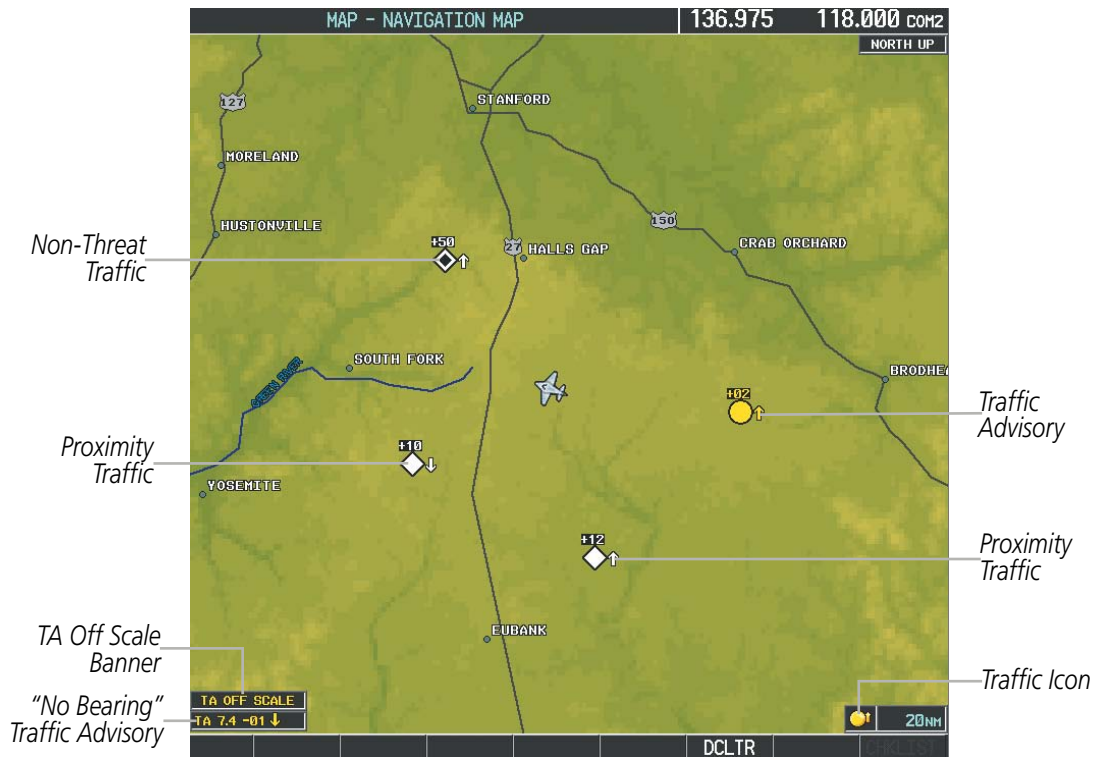

Figure 6-178 TAS Traffic on Navigation Map

Displaying traffic information (PFD Inset Map):

- 1) Select the **INSET** Softkey.
- 2) Select the **TRAFFIC** Softkey to display traffic data on the inset map (TRFC-1).
- 3) Select the softkey again to display the traffic-only inset (TRFC-2).
- 4) Select the softkey again to remove traffic data.

The Navigation Map Page Setup Menu also controls the display of traffic. The setup menu controls the map range settings. Traffic data symbols and labels can be decluttered from the display. If a map range larger than the map range setting is selected, the data is removed from the map. Maps besides the Traffic Map Page use settings based on those selected for the Navigation Map Page.

ALTITUDE DISPLAY

Changing the altitude display mode:

- 1) On the Traffic Page, select the **ALT MODE** Softkey.
- 2) Select one of the following Softkeys:
 - **BELOW**
 - **NORMAL**
 - **ABOVE**
 - **UNREST** (unrestricted)
- 3) To return to the Traffic Page, select the **BACK** Softkey.

Or:

- 1) Press the **MENU** Key.
- 2) Turn the small **FMS** Knob to select one of the following:
 - BELOW
 - NORMAL
 - ABOVE
 - UNREST (unrestricted)
- 3) Press the **ENT** Key.

TRAFFIC MAP PAGE DISPLAY RANGE

The display range on the Traffic Map Page can be changed at any time. Map range is adjustable with the **RANGE** Knob from 2 to 40 nm, as indicated by the map range rings.

Changing the display range on the Traffic Page:

- 1) Turn the **RANGE** Knob.
- 2) The following range options are available:
 - 2 nm
 - 2 and 6 nm
 - 6 and 12 nm
 - 12 and 24 nm
 - 24 and 40 nm

Customizing the traffic display on the Navigation Map Page:

- 1) Select the Navigation Map Page.
- 2) Press the **MENU** Key.
- 3) With Map Setup highlighted, press the **ENT** Key (Figure 6-179).
- 4) Turn the small **FMS** Knob to select the Traffic Group and press the **ENT** Key (Figure 6-180).
- 5) Turn the large **FMS** Knob or press the **ENT** Key to scroll through the selections (Figure 6-181).
 - TRAFFIC – Turns the display of traffic data on or off
 - TRAFFIC MODE – Selects the traffic mode for display; select from:
 - All Traffic - Displays all traffic
 - TA/PA - Displays Traffic Alerts and Proximity Advisories
 - TA ONLY - Displays Traffic Alerts only
 - TRAFFIC SMBL – Selects the maximum range at which traffic symbols are shown
 - TRAFFIC LBL – Selects the maximum range at which traffic labels are shown with the option to turn off
- 6) Turn the small **FMS** Knob to scroll through options (ON/OFF, range settings, etc.).
- 7) Press the **ENT** Key to select an option.
- 8) Press the **FMS** Knob or **CLR** Key to return to the Navigation Map Page.

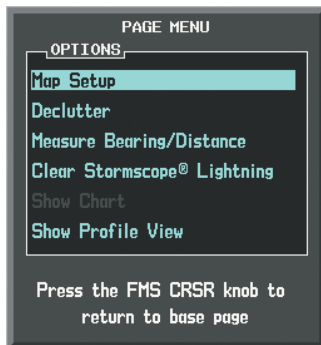

Figure 6-179 Navigation Map Page Menu

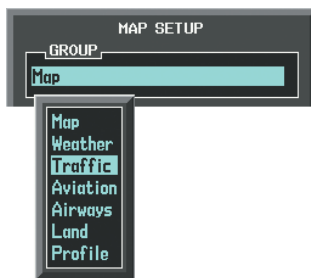

Figure 6-180 Navigation Map Page Setup Menu

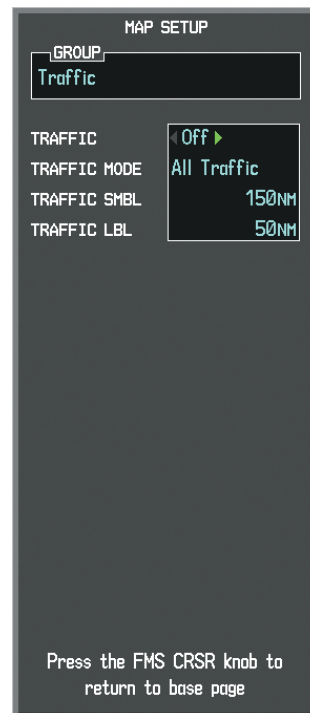

Figure 6-181 Navigation Map Page Setup Menu, Traffic Group

TAS ALERTS

NOTE: Refer to the KTA 870 documentation for information on alerts generated by the TAS equipment.

When the number of TAs on the Traffic Map Page increases from one scan to the next, the following occur:

- A **“Traffic, Traffic”** voice alert is generated when the first TA is displayed.
- A 'TRAFFIC' Annunciation appears at the top right of the airspeed on the PFD, flashing for 5 seconds and remaining displayed until no TAs are detected in the area.
- The PFD Inset Map is automatically displayed with TA traffic.
- A single **“Traffic”** voice alert is generated when the number of TAs increases.

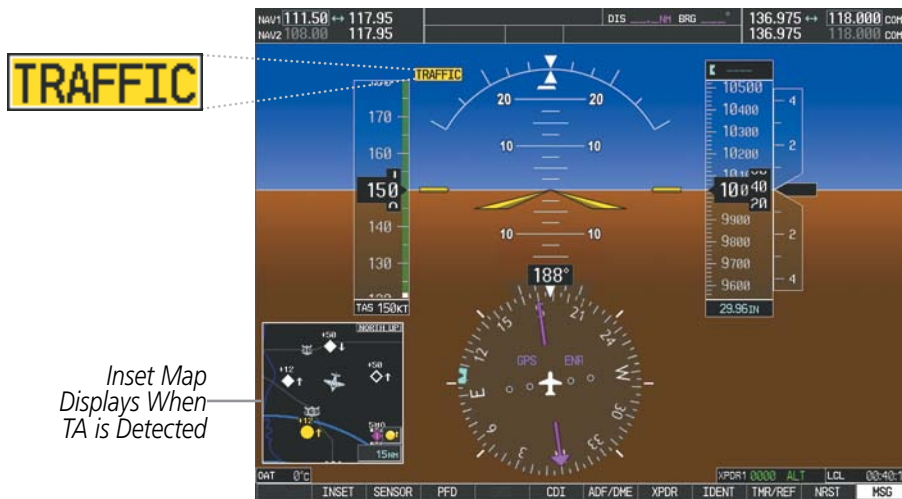

Figure 6-182 Traffic Annunciation (PFD)

SYSTEM STATUS

The traffic mode is annunciated in the upper left corner of the Traffic Map Page.

Mode	Traffic Mode Annunciation (Traffic Map Page)	Traffic Display Enabled Icon (Other Maps)
TAS Self-test Initiated	TEST (also shown in white in center of page)	
TAS Operating	OPERATING	
TAS Standby	STANDBY (also shown in white in center of page)	
TAS Failed*	FAIL	

* See Table 6-38 for additional failure annunciations

Table 6-37 TAS Modes

If the unit fails, an annunciation as to the cause of the failure is shown in the center of the Traffic Map Page.

Traffic Map Page Annunciation	Description
NO DATA	Data is not being received from the TAS unit
DATA FAILED	Data is being received from the TAS unit, but the unit is self-reporting a failure
FAILED	Incorrect data format received from the TAS unit

Table 6-38 TAS Failure Annunciations

The annunciations to indicate the status of traffic information appear in a banner at the lower left corner of maps on which traffic can be displayed.

Traffic Status Banner Annunciation	Description
TA OFF SCALE	A Traffic Advisory is outside the selected display range* Annunciation is removed when traffic comes within the selected display range
TA X.X ± XX ↓	System cannot determine bearing of Traffic Advisory** Annunciation indicates distance in nm, altitude separation in hundreds of feet, and altitude trend arrow (climbing/descending)
TRFC FAIL	TAS unit has failed (unit is self-reporting a failure or sending incorrectly formatted data)
NO TRFC DATA	Data is not being received from the TAS unit

*Shown as symbol on Traffic Map Page

**Shown in center of Traffic Map Page

Table 6-39 TAS Traffic Status Annunciations

BLANK PAGE

SECTION 7 AUTOMATIC FLIGHT CONTROL SYSTEM



NOTE: *The approved Pilot's Operating Handbook (POH) always supersedes this Pilot's Guide.*

The GFC 700 is a digital Automatic Flight Control System (AFCS), fully integrated within the G1000 System avionics architecture. The System Overview section provides a block diagram to support this system description. GFC 700 AFCS functionality in the Socata TBM 850 is distributed across the following Line Replaceable Units (LRUs):

- GDU 1040A Primary Flight Displays (PFDs) (2)
- GMC 710 AFCS Control Unit
- GIA 63W Integrated Avionics Units (IAUs) (2)
- GSA 81 AFCS Servos (4)
- GTA 82 Trim Adapter (1)
- GSM 85 or GSM 86 servo Gearboxes (4)

The GFC 700 AFCS can be divided into these main operating functions:

- **Flight Director (FD)** — The Socata TBM 850 has two flight directors, each operating within an IAU and referred to as pilot-side and copilot-side. Commands for the selected flight director are displayed on both PFDs. The flight directors provide:
 - Command Bars showing pitch/roll guidance
 - Vertical/lateral mode selection and processing
 - Autopilot communication
- **Autopilot (AP)** — Autopilot operation occurs within the pitch, roll, and pitch trim servos and yaw trim adapter. It also provides servo monitoring and automatic flight control in response to flight director steering commands, Attitude and Heading Reference System (AHRS) attitude and rate information, and airspeed.
- **Yaw Damper (YD)** — The yaw servo is self-monitoring and provides Dutch roll damping and turn coordination in response to yaw rate, roll angle, lateral acceleration, and airspeed.
- **Manual Electric Pitch Trim (MEPT)** — The pitch trim servo provides manual electric pitch trim capability when the autopilot is not engaged.
- **Manual Electric Yaw Trim (MEYT)** — The yaw trim adapter provides manual electric yaw trim capability when the autopilot is not engaged.

7.1 AFCS CONTROLS

The AFCS Control Unit is positioned above the MFD, and has the following controls:

- ① **HDG Key** Selects/deselects Heading Select Mode
- ② **APR Key** Selects/deselects Approach Mode
- ③ **NAV Key** Selects/deselects Navigation Mode
- ④ **FD Key** Activates/deactivates the flight director only
Pressing once turns on the selected flight director in the default vertical and lateral modes. Pressing again deactivates the flight director and removes the Command Bars. If the autopilot is engaged, the key is disabled.
- ⑤ **XFR Key** Transfers between the pilot and copilot flight directors and controls which flight director the autopilot is tracking
- ⑥ **ALT Key** Selects/deselects Altitude Hold Mode
- ⑦ **VS Key** Selects/deselects Vertical Speed Mode
- ⑧ **FLC Key** Selects/deselects Flight Level Change Mode
- ⑨ ①⑦ **CRS Knobs** Adjust the Selected Course (while in VOR, LOC, or OBS Mode) in 1° increments on the Horizontal Situation Indicator (HSI) of the corresponding PFD
Press to re-center the Course Deviation Indicator (CDI) and return course pointer directly TO the bearing of the active waypoint/station
- ⑩ **SPD Key** Toggles Airspeed Reference between IAS and Mach for Flight Level Change Mode
- ⑪ **NOSE UP/DN Wheel** Adjusts the reference in Pitch Hold, Vertical Speed, and Flight Level Change modes
- ⑫ **VNV Key** Selects/deselects Vertical Path Tracking Mode for Vertical Navigation flight control
- ⑬ **ALT SEL Knob** Controls the Selected Altitude in 100-ft increments (a finer resolution of 10 feet is available under approach conditions)
- ⑭ **YD Key** Engages/disengages the yaw damper
- ⑮ **AP Key** Engages/disengages the autopilot
- ⑯ **BANK Key** Manually selects/deselects Low Bank Mode
- ⑰ **BC Key** Selects/deselects Backcourse Mode
- ⑱ **HDG Knob** Adjusts the Selected Heading and bug in 1° increments on the HSI (both PFDs)
Press to synchronize the Selected Heading to the current heading on the pilot-side PFD

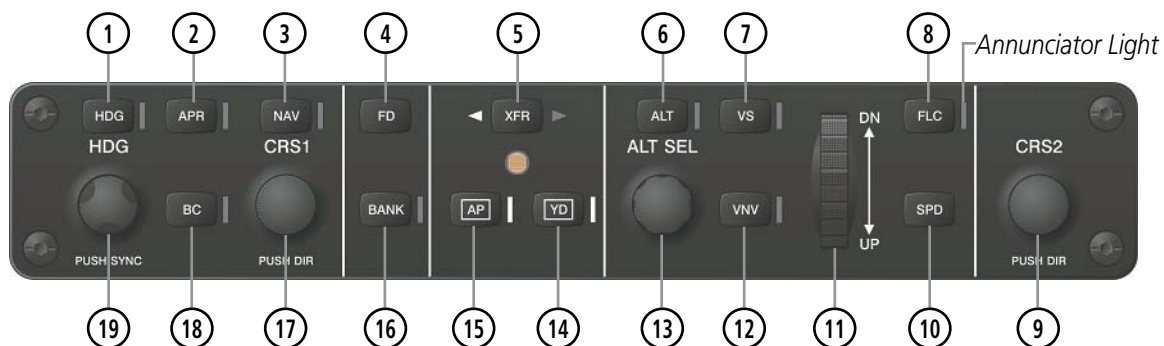

Figure 7-1 GMC 710 AFCS Control Unit

The following AFCS controls are located separately from the AFCS Control Unit:

- | | |
|---|---|
| AP DISC Switch
(Autopilot
Disconnect) | <p>Disengages the autopilot, yaw damper, and flight director and interrupts pitch trim operation</p> <p>An AP DISC Switch is located on each control wheel.</p> <p>This switch may be used to acknowledge an autopilot disconnect alert and mute the associated aural tone.</p> |
| CWS Button
(Control Wheel
Steering) | <p>While pressed, allows manual control of the aircraft while the autopilot is engaged and synchronizes the flight director's Command Bars with the current aircraft pitch (if not in a Vertical Navigation, Glideslope, or Glidepath Mode) and roll (if in Roll Hold Mode)</p> <p>A CWS Button is located on each control wheel.</p> <p>Upon release of the CWS Button, the flight director may establish new pitch and roll references, depending on the current vertical and lateral modes. CWS operation details are discussed in the respective mode sections of this manual.</p> |
| GA Switch
(Go Around) | <p>Disengages the autopilot and selects flight director Takeoff (on ground) or Go Around (in air) Mode</p> <p>If an approach procedure is loaded this switch also activates the missed approach when the selected navigation source is GPS or when the navigation source is VOR/LOC and a valid frequency has been tuned.</p> <p>The GA Switch is located on the throttle.</p> |
| MEPT Switch
(Manual Electric
Pitch Trim) | <p>Used to command manual electric pitch trim</p> <p>An MEPT Switch is located on each control wheel.</p> <p>This composite switch is split into left and right sides. The left switch is the ARM contact and the right switch controls the DN (forward) and UP (rearward) contacts. Pushing the MEPT ARM Switch disengages the autopilot, if currently engaged, but does not affect yaw damper operation. The MEPT ARM Switch may be used to acknowledge an autopilot disconnect alert and mute the associated aural tone.</p> <p>Manual trim commands are generated only when both sides of the switch are operated simultaneously. If either side of the switch is active separately for more than three seconds, MEPT function is disabled and 'PTRM' (Pitch Trim Failure) is displayed as the AFCS Status Annunciation on the PFDs. The function remains disabled until both sides of the switch are inactivated.</p> |
| MEYT Switch
(Manual Electric
Yaw Trim) | <p>Used to command manual electric yaw trim</p> <p>An MEYT Switch is located on each control wheel.</p> |

7.2 FLIGHT DIRECTOR OPERATION

The flight director function provides pitch and roll commands to the AFCS and displays them on the PFDs. With the flight director active, the aircraft can be hand-flown to follow the path shown by the Command Bars. Maximum commanded pitch (-15°, +25°) and roll (25°) angles, vertical acceleration, and roll rate are limited to values established during AFCS certification. The flight director also provides commands to the autopilot.

ACTIVATING THE FLIGHT DIRECTOR

An initial press of a key listed in Table 7-1 (when the flight director is not active) activates the pilot-side flight director in the listed modes. The flight director may be turned off and the Command Bars removed from the displays by pressing the **FD** Key again. The **FD** Key is disabled when the autopilot is engaged.

Control Pressed	Modes Selected			
	Lateral		Vertical	
FD Key	Roll Hold (default)	ROL	Pitch Hold (default)	PIT
AP Key	Roll Hold (default)	ROL	Pitch Hold (default)	PIT
CWS Button	Roll Hold (default)	ROL	Pitch Hold (default)	PIT
GA Switch	Takeoff (on ground) Go Around (in air)	TO GA	Takeoff (on ground) Go Around (in air)	TO GA
ALT Key	Roll Hold (default)	ROL	Altitude Hold	ALT
VS Key	Roll Hold (default)	ROL	Vertical Speed	VS
VNV Key	Roll Hold (default)	ROL	Vertical Path Tracking*	VPTH
NAV Key	Navigation**	GPS VOR LOC	Pitch Hold (default)	PIT
BC Key	Backcourse***	BC	Pitch Hold (default)	PIT
APR Key	Approach**	GPS VOR LOC	Pitch Hold (default)	PIT
HDG Key	Heading Select	HDG	Pitch Hold (default)	PIT

*Valid VNV flight plan must be entered before **VNV** Key press activates flight director.

The selected navigation receiver must have a valid VOR or LOC signal or active GPS course before **NAV or **APR** Key press activates flight director.

***The selected navigation receiver must have a valid LOC signal before **BC** Key press activates flight director.

Table 7-1 Flight Director Activation

AFCS STATUS BOX

Flight director mode annunciations are displayed on the PFDs when the flight director is active. Flight director selection and autopilot and yaw damper statuses are shown in the center of the AFCS Status Box. Lateral flight director modes are displayed on the left and vertical on the right. Armed modes are displayed in white and active in green.

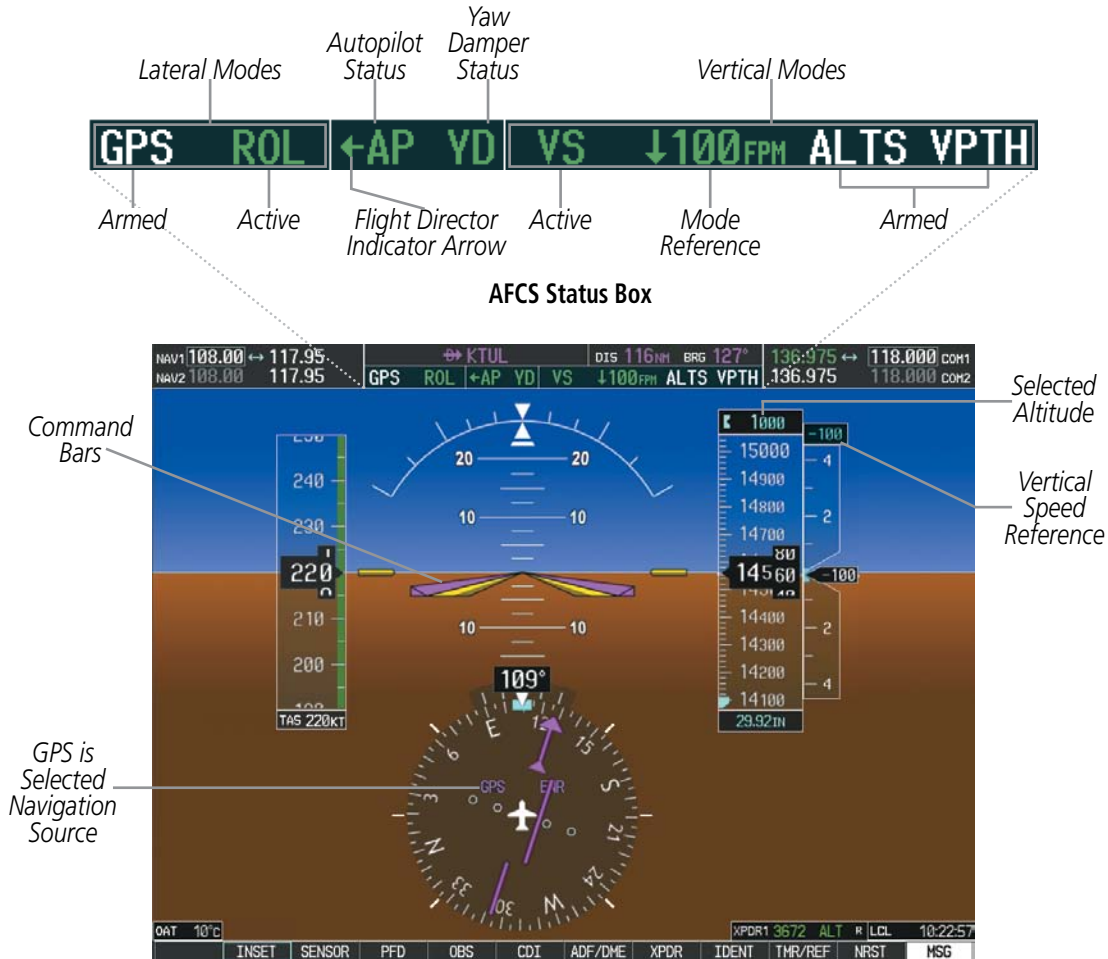

Figure 7-2 PFD AFCS Display

FLIGHT DIRECTOR MODES

Flight director modes are normally selected independently for the pitch and roll axes. Unless otherwise specified, all mode keys are alternate action (i.e., press on, press off). In the absence of specific mode selection, the flight director reverts to the default pitch and/or roll mode(s). Mode keys on the AFCS controller are accompanied by annunciator lights (Figure 7-1) which are illuminated when their respective modes are armed or active.

Armed modes are annunciated in white and active in green in the AFCS Status Box. Under normal operation, when the control for the active flight director mode is pressed, the flight director reverts to the default mode(s) for the axis(es). Automatic transition from armed to active mode is indicated by the white armed mode annunciation moving to the green active mode field and flashing for 10 seconds.

If the information required to compute a flight director mode becomes invalid or unavailable, the flight director automatically reverts to the default mode for that axis. A flashing yellow mode annunciation and annunciator light indicate loss of sensor (ADC) or navigation data (VOR, LOC, GPS, VNV, SBAS) required to compute commands. When such a loss occurs, the system automatically begins to roll the wings level (enters Roll Hold Mode) or maintain the pitch angle (enters Pitch Hold Mode), depending on the affected axis. The flashing annunciation stops when the affected mode key is pressed or another mode for the axis is selected. If after 10 seconds no action is taken, the flashing annunciation stops.



Figure 7-3 Loss of VOR Signal

The flight director is automatically disabled if the attitude information required to compute the default flight director modes becomes invalid or unavailable.

SWITCHING FLIGHT DIRECTORS

The GFC 700 in the Socata TBM 850 has two flight directors, each operating within an IAU. The autopilot follows the selected flight director only, indicated by an arrow pointing toward either the pilot or copilot side, in the center of the AFCS Status Box. Flight directors may be switched by pressing the **XFR** Key. The annunciator light arrow for the selected flight director is also illuminated beside the **XFR** Key. When the flight directors are switched, the vertical and lateral modes revert to default.

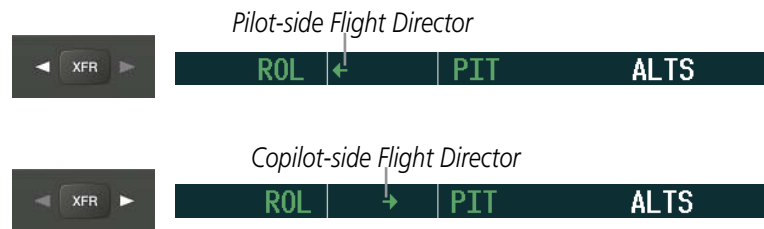

Figure 7-4 Flight Director Selection Indications

COMMAND BARS

Upon activation of the flight director, Command Bars are displayed in magenta on the PFDs as a single-cue. The Command Bars do not override the (yellow) Aircraft Symbol. The single-cue Command Bars (Figure 7-5) move together vertically to indicate pitch commands and bank left or right to indicate roll commands.

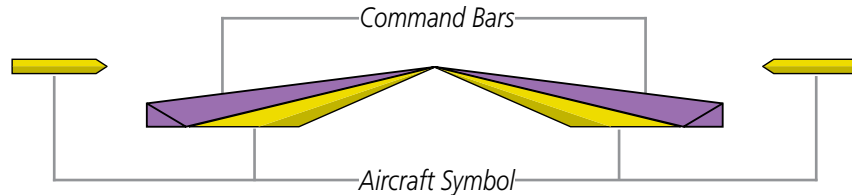

Figure 7-5 Single-cue Command Bars

If the attitude information being sent to the flight director becomes invalid or unavailable, the Command Bars are removed from the display. The flight director Command Bars also disappear if the pitch exceeds $+30^{\circ}/-20^{\circ}$ or bank exceeds 65° .

7.3 VERTICAL MODES

Table 7-2 lists the vertical modes with their corresponding controls and annunciations. The mode reference is displayed next to the active mode annunciation for Altitude Hold, Vertical Speed, and Flight Level Change modes. The **NOSE UP/DN** Wheel can be used to change the vertical mode reference while operating under Pitch Hold, Vertical Speed, or Flight Level Change Mode. Increments of change and acceptable ranges of values for each of these references using the **NOSE UP/DN** Wheel are also listed in the table.

Vertical Mode	Description	Control	Annunciation	Reference Range	Reference Change Increment
Pitch Hold	Holds the current aircraft pitch attitude; may be used to climb/descend to the Selected Altitude	(default)	PIT	-15° to +25°	0.5°
Selected Altitude Capture	Captures the Selected Altitude	*	ALTS		
Altitude Hold	Holds the current Altitude Reference	ALT Key	ALT nnnnn FT		
Vertical Speed	Maintains the current aircraft vertical speed; may be used to climb/descend to the Selected Altitude	VS Key	VS nnnn FPM	-4000 to +3000 fpm	100 fpm
Flight Level Change, IAS Hold	Maintains the current aircraft airspeed (in IAS or Mach) while the aircraft is climbing/descending to the Selected Altitude	FLC Key	FLC nnn KT	80 to 265 kts	1 kt
Flight Level Change, Mach Hold			FLC M .nnn	M 0.20 to 0.69	M 0.01
Vertical Path Tracking	Captures and tracks descent legs of an active vertical profile	VNV Key	VPTH		
VNV Target Altitude Capture	Captures the Vertical Navigation (VNV) Target Altitude	**	ALTV		
Glidepath	Captures and tracks the WAAS glidepath on approach	APR Key	GP		
Glideslope	Captures and tracks the ILS glideslope on approach		GS		
Takeoff	Commands a constant pitch angle and wings level on the ground in preparation for takeoff	GA Switch	TO	7.5°	
Go Around	Disengages the autopilot and commands a constant pitch angle and wings level in the air		GA	7.5°	

* *ALTS armed automatically when PIT, VS, FLC, TO, or GA active, and under VPTH when Selected Altitude is to be captured instead of VNV Target Altitude*

** *ALTV armed automatically under VPTH when VNV Target Altitude is to be captured instead of Selected Altitude*

Table 7-2 Flight Director Vertical Modes

PITCH HOLD MODE (PIT)

When the flight director is activated (the **FD** Key is pressed) or switched (the **XFR** Key is pressed), Pitch Hold Mode is selected by default. Pitch Hold Mode is indicated as the active vertical mode by the ‘PIT’ annunciation. This mode may be used for climb or descent to the Selected Altitude (shown above the Altimeter), since Selected Altitude Capture Mode is automatically armed when Pitch Hold Mode is activated.

In Pitch Hold Mode, the flight director maintains a constant pitch attitude, the pitch reference. The pitch reference is set to the aircraft pitch attitude at the moment of mode selection. If the aircraft pitch attitude exceeds the flight director pitch command limitations, the flight director commands a pitch angle equal to the nose-up/down limit.

CHANGING THE PITCH REFERENCE

When operating in Pitch Hold Mode, the pitch reference can be adjusted by:

- Using the **NOSE UP/DN** Wheel
- Pressing the **CWS** Button, hand-flying the aircraft to establish a new pitch reference, then releasing the **CWS** Button

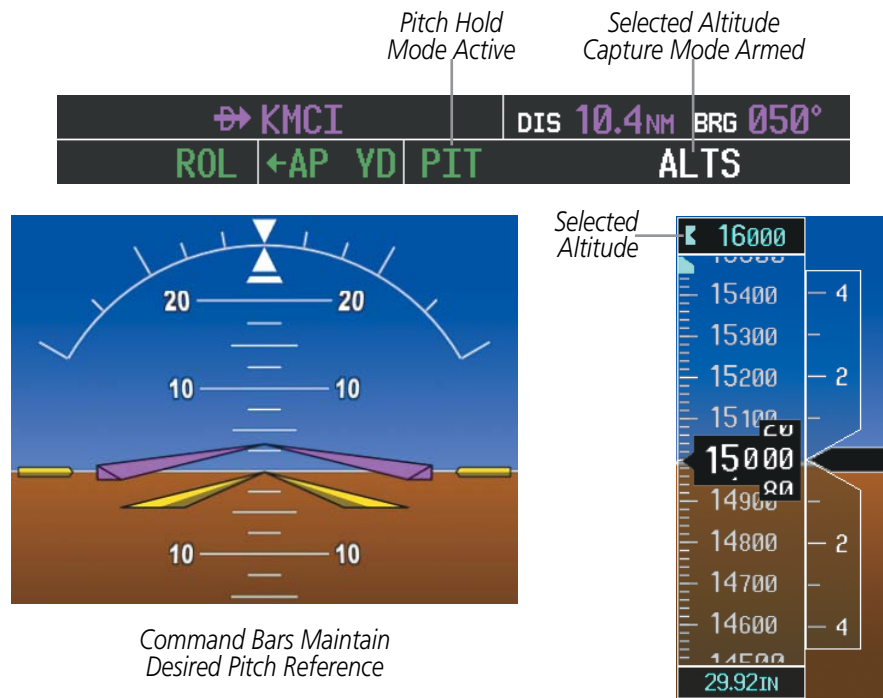

Figure 7-6 Pitch Hold Mode

SELECTED ALTITUDE CAPTURE MODE (ALTS)

Selected Altitude Capture Mode is automatically armed with activation of the following modes:

- Pitch Hold
- Vertical Speed
- Flight Level Change
- Go Around
- Vertical Path Tracking (if the Selected Altitude is to be captured instead of the VNV Target Altitude)

The white ‘ALTS’ annunciation indicates Selected Altitude Capture Mode is armed (see Figure 7-6 for example). The **ALT SEL** Knob is used to set the Selected Altitude (shown above the Altimeter) until Selected Altitude Capture Mode becomes active.

As the aircraft nears the Selected Altitude, the flight director automatically transitions to Selected Altitude Capture Mode with Altitude Hold Mode armed (Figure 7-7). This automatic transition is indicated by the green ‘ALTS’ annunciation flashing for up to 10 seconds and the appearance of the white ‘ALT’ annunciation. The Selected Altitude is shown as the Altitude Reference beside the ‘ALTS’ annunciation.

At 50 feet from the Selected Altitude, the flight director automatically transitions from Selected Altitude Capture to Altitude Hold Mode and holds the Selected Altitude (shown as the Altitude Reference). As Altitude Hold Mode becomes active, the white ‘ALT’ annunciation moves to the active vertical mode field and flashes green for 10 seconds to indicate the automatic transition.

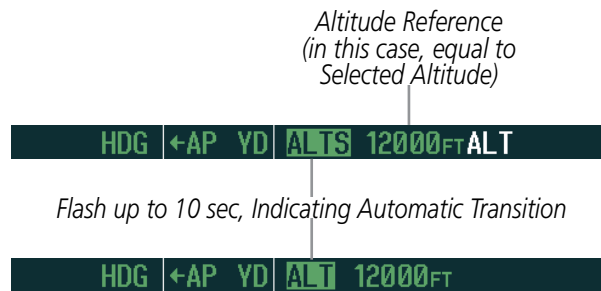

Figure 7-7 Automatic Mode Transitions During Altitude Capture

CHANGING THE SELECTED ALTITUDE



NOTE: Pressing the **CWS** Button while in Selected Altitude Capture Mode does not cancel the mode.

Use of the **ALT SEL** Knob to change the Selected Altitude while Selected Altitude Capture Mode is active causes the flight director to revert to Pitch Hold Mode with Selected Altitude Capture Mode armed for the new Selected Altitude.

ALTITUDE HOLD MODE (ALT)

Altitude Hold Mode can be activated by pressing the **ALT** Key; the flight director maintains the current aircraft altitude (to the nearest 10 feet) as the Altitude Reference. The flight director's Altitude Reference, shown in the AFCS Status Box, is independent of the Selected Altitude, displayed above the Altimeter. Altitude Hold Mode active is indicated by a green 'ALT' annunciation in the AFCS Status Box.

Altitude Hold Mode is automatically armed when the flight director is in Selected Altitude Capture Mode (see Figure 7-7). Selected Altitude Capture Mode automatically transitions to Altitude Hold Mode when the altitude error is less than 50 feet. In this case, the Selected Altitude becomes the flight director's Altitude Reference.

CHANGING THE ALTITUDE REFERENCE

NOTE: Turning the **ALT SEL** Knob while in Altitude Hold Mode changes the Selected Altitude, but not the flight director's Altitude Reference, and does not cancel the mode.

With the **CWS** Button depressed, the aircraft can be hand-flown to a new Altitude Reference. When the **CWS** Button is released at the desired altitude, the new altitude is established as the Altitude Reference.

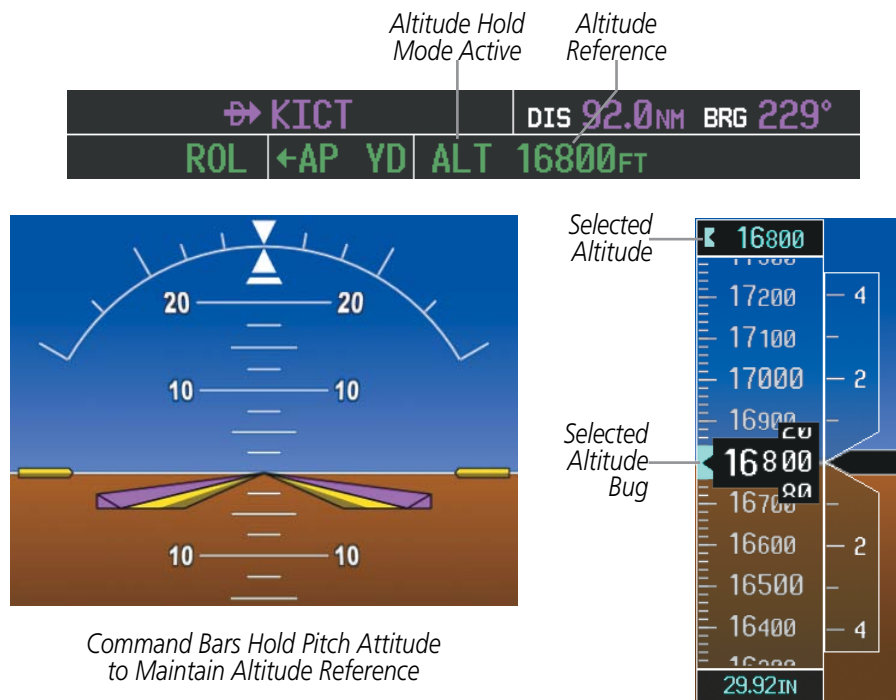

Figure 7-8 Altitude Hold Mode

VERTICAL SPEED MODE (VS)

In Vertical Speed Mode, the flight director acquires and maintains a Vertical Speed Reference. Current aircraft vertical speed (to the nearest 100 fpm) becomes the Vertical Speed Reference at the moment of Vertical Speed Mode activation. This mode may be used for climb or descent to the Selected Altitude (shown above the Altimeter) since Selected Altitude Capture Mode is automatically armed when Vertical Speed Mode is selected.

When Vertical Speed Mode is activated by pressing the **VS** Key, 'VS' is annunciated in green in the AFCS Status Box along with the Vertical Speed Reference. The Vertical Speed Reference is also displayed above the Vertical Speed Indicator. A Vertical Speed Reference Bug corresponding to the Vertical Speed Reference is shown on the indicator.

CHANGING THE VERTICAL SPEED REFERENCE

The Vertical Speed Reference (shown both in the AFCS Status Box and above the Vertical Speed Indicator) may be changed by:

- Using the **NOSE UP/DN** Wheel
- Pressing the **CWS** Button, hand-flying the aircraft to attain a new Vertical Speed Reference, then releasing the **CWS** Button



NOTE: If the Selected Altitude is reached during CWS maneuvering, the Altitude Reference is not changed. To adjust the Altitude Reference in this case, the **CWS** Button must be pressed again after the Selected Altitude is reached.

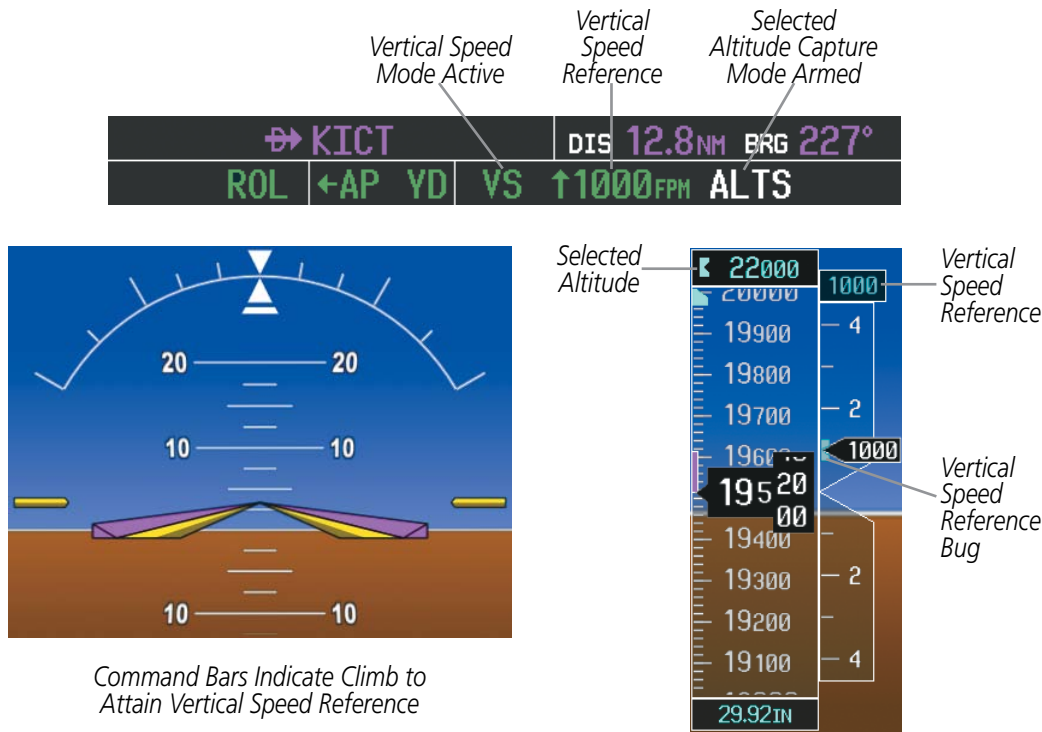

Figure 7-9 Vertical Speed Hold Mode

FLIGHT LEVEL CHANGE MODE (FLC)

NOTE: *The Selected Altitude should be set before selecting Flight Level Change Mode.*

Flight Level Change Mode is selected by pressing the **FLC** Key. This mode acquires and maintains the Airspeed Reference (in IAS or Mach) while climbing or descending to the Selected Altitude (shown above the Altimeter). When Flight Level Change Mode is active, the flight director continuously monitors Selected Altitude, airspeed, Mach, and altitude.

The Airspeed Reference is set to the current airspeed upon mode activation. Flight Level Change Mode is indicated by a green 'FLC' annunciation beside the Airspeed Reference in the AFCS Status Box. The Airspeed Reference is also displayed directly above the Airspeed Indicator, along with a bug corresponding to the Airspeed Reference along the tape.

Engine power must be adjusted to allow the autopilot to fly the aircraft at a pitch attitude corresponding to the desired flight profile (climb or descent) while maintaining the Airspeed Reference. The flight director maintains the current altitude until either engine power or the Airspeed Reference are adjusted and does not allow the aircraft to climb or descend away from the Selected Altitude.

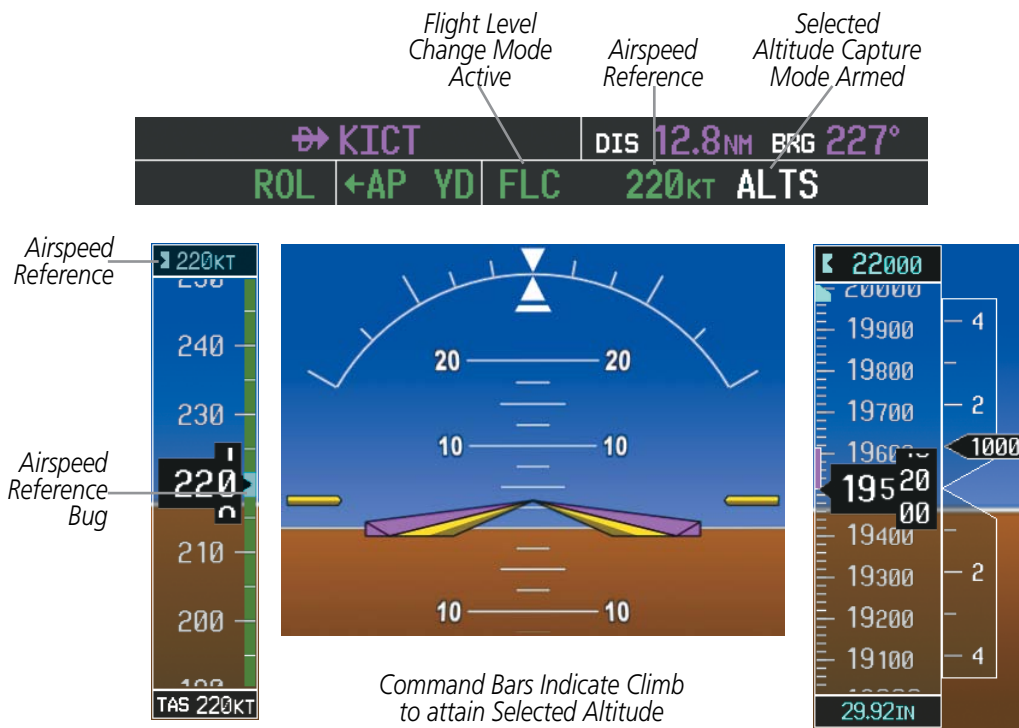

Figure 7-10 Flight Level Change Mode (IAS)

CHANGING THE AIRSPEED REFERENCE

The Airspeed Reference (shown in both the AFCS Status Box and above the Airspeed Indicator) may be adjusted by:

- Using the **NOSE UP/DN** Wheel
- Pressing the **CWS** Button, hand-flying the aircraft to attain a new Airspeed Reference, then releasing the **CWS** Button



NOTE: *If the Selected Altitude is reached during CWS maneuvering, the Altitude Reference is not changed. To adjust the Altitude Reference in this case, the **CWS** Button must be pressed again after the Selected Altitude is reached.*

Airspeed Reference units can be manually toggled between IAS and Mach units using the **SPD** Key. When the FLC Airspeed Reference is displayed in Mach, the Airspeed Reference Bug is displayed on the Airspeed Indicator at the IAS corresponding to the selected Mach target speed and the current Mach number is shown below the Airspeed Indicator.

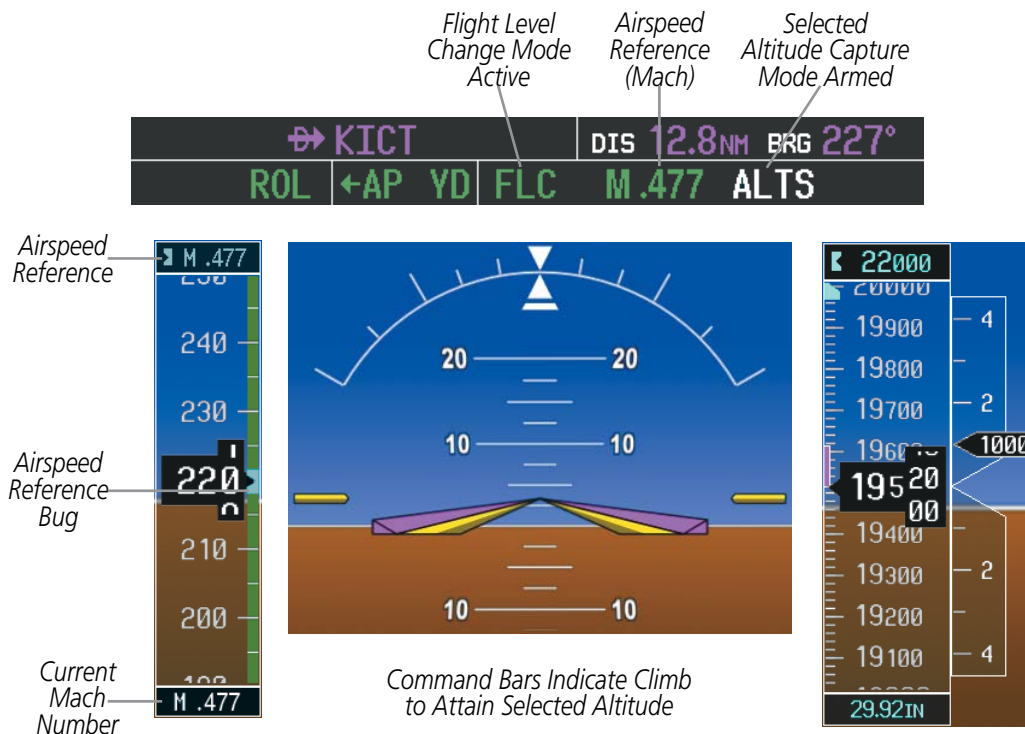



Figure 7-11 Flight Level Change Mode (Mach)

VERTICAL NAVIGATION MODES (VPTH, ALTV)

 **NOTE:** VNV is disabled when parallel track or Dead Reckoning Mode is active. Refer to the Flight Management Section for more information on VNV flight plans.

 **NOTE:** The Selected Altitude takes precedence over any other vertical constraints.

Vertical Navigation (VNV) flight control is available for enroute/terminal cruise and descent operations when VNV flight planning is available. Conditions for availability include, but are not limited to:

- The selected navigation source is GPS.
- A VNV flight plan (with at least one altitude-constrained waypoint) or vertical direct-to is active.
- VNV is enabled (**VNV ENBL** Softkey pressed on the MFD).
- Crosstrack error is valid and within certain limits.
- Desired/actual track are valid or track angle error is within certain limits.
- The VNV Target Altitude of the active waypoint is no more than 250 ft above the current aircraft altitude.

The flight director may be armed for VNV at any time, but no target altitudes are captured during a climb. The Command Bars provide vertical profile guidance based on specified altitudes (entered manually or loaded from the database) at waypoints in the active flight plan or vertical direct-to. The appropriate VNV flight control modes are sequenced by the flight director to follow the path defined by the vertical profile. Upon reaching the last waypoint in the VNV flight plan, the flight director transitions to Altitude Hold Mode and cancels any armed VNV modes.

VERTICAL PATH TRACKING MODE (VPTH)

 **NOTE:** If another vertical mode key is pressed while Vertical Path Tracking Mode is selected, Vertical Path Tracking Mode reverts to armed.

 **NOTE:** Pressing the **CWS** Button while Vertical Path Tracking Mode is active does not cancel the mode. The autopilot guides the aircraft back to the descent path upon release of the **CWS** Button.

When a vertical profile (VNV flight plan) is active and the **VNV** Key is pressed, Vertical Path Tracking Mode is armed in preparation for descent path capture. 'VPTH' (or 'V' when Glidepath or Glideslope Mode is concurrently armed) is annunciated in white in addition to previously armed modes. If applicable, the appropriate altitude capture mode is armed for capture of the next VNV Target Altitude (ALTV) or the Selected Altitude (ALTS), whichever is greater.

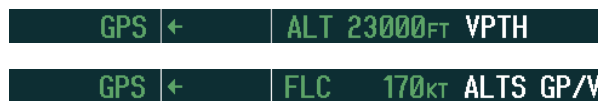

Figure 7-12 Vertical Path Tracking Armed Annunciations

Prior to descent path interception, the Selected Altitude must be set below the current aircraft altitude by at least 75 feet. For the flight director to transition from Altitude Hold to Vertical Path Tracking Mode, acknowledgment is required within five minutes of descent path interception by:

- Pressing the **VNV** Key
- Adjusting the Selected Altitude

If acknowledgment is not received within 1 minute of descent path interception, the white 'VPTH' annunciation starts to flash. Flashing continues until acknowledged or the descent path is intercepted. If the descent is not confirmed by the time of interception, Vertical Path Tracking Mode remains armed and the descent is not captured.

In conjunction with the "TOD [top of descent] within 1 minute" annunciation in the PFD Navigation Status Box and the "Vertical track" voice message, VNV indications (VNV Target Altitude, vertical deviation, and vertical speed required) appear on the PFDs in magenta (Figure 7-13).

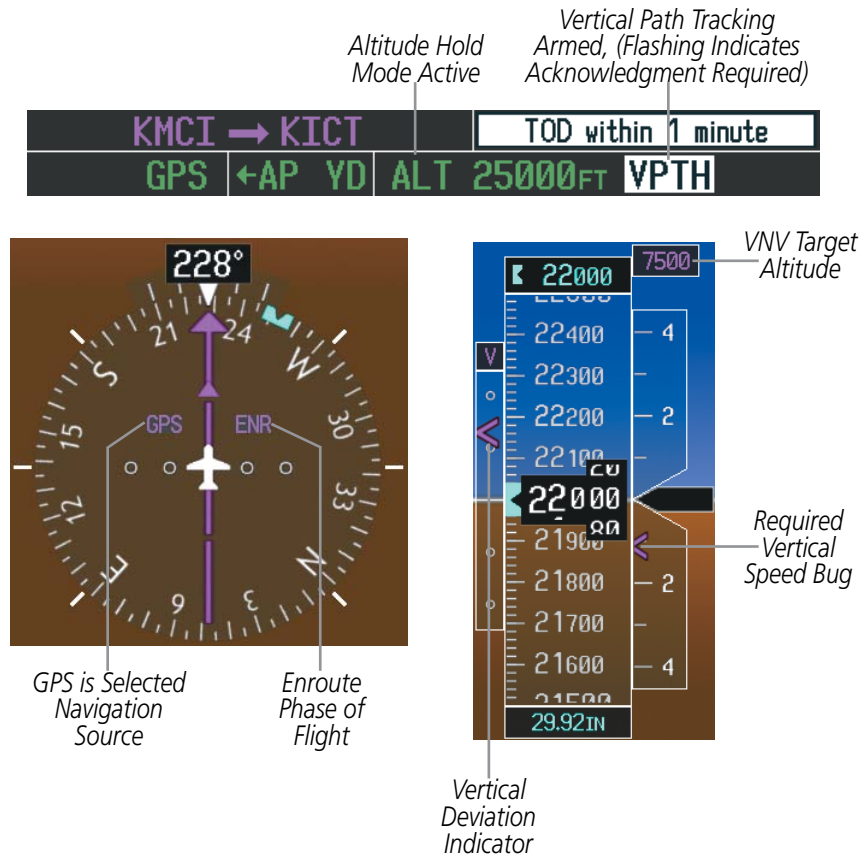

Figure 7-13 Vertical Path Capture

When a descent leg is captured (i.e., vertical deviation becomes valid), Vertical Path Tracking becomes active and tracks the descent profile (Figure 7-14). An altitude capture mode ('ALTS' or 'ALTV') is armed as appropriate.

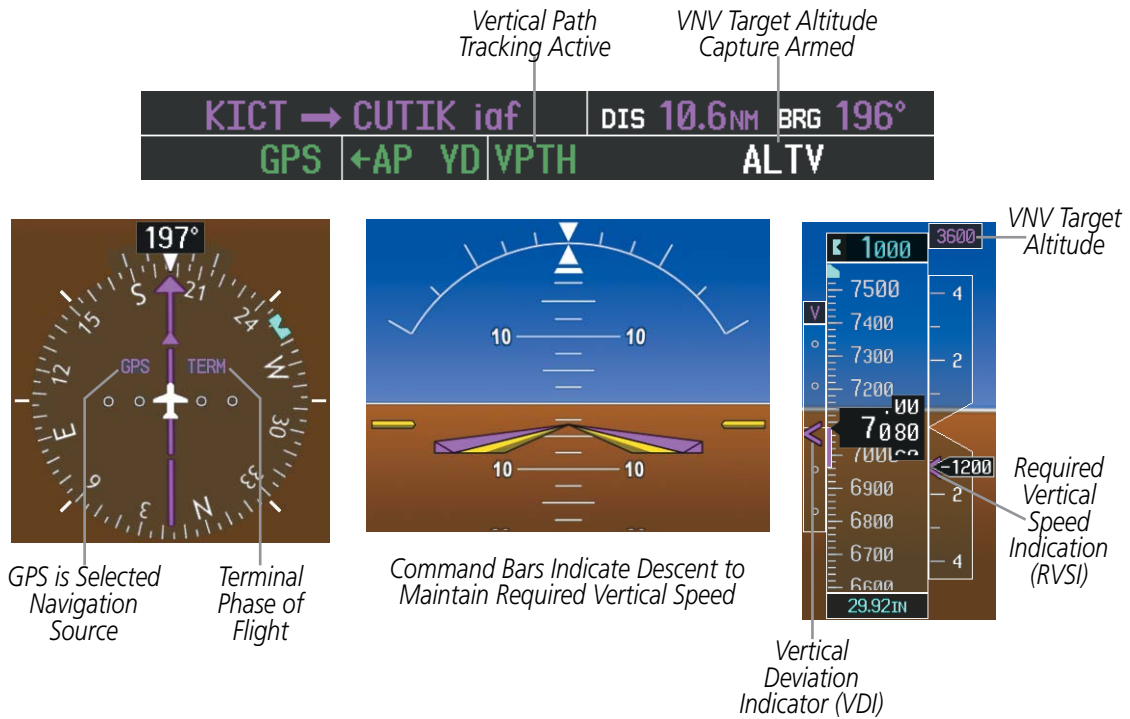

Figure 7-14 Vertical Path Tracking Mode

If the altimeter barometric setting is adjusted while Vertical Path Tracking is active, the flight director increases/decreases the descent rate by up to 500 fpm to re-establish the aircraft on the descent path (without commanding a climb). Adjusting the altimeter barometric setting creates discontinuities in VNV vertical deviation, moving the descent path. For large adjustments, it may take several minutes for the aircraft to re-establish on the descent path. If the change is made while nearing a waypoint with a VNV Target Altitude, the aircraft may not re-establish on the descent path in time to meet the vertical constraint.

AUTOMATIC REVERSION TO PITCH HOLD MODE

Several situations can occur while Vertical Path Tracking Mode is active which cause the flight director to revert to Pitch Hold Mode:

- Vertical deviation exceeds 200 feet during an overspeed condition.
- Vertical deviation experiences a discontinuity that both exceeds 200 feet in magnitude and results in the vertical deviation exceeding 200 feet in magnitude. Such discontinuities are usually caused by flight plan changes that affect the vertical profile.
- Vertical deviation becomes invalid (the Vertical Deviation Indicator is removed from the PFD).
- A display enters Reversionary Mode (this does not apply to an active vertical direct-to).

Unless VNV is disabled, Vertical Path Tracking Mode and the appropriate altitude capture mode become armed following the reversion to Pitch Hold Mode to allow for possible profile recapture.

NON-PATH DESCENTS

Pitch Hold, Vertical Speed, and Flight Level Change modes can also be used to fly non-path descents while VNV flight control is selected. If the **VS** or **FLC** Key is pressed while Vertical Path Tracking Mode is selected, Vertical Path Tracking Mode reverts to armed along with the appropriate altitude capture mode to allow profile re-capture.



Figure 7-15 Flight Level Change VNV Non-Path Descent

To prevent immediate profile re-capture, the following must be satisfied:

- At least 10 seconds have passed since the non-path transition was initiated
- Vertical deviation from the profile has exceeded 250 feet, but is now less than 200 feet

Pressing the **VNV** Key twice re-arms Vertical Path Tracking for immediate profile re-capture.

VNV TARGET ALTITUDE CAPTURE MODE (ALTV)

NOTE: Armed VNV Target Altitude and Selected Altitude capture modes are mutually exclusive. However, Selected Altitude Capture Mode is armed implicitly (not annunciated) whenever VNV Target Altitude Capture Mode is armed.

VNV Target Altitude Capture is analogous to Selected Altitude Capture Mode and is armed automatically after the **VNV** Key is pressed and the next VNV Target Altitude is to be intercepted before the Selected Altitude. The annunciation ‘ALTV’ indicates that the VNV Target Altitude is to be captured. VNV Target Altitudes are shown in the active flight plan or vertical direct-to, and can be entered manually or loaded from a database (see the Flight Management Section for details). At the same time as “TOD within 1 minute” is annunciated in the Navigation Status Box, the active VNV Target Altitude is displayed above the Vertical Speed Indicator (see Figure 7-13).

As the aircraft nears the VNV Target Altitude, the flight director automatically transitions to VNV Target Altitude Capture Mode with Altitude Hold Mode armed. This automatic transition is indicated by the green ‘ALTV’ annunciation flashing for up to 10 seconds and the appearance of the white ‘ALT’ annunciation. The VNV Target Altitude is shown as the Altitude Reference beside the ‘ALTV’ annunciation and remains displayed above the Vertical Speed Indicator. The Required Vertical Speed Indication (RVSI) is removed once VNV Target Altitude Capture Mode becomes active.

At 50 feet from the VNV Target Altitude, the flight director automatically transitions from VNV Target Altitude Capture to Altitude Hold Mode and tracks the level leg. As Altitude Hold Mode becomes active, the white ‘ALT’ annunciation moves to the active vertical mode field and flashes green for 10 seconds to indicate the automatic transition. The flight director automatically arms Vertical Path Tracking, allowing upcoming descent legs to be captured and subsequently tracked.

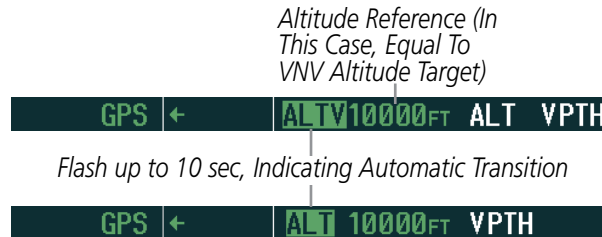

Figure 7-16 VNV Altitude Capture

CHANGING THE VNV TARGET ALTITUDE

NOTE: Pressing the **CWS** Button while in VNV Target Altitude Capture Mode does not cancel the mode.

Changing the current VNV Target Altitude while VNV Target Altitude Capture Mode is active causes the flight director to revert to Pitch Hold Mode. Vertical Path Tracking and the appropriate altitude capture mode are armed in preparation to capture the new VNV Target Altitude or the Selected Altitude, depending on which altitude is to be intercepted first.

VNV target altitudes can be changed while editing the active flight plan (see the Flight Management Section for details).

GLIDEPATH MODE (GP)



NOTE: Pressing the **CWS** Button while Glidepath Mode is active does not cancel the mode. The autopilot guides the aircraft back to the glidepath upon release of the **CWS** Button.

Glidepath Mode is used to track the WAAS-based glidepath. When Glidepath Mode is armed, 'GP' is annunciated in white in the AFCS Status Box.

Selecting Glidepath Mode:

- 1) Ensure a GPS approach with vertical guidance (LPV, LNAV/VNAV, LNAV+V) is loaded into the active flight plan. The active waypoint must be part of the flight plan (cannot be a direct-to a waypoint not in the flight plan).
- 2) Ensure that GPS is the selected navigation source (use the **CDI** Softkey to cycle through navigation sources if necessary).
- 3) Press the **APR** Key.



NOTE: Some RNAV (GPS) approaches provide a vertical descent angle as an aid in flying a stabilized approach. These approaches are **NOT** considered Approaches with Vertical Guidance (APV). Approaches that are annunciated on the HSI as LNAV or LNAV+V are considered Nonprecision Approaches (NPA) and are flown to an MDA even though vertical glidepath (GP) information may be provided.



WARNING: When flying an LNAV approach (with vertical descent angle) with the autopilot coupled, the aircraft will not level off at the MDA even if the MDA is set in the altitude preselect.

Upon reaching the glidepath, the flight director transitions to Glidepath Mode and begins to capture and track the glidepath.

GPS +AP YD VPTH ALTS GP

Figure 7-17 Glidepath Mode Armed

Once the following conditions have been met, the glidepath can be captured:

- The active waypoint is at or after the final approach fix (FAF).
- Vertical deviation is valid.
- The CDI is at less than full scale deviation
- Automatic sequencing of waypoints has not been suspended (no 'SUSP' annunciation on the HSI)

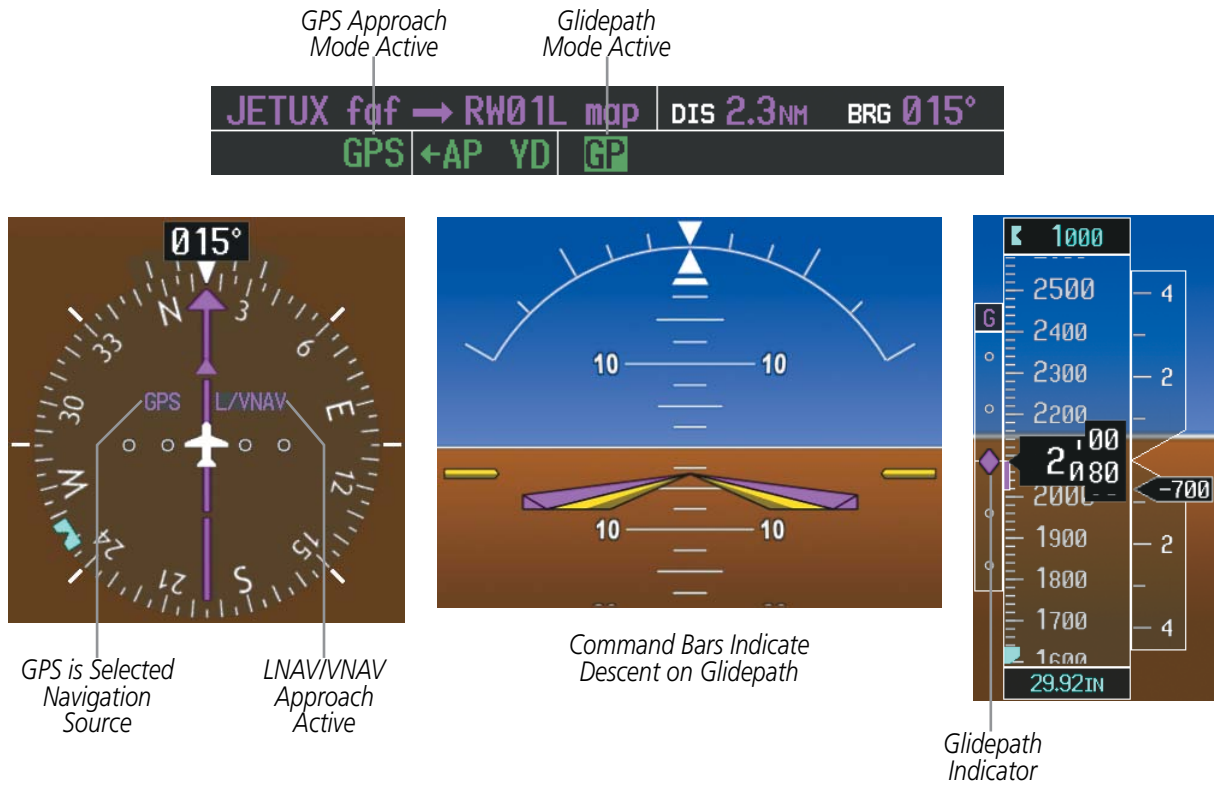

Figure 7-18 Glidepath Mode

GLIDESLOPE MODE (GS)

NOTE: Pressing the **CWS** Button while Glideslope Mode is active does not cancel the mode. The autopilot guides the aircraft back to the glideslope upon release of the **CWS** Button.

Glideslope Mode is available for LOC/ILS approaches to capture and track the glideslope. When Glideslope Mode is armed (annunciated as 'GS' in white), LOC Approach Mode is armed as the lateral flight director mode.

Selecting Glideslope Mode:

- 1) Ensure a valid localizer frequency is tuned.
- 2) Ensure that LOC is the selected navigation source (use the **CDI** Softkey to cycle through navigation sources if necessary).
- 3) Press the **APR** Key.

Or:

- 1) Ensure that GPS is the selected navigation source (use the **CDI** Softkey to cycle through navigation sources if necessary).
- 2) Ensure a LOC/ILS approach is loaded into the active flight plan.
- 3) Ensure the corresponding LOC frequency is tuned.
- 4) Press the **APR** Key.



Figure 7-19 Glideslope Mode Armed

Once LOC is the navigation source, the localizer and glideslope can be captured. Upon reaching the glideslope, the flight director transitions to Glideslope Mode and begins to capture and track the glideslope.

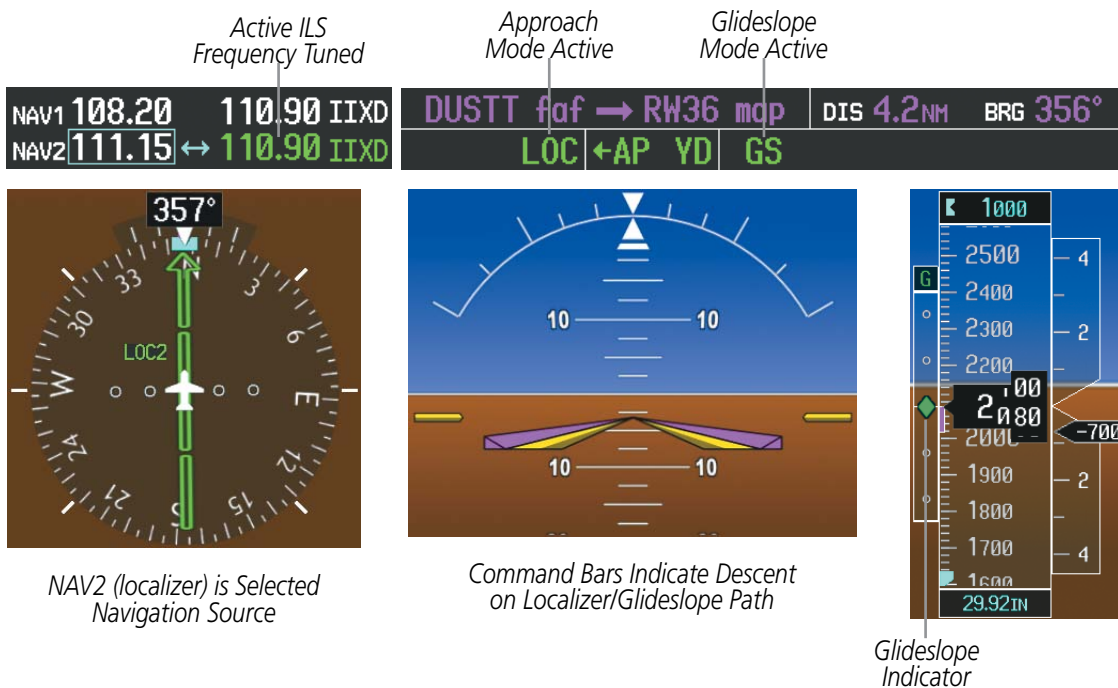

Figure 7-20 Glideslope Mode

TAKEOFF (TO) AND GO AROUND (GA) MODES

In Takeoff and Go Around modes, the flight director commands a constant set pitch attitude. The **GA** Switch is used to select both modes. The mode entered by the flight director depends on whether the aircraft is on the ground. Selected Altitude Capture Mode is automatically armed when the aircraft is at least 400 feet below the Selected altitude at the time Takeoff or Go Around Mode is selected.

Takeoff Mode provides an attitude reference during rotation and takeoff. This mode can be selected only while on the ground by pushing the **GA** Switch. The flight director Command Bars assume a wings-level, pitch-up attitude. Autopilot engagement while Takeoff Mode is active is inhibited while the aircraft is on the ground.

Pressing the **GA** Switch while in the air activates the flight director in a wings-level, pitch-up attitude, allowing the execution of a missed approach or a go around. Selecting Go Around Mode disengages the autopilot; however subsequent autopilot engagement is allowed. Attempts to modify the aircraft attitude (i.e., with the **NOSE UP/DN** Wheel or **CWS** Button) result in reversion to Pitch Hold Mode.

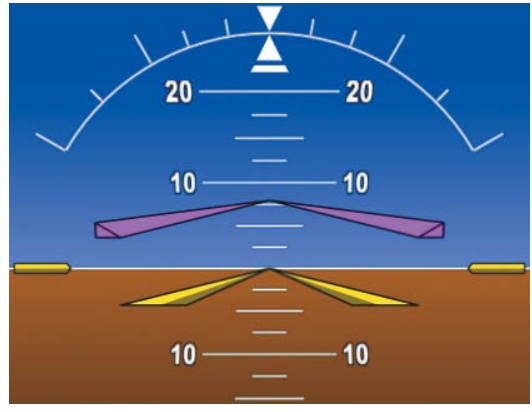
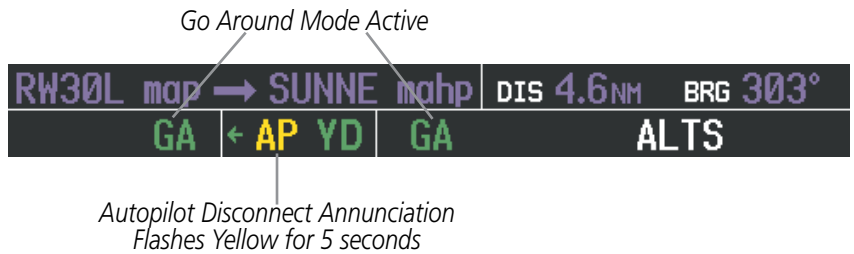

Command Bars Indicate Climb

Figure 7-21 Go Around Mode

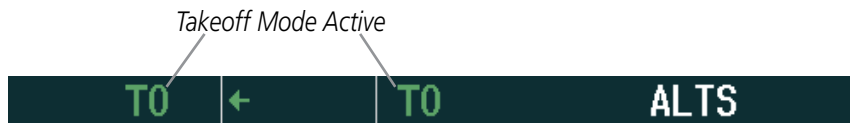

Figure 7-22 Takeoff Mode

7.4 LATERAL MODES

The following table relates each GFC 700 lateral mode to its respective control and annunciation. Refer to the vertical modes section for information regarding Takeoff and Go Around modes.



NOTE: The GFC 700 may generate a lower bank angle than the maximum roll command limit in degrees indicated in table 7-3 by the amount needed to produce a turn rate equal to or less than standard rate.

Lateral Mode	Description	Control	Annunciation	Maximum Roll Command Limit
Roll Hold	Holds the current aircraft roll attitude or rolls the wings level, depending on the commanded bank angle	(default)	ROL	25°
Low Bank	Limits the maximum commanded roll angle	BANK Key	*	15°
Heading Select **	Captures and tracks the Selected Heading	HDG Key	HDG	25°
Navigation, GPS **	Captures and tracks the selected navigation source (GPS, VOR, LOC)	NAV Key	GPS	25°
Navigation, VOR Enroute Capture/Track **			VOR	25° Capture 10° Track
Navigation, LOC Capture/Track (No Glideslope)			LOC	25° Capture 10° Track
Backcourse Capture/Track	Captures and tracks a localizer signal for backcourse approaches	BC Key	BC	25° Capture 10° Track
Approach, GPS	Captures and tracks the selected navigation source (GPS, VOR, LOC)	APR Key	GPS	25°
Approach, VOR Capture/Track			VAPP	25° Capture 10° Track
Approach, LOC Capture/Track (Glideslope Mode automatically armed)			LOC	25° Capture 10° Track
Takeoff	Commands a constant pitch angle and wings level on the ground in preparation for takeoff	GA Switch	TO	Wings Level
Go Around	Disengages the autopilot and commands a constant pitch angle and wings level in the air		GA	Wings Level

* No annunciation appears in the AFCS Status Box. The acceptable bank angle range is indicated in green along the Roll Scale of the Attitude Indicator.

** The Heading, Navigation GPS and Navigation VOR mode maximum roll command limit will be limited to the Low Bank mode value if it is engaged.

Table 7-3 Flight Director Lateral Modes

The **CWS** Button does not change lateral references for Heading Select, Navigation, Backcourse, or Approach Mode. The autopilot guides the aircraft back to the Selected Heading/Course upon release of the **CWS** Button.

ROLL HOLD MODE (ROL)



NOTE: If Roll Hold Mode is activated as a result of a mode reversion, the flight director rolls wings level.

When the flight director is activated or switched, Roll Hold Mode is selected by default. This mode is annunciated as 'ROL' in the AFCS Status Box. The current aircraft bank angle is held, subject to the bank angle condition.

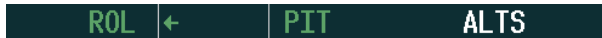

Figure 7-23 Roll Hold Mode Annunciation

Bank Angle	Flight Director Response
< 6°	Rolls wings level
6 to 30°	Maintains current aircraft roll attitude
> 30°	Limits bank to 30°

Table 7-4 Roll Hold Mode Responses

CHANGING THE ROLL REFERENCE

The roll reference can be changed by pressing the **CWS** Button, establishing the desired bank angle, then releasing the **CWS** Button.

LOW BANK MODE

When in Low Bank Mode, the flight director limits the maximum commanded roll angle to 15°. Low bank arc limits are displayed in green along the Roll Scale.

Low Bank Mode can be manually selected/deselected by pressing the **BANK** Key while in Heading Select or Navigation Modes (GPS and VOR). Low Bank Mode is activated automatically climbing above 25,000 ft (FL250), and deactivated when descending below 25,000 ft. The annunciator light next to the **BANK** Key illuminates while Low Bank Mode is selected.

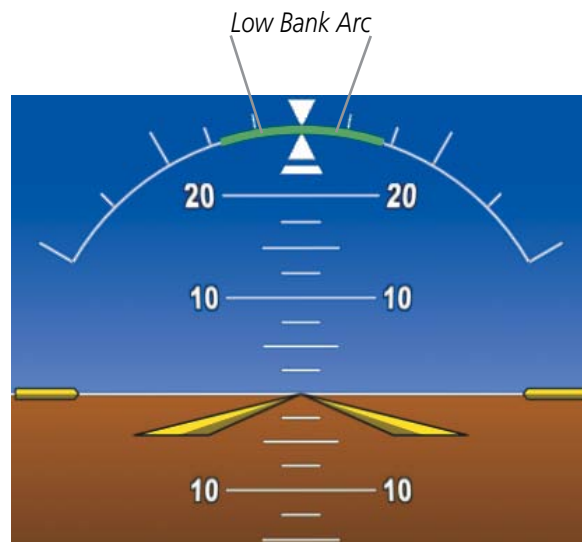

Figure 7-24 Low Bank Mode Limits

HEADING SELECT MODE (HDG)

Heading Select Mode is activated by pressing the **HDG** Key. Heading Select Mode acquires and maintains the Selected Heading. The Selected Heading is shown by a light blue bug on the HSI and in the box to the upper left of the HSI.

CHANGING THE SELECTED HEADING

NOTE: Pressing the **HDG** Knob synchronizes the Selected Heading to the current heading.

The Selected Heading is adjusted using the **HDG** Knob. Pressing the **CWS** Button and hand-flying the aircraft does not change the Selected Heading. The autopilot guides the aircraft back to the Selected Heading upon release of the **CWS** Button.

Turns are commanded in the same direction as Selected Heading Bug movement, even if the bug is turned more than 180° from the present heading (e.g., a 270° turn to the right). However, Selected Heading changes of more than 330° at a time result in turn reversals.

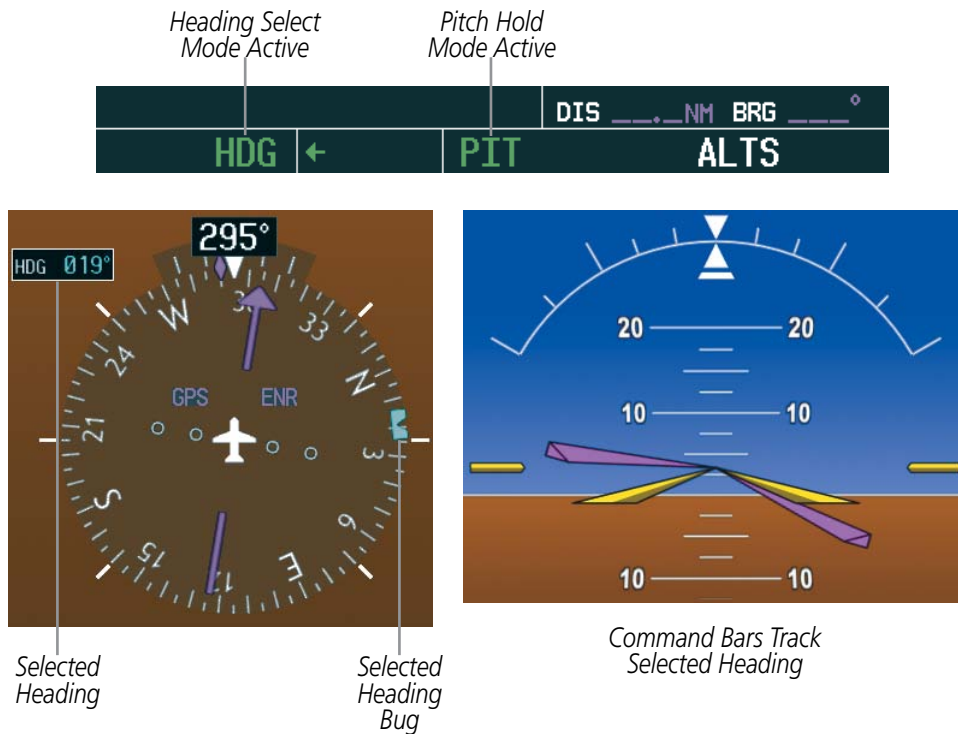

Figure 7-25 Heading Select Mode

NAVIGATION MODES (GPS, VOR, LOC)



NOTE: *The selected navigation receiver must have a valid VOR or LOC signal or active GPS course for the flight director to enter Navigation Mode.*

Pressing the **NAV** Key selects Navigation Mode. Navigation Mode acquires and tracks the selected navigation source (GPS, VOR, LOC). The flight director follows GPS roll steering commands when GPS is the selected navigation source. When the navigation source is VOR or LOC, the flight director creates roll steering commands from the Selected Course and deviation. Navigation Mode can also be used to fly non-precision GPS and LOC approaches where vertical guidance is not required.

If the Course Deviation Indicator (CDI) shows greater than one dot when the **NAV** Key is pressed, the selected mode is armed. If the CDI is less than one dot, Navigation Mode is automatically captured when the **NAV** Key is pressed. The armed annunciation appears in white to the left of the active lateral mode.

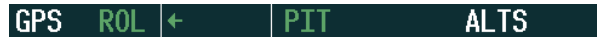

Figure 7-26 GPS Navigation Mode Armed

When the CDI has automatically switched from GPS to LOC during a LOC/ILS approach, GPS Navigation Mode remains active, providing GPS steering guidance until the localizer signal is captured. LOC Navigation Mode is armed automatically when the navigation source switch takes place if the **APR** Key is not pressed prior to the automatic source switch.

If Navigation Mode is active and either of the following occur, the flight director reverts to Roll Hold Mode (wings rolled level):

- Different VOR tuned while in VOR Navigation Mode (VOR Navigation Mode reverts to armed)
- Navigation source manually switched (with the **CDI** Softkey)
- During a LOC/ILS approach, the FAF is crossed while in GPS Navigation Mode after the automatic navigation source switch from GPS to LOC

CHANGING THE SELECTED COURSE

If the navigation source is VOR or localizer or OBS Mode has been enabled when using GPS, the Selected Course is controlled using the **CRS** Knob corresponding to the selected flight director (**CRS1** for the pilot side, **CRS2** for the copilot side).

Pressing the **CWS** Button and hand-flying the aircraft does not change the Selected Course while in Navigation Mode. The autopilot guides the aircraft back to the Selected Course (or GPS flight plan) when the **CWS** Button is released.



Figure 7-27 Navigation Mode

APPROACH MODES (GPS, VAPP, LOC)



NOTE: *The selected navigation receiver must have a valid VOR or LOC signal or active GPS course for the flight director to enter Approach Mode.*

Approach Mode is activated when the **APR** Key is pressed. Approach Mode acquires and tracks the selected navigation source (GPS, VOR, or LOC), depending on loaded approach. This mode uses the selected navigation receiver deviation and desired course inputs to fly the approach. Pressing the **APR** Key when the CDI is greater than one dot arms the selected approach mode (annunciated in white to the left of the active lateral mode). If the CDI is less than one dot, the LOC is automatically captured when the **APR** Key is pressed.

VOR Approach Mode (VAPP) provides greater sensitivity for signal tracking than VOR Navigation Mode.

Selecting VOR Approach Mode:

- 1) Ensure a valid VOR frequency is tuned
- 2) Ensure that VOR is the selected navigation source (use the **CDI** Softkey to cycle through navigation sources if necessary).
- 3) Press the **APR** Key.

When GPS Approach Mode is armed, Glidepath Mode is also armed.

Selecting GPS Approach Mode:

- 1) Ensure a GPS approach is loaded into the active flight plan. The active waypoint must be part of the flight plan (cannot be a direct-to a waypoint not in the flight plan).
- 2) Ensure that GPS is the selected navigation source (use the **CDI** Softkey to cycle through navigation sources if necessary).
- 3) Press the **APR** Key.



Figure 7-28 GPS Approach Mode Armed

LOC Approach Mode allows the autopilot to fly a LOC/ILS approach with a glideslope. When LOC Approach Mode is armed, Glideslope Mode is also armed automatically. LOC captures are inhibited if the difference between aircraft heading and localizer course exceeds 105°.

Selecting LOC Approach Mode:

- 1) Ensure a valid localizer frequency is tuned.
- 2) Ensure that LOC is the selected navigation source (use the **CDI** Softkey to cycle through navigation sources if necessary).
- 3) Press the **APR** Key.

Or:

- 1) Ensure that GPS is the selected navigation source (use the **CDI** Softkey to cycle through navigation sources if necessary).
- 2) Ensure a LOC/ILS approach is loaded into the active flight plan.
- 3) Ensure the corresponding LOC frequency is tuned.
- 4) Press the **APR** Key.

If the following occurs, the flight director reverts to Roll Hold Mode (wings rolled level):

- Approach Mode is active and a Vectors-To-Final is activated
- Approach Mode is active and Navigation source is manually switched
- During a LOC/ILS approach GPS Navigation Mode is active and the FAF is crossed after the automatic navigation source switch from GPS to LOC

CHANGING THE SELECTED COURSE

If the navigation source is VOR or localizer or OBS Mode has been enabled when using GPS, the Selected Course is controlled using the **CRS** Knob corresponding to the selected flight director (**CRS1** for the pilot side, **CRS2** for the copilot side).

Pressing the **CWS** Button and hand-flying the aircraft does not change the Selected Course while in Approach Mode. The autopilot guides the aircraft back to the Selected Course (or GPS flight plan) when the **CWS** Button is released.

BACKCOURSE MODE (BC)



NOTE: When making a backcourse approach, set the Selected Course to the localizer front course.

Backcourse Mode captures and tracks a localizer signal in the backcourse direction. The mode may be selected by pressing the **BC** Key. Backcourse Mode is armed if the CDI is greater than one dot when the mode is selected. If the CDI is less than one dot, Backcourse Mode is automatically captured when the **BC** Key is pressed. The flight director creates roll steering commands from the Selected Course and deviation when in Backcourse Mode.

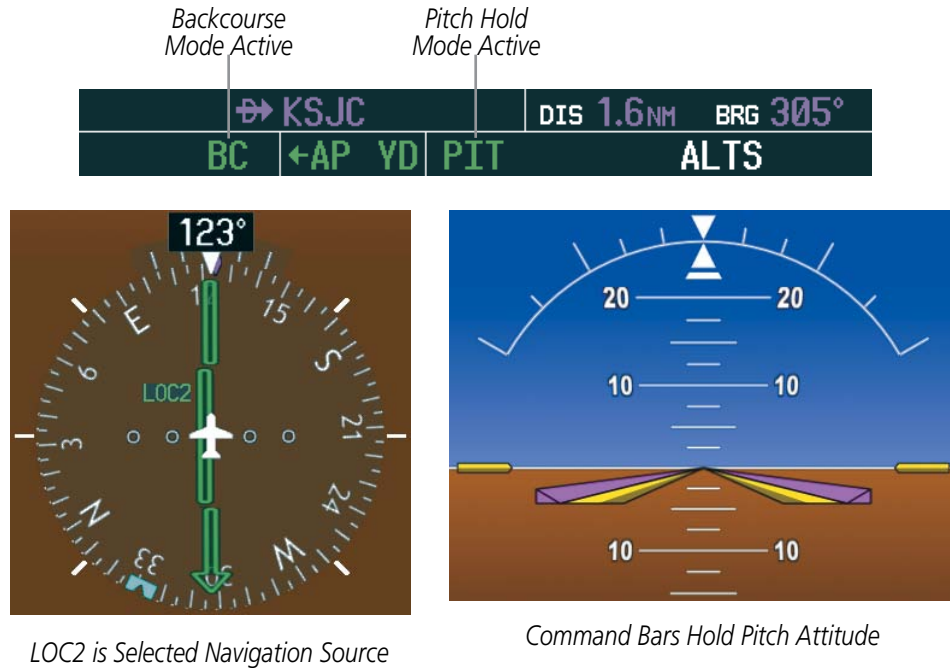

Figure 7-29 Backcourse Mode

CHANGING THE SELECTED COURSE

If the navigation source is VOR or localizer or OBS Mode has been enabled when using GPS, the Selected Course is controlled using the **CRS** Knob corresponding to the selected flight director (**CRS1** for the pilot side, **CRS2** for the copilot side).

Pressing the **CWS** Button and hand-flying the aircraft does not reset any reference data while in Backcourse Mode. The autopilot guides the aircraft back to the Selected Course when the **CWS** Button is released.

INTERCEPTING AND FLYING A DME ARC

The AFCS will intercept and track a DME arc that is part of the active flight plan provided that GPS Navigation Mode is engaged, GPS is the active navigation source on the CDI, and the DME arc segment is the active flight plan leg. It is important to note that automatic navigation of DME arcs is based on GPS. Thus, even if the **APR** key is pressed and **LOC** or **VOR Approach Mode** is armed prior to reaching the Initial Approach Fix (IAF), **Approach Mode** will not activate until the arc segment is completed.

If the pilot decides to intercept the arc at a location other than the published IAF (i.e. ATC provides vectors to intercept the arc) and subsequently selects **Heading Mode** or **Roll Mode**, the AFCS will not automatically intercept or track the arc unless the pilot activates the arc leg of the flight plan and arms **GPS Navigation Mode**. The AFCS will not intercept and fly a DME arc before reaching an IAF that defines the beginning of the arc segment. Likewise, if at any point while established on the DME arc the pilot deselects **GPS Navigation Mode**, the AFCS will no longer track the arc.

7.5 AUTOPILOT AND YAW DAMPER OPERATION



NOTE: Refer to the POH for specific instructions regarding emergency procedures.

The Socata TBM 850's autopilot and yaw damper operate the flight control surface servos to provide automatic flight control. The autopilot controls the aircraft pitch and roll attitudes following commands received from the flight director. Pitch and yaw autotrim provide trim commands to the pitch trim servo and yaw trim adapter to relieve any sustained effort required by the pitch and yaw servos, respectively. Autopilot operation is independent of the yaw damper for the Socata TBM 850.

The yaw damper reduces Dutch roll tendencies and coordinates turns. It can operate independently of the autopilot and may be used during normal hand-flight maneuvers. Yaw rate commands are limited to 6 deg/sec by the yaw damper.

FLIGHT CONTROL

Pitch and roll commands are provided to the servos based on the active flight director modes. Yaw damping is provided by the yaw servo. Servo motor control limits the maximum servo speed and torque. The servo gearboxes are equipped with slip-clutches set to certain values. This allows the servos to be overridden in case of an emergency.

PITCH AXIS AND TRIM

The autopilot pitch axis uses pitch rate to stabilize the aircraft pitch attitude during flight director maneuvers. Flight director pitch commands are rate- and attitude-limited, combined with pitch damper control, and sent to the pitch servo motor. The pitch servo measures the output effort (torque) and provides this signal to the pitch trim servo. The pitch trim servo commands the motor to reduce the average pitch servo effort.

When the autopilot is not engaged, the pitch trim servo may be used to provide manual electric pitch trim (MEPT). This allows the aircraft to be trimmed using a control wheel switch rather than the trim wheel. Manual trim commands are generated only when both halves of the **MEPT** Switch are operated simultaneously. Trim speeds are scheduled with airspeed to provide more consistent response.

ROLL AXIS

The autopilot roll axis uses roll rate to stabilize aircraft roll attitude during flight director maneuvers. The flight director roll commands are rate- and attitude-limited, combined with roll damper control, and sent to the roll servo motor.

YAW AXIS AND TRIM

The yaw damper uses yaw rate and roll attitude to dampen the aircraft's natural Dutch roll response. It also uses lateral acceleration to coordinate turns. Yaw damper operation is independent of autopilot engagement.

When the yaw damper is not engaged, the yaw trim adapter may be used to provide manual electric yaw trim (MEYT). This allows the aircraft to be trimmed using a control wheel switch. Trim speeds are scheduled with airspeed to provide more consistent response.

ENGAGEMENT

NOTE: Autopilot engagement/disengagement is not equivalent to servo engagement/disengagement. Use the **CWS** Button to disengage the pitch and roll servos while the autopilot remains active.

When the **AP** Key is pressed, the autopilot, yaw damper, and flight director (if not already active) are activated and the annunciator lights on the AFCS controller for the autopilot and yaw damper are illuminated. The flight director engages in Pitch and Roll Hold Modes when initially activated.



Figure 7-30 Autopilot and Yaw Damper Engaged

When the **YD** Key is pressed, the system engages the yaw damper independently of the autopilot and the yaw damper annunciator light is illuminated.

Autopilot and yaw damper status are displayed in the center of the AFCS Status Box. Engagement is indicated by green ‘AP’ and ‘YD’ annunciations, respectively.

CONTROL WHEEL STEERING

During autopilot operation, the aircraft may be hand-flown without disengaging the autopilot. Pressing and holding the **CWS** Button disengages the pitch and roll servos from the flight control surfaces and allows the aircraft to be hand-flown. At the same time, the flight director is synchronized to the aircraft attitude during the maneuver. CWS activity has no effect on yaw damper engagement.

The ‘AP’ annunciation is temporarily replaced by ‘CWS’ in white for the duration of CWS maneuvers.



Figure 7-31 CWS Annunciation

In most scenarios, releasing the **CWS** Button reengages the autopilot with a new reference. Refer to flight director mode descriptions for specific CWS behavior in each mode.

DISENGAGEMENT



NOTE: Pressing the **AP** Key does not disengage the yaw damper.

The autopilot may be manually disengaged by pushing the **AP DISC**, **GA, MERT** Switch, **MEPT ARM** Switch, or the **AP** Key on the AFCS Control Unit. Manual disengagement is indicated by a five-second flashing yellow ‘AP’ annunciation and a three-second autopilot disconnect aural alert. The **AP DISC** or **MEPT ARM** Switch may be used to cancel the aural alert.



Figure 7-32 Manual Autopilot Disengagement

The **YD** Key, **MEYT** and **AP DISC** Switches can be used to disengage the yaw damper (the autopilot, if engaged, also disengages when the **AP DISC** Switch is pressed). The ‘YD’ and ‘AP’ annunciations turn yellow and flash for 5 seconds upon disengagement.



Figure 7-33 Yaw Damper Disengagement

Automatic autopilot disengagement is indicated by a flashing red and white ‘AP’ annunciation and by the autopilot disconnect aural alert, which continue until acknowledged by pushing the **AP DISC** or **MEPT ARM** Switch. Automatic autopilot disengagement occurs due to:

- System failure
- Invalid sensor data
- Roll Trim input
- Stall warning
- Inability to compute default flight director modes (FD also disengages automatically)

Yaw damper disengagement is indicated by a five-second flashing yellow ‘YD’ annunciation. Automatic yaw damper disengagement occurs when autopilot disengagement is caused by failure in a parameter also affecting the yaw damper. This means the yaw damper can remain operational in some cases where the autopilot automatically disengages. A localized failure in the yaw damper system or invalid sensor data also cause yaw damper disengagement.



Figure 7-34 Automatic Autopilot and Yaw Damper Disengagement

7.6 EXAMPLE FLIGHT PLAN



NOTE: The following example flight plan and diagrams (not to be used for navigation) in this section are for instructional purposes only and should be considered not current. Numbered portions of accompanying diagrams correspond to numbered procedure steps.

This scenario-based set of procedures (based on the example flight plan found in the Flight Management Section) shows various GFC 700 AFCS modes used during a flight. In this scenario, the aircraft departs Charles B. Wheeler Downtown Airport (KMKC), enroute to Colorado Springs Airport (KCOS). After departure, the aircraft climbs to 12,000 ft and airway V4 is intercepted, following ATC vectors.

Airway V4 is flown to Salina VOR (SLN) using VOR navigation, then airway V244 is flown using a GPS flight plan. The ILS approach for runway 35L and LPV (WAAS) approach for runway 35R are shown and a missed approach is executed.

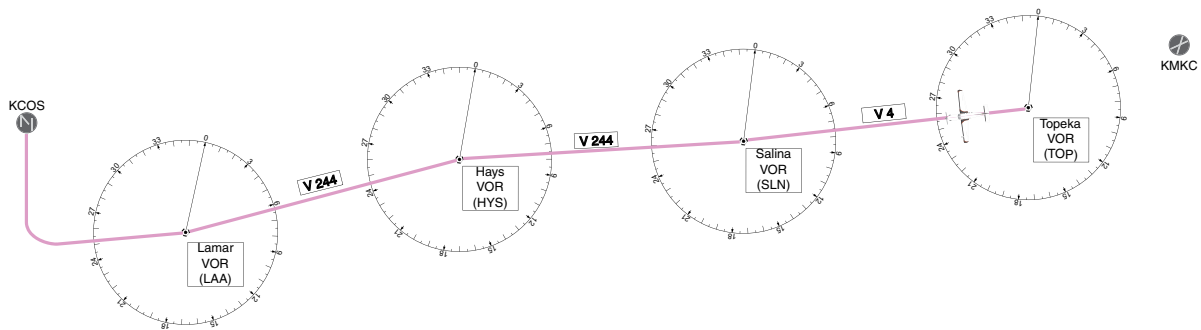

Figure 7-35 Flight Plan Overview

DEPARTURE

Climbing to the Selected Altitude and flying an assigned heading:

- 1) Before takeoff:
 - a) Use the **ALT SEL** Knob to set the Selected Altitude to 12,000 feet.
 - b) Push the **GA** Switch to activate Takeoff Mode. The flight director Command Bars establish a pitch up attitude to follow.



- c) Press the **AP** Key to engage the autopilot in a climb, holding the pitch angle commanded in Takeoff Mode and wings level.



- 2) In this example, Vertical Speed Mode is used to capture the Selected Altitude (Pitch Hold, Vertical Speed, or Flight Level Change Mode may be used).

- a) Press the **VS** Key to activate Vertical Speed Mode.
 The Vertical Speed Reference may be adjusted after Vertical Speed Mode is selected using the **NOSE UP/DN** Wheel or pushing the **CWS** Button while hand-flying the aircraft to establish a new Vertical Speed Reference.

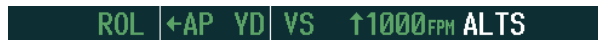

- 3) Use the **HDG** Knob to set the Selected Heading, complying with ATC vectors to intercept Airway V4.
 Press the **HDG** Key to activate Heading Select Mode while the autopilot is engaged in the climb. The autopilot follows the Selected Heading Bug on the HSI and turns the aircraft to the desired heading.

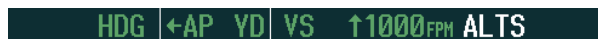

- 4) As the aircraft nears the Selected Altitude, the flight director transitions to Selected Altitude Capture Mode, indicated by the green 'ALTS' annunciation flashing for up to 10 seconds.



At 50 feet from the Selected Altitude, the green 'ALT' annunciation flashes for up to 10 seconds; the autopilot transitions to Altitude Hold Mode and levels the aircraft.



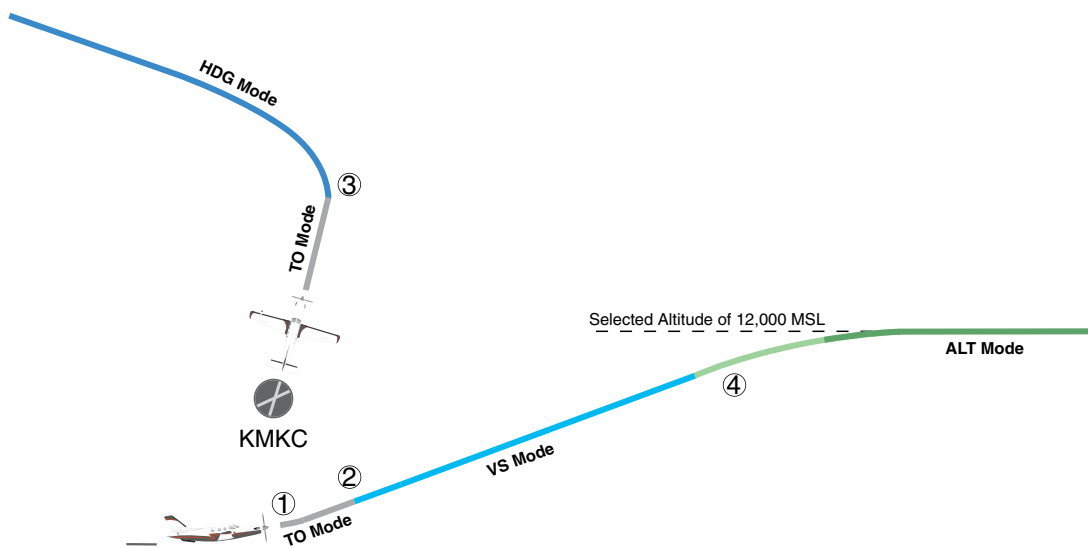

Figure 7-36 Departure

INTERCEPTING A VOR RADIAL

During climb-out, the autopilot continues to fly the aircraft in Heading Select Mode. Airway V4 to Salina VOR (SLN) should now be intercepted. Since the enroute flight plan waypoints correspond to VORs, flight director Navigation Mode using either VOR or GPS as the navigation source may be used. In this scenario, VOR Navigation Mode is used for navigation to the first VOR waypoint in the flight plan.

Intercepting a VOR radial:

- 1) Arm VOR Navigation Mode:
 - a) Tune the VOR frequency.
 - b) Press the **CDI** Softkey to set the navigation source to VOR.
 - c) Use the **CRS1** or **CRS2** Knob to set the Selected Course to the desired value, 255°. Note that at this point, the flight director is still in Heading Select Mode and the autopilot continues to fly the Selected Heading, 290°.
 - d) Press the **NAV** Key. This arms VOR Navigation Mode and the white 'VOR' annunciation appears to the left of the active lateral mode.



- 2) As the aircraft nears the Selected Course, the flight director transitions from Heading Select to VOR Navigation Mode and the 'VOR' annunciation flashes green. The autopilot begins turning to intercept the Selected Course.



- 3) The autopilot continues the turn until the aircraft is established on the Selected Course.

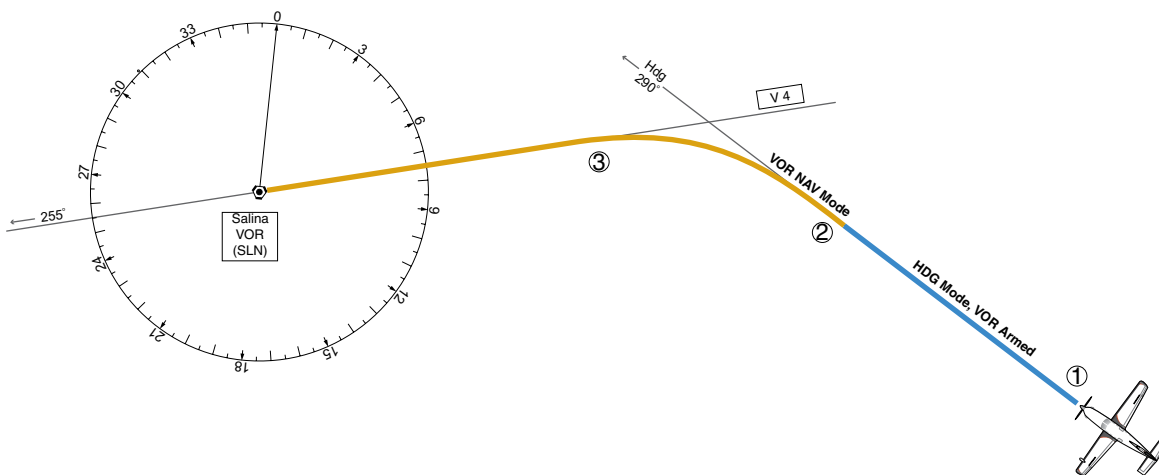

Figure 7-37 Intercepting a VOR Radial

FLYING A FLIGHT PLAN/GPS COURSE

NOTE: Changing the navigation source cancels Navigation Mode and causes the flight director to revert back to Roll Hold Mode (wings rolled level).

As the aircraft closes on Salina VOR, GPS is used to navigate the next leg, airway V244. The aircraft is currently tracking inbound on Airway V4.

Flying a GPS flight plan:

- 1) Transition from VOR to GPS Navigation Mode:
 - a) Press the **CDI** Softkey until GPS is the selected navigation source.
 - b) Press the **NAV** Key to activate GPS Navigation Mode. The autopilot guides the aircraft along the active flight plan leg.



- 2) Following the flight plan, the autopilot continues to steer the aircraft under GPS guidance. Note that in GPS Navigation Mode, course changes defined by the flight plan are automatically made without pilot action required.

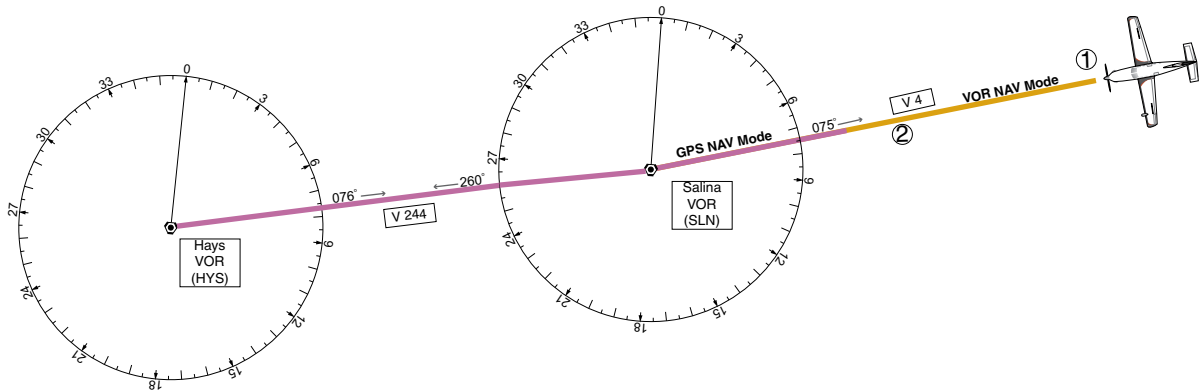

Figure 7-38 Transition to GPS Flight Plan

DESCENT

While flying the arrival procedure, the aircraft is cleared for descent in preparation for the approach to KCOS. Three methods are presented for descent:

- Flight Level Change descent – Flight Level Change Mode can be used to descend to the Selected Altitude at a constant airspeed. This descent method does not account for flight plan waypoint altitude constraints.
- Vertical Path Tracking descent – Vertical Path Tracking Mode is used to follow the vertical descent path defined in the GPS flight plan. Altitude constraints correspond to waypoints in the flight plan. Before VNV flight control can provide vertical profile guidance, a VNV flight plan must be entered and enabled.
- Non-path descent in a VNV scenario – A VNV flight plan is entered and enabled, however Pitch Hold, Vertical Speed, or Flight Level Change Mode can be used to descend to the VNV Target Altitude prior to reaching the planned TOD. Flight Level Change Mode is used in the example.

Flight Level Change descent:

1) Select Flight Level Change Mode:

- Using the **ALT SEL** Knob, set the Selected Altitude to 10,000 feet.
- Press the **FLC** Key to activate Flight Level Change Mode. The annunciation 'FLC' appears next to the Airspeed Reference, which defaults to the current aircraft airspeed. Selected Altitude Capture Mode is armed automatically.



c) If desired, press the **SPD** Key to display the Airspeed Reference in Mach.



- Use the **NOSE UP/DN** Wheel or push the **CWS** Button while hand-flying the aircraft to adjust the commanded airspeed while maintaining the same power, or reduce power to allow descent in Flight Level Change Mode while the autopilot maintains the current airspeed.
- As the aircraft nears the Selected Altitude, the flight director transitions to Selected Altitude Capture Mode, indicated by the green 'ALTS' annunciation flashing for up to 10 seconds.



The green 'ALT' annunciation flashes for up to 10 seconds upon reaching 50 feet from the Selected Altitude; the autopilot transitions to Altitude Hold Mode and levels the aircraft.

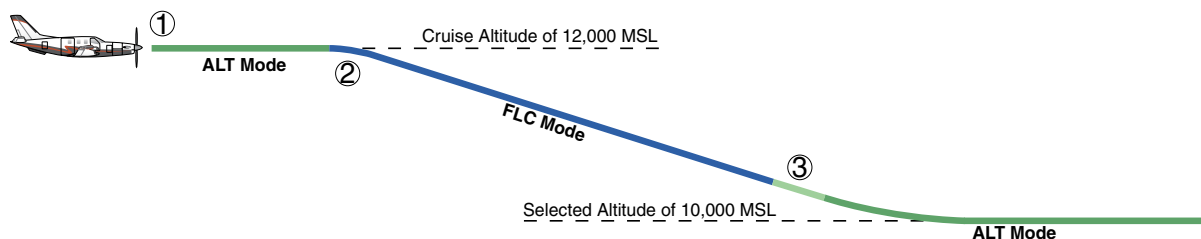

Figure 7-39 FLC Descent

Vertical Path Tracking descent to VNV Target Altitude:

- 1) Select VNV flight control:
 - a) Press the **VNV** Key to arm Vertical Path Tracking Mode. The white annunciation 'VPTH' appears.



- b) Using the **ALT SEL** Knob, set the Selected Altitude 75 feet below the flight plan's VNV Target Altitude of 10,000 feet.

If the Selected Altitude is not at least 75 feet below the VNV Target Altitude, the flight director will capture the Selected Altitude rather than the VNV Target Altitude once Vertical Path Tracking Mode becomes active (ALTS will be armed rather than ALTV).

- c) If Vertical Path Tracking Mode is armed more than 5 minutes prior to descent path capture, acknowledgment is required for the flight director to transition from Altitude Hold to Vertical Path Tracking Mode. To proceed with descent path capture if the white 'VPTH' annunciation begins flashing, do one of the following
 - Press the **VNV** Key
 - Turn the **ALT SEL** Knob to adjust the Selected Altitude

If the descent is not confirmed by the time of interception, Vertical Path Tracking Mode remains armed and the descent is not captured.

- 2) When the top of descent (TOD) is reached, the flight director transitions to Vertical Path Tracking Mode and begins the descent to the VNV Target Altitude. Intention to capture the VNV Target Altitude is indicated by the white 'ALTV' annunciation.



- 3) As the aircraft nears the VNV Target Altitude, the flight director transitions to VNV Target Altitude Capture Mode, indicated by the green 'ALTV' annunciation flashing for up to 10 seconds.



The green 'ALT' annunciation flashes for up to 10 seconds upon reaching 50 feet from the VNV Target Altitude; the autopilot transitions to Altitude Hold Mode and levels the aircraft at the vertical waypoint.

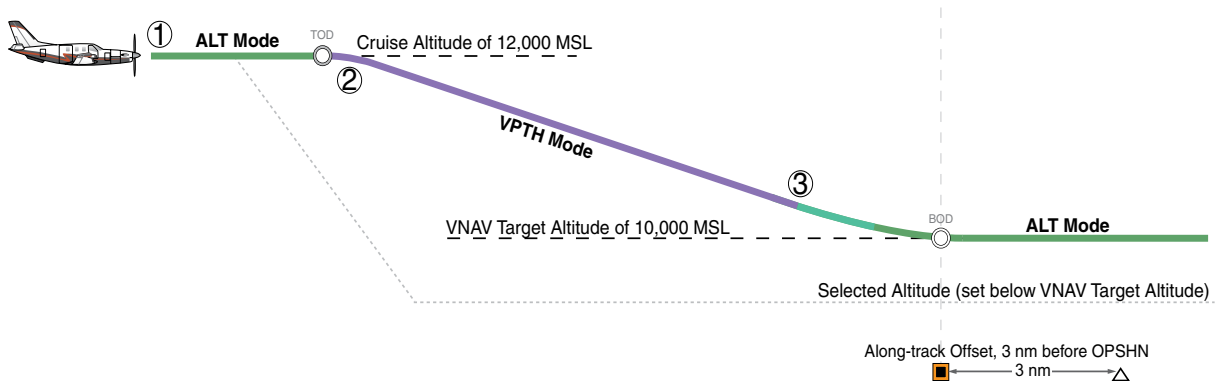

Figure 7-40 VPTH Descent

Non-path descent using Flight Level Change Mode:

- 1) Command a non-path descent to an intermediate altitude above the next VNV flight plan altitude. Use Flight Level Change Mode:
 - a) Using the **ALT SEL** Knob, set the Selected Altitude below the current aircraft altitude to an altitude (in this case, 9,400 feet) at which to level off between VNV flight plan altitudes.
 - b) Press the **FLC** Key before the planned TOD during an altitude hold while VPTH is armed. The Airspeed Reference defaults to the current aircraft airspeed. Vertical Path Tracking and Selected Altitude Capture Mode are armed automatically.

GPS +AP YD FLC 184KT ALTS VPTH

- 2) Reduce power to allow descent in Flight Level Change Mode. The autopilot maintains the Airspeed Reference.
- 3) As the aircraft nears the Selected Altitude, the flight director transitions to Selected Altitude Capture Mode, indicated by the green 'ALTS' annunciation flashing for up to 10 seconds.

GPS +AP YD ALTS 9400FT ALT VPTH

The green 'ALT' annunciation flashes for up to 10 seconds upon reaching 50 feet from the Selected Altitude; the autopilot transitions to Altitude Hold Mode and levels the aircraft. After leveling off, reset the Selected Altitude at or below 9000 ft.

GPS +AP YD ALT 9400FT VPTH

- 4) When the next TOD is reached, Vertical Path Tracking becomes active (may require acknowledgment to allow descent path capture).

GPS +AP YD VPTH ALTV

- 5) As the aircraft nears the VNV Target Altitude, the flight director transitions to VNV Target Altitude Capture Mode, indicated by the green 'ALTV' annunciation flashing for up to 10 seconds.

GPS +AP YD ALTV 9000FT ALT

The green 'ALT' annunciation flashes for up to 10 seconds upon reaching 50 feet from the VNV Target Altitude; the autopilot transitions to Altitude Hold Mode and levels the aircraft at the vertical waypoint.

GPS +AP YD ALT 9000FT

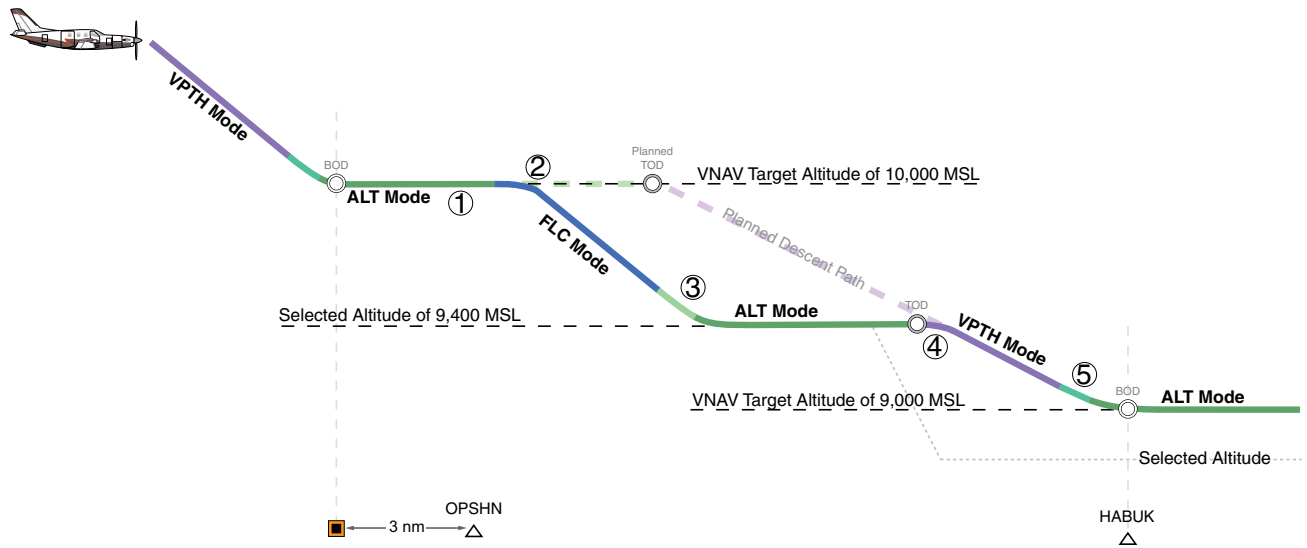

Figure 7-41 Non-path Descent

APPROACH



NOTE: If an approach contains a DME arc, the arc must be flown in Navigation Mode with the GFC 700. When receiving vectors from ATC, Navigation Mode must be selected prior to intercepting the ARC.

Flying an ILS approach:

- 1) Transition from GPS Navigation Mode to Heading Select Mode.
 - a) Select the Runway 35L ILS approach for KCOS and select 'VECTORS' for the transition. Load and activate the approach into the flight plan.
 - b) Use the **HDG** Knob to set the Selected Heading after getting vectors from ATC.
 - c) Press the **HDG** Key. The autopilot turns the aircraft to the desired heading.
 - d) Use Heading Select Mode to comply with ATC vectors as requested.

HDG | **+AP YD** | **ALT 9000FT**

- 2) Arm LOC Approach and Glideslope modes.
 - a) Ensure the appropriate localizer frequency is tuned.
 - b) Press the **APR** Key when cleared for approach to arm Approach and Glideslope modes. 'LOC' and 'GS' appear in white as armed mode annunciations.

LOC | **HDG** | **+AP YD** | **ALT 9000FT** | **GS**

- c) The navigation source automatically switches to LOC. After this switch occurs, the localizer signal can be captured and the autopilot and flight director determine when to begin the turn to intercept the final approach course. The flight director now provides guidance to the missed approach point.
- 3) There are two options available at this point, as the autopilot flies the ILS approach:
 - Push the **AP DISC** Switch at the decision height and land the aircraft
 - Use the **GA** Switch to execute a missed approach.

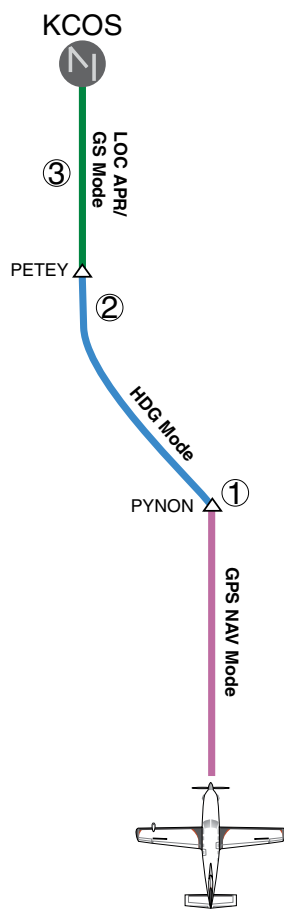

Figure 7-42 ILS Approach to KCOS

Flying a RNAV GPS approach with vertical guidance:

- 1) Arm flight director modes for a RNAV GPS approach with vertical guidance:
 - a) Make sure the navigation source is set to GPS (use **CDI** Softkey to change navigation source).
 - b) Select the Runway 35R LPV approach for KCOS. Load and activate the approach into the flight plan.
- 2) Press the **APR** Key once clearance for approach has been received. GPS Approach Mode is activated and Glidepath Mode is armed.



- 3) Once the glidepath is captured, Glidepath Mode becomes active. The flight director now provides guidance to the missed approach point.



- 4) There are two options available at this point, as the autopilot flies the approach:
 - Push the **AP DISC** Switch at the decision height and land the aircraft.
 - Use the **GA** Switch to execute a missed approach.

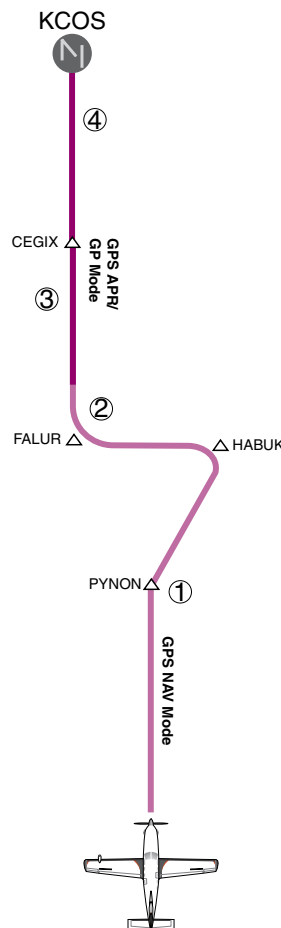

Figure 7-43 LPV Approach to KCOS

GO AROUND/MISSED APPROACH



NOTE: As a result of calculations performed by the system while flying the holding pattern, the display may re-size automatically and the aircraft may not precisely track the holding pattern as depicted on the PFD and MFD.

Flying a missed approach:

- 1) Push the **GA** Switch at the Decision height and apply go around power to execute a missed approach. The flight director Command Bars establish a nose-up climb to follow. If flying an ILS or LOC approach the CDI also switches to GPS as the navigation source.

Note that when the **GA** Switch is pushed, the missed approach is activated and the autopilot disconnects, indicated by the 'AP' annunciation flashing yellow for 5 seconds and the autopilot disconnect aural alert.

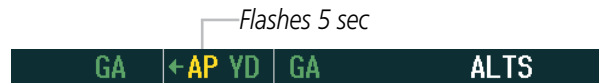

- 2) Start the climb to the prescribed altitude in the published Missed Approach Procedure (in this case, 10,000 ft).
 - a) Press the **AP** Key to re-engage the autopilot.
 - b) Press the **NAV** Key to have the autopilot fly to the hold.

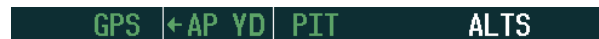

- 3) Use the **ALT SEL** Knob to set a Selected Altitude to hold.

To hold the current airspeed during the climb, press the **FLC** Key.



As the aircraft nears the Selected Altitude, the flight director transitions to Selected Altitude Capture Mode, indicated by the green 'ALTS' annunciation flashing for up to 10 seconds.



The green 'ALT' annunciation flashes for up to 10 seconds upon reaching 50 feet from the Selected Altitude; the autopilot transitions to Altitude Hold Mode and levels the aircraft.



- 4) The autopilot flies the holding pattern after the missed approach is activated. Annunciations are displayed in the Navigation Status Box, above the AFCS Status Box.



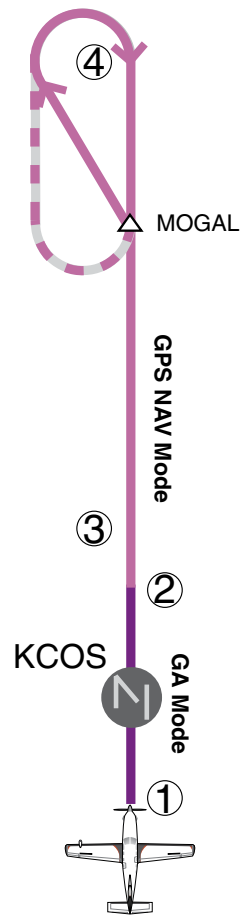

Figure 7-44 Go Around/Missed Approach

7.7 AFCS ANNUNCIATIONS AND ALERTS

AFCS STATUS ALERTS

The annunciations in Table 7-5 (listed in order of increasing priority) can appear on the PFDs above the Airspeed and Attitude indicators. Only one annunciation may occur at a time, and messages are prioritized by criticality.

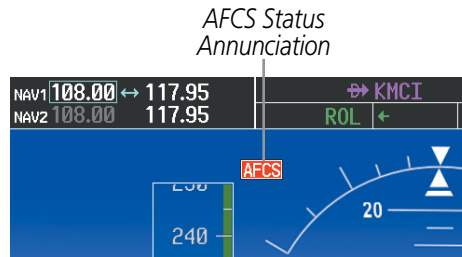

Figure 7-45 AFCS Status Annunciation

Alert Condition	Annunciation	Description
Rudder Mistrim Right	RUD→	Yaw servo providing sustained force in the indicated direction
Rudder Mistrim Left	←RUD	
Aileron Mistrim Right	AIL→	Roll servo providing sustained force in the indicated direction
Aileron Mistrim Left	←AIL	
Elevator Mistrim Down	↓ELE	Pitch servo providing sustained force in the indicated direction
Elevator Mistrim Up	↑ELE	
Pitch Trim Failure (or stuck MEPT Switch)	PTRM	If AP engaged, take control of the aircraft and disengage AP If AP disengaged, move MEPT switches separately to unstick
Yaw Trim Failure (or stuck MEYT Switch)	YTRM	If AP engaged, take control of the aircraft and disengage AP If AP disengaged, move MEYT switch to unstick
Yaw Damper Failure	YAW	YD control failure
Roll Failure	ROLL	Roll axis control failure; AP inoperative
Pitch Failure	PTCH	Pitch axis control failure; AP inoperative
System Failure	AFCS	AP and MEPT are unavailable; FD may still be available
Preflight Test	PFT	Performing preflight system test; aural alert sounds at completion Do not press the AP DISC Switch during servo power-up and preflight system tests as this may cause the preflight system test to fail or never to start (if servos fail their power-up tests). Power must be cycled to the servos to remedy the situation.
	PFT	Preflight system test failed; aural alert sounds at failure

Table 7-5 AFCS Status Alerts

OVERSPEED PROTECTION



NOTE: Overspeed protection is not active in Altitude Hold, Glideslope or Glidepath modes.

While Pitch Hold, Vertical Speed, Flight Level Change, Vertical Path Tracking, or an altitude capture mode is active, airspeed is monitored by the flight director. Pitch commands are not changed until overspeed protection becomes active. Overspeed protection is provided in situations where the flight director cannot acquire and maintain the mode reference for the selected vertical mode without exceeding the certified maximum autopilot airspeed.

When an autopilot overspeed condition occurs, the Airspeed Reference appears in a box above the Airspeed Indicator, flashing a yellow 'MAXSPD' annunciation. Engine power should be reduced and/or the pitch reference adjusted to slow the aircraft. The annunciation disappears when the overspeed condition is resolved.

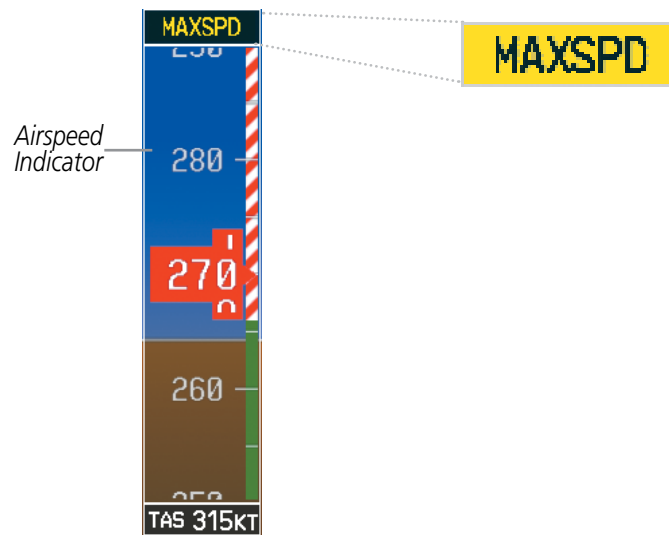

Figure 7-46 Overspeed Annunciation

SECTION 8 ADDITIONAL FEATURES



NOTE: *With the availability of SafeTaxi®, ChartView, or FliteCharts®, it may be necessary to carry another source of charts on-board the aircraft.*

Additional features of the system include the following:

- Synthetic Vision System (SVS)
- SafeTaxi® diagrams
- ChartView and FliteCharts® electronic charts
- AOPA's Airport Directory
- SiriusXM Radio entertainment
- Scheduler
- Electronic Checklists
- Flight Data Logging
- Iridium Satellite Telephone and SMS text messaging

The optional Synthetic Vision System (SVS) provides a three-dimensional forward view of terrain features on the PFD. SVS imagery shows the pilot's view of relevant features in relation to the aircraft attitude, as well as the flight path pertaining to the active flight plan.

SafeTaxi diagrams provide detailed taxiway, runway, and ramp information at more than 700 airports in the United States. By decreasing range on an airport that has a SafeTaxi diagram available, a close up view of the airport layout can be seen.

The optional ChartView and FliteCharts provide on-board electronic terminal procedures charts. Electronic charts offer the convenience of rapid access to essential information. Either ChartView or FliteCharts may be configured in the system, but not both.

AOPA's Airport Directory offers detailed information for a selected airport, such as available services, hours of operation, and lodging options.

The optional SiriusXM Radio entertainment audio feature of the GDL 69A Data Link Receiver handles more than 170 channels of music, news, and sports. SiriusXM Radio offers more entertainment choices and longer range coverage than commercial broadcast stations.

The Scheduler feature can be used to enter and display short term or long term reminder messages such as Switch fuel tanks, Change oil, or Altimeter-Transponder Check in the Messages Window on the PFD.

Optional checklists help to quickly find the proper procedure on the ground or during flight.

The Flight Data Logging feature automatically stores critical flight and engine data on an SD data card. Approximately 1,000 flight hours can be recorded for each 1GB of available space on the card.

Telephone Service and SMS text messaging is an optional subscription service offered through Iridium Satellite LLC.

8.1 SYNTHETIC VISION SYSTEM (SVS)



WARNING: Use appropriate primary systems for navigation, and for terrain, obstacle, and traffic avoidance. SVS is intended as an aid to situational awareness only and may not provide either the accuracy or reliability upon which to solely base decisions and/or plan maneuvers to avoid terrain, obstacles, or traffic.

The optional Synthetic Vision System (SVS) is a visual enhancement to the G1000 Integrated Flight Deck. SVS depicts a forward-looking attitude display of the topography immediately in front of the aircraft. The field of view is 30 degrees to the left and 35 degrees to the right. SVS information is shown on the Primary Flight Display (PFD), or on the Multifunction Display (MFD) in Reversionary Mode (Figure 8-105). The depicted imagery is derived from the aircraft attitude, heading, GPS three-dimensional position, and a nine arc-second database of terrain, obstacles, and other relevant features. The terrain data resolution of nine arc-seconds, meaning that the terrain elevation contours are stored in squares measuring nine arc-seconds on each side, is required for the operation of SVS. Loss of any of the required data, including temporary loss of the GPS signal, will cause SVS to be disabled until the required data is restored.

The SVS terrain display shows land contours (colors are consistent with those of the topographical map display), large water features, towers, and other obstacles over 200' AGL that are included in the obstacle database. Cultural features on the ground such as roads, highways, railroad tracks, cities, and state boundaries are not displayed even if those features are found on the MFD map. The terrain display also includes a north–south east–west grid with lines oriented with true north and spaced at one arc-minute intervals to assist in orientation relative to the terrain.

The optional Terrain Awareness and Warning System (TAWS) or standard Terrain-SVS is integrated within SVS to provide visual and auditory alerts to indicate the presence of terrain and obstacle threats relevant to the projected flight path. Terrain alerts are displayed in red and yellow shading on the PFD.

The terrain display is intended for situational awareness only. It may not provide the accuracy or fidelity on which to base decisions and plan maneuvers to avoid terrain or obstacles. Navigation must not be predicated solely upon the use of the Terrain–SVS or TAWS terrain or obstacle data displayed by the SVS.

The following SVS enhancements appear on the PFD:

- Pathways
- Flight Path Marker
- Horizon Heading Marks
- Traffic Display
- Airport Signs
- Runway Display
- Terrain Alerting
- Obstacle Alerting



Figure 8-1 Synthetic Vision Imagery

SVS OPERATION

SVS is activated from the PFD using the softkeys located along the bottom edge of the display. Pressing the softkeys turns the related function on or off. When SVS is enabled, the pitch scale increments are reduced to 10 degrees up and 7.5 degrees down.

SVS functions are displayed on three levels of softkeys. The **PFD** Softkey leads into the PFD function Softkeys, including synthetic vision. Pressing the **SYN VIS** Softkey displays the SVS feature softkeys. The softkeys are labeled **PATHWAY**, **SYN TERR**, **HRZN HDG**, and **APTSIGNS**. The **BACK** Softkey returns to the previous level of softkeys. Synthetic Terrain must be active before any other SVS feature may be activated.

HRZN HDG, **APTSIGNS**, and **PATHWAY** Softkeys are only available when the **SYN TERR** Softkey is activated (gray with black characters). After activating the **SYN TERR** Softkey, the **HRZN HDG**, **APTSIGNS**, and **PATHWAY** softkeys may be activated in any combination to display desired features. When system power is cycled, the last selected state (on or off) of the **SYN TERR**, **HRZN HDG**, **APTSIGNS**, and **PATHWAY** softkeys is remembered by the system.

- **PATHWAY** Softkey enables display of rectangular boxes that represent course guidance.
- **SYN TERR** Softkey enables synthetic terrain depiction.
- **HRZN HDG** Softkey enables horizon heading marks and digits.
- **APTSIGNS** Softkey enables airport signposts.

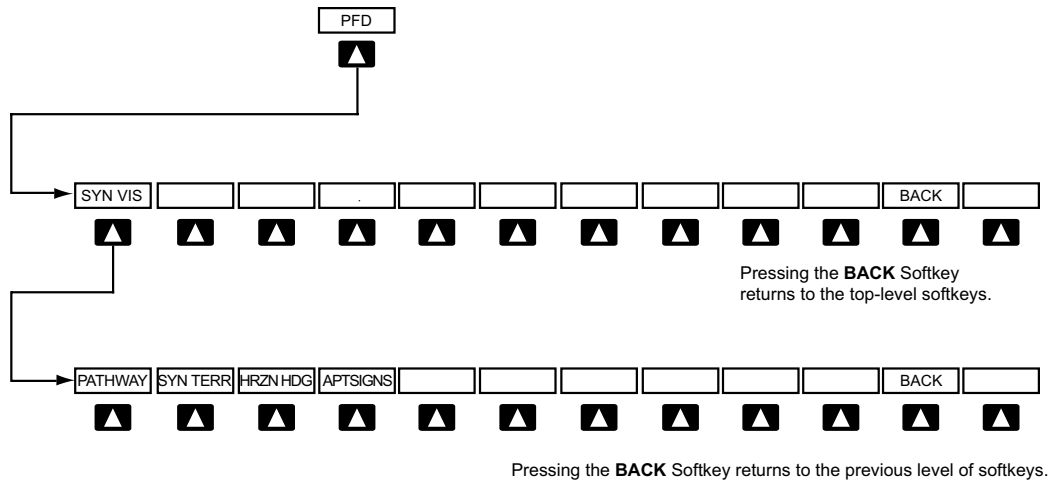

Figure 8-2 SVS Softkeys

Activating and deactivating SVS:

- 1) Press the **PFD** Softkey.
- 2) Press the **SYN VIS** Softkey.
- 3) Press the **SYN TERR** Softkey. The SVS display will cycle on or off with the **SYN TERR** Softkey.

Activating and deactivating Pathways:

- 1) Press the **PFD** Softkey.
- 2) Press the **SYN VIS** Softkey.
- 3) Press the **PATHWAY** Softkey. The Pathway feature will cycle on or off with the **PATHWAY** Softkey.

Activating and deactivating Horizon Headings:

- 1) Press the **PFD** Softkey.
- 2) Press the **SYN VIS** Softkey.
- 3) Press the **HRZN HDG** Softkey. The horizon heading display will cycle on or off with the **HRZN HDG** Softkey.

Activating and deactivating Airport Signs:

- 1) Press the **PFD** Softkey.
- 2) Press the **SYN VIS** Softkey.
- 3) Press the **APTSIGNS** Softkey. Display of airport signs will cycle on or off with the **APTSIGNS** Softkey.

SVS FEATURES



Figure 8-3 SVS on the Primary Flight Display



NOTE: Pathways and terrain features are not a substitute for standard course and altitude deviation information provided by the altimeter, CDI, and VDI.

PATHWAYS

Pathways provide a three-dimensional perspective view of the selected route of flight shown as colored rectangular boxes representing the horizontal and vertical flight path of the active flight plan. The box size represents 700 feet wide by 200 feet tall during enroute, oceanic, and terminal flight phases. During an approach, the box width is 700 feet or one half full scale deviation on the HSI, whichever is less. The height is 200 feet or one half full scale deviation on the VDI, whichever is less. The altitude at which the pathway boxes are displayed is determined by the selected altitude during climb, cruise, and when the active leg is the final approach course prior to intercepting the glidepath/glide slope. During a descent (except while on the approach glidepath/glide slope), the pathway boxes are displayed at the selected altitude, or the VNAV altitude programmed for the active leg in the flight plan, or the published altitude constraint, whichever is higher (Figure 8-4). Just prior to intercepting the glidepath/glide slope, the pathway boxes are displayed on the glidepath/glide slope, or the selected altitude, whichever is lower.

The color of the rectangular boxes may be magenta, green, or white depending on the route of flight and navigation source selected. The active GPS or GPS overlay flight plan leg is represented by magenta boxes that correspond to the Magenta CDI. A localizer course is represented by green boxes that correspond to a green CDI. An inactive leg of an active flight plan is represented by white boxes corresponding to a white line drawn on the Inset map or MFD map indicating an inactive leg.

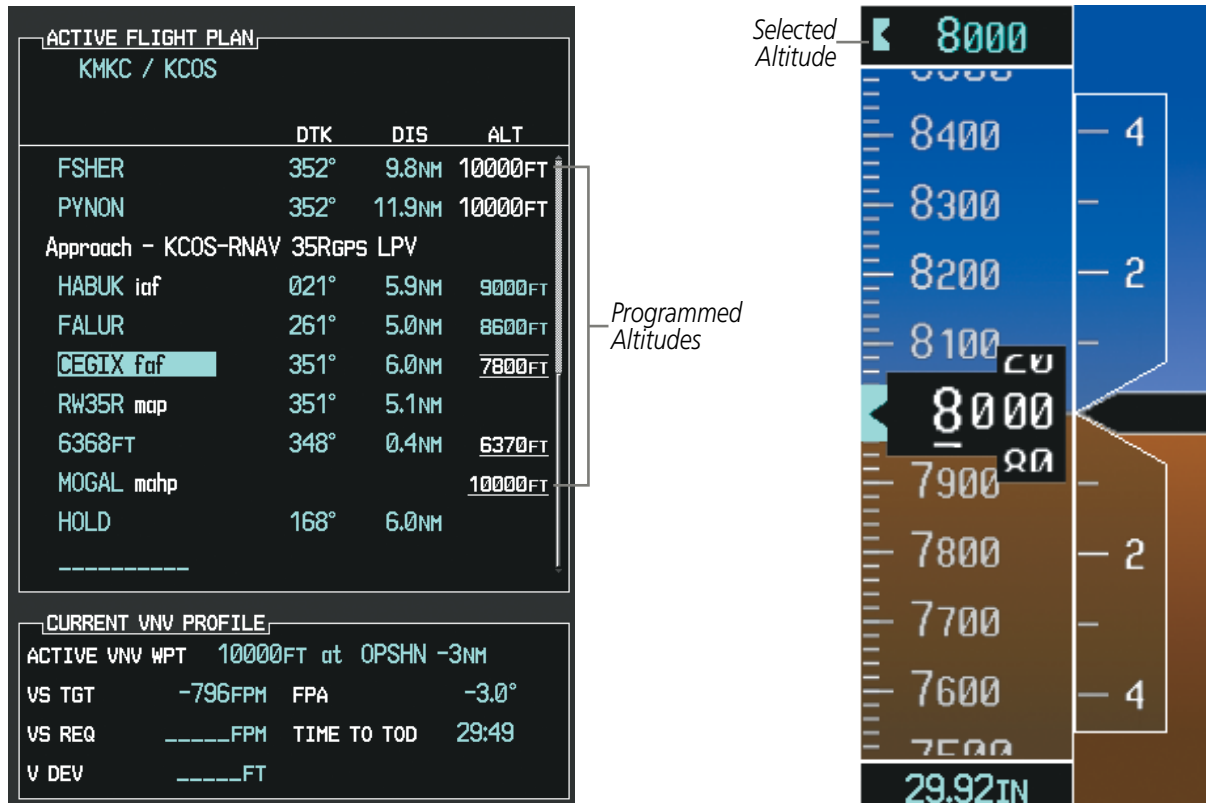

Figure 8-4 Programmed and Selected Altitude

Pathways provide supplemental glidepath information on an active ILS, LPV, LNAV/VNAV, and some LNAV approaches. Pathways are intended as an aid to situational awareness and should not be used independent of the CDI, VDI, glide path indicator, and glide slope indicator. They are removed from the display when the selected navigation information is not available. Pathways are not displayed beyond the active leg when leg sequencing is suspended and are not displayed on any portion of the flight plan leg that would lead to intercepting a leg in the wrong direction.

DEPARTURE AND ENROUTE

Prior to intercepting an active flight plan leg, pathways are displayed as a series of boxes with pointers at each corner that point in the direction of the active waypoint. Pathways are not displayed for the first leg of the flight plan if that segment is a Heading-to-Altitude leg. The first segment displaying pathways is the first active GPS leg or active leg with a GPS overlay. If this leg of the flight plan route is outside the SVS field of view, pathways will not be visible until the aircraft has turned toward this leg. While approaching the center of the active leg and prescribed altitude, the number of pathway boxes decreases to a minimum of four.

Pathways are displayed along the flight plan route at the highest of either the selected altitude or the programmed altitude for the leg. Climb profiles cannot be displayed due to the variables associated with aircraft performance. Flight plan legs requiring a climb are indicated by pathways displayed at a level above the aircraft at the altitude selected or programmed.

DESCENT AND APPROACH

Pathways are shown descending only for a programmed descent (Figures 8-5, 8-6). When the flight plan includes programmed descent segments, pathways are displayed along the descent path provided that the selected altitude is lower than the programmed altitude.

When an approach providing vertical guidance is activated, Pathways are shown level at the selected altitude up to the point along the final approach course where the altitude intercepts the extended vertical descent path, glidepath, or glideslope. From the vertical path descent, glidepath, or glideslope intercept point, the pathways are shown inbound to the Missed Approach Point (MAP) along the published lateral and vertical descent path, or at the selected altitude, whichever is lower.

During an ILS approach, the initial approach segment is displayed in magenta at the segment altitudes if GPS is selected as the navigation source on the CDI. When switching to localizer inbound with LOC selected as the navigation source on the CDI, pathways are displayed in green along the localizer and glide slope.

VOR, LOC BC, and ADF approach segments that are approved to be flown using GPS are displayed in magenta boxes. Segments that are flown using other than GPS or ILS, such as heading legs or VOR final approach courses are not displayed.

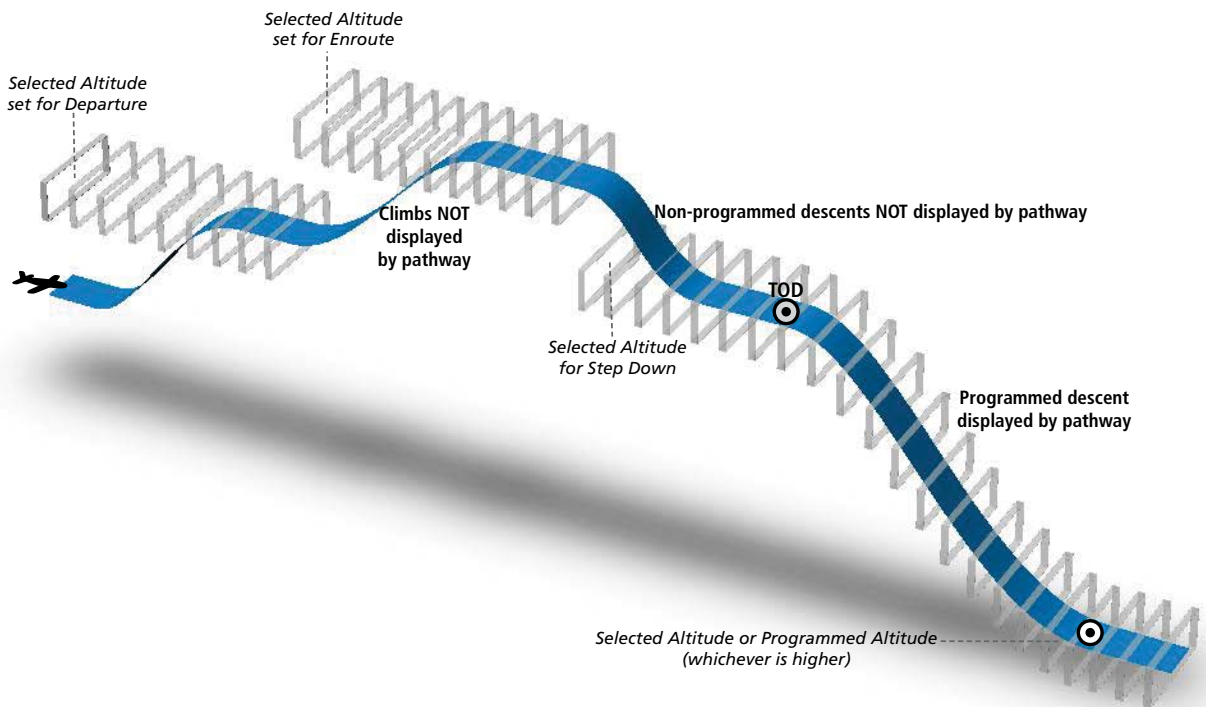

Figure 8-5 SVS Pathways, Enroute and Descent

MISSED APPROACH

Upon activating the missed approach, pathways lead to the Missed Approach Holding Point (MAHP) and are displayed as a level path at the published altitude for the MAHP, or the selected altitude, whichever is the highest. If the initial missed approach leg is a Course-to-Altitude (CA) leg, the pathways boxes will be displayed level at the altitude published for the MAHP. If the initial missed approach leg is defined by a course using other than GPS, pathways are not displayed for that segment. In this case, the pathways displayed for the next leg may be outside the field of view and will be visible when the aircraft has turned in the direction of that leg.

Pathways are displayed along each segment including the path required to track course reversals that are part of a procedure, such as holding patterns. Pathways boxes will not indicate a turn to a MAHP unless a defined geographical waypoint exists between the MAP and MAHP.

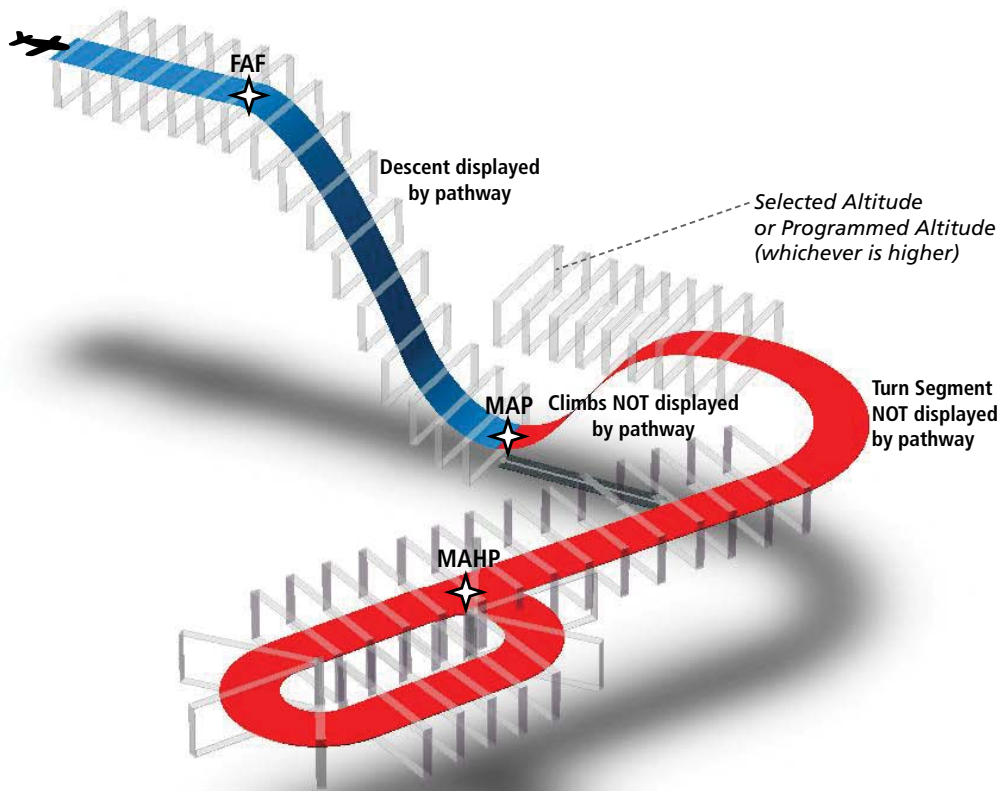

Figure 8-6 SVS Pathways, Approach, Missed Approach, and Holding

FLIGHT PATH MARKER

The Flight Path Marker (FPM), also known as a Velocity Vector, is displayed on the PFD at groundspeeds above 30 knots. The FPM depicts the approximate projected path of the aircraft accounting for wind speed and direction relative to the three-dimensional terrain display.

The FPM is always available when the Synthetic Terrain feature is in operation. The FPM represents the direction of the flight path as it relates to the terrain and obstacles on the display, while the airplane symbol represents the aircraft heading.

The FPM works in conjunction with the Pathways feature to assist the pilot in maintaining desired altitudes and direction when navigating a flight plan. When on course and altitude the FPM is aligned inside the pathway boxes as shown (Figure 8-7).

The FPM may also be used to identify a possible conflict with the aircraft flight path and distant terrain or obstacles. Displayed terrain or obstacles in the aircraft's flight path extending above the FPM could indicate a potential conflict, even before an alert is issued by TAWS. However, decisions regarding terrain and/or obstacle avoidance should not be made using only the FPM.



Figure 8-7 Flight Path Marker and Pathways

ZERO PITCH LINE

The Zero Pitch Line is drawn completely across the display and represents the aircraft attitude with respect to the horizon. It may not align with the terrain horizon, particularly when the terrain is mountainous or when the aircraft is flown at high altitudes.

HORIZON HEADING

The Horizon Heading is synchronized with the HSI and shows approximately 60 degrees of compass heading in 30-degree increments on the Zero Pitch Line. Horizon Heading tick marks and digits appearing on the zero pitch line are not visible behind either the airspeed or altitude display. Horizon Heading is used for general heading awareness, and is activated and deactivated by pressing the **HRZN HDG** Softkey.

TRAFFIC



WARNING: Intruder aircraft at or below 500 ft. AGL may not appear on the SVS display or may appear as a partial symbol.

Traffic symbols are displayed in their approximate locations as determined by the related traffic systems. Traffic symbols are displayed in three dimensions, appearing larger as they are getting closer, and smaller when they are further away. Traffic within 250 feet laterally of the aircraft will not be displayed on the SVS display. Traffic symbols and coloring are consistent with that used for traffic displayed in the Inset map or MFD traffic page. If the traffic altitude is unknown, the traffic will not be displayed on the SVS display. For more details refer to the traffic system discussion in the Hazard Avoidance section.

AIRPORT SIGNS

Airport Signs provide a visual representation of airport location and identification on the synthetic terrain display. When activated, the signs appear on the display when the aircraft is approximately 15 nm from an airport and disappear at approximately 4.5 nm. Airport signs are shown without the identifier until the aircraft is approximately eight nautical miles from the airport. Airport signs are not shown behind the airspeed or altitude display. Airport signs are activated and deactivated by pressing the **APTSIGNS** Softkey.



Figure 8-8 Airport Signs

RUNWAYS

WARNING: Do not use SVS runway depiction as the sole means for determining the proximity of the aircraft to the runway or for maintaining the proper approach path angle during landing.

NOTE: Not all airports have runways with endpoint data in the database, therefore, these runways are not displayed.

Runway data provides improved awareness of runway location with respect to the surrounding terrain. All runway thresholds are depicted at their respective elevations as defined in the database. In some situations, where threshold elevations differ significantly, crossing runways may appear to be layered. As runways are displayed, those within 45 degrees of the aircraft heading are displayed in white. Other runways will be gray in color. When an approach for a specific runway is active, that runway will appear brighter and be outlined with a white box, regardless of the runway orientation as related to aircraft heading. As the aircraft gets closer to the runway, more detail such as runway numbers and centerlines will be displayed.



Figure 8-9 Airport Runways

TERRAIN-SVS AND TAWS ALERTING

Terrain alerting on the synthetic terrain display is triggered by Forward-looking Terrain Avoidance (FLTA) alerts, and corresponds to the red and yellow X symbols on the Inset Map and MFD map displays. For more detailed information regarding Terrain-SVS and TAWS, refer to the Hazard Avoidance Section.

In some instances, a terrain or obstacle alert may be issued with no conflict shading displayed on the synthetic terrain. In these cases, the conflict is outside the SVS field of view to the left or right of the aircraft.



Figure 8-10 Terrain Alert

Obstacles are represented on the synthetic terrain display by standard two-dimensional tower symbols found on the Inset map and MFD maps and charts. Obstacle symbols appear in the perspective view with relative height above terrain and distance from the aircraft. Unlike the Inset map and MFD moving map display, obstacles on the synthetic terrain display do not change colors to warn of potential conflict with the aircraft's flight path until the obstacle is associated with an actual FLTA alert. Obstacles greater than 1000 feet below the aircraft altitude are not shown. Obstacles are shown behind the airspeed and altitude displays.



Figure 8-11 Obstacle

FIELD OF VIEW

The PFD field of view can be represented on the MFD Navigation Map Page. Two dashed lines forming a V-shape in front of the aircraft symbol on the map, represent the forward viewing area shown on the PFD.

Configuring field of view:

- 1) While viewing the Navigation Map Page, press the **MENU** Key to display the PAGE MENU.
- 2) Turn the large **FMS** Knob to highlight Map Setup and press the **ENT** Key.

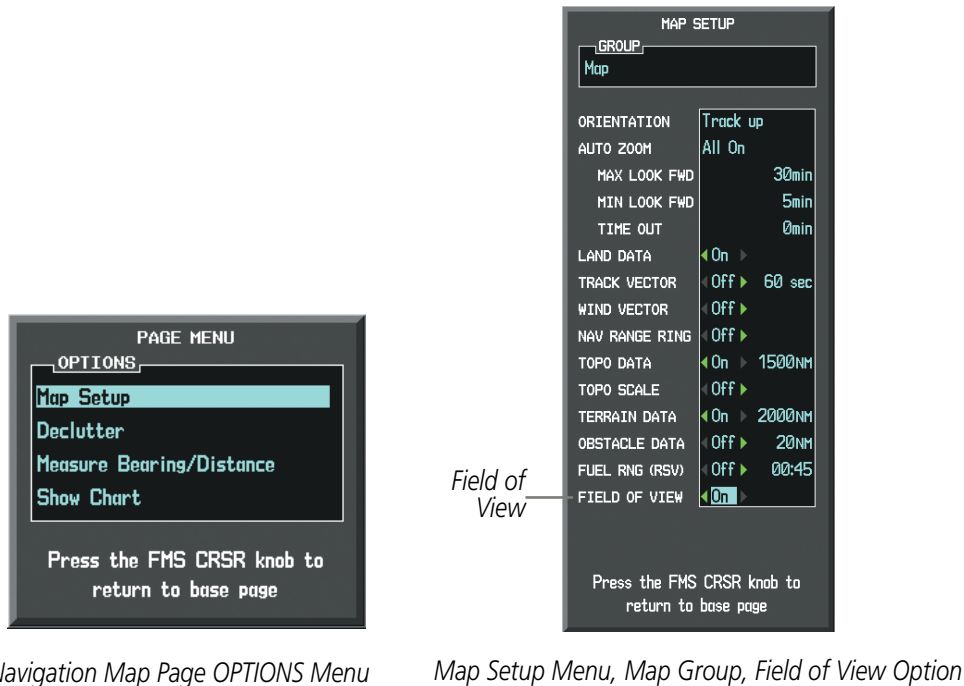

Figure 8-12 Option Menus

- 3) Turn the **FMS** Knob to select the Map Group and press the **ENT** Key.
- 4) Turn the large **FMS** Knob to scroll through the Map Group options to FIELD OF VIEW.
- 5) Turn the small **FMS** Knob to select On or Off.
- 6) Press the **FMS** Knob to return to the Navigation Map Page.

The following figure compares the PFD forward looking depiction with the MFD plan view and FIELD OF VIEW turned on.



SVS View on the PFD



*Lines
Depict
PFD Field
of View*

Field of View on the MFD

Figure 8-13 PFD and MFD Field of View Comparison

8.2 SAFETAXI

SafeTaxi is an enhanced feature that gives greater map detail when viewing airports at close range. The maximum map ranges for enhanced detail are pilot configurable. When viewing at ranges close enough to show the airport detail, the map reveals taxiways with identifying letters/numbers, airport Hot Spots, and airport landmarks including ramps, buildings, control towers, and other prominent features. Resolution is greater at lower map ranges. When the MFD display is within the SafeTaxi ranges, the airplane symbol on the airport provides enhanced position awareness.

Designated Hot Spots are recognized at airports with many intersecting taxiways and runways, and/or complex ramp areas. Airport Hot Spots are outlined to caution pilots of areas on an airport surface where positional awareness confusion or runway incursions happen most often. Hot Spots are defined with a magenta circle or outline around the region of possible confusion.

Any map page that displays the navigation view can also show the SafeTaxi airport layout within the maximum configured range. The following is a list of pages where the SafeTaxi feature can be seen:

- Navigation Map Page
- Inset Map (PFD)
- Weather Datalink Page
- Airport Information Page
- Intersection Information Page
- NDB Information Page
- VOR Information Page
- User Waypoint Information Page
- Trip Planning Page
- Nearest Pages
- Active and Stored Flight Plan Pages

During ground operations the aircraft's position is displayed in reference to taxiways, runways, and airport features. In the example shown, the aircraft is on taxiway Bravo inside the High Alert Intersection boundary on KSFO airport. Airport Hot Spots are outlined in magenta. When panning over the airport, features such as runway holding lines and taxiways are shown at the cursor.

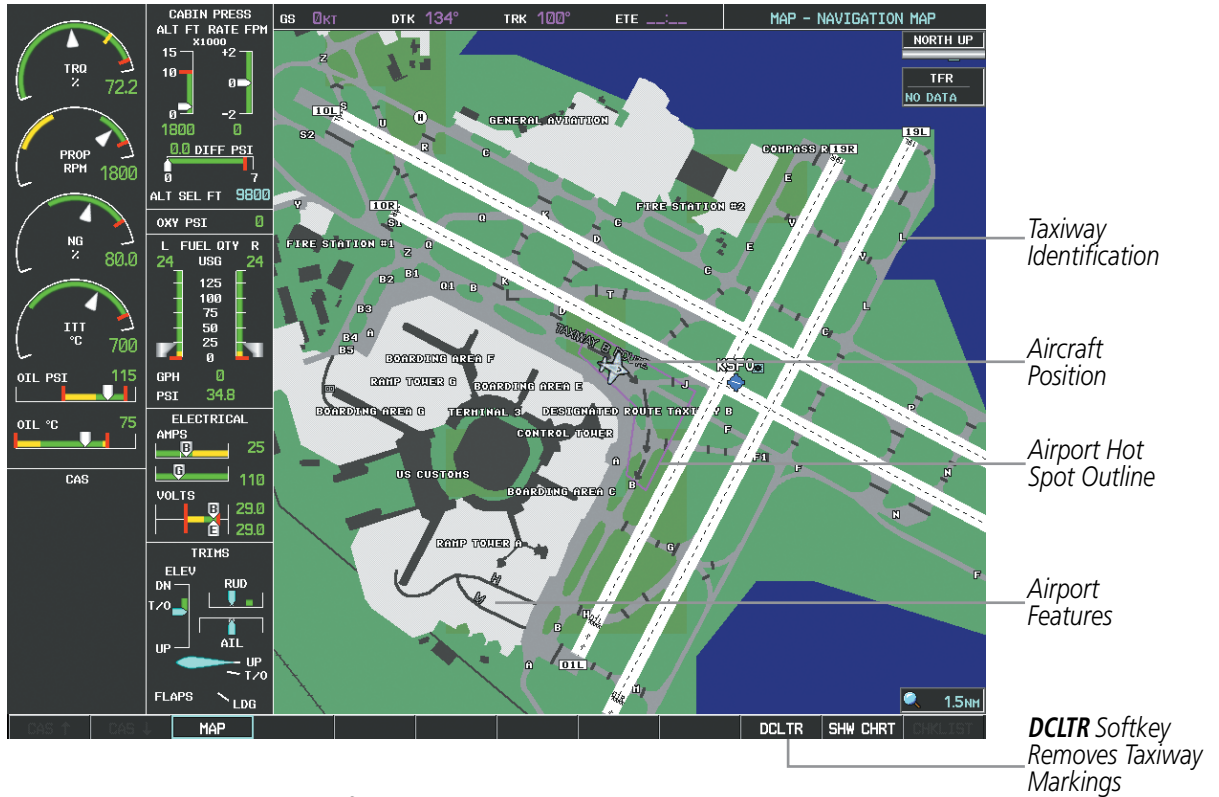

Figure 8-14 SafeTaxi Depiction on the Navigation Map Page

The **DCLTR** Softkey (declutter) label advances to DCLTR-1, DCLTR -2, and DCLTR-3 each time the softkey is selected for easy recognition of decluttering area level. Selecting the **DCLTR** Softkey removes the taxiway markings and airport feature labels. Selecting the **DCLTR-1** Softkey removes VOR station ID, the VOR symbol, and intersection names if within the airport plan view. Selecting the **DCLTR-2** Softkey removes the airport runway layout, unless the airport in view is part of an active route structure. Selecting the **DCLTR-3** Softkey cycles back to the original map detail. Refer to Map Declutter Levels in the Flight Management Section.

Configuring SafeTaxi range:

- 1) While viewing the Navigation Map Page, press the **MENU** Key to display the PAGE MENU.
- 2) Turn the large **FMS** Knob to highlight the Map Setup Menu Option and press the **ENT** Key.



Figure 8-15 Navigation Map PAGE MENU, Map Setup Option

- 3) Turn the **FMS** Knob to select the Aviation Group and press the **ENT** Key.
- 4) Turn the large **FMS** Knob to scroll through the Aviation Group options to SAFETAXI.
- 5) Turn the small **FMS** Knob to display the range of distances.
- 6) Turn either **FMS** Knob to select the desired distance for maximum SafeTaxi display range.
- 7) Press the **ENT** Key to complete the selection.
- 8) Press the **FMS** Knob to return to the Navigation Map Page.

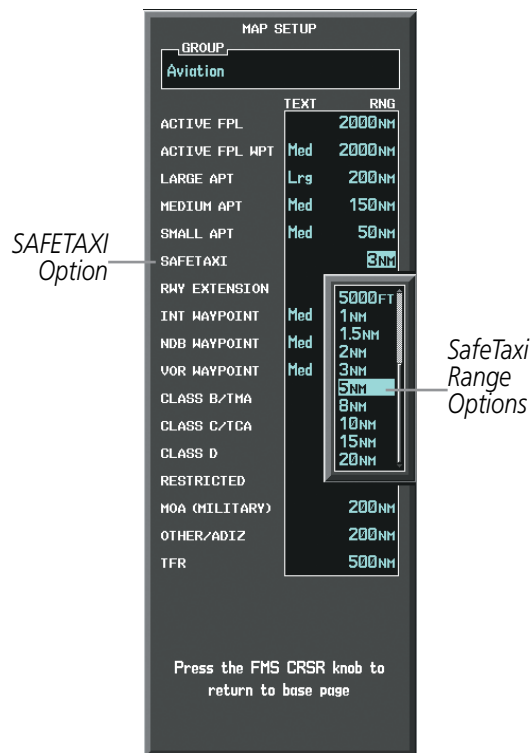

Figure 8-16 MAP SETUP Menu, Aviation Group, SAFETAXI Range Options

SAFETAXI CYCLE NUMBER AND REVISION

SafeTaxi database is revised every 56 days. SafeTaxi is always available for use after the expiration date. When turning on the system, the Power-up Page indicates whether the databases are current, out of date, or not available.

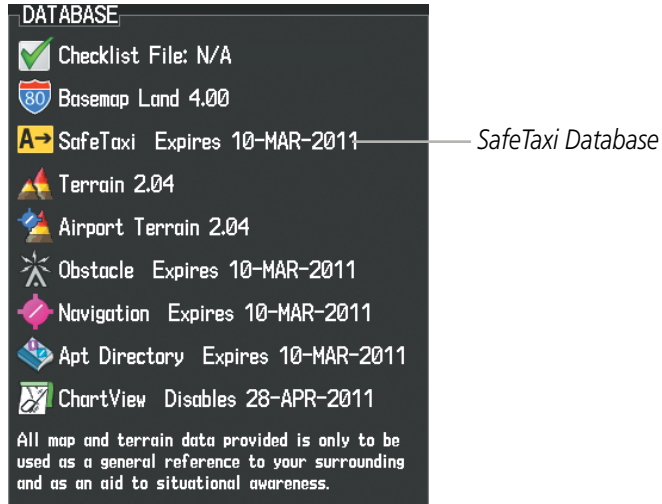

Figure 8-17 Power-up Page, SafeTaxi Database

Power-up Page Display	Definition
SafeTaxi Expires 10-MAR-2011	Normal operation. SafeTaxi database is valid and within current cycle.
SafeTaxi Expires 10-MAR-2011	SafeTaxi database has expired.
SafeTaxi: N/A	Database card contains no SafeTaxi data.

Table 8-1 SafeTaxi Annunciation Definitions

The SafeTaxi Region, Version, Cycle, Effective date and Expires date of the database cycle can also be found on the AUX - System Status page, as seen in Figure 8-18.

Select the **MFD1 DB** Softkey to place the cursor in the DATABASE window. Scroll through the listed information by turning the **FMS** Knob or pressing the **ENT** Key until the SafeTaxi database information is shown.

The SafeTaxi database cycle number shown in Figure 8-18, 11S3, is deciphered as follows:

- 11 – Indicates the year 2011
- S – Indicates the data is for SafeTaxi
- 3 – Indicates the third issue of the SafeTaxi database for the year

The SafeTaxi EFFECTIVE date 07–MAY–11 is the beginning date for the current database cycle. SafeTaxi EXPIRES date 02–JUL–11 is the revision date for the next database cycle.



Figure 8-18 AUX – System Status Page, SafeTaxi Current Information

SafeTaxi information appears in blue and yellow text. The EFFECTIVE date appears in blue when data is current and in yellow when the current date is before the effective date. The EXPIRES date appears in blue when data is current and in yellow when expired (Figures 8-18 and 8-19). NOT AVAILABLE appears in blue in the REGION field if SafeTaxi data is not available on the database card (Figure 8-19). An expired SafeTaxi database is not disabled and will continue to function indefinitely.

Select the **MFD1 DB** Softkey a second time. The softkey label will change to **PF1 DB**. The DATABASE window will now be displaying database information for PF1. As before, scroll through the listed information by turning the **FMS** Knob or pressing the **ENT** Key until the SafeTaxi database information is shown.

Select the **PFD1 DB** Softkey. The softkey label will change to **PFD2 DB**. The DATABASE window will now display database information for PFD2. Again, scroll through the listed information by turning the **FMS** Knob or pressing the **ENT** Key until the SafeTaxi database information is shown.

Refer to Updating Garmin Databases in Appendix B for instructions on revising the SafeTaxi database.

Figure 8-19 illustrates possible SafeTaxi database conditions that may appear on the AUX - System Status Page. The EFFECTIVE date is the beginning date for this database cycle. If the present date is before the effective date, the EFFECTIVE date appears in yellow and the EXPIRES date appears in blue. The EXPIRES date is the revision date for the next database cycle. NOT AVAILABLE indicates that SafeTaxi is not available on the database card or no database card is inserted.

MFD1 DATABASE	MFD1 DATABASE	MFD1 DATABASE
REGION WORLDWIDE	REGION WORLDWIDE	REGION WORLDWIDE
VERSION 4.00	VERSION 4.00	VERSION 4.00
GARMIN LTD. AND ITS SUBSIDIARIES 2010	GARMIN LTD. AND ITS SUBSIDIARIES 2010	GARMIN LTD. AND ITS SUBSIDIARIES 2010
SAFETAXI - BOTTOM CARD	SAFETAXI - BOTTOM CARD	SAFETAXI - UNKNOWN
REGION US	REGION US	REGION NOT AVAILABLE
VERSION 2.34	VERSION 2.34	VERSION
CYCLE 11S1	CYCLE 11S1	CYCLE
EFFECTIVE 13-JAN-11	EFFECTIVE 13-JAN-11	EFFECTIVE
EXPIRES 10-MAR-11	EXPIRES 10-MAR-11	EXPIRES
GARMIN LTD. AND ITS SUBSIDIARIES 2010	GARMIN LTD. AND ITS SUBSIDIARIES 2010	
TERRAIN - BOTTOM CARD	TERRAIN - BOTTOM CARD	TERRAIN - BOTTOM CARD
REGION WORLDWIDE-9	REGION WORLDWIDE-9	REGION WORLDWIDE-9
VERSION 2.04	VERSION 2.04	VERSION 2.04

Current Date is before Effective Date

SafeTaxi Database has Expired

SafeTaxi Database Not Installed

Figure 8-19 AUX – System Status Page, SafeTaxi Database Status

8.3 CHARTVIEW

ChartView resembles the paper version of Jeppesen terminal procedures charts. The charts are displayed in full color with high-resolution. The MFD depiction shows the aircraft position on the moving map in the plan view of approach charts and on airport diagrams. Airport Hot Spots are outlined in magenta.

The ChartView database subscription is available from Jeppesen, Inc. Available data includes:

- Arrivals (STAR)
- Departure Procedures (DP)
- Approaches
- Airport Diagrams
- NOTAMs

CHARTVIEW SOFTKEYS

ChartView functions are displayed on three levels of softkeys. While on the Navigation Map Page, Nearest Airports Page, or Flight Plan Page, selecting the **SHW CHRT** Softkey displays the available terminal chart and advances to the chart selection level of softkeys: **CHRT OPT**, **CHRT**, **INFO-1/2**, **DP**, **STAR**, **APR**, **WX**, **NOTAM**, and **GO BACK**. The chart selection softkeys shown below appear on the Airport Information Page.

Selecting the **GO BACK** Softkey reverts to the top level softkeys and previous page.

Selecting the **CHRT OPT** Softkey advances to the next level of softkeys: **ALL**, **HEADER**, **PLAN**, **PROFILE**, **MINIMUMS**, **FIT WDTN**, **FULL SCN**, and **BACK**.

While viewing the **CHRT OPT** Softkeys, after 45 seconds of softkey inactivity, the system reverts to the chart selection softkeys.

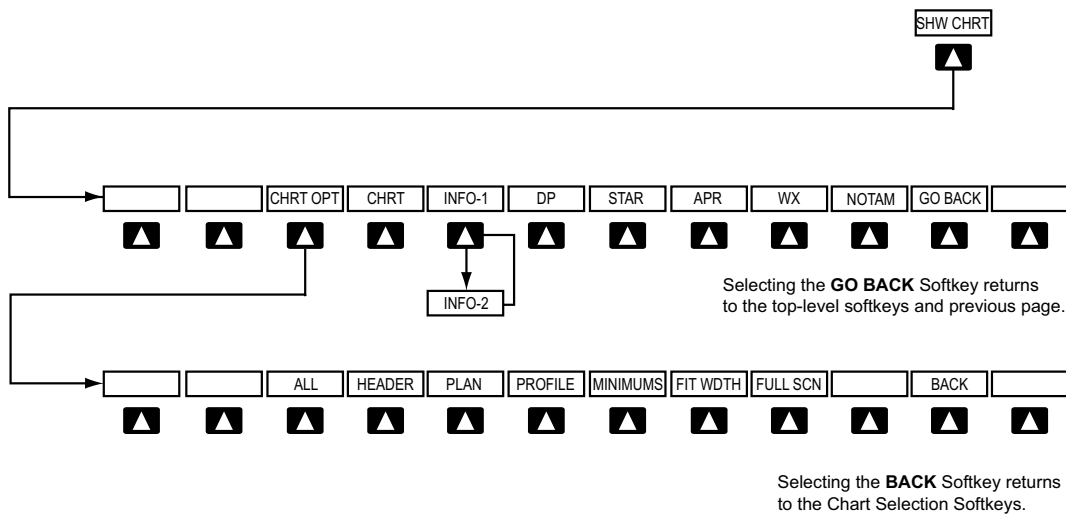

Figure 8-20 ChartView SHW CHRT, Chart Selection, and Chart Option Softkeys

TERMINAL PROCEDURES CHARTS

Selecting Terminal Procedures Charts:

While viewing the Navigation Map Page, Nearest Airport Page, or Flight Plan Page, select the **SHW CHRT** Softkey.

Or:

- 1) Press the **MENU** Key to display the PAGE MENU.
- 2) Turn the large **FMS** Knob to scroll through the OPTIONS Menu to Show Chart.
- 3) Press the **ENT** Key to display the chart.

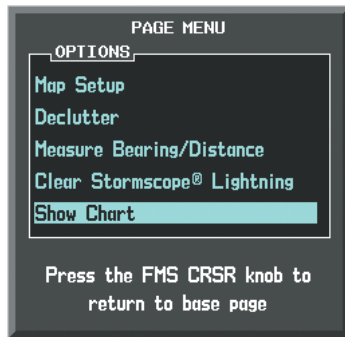

Navigation Map Page OPTIONS Menu

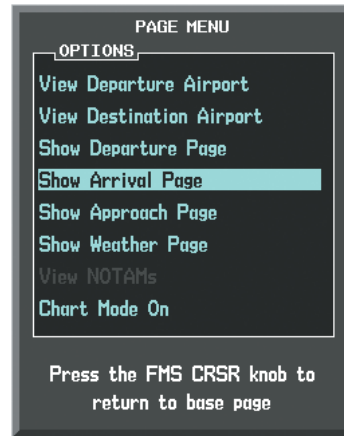

Waypoint Airport Information Page OPTIONS Menu

Figure 8-21 Option Menus

On the Waypoint Airport Information Page OPTIONS Menu, select the desired chart and press the **ENT** Key to display the chart.

When no terminal procedure chart is available, the banner CHART NOT AVAILABLE appears on the screen. The CHART NOT AVAILABLE banner does not refer to the FliteCharts subscription, but rather the availability of a particular airport chart selection or procedure for a selected airport.



Figure 8-22 Chart Not Available Banner

If there is a problem in rendering the data (such as a data error or a failure of an individual chart), the banner UNABLE TO DISPLAY CHART is then displayed.



Figure 8-23 Unable To Display Chart Banner

When a chart is not available by selecting the **SHW CHRT** Softkey or selecting a Page Menu Option, charts may be obtained for other airports from the WPT Pages or Flight Plan Pages.

If a chart is available for the destination airport, or the airport selected in the active flight plan, the chart appears on the screen. When no flight plan is active, or when not flying to a direct-to destination, selecting the **SHW CHRT** Softkey displays the chart for the nearest airport, if available.

The chart shown is one associated with the WPT – Airport Information page. Usually this is the airport runway diagram. Where no runway diagram exists, but Take Off Minimums or Alternate Minimums are available, that page appears. If Airport Information pages are unavailable, the Approach Chart for the airport is shown.

Selecting a chart:

- 1) While viewing the Navigation Map Page, Flight Plan Page, or Nearest Airports Page, select the **SHW CHRT** Softkey. The airport diagram or approach chart is displayed on the Airport Information Page.
- 2) Press the **FMS** Knob to activate the cursor.
- 3) Turn the large **FMS** Knob to select either the Airport Identifier Box or the Approach Box. (Select the **APR** Softkey if the Approach Box is not currently shown).
- 4) Turn the small and large **FMS** Knob to enter the desired airport identifier.
- 5) Press the **ENT** Key to complete the airport selection.
- 6) Turn the large **FMS** Knob to select the Approach Box.
- 7) Turn the small **FMS** Knob to show the approach chart selection choices.
- 8) Turn either **FMS** Knob to scroll through the available charts.
- 9) Press the **ENT** Key to complete the chart selection.

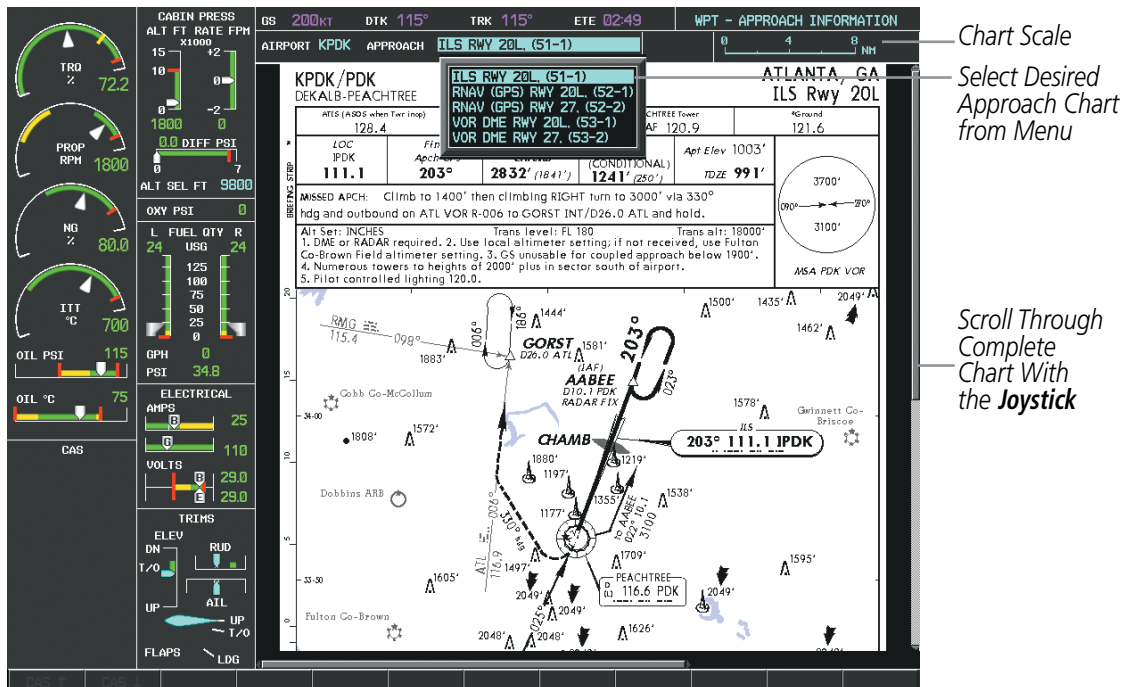

Figure 8-24 Approach Information Page, Chart Selection

While the APPROACH Box is selected using the **FMS** Knob, the G1000 softkeys are blank. Once the desired chart is selected, the chart scale can be changed and the chart page can be scrolled using the **Joystick**. Pressing the **Joystick** centers the chart on the screen.

The aircraft symbol is shown on the chart only if the chart is to scale and the aircraft position is within the boundaries of the chart. The aircraft symbol is not displayed when the Aircraft Not Shown Icon appears (Figure 8-28). If the Chart Scale Box displays a banner NOT TO SCALE, the aircraft symbol is not shown. The Aircraft Not Shown Icon may appear at certain times, even if the chart is displayed to scale.

Selecting the **CHRT** Softkey switches between the ChartView diagram and the associated map in the WPT page group. In the example shown, the **CHRT** Softkey switches between the Gainesville, FL (KGNV) Airport Diagram and the navigation map on the WPT – Airport Information page.

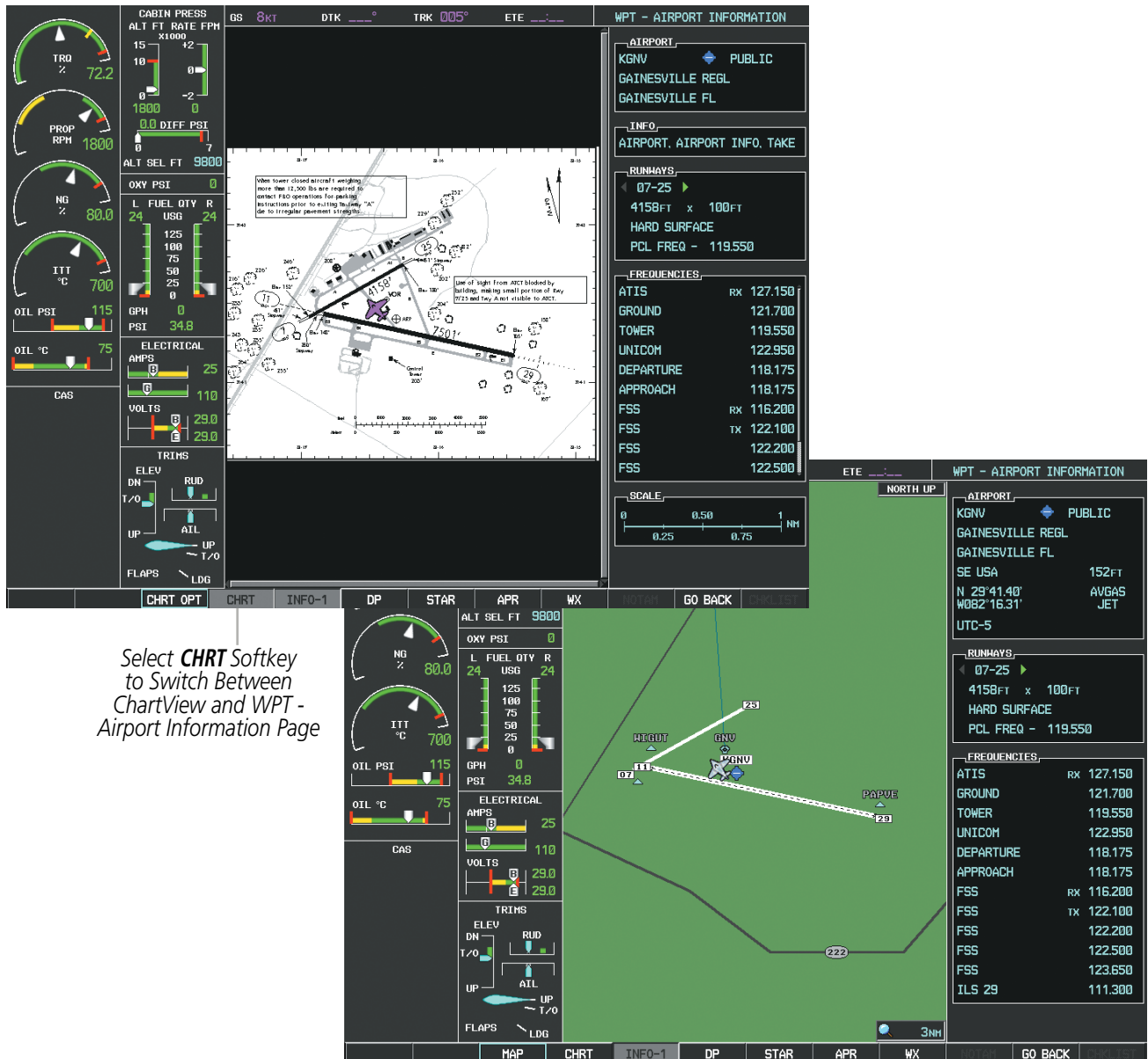

Figure 8-25 CHRT Softkey, Airport Information Page

Selecting the **INFO-1** or **INFO-2** Softkey returns to the airport diagram when the view is on a different chart. If the displayed chart is the airport diagram, the **INFO-1** or **INFO-2** Softkey has no effect.

The aircraft position is shown in magenta on the ChartView diagrams when the location of the aircraft is within the chart boundaries. In the example shown, the aircraft is taxiing on Taxiway Alpha on the Charlotte, NC (KCLT) airport.

Another source for additional airport information is from the INFO Box above the chart for certain airports. This information source is not related to the **INFO-1** or **INFO-2** Softkey. When the INFO Box is selected using the **FMS** Knob, the G1000 softkeys are blank. The Charlotte, NC airport has five additional charts offering information; the Airport Diagram, Take-off Minimums, Class B Airspace, Airline Parking Gate Coordinates, and Airline Parking Gate Location. (The numbers in parentheses after the chart name are Jeppesen designators.)

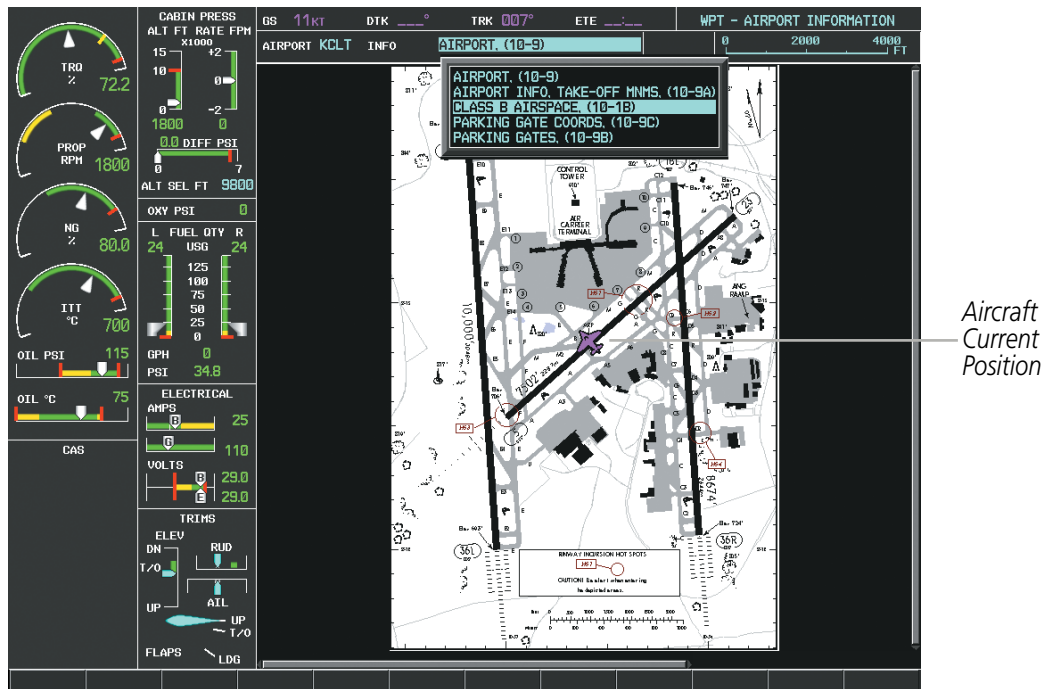

Figure 8-26 Airport Information Page, INFO View, Full Screen Width

In the example shown in Figure 8-26, the Class B Chart is selected. Pressing the **ENT** Key displays the Charlotte Class B Airspace Chart (Figure 8-27).

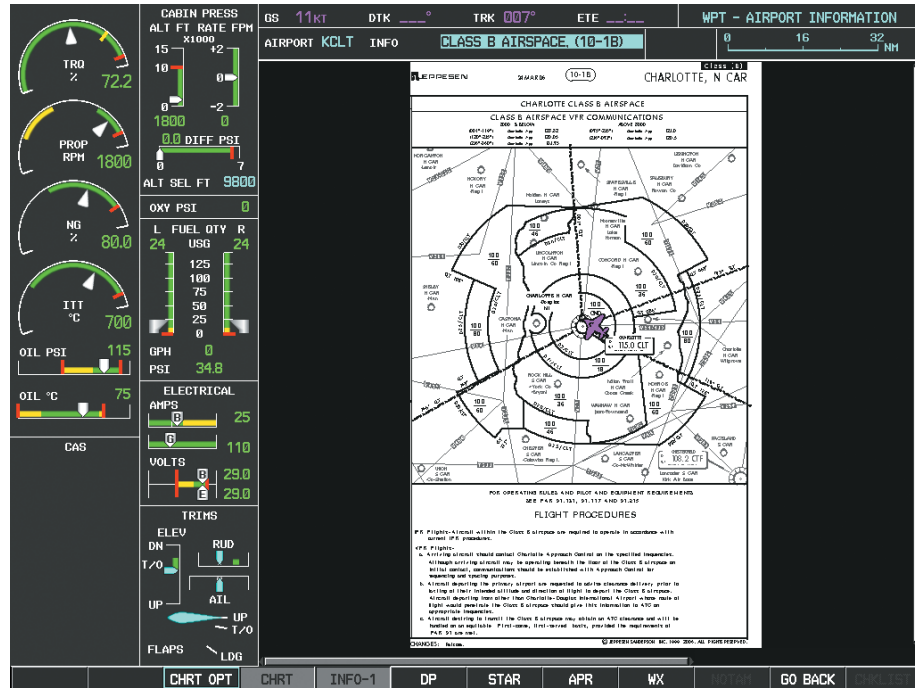

Figure 8-27 Airport Information Page, Class B Chart Selected from INFO View

Selecting the **DP** Softkey displays the Departure Procedure Chart if available.

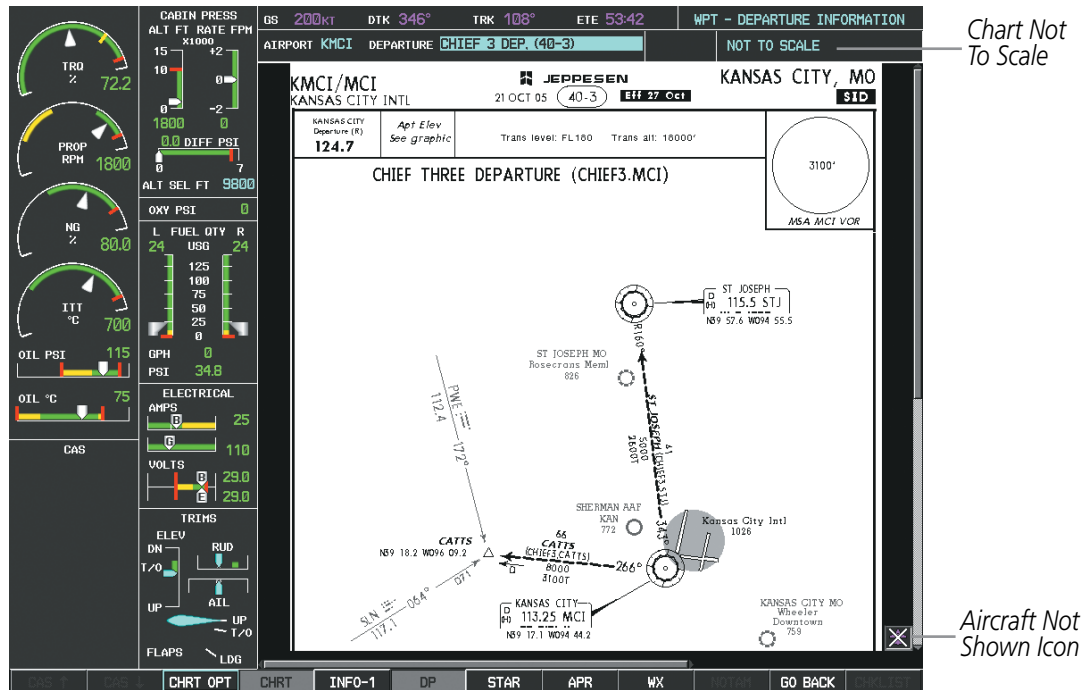

Figure 8-28 Departure Information Page

Selecting the **STAR** Softkey displays the Standard Terminal Arrival Chart if available.

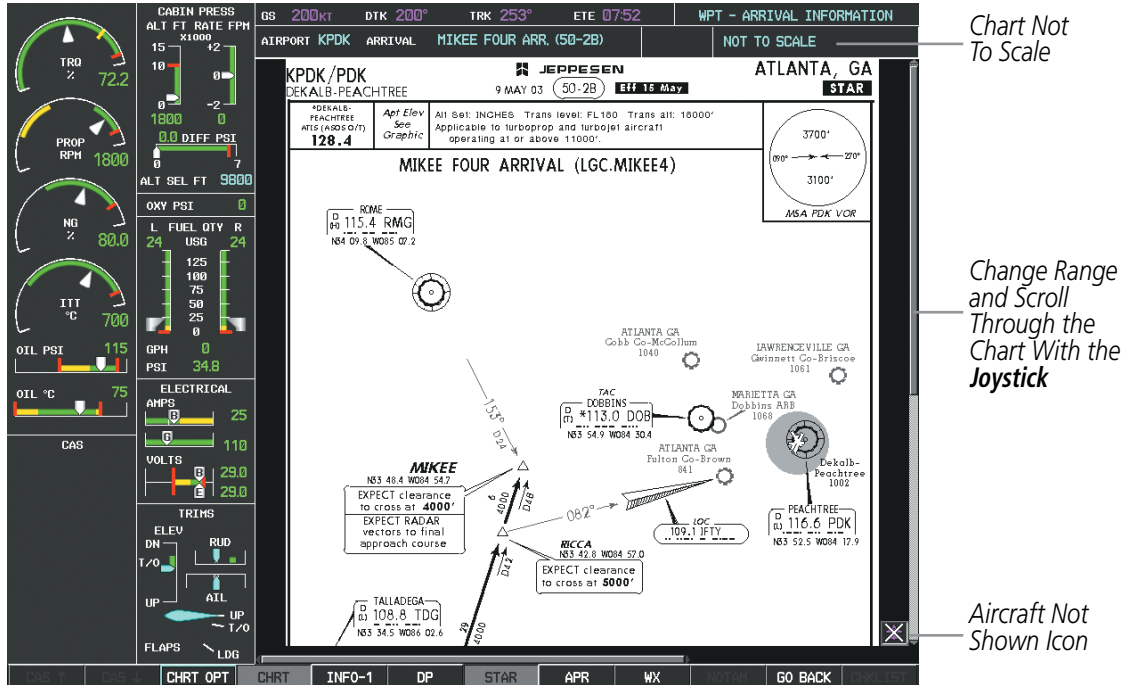

Figure 8-29 Arrival Information Page

Selecting the **APR** Softkey displays the approach chart for the airport if available.

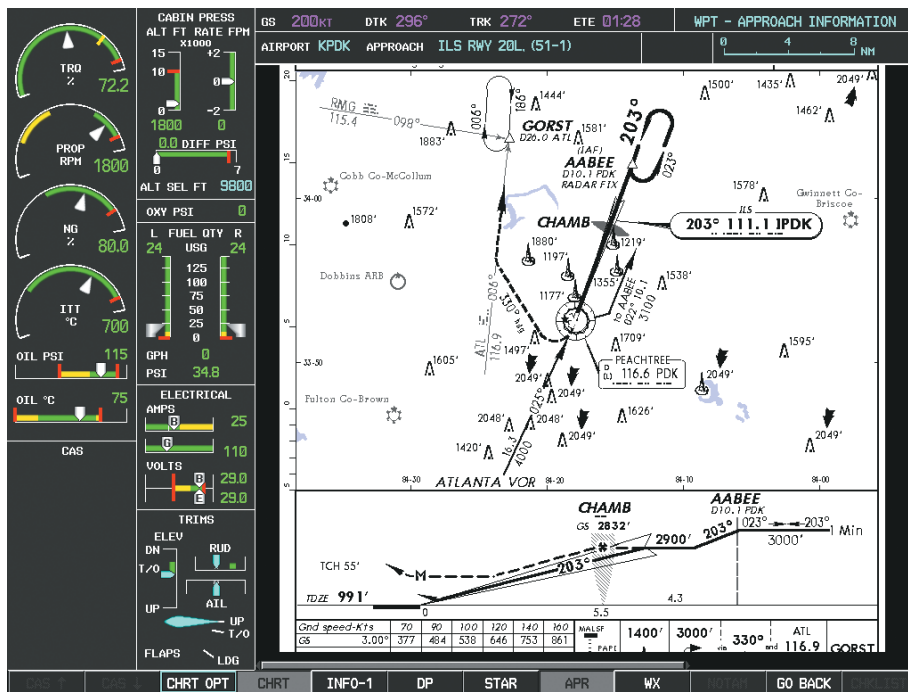

Figure 8-30 Approach Information Page

Selecting the **WX** Softkey shows the airport weather frequency information, and includes weather data such as METAR and TAF from the SiriusXM Data Link Receiver, when available. Weather information is available only when an SiriusXM Data Link Receiver is installed and the XM WX Satellite Weather subscription is current.

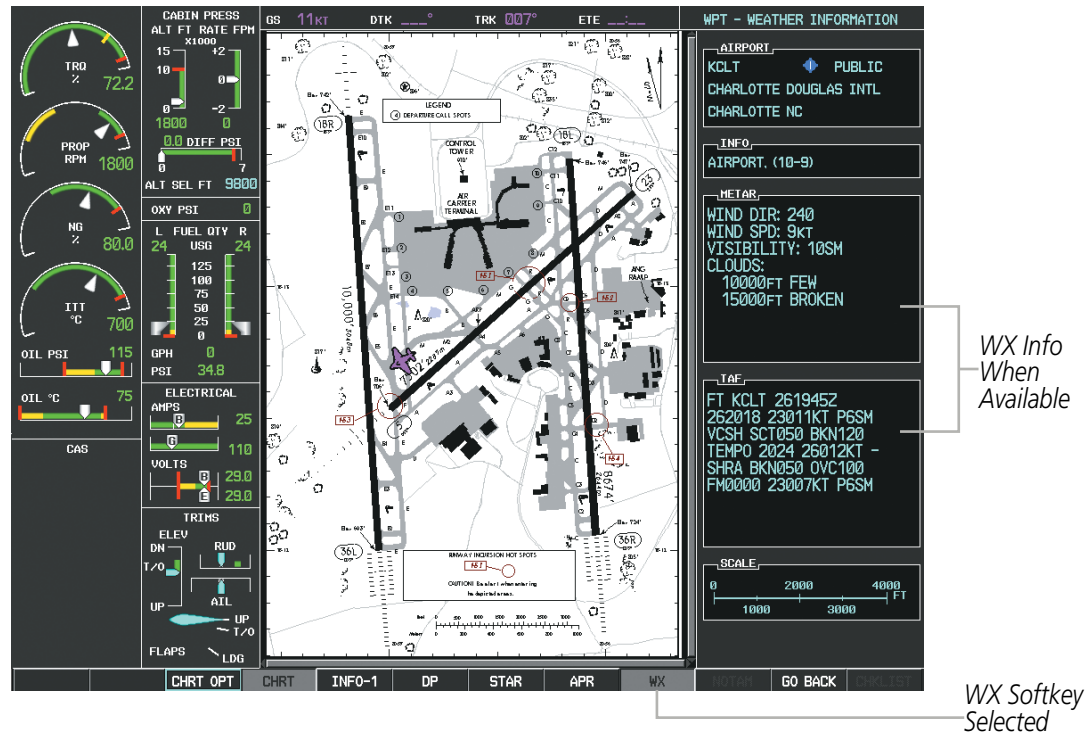
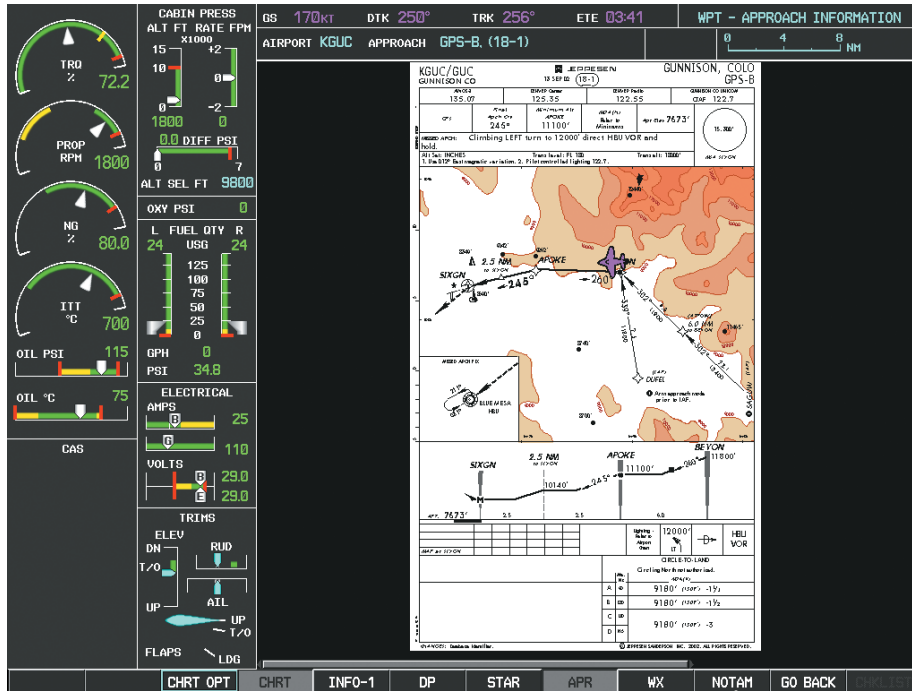

Figure 8-31 Weather Information Page

NOTE: A subdued softkey label indicates the function is disabled.

NOTE: Only NOTAMs applicable to specific information conveyed on the displayed Jeppesen chart are available when the NOTAM Softkey is selected. There may be other NOTAMs available pertaining to the flight that may not be displayed. Contact Jeppesen for more information regarding Jeppesen database-published NOTAMs.

Recent NOTAMs applicable to the current ChartView cycle are included in the ChartView database. Selecting the **NOTAM** Softkey shows the local NOTAM information for selected airports, when available. When NOTAMs are not available, the **NOTAM** Softkey label appears subdued and is disabled as shown in Figure 8-31. The **NOTAM** Softkey may appear on the Airport Information Page and all of the chart page selections.



NOTAM Softkey Appears for Selected Airports

Figure 8-32 NOTAM Available

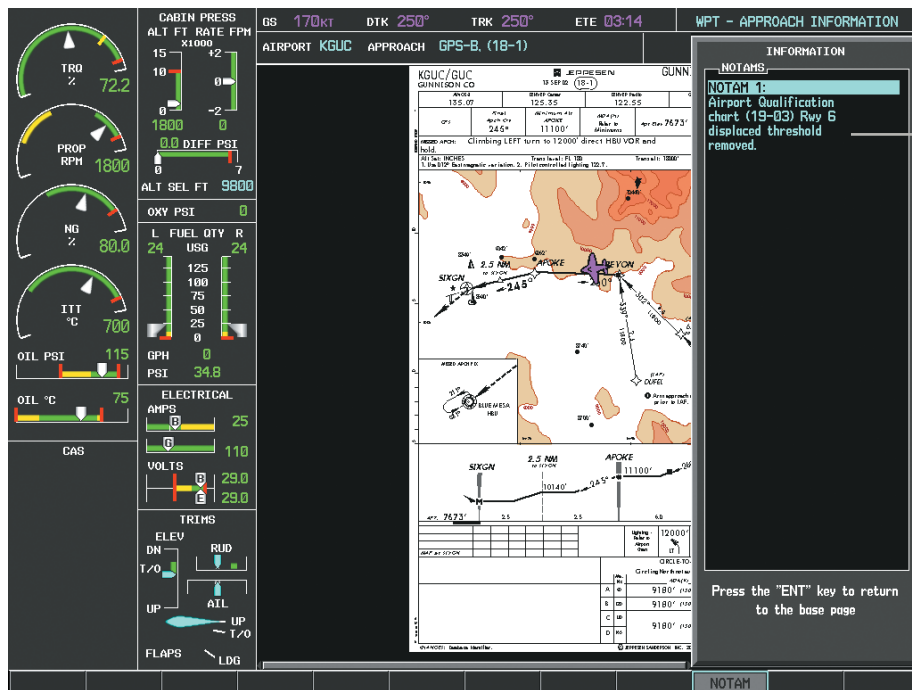

Local NOTAM on This Airport

NOTAM Softkey Selected

Figure 8-33 Airport Information Page, Local NOTAMS

Selecting the **NOTAM** Softkey again removes the NOTAMS information.

Selecting the **GO BACK** Softkey reverts to the previous page (Navigation Map Page, Nearest Pages, or Flight Plan Page).

CHART OPTIONS

Selecting the **CHRT OPT** Softkey displays the next level of softkeys, the chart options level (Figure 8-20).
 Selecting the **ALL** Softkey shows the entire approach chart on the screen.

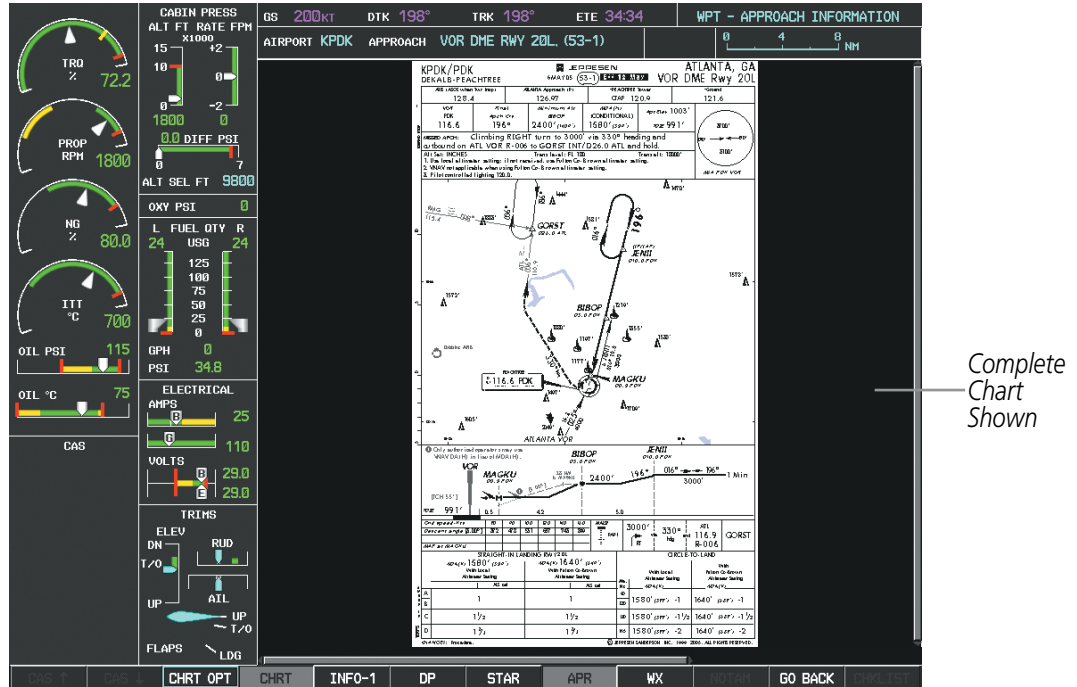
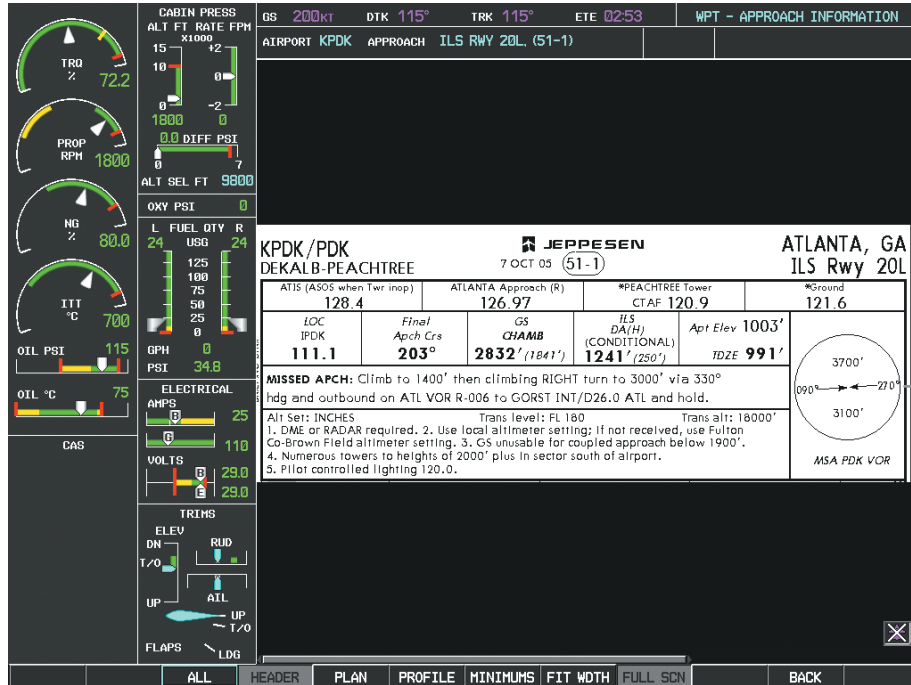

Figure 8-34 Approach Information Page, ALL View

Selecting the **HEADER** Softkey shows the header view (approach chart briefing strip) on the screen.



Approach Chart Briefing Strip

Figure 8-35 Approach Information Page, Header View

Selecting the **PLAN** Softkey shows the approach chart two dimensional plan view.

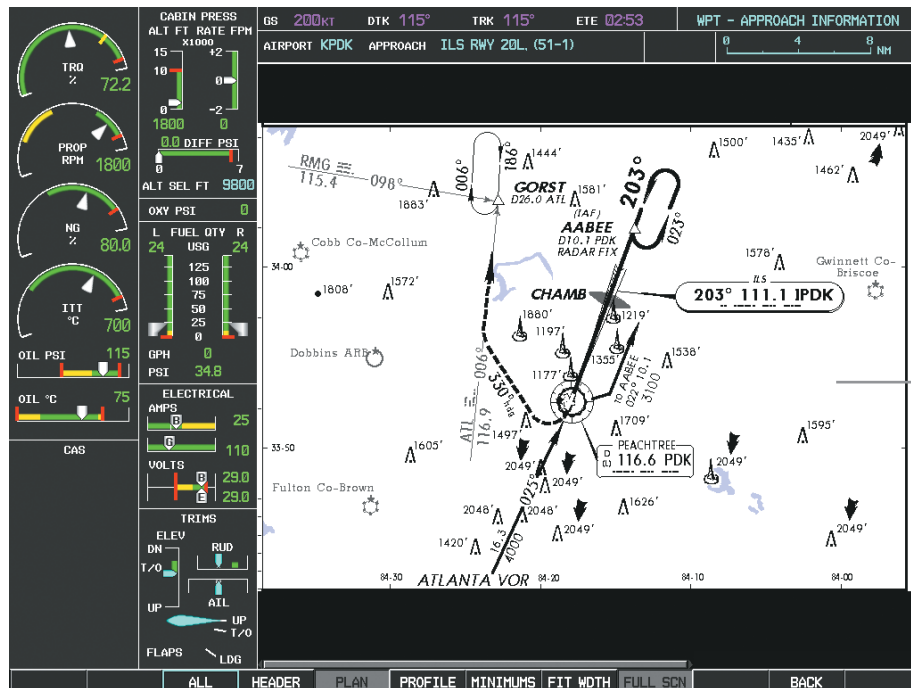

Approach Chart Plan View

Figure 8-36 Approach Information Page, Plan View

Selecting the **PROFILE** Softkey displays the approach chart descent profile strip.

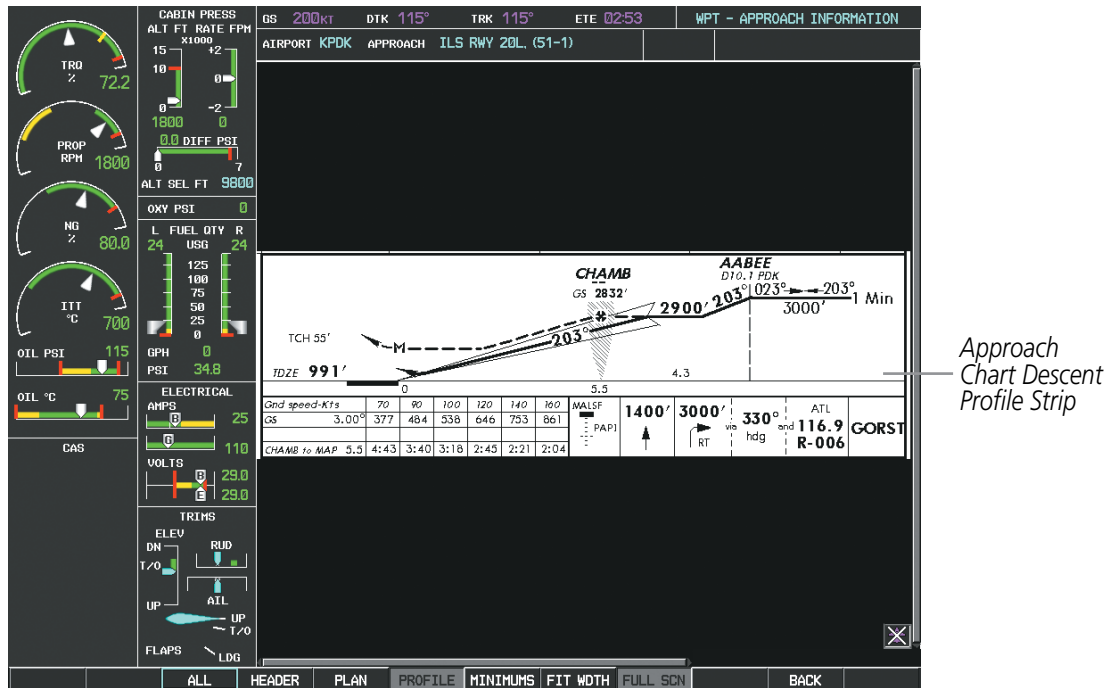

Figure 8-37 Approach Information Page, Profile View, Full Screen Width

Selecting the **MINIMUMS** Softkey displays the minimum descent altitude/visibility strip at the bottom of the approach chart.

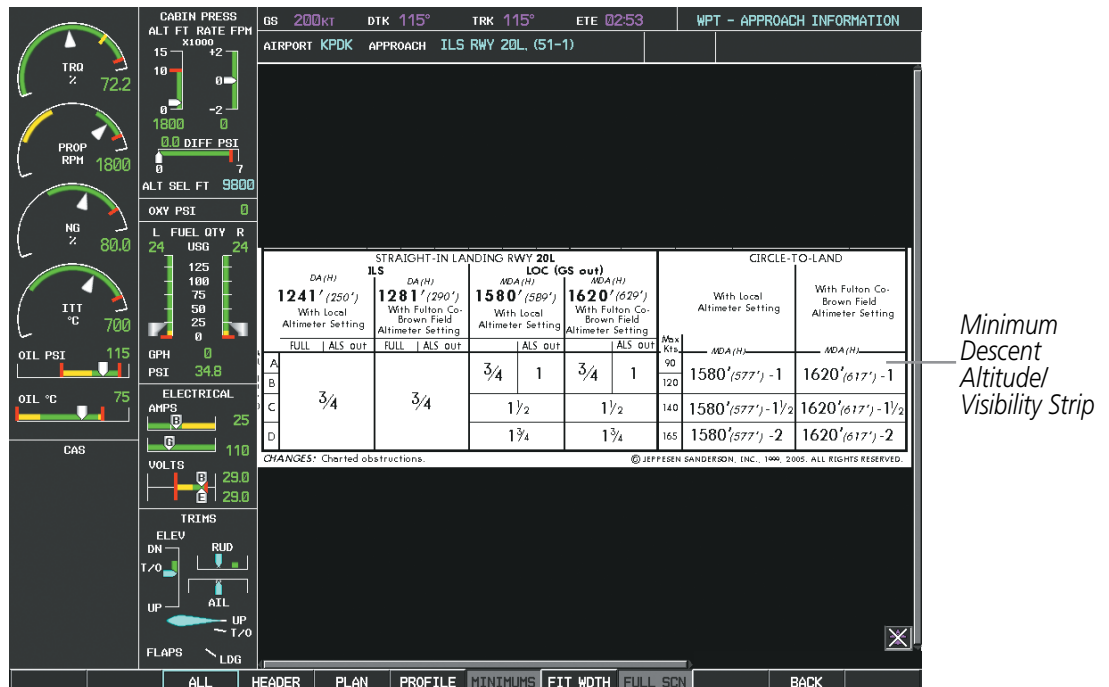
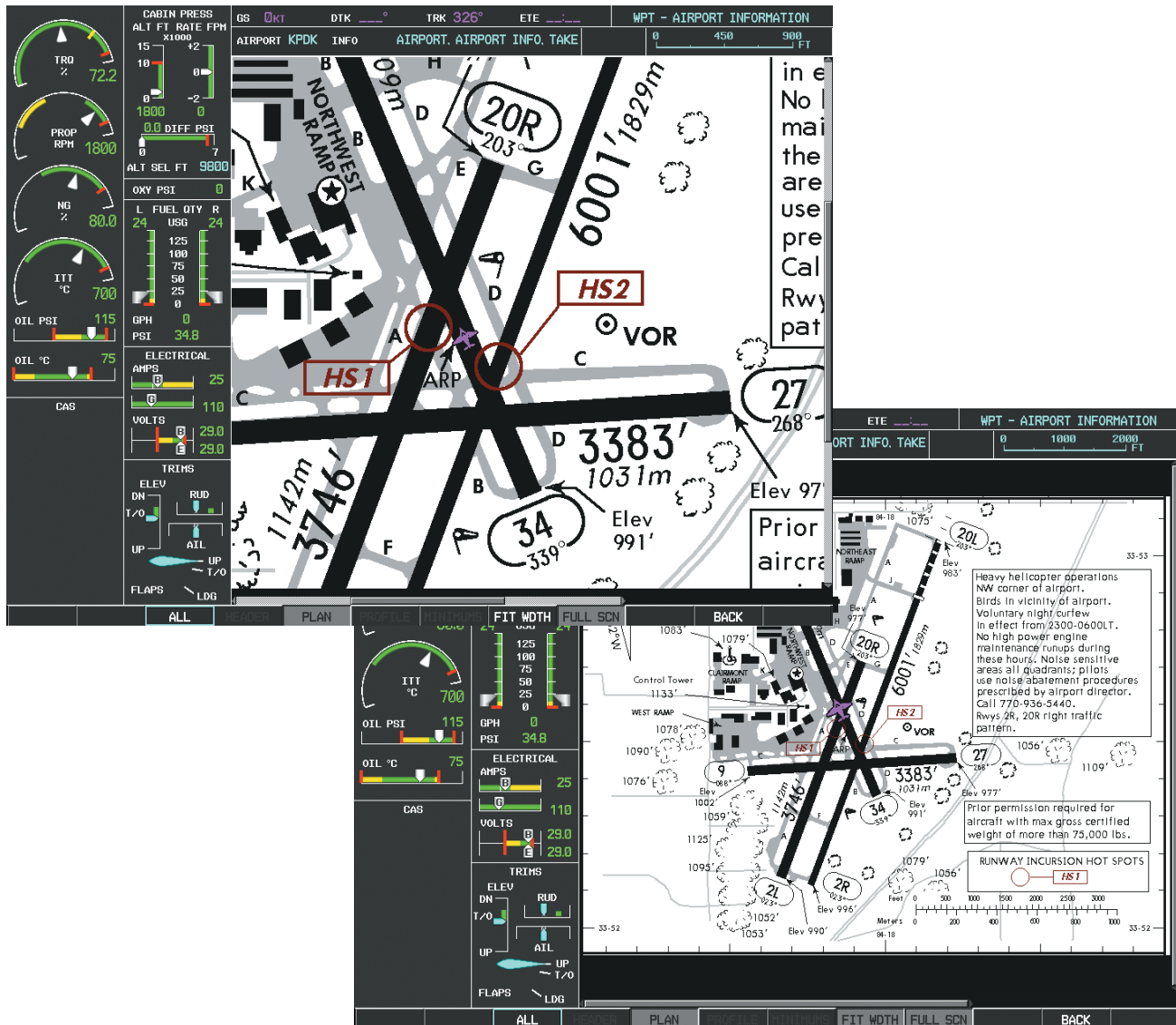

Figure 8-38 Approach Information Page, Minimums View, Full Screen Width

If the chart scale has been adjusted to view a small area of the chart, selecting the **FIT WIDTH** Softkey changes the chart size to fit the available screen width.



Select **FIT WIDTH** Softkey to Show Full Chart Width

Figure 8-39 Airport Information Page, FIT WIDTH Softkey Selected

Selecting the **FULL SCN** Softkey alternates between removing and replacing the data window to the right.

Selecting Additional Information:

- 1) While viewing the Airport Taxi Diagram, select the **FULL SCN** Softkey to display the information windows (AIRPORT, INFO).
- 2) Press the **FMS** Knob to activate the cursor.
- 3) Turn the large **FMS** Knob to highlight the AIRPORT, INFO, RUNWAYS, or FREQUENCIES Box (INFO Box shown).
- 4) Turn the small **FMS** Knob to select the INFO Box choices. If multiple choices are available, scroll to the desired choice with the large **FMS** Knob and press the **ENT** Key to complete the selection.
- 5) Press the **FMS** Knob again to deactivate the cursor.

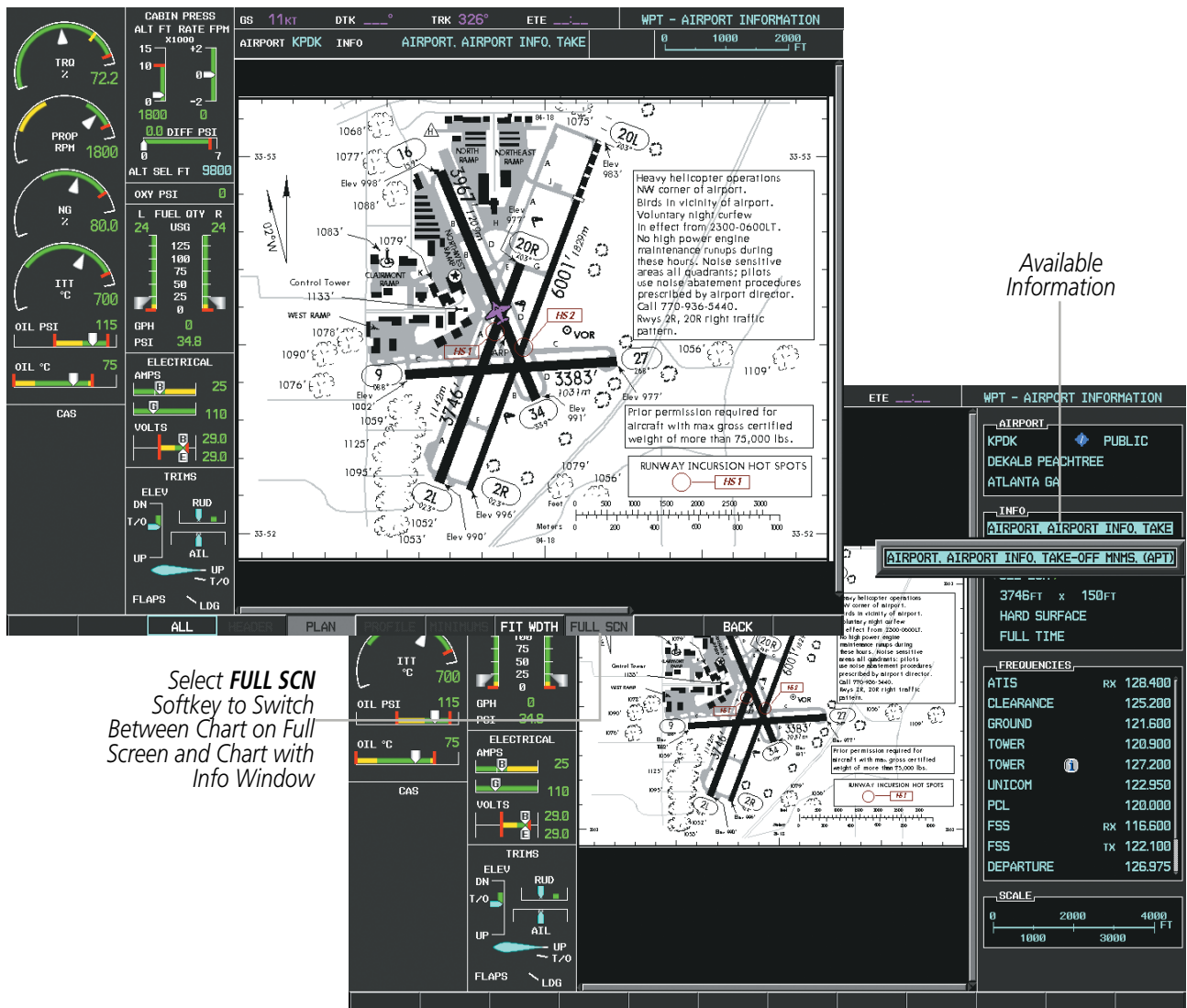

Select **FULL SCN** Softkey to Switch Between Chart on Full Screen and Chart with Info Window

Figure 8-40 Airport Information Page, Full Screen and Info Window

Selecting the **BACK** Softkey, or waiting for 45 seconds reverts to the chart selection softkeys.

The full screen view can also be selected by using the page menu option.

Selecting full screen On or Off:

- 1) While viewing a terminal chart press the **MENU** Key to display the Page Menu OPTIONS.
- 2) Turn the large **FMS** Knob to highlight the Chart Setup Menu Option and press the **ENT** Key.
- 3) Turn the large **FMS** Knob to move between the FULL SCREEN and COLOR SCHEME Options.
- 4) Turn the small **FMS** Knob to choose between the On and Off Full Screen Options.



Chart Setup Option

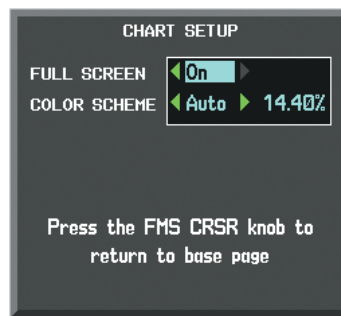

Full Screen On/Off Selection

Figure 8-41 Page Menus

DAY/NIGHT VIEW

ChartView can be displayed on a white or black background for day or night viewing. The Day View offers a better presentation in a bright environment. The Night View gives a better presentation for viewing in a dark environment. When the CHART SETUP Box is selected the G1000 softkeys are blank.

Selecting Day, Night, or Automatic View:

- 1) While viewing a terminal chart press the **MENU** Key to display the Page Menu OPTIONS.
- 2) Turn the large **FMS** Knob to highlight the Chart Setup Menu Option and press the **ENT** Key.

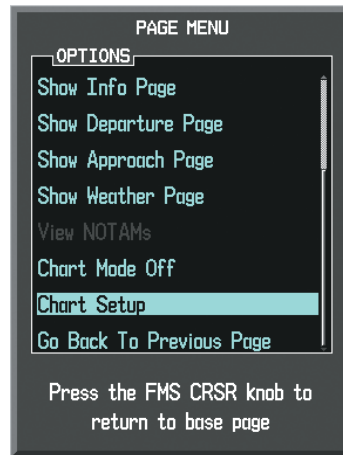

Figure 8-42 Waypoint Information Page, OPTIONS Menu

- 3) Turn the large **FMS** Knob to move to the COLOR SCHEME Option (Figure 8-43).
- 4) Turn the small **FMS** Knob to choose between Day, Auto, and Night Options.
- 5) If Auto Mode is selected, turn the large **FMS** Knob to select the percentage field. Use the small **FMS** Knob to change the percentage value. The percentage value is the day/night crossover point based on the percentage of backlighting intensity. For example, if the value is set to 15%, the day/night display changes when the display backlight reaches 15% of full brightness.

The display must be changed in order for the new setting to become active. This may be accomplished by selecting another page or changing the display range.

- 6) Press the **FMS** Knob when finished to remove the Chart Setup Menu.

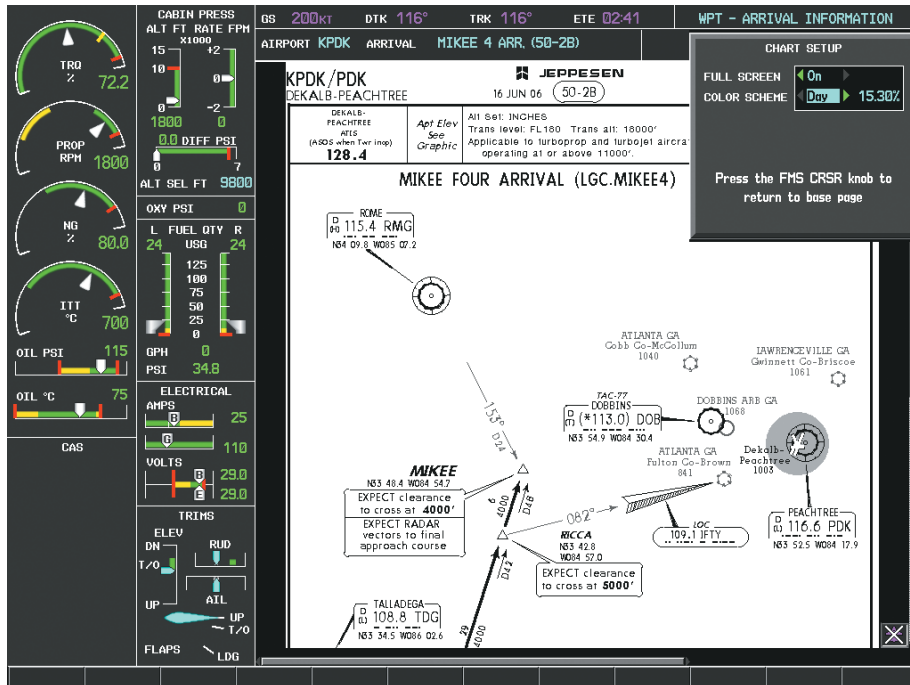

Figure 8-43 Arrival Information Page, Day View

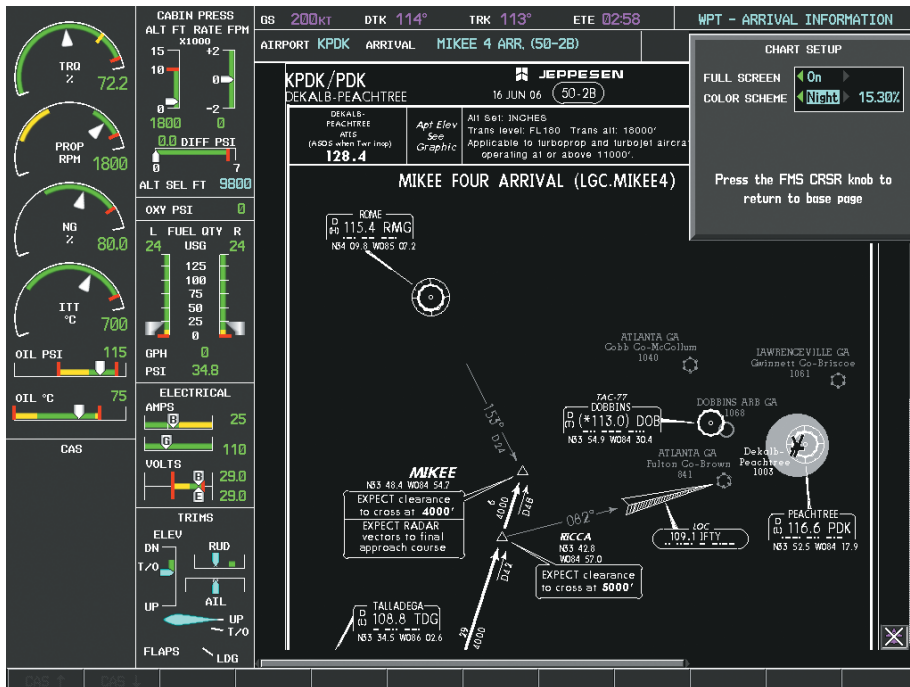

Figure 8-44 Arrival Information Page, Night View

CHARTVIEW CYCLE NUMBER AND EXPIRATION DATE

ChartView database is revised every 14 days. Charts are still viewable during a period that extends from the cycle expiration date to the disables date. ChartView is disabled 70 days after the expiration date and is no longer available for viewing. When turning on the system, the Power-up Page displays the current status of the ChartView database. See the table below for the various ChartView Power-up Page displays and the definition of each.

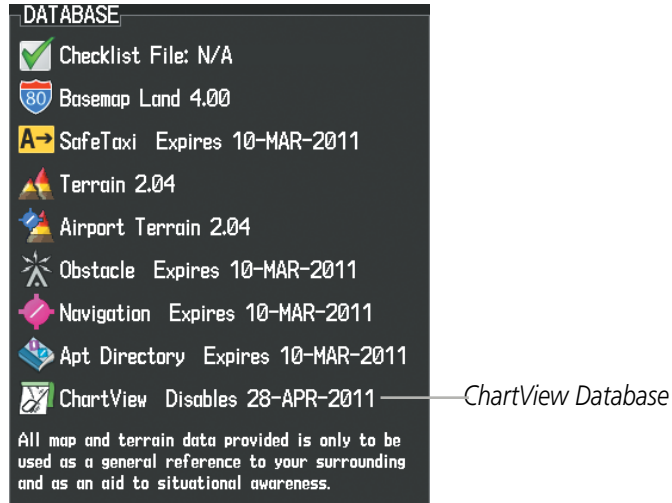

Figure 8-45 Power-up Page, ChartView Database

Power-up Page Display	Definition
	Blank Line. System is not configured for ChartView. Contact a Garmin-authorized service center for configuration.
	System is configured for ChartView but no chart database is installed. Contact Jeppesen for a ChartView database.
	Normal operation. ChartView database is valid and within current cycle.
	ChartView database is within 1 week after expiration date. A new cycle is available for update.
	ChartView database is beyond 1 week after expiration date, but still within the 70 day viewing period.
	ChartView database has timed out. Database is beyond 70 days after expiration date. ChartView database is no longer available for viewing.
	System time is not available. GPS satellite data is unknown or the system has not yet locked onto satellites. Check database cycle number for effectivity.
	System is verifying chart database when new cycle is installed for the first time.
	After verifying, chart database is found to be corrupt. ChartView is not available.

Table 8-2 ChartView Power-up Page Annunciations and Definitions

The ChartView time critical information can also be found on the AUX - System Status page. The database CYCLE number, EXPIRES, and DISABLES dates of the ChartView subscription appear in either blue or yellow text. When the ChartView EXPIRES date is reached, ChartView becomes inoperative 70 days later. This is shown as the DISABLES date. When the DISABLES date is reached, charts are no longer available for viewing. The **SHW CHRT** Softkey label then appears subdued and is disabled until a revised issue of ChartView is installed.



NOTE: A subdued softkey label indicates the function is disabled.

Select the **MFD1 DB** Softkey to place the cursor in the DATABASE window. Scroll through the listed information by turning the **FMS** Knob or pressing the **ENT** Key until the ChartView database information is shown.

The ChartView database cycle number shown in the figure, 1104, is deciphered as follows:

11 – Indicates the year 2011

04 – Indicates the fourth issue of the ChartView database for the year

The EXPIRES date 05–MAR–11 is the date that this database should be replaced with the next issue.

The DISABLES date 14–MAY–11 is the date that this database becomes inoperative.

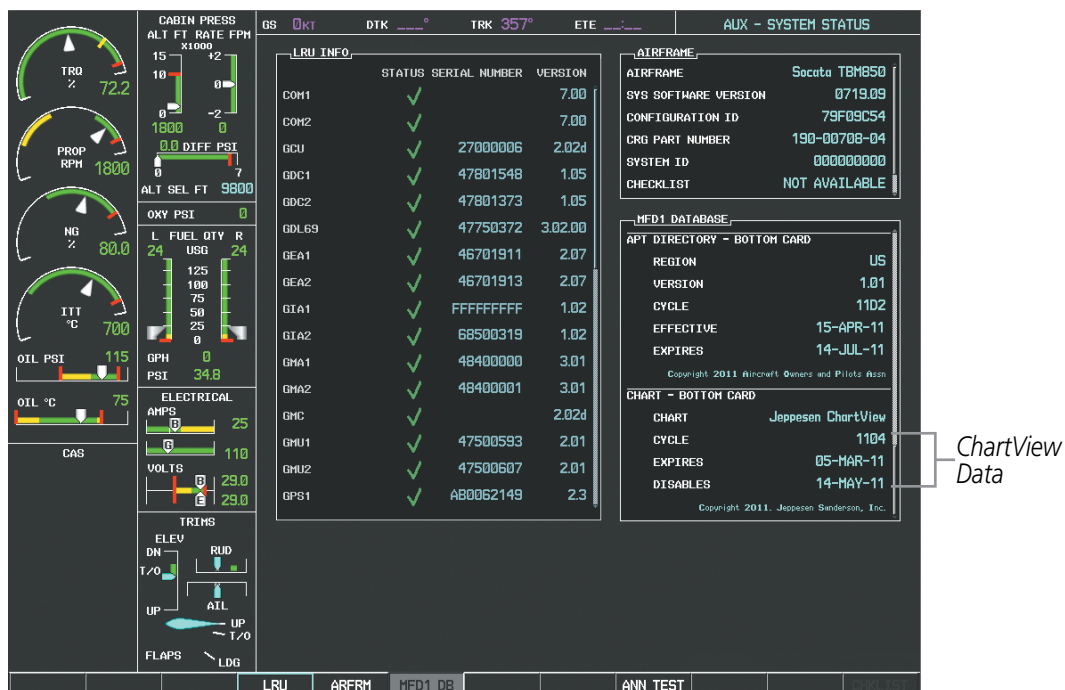

Figure 8-46 AUX – System Status Page, ChartView Current and Available

The ChartView database is obtained directly from Jeppesen. Refer to Updating Jeppesen Databases in Appendix B for instructions on revising the ChartView database.

Other possible AUX - System Status page conditions are shown in Figure 8-47. The EXPIRES date, in yellow, is the revision date for the next database cycle. The DISABLES date, in yellow, is the date that this database cycle is no longer viewable. CYCLE NOT AVAILABLE in blue, indicates no ChartView data is available on the database card or no database card is inserted.

<p>MFD1 DATABASE</p> <p>APT DIRECTORY - BOTTOM CARD</p> <p>REGION US</p> <p>VERSION 1.01</p> <p>CYCLE 11D1</p> <p>EFFECTIVE 13-JAN-11</p> <p>EXPIRES 10-MAR-11</p> <p>Copyright 2010 Aircraft Owners and Pilots Assn</p> <hr/> <p>CHART - BOTTOM CARD</p> <p>CHART Jeppesen ChartView</p> <p>CYCLE 1103</p> <p>EXPIRES 17-FEB-11</p> <p>DISABLES 28-APR-11</p> <p>Copyright 2011. Jeppesen Sanderson, Inc.</p>	<p>MFD1 DATABASE</p> <p>APT DIRECTORY - BOTTOM CARD</p> <p>REGION US</p> <p>VERSION 1.01</p> <p>CYCLE 11D1</p> <p>EFFECTIVE 13-JAN-11</p> <p>EXPIRES 10-MAR-11</p> <p>Copyright 2010 Aircraft Owners and Pilots Assn</p> <hr/> <p>CHART - BOTTOM CARD</p> <p>CHART Jeppesen ChartView</p> <p>CYCLE 1103</p> <p>EXPIRES 17-FEB-11</p> <p>DISABLES 28-APR-11</p> <p>Copyright 2011. Jeppesen Sanderson, Inc.</p>	<p>MFD1 DATABASE</p> <p>REGION US</p> <p>VERSION 1.01</p> <p>CYCLE 11D1</p> <p>EFFECTIVE 13-JAN-11</p> <p>EXPIRES 10-MAR-11</p> <p>Copyright 2010 Aircraft Owners and Pilots Assn</p> <hr/> <p>CHART - UNKNOWN</p> <p>CHART Jeppesen ChartView</p> <p>REGION NOT AVAILABLE</p> <p>CYCLE NOT AVAILABLE</p> <p>EFFECTIVE -- -- --</p> <p>EXPIRES -- -- --</p> <p>DISABLES -- -- --</p>
---	---	---

ChartView has Expired, but is not Disabled

ChartView Database is Disabled

ChartView Database is Not Available

Figure 8-47 AUX – System Status Page, ChartView Database Status

8.4 FLITECHARTS

FliteCharts resemble the paper version of AeroNav Services terminal procedures charts. The charts are displayed with high-resolution and in color for applicable charts. FliteCharts database subscription is available from Garmin. Available data includes:

- Arrivals (STAR)
- Departure Procedures (DP)
- Approaches
- Airport Diagrams

FLITECHARTS SOFTKEYS

FliteCharts functions are displayed on three levels of softkeys. While on the Navigation Map Page, Nearest Airports Page, or Flight Plan Page, selecting the **SHW CHRT** Softkey displays the available terminal chart and advances to the chart selection level of softkeys: **CHRT OPT**, **CHRT**, **INFO-1/2**, **DP**, **STAR**, **APR**, **WX**, and **GO BACK**. The chart selection softkeys appear on the Airport Information Page.

Selecting the **GO BACK** Softkey reverts to the top level softkeys and previous page.

Selecting the **CHRT OPT** Softkey displays the available terminal chart and advances to the next level of softkeys: **ALL**, **FIT WDTH**, **FULL SCN**, and **BACK**.

While viewing the **CHRT OPT** Softkeys, after 45 seconds of softkey inactivity, the system reverts to the chart selection softkeys.

NOTAMs are not available with FliteCharts. The NOTAM Softkey label appears subdued and is disabled.

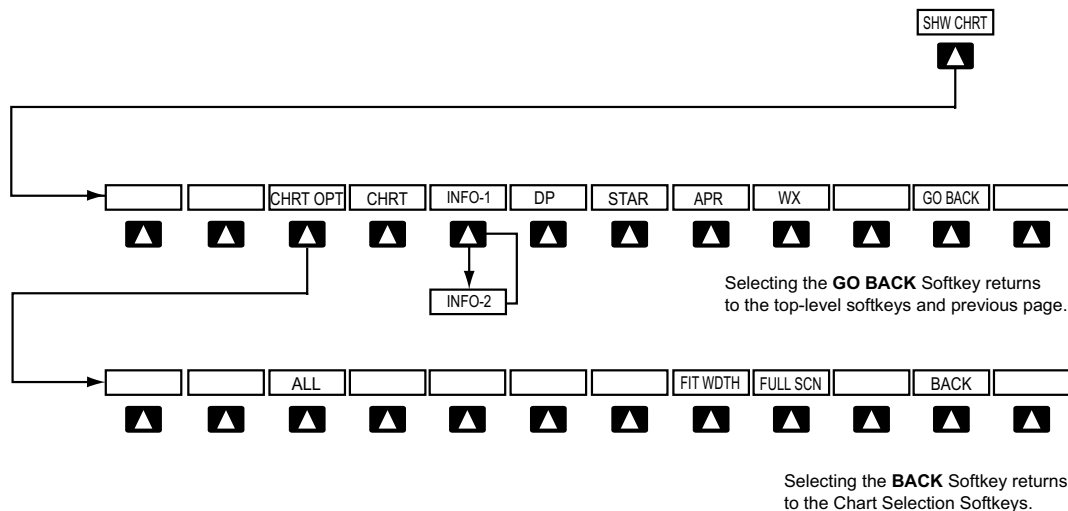

Figure 8-48 FliteCharts SHW CHRT, Chart Selection, and Chart Option Softkeys

TERMINAL PROCEDURES CHARTS

Selecting Terminal Procedures Charts:

While viewing the Navigation Map Page, Nearest Airport Page, or Flight Plan Page, select the **SHW CHRT** Softkey.

Or:

- 1) Press the **MENU** Key to display the PAGE MENU.
- 2) Turn the large **FMS** Knob to scroll through the OPTIONS Menu to Show Chart.
- 3) Press the **ENT** Key to display the chart.

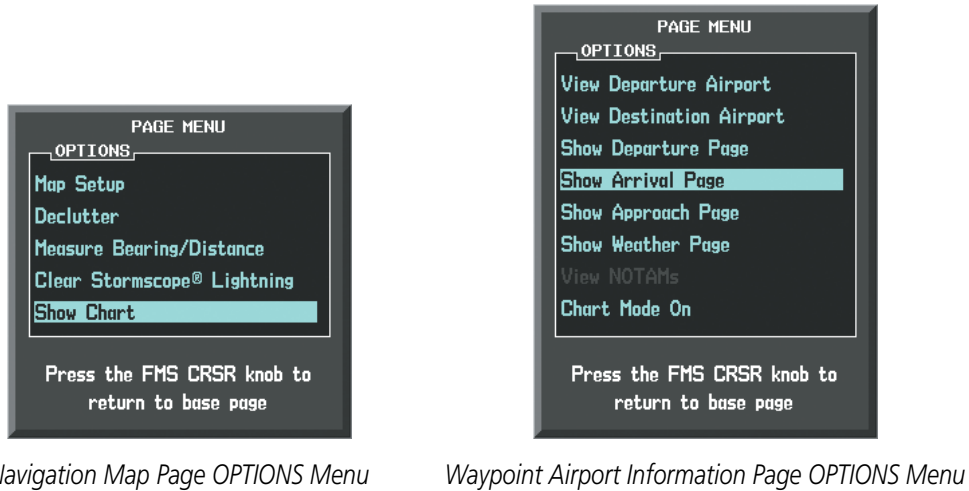

Figure 8-49 Option Menus

On the Waypoint Airport Information Page OPTIONS Menu, select the desired chart and press the **ENT** Key to display the chart.

When no terminal procedure chart is available, the banner CHART NOT AVAILABLE appears on the screen. The CHART NOT AVAILABLE banner does not refer to the FliteCharts subscription, but rather the availability of a particular airport chart selection or procedure for a selected airport.



Figure 8-50 Chart Not Available Banner

If there is a problem in rendering the data (such as a data error or a failure of an individual chart), the banner UNABLE TO DISPLAY CHART is then displayed.



Figure 8-51 Unable To Display Chart Banner

When a chart is not available by selecting the **SHW CHRT** Softkey or selecting a Page Menu Option, charts may be obtained for other airports from the WPT Pages or Flight Plan Pages.

If a chart is available for the destination airport, or the airport selected in the active flight plan, the chart appears on the screen. When no flight plan is active, or when not flying to a direct-to destination, selecting the **SHW CHRT** Softkey displays the chart for the nearest airport, if available.

The chart shown is one associated with the WPT – Airport Information page. Usually this is the airport runway diagram. Where no runway diagram exists, but Take Off Minimums or Alternate Minimums are available, that page appears. If Airport Information pages are unavailable, the Approach Chart for the airport is shown.

Selecting a chart:

- 1) While viewing the Navigation Map Page, Flight Plan Page, or Nearest Airports Page, select the **SHW CHRT** Softkey. The airport diagram or approach chart is displayed on the Airport Information Page.
- 2) Press the **FMS** Knob to activate the cursor.
- 3) Turn the large **FMS** Knob to select either the Airport Identifier Box or the Approach Box. (Select the **APR** Softkey if the Approach Box is not currently shown).
- 4) Turn the small and large **FMS** Knob to enter the desired airport identifier.
- 5) Press the **ENT** Key to complete the airport selection.
- 6) Turn the large **FMS** Knob to select the Approach Box.
- 7) Turn the small **FMS** Knob to show the approach chart selection choices.
- 8) Turn either **FMS** Knob to scroll through the available charts.
- 9) Press the **ENT** Key to complete the chart selection.

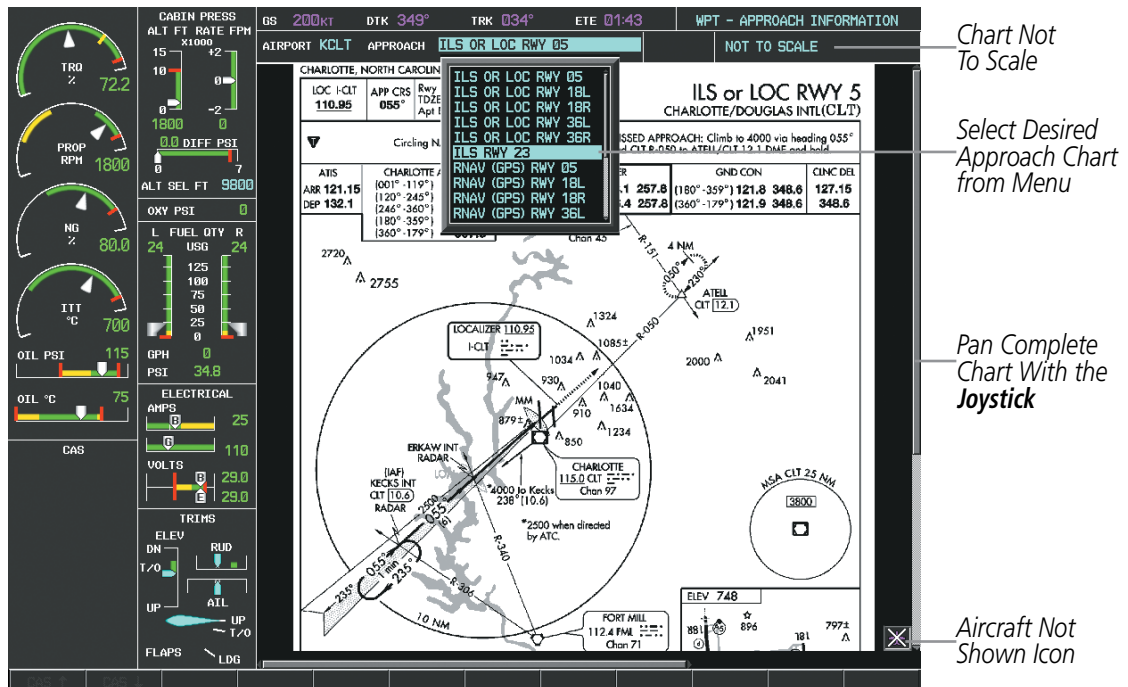

Figure 8-52 Approach Information Page, Chart Selection

While the APPROACH Box is selected using the **FMS** Knob, the G1000 softkeys are blank. Once the desired chart is selected, the chart scale can be changed and the chart can be panned using the **Joystick**. Pressing the **Joystick** centers the chart on the screen.

The aircraft symbol is not shown on FliteCharts. The Chart Scale Box displays a banner NOT TO SCALE, and the Aircraft Not Shown Icon is displayed in the lower right corner of the screen.

Selecting the **CHRT** Softkey switches between the FliteCharts diagram and the associated map in the WPT page group. In the example shown, the **CHRT** Softkey switches between the Gainesville, FL (KGNV) Airport Diagram and the navigation map on the WPT – Airport Information page.

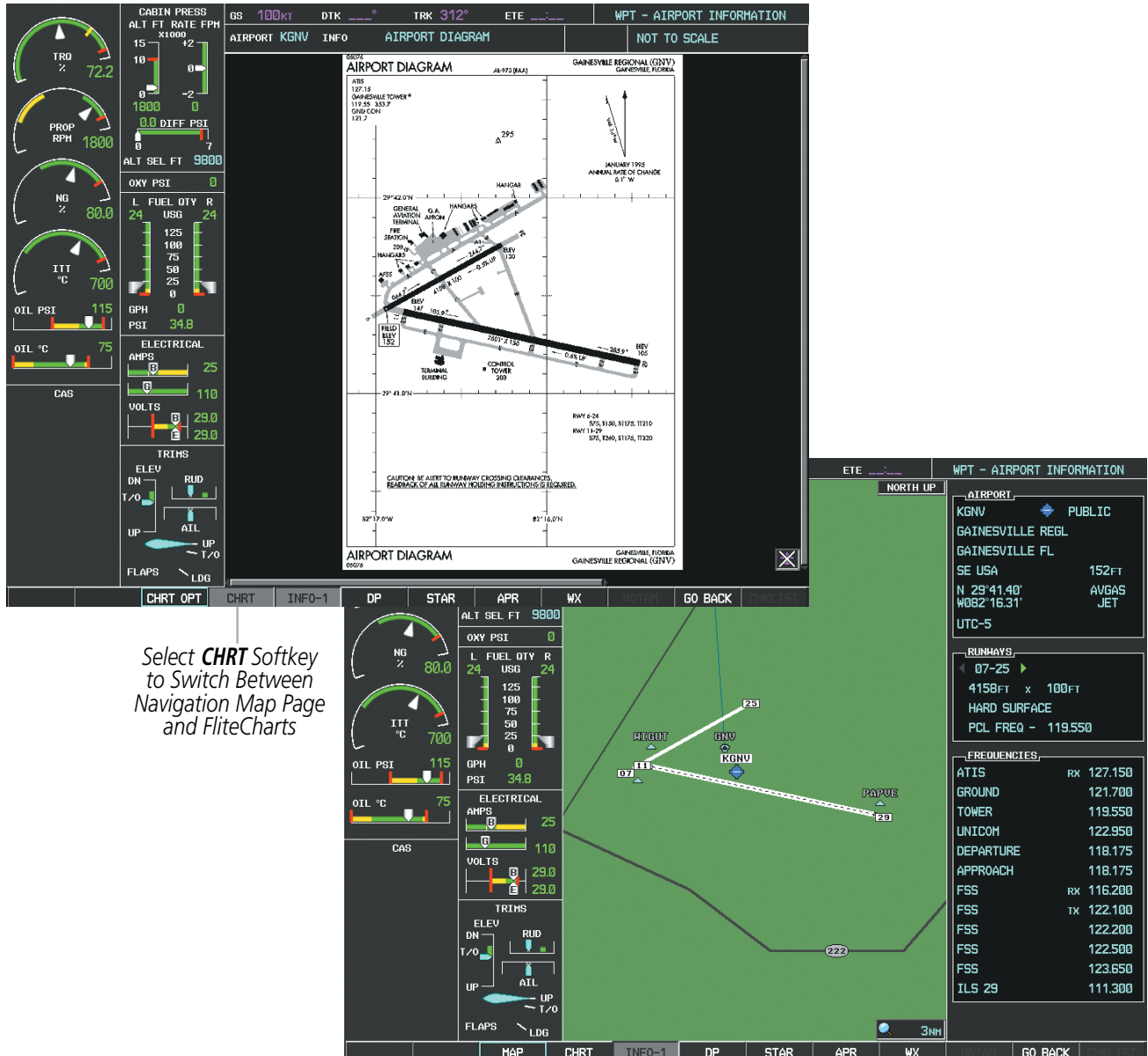

Figure 8-53 CHRT Softkey, Airport Information Page

Selecting the **INFO-1** or **INFO-2** Softkey returns to the airport diagram when the view is on a different chart. If the displayed chart is the airport diagram, the **INFO-1** or **INFO-2** Softkey has no effect.

Another source for additional airport information is from the INFO Box above the chart (Figure 8-53) or to the right of the chart (Figure 8-54) for certain airports. This information source is not related to the **INFO-1** or **INFO-2** Softkey. When the INFO Box is selected using the **FMS** Knob, the G1000 softkeys are blank. The DeKalb Peachtree Airport has three additional charts offering information; the Airport Diagram, Alternate Minimums, and Take-off Minimums.

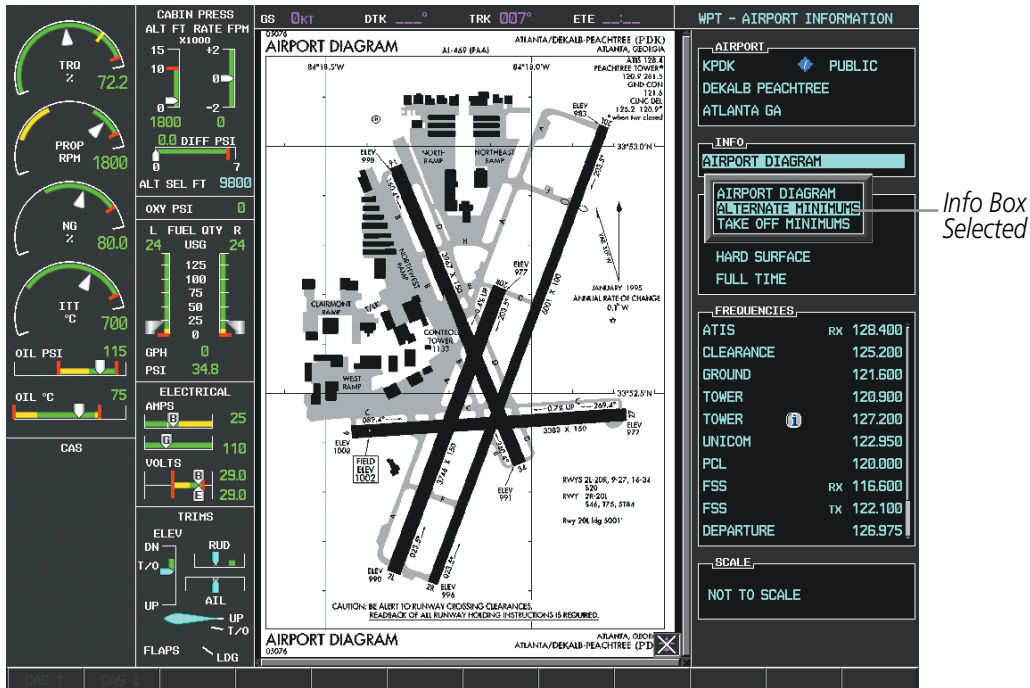

Figure 8-54 Airport Information Page, INFO View with Airport Information

In the example shown in Figure 8-54, ALTERNATE MINIMUMS is selected. Pressing the **ENT** Key displays the IFR Alternate Minimums Chart (Figure 8-55).

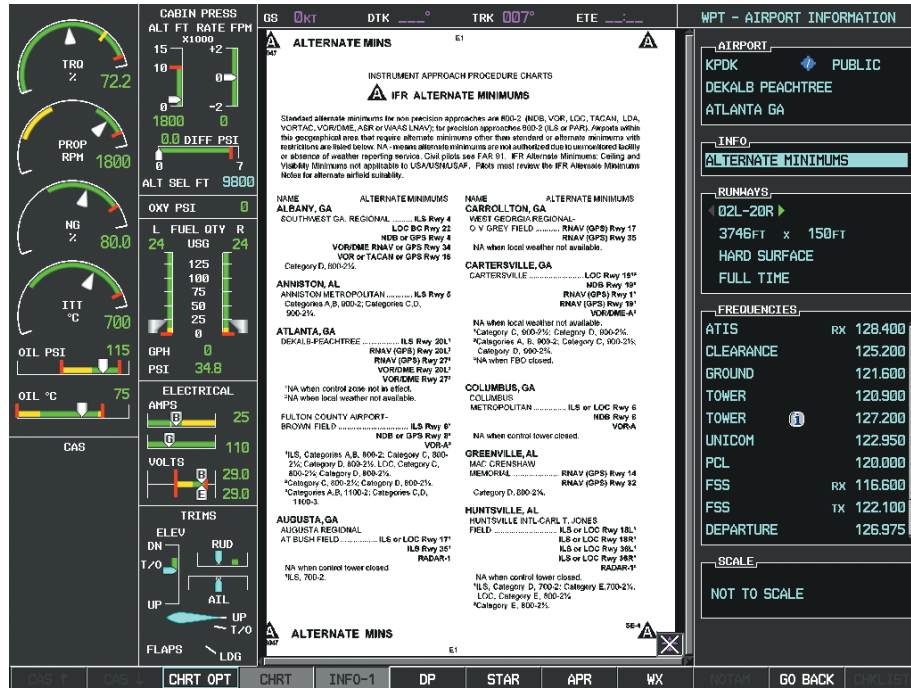

Figure 8-55 Airport Information Page, ALTERNATE MINIMUMS Selected from INFO View

Selecting the **DP** Softkey displays the Departure Procedure Chart if available.

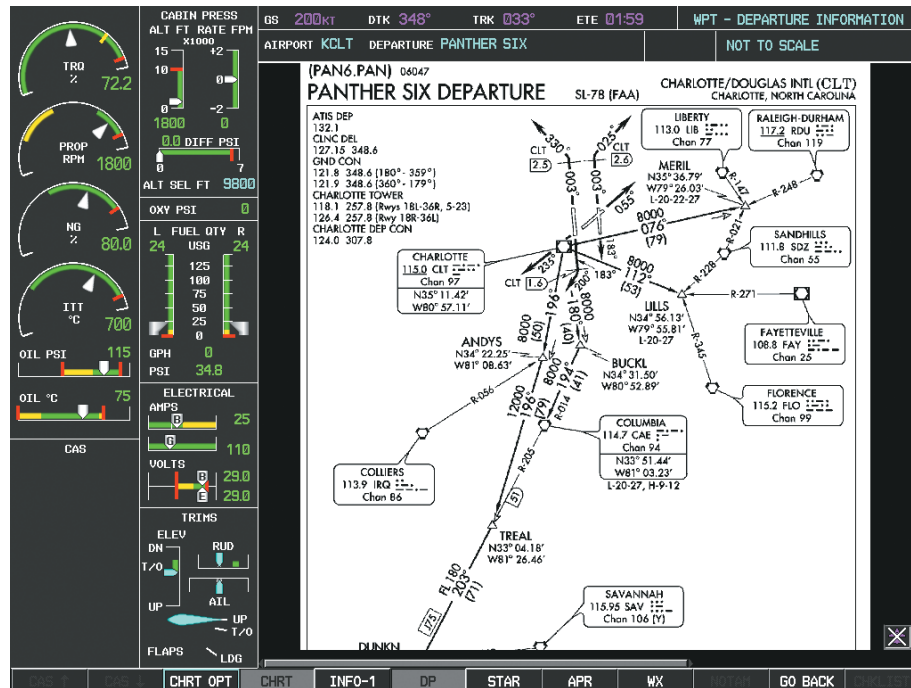

Figure 8-56 Departure Information Page

Selecting the **STAR** Softkey displays the Standard Terminal Arrival Chart if available.

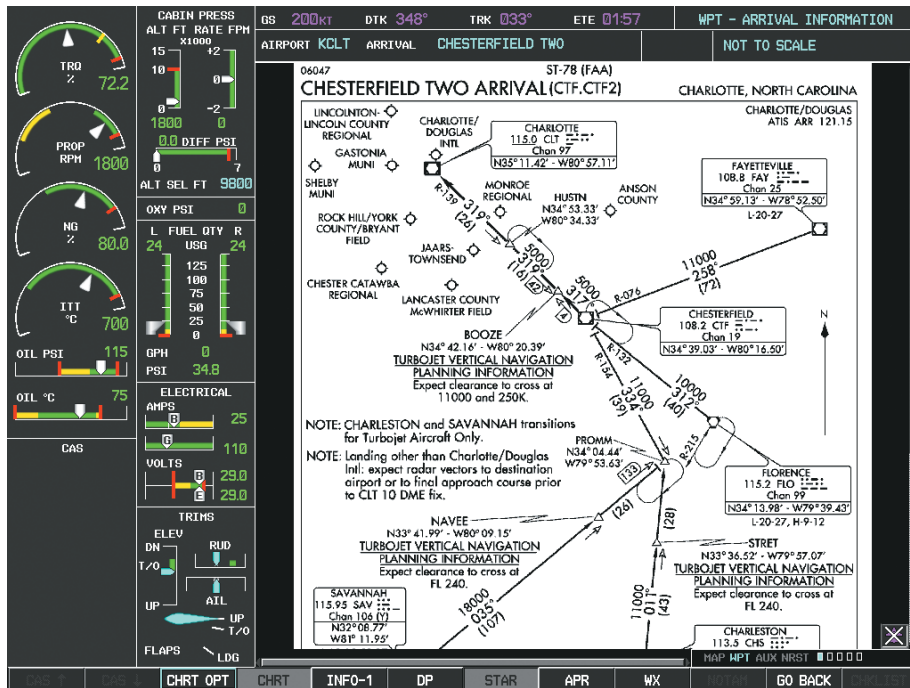

Figure 8-57 Arrival Information Page

Selecting the **APR** Softkey displays the approach chart for the airport if available.

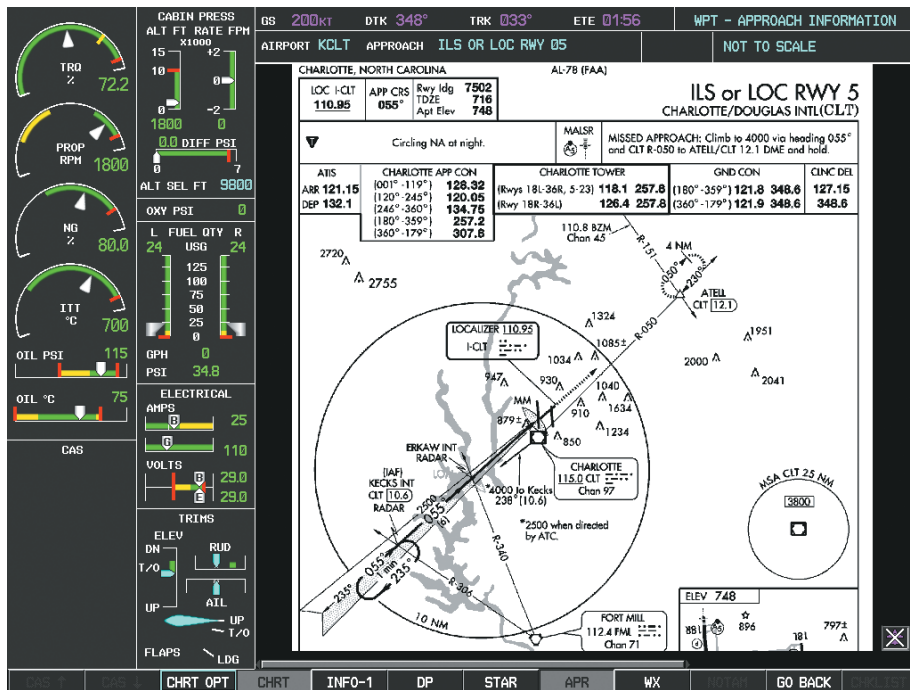

Figure 8-58 Approach Information Page

Selecting the **WX** Softkey shows the airport weather frequency information, when available, and includes weather data such as METAR and TAF from the SiriusXM Data Link Receiver. Weather information is available only when an SiriusXM Data Link Receiver is installed and the XM WX Satellite Weather subscription is current.

Selecting Additional Information:

- 1) While viewing the Airport Taxi Diagram, select the **WX** Softkey to display the information windows (AIRPORT, INFO).
- 2) Press the **FMS** Knob to activate the cursor.
- 3) Turn the large **FMS** Knob to highlight the INFO Box.
- 4) Turn the small **FMS** Knob to select the INFO Box choices. When the INFO Box is selected the G1000 softkeys are blank. If multiple choices are available, scroll to the desired choice with the large **FMS** Knob and press the **ENT** Key to complete the selection.
- 5) Press the **FMS** Knob again to deactivate the cursor.

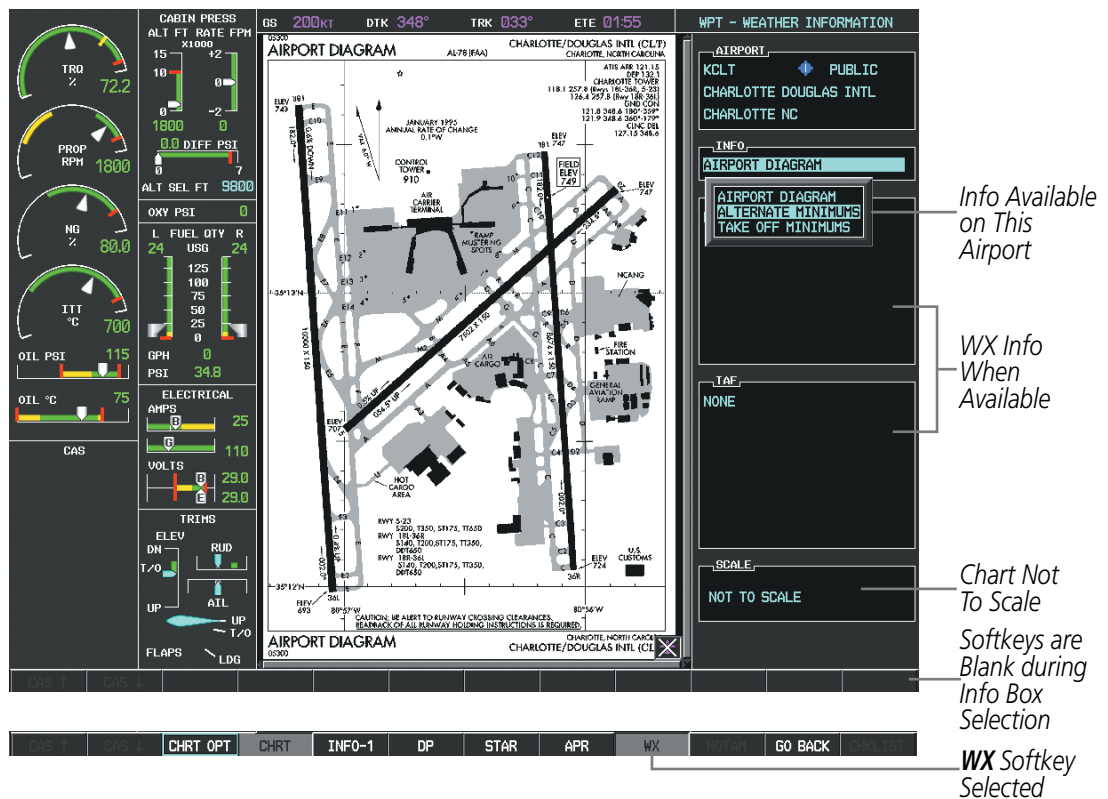

Figure 8-59 Weather Information Page, WX Softkey Selected

Selecting the **GO BACK** Softkey reverts to the previous page (Navigation Map Page or Flight Plan Page).

CHART OPTIONS

Selecting the **CHRT OPT** Softkey displays the next level of softkeys, the chart options level (Figure 8-48).

Selecting the **ALL** Softkey shows the entire chart on the screen.

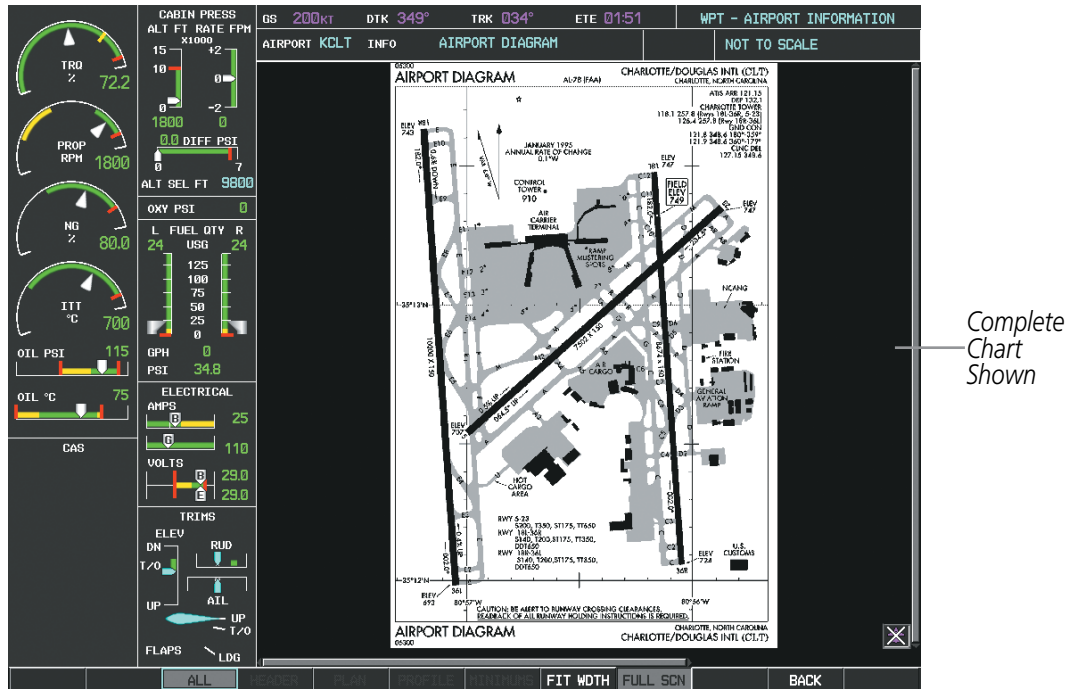
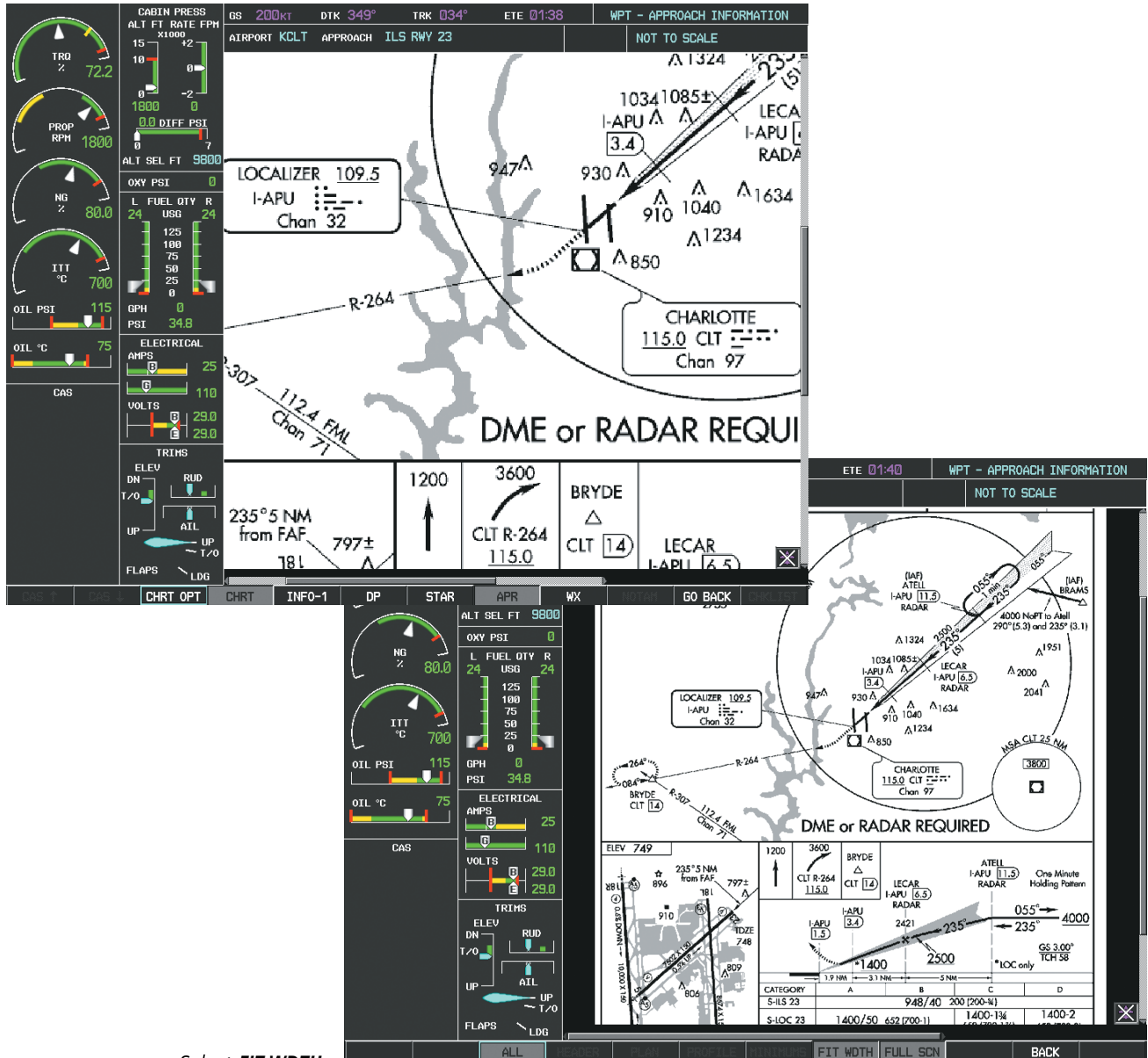

Figure 8-60 Airport Information Page, ALL View Selected

Selecting the **FIT WIDTH** Softkey fits the width of the chart in the display viewing area. In the example shown, the chart at close range is replaced with the full width chart.



Select **FIT WIDTH** Softkey to Show Full Chart Width

Figure 8-61 Approach Information Page, FIT WIDTH Softkey Selected

Selecting the **FULL SCN** Softkey alternates between removing and replacing the data window to the right.

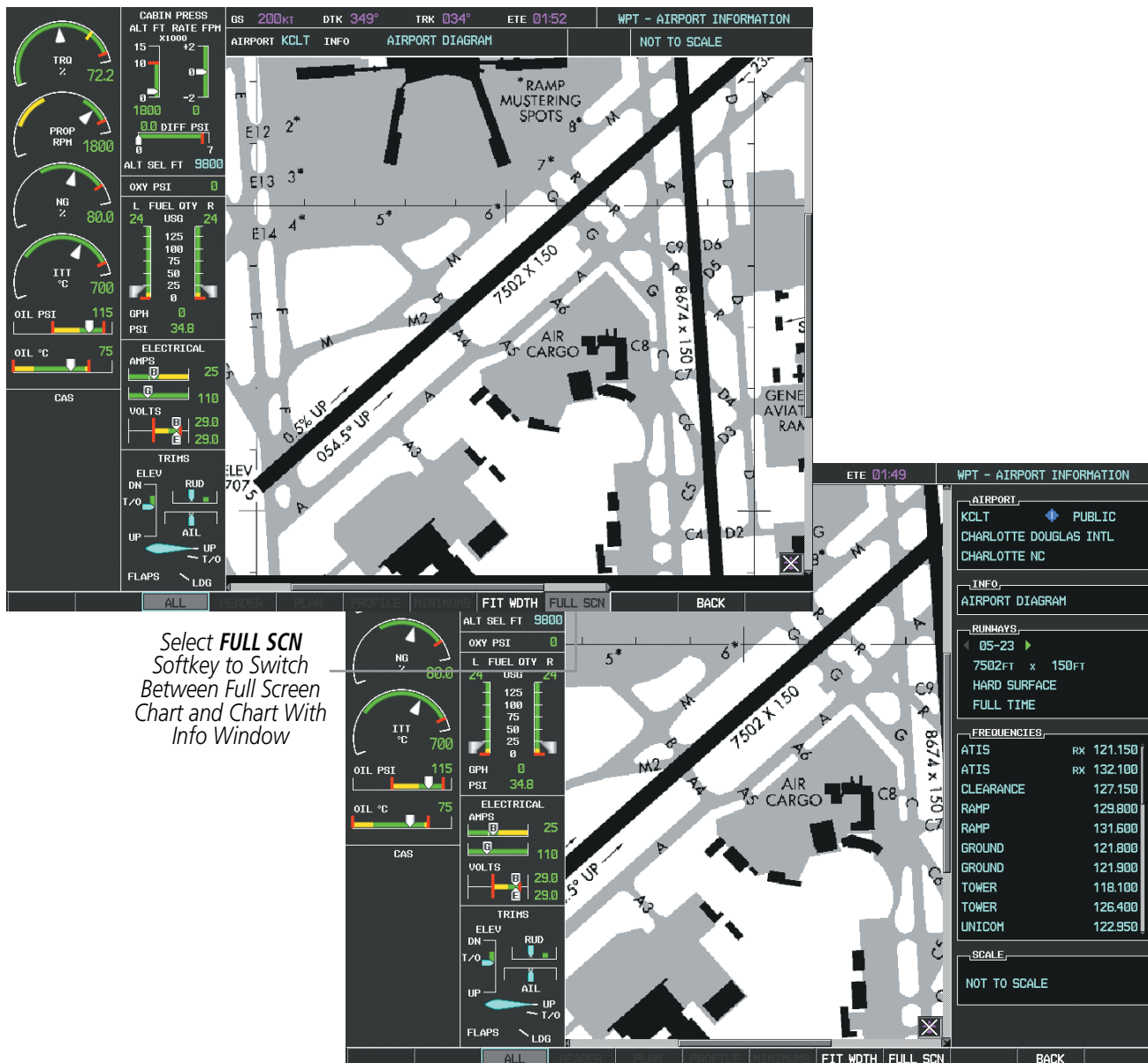

Figure 8-62 Airport Information Page, Full Screen and Info Window

Selecting the **BACK** Softkey, or waiting for 45 seconds reverts to the chart selection softkeys.

The full screen view can also be selected by using the page menu option.

Selecting full screen On or Off:

- 1) While viewing a terminal chart press the **MENU** Key to display the Page Menu **OPTIONS**.
- 2) Turn the large **FMS** Knob to highlight the Chart Setup Menu Option and press the **ENT** Key.
- 3) Turn the large **FMS** Knob to move between the **FULL SCREEN** and **COLOR SCHEME** Options.

- 4) Turn the small **FMS** Knob to choose between the On and Off Full Screen Options.

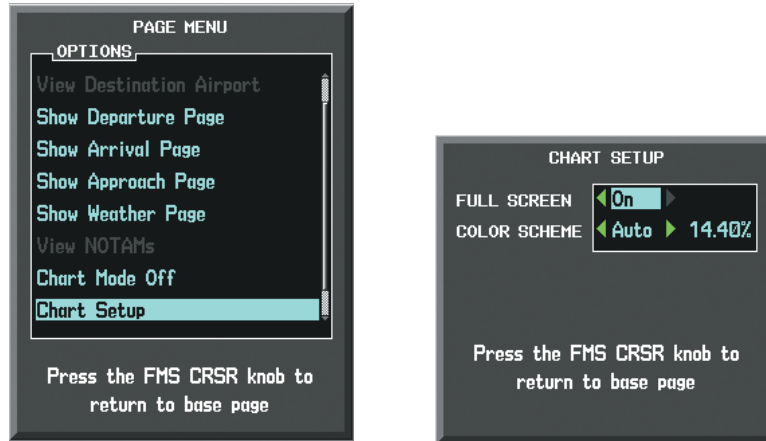

Chart Setup Option

Full Screen On/Off Selection

Figure 8-63 Page Menus

DAY/NIGHT VIEW

FliteCharts can be displayed on a white or black background for day or night viewing. The Day View offers a better presentation in a bright environment. The Night View gives a better presentation for viewing in a dark environment. When the CHART SETUP Box is selected the G1000 softkeys are blank.

Selecting Day, Night, or Automatic View:

- 1) While viewing a terminal chart press the **MENU** Key to display the Page Menu OPTIONS.
- 2) Turn the large **FMS** Knob to highlight the Chart Setup Menu Option and press the **ENT** Key.

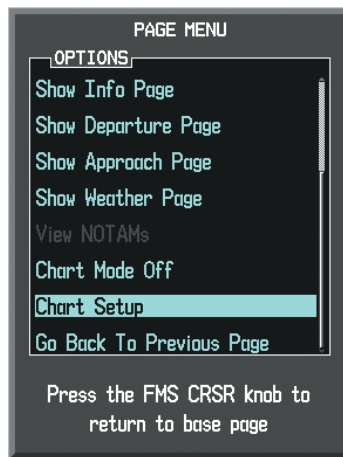

Figure 8-64 Waypoint Information Page, OPTIONS Menu

- 3) Turn the large **FMS** Knob to move to the COLOR SCHEME Option (Figure 8-65).
- 4) Turn the small **FMS** Knob to choose between Day, Auto, and Night Options.
- 5) If Auto Mode is selected, turn the large **FMS** Knob to select the percentage field. Use the small **FMS** Knob to change the percentage value. The percentage value is the day/night crossover point based on the percentage of

backlighting intensity. For example, if the value is set to 15%, the day/night display changes when the display backlight reaches 15% of full brightness.

The display must be changed in order for the new setting to become active. This may be accomplished by selecting another page or changing the display range.

- 6) Press the **FMS** Knob when finished to remove the Chart Setup Menu.

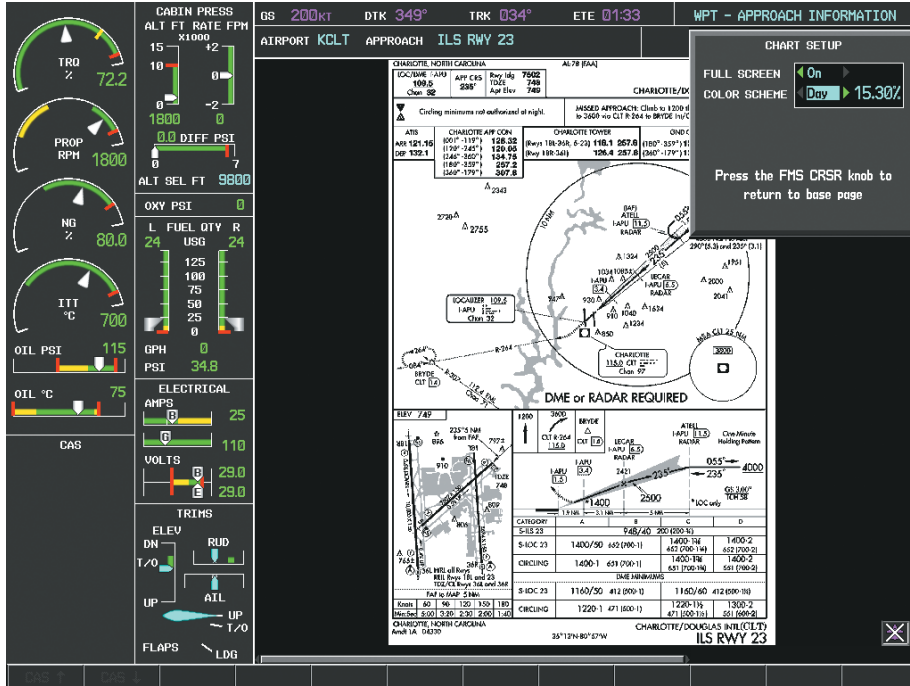

Figure 8-65 Approach Information Page, Day View

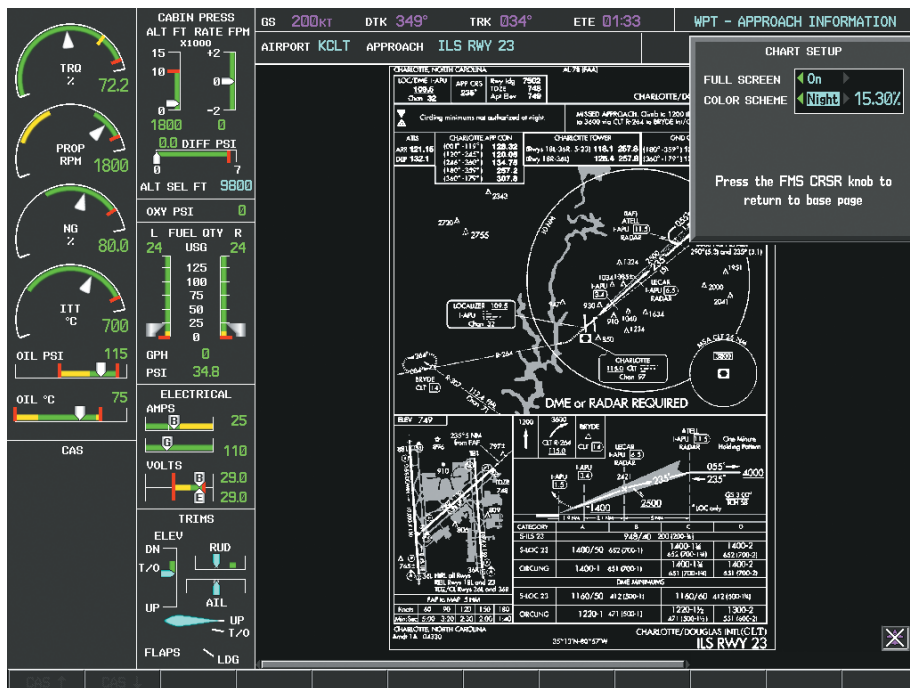

Figure 8-66 Approach Information Page, Night View

FLITECHARTS CYCLE NUMBER AND EXPIRATION DATE

FliteCharts data is revised every 28 days. Charts are still viewable during a period that extends from the cycle expiration date to the disables date. FliteCharts is disabled 180 days after the expiration date and are no longer available for viewing upon reaching the disables date. After the expiration date, the FliteCharts database is no longer current, however, data displayed on the actual charts may still be current. When viewing charts after the FliteCharts database has expired, ensure the displayed chart is current before using.

When turning on the system, the Power-up Page displays the current status of the FliteCharts database. See the table below for the various FliteCharts Power-up Page displays and the definition of each.

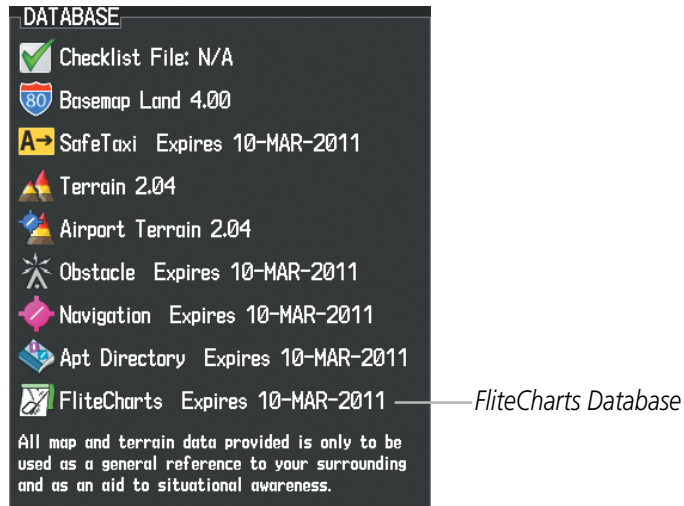

Figure 8-67 Power-up Page, FliteCharts Database

Power-up Page Display	Definition
	Blank Line. system is not configured for FliteCharts. Contact a Garmin-authorized service center for configuration.
Chart Data: N/A	System is configured for FliteCharts but no chart database is installed. Refer to Updating Garmin Databases in Appendix B for the FliteCharts database
FliteCharts Expires 10-MAR-2011	Normal operation. FliteCharts database is valid and within current cycle.
Chart data is out of date!	FliteCharts database is beyond the expiration date, but still within the 180 day viewing period.
Chart data is disabled.	FliteCharts database has timed out. Database is beyond 180 days after expiration date. FliteCharts database is no longer available for viewing.

Table 8-3 FliteCharts Power-up Page Annunciations and Definitions

Other possible AUX - System Status page conditions are shown in Figure 8-68. ‘FliteCharts Expires’ plus a date in white, indicates the chart database is current. ‘Chart data is out of date!’ in yellow, indicates charts are still viewable, but approaching the disable date.

When the 180 day grace period has expired, 'Chart data is disabled.' in yellow indicates that the FliteCharts database has expired and is no longer viewable. 'Chart Data: N/A' appears in white if no FliteCharts data is available on the database card or no database card is inserted.

FliteCharts time critical information can also be found on the AUX - System Status page. The FliteCharts database REGION, CYCLE number, EFFECTIVE, EXPIRES, and DISABLES dates of the subscription appear in either blue or yellow text. Dates shown in blue are current data. Dates shown in yellow indicate the data is not within the current subscription period.

FliteCharts becomes inoperative 180 days after the FliteCharts EXPIRES date is reached, and is no longer available for viewing. This date is shown as the DISABLES date. After the disable date the **SHW CHRT** Softkey label appears subdued and is unavailable until a revised issue of FliteCharts is installed.

NOTE: A subdued softkey label indicates the function is disabled.

Select the **MFD1 DB** Softkey to place the cursor in the DATABASE window. Scroll through the listed information by turning the **FMS** Knob or pressing the **ENT** Key until the FliteCharts database information is shown.

The FliteCharts database cycle number shown in the figure, 1105, is deciphered as follows:

11 – Indicates the year 2011

05 – Indicates the fifth issue of the FliteCharts database for the year

The FliteCharts EFFECTIVE date 07–MAY–11 is the first date that this database is current.

The FliteCharts EXPIRES date 04–JUN–11 is the last date that this database is current.

The DISABLES date 01–DEC–11 is the date that this database becomes inoperative.

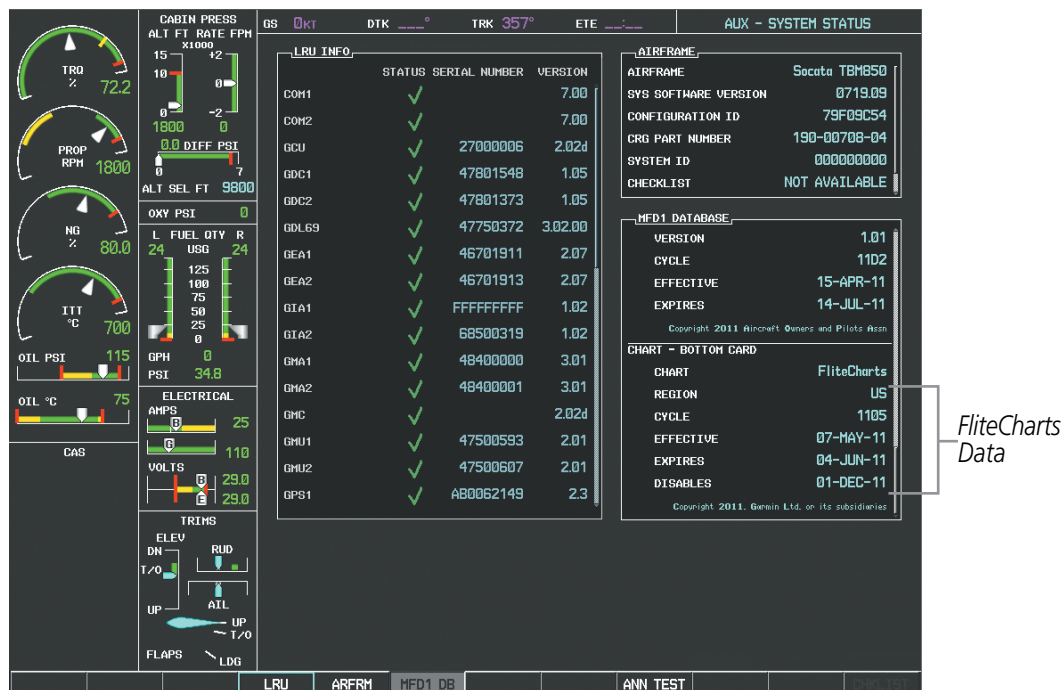

Figure 8-68 AUX – System Status Page, FliteCharts Current and Available

The FliteCharts database is provided from Garmin. Refer to Updating Garmin Databases in Appendix B for instructions on revising the FliteCharts database.

The other three possible AUX - System Status page conditions are shown here. The EXPIRES date, in yellow, is the revision date for the next database cycle. The DISABLES date, in yellow, is the date that this database cycle is no longer viewable. REGION and CYCLE NOT AVAILABLE in blue, indicate that FliteCharts database is not available on the database card or no database card is inserted.

MFD1 DATABASE	
VERSION	1.01
CYCLE	11D1
EFFECTIVE	13-JAN-11
EXPIRES	10-MAR-11
Copyright 2010 Aircraft Owners and Pilots Assn	
CHART - BOTTOM CARD	
CHART	FliteCharts
REGION	US
CYCLE	1102
EFFECTIVE	10-FEB-11
EXPIRES	10-MAR-11
DISABLES	06-SEP-11
Copyright 2011. Garmin Ltd. or its subsidiaries	

Current Date is Before Effective Date

MFD1 DATABASE	
VERSION	1.01
CYCLE	11D1
EFFECTIVE	13-JAN-11
EXPIRES	10-MAR-11
Copyright 2010 Aircraft Owners and Pilots Assn	
CHART - BOTTOM CARD	
CHART	FliteCharts
REGION	US
CYCLE	1102
EFFECTIVE	10-FEB-11
EXPIRES	10-MAR-11
DISABLES	06-SEP-11
Copyright 2011. Garmin Ltd. or its subsidiaries	

FliteCharts Expired, but is not Disabled

MFD1 DATABASE	
VERSION	1.01
CYCLE	11D1
EFFECTIVE	13-JAN-11
EXPIRES	10-MAR-11
Copyright 2010 Aircraft Owners and Pilots Assn	
CHART - BOTTOM CARD	
CHART	FliteCharts
REGION	US
CYCLE	1102
EFFECTIVE	10-FEB-11
EXPIRES	10-MAR-11
DISABLES	06-SEP-11
Copyright 2011. Garmin Ltd. or its subsidiaries	

FliteCharts Database is Disabled

MFD1 DATABASE	
VERSION	1.01
CYCLE	11D1
EFFECTIVE	13-JAN-11
EXPIRES	10-MAR-11
Copyright 2010 Aircraft Owners and Pilots Assn	
CHART - UNKNOWN	
CHART	FliteCharts
REGION	NOT AVAILABLE
CYCLE	NOT AVAILABLE
EFFECTIVE	-- -- -- --
EXPIRES	-- -- -- --
DISABLES	-- -- -- --

FliteCharts Database is Not Available

Figure 8-69 AUX – System Status Page, FliteCharts Database Status

8.5 AOPA AIRPORT DIRECTORY

The Aircraft Owners and Pilots Association (AOPA) Airport Directory database offers detailed information regarding services, hours of operation, lodging options, and more. This information is viewed on the Airport Information Page by selecting the INFO Softkey until **INFO-2** is displayed as shown in Figure 8-70.

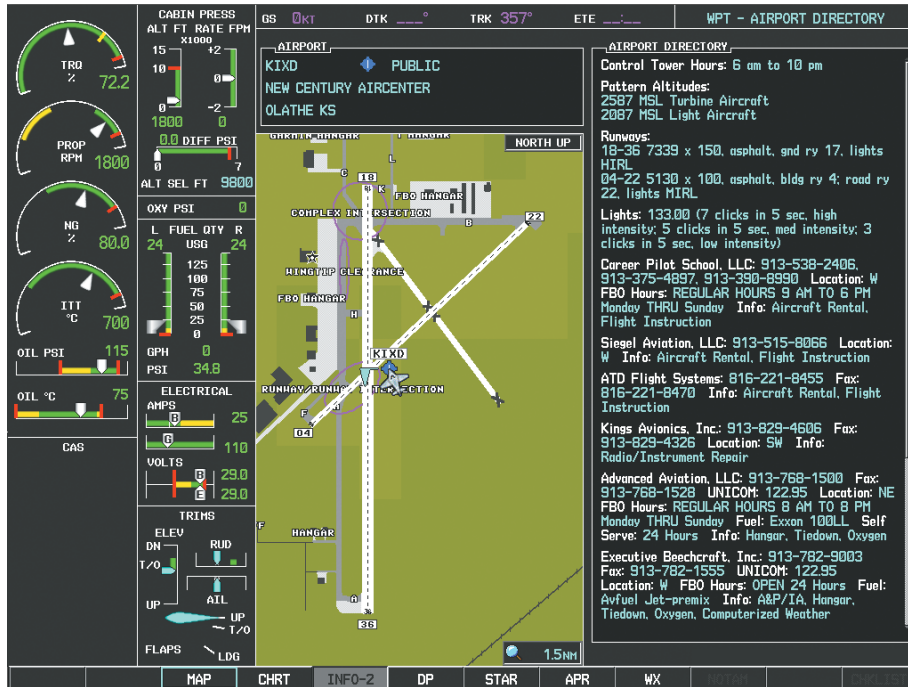

Figure 8-70 AOPA Information on the Airport Information Page

AOPA DATABASE CYCLE NUMBER AND REVISION

The AOPA Airport Directory database is revised four times per year. Check fly.garmin.com for the current database. The Airport Directory is always available for use after the expiration date. When turning on the system, the Power-up Page indicates whether the databases are current, out of date, or not available.

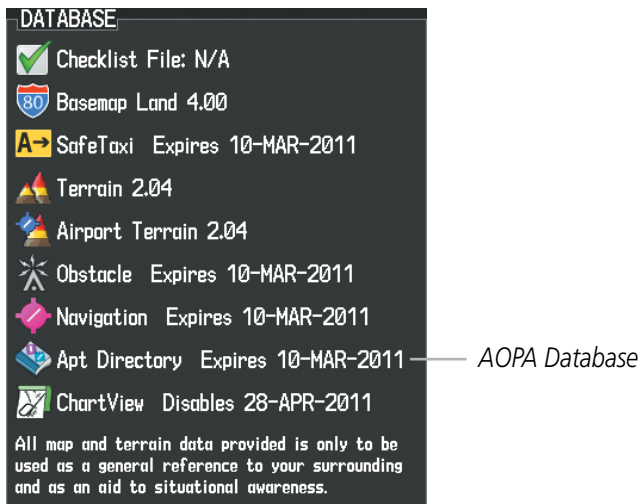

Figure 8-71 Power-up Page, Airport Directory Database

Power-up Page Display	Definition
Apt Directory Expires 10-MAR-2011	Normal operation. AOPA Airport Directory database is valid and within current cycle.
Apt Directory Expires 10-MAR-2011	AOPA Airport Directory database has expired.
Apt Directory N/A	Database card contains no AOPA Airport Directory data.

Table 8-4 Airport Directory Annunciation Definitions

The Airport Directory Region, Version, Cycle, Effective date and Expires date of the database cycle can also be found on the AUX - System Status page, as seen in Figure 8-72.

Select the **MFD1 DB** Softkey to place the cursor in the DATABASE window. Scroll through the listed information by turning the **FMS** Knob or pressing the **ENT** Key until the Airport Directory database information is shown.

The Airport Directory database cycle number shown in the figure, 11D2, is deciphered as follows:

11 – Indicates the year 2011

D – Indicates the data is for Airport Directory

2 – Indicates the second issue of the Airport Directory database for the year

The Airport Directory EFFECTIVE date 15-APR-11 is the beginning date for the current database cycle. The Airport Directory EXPIRES date 14-JUL-11 is the revision date for the next database cycle.



Figure 8-72 AUX – System Status Page, Airport Directory Current Information

Airport Directory information appears in blue and yellow text. The EFFECTIVE date appears in blue when data is current and in yellow when the current date is before the effective date. The EXPIRES date appears in blue when data is current and in yellow when expired (Table 8-4). NOT AVAILABLE appears in blue in the REGION field if Airport Directory data is not available on the database card. An expired Airport Directory database is not disabled and will continue to function indefinitely.

8.6 SIRIUSXM RADIO ENTERTAINMENT



NOTE: Refer to the Hazard Avoidance Section for information about XM WX Satellite Weather products.

The optional SiriusXM Radio entertainment feature of the GDL 69A Data Link Receiver is available for the pilot's and passengers' enjoyment. The GDL 69A can receive SiriusXM Satellite Radio entertainment services at any altitude throughout the Continental U.S. Entertainment audio is available only on the GDL 69A Data Link Receiver, not the GDL 69.

SiriusXM Satellite Radio offers a variety of radio programming over long distances without having to constantly search for new stations. Based on signals from satellites, coverage far exceeds land-based transmissions. SiriusXM Satellite Radio services are subscription-based. For more information on specific service packages, visit www.siriusxm.com.

ACTIVATING SIRIUSXM SATELLITE RADIO SERVICES

The service is activated by providing SiriusXM Satellite Radio with either one or two coded IDs, depending on the equipment. Either the Audio Radio ID or the Data Radio ID, or both, must be provided to SiriusXM Satellite Radio to activate the entertainment subscription.

It is not required to activate both the entertainment and weather service subscriptions with the GDL 69A. Either or both services can be activated. SiriusXM Satellite Radio uses one or both of the coded IDs to send an activation signal that, when received by the GDL 69A, allows it to play entertainment programming.

These IDs are located:

- On the label on the back of the Data Link Receiver
- On the XM Information Page on the MFD (Figure 8-73)
- On the XM Satellite Radio Activation Instructions included with the unit (available at www.garmin.com, P/N 190-00355-04)

Contact the installer if the Data Radio ID and the Audio Radio ID cannot be located.



NOTE: The **LOCK** Softkey on the XM Information Page (Auxiliary Page Group) is used to save GDL 69A activation data when the SiriusXM services are initially set up. It is not used during normal SiriusXM Radio operation, but there should be no adverse effects if inadvertently selected during flight. Refer to the GDL 69/69A XM Satellite Radio Activation Instructions (190-00355-04, Rev H or later) for further information.

Activating the SiriusXM Satellite Radio services:

- 1) Contact SiriusXM Satellite Radio. Follow the instructions provided by SiriusXM Satellite Radio services.
- 2) Select the Auxiliary Page Group.
- 3) Select the next to last page in the AUX Page Group.
- 4) Select the **INFO** Softkey to display the XM Information Page.
- 5) Verify that the desired services are activated.

- 6) Select the **LOCK** Softkey.
- 7) Turn the large **FMS** Knob to highlight YES.
- 8) To complete activation, press the **ENT** Key.



Figure 8-73 XM Information Page

If XM WX Satellite Weather Services have not been activated, all the weather product boxes are blank on the XM Information Page and a yellow Activation Required message is displayed in the center of the Weather Data Link Page (Map Page Group). The Service Class refers to the groupings of weather products available for subscription.

USING SIRIUSXM RADIO

The XM Radio Page provides information and control of the audio entertainment features of the SiriusXM Satellite Radio.

Selecting the XM Radio Page:

- 1) Turn the large **FMS** Knob to select the Auxiliary Page Group.
- 2) Turn the small **FMS** Knob to select the displayed AUX - XM Information Page.
- 3) Select the **RADIO** Softkey to show the XM Radio Page where audio entertainment is controlled.



Figure 8-74 XM Radio Page

ACTIVE CHANNEL AND CHANNEL LIST

The Active Channel Box on the XM Radio Page displays the currently selected channel that the SiriusXM Radio is using.

The Channels List Box of the XM Radio Page shows a list of the available channels for the selected category. Channels can be stepped through one at a time or may be selected directly by channel number.

Selecting a channel from the channel list:

- 1) While on the XM Radio Page, select the **CHNL** Softkey.
- 2) Select the **CH +** Softkey to go up through the list in the Channel Box, or move down the list with the **CH -** Softkey.

Or:

- 1) Press the **FMS** Knob to highlight the channel list and turn the large **FMS** Knob to scroll through the channels.
- 2) Press the **ENT** Key to activate the selected channel.

Selecting a channel directly:

- 1) While on the XM Radio Page, select the **CHNL** Softkey.
- 2) Select the **DIR CH** Softkey. The channel number in the Active Channel Box is highlighted.
- 3) Select the numbered softkeys located on the bottom of the display to directly select the desired channel number.
- 4) Press the **ENT** Key to activate the selected channel.

CATEGORY

The Category Box of the XM Radio Page displays the currently selected category of audio. Categories of channels such as jazz, rock, or news can be selected to list the available channels for a type of music or other contents. One of the optional categories is PRESETS to view channels that have been programmed.

Selecting a category:

- 1) Select the **CATGRY** Softkey on the XM Radio Page.
- 2) Select the **CAT +** and **CAT -** Softkeys to cycle through the categories.

Or:

Turn the small **FMS** Knob to display the Categories list. Highlight the desired category with the small **FMS** Knob and press the **ENT** Key. Selecting All Categories places all channels in the list.



Figure 8-75 Categories List

PRESETS

Up to 15 channels from any category can be assigned a preset number. The preset channels are selected by selecting the **PRESETS** and **MORE** Softkeys. Then the preset channel can be selected directly and added to the channel list for the Presets category.

Setting a preset channel number:

- 1) On the XM Radio Page, while listening to an Active Channel that is wanted for a preset, press the **PRESETS** Softkey to access the first five preset channels (**PS1 - PS5**).
- 2) Press the **MORE** Softkey to access the next five channels (**PS6 – PS10**), and again to access the last five channels (**PS11 – PS15**). Pressing the **MORE** Softkey repeatedly cycles through the preset channels.
- 3) Press the **SET** Softkey.
- 4) Press any one of the (**PS1 - PS15**) softkeys to assign a number to the active channel.

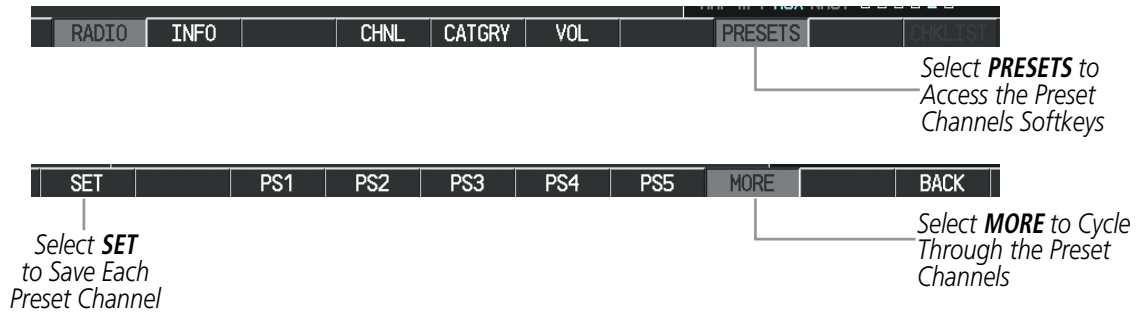

Figure 8-76 Accessing and Selecting XM Preset Channels

Selecting the **BACK** Softkey, or waiting during 45 seconds of softkey inactivity, returns the system to the top level softkeys.

VOLUME

Radio volume is shown as a percentage of full volume. Volume level is controlled by selecting the **VOL** Softkey, which brings up the **MUTE** Softkey and the volume increase and decrease softkeys.

Adjusting the volume:

- 1) With the XM Radio Page displayed, select the **VOL** Softkey.
- 2) Select the **VOL –** Softkey to reduce volume or select the **VOL +** Softkey to increase volume. (Once the **VOL** Softkey is selected, the volume can also be adjusted using the small **FMS** Knob.)
- 3) Select the **MUTE** Softkey to mute the audio. Select the **MUTE** Softkey again to unmute the audio.

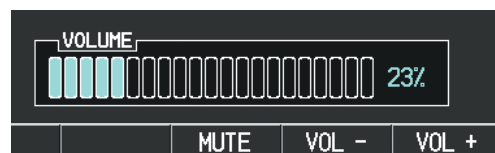

Figure 8-77 Volume Control

SiriusXM Radio volume may also be adjusted on each passenger headset.

8.7 SCHEDULER

The Scheduler feature can be used to enter and display reminder messages (e.g., Change oil, Switch fuel tanks, or Altimeter-Transponder Check) in the Alerts Window on the PFD. Messages can be set to display based on a specific date and time (event), once the message timer reaches zero (one-time; default setting), or recurrently whenever the message timer reaches zero (periodic). Message timers set to periodic alerting automatically reset to the original timer value once the message is displayed. When power is cycled, all messages are retained until deleted, and message timer countdown is resumed.



Figure 8-78 Scheduler (Utility Page)

Entering a scheduler message:

- 1) Select the AUX - Utility Page.
- 2) Press the **FMS** Knob momentarily to activate the flashing cursor.
- 3) Turn the large **FMS** Knob to highlight the first empty scheduler message naming field.
- 4) Use the **FMS** Knob to enter the message text to be displayed in the Messages Window and press the **ENT** Key.
- 5) Press the **ENT** Key again or use the large **FMS** Knob to move the cursor to the field next to Type.
- 6) Turn the small **FMS** Knob to select the message type:
 - Event—Message issued at the specified date/time
 - One-time—Message issued when the message timer reaches zero (default setting)
 - Periodic—Message issued each time the message timer reaches zero
- 7) Press the **ENT** Key again or use the large **FMS** Knob to move the cursor to the next field.
- 8) For periodic and one-time messages, use the **FMS** Knob to enter the timer value (HH:MM:SS) from which to countdown and press the **ENT** Key.

- 9) For event-based messages:
 - a) Use the **FMS** Knob to enter the desired date (DD-MM-YY) and press the **ENT** Key.
 - b) Press the **ENT** Key again or use the large **FMS** Knob to move the cursor to the next field.
 - c) Use the **FMS** Knob to enter the desired time (HH:MM) and press the **ENT** Key.
- 10) Press the **ENT** Key again or use the large **FMS** Knob to move the cursor to enter the next message.

Deleting a scheduler message:

- 1) Select the AUX - Utility Page.
- 2) Press the **FMS** Knob momentarily to activate the flashing cursor.
- 3) Turn the large **FMS** Knob to highlight the name field of the scheduler message to be deleted.
- 4) Press the **CLR** Key to clear the message text. If the **CLR** Key is pressed again, the message is restored.
- 5) Press the **ENT** Key while the message line is cleared to clear the message time.

Scheduler messages appear in the Messages Window on the PFD. When a scheduler message is waiting, the **MSG** Softkey label flashes. Selecting the **MSG** Softkey opens the Messages Window and acknowledges the scheduler message. Pressing the **MSG** Softkey again removes the Messages Window from the display, and the scheduler message is deleted from the message queue.



Figure 8-79 PFD Messages Window

8.8 ELECTRONIC CHECKLISTS

NOTE: The optional checklists presented in this section are for example only and may differ from checklists available for the TBM 850. The information described in this section is not intended to replace the checklist information described in the AFM or the Pilot Safety and Warning Supplements document.

NOTE: Garmin is not responsible for the content of checklists. TBM 850 checklists are created, modified, and updated by the aircraft manufacturer.

NOTE: Checklists cannot be edited from within the system.

The optional Checklist functions are displayed on two levels of softkeys that are available from any MFD page.

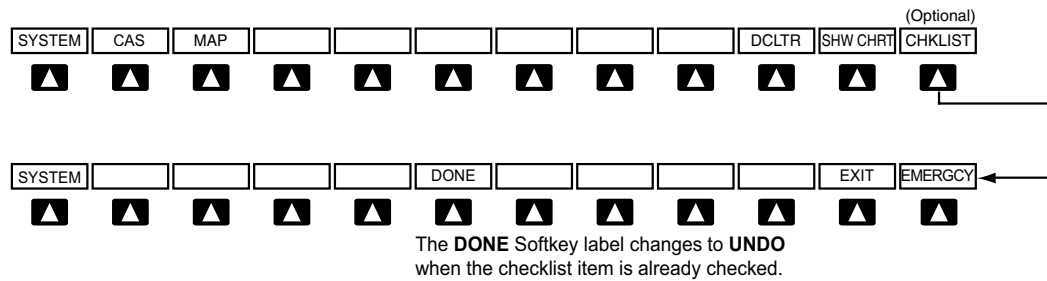

Figure 8-80 Checklist Softkeys

The MFD is able to display optional electronic checklists which allow a pilot to quickly find the proper procedure on the ground and during each phase of flight. The G1000 accesses the checklists from an SD card inserted into the bezel slot. For information regarding SD card placement, refer to the System Overview Section.

When turning on the G1000, the Power-up Page indicates whether the SD card contains a valid checklist file an invalid file, or whether no checklist is available, as shown in the figure. A valid checklist file is noted as Checklist File: TBM 850 with the version number. When the Power-up Page displays Invalid or N/A the **CHKLIST** Softkey is subdued and not available.

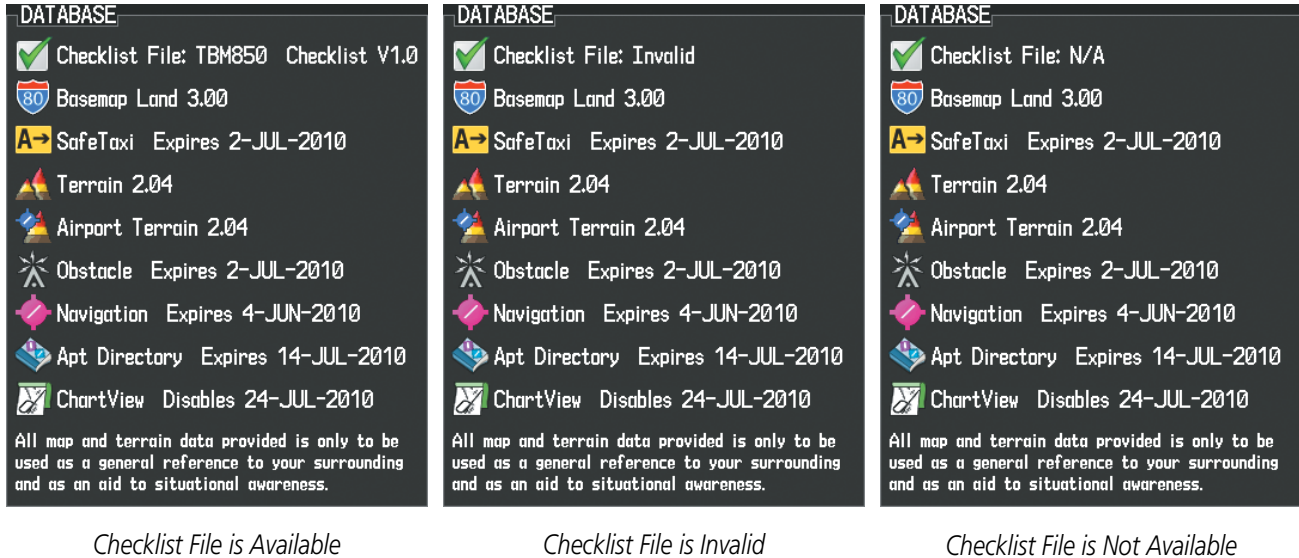

Figure 8-81 Power-up Page, Checklist File Availability

The AUX - System Status page also shows checklist validity and availability. The valid CHECKLIST data gives the aircraft type and version number. If the database is not valid the CHECKLIST line shows INVALID. If the database is not installed the CHECKLIST line shows NOT AVAILABLE indicating that the database is not available on the database card or no database card is inserted.

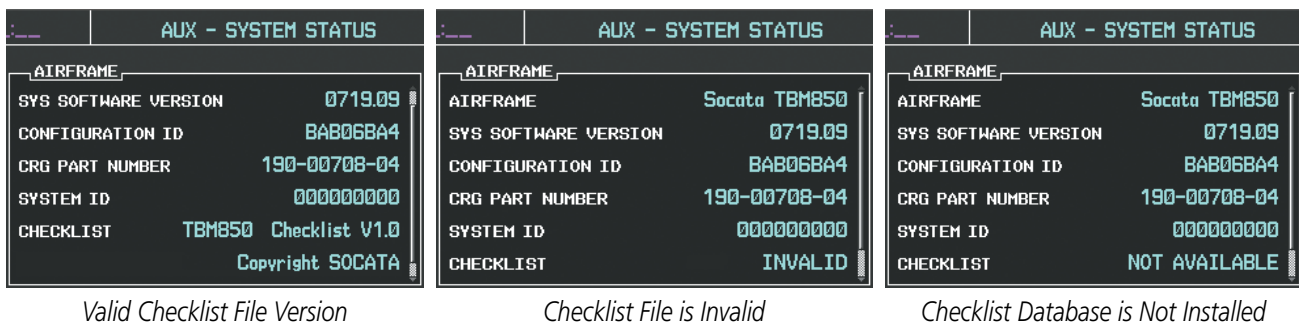

Figure 8-82 AUX – System Status Page, Checklist Version and Availability

Accessing and navigating checklists:

- 1) From any page, select the **CHKLIST** Softkey.
- 2) Turn the large **FMS** Knob to select the GROUP field.
- 3) Turn the small **FMS** Knob to select the desired procedure and press the **ENT** Key.
- 4) Turn the large **FMS** Knob to select the Checklist field.
- 5) Turn the **FMS** Knob to select the desired checklist and press the **ENT** Key.

- 6) Turn the **FMS** Knob to scroll through the checklist and highlight the desired checklist item (has a hollow white box for checkmark).
- 7) Press the **ENT** Key or **DONE** Softkey to select the highlighted checklist item (item turns green and a checkmark is placed in the box next to the item). The next item is automatically highlighted for selection.
Press the **CLR** Key to remove a check mark from an item.
- 8) Once the last item in a checklist is selected, Go to the next checklist? is highlighted. Press the **ENT** Key to advance to the next checklist displayed.
- 9) Select the **EXIT** Softkey or hold down the **CLR** Key momentarily to exit the Checklist Page and return to the page last viewed.



Figure 8-83 Checklist Page Example

Immediately accessing emergency procedures:

- 1) From any page, select the **CHKLIST** Softkey.
- 2) Select the **EMERGENCY** Softkey.

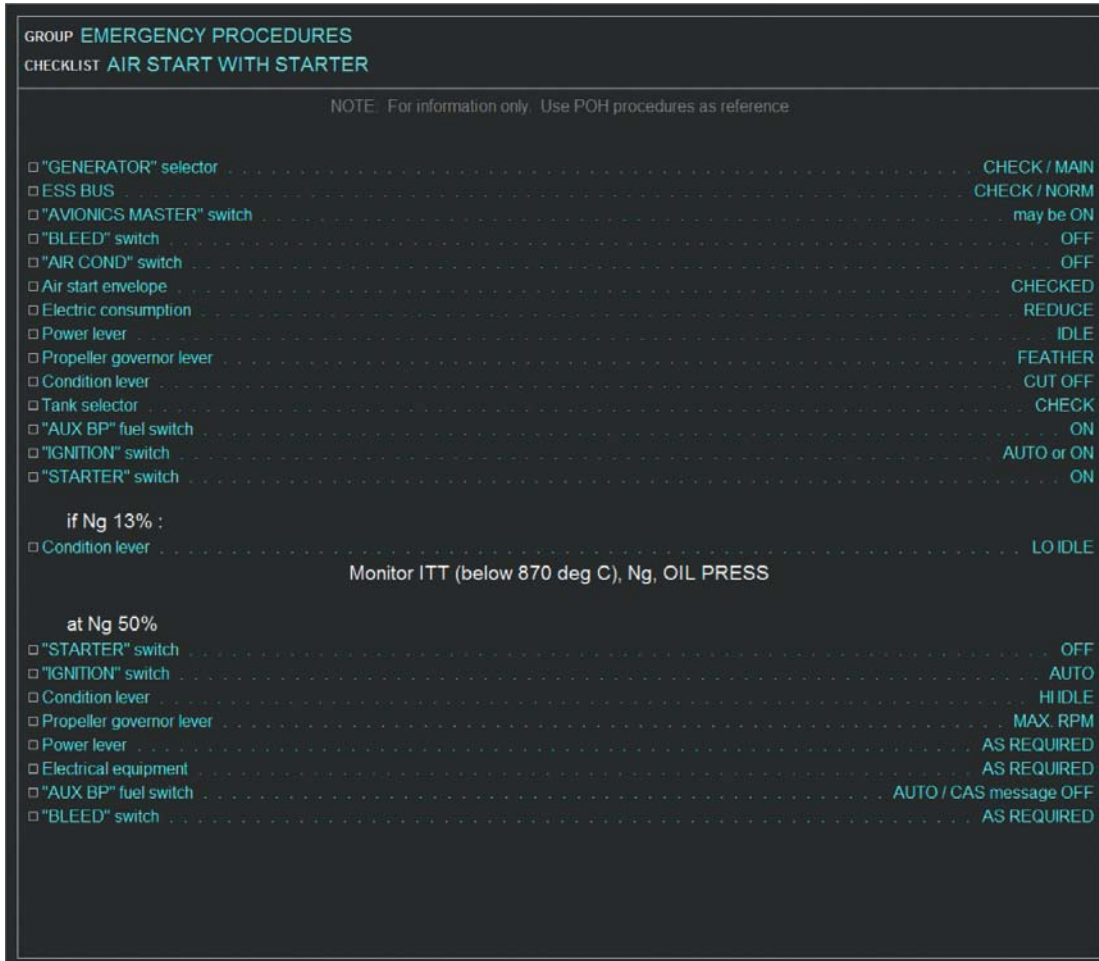

Figure 8-84 Sample Emergency Checklist

8.9 FLIGHT DATA LOGGING

The flight data logging feature automatically stores flight and engine data to an SD card (4 GB maximum card size) inserted into the top card slot of the MFD. Data is recorded to the SD card every second. One hour of flight data requires approximately 2 MB of storage space. A 2 GB SD card will store over 1,000 hours of flight data.

It is best to use an SD card that contains no other files. If necessary, reformat the SD card before use as a flight data logging card. The data files stored on the SD card have an extension of .csv. This file format can be opened using a spread sheet application on a personal computer.

The following is a list of the types of data recorded. Not all data types are applicable to all aircraft. For example, EGT and CHT would not apply to turbine aircraft.

- Local Date (YYYY-MM-DD)
- Local Time (HH:MM:SS)
- Active Waypoint Distance (nm)
- Active Waypoint Bearing (degrees mag.)
- UTC Offset (HH:MM)
- Mag. Variation (degrees)
- Active Waypoint Identifier
- Voltage 1 (volts)
- Voltage 2 (volts)
- Amps 1 (amps)
- Amps 2 (amps)
- AFCS On (0 – false, 1 – true)
- Latitude (degrees)
- AFCS Roll Mode (e.g. HDG, LOC, GPS, VOR, ROL)
- Longitude (degrees)
- Right Fuel Qty (gals or lbs)
- Left Fuel Qty (gals or lbs)
- Center Fuel Qty (gals or lbs)
- AFCS Pitch Mode (e.g. ALT, GS, GP, VS)
- Barometric Altitude (feet)
- Altimeter Setting (in. Hg.)
- GPS Altitude (ft)
- Pitch Commanded (degrees)
- Roll Commanded (degrees)
- OAT (deg. C)
- True Airspeed (kts)
- Selected Vertical Speed (fpm)
- Vertical Speed (fpm)
- HSI Selection (GPS,NAV1/2)
- GPS Fix (e.g. 2D, 3D, 3DDiff)
- Indicated Airspeed (kts)
- Horizontal Alert Limit (HAL, meters)
- Gnd Speed (kts)
- Vertical Alert Limit (VAL, meters)
- Vertical Speed (fpm)
- NAV1 Frequency (MHz)
- NAV2 Frequency (MHz)
- Horizontal Protection Level (HPLWAS, meters)
- Pitch (degrees)
- Roll (degrees)
- Horizontal Protection Level (HPLFD, meters)
- Vertical Protection Level (VPLWAS, meters)
- COM1 Frequency (MHz)
- COM2 Frequency (MHz)
- Lateral Acceleration (g)
- CDI Deflection (0.0 to 1.0)

- VDI Deflection (0.0 to 1.0)
- Normal Acceleration (g)
- Heading (degrees magnetic)
- Course (deg)
- Wind Direction (degrees mag.)
- Wind Speed (kts)
- Gnd Trk (degrees magnetic)
- Fuel Flow (gph)
- Fuel Press. (psi)
- EGT (deg. F)
- CHT (deg. F)
- Oil Temperature (deg. F)
- Oil Pressure (psi)
- Manifold Pressure (in. Hg.)
- Engine Speed (rpm)
- Power (%)
- Carburetor Temperature (deg. F)
- TIT (deg. F)
- Torque (ft. lbs.)
- Np (rpm)
- Ng (%)
- ITT (deg. C)
- N1 (%)

The file containing the recorded data will appear in the format shown in Figure 8-82. This file can be imported into most computer spreadsheet applications.

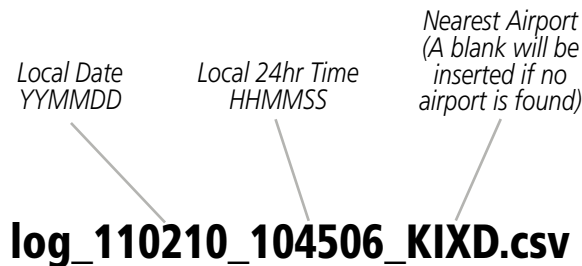

Figure 8-85 Log File Format

Data logging status can be monitored on the AUX-UTILITY Page.

8.10 SATELLITE TELEPHONE & SMS MESSAGING SERVICE

The optional GSR 56 Iridium Transceiver provides airborne Iridium Satellite Telephone and SMS messaging service. The telephone audio is through the audio panel and headset. Operation is accomplished through the AUX-AUXILIARY COMMUNICATIONS Pages.

REGISTERING THE IRIDIUM SATELLITE SYSTEM

A subscriber account must be established prior to using the Iridium Satellite System. Before setting up an Iridium account, obtain the serial number of the Iridium Transceiver (GSR1) and the System ID by selecting the AUX- SYSTEM STATUS Page as shown in Figure 8-86. Contact Garmin Flight Data Services at 1-866-739-5687 in the United States or 913-397-8200, ext. 1135.

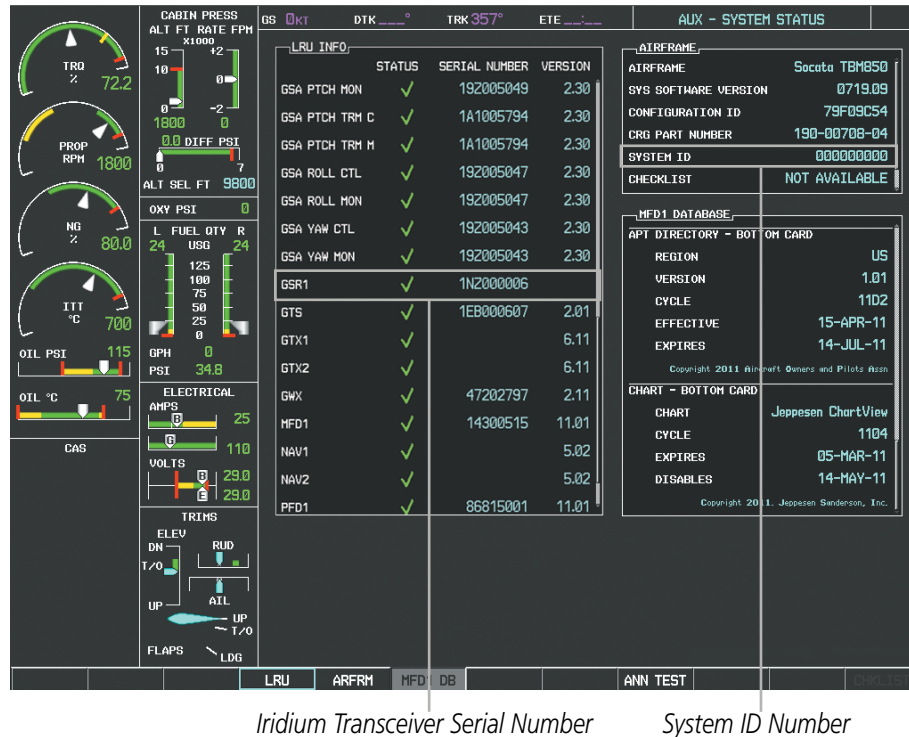

Figure 8-86 Identification Needed for Iridium Registration

TELEPHONE COMMUNICATION

The pilot or copilot can place and answer calls on the Iridium satellite network. Control and monitoring of telephone functions are accomplished through the AUX-TELEPHONE Page.

To view the Telephone Page:

- 1) Turn the large **FMS** Knob on the MFD to select the AUX page group.
- 2) Turn the small **FMS** Knob to select the AUX-TELEPHONE Page.

The PHONE STATUS display, as shown in Figure 8-87, gives a graphical representation of the current disposition of the connection with the Iridium network. Table 8-5 describes symbology used on PHONE STATUS display.

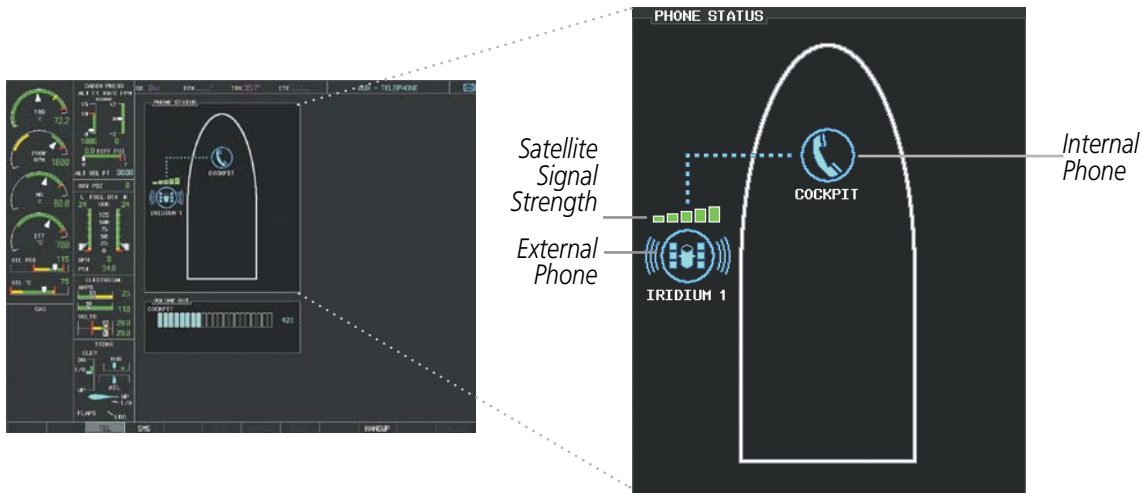

Figure 8-87 Phone Status Display

ENABLE/DISABLE THE IRIDIUM TELEPHONE SYSTEM

The Iridium Satellite Telephone System may be turned on or off by using the page menu.

To enable the Iridium telephone system:

- 1) With the AUX-TELEPHONE Page displayed, select the **MENU** Key on the MFD to display the Page Menu.
- 2) Turn either **FMS** Knob to place the cursor on 'Enable Iridium Transmission'.
- 3) Press the **ENT** Key.

To disable the Iridium telephone system:

- 1) With the AUX-TELEPHONE Page displayed, select the **MENU** Key on the MFD to display the Page Menu.
- 2) Turn either **FMS** Knob to place the cursor on 'Disable Iridium Transmission'.
- 3) Press the **ENT** Key.

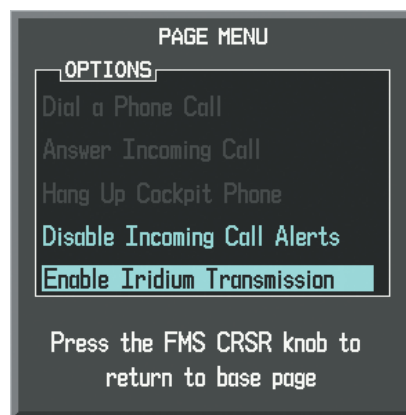

Figure 8-88 Enable Iridium Telephone System



















Internal Phone	External Phone	Description
		Phone is Idle
		Phone is ringing
		Phone has a dial tone (off hook) or connected to another phone
		Phone dialed is busy
		Phone is dialing another phone
		Phone has failed
		Phone status not known
		Phone is disabled
		Phone is reserved for data transmission
		Calling other phone or incoming call from other phone
		Other phone is on hold
		Phones are connected

Table 8-5 Telephone Symbols

INCOMING CALLS

NOTE: Outside callers should dial 00 + 8816 or 8817 + aircraft phone number when calling the aircraft Iridium Telephone System.

When a phone call is received while viewing MFD pages other than the AUX-TELEPHONE Page, a pop-up alert similar to Figure 8-89 is displayed, accompanied by a ringtone heard on the selected cockpit audio. The pop-up alert may be inhibited at times, such as during takeoff. In addition to the pop-up alert, a ringing phone symbol is displayed to the right of the MFD page title as shown in Figure 8-89.



Figure 8-89 Incoming Call

Answering an incoming call:

- 1) Press the **TEL** Key on the audio panel.
- 2) Select the **ANSWER** Softkey on the MFD.

Or:

While viewing the AUX-TELEPHONE Page:

NOTE: The Push-to-Talk switch is not utilized for telephone communication. The microphone is active after selecting the **ANSWER** Softkey, and stays active until the call is terminated.

- 1) Press the **TEL** Key on the audio panel.
- 2) Press the **MENU** Key to display the Page Menu.
- 3) Turn either **FMS** Knob to place the cursor on 'Answer Incoming Call'.
- 4) Press the **ENT** Key.

Selecting the **IGNORE** Softkey will extinguish the pop-up window and leave the current call unanswered. Selecting the **IGNRE ALL** Softkey will extinguish the pop-up window for the current and all future incoming calls and leave the current call unanswered. Selecting the **TEL** Softkey will display the AUX-TELEPHONE Page allowing additional call information to be viewed before answering.

Disabling incoming call alerts:

- 1) With the AUX-TELEPHONE Page displayed, press the **MENU** Key on the MFD to display the Page Menu.
- 2) Turn either **FMS** Knob to place the cursor on 'Disable Incoming Call Alerts'.
- 3) Press the **ENT** Key. The voice and pop-up alert will not be displayed now when an incoming call is received.

OUTGOING CALLS

Voice calls can be made from the cockpit to an external phone through the Iridium Satellite Network.



NOTE: The Push-to-Talk switch is not utilized for telephone communication. The microphone is active after selecting the **ANSWER** Softkey, and stays active until the call is terminated.

To make a call:

- 1) Press the **TEL** Key on the audio panel.
- 2) Select the **DIAL** Softkey on the MFD. A display similar to Figure 8-90 will be shown.

Or:

While viewing the AUX-TELEPHONE Page:

- a) Press the **TEL** Key on the audio panel.
- b) Press the **MENU** Key to display the Page Menu.
- c) Turn either **FMS** Knob to place the cursor on 'Dial a Phone Call'.
- d) Press the **ENT** Key.

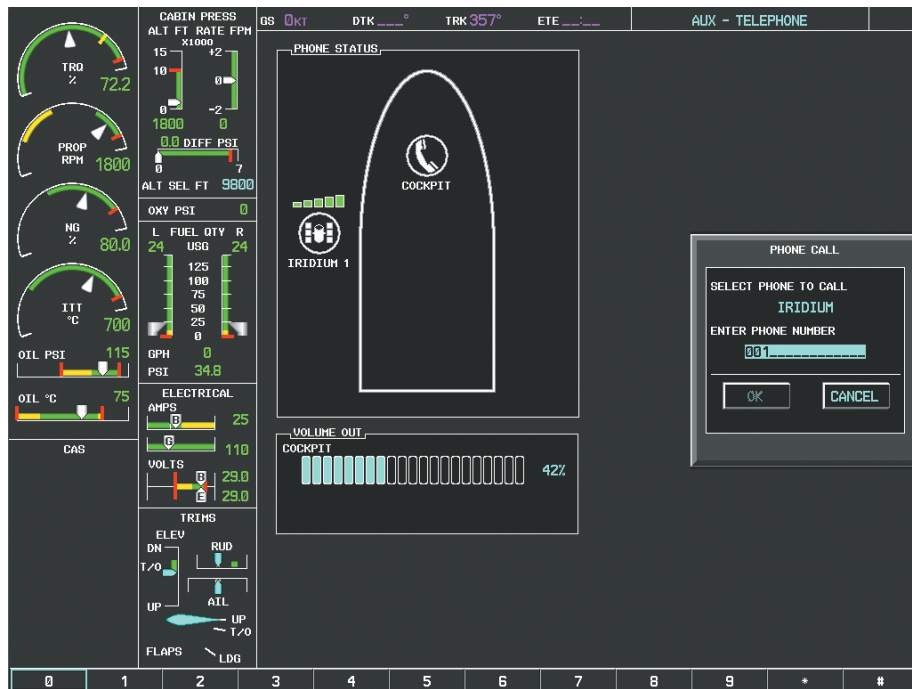

Figure 8-90 Enter Phone Number

- 3) Selecting the number softkeys on the MFD, enter 00 + country code + area code + phone number when calling a non-satellite telephone system. Enter 00 + Satellite Country Code (shown in the following table) + phone number when placing a call to another satellite telephone system.

Satellite System	Country Code
Inmarsat	870
ICO	8810 or 8811
Ellipso	8812 or 8813
Iridium	8816 or 8817
Globalstar	8818 or 8819

- 4) Press the **ENT** Key. 'OK' is highlighted as in Figure 8-91.

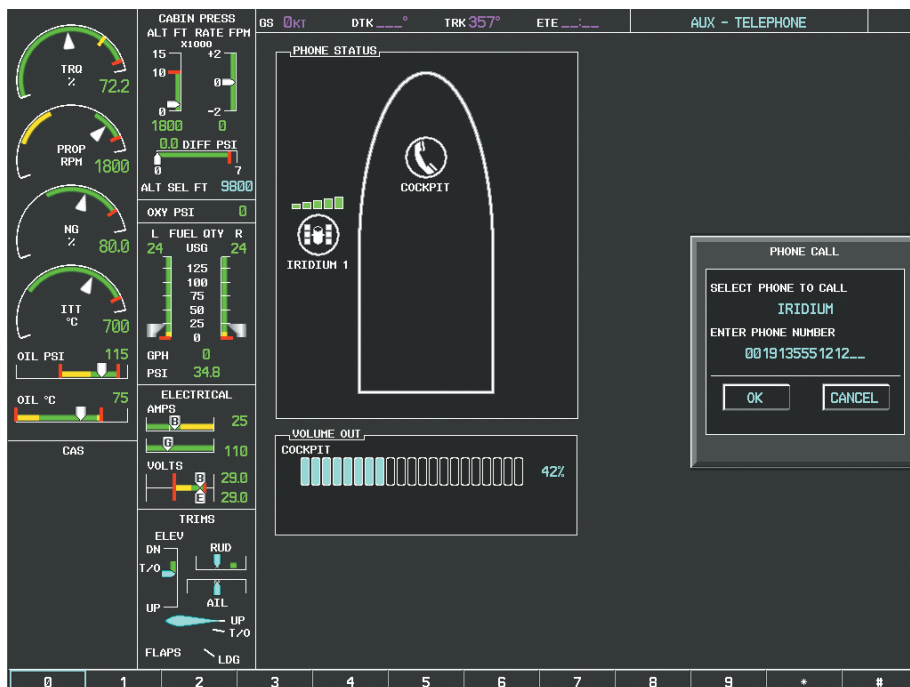

Figure 8-91 Make the Call

- 5) Press the **ENT** Key. The system will begin calling the number, as in Figure 8-92.

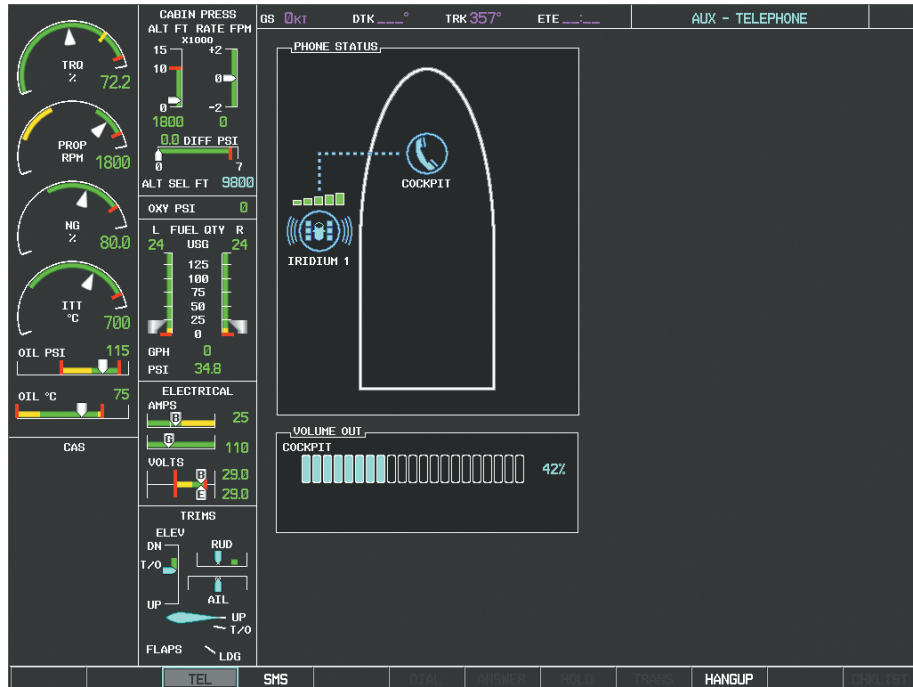

Figure 8-92 System is Making the Connection

When the phone is answered, the connection is established as shown in Figure 8-93. To exit the call, select the **HANGUP** Softkey.

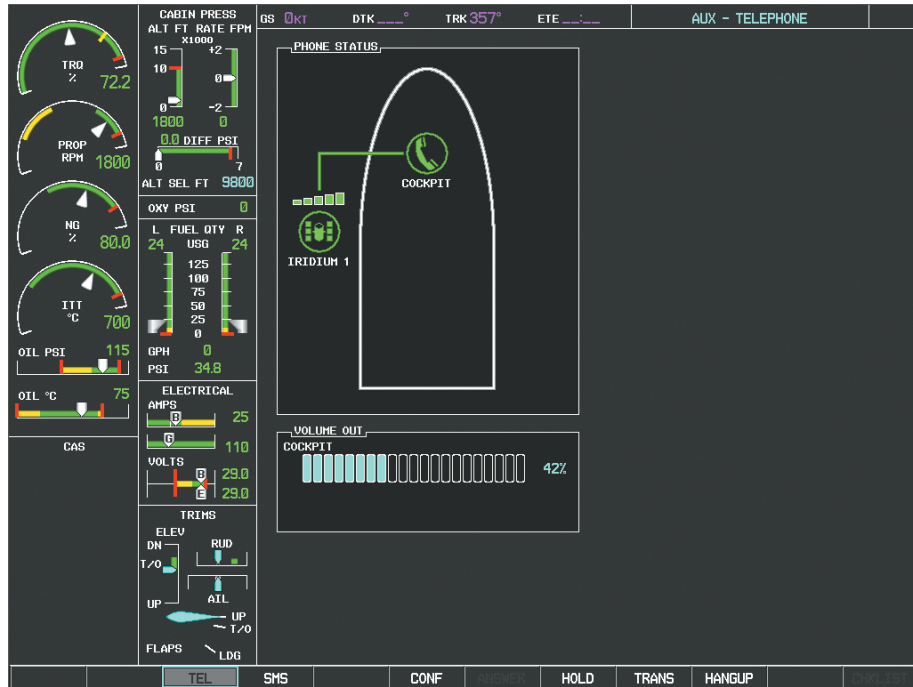

Figure 8-93 Phone is Answered, Connection Complete

TEXT MESSAGING (SMS)

The pilot or copilot can send and receive text messages on the Iridium satellite network. Messages may be sent to an email address or text message capable cellular telephone. Message length is limited to 160 characters, including the email address.

Senders should address text messages to the aircraft by entering [aircraft Iridium phone number]@msg.iridium.com.

The text messaging user interface is mainly through the AUX-TEXT MESSAGING Page.

Viewing the Text Messaging Page:

- 1) Turn the large **FMS** Knob on the MFD to select the AUX page group.
- 2) Turn the small **FMS** Knob to select the SATELLITE PHONE.
- 3) If necessary, select the **SMS** Softkey to display the AUX-TEXT MESSAGING Page as shown in Figure 8-94.



Figure 8-94 Text Messaging Page







Message Symbol	Description
	Received text message that has not been opened
	Received text message that has been opened
	Saved text message, draft not sent
	System is sending text message
	Text message has been sent
	System failed to send text message
	Predefined text message

Table 8-6 Text Message Symbols

VIEWING A TEXT MESSAGE WHEN RECEIVED

When viewing MFD pages other than the AUX-TEXT MESSAGING Page, a pop-up alert similar to Figure 8-95 will be displayed when a new text message is received.



New Text Message Pop-up



New Text Message Symbol on MFD Page

Figure 8-95 New Text Message Received

Select the **VIEW** Softkey to view the message (Figure 8-96). Selecting the **IGNORE** Softkey will extinguish the pop-up window and leave the text message unopened. Selecting the **IGNR ALL** Softkey will extinguish the pop-window and ignore all future incoming text messages. Selecting the **SMS** Softkey will display the AUX-TEXT MESSAGING Page.

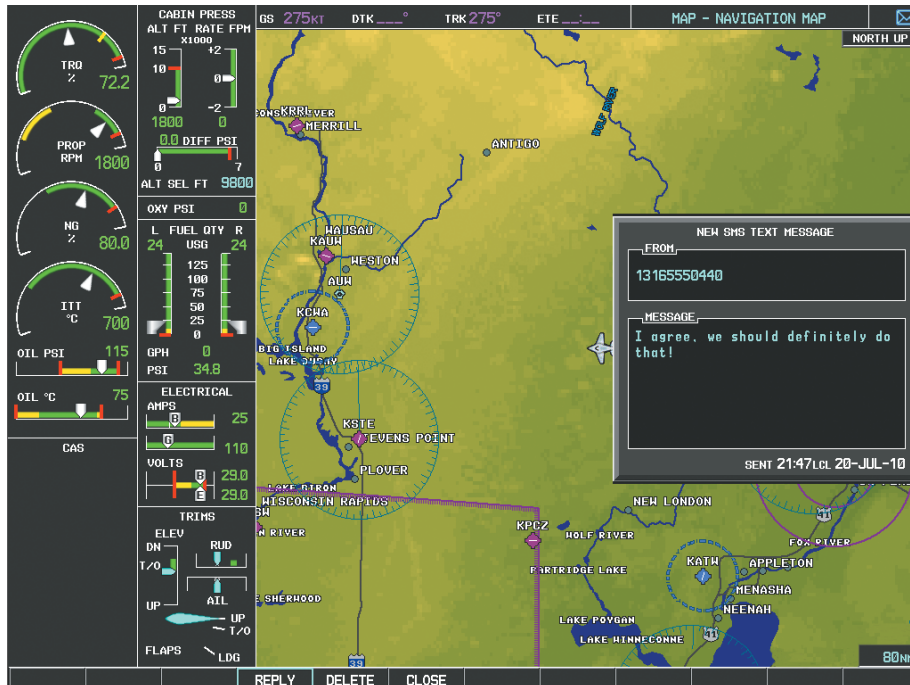

Figure 8-96 Text Message Displayed from Pop-Up Alert

The pop-up alerts may be enabled or disabled through the Page Menu.

Enabling/disabling incoming text message pop-up alerts:

- 1) With the AUX-TEXT MESSAGING Page displayed, press the **MENU** Key on the MFD to display the Page Menu.
- 2) Turn either **FMS** Knob to place the cursor on 'Disable New Message Popups' or 'Enable New Message Popups'.
- 3) Press the **ENT** Key. The pop-up alert will not be displayed when an incoming text message is received.

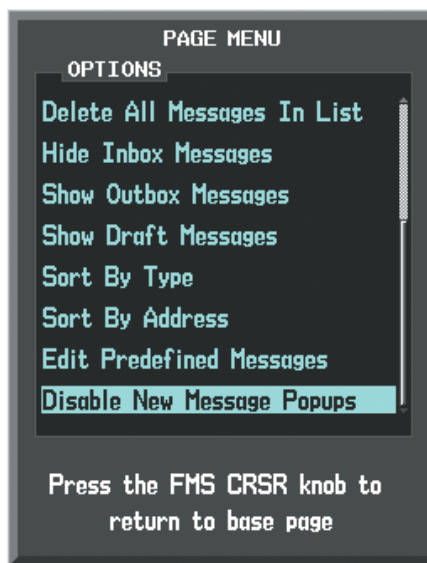

Figure 8-97 Disabling New Text Message Pop-Ups

REPLY TO A TEXT MESSAGE

After reading a text message, a reply may be sent.

Replying to a text message:

While viewing the text message, select the **REPLY** Softkey.

Or:

- 1) Press the **MENU** Key to display the Page Menu.
- 2) Turn either **FMS** Knob to place the cursor on 'Reply To Message'.
- 3) Press the **ENT** Key.

SENDING A TEXT MESSAGE

Text messages may be sent from the AUX-TEXT MESSAGING Page.

Sending a new text message:

- 1) While viewing the AUX-TEXT MESSAGING Page, select the **NEW** Softkey.

Or:

- a) Press the **MENU** Key to display the Page Menu.
 - b) Turn either **FMS** Knob to place the cursor on 'Draft New Message'.
 - c) Press the **ENT** Key.
-
- 2) The TEXT MESSAGE DRAFT Window is now displayed with the cursor in the 'TO' field. Enter 00 + country code + area code + phone number when sending to a text capable telephone. An email address may also be entered. Entry can be accomplished through the alphanumeric keys on the MFD Controller, or combination of the **FMS** Knob on the controller and softkeys on the MFD. The **FMS** Knob is used to enter letters and numbers, or numbers can be entered from the MFD by selecting the **NUMBERS** Softkey. Select the **CAP LOCK** Softkey to create upper and lower case alpha characters. Special characters can be accessed by selecting the **SYMBOLS** Softkey. See Figure 8-98.
 - 3) Press the **ENT** Key. The cursor is now displayed in the 'MESSAGE' field.



Figure 8-98 Composing a New Text Message

- 4) Enter the desired message using any combination of entry methods as described in step 2.
- 5) Press the **ENT** Key.
- 6) Select the **SEND** Softkey to send the message immediately, or select the **SAVE** Softkey to save the message in Outbox for sending at a later time. Select the **CANCEL** Softkey to delete the message.

PREDEFINED TEXT MESSAGES

Time and effort can be saved in typing text messages that are used repeatedly by saving these messages as a predefined message.

Creating a predefined text message:

- 1) While viewing the AUX-TEXT MESSAGING Page, press the **MENU** Key to display the Page Menu.

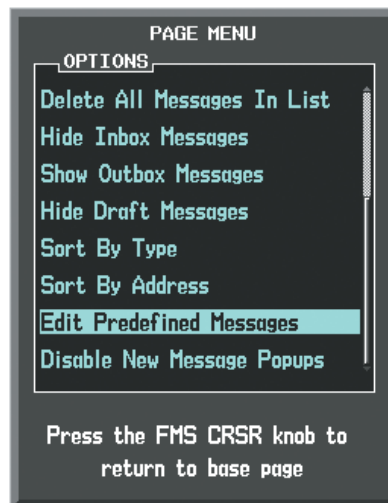

Figure 8-99 Creating/Editing Predefined Messages

- 2) Turn either **FMS** Knob to select 'Edit Predefined Messages' as shown in Figure 8-99.
- 3) Press the **ENT** Key. The PREDEFINED MESSAGES view is now displayed.
- 4) Select the **NEW** Softkey.
 - Or:
 - a) Press the **MENU** Key to display the Page Menu.
 - b) Turn either **FMS** Knob to place the cursor on 'Draft New Predefined Message'.
 - c) Press the **ENT** Key. The PREDEFINED SMS TEXT MESSAGE Window is now displayed as shown in Figure 8-100.

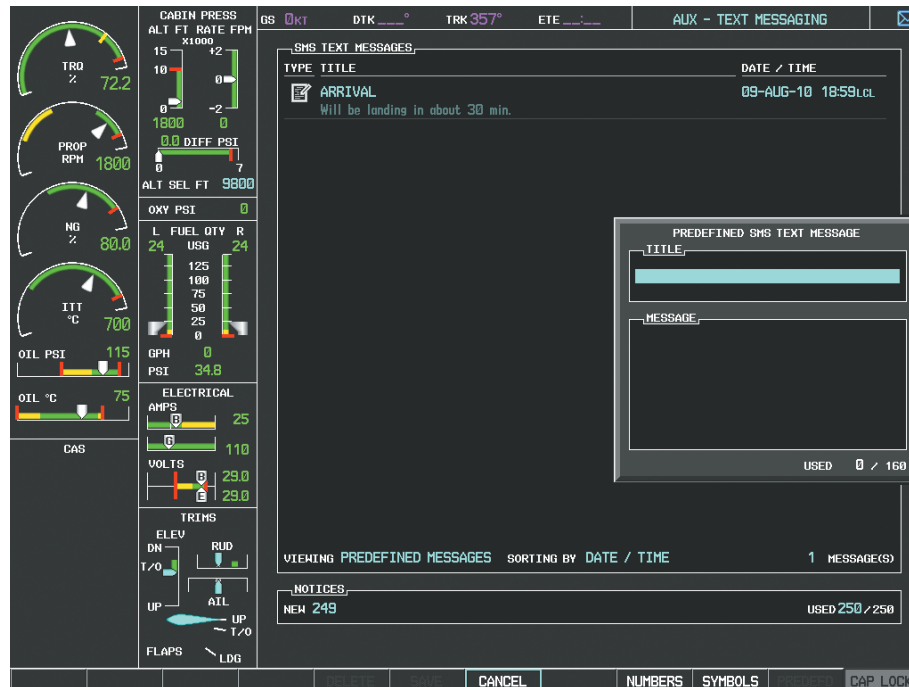

Figure 8-100 Composing a Predefined Message

- 5) The cursor is displayed in the 'TITLE' field. Enter the desired message title. Entry can be accomplished through the alphanumeric keys on the MFD Controller, or combination of the **FMS** Knob on the controller and softkeys on the MFD. The **FMS** Knob is used to enter letters and numbers, or numbers can be entered from the MFD by selecting the **NUMBERS** Softkey. Select the **CAP LOCK** Softkey to create upper and lower case alpha characters. Special characters can be accessed by selecting the **SYMBOLS** Softkey.
- 6) Press the **ENT** Key. The cursor is now displayed in the 'MESSAGE' field.
- 7) Enter the desired message using any combination of entry methods as described in step 5.
- 8) Press the **ENT** Key.
- 9) Select the **SAVE** Softkey. The new predefined message is now shown in the displayed list. Selecting the **CANCEL** Softkey will delete the message without saving.
- 10) Press the **MENU** Key to display the Page Menu.
- 11) Turn either **FMS** Knob to place the cursor on 'Stop Editing Predefined Message'.
- 12) Press the **ENT** Key.

Sending a predefined text message:

- 1) While viewing the AUX-TEXT MESSAGING Page, select the **NEW** Softkey.
- 2) The TEXT MESSAGE DRAFT Window is now displayed with the cursor in the 'TO' field. Enter the desired telephone number or email address. Entry can be accomplished through the alphanumeric keys on the MFD Controller, or combination of the **FMS** Knob on the controller and softkeys on the MFD. The **FMS** Knob is used to enter letters and numbers, or numbers can be entered from the MFD by selecting the **NUMBERS** Softkey. Select the **CAP LOCK** Softkey to create upper and lower case alpha characters. Special characters can be accessed by selecting the **SYMBOLS** Softkey.
- 3) Press the **ENT** Key. The cursor is now displayed in the 'MESSAGE' field (Figure 8-101).



Figure 8-101 Predefined Message Softkey Shown When Composing a Message

- 4) Select the **PREDEFD** Softkey. The PREDEFINED MESSAGE MENU Window is displayed as seen in Figure 8-102.

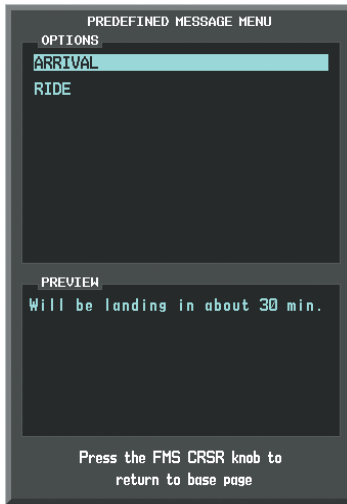

Figure 8-102 Predefined Message List

- 5) Turn either **FMS** Knob to select the desired predefined message.
- 6) Press the **ENT** Key. The predefined message text is inserted into the message field. If desired, the message can be edited by using the FMS Knobs.
- 7) Press the **ENT** Key.
- 8) Select the **SEND** Softkey to transmit the message.

TEXT MESSAGE BOXES

Received text messages reside in the Inbox as ‘Read’ or ‘Unread’ messages. The Outbox contains ‘Sent’ and ‘Unsent’ text messages. Saved messages that are meant to be sent later are stored as Drafts. Each text message box may be viewed separately, or together in any combination.

Show Inbox messages:

While viewing the AUX-TEXT MESSAGING Page, select the **ARRANGE** Softkey, then select the **INBOX** Softkey (Figure 8-103).

Or:

- 1) Press the **MENU** Key to display the Page Menu.
- 2) Turn either **FMS** Knob to place the cursor on ‘Show Inbox Messages’.
- 3) Press the **ENT** Key. The message box selected for viewing is indicated at the bottom left of the list window.



Figure 8-103 Text Message Inbox

Show Outbox messages:

While viewing the AUX-TEXT MESSAGING Page, select the **ARRANGE** Softkey, then select the **OUTBOX** Softkey.

Or:

- 1) Press the **MENU** Key to display the Page Menu.
- 2) Turn either **FMS** Knob to place the cursor on 'Show Outbox Messages'.
- 3) Press the **ENT** Key. The message box selected for viewing is indicated at the bottom left of the list window.

Show Draft messages:

While viewing the AUX-TEXT MESSAGING Page, select the **ARRANGE** Softkey, then select the **DRAFTS** Softkey.

Or:

- 1) Press the **MENU** Key to display the Page Menu.
- 2) Turn either **FMS** Knob to place the cursor on 'Show Draft Messages'.
- 3) Press the **ENT** Key. The message box selected for viewing is indicated at the bottom left of the list window.

MANAGING TEXT MESSAGES

The viewed messages may be listed according to the date/time the message was sent or received, the type of message (read, unread, sent, unsent, etc.), or by message address.

Viewing messages sorted by message date/time:

While viewing the AUX-TEXT MESSAGING Page, select the **ARRANGE** Softkey, then select the **TIME** Softkey (Figure 8-103).

Or:

- 1) Press the **MENU** Key to display the Page Menu.
- 2) Turn either **FMS** Knob to place the cursor on 'Sort By Date/Time'.
- 3) Press the **ENT** Key. The sorting selection is indicated at the bottom center of the list window.

Viewing messages sorted by message type:

While viewing the AUX-TEXT MESSAGING Page, select the **ARRANGE** Softkey, then select the **TYPE** Softkey.

Or:

- 1) Press the **MENU** Key to display the Page Menu.
- 2) Turn either **FMS** Knob to place the cursor on 'Sort By Type'.
- 3) Press the **ENT** Key. The sorting selection is indicated at the bottom center of the list window.

Viewing messages sorted by address:

While viewing the AUX-TEXT MESSAGING Page, select the **ARRANGE** Softkey, then select the **ADDRESS** Softkey.

Or:

- 1) Press the **MENU** Key to display the Page Menu.
- 2) Turn either **FMS** Knob to place the cursor on 'Sort By Address'.
- 3) Press the **ENT** Key. The sorting selection is indicated at the bottom center of the list window.

Viewing the content of a text message:

- 1) While viewing the AUX-TEXT MESSAGING Page, select the desired message box.
- 2) Press the **FMS** Knob to activate the cursor.
- 3) Turn either **FMS** Knob to select the desired message.
- 4) Select the **VIEW** Softkey.

Or:

Press the **ENT** Key.

Or:

- a) Press the **MENU** Key to display the Page Menu.
- b) Turn either **FMS** Knob to place the cursor on 'View Selected Message'.
- c) Press the **ENT** Key.

Message content is displayed as shown in Figure 8-104.



Figure 8-104 Viewing Message Content

- 5) To close the text message, select the **CLOSE** Softkey.

Or:

- a) Press the **MENU** Key to display the Page Menu.
- b) Turn either **FMS** Knob to place the cursor on 'Close Message'.
- c) Press the **ENT** Key.

Marking selected message as read:

- 1) While viewing the Inbox on the AUX-TEXT MESSAGING Page, press the **FMS** Knob to activate the cursor.
- 2) Turn either **FMS** Knob to select the desired message.
- 3) Select the **MRK READ** Softkey.

Or:

- a) Press the **MENU** Key to display the Page Menu.
- b) Turn either **FMS** Knob to place the cursor on 'Mark Selected Message As Read'.
- c) Press the **ENT** Key.

The message symbol now indicates the message has been opened.

Marking all messages as read:

- 1) While viewing the Inbox on the AUX-TEXT MESSAGING Page, press the **MENU** Key to display the Page Menu.
- 2) Turn either **FMS** Knob to place the cursor on 'Mark All New Messages As Read'.
- 3) Press the **ENT** Key. A confirmation window is displayed.
- 4) With cursor highlighting 'YES', press the **ENT** Key. The message symbols now indicate all the message have been opened.

Delete a message:

- 1) While viewing the Inbox on the AUX-TEXT MESSAGING Page, press the **FMS** Knob to activate the cursor.
- 2) Turn either **FMS** Knob to select the desired message.
- 3) Select the **DELETE** Softkey.

Or:

- a) Press the **MENU** Key to display the Page Menu.
- b) Turn either **FMS** Knob to place the cursor on 'Delete Selected Message'.
- c) Press the **ENT** Key.

8.11 ABNORMAL OPERATION

SVS TROUBLESHOOTING

SVS is intended to be used with traditional attitude, heading, obstacle, terrain, and traffic inputs. SVS is disabled when valid attitude or heading data is not available for the display. In case of invalid SVS data, the PFD display reverts to the standard blue-over-brown attitude display.

SVS becomes disabled without the following data resources:

- Attitude data
- Heading data
- GPS position data
- 9 Arc-second Terrain data
- Obstacle data
- TAWS function is not available, in test mode, or failed
- The position of the aircraft exceeds the range of the terrain database.

REVERSIONARY MODE

SVS can be displayed on the Multifunction Display (MFD) in Reversionary Mode. If it is enabled when switching to Reversionary Mode, SVS will take up to 30 seconds to be displayed. The standard, non-SVS PFD display will be shown in the interim.



Figure 8-105 SVS Reversionary Mode

UNUSUAL ATTITUDES

Unusual attitudes are displayed with red chevrons overlaid on the display indicating the direction to fly to correct the unusual attitude condition. The display shows either a brown or blue colored bar at the top or bottom of the screen to represent earth or sky. This is intended to prevent losing sight of the horizon during extreme pitch attitudes.

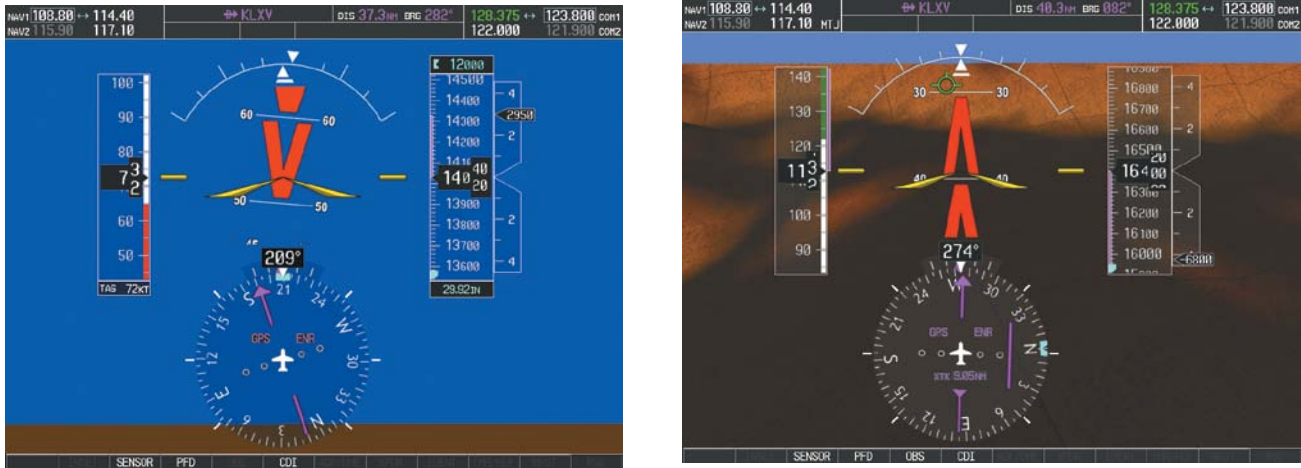

Figure 8-106 Unusual Attitude Display

The blue colored bar is also displayed when terrain gradient is great enough to completely fill the display.



Figure 8-107 Blue Sky Bar with Full Display Terrain

GDL 69/69A DATA LINK RECEIVER TROUBLESHOOTING

Some quick troubleshooting steps listed below can be performed to find the possible cause of a failure.

- Ensure the owner/operator of the aircraft in which the Data Link Receiver is installed has subscribed to SiriusXM
- Ensure the SiriusXM subscription has been activated
- Perform a quick check of the circuit breakers to ensure that power is applied to the Data Link Receiver
- Ensure that nothing is plugged into the MUSIC 1 or MUSIC 2 jacks because that would prevent XM radio from being heard

For troubleshooting purposes, check the LRU Information Box on the AUX - System Status Page for Data Link Receiver (GDL 69/69A) status, serial number, and software version number. If a failure has been detected in the GDL 69/69A the status is marked with a red X.

Selecting the AUX - System Status Page:

- 1) Turn the large **FMS** Knob to select the AUX Page Group.
- 2) Turn the small **FMS** Knob to select the AUX - System Status Page.

LRU INFO	STATUS	SERIAL NUMBER	VERSION
COM1	✓		7.00
COM2	✓		7.00
GCU	✓	27000006	2.02d
GDC1	✓	47801548	1.05
GDC2	✓	47801373	1.05
GDL69	✓	47750372	3.02.00
GEA1	✓	46701911	2.07
GEA2	✓	46701913	2.07
GEA3	✓	FFFFFFFF	1.02
GIA1	✓	68500319	1.02
GIA2	✓	48400000	3.01
GMA1	✓	48400001	3.01
GMA2	✓		2.02d
GMC	✓	47500593	2.01
GMU1	✓	47500607	2.01
GMU2	✓	AB0062149	2.3

Figure 8-108 LRU Information Window on System Status Page

If a failure still exists, the following messages may provide insight as to the possible problem:

Message	Message Location	Description
CHECK ANTENNA	XM Radio Page - active channel field	Data Link Receiver antenna error; service required
UPDATING	XM Radio Page - active channel field	Data Link Receiver updating encryption code
NO SIGNAL	XM Radio Page - active channel field Weather Datalink Page - center of page	Loss of signal; signal strength too low for receiver
LOADING	XM Radio Page - active channel field	Acquiring channel audio or information
OFF AIR	XM Radio Page - active channel field	Channel not in service
---	XM Radio Page - active channel field	Missing channel information
WEATHER DATA LINK FAILURE	Weather Datalink Page - center of page	No communication from Data Link Receiver within last 5 minutes
ACTIVATION REQUIRED	Weather Datalink Page - center of page	SiriusXM subscription is not activated

Table 8-7 GDL 69/69A Data Link Receiver Error Messages

ANNUNCIATIONS AND ALERTS

CAS MESSAGES

See the Pilot's Operating Handbook (POH) for recommended pilot actions.

- **Warning** (red) – Immediate crew awareness and action required; Master Warning triggered
- **Caution** (yellow) – Immediate crew awareness and possible future corrective action required; Master Caution triggered

Inhibits prevent certain CAS messages from being displayed during the following conditions:

- Engine off
- Engine on
- Aircraft on ground (Ground)
- Takeoff Operation Phase Inhibit (TOPI)
- Aircraft in air (AIR)
- Landing Operation Phase Inhibit (LOPI)

Messages	Comments	Inhibits					
		ENGINE OFF	ENGINE ON	GROUND	TOPI	AIR	LOPI
BAT OVERHEAT	Battery temperature over 70°C						
BLEED TEMP	Bleed temperature high	X			X		
CABIN ALTITUDE	Cabin altitude over 10,000 ft			X			
CABIN DIFF PRESS	Cabin pressure differential over 6.2 psi	X					
DOOR	Pilot or cabin door open						
FIRE	Engine compartment fire (temperature over 200°C; if installed)						
FLAPS ASYM	Dissymmetry between left- and right-hand flaps						
FUEL OFF	Fuel tank selectors set to "Off"						
FUEL PRESS	Fuel pressure below 10 psi						
ITT	Engine start: ITT over 1000°C, 870°C (5 s), or 840°C (20 s) Engine running: ITT over 840°C						
OIL PRESS	Oil pressure below 60 psi						
OXYGEN	Oxygen cylinder closed						
PARK BRAKE	Parking brake applied						
TORQUE	Torque greater than or equal to 121.4% maximum torque						

Warning Messages

Messages	Comments	Inhibits					
		ENGINE OFF	ENGINE ON	GROUND	TOPI	AIR	LOPI
AUTO SEL	Fuel timer off or out of service				X		
AUX BOOST PMP ON	Electric fuel pump running (manual or automatic mode)						
BAT AMP	Battery current over 50 A while on ground				X	X	X
BAT OFF	Battery off				X		
BLEED OFF	Flow control and shut-off valve/shut-off valve closed	X			X		X
CHIP	Oil chip detector on (if installed)				X		X
FRONT CARGO DOOR	Forward baggage door open				X		
FUEL IMBALANCE	Fuel tanks imbalanced by more than 15 USGAL for >30 seconds						
FUEL LOW L-R*	Fuel quantity less than or equal to 9.1 USGAL in specified tank						
GPU DOOR	GPU receptacle door not closed				X		X
IGNITION	Ignition exciter running						
INERT SEP FAIL	Inertial separator failure	X			X		
INERT SEP ON	Inertial separator extended						
LOW LVL FAIL L-R*	Low fuel level sensor failure for specified tank						
LOW VOLTAGE	Battery voltage below 26 V				X		X
MAIN GEN	Starter generator unconnected	X			X		
NG HI	Generator speed is more than 103%						
OIL PRESS	Oil pressure between 60 and 100 psi	X					
OIL TEMP	Oil temperature below 0°C or above 104°C				X		
PITOT HT ON L-R*	Specified pitot heat (left or right) on while engine off		X				
PITOT NO HT L-R*	Specified pitot heat (left or right) off	X					
PROP DEICE FAIL	Prop deice selected and not on	X			X		
PROP DEICE ON	Prop deice on while engine off		X				
REAR CARGO DOOR	Rear cargo door open				X		
STALL HEAT ON	Stall warning heat on while engine off		X				
STALL NO HEAT	Stall warning heat off	X					
STARTER	Starter generator running						
VACUUM LOW	Vacuum pressure less than 3.75 in Hg	X			X		

* Only affected side (L, R, or L-R) displayed in CAS message; applicable messages listed here display L-R for example

Caution Messages

COMPARATOR ANNUNCIATIONS

The Comparator monitors critical values generated by redundant sensors. If differences in the sensors exceed a specified amount, this discrepancy is annunciated in the Comparator Window as a ‘MISCOMP’ (miscompare) as seen in Figure A-1. If one or both of the sensed values are unavailable, it is annunciated as a ‘NO COMP’ (no compare). The following is a list of the possible annunciations:

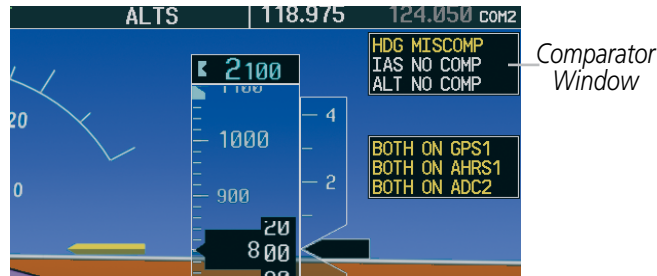

Figure A-1 Sensor Comparator Window

Comparator Window Text	Condition
ALT MISCOMP	Difference in altitude sensors is ≥ 200 ft.
IAS MISCOMP	If both airspeed sensors detect < 35 knots, this is inhibited.
	If either airspeed sensor detects ≥ 35 knots, and the difference in sensors is > 10 knots.
	If either airspeed sensor detects ≥ 80 knots, and the difference in sensors is > 7 knots.
HDG MISCOMP	Difference in heading sensors is > 6 degrees.
PIT MISCOMP	Difference in pitch sensors is > 5 degrees.
ROL MISCOMP	Difference in roll sensors is > 6 degrees.
ALT NO COMP	No data from one or both altitude sensors.
IAS NO COMP	No data from one or both airspeed sensors.
HDG NO COMP	No data from one or both heading sensors.
PIT NO COMP	No data from one or both pitch sensors.
ROL NO COMP	No data from one or both roll sensors..

REVERSIONARY SENSOR ANNUNCIATIONS

Reversionary sensor selection is annunciated in the Reversionary Sensor Window, as shown in Figure A-2. These annunciations reflect reversionary sensors selected on one or both PFDs. Selecting the **SENSOR** Softkey gives access to **ADC1**, **ADC2**, **AHRS1**, and **AHRS2** Softkeys. These softkeys allow manual switching of sensors. In the case of certain types of sensor failures, the G1000 may make some sensor selections automatically. The GPS sensor cannot be switched manually.



Figure A-2 Reversionary Sensor Windows

Reversionary Sensor Window Text	Condition
BOTH ON ADC1	Both PFDs are displaying data from the number one Air Data Computer.
BOTH ON ADC2	Both PFDs are displaying data from the number two Air Data Computer.
BOTH ON AHRS1	Both PFDs are displaying data from the number one Attitude & Heading Reference System.
BOTH ON AHRS2	Both PFDs are displaying data from the number two Attitude & Heading Reference System.
BOTH ON GPS1	Both PFDs are displaying data from the number one GPS receiver.
BOTH ON GPS2	Both PFDs are displaying data from the number two GPS receiver.
USING ADC1	PFD2 is displaying data from the #1 Air Data Computer.
USING ADC2	PFD1 is displaying data from the #2 Air Data Computer.
USING AHRS1	PFD2 is displaying data from the #1 AHRS.
USING AHRS2	PFD1 is displaying data from the #2 AHRS.
USING GPS1	PFD2 is displaying data from the #1 GPS.
USING GPS2	PFD1 is displaying data from the #2 GPS.

SYSTEM ANNUNCIATIONS

When a new message is issued, the **MSG** Softkey flashes to alert the flight crew of a new message. It continues to flash until acknowledged by selecting the softkey. Active messages are displayed in white text. Messages that have become inactive change to gray text. The **MSG** Softkey flashes if the state of a displayed message changes or a new message is displayed. The inactive messages can be removed from the Message Window by selecting the flashing **MSG** Softkey.

Message Advisories are displayed in the Messages Window and convey messages to the flight crew regarding problems with the G1000 or certain aircraft systems. Typically, a large red 'X' appears in a window when a related LRU fails or detects invalid data.

The following section describes various system annunciations. Refer to the POH for additional information regarding pilot responses to these annunciations.



NOTE: Upon power-up of the G1000 system, certain windows remain invalid as G1000 equipment begins to initialize. All windows should be operational within one minute of power-up. Should any window continue to remain flagged, the G1000 system should be serviced by a Garmin-authorized repair facility.

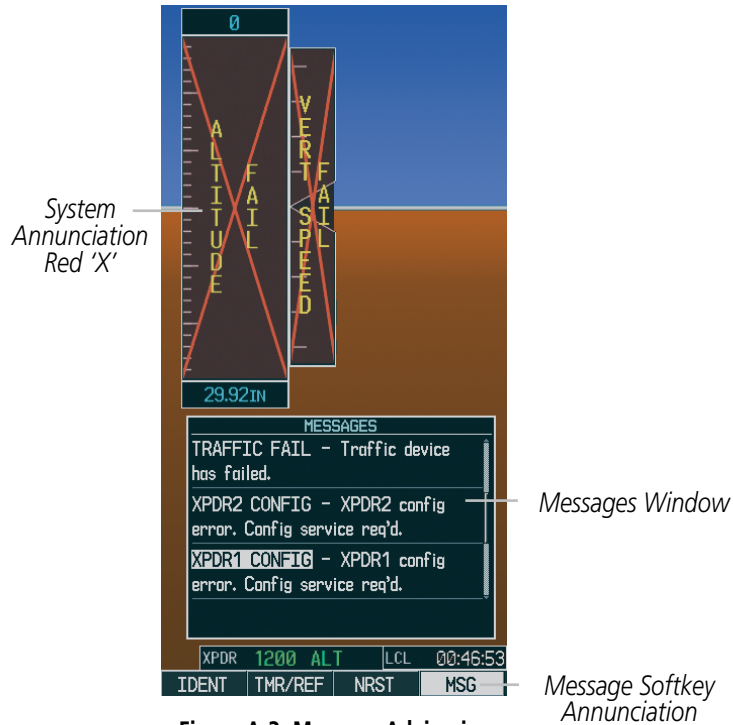

Figure A-3 Message Advisories

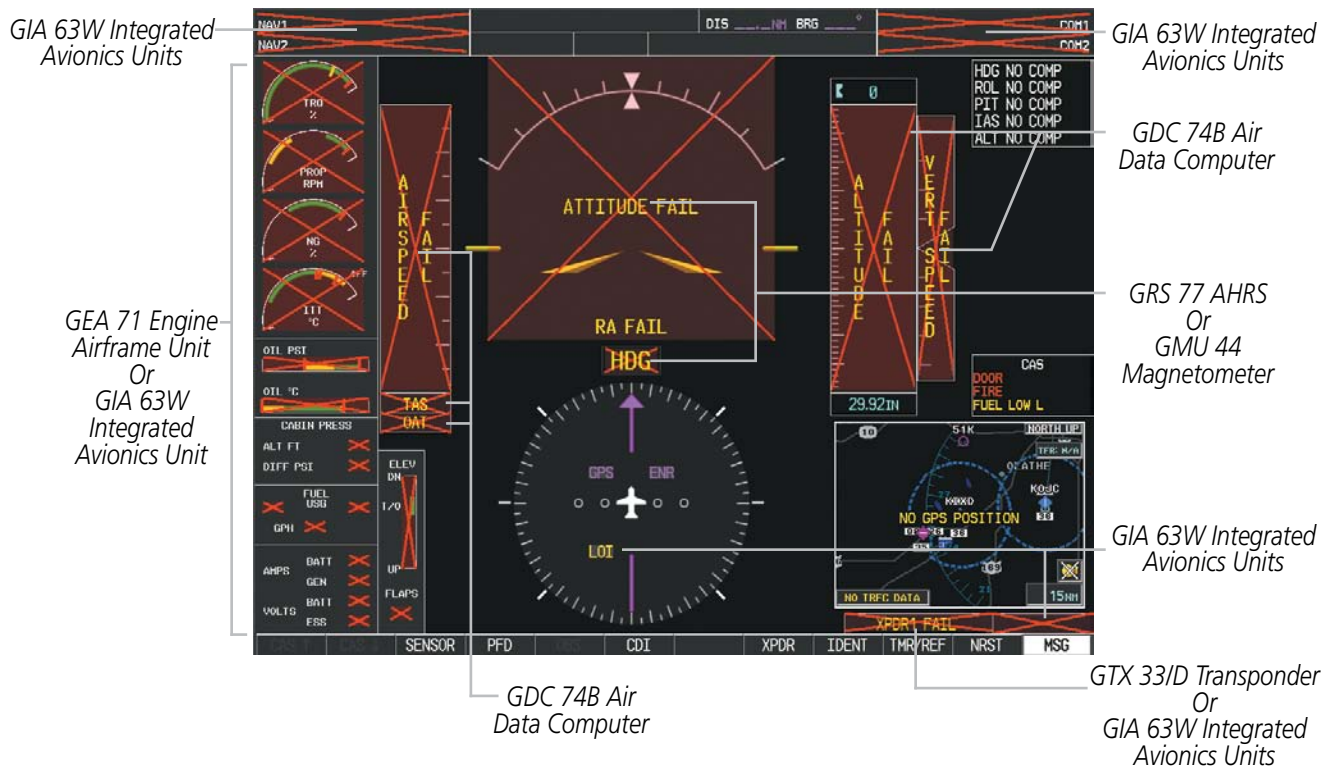



Figure A-4 System Failure Annunciations

System Annunciation	Comment
 <p>AHRS ALIGN: Keep Wings Level</p>	<p>Attitude and Heading Reference System is aligning.</p>
 <p>ATTITUDE FAIL</p>	<p>Display system is not receiving attitude information from the AHRS.</p>
 <p>CALIBRATE AHRS/MAG</p>	<p>Indicates a configuration module failure.</p>
 <p>AIRSPEED FAIL</p>	<p>Display system is not receiving airspeed input from air data computer.</p>
 <p>HDG</p>	<p>Display system is not receiving valid heading input from AHRS.</p>
 <p>ALTITUDE FAIL</p>	<p>Display system is not receiving altitude input from the air data computer.</p>
 <p>VERTICAL SPEED FAIL</p>	<p>Display system is not receiving vertical speed input from the air data computer.</p>
 <p>XPDR1 FAIL</p>	<p>Display system is not receiving valid transponder information.</p>

System Annunciation	Comment
	<p>GPS information is either not present or is invalid for navigation use. Note that AHRS utilizes GPS inputs during normal operation. AHRS operation may be degraded if GPS signals are not present (see POH).</p>
<p>Other Various Red X Indications</p>	<p>A red 'X' through any other display field (such as engine instrumentation display) indicates that the field is not receiving valid data.</p>

MESSAGE ADVISORIES

This section describes various Message Advisories. Certain messages are issued due to an LRU or an LRU function failure. Such messages are normally accompanied by a corresponding red 'X' annunciation as shown previously in the System Annunciation section.



NOTE: This section provides information regarding Message Advisories that may be displayed by the system. Knowledge of the aircraft, systems, flight conditions, and other existing operational priorities must be considered when responding to a message. Always use sound pilot judgment. The Pilot's Operating Handbook (POH) takes precedence over any conflicting guidance found in this section.

MFD & PFD MESSAGE ADVISORIES

Message	Comments
<p>DATA LOST – Pilot stored data was lost. Recheck settings.</p>	<p>The pilot profile data was lost. System reverts to default pilot profile and settings. The pilot may reconfigure the MFD & PFDs with preferred settings, if desired.</p>
<p>XTALK ERROR – A flight display crosstalk error has occurred.</p>	<p>The MFD and PFDs are not communicating with each other. The G1000 system should be serviced.</p>
<p>PFD1 SERVICE – PFD1 needs service. Return unit for repair.</p>	
<p>PFD2 SERVICE – PFD2 needs service. Return unit for repair.</p>	<p>The PFD and/or MFD self-test has detected a problem. The G1000 system should be serviced.</p>
<p>MFD1 SERVICE – MFD1 needs service. Return unit for repair.</p>	
<p>MANIFEST – PFD1 software mismatch, communication halted.</p>	
<p>MANIFEST – PFD2 software mismatch, communication halted.</p>	<p>The PFD and/or MFD has incorrect software installed. The G1000 system should be serviced.</p>
<p>MANIFEST – MFD1 software mismatch, communication halted.</p>	

MFD & PFD MESSAGE ADVISORIES (CONT.)

Message	Comments
PFD1 CONFIG – PFD1 config error. Config service req'd.	The PFD configuration settings do not match backup configuration memory. The G1000 system should be serviced.
PFD2 CONFIG – PFD2 config error. Config service req'd.	
MFD1 CONFIG – MFD1 config error. Config service req'd.	The MFD configuration settings do not match backup configuration memory. The G1000 system should be serviced.
SW MISMATCH – GDU software version mismatch. Xtalk is off.	The MFD and PFDs have different software versions installed. The G1000 system should be serviced.
PFD1 COOLING – PFD1 has poor cooling. Reducing power usage.	The PFD and/or MFD is overheating and is reducing power consumption by dimming the display. If problem persists, the G1000 system should be serviced.
PFD2 COOLING – PFD2 has poor cooling. Reducing power usage.	
MFD1 COOLING – MFD1 has poor cooling. Reducing power usage.	
PFD1 KEYSTK – PFD1 [key name] Key is stuck.	A key is stuck on the PFD and/or MFD bezel. Attempt to free the stuck key by pressing it several times. The G1000 system should be serviced if the problem persists.
PFD2 KEYSTK – PFD2 [key name] Key is stuck.	
MFD1 KEYSTK – MFD [key name] Key is stuck.	
CNFG MODULE – PFD1 configuration module is inoperative.	The PFD1 configuration module backup memory has failed. The G1000 system should be serviced.
PFD1 VOLTAGE – PFD1 has low voltage. Reducing power usage	The PFD1 voltage is low. The G1000 system should be serviced.
PFD2 VOLTAGE – PFD2 has low voltage. Reducing power usage	The PFD2 voltage is low. The G1000 system should be serviced.
MFD1 VOLTAGE – MFD1 has low voltage. Reducing power usage	The MFD voltage is low. The G1000 system should be serviced.

DATABASE MESSAGE ADVISORIES

Message	Comments
MFD1 DB ERR – MFD1 navigation database error exists.	The MFD and/or PFD detected a failure in the navigation database. Attempt to reload the navigation database. If problem persists, the G1000 system should be serviced.
PFD1 DB ERR – PFD1 navigation database error exists.	
PFD2 DB ERR – PFD2 navigation database error exists.	

DATABASE MESSAGE ADVISORIES (CONT.)

Message	Comments
MFD1 DB ERR – MFD1 basemap database error exists.	The MFD and/or PFD detected a failure in the basemap database.
PFD1 DB ERR – PFD1 basemap database error exists.	
PFD2 DB ERR – PFD2 basemap database error exists.	
MFD1 DB ERR – MFD1 terrain database error exists.	The MFD and/or PFD detected a failure in the terrain database. Ensure that the terrain card is properly inserted in display. Replace terrain card. If problem persists, The G1000 system should be serviced.
PFD1 DB ERR – PFD1 terrain database error exists.	
PFD2 DB ERR – PFD2 terrain database error exists.	
MFD1 DB ERR – MFD1 terrain database missing.	The terrain database is present on another LRU, but is missing on the specified LRU.
PFD1 DB ERR – PFD1 terrain database missing.	
PFD2 DB ERR – PFD2 terrain database missing.	
MFD1 DB ERR – MFD1 obstacle database error exists.	The MFD and/or PFD detected a failure in the obstacle database. Ensure that the data card is properly inserted. Replace data card. If problem persists, The G1000 system should be serviced.
PFD1 DB ERR – PFD1 obstacle database error exists.	
PFD2 DB ERR – PFD2 obstacle database error exists.	
MFD1 DB ERR – MFD1 obstacle database missing.	The obstacle database is present on another LRU, but is missing on the specified LRU.
PFD1 DB ERR – PFD1 obstacle database missing.	
PFD2 DB ERR – PFD2 obstacle database missing.	
MFD1 DB ERR – MFD1 airport terrain database error exists.	The MFD and/or PFD detected a failure in the airport terrain database. Ensure that the data card is properly inserted. Replace data card. If problem persists, The G1000 system should be serviced.
PFD1 DB ERR – PFD1 airport terrain database error exists.	
PFD2 DB ERR – PFD2 airport terrain database error exists.	
MFD1 DB ERR – MFD1 airport terrain database missing.	The airport terrain database is present on another LRU, but is missing on the specified LRU.
PFD1 DB ERR – PFD1 airport terrain database missing.	
PFD2 DB ERR – PFD2 airport terrain database missing.	

DATABASE MESSAGE ADVISORIES (CONT.)

Message	Comments
MFD1 DB ERR – MFD1 Safe Taxi database error exists.	The MFD and/or PFD detected a failure in the Safe Taxi database. Ensure that the data card is properly inserted. Replace data card. If problem persists, The G1000 system should be serviced.
PFD1 DB ERR – PFD1 Safe Taxi database error exists.	
PFD2 DB ERR – PFD2 Safe Taxi database error exists.	
MFD1 DB ERR – MFD1 Chartview database error exists.	The MFD detected a failure in the ChartView database (optional feature). Ensure the data card is properly inserted. Replace data card. If problem persists, the system should be serviced.
MFD1 DB ERR – MFD1 FliteCharts database error exists.	The MFD detected a failure in the FliteCharts database (optional feature). Ensure the data card is properly inserted. Replace data card. If problem persists, the system should be serviced.
MFD1 DB ERR – MFD1 Airport Directory database error exists.	The MFD detected a failure in the Airport Directory database. Ensure the data card is properly inserted. Replace data card. If problem persists, the system should be serviced.
DB MISMATCH – Navigation database mismatch. Xtalk is off.	The PFDs and MFD have different navigation database versions or regions installed. Crossfill is off. Check the AUX-SYSTEM STATUS Page to determine versions or regions. Also, check the AUX-SYSTEM STATUS Page for a database synchronization function not completed. After synchronization is complete, power must be turned off, then on.
DB MISMATCH – Standby Navigation database mismatch.	The PFDs and MFD have different standby navigation database versions or regions installed. Check the AUX-SYSTEM STATUS Page to determine versions or regions. Also, check the AUX-SYSTEM STATUS Page for a database synchronization function not completed. After synchronization is complete, power must be turned off, then on.
DB MISMATCH – Terrain database mismatch.	The PFDs and MFD have different terrain database versions or regions installed. Check the AUX-SYSTEM STATUS Page to determine versions or regions. Also, check the AUX-SYSTEM STATUS Page for a database synchronization function not completed. After synchronization is complete, power must be turned off, then on.
DB MISMATCH – Obstacle database mismatch.	The PFDs and MFD have different obstacle database versions or regions installed. Check the AUX-SYSTEM STATUS Page to determine versions or regions. Also, check the AUX-SYSTEM STATUS Page for a database synchronization function not completed. After synchronization is complete, power must be turned off, then on.
DB MISMATCH – Airport Terrain database mismatch.	The PFDs and MFD have different airport terrain database versions or regions installed. Check the AUX-SYSTEM STATUS Page to determine versions or regions. Also, check the AUX-SYSTEM STATUS Page for a database synchronization function not completed. After synchronization is complete, power must be turned off, then on.
NAV DB UPDATED – Active navigation database updated.	System has updated the active navigation database from the standby navigation database.
TERRAIN DSP – [PFD1, PFD2 or MFD1] Terrain awareness display unavailable.	One of the terrain, airport terrain, or obstacle databases required for TAWS in the specified PFD or MFD is missing or invalid.

GMA 1347D MESSAGE ADVISORIES

Message	Comments
GMA1 FAIL – GMA1 is inoperative.	The audio panel self-test has detected a failure. The audio panel is unavailable. The G1000 system should be serviced.
GMA2 FAIL – GMA2 is inoperative.	
GMA XTALK – GMA crosstalk error has occurred.	An error has occurred in transferring data between the two GMAs. The G1000 system should be serviced.
GMA1 CONFIG – GMA1 config error. Config service req'd.	The audio panel configuration settings do not match backup configuration memory. The G1000 system should be serviced.
GMA2 CONFIG – GMA2 config error. Config service req'd.	
MANIFEST – GMA1 software mismatch, communication halted.	The audio panel has incorrect software installed. The G1000 system should be serviced.
MANIFEST – GMA2 software mismatch, communication halted.	
GMA1 SERVICE – GMA1 needs service. Return unit for repair.	The audio panel self-test has detected a problem in the unit. Certain audio functions may still be available, and the audio panel may still be usable. The G1000 system should be serviced when possible.
GMA2 SERVICE – GMA2 needs service. Return unit for repair.	

GIA 63W MESSAGE ADVISORIES

Message	Comments
GIA1 CONFIG – GIA1 config error. Config service req'd.	The GIA1 and/or GIA2 configuration settings do not match backup configuration memory. The G1000 system should be serviced.
GIA2 CONFIG – GIA2 config error. Config service req'd.	
GIA1 CONFIG – GIA1 audio config error. Config service req'd.	The GIA1 and/or GIA2 have an error in the audio configuration. The G1000 system should be serviced.
GIA2 CONFIG – GIA2 audio config error. Config service req'd.	
COM1 CONFIG – COM1 config error. Config service req'd.	The COM1 and/or COM2 configuration settings do not match backup configuration memory. The system should be serviced.
COM2 CONFIG – COM2 config error. Config service req'd.	
GIA1 COOLING – GIA1 temperature too low.	The GIA1 and/or GIA2 temperature is too low to operate correctly. Allow units to warm up to operating temperature.
GIA2 COOLING – GIA2 temperature too low.	
GIA1 COOLING – GIA1 over temperature.	The GIA1 and/or GIA2 temperature is too high. If problem persists, the G1000 system should be serviced.
GIA2 COOLING – GIA2 over temperature.	

GIA 63W MESSAGE ADVISORIES (CONT.)

Message	Comments
GIA1 SERVICE – GIA1 needs service. Return the unit for repair.	The GIA1 and/or GIA2 self-test has detected a problem in the unit. The G1000 system should be serviced.
GIA2 SERVICE – GIA2 needs service. Return the unit for repair.	
HW MISMATCH – GIA hardware mismatch. GIA1 communication halted.	A GIA mismatch has been detected, where only one is SBAS capable.
HW MISMATCH – GIA hardware mismatch. GIA2 communication halted.	
MANIFEST – GIA1 software mismatch, communication halted.	The GIA1 and/or GIA 2 has incorrect software installed. The G1000 system should be serviced.
MANIFEST – GIA2 software mismatch, communication halted.	
MANIFEST – GFC software mismatch, communication halted.	Incorrect servo software is installed, or gain settings are incorrect.
MANIFEST – COM1 software mismatch, communication halted.	The COM1 and/or COM2 has incorrect software installed. The system should be serviced.
MANIFEST – COM2 software mismatch, communication halted.	
MANIFEST – NAV1 software mismatch, communication halted.	The NAV1 and/or NAV2 has incorrect software installed. The system should be serviced.
MANIFEST – NAV2 software mismatch, communication halted.	
COM1 TEMP – COM1 over temp. Reducing transmitter power.	The system has detected an over temperature condition in COM1 and/or COM2. The transmitter is operating at reduced power. If the problem persists, the G1000 system should be serviced.
COM2 TEMP – COM2 over temp. Reducing transmitter power.	
COM1 SERVICE – COM1 needs service. Return unit for repair.	The system has detected a failure in COM1 and/or COM2. COM1 and/or COM2 may still be usable. The G1000 system should be serviced when possible.
COM2 SERVICE – COM2 needs service. Return unit for repair.	
COM1 PTT – COM1 push-to-talk key is stuck.	The COM1 and/or COM2 external push-to-talk switch is stuck in the enable (or “pressed”) position. Press the PTT switch again to cycle its operation. If the problem persists, the G1000 system should be serviced.
COM2 PTT – COM2 push-to-talk key is stuck.	
COM1 RMT XFR – COM1 remote transfer key is stuck.	The COM1 and/or COM2 transfer switch is stuck in the enabled (or “pressed”) position. Press the transfer switch again to cycle its operation. If the problem persists, the G1000 system should be serviced.
COM2 RMT XFR – COM2 remote transfer key is stuck.	

GIA 63W MESSAGE ADVISORIES (CONT.)

Message	Comments
LOI – GPS integrity lost. Crosscheck with other NAVS.	GPS integrity is insufficient for the current phase of flight.
GPS NAV LOST – Loss of GPS navigation. Insufficient satellites.	Loss of GPS navigation due to insufficient satellites.
GPS NAV LOST – Loss of GPS navigation. Position error.	Loss of GPS navigation due to position error.
GPS NAV LOST – Loss of GPS navigation. GPS fail.	Loss of GPS navigation due to GPS failure.
ABORT APR – Loss of GPS navigation. Abort approach.	Abort approach due to loss of GPS navigation.
APR DWNGRADE – Approach downgraded.	Vertical guidance generated by SBAS is unavailable, use LNAV only minimums.
TRUE APR – True north approach. Change HDG reference to TRUE.	Displayed after passing the first waypoint of a true north approach when the nav angle is set to 'AUTO'.
GPS1 SERVICE – GPS1 needs service. Return unit for repair.	A failure has been detected in the GPS1 and/or GPS2 receiver. The receiver may still be available. The G1000 system should be serviced.
GPS2 SERVICE – GPS2 needs service. Return unit for repair.	
NAV1 SERVICE – NAV1 needs service. Return unit for repair.	A failure has been detected in the NAV1 and/or NAV2 receiver. The receiver may still be available. The G1000 system should be serviced.
NAV2 SERVICE – NAV2 needs service. Return unit for repair.	
NAV1 RMT XFR – NAV1 remote transfer key is stuck.	The remote NAV1 and/or NAV2 transfer switch is stuck in the enabled (or “pressed”) state. Press the transfer switch again to cycle its operation. If the problem persists, the G1000 system should be serviced.
NAV2 RMT XFR – NAV2 remote transfer key is stuck.	
G/S1 FAIL – G/S1 is inoperative.	A failure has been detected in glideslope receiver 1 and/or receiver 2. The G1000 system should be serviced.
G/S2 FAIL – G/S2 is inoperative.	
G/S1 SERVICE – G/S1 needs service. Return unit for repair.	A failure has been detected in glideslope receiver 1 and/or receiver 2. The receiver may still be available. The G1000 system should be serviced when possible.
G/S2 SERVICE – G/S2 needs service. Return unit for repair.	

GEA 71 MESSAGE ADVISORIES

Message	Comments
GEA1 CONFIG – GEA1 config error. Config service req'd.	The GEA1 configuration settings do not match those of backup configuration memory. The G1000 system should be serviced.
GEA2 CONFIG – GEA2 config error. Config service req'd.	The GEA2 configuration settings do not match those of backup configuration memory. The G1000 system should be serviced.
MANIFEST – GEA1 software mismatch, communication halted.	The #1 GEA 71 has incorrect software installed. The G1000 system should be serviced.
MANIFEST – GEA2 software mismatch, communication halted.	The #2 GEA 71 has incorrect software installed. The G1000 system should be serviced.

GTX 33 & GTX 33D MESSAGE ADVISORIES

Message	Comments
XPDR1 CONFIG – XPDR1 config error. Config service req'd.	The transponder configuration settings do not match those of backup configuration memory. The G1000 system should be serviced.
XPDR2 CONFIG – XPDR2 config error. Config service req'd.	The transponder configuration settings do not match those of backup configuration memory. The G1000 system should be serviced.
MANIFEST – GTX1 software mismatch, communication halted.	The transponder has incorrect software installed. The G1000 system should be serviced.
MANIFEST – GTX2 software mismatch, communication halted.	The transponder has incorrect software installed. The G1000 system should be serviced.
XPDR1 SRVC – XPDR1 needs service. Return unit for repair.	The #1 transponder should be serviced when possible.
XPDR2 SRVC – XPDR2 needs service. Return unit for repair.	The #2 transponder should be serviced when possible.
XPDR1 FAIL – XPDR1 is inoperative.	There is no communication with the #1 transponder.
XPDR2 FAIL – XPDR2 is inoperative.	There is no communication with the #2 transponder.

GRS 77 MESSAGE ADVISORIES

Message	Comments
AHRS1 TAS – AHRS1 not receiving airspeed.	The #1 AHRS is not receiving true airspeed from the air data computer. The AHRS relies on GPS information to augment the lack of airspeed. The G1000 system should be serviced.
AHRS2 TAS – AHRS2 not receiving airspeed.	The #2 AHRS is not receiving true airspeed from the air data computer. The AHRS relies on GPS information to augment the lack of airspeed. The G1000 system should be serviced.
AHRS1 GPS – AHRS1 using backup GPS source.	The #1 AHRS is using the backup GPS path. Primary GPS path has failed. The G1000 system should be serviced when possible.
AHRS2 GPS – AHRS2 using backup GPS source.	The #2 AHRS is using the backup GPS path. Primary GPS path has failed. The G1000 system should be serviced when possible.
AHRS1 GPS – AHRS1 not receiving any GPS information.	The #1 AHRS is not receiving any or any useful GPS information. Check AFMS limitations. The G1000 system should be serviced.

GRS 77 MESSAGE ADVISORIES (CONT.)

Message	Comments
AHRS2 GPS – AHRS2 not receiving any GPS information.	The #2 AHRS is not receiving any or any useful GPS information. Check AFMS limitations. The G1000 system should be serviced.
AHRS1 GPS – AHRS1 not receiving backup GPS information.	The #1 AHRS is not receiving backup GPS information. The G1000 system should be serviced.
AHRS2 GPS – AHRS2 not receiving backup GPS information.	The #2 AHRS is not receiving backup GPS information. The G1000 system should be serviced.
AHRS1 GPS – AHRS1 operating exclusively in no-GPS mode.	The #1 AHRS is operating exclusively in no-GPS mode. The G1000 system should be serviced.
AHRS2 GPS – AHRS2 operating exclusively in no-GPS mode.	The #2 AHRS is operating exclusively in no-GPS mode. The G1000 system should be serviced.
AHRS MAG DB – AHRS magnetic model database version mismatch.	The #1 AHRS and #2 AHRS magnetic model database versions do not match.
AHRS1 SRVC – AHRS1 Magnetic-field model needs update.	The #1 AHRS earth magnetic field model is out of date. Update magnetic field model when practical.
AHRS2 SRVC – AHRS2 Magnetic-field model needs update.	The #2 AHRS earth magnetic field model is out of date. Update magnetic field model when practical.
GEO LIMITS – AHRS1 too far North/South, no magnetic compass.	The aircraft is outside geographical limits for approved AHRS operation. Heading is flagged as invalid.
GEO LIMITS – AHRS2 too far North/South, no magnetic compass.	
MANIFEST – GRS1 software mismatch, communication halted.	The #1 AHRS has incorrect software installed. The G1000 system should be serviced.
MANIFEST – GRS2 software mismatch, communication halted.	The #2 AHRS has incorrect software installed. The G1000 system should be serviced.

GMU 44 MESSAGE ADVISORIES

Message	Comments
HDG FAULT – AHRS1 magnetometer fault has occurred.	A fault has occurred in the #1 GMU 44. Heading is flagged as invalid. The AHRS uses GPS for backup mode operation. The G1000 system should be serviced.
HDG FAULT – AHRS2 magnetometer fault has occurred.	A fault has occurred in the #2 GMU 44. Heading is flagged as invalid. The AHRS uses GPS for backup mode operation. The G1000 system should be serviced.
MANIFEST – GMU1 software mismatch, communication halted.	The GMU 44 has incorrect software installed. The G1000 system should be serviced.
MANIFEST – GMU2 software mismatch, communication halted.	

GSR 56 MESSAGE ADVISORIES

Message	Comments
GSR1 FAIL – GSR1 has failed.	A failure has been detected in the #1 GSR 56. The system should be serviced.

GDL 69A MESSAGE ADVISORIES

Message	Comments
GDL69 CONFIG – GDL 69 config error. Config service req'd.	GDL 69 configuration settings do not match those of backup configuration memory. The G1000 system should be serviced.
GDL69 FAIL – GDL 69 has failed.	A failure has been detected in the GDL 69. The receiver is unavailable. The G1000 system should be serviced.
MANIFEST – GDL software mismatch, communication halted.	The GDL 69 has incorrect software installed. The G1000 system should be serviced.

GWX 68 MESSAGE ADVISORIES

Message	Comments
GWX CONFIG – GWX config error. Config service req'd.	GWX 68 configuration settings do not match those of the GDU configuration. The G1000 system should be serviced.
GWX FAIL – GWX is inoperative.	The GDU is not receiving status packet from the GWX 68 or the GWX 68 is reporting a fault. The GWX 68 radar system should be serviced.
GWX SERVICE – GWX needs service. Return unit for repair.	A failure has been detected in the GWX 68. The GWX 68 may still be usable.
WX ALERT – Possible severe weather ahead.	The GWX 68 indicates severe weather within $\pm 10^\circ$ of the aircraft heading at a range of 80 to 320 nm.
MANIFEST – GWX software mismatch, communication halted.	The GWX 68 has incorrect software installed. The G1000 system should be serviced.

GDC 74B MESSAGE ADVISORIES

Message	Comments
ADC1 ALT EC – ADC1 altitude error correction is unavailable.	GDC1 or GDC2 is reporting that the altitude error correction is unavailable.
ADC2 ALT EC – ADC2 altitude error correction is unavailable.	
ADC1 AS EC – ADC1 airspeed error correction is unavailable.	GDC1 or GDC2 is reporting that the airspeed error correction is unavailable.
ADC2 AS EC – ADC2 airspeed error correction is unavailable.	
MANIFEST – GDC1 software mismatch, communication halted.	The GDC 74B has incorrect software installed. The G1000 system should be serviced.
MANIFEST – GDC2 software mismatch, communication halted.	

GTS 820 MESSAGE ADVISORIES

Message	Comments
GTS CONFIG – GTS config error. Config service req'd.	The GTS and GDU have incompatible configurations. This alert is also set when the GTS has an invalid mode S address configured or the mode S address does not match both XPDR mode S addresses.
MANIFEST – GTS software mismatch, communication halted.	The GTS has incorrect software installed. The G1000 system should be serviced.

GCU 475 MESSAGE ADVISORIES

Message	Comments
GCU CNFG – GCU Config error. Config service req'd.	GCU 475 configuration settings do not match those of backup configuration memory. The G1000 system should be serviced.
GCU FAIL – GCU is inoperative.	A failure has been detected in the GCU 475. The GCU 475 is unavailable.
MANIFEST – GCU software mismatch, communication halted.	The GCU 475 has incorrect software installed. The G1000 system should be serviced.
GCU KEYSTK – GCU [key name] Key is stuck.	A key is stuck on the GCU 475 bezel. Attempt to free the stuck key by pressing it several times. The G1000 system should be serviced if the problem persists.

GMC 710 MESSAGE ADVISORIES

Message	Comments
GMC CONFIG – GMC Config error. Config service req'd.	Error in the configuration of the GMC 710.
GMC FAIL – GMC is inoperative.	A failure has been detected in the GMC 710. The GMC 710 is unavailable.
MANIFEST – GMC software mismatch. Communication halted.	The GMC 710 has incorrect software installed. The G1000 system should be serviced.
GMC KEYSTK – GMC [key name] Key is stuck.	A key is stuck on the GMC 710 bezel. Attempt to free the stuck key by pressing it several times. The G1000 system should be serviced if the problem persists.

MISCELLANEOUS MESSAGE ADVISORIES

Message	Comments
FPL WPT LOCK – Flight plan waypoint is locked.	Upon power-up, the G1000 system detects that a stored flight plan waypoint is locked. This occurs when a navigation database update eliminates an obsolete waypoint. The flight plan cannot find the specified waypoint and flags this message. This can also occur with user waypoints in a flight plan that is deleted. Remove the waypoint from the flight plan if it no longer exists in any database, Or update the waypoint name/identifier to reflect the new information.
FPL WPT MOVE – Flight plan waypoint moved.	The system has detected that a waypoint coordinate has changed due to a new navigation database update. Verify that stored flight plans contain correct waypoint locations.
TIMER EXPIRD – Timer has expired.	The system notifies the pilot that the timer has expired.

MISCELLANEOUS MESSAGE ADVISORIES (CONT.)

Message	Comments
DB CHANGE – Database changed. Verify user modified procedures.	This occurs when a stored flight plan contains procedures that have been manually edited. This alert is issued only after a navigation database update. Verify that the user-modified procedures in stored flight plans are correct and up to date.
DB CHANGE – Database changed. Verify stored airways.	This occurs when a stored flight plan contains an airway that is no longer consistent with the navigation database. This alert is issued only after a navigation database update. Verify use of airways in stored flight plans and reload airways as needed.

MISCELLANEOUS MESSAGE ADVISORIES (CONT.)

Message	Comments
FPL TRUNC – Flight plan has been truncated.	This occurs when a newly installed navigation database eliminates an obsolete approach or arrival used by a stored flight plan. The obsolete procedure is removed from the flight plan. Update flight plan with current arrival or approach.
LOCKED FPL – Cannot navigate locked flight plan.	This occurs when the pilot attempts to activate a stored flight plan that contains locked waypoint. Remove locked waypoint from flight plan. Update flight plan with current waypoint.
WPT ARRIVAL – Arriving at waypoint -[xxxx]	Arriving at waypoint [xxxx], where [xxxx] is the waypoint name.
STEEP TURN – Steep turn ahead.	A steep turn is 15 seconds ahead. Prepare to turn.
INSIDE ARSPC – Inside airspace.	The aircraft is inside the special use airspace.
ARSPC AHEAD – Airspace ahead less than 10 minutes.	Special use airspace is ahead of aircraft. The aircraft will penetrate the airspace within 10 minutes.
ARSPC NEAR – Airspace near and ahead.	Special use airspace is near and ahead of the aircraft position.
ARSPC NEAR – Airspace near – less than 2 nm.	Special use airspace is within 2 nm of the aircraft position.
APR INACTV – Approach is not active.	The system notifies the pilot that the loaded approach is not active. Activate approach when required.
SLCT FREQ – Select appropriate frequency for approach.	The system notifies the pilot to load the approach frequency for the appropriate NAV receiver. Select the correct frequency for the approach.
SLCT NAV – Select NAV on CDI for approach.	The system notifies the pilot to set the CDI to the correct NAV receiver. Set the CDI to the correct NAV receiver.
PTK FAIL – Parallel track unavailable: bad geometry.	Bad parallel track geometry.
PTK FAIL – Parallel track unavailable: invalid leg type.	Invalid leg type for parallel offset.
PTK FAIL – Parallel track unavailable: past IAF.	IAF waypoint for parallel offset has been passed.
UNABLE V WPT – Can't reach current vertical waypoint.	The current vertical waypoint can not be reached within the maximum flight path angle and vertical speed constraints. The system automatically transitions to the next vertical waypoint.
VNV – Unavailable. Unsupported leg type in flight plan.	The lateral flight plan contains a procedure turn, vector, or other unsupported leg type prior to the active vertical waypoint. This prevents vertical guidance to the active vertical waypoint.
VNV – Unavailable. Excessive track angle error.	The current track angle error exceeds the limit, causing the vertical deviation to go invalid.
VNV – Unavailable. Excessive crosstrack error.	The current crosstrack exceeds the limit, causing vertical deviation to go invalid.
VNV – Unavailable. Parallel course selected.	A parallel course has been selected, causing the vertical deviation to go invalid.
TRAFFIC FAIL – Traffic device has failed.	The G1000 is no longer receiving data from the traffic system. The traffic device should be serviced.

MISCELLANEOUS MESSAGE ADVISORIES (CONT.)

Message	Comments
NON WGS84 WPT – Do not use GPS for navigation to [xxxx]	The position of the selected waypoint [xxxx] is not calculated based on the WGS84 map reference datum and may be positioned in error as displayed. Do not use GPS to navigate to the selected non-WGS84 waypoint.
STRMSCP FAIL – Stormscope has failed.	Stormscope has failed. The G1000 system should be serviced.
FAILED PATH – A data path has failed.	A data path connected to the GDU or the GIA 63/W has failed.
MAG VAR WARN – Large magnetic variance. Verify all course angles.	The GDU's internal model cannot determine the exact magnetic variance for geographic locations near the magnetic poles. Displayed magnetic course angles may differ from the actual magnetic heading by more than 2°.
SVS – SVS DISABLED: Out of available terrain region.	Synthetic Vision is disabled because the aircraft is not within the boundaries of the installed terrain database.
SVS – SVS DISABLED: Terrain DB resolution too low.	Synthetic Vision is disabled because a terrain database of sufficient resolution (9 arc-second or better) is not currently installed.
SCHEDULER [#] – <message>.	Message criteria entered by the user.
CHECK CRS – Database course for LOC1 / [LOC ID] is [CRS]°.	Selected course for LOC1 differs from published localizer course by more than 10 degrees.
CHECK CRS – Database course for LOC2 / [LOC ID] is [CRS]°.	Selected course for LOC2 differs from published localizer course by more than 10 degrees.
[PFD1, PFD2, or MFD1] CARD 1 REM – Card 1 was removed. Reinsert card.	The SD card was removed from the top card slot of the PFD or MFD. The SD card needs to be reinserted.
[PFD1, PFD2, or MFD1] CARD 2 REM – Card 2 was removed. Reinsert card.	The SD card was removed from the bottom card slot of the PFD or MFD. The SD card needs to be reinserted.
[PFD1, PFD2, or MFD1] CARD 1 ERR – Card 1 is invalid.	The SD card in the top card slot of the PFD or MFD contains invalid data.
[PFD1, PFD2, or MFD1] CARD 2 ERR – Card 2 is invalid.	The SD card in the bottom card slot of the PFD or MFD contains invalid data.
ECS – Service required.	The Environmental Control System has failed.
EPS – Service required.	The EPS option has been installed on an aircraft without the EPS system. Software baseline and appropriate options shall be reloaded.
EPS – S/G speed sensor failed.	The EPS option has been installed on an aircraft without the EPS system. Software baseline and appropriate options shall be reloaded.
CRUISE I – Cruise I conditions met.	Cruise I engine trend data log has been captured.
CRUISE II – Cruise II conditions met.	Cruise II engine trend data log has been captured.
EXCEEDANCE – Engine exceedance data is being logged.	An engine exceedance log has been captured.
REGISTER GFDS – Data services are inoperative, register w/GFDS.	The system is not registered with Garmin Flight Data Services, or its current registration data has failed authentication.
TRN AUD FAIL – Trn Awareness audio source unavailable.	The audio source for terrain awareness is offline. Check GIA1 or GIA 2.
TERRAIN AUD CFG – Trn Awareness audio config error. Service req'd.	Terrain audio alerts are not configured properly. The system should be serviced

AFCS ALERTS

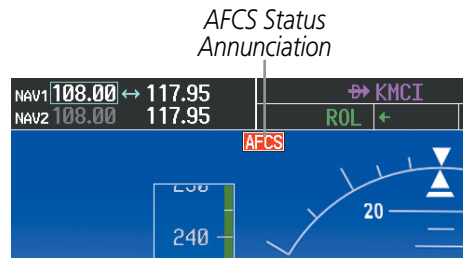

Figure A-5 AFCS Status Annunciation

The following alert annunciations appear in the AFCS System Status field on the PFD.

Alert Condition	Annunciation	Description
Rudder Mistrim Right		Yaw servo providing sustained force in the indicated direction. Aircraft rudder retrim after substantial pitch and power changes required.
Rudder Mistrim Left		
Aileron Mistrim Right		Roll servo providing sustained force in the indicated direction
Aileron Mistrim Left		
Elevator Mistrim Down		Pitch servo providing sustained force in the indicated direction. May indicate a failure of the pitch trim servo or trim system.
Elevator Mistrim Up		
Pitch Trim Failure (or stuck MEPT Switch)		If AP engaged, take control of the aircraft and disengage AP If AP disengaged, move MEPT switches separately to unstick
Yaw Trim Failure (or stuck MEYT Switch)		If AP engaged, take control of the aircraft and disengage AP If AP disengaged, move the MEYT switch to check if a stuck switch is causing the annunciation
Yaw Damper Failure		YD control failure; AP also inoperative
Roll Failure		Roll axis control failure; AP inoperative
Pitch Failure		Pitch axis control failure; AP inoperative
System Failure		AP and MEPT are unavailable; FD may still be available
Preflight Test		Performing preflight system test; aural alert sounds at completion Do not press the AP DISC Switch during servo power-up and preflight system tests as this may cause the preflight system test to fail or never to start (if servos fail their power-up tests). Power must be cycled to the servos to remedy the situation.
		Preflight system test failed; aural alert sounds at failure



NOTE: Do not press the **AP DISC** switch during servo power-up and preflight system tests as this may cause the preflight system test to fail or never to start (if servos fail their power-up tests). Power must be cycled to the servos to remedy the situation.

TERRAIN-SVS ALERTS

Alert Type	PFD/MFD TERRAIN-SVS Page Annunciation	MFD Pop-Up Alert	Aural Message
Reduced Required Terrain Clearance Warning (RTC)	TERRAIN	WARNING - TERRAIN	"Warning; Terrain, Terrain"
Imminent Terrain Impact Warning (ITI)	TERRAIN	WARNING - TERRAIN	"Warning; Terrain, Terrain"
Reduced Required Obstacle Clearance Warning (ROC)	TERRAIN	WARNING - OBSTACLE	"Warning; Obstacle, Obstacle"
Imminent Obstacle Impact Warning (IOI)	TERRAIN	WARNING - OBSTACLE	"Warning; Obstacle, Obstacle"
Reduced Required Terrain Clearance Caution (RTC)	TERRAIN	CAUTION - TERRAIN	"Caution; Terrain, Terrain"
Imminent Terrain Impact Caution (ITI)	TERRAIN	CAUTION - TERRAIN	"Caution; Terrain, Terrain"
Reduced Required Obstacle Clearance Caution (ROC)	TERRAIN	CAUTION - OBSTACLE	"Caution; Obstacle, Obstacle"
Imminent Obstacle Impact Caution (IOI)	TERRAIN	CAUTION - OBSTACLE	"Caution; Obstacle, Obstacle"

TERRAIN-SVS SYSTEM STATUS ANNUNCIATIONS

Alert Type	PFD/MFD Alert Annunciation	TERRAIN-SVS Page Annunciation	Aural Message
System Test in Progress	TER TEST	TERRAIN TEST	None
System Test Pass	None	None	"Terrain System Test OK"
Terrain Alerting is disabled	TER INH	None	None
MFD Terrain or Obstacle database unavailable or invalid. Terrain-SVS operating with PFD Terrain or Obstacle databases	None	TERRAIN DATABASE FAILURE	None
Terrain System Test Fail	TER FAIL	TERRAIN FAIL	"Terrain System Failure"
Terrain or Obstacle database unavailable or invalid, invalid software configuration, system audio fault	TER FAIL	TERRAIN FAIL	"Terrain System Failure"
No GPS position	TER N/A	NO GPS POSITION	"Terrain System Not Available"
Excessively degraded GPS signal, Out of database coverage area	TER N/A	None	"Terrain System Not Available"
Sufficient GPS signal received after loss	None	None	"Terrain System Available"

TAWS-B ALERTS

Annunciations appear on the PFD and MFD. Pop-up alerts appear only on the MFD.

Alert Type	PFD/MFD TAWS Page Annunciation	MFD Map Page Pop-Up Alert	Aural Message
Excessive Descent Rate Warning (EDR)	PULL UP	PULL-UP	"Pull Up"
Reduced Required Terrain Clearance Warning (RTC)	PULL UP	TERRAIN - PULL-UP or TERRAIN AHEAD - PULL-UP	"Terrain, Terrain; Pull Up, Pull Up" or "Terrain Ahead, Pull Up; Terrain Ahead, Pull Up"
Imminent Terrain Impact Warning (ITI)	PULL UP	TERRAIN AHEAD - PULL-UP or TERRAIN - PULL-UP	Terrain Ahead, Pull Up; Terrain Ahead, Pull Up" or "Terrain, Terrain; Pull Up, Pull Up"
Reduced Required Obstacle Clearance Warning (ROC)	PULL UP	OBSTACLE - PULL-UP or OBSTACLE AHEAD - PULL-UP	"Obstacle, Obstacle; Pull Up, Pull Up" or "Obstacle Ahead, Pull Up; Obstacle Ahead, Pull Up"
Imminent Obstacle Impact Warning (IOI)	PULL UP	OBSTACLE AHEAD - PULL-UP or OBSTACLE - PULL-UP	"Obstacle Ahead, Pull Up; Obstacle Ahead, Pull Up" or "Obstacle, Obstacle; Pull Up, Pull Up"
Reduced Required Terrain Clearance Caution (RTC)	TERRAIN	CAUTION - TERRAIN or TERRAIN AHEAD	"Caution, Terrain; Caution, Terrain" or "Terrain Ahead; Terrain Ahead"
Imminent Terrain Impact Caution (ITI)	TERRAIN	TERRAIN AHEAD or CAUTION - TERRAIN	"Terrain Ahead; Terrain Ahead" or "Caution, Terrain; Caution, Terrain"
Reduced Required Obstacle Clearance Caution (ROC)	TERRAIN	CAUTION - OBSTACLE or OBSTACLE AHEAD	"Caution, Obstacle; Caution, Obstacle" or "Obstacle Ahead; Obstacle Ahead"
Imminent Obstacle Impact Caution (IOI)	TERRAIN	OBSTACLE AHEAD or CAUTION - OBSTACLE	"Obstacle Ahead; Obstacle Ahead" or "Caution, Obstacle; Caution, Obstacle"
Premature Descent Alert Caution (PDA)	TERRAIN	TOO LOW - TERRAIN	"Too Low, Terrain"
Altitude Callout "500"	None	None	"Five-Hundred"
Excessive Descent Rate Caution (EDR)	TERRAIN	SINK RATE	"Sink Rate"
Negative Climb Rate Caution (NCR)	TERRAIN	DON'T SINK or TOO LOW - TERRAIN	"Don't Sink" or "Too Low, Terrain"

TAWS-B SYSTEM STATUS ANNUNCIATIONS

Alert Type	PFD/MFD Alert Annunciation	TAWS-B Page Annunciation	Aural Message
System Test in Progress	TAWS TEST	TAWS TEST	None
System Test Pass	None	None	"TAWS System Test OK"
TAWS Alerting is disabled	TAWS INH	None	None
MFD Terrain or Obstacle database unavailable or invalid. TAWS operating with PFD Terrain or Obstacle databases	None	TERRAIN DATABASE FAILURE	None
TAWS-B System Test Fail	TAWS FAIL	TAWS FAIL	"TAWS System Failure"
Terrain or Obstacle database unavailable or invalid, invalid software configuration, system audio fault	TAWS FAIL	TAWS FAIL	"TAWS System Failure"
No GPS position	TAWS N/A	NO GPS POSITION	"TAWS Not Available"
Excessively degraded GPS signal, Out of database coverage area	TAWS N/A	None	"TAWS Not Available"
Sufficient GPS signal received after loss	None	None	"TAWS Available"

OTHER G1000 AURAL ALERTS

Voice Alert	Description
"Minimums, minimums"	The aircraft has descended below the preset barometric minimum descent altitude.
"Vertical track"	The aircraft is one minute from Top of Descent. Issued only when vertical navigation is enabled.
"Airspeed, Airspeed"	Played when the indicated airspeed is below a given threshold for a given aircraft configuration. Note this alert may be heard under normal conditions during the landing flare.
"Traffic"	Played when a Traffic Advisory (TA) is issued with the TIS system.
"Traffic Not Available"	The aircraft is outside the Traffic Information Service (TIS) coverage area.
"Traffic, Traffic"	Played when a Traffic Advisory (TA) is issued with a TAS system.
"TAS System Test OK"	Played when the TAS system passes a pilot-initiated self test.
"TAS System Test Failed"	Played when the TAS system fails a pilot-initiated self test.
"One o'clock" through "Twelve o'clock" or "No Bearing"	Played to indicate bearing of traffic from own aircraft (GTS 820 only).
"High", "Low", "Same Altitude" (if within 200 feet of own altitude), or "Altitude not available"	Played to indicate altitude of traffic relative to own aircraft (GTS 820 only).
"Less than one mile", "One Mile" through "Ten Miles", or "More than ten miles"	Played to indicate distance of traffic from own aircraft (GTS 820 only).

FLIGHT PLAN IMPORT/EXPORT MESSAGES

In some circumstances, some messages may appear in conjunction with others.

Flight Plan Import/Export Results	Description
'Flight plan successfully imported.'	A flight plan file stored on the SD card was successfully imported as a stored flight plan.
'File contained user waypoints only. User waypoints imported successfully. No stored flight plan data was modified.'	The file stored on the SD card did not contain a flight plan, only user waypoints. These waypoints have been saved to the system user waypoints. No flight plans stored in the system have been modified.
'No flight plan files found to import.'	The SD card contains no flight plan data.
'Flight plan import failed.'	Flight plan data was not successfully imported from the SD card.
'Flight plan partially imported.'	Some flight plan waypoints were successfully imported from the SD card, however others had errors and were not imported. A partial stored flight plan now exists in the system.
'File contained user waypoints only.'	The file stored on the SD card did not contain a flight plan, only user waypoints. One or more of these waypoints did not import successfully.
'Too many points. Flight plan truncated.'	The flight plan on the SD card contains more waypoints than the system can support. The flight plan was imported with as many waypoints as possible.
'Some waypoints not loaded. Waypoints locked.'	The flight plan on the SD card contains one or more waypoints that the system cannot find in the navigation database. The flight plan has been imported, but must be edited within the system before it can be activated for use.
'User waypoint database full. Not all loaded.'	The flight plan file on the SD card contains user waypoints. The quantity of stored user waypoints has exceeded system capacity, therefore not all the user waypoints on the SD card have been imported. Any flight plan user waypoints that were not imported are locked in the flight plan. The flight plan must be edited within the system before it can be activated for use.
'One or more user waypoints renamed.'	One or more imported user waypoints were renamed when imported due to naming conflicts with waypoints already existing in the system.
'Flight plan successfully exported.'	The stored flight plan was successfully exported to the SD card.
'Flight plan export failed.'	The stored flight plan was not successfully exported to the SD card. The SD card may not have sufficient available memory or the card may have been removed prematurely.

DATABASE MANAGEMENT



CAUTION: Never disconnect power to the system when loading a database. Power interruption during the database loading process could result in maintenance being required to reboot the system.

The system uses Secure Digital (SD) cards to load and store various types of data. For basic flight operations, SD cards are required for database storage as well as Jeppesen navigation and ChartView database updates. Not all SD cards are compatible with the G1000. Use only SD cards supplied by Garmin or the aircraft manufacturer.



CAUTION: When downloading updates to the Jeppesen Navigation Database, copy the data to an SD card other than a Garmin Supplemental Data Card. Otherwise, data corruption can occur.



NOTE: When loading database updates, the 'DB Mismatch' message will be displayed until database synchronization is complete, followed by turning system power off, then on. Synchronization can be monitored on the AUX-SYSTEM STATUS Page.



NOTE: Loading a database in the system prior to its effective date will result in the expiration date on the power-up screen and the effective date on the AUX-System Status Page being displayed in yellow.



NOTE: Garmin requests the flight crew report any observed discrepancies related to database information. These discrepancies could come in the form of an incorrect procedure; incorrectly identified terrain, obstacles and fixes; or any other displayed item used for navigation or communication in the air or on the ground. Go to FlyGarmin.com and select "Aviation Data Error Report".

JEPPESEN DATABASES

The Jeppesen navigation database is updated on a 28-day cycle. The ChartView database is updated on a 14-day cycle. If the ChartView database is not updated within 70 days of the expiration date, ChartView will no longer function. Both of these databases are provided directly from Jeppesen.



NOTE: The Jeppesen aviation navigation database is now referred to as the 'navigation database'. Previously this database had been referred to as the 'aviation database'.

The ChartView database should be copied to the Garmin supplied Supplemental Data Card which will reside in the bottom card slot on the MFD. The navigation database must be installed from the Jeppesen or user supplied SD data card. Contact Jeppesen (www.jeppesen.com) for subscription and update information.



NOTE: After the navigation database is installed, the card may be removed.

Updating the active Jeppesen navigation database (not using the Dual Navigation Database or Automatic Database Synchronization Features):

- 1) With the system OFF, insert the SD card containing the new navigation database version into the top card slot of the display (PFD1, PFD2 or MFD) to be updated (label of SD card facing left).
- 2) Turn the system ON. A prompt similar to the following is displayed in the upper left corner of the display:

```
DO YOU WANT TO UPDATE THE STANDBY NAVIGATION DATABASE ON THE BOTTOM CARD?
THE STANDBY DATABASE WILL BE ACTIVATED UPON THE FIRST ON-GROUND POWER CYCLE ON OR
AFTER 00:00 SYSTEM TIME ON THE EFFECTIVE DATE.
FROM TO
REGION: WORLDWIDE WORLDWIDE
CYCLE: 0904 0905
EFFECTIVE: 09-APR-2009 07-MAY-2009
EXPIRES: 07-MAY-2009 04-JUN-2009
NO WILL BE ASSUMED IN 21 SECONDS.
```

Figure B-1 Standby Navigation Database Prompt

- 3) Press the **NO** Softkey to proceed to loading the active database.
- 4) A prompt similar to the following is displayed, press the **YES** Softkey to update the active navigation database.

```
DO YOU WANT TO UPDATE THE ACTIVE NAVIGATION DATABASE?
SELECTING YES WILL OVERWRITE THE ACTIVE NAVIGATION DATABASE.
FROM TO
REGION: WORLDWIDE WORLDWIDE
CYCLE: 0904 0905
EFFECTIVE: 09-APR-2009 07-MAY-2009
EXPIRES: 07-MAY-2009 04-JUN-2009
NO WILL BE ASSUMED IN 8 SECONDS.
UPDATING THE ACTIVE NAVIGATION DATABASE, PLEASE WAIT.
.
UPDATED 1 FILES SUCCESSFULLY!
PRESS ANY KEY TO CONTINUE.
CONTINUING IN 8 SECONDS.
```

Figure B-2 Database Update Confirmation

- 5) After the update completes, the display starts in normal mode. Do not remove power while the display is starting.
- 6) Turn the system OFF and remove the SD card from the top card slot.
- 7) Repeat steps 1 through 6 for the other displays (PFD1, PFD2 or MFD). Remove the SD card when finished.
- 8) Apply power to the system and press the **ENT** Key to acknowledge the startup screen.
- 9) Turn the large **FMS** Knob to select the AUX Page group on the MFD.
- 10) Turn the small **FMS** Knob to select the System Status Page.
- 11) Press the Display Database Selection Softkey to show active navigation database information for each display (**MFD1 DB, PFD1 DB, PFD2 DB**). Verify the correct active navigation database cycle information is shown for each display.

DUAL NAVIGATION DATABASE FEATURE

The dual navigation database feature allows each display to store an upcoming navigation database on the bottom SD card so that the system can automatically load it to replace the active database when the new database becomes effective (the next cycle becomes available seven days prior to its effective date).

If a navigation database loader card is inserted into the top SD card slot of a display, and an SD card is in the bottom slot, the system will prompt the user (upon on-ground power up) as to whether the database should be stored on the bottom SD card as the standby database. If the user responds affirmatively, the system will copy the navigation database from the top SD card to the bottom SD card. As long as the bottom SD card remains in the card slot, this standby navigation database will be available for the system to use as the active database as soon as it becomes effective.

The system checks the active and standby databases upon (on-ground only) power-up. If the standby database is current and the active database is out of date, the display will upload the standby database into the active internal database location. Uploading the standby database to the active location takes approximately 45-55 seconds. The pilot is alerted that the update is complete by a system alert message, 'NAV DB UPDATED'.

Loading a standby navigation database:

- 1) With the system OFF, insert the SD card containing the new navigation database version into the top card slot of the MFD.
- 2) Verify that an SD card is inserted in the bottom slot of each PFD and the MFD.
- 3) Turn the system ON. A prompt similar to the following is displayed.

```
DO YOU WANT TO UPDATE THE STANDBY NAVIGATION DATABASE ON THE BOTTOM CARD?
THE STANDBY DATABASE WILL BE ACTIVATED UPON THE FIRST ON-GROUND POWER CYCLE ON OR
AFTER 00:00 SYSTEM TIME ON THE EFFECTIVE DATE.
FROM TO
REGION: WORLDWIDE WORLDWIDE
CYCLE: 0904 0905
EFFECTIVE: 09-APR-2009 07-MAY-2009
EXPIRES: 07-MAY-2009 04-JUN-2009
NO WILL BE ASSUMED IN 21 SECONDS.
```

Figure B-3 Standby Navigation Database Prompt

- 4) Press the **YES** Softkey. The navigation database is copied to the SD card in the bottom card slot of the MFD.
- 5) After the navigation database files are copied to the bottom SD card, the display will appear as shown in Figure B-4.

```
INITIALIZING SYSTEM
DO YOU WANT TO UPDATE THE STANDBY NAVIGATION DATABASE ON THE BOTTOM CARD?
THE STANDBY DATABASE WILL BE ACTIVATED UPON THE FIRST ON-GROUND POWER CYCLE ON OR
AFTER 00:00 SYSTEM TIME ON THE EFFECTIVE DATE.
FROM TO
REGION: WORLDWIDE WORLDWIDE
CYCLE: 1009 1012
EFFECTIVE: 26-AUG-2010 18-NOV-2010
EXPIRES: 23-SEP-2010 16-DEC-2010
NO WILL BE ASSUMED IN 18 SECONDS.
UPDATING STANDBY NAVIGATION DATABASE, PLEASE WAIT.
.
UPDATED STANDBY NAVIGATION DATABASE SUCCESSFULLY.
PRESS ANY KEY TO CONTINUE.
CONTINUING IN 9 SECONDS.
```

Figure B-4 Standby Navigation Database Update Complete

- 6) As instructed on the display, press any key to continue. The display will now appear as shown in Figure B-5.

```

DATABASE NAVIGATION WILL BE VERIFIED BEFORE USE.
DATABASE STANDBY NAV WILL BE VERIFIED BEFORE USE.
PRESS ANY KEY TO CONTINUE.
CONTINUING IN 6 SECONDS.

```

Figure B-5 Navigation Database Verification Prompt

- 7) Press any key to continue. The display will now appear as shown in Figure B-6.

```

*
DO YOU WANT TO UPDATE THE ACTIVE NAVIGATION DATABASE?
SELECTING YES WILL OVERWRITE THE ACTIVE NAVIGATION DATABASE.
REGION:      FROM          TO
CYCLE:       0904           0905
EFFECTIVE:   09-APR-2009      07-MAY-2009
EXPIRES:     07-MAY-2009      04-JUN-2009
NO WILL BE ASSUMED IN 8 SECONDS.

```

Figure B-6 Active Navigation Database Prompt

- 8) Press the **NO** Softkey. The display now starts in normal mode. Since the database effective date is not yet valid, it should not be loaded as the active database. The display now starts in normal mode. Do not remove power while the display is starting.
- 9) Press the **ENT** Key to acknowledge the startup screen.
- 10) Turn the large **FMS** Knob to select the AUX Page group on the MFD.
- 11) Turn the small **FMS** Knob to select the System Status Page.
- 12) The new database is copied to the SD card in the bottom card slot of each PFD. Progress can be monitored in the SYNC STATUS field. When copying is finished, 'Complete' is displayed.
- 13) Turn system power OFF.
- 14) Remove the SD card from the top card slot of the MFD.
- 15) Turn system power ON.
- 16) Press the **ENT** Key to acknowledge the startup screen.
- 17) Turn the large **FMS** Knob to select the AUX Page group on the MFD.
- 18) Turn the small **FMS** Knob to select the System Status Page.
- 19) Press the Display Database Selection Softkey to show standby navigation database information for each display (**MFD1 DB, PFD1 DB, PFD2 DB**). Verify the correct standby navigation database cycle information is shown for each display.

GARMIN DATABASES

The following databases are stored on Supplemental Data Cards provided by Garmin:

- Expanded basemap
- Terrain
- Airport terrain
- Obstacle
- SafeTaxi
- FliteCharts
- Airport Directory (AOPA)

After subscribing to the desired database product, these database products will be downloaded and ultimately stored on three Supplemental Data Cards (with the exception of FliteCharts, which is loaded on only one card). Each Supplemental Data Card resides in the bottom card of each display as shown in Figure B-7. These cards must not be removed except to update the databases stored on each card.

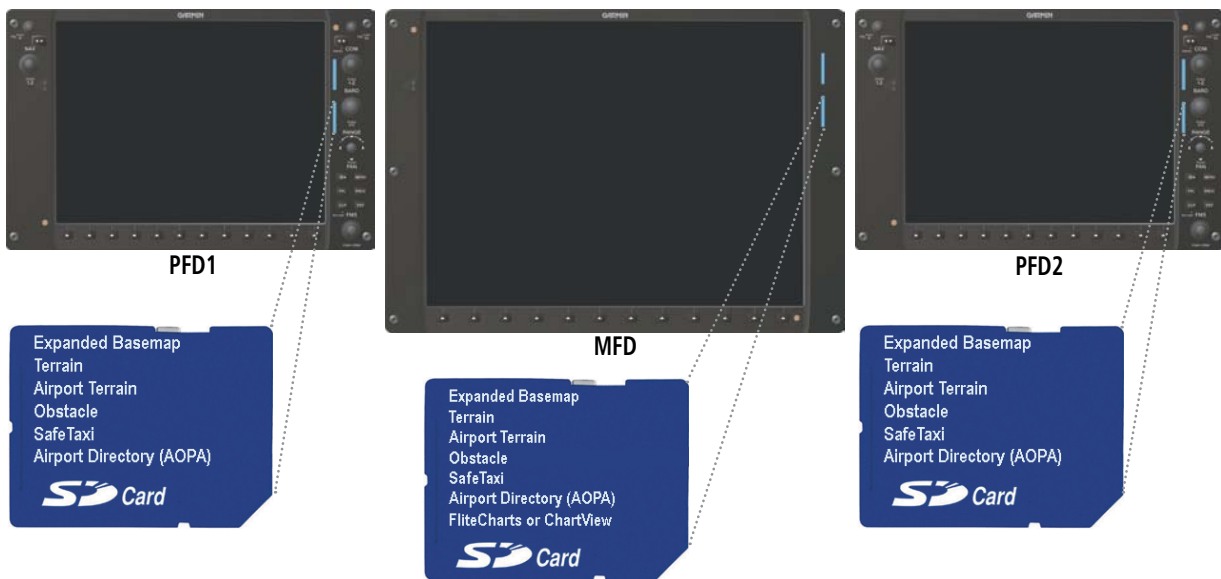

Figure B-7 Correct Database Locations

Since these databases are not stored internally in the displays, a Supplemental Data Card containing identical database versions must be kept in each display unit.

The basemap database contains data for the topography and land features, such as rivers, lakes, and towns. It is updated only periodically, with no set schedule. There is no expiration date.

The terrain database contains the terrain mapping data. The airport terrain database contains increased resolution terrain data around airports. These databases are updated periodically and have no expiration date.

The obstacle database contains data for obstacles, such as towers, that pose a potential hazard to aircraft. Obstacles 200 feet and higher are included in the obstacle database. It is very important to note that not all obstacles are necessarily charted and therefore may not be contained in the obstacle database. This database is updated on a 56-day cycle.



NOTE: The data contained in the terrain and obstacle databases comes from government agencies. Garmin accurately processes and cross-validates the data, but cannot guarantee the accuracy and completeness of the data.

The AOPA Airport Directory provides data on airports and heliports throughout the U.S., and offers detailed information for over 5,300 U. S. airports, along with the names and phone numbers of thousands of FBOs. This database is updated four times per year.

The SafeTaxi database contains detailed airport diagrams for selected airports. These diagrams aid in following ground control instructions by accurately displaying the aircraft position on the map in relation to taxiways, ramps, runways, terminals, and services. This database is updated on a 56-day cycle.

The FliteCharts database contains procedure charts for the United States only. This database is updated on a 28-day cycle. If not updated within 180 days of the expiration date, FliteCharts will no longer function.

AUTOMATIC DATABASE SYNCHRONIZATION FEATURE

The automatic database synchronization feature automatically transfers the database from a single SD database card to the SD cards on each PFD and the MFD to ensure that all databases are synchronized throughout the system. After power-up, the system compares all copies of each applicable database. If similar databases do not match, the most recent valid database is automatically copied to each card in the system that does not already contain that database.

The following databases are checked and synchronized: Basemap, Safetaxi, Airport Terrain, Obstacle, Airport Directory (AOPA), and Terrain. This feature applies only to databases that are stored on the SD card that resides in the bottom slot of each display. This feature does not apply to the navigation database which is stored internally in each display, or to the charts databases (FliteCharts and ChartView) which are only required to be present on the MFD. The typical procedure would be to download new databases to the MFD card, then synchronize the data to the PFD(s).



NOTE: The 9-arc second terrain database may take as long as 100 minutes to synchronize using this method. Therefore the user may want to transfer the data using a PC, or connect the system to a ground power source while performing the database synchronization.

The synchronization progress may be monitored on the AUX-System Status Page in the Sync Status section of the Database Window (Figure B-8). This section shows the synchronization status of each applicable database, including the percent complete, time remaining, and to which displays the databases are being copied. When the synchronization is complete, the status is listed as 'Complete', followed by the displays to which the databases were copied. This sub-section is only present when a sync is occurring or has occurred on the current power-up.

An indication of 'Complete' still requires a power cycle before the synchronized databases will be used by the system.

MFD1 DATABASE	
SYNC STATUS	
BASEMAP	Complete PFD1.PFD2
SAFETAXI	Complete PFD1.PFD2
TERRAIN	34% 0:14 PFD1.PFD2
NAVIGATION - INTERNAL	
REGION	WORLDWIDE
CYCLE	0905
EFFECTIVE	07-MAY-09
EXPIRES	04-JUN-09
Copyright 2009, Jeppesen Sanderson, Inc.	
BASEMAP - BOTTOM CARD	
REGION	WORLDWIDE
VERSION	3.00

Figure B-8 AUX-System Status Page, Database Window

The Display Database Softkey (Figure B-11) is used to place the cursor in the Database Window. Upon first press of the Display Database Softkey, the softkey will change to a selected state (black text on gray background) and the cursor will appear in the Database Window. At this point the user can scroll through all databases in the Database Window to view status information. If the Display Database Softkey is pressed repeatedly, the softkey will cycle through PFD1, PFD2, and MFD. Database status information in the Database Window will reflect the database of the selected PFD or MFD. After a successful sync and restart, verify that the proper databases are now in use on the AUX–System Status Page (Figure B-8).

If an error occurs during the synchronization, an error message will be displayed, followed by the affected display in the Sync Status section of the Database Window (Figure B-9). If a synchronization completes on one display, but an error occurs on another, the error message will be displayed with the affected display listed after it. When an error message (Table B-1) is displayed, the problem must be corrected before the synchronization can be completed. A power cycle is required to restart synchronization when ‘Card Full’ or ‘Err’ is shown.

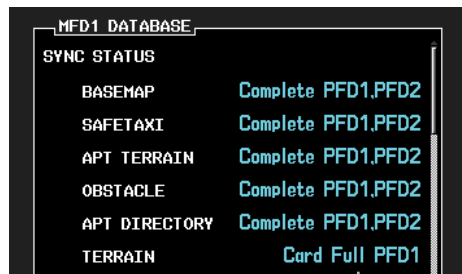

Database Synchronization Error Message
Figure B-9 Synchronization Error Message

Error Message	Description
Canceled	Database synchronization has been canceled by removing the bottom SD card in display being updated
Card Full	SD card does not contain sufficient memory
Err	Displayed for all other errors that may cause the synchronization process to be halted
Timeout	System timed-out prior to the database transfer completing

Table B-1 Database Synchronization Error Messages

UPDATING GARMIN DATABASES

The Garmin database updates can be obtained by following the instructions detailed in the ‘Aviation Databases’ section of the Garmin website (fly.garmin.com). Once the updated files have been downloaded from the website, a PC equipped with an appropriate SD card reader is used to unpack and program the new databases onto an existing Supplemental Data Card. Equipment required to perform the update is as follows:

- Windows-compatible PC computer (running Windows XP, Vista, or Windows 7)
- SD Card Reader: SanDisk SDDR-93, SanDisk SDDR-99, Verbatim #96504, or equivalent
- Updated database obtained from the Garmin website
- Existing Supplemental Database SD Cards (010-00330-42, or -43) from both PFDs and MFD

In some cases it may be necessary to obtain an unlock code from Garmin in order to make the database product functional. It may also be necessary to have the system configured by a Garmin authorized service facility in order to use some database features.

After the data has been copied to the appropriate data card, perform the following steps:

- 1) With system power OFF, remove the MFD database card from the bottom card slot of the MFD.
- 2) Update the Garmin databases on the MFD card.
- 3) Insert the MFD database card into the bottom card slot of the MFD.
- 4) Apply power to the system, check that the databases are initialized and displayed on the power-up screen (Figure B-10). When updating the terrain and FliteCharts databases, a 'Verifying' message may be seen. If this message is present, wait for the system to finish loading before proceeding to step 5.

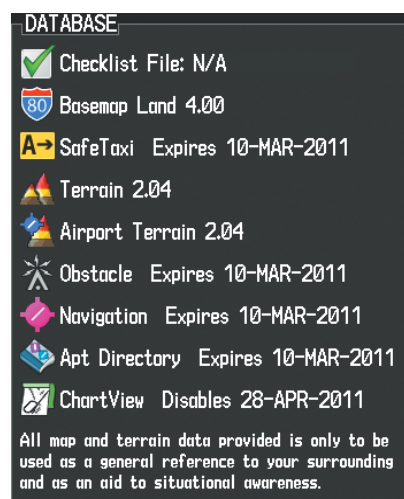

Figure B-10 Database Information on the Power-up Screen

- 5) Acknowledge the Power-up Page agreement by pressing the **ENT** Key or the right most softkey.
- 6) Turn the large **FMS** Knob to select the AUX Page group on the MFD.
- 7) Turn the small **FMS** Knob to select the System Status Page.
- 8) Monitor the Sync Status in the Database Window. Wait for all databases to complete syncing, indicated by 'Complete' being displayed as seen in Figure B-9.
- 9) Remove and reapply power to the system.
- 10) Turn the large **FMS** Knob to select the AUX Page group on the MFD.
- 11) Turn the small **FMS** Knob to select the System Status Page.
- 12) Press the Display Database Selection Softkey to show database information for each display (**MFD1 DB**, **PFD1 DB**, **PFD2 DB**). Verify the correct database cycle information is shown for each database for each display.



Figure B-11 Display Database Softkey

MAGNETIC FIELD VARIATION DATABASE UPDATE

A copy of the current magnetic field variation database (MV DB) is included with the navigation database. At startup, the system compares this version of the MV DB with that presently being used by each AHRS (GRS1 and GRS2). If the system determines the MV DB needs to be updated, a prompt is displayed on the Navigation Map Page, as shown in Figure B-12. Note, in the following example, GRS1 is the first AHRS to indicate an update is available. In actuality, this is dependent on which AHRS is the first to report status to the system. GRS2 may be displayed before GRS1. The order is not important, only that both AHRS be updated.

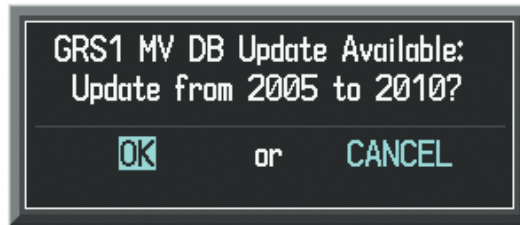

Figure B-12 GRS1 Magnetic Field Variation Database Update Prompt

Loading the magnetic field variation database update:

- 1) With 'OK' highlighted, as seen in Figure B-12, press the **ENT** Key on the MFD. A progress monitor is displayed as shown in Figure B-13.

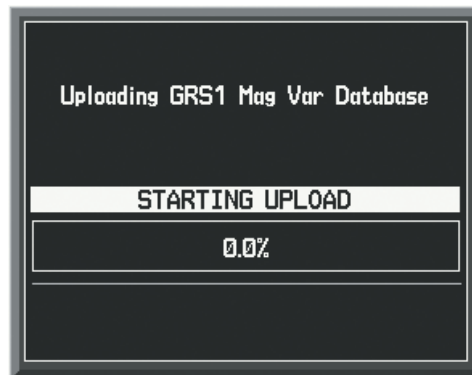

Figure B-13 Uploading Database to GRS1

- 2) When the upload is complete, the prompt for the next GRS upload is displayed, as seen in Figure B-14.

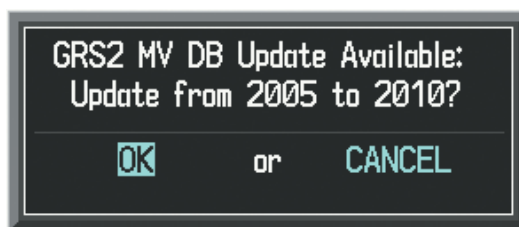

Figure B-14 GRS2 Magnetic Field Variation Database Update Prompt

- 3) With 'OK' highlighted, press the **ENT** Key on the MFD. A progress monitor is displayed as shown in Figure B-15. When the upload is complete, the system is ready for use.



Figure B-15 Uploading Database to GRS2

GLOSSARY

ACC	accuracy	°C	degrees Celsius
ACT, ACTV	active, activate	CA	Course to Altitude
ADC	air data computer	CALC	calculator
ADF	Automatic Direction Finder	Calibrated Airspeed	Indicated airspeed corrected for installation and instrument errors.
ADI	Attitude Direction Indicator	CD	Course to DME distance
AF	Arc to fix	CDI	Course Deviation Indicator
AFCS	Automatic Flight Control System	CDU	Control Display Unit
AFM	Airplane Flight Manual	CF	Course to Fix
AFMS	Airplane Flight Manual Supplement	CHT	Cylinder Head Temperature
AFRM	airframe	CHKLIST	checklist
AGL	Above Ground Level	CHNL	channel
AHRS	Attitude and Heading Reference System	CI	Course to Intercept
AIM	Aeronautical Information Manual	CLD	cloud
AIRMET	Airman's Meteorological Information	CLR	clear
ALRT	alert	cm	centimeter
ALT	altitude	CNS	Communication, Navigation, & Surveillance
ALT, ALTN	alternator	CO	carbon monoxide
AMPS	amperes	COM	communication radio
ANNUNC	annunciation	CONFIG	configuration
ANT	antenna	COOL	coolant
AP	autopilot	COPLT	co-pilot
AP DISC	autopilot disconnect	Course	The line between two points to be followed by the aircraft.
APR	approach	Course to Steer	The recommended direction to steer in order to reduce course error or stay on course. Provides the most efficient heading to get back to the desired course and proceed along the flight plan.
APT	airport, aerodrome		
ARINC	Aeronautical Radio Incorporated		
ARSPC	airspace	CR	Course to Radial
ARTCC	Air Route Traffic Control Center	CRG	Cockpit Reference Guide
ARV	arrival	CRNT	current
AS	airspeed	Crosstrack Error	The distance the aircraft is off a desired course in either direction, left or right.
ASB	Aviation Support Branch	CRS	course
ASOS	Automated Surface Observing System	CRS	Course to Steer
ATC	Air Traffic Control	CRSR	cursor
ATCRBS	ATC Radar Beacon System	CTA	Control Area
ATIS	Automatic Terminal Information Service	CTRL	control
ATK	along-track	Cumulative	The total of all legs in a flight plan.
AUTOSEQ	automatic sequence	CVR	Cockpit Voice Recorder
AUX	auxiliary	CVRG	coverage
AWOS	Automated Weather Observing System	CWS	control wheel steering
		CYL	cylinder
B ALT	barometric altitude	D ALT	density altitude
BARO	barometric setting	DB, DBASE	database
BATT	battery	dBZ	decibels 'Z' (radar return)
BC	backcourse		
Bearing	The compass direction from the present position to a destination waypoint.		
BFO	beat frequency oscillator		
BKSP	backspace		
BRG	bearing		
C	center runway		

DCLTR, DECLTR	declutter	ENT	enter
DEC FUEL	decrease fuel	EPE	Estimated Position Error
deg	degree	EPU	Estimated Position Uncertainty
DEIC, DEICE	de-icing	ERR	error
DEP	departure	ESA	Enroute Safe Altitude
Desired Track	The desired course between the active "from" and "to" waypoints.	Estimated Position Error	A measure of horizontal GPS position error derived by satellite geometry conditions and other factors.
DEST	destination	Estimated Time of Arrival	The estimated time at which the aircraft should reach the destination waypoint, based upon current speed and track.
DF	Direct to Fix	Estimated Time Enroute	The estimated time it takes to reach the destination waypoint from the present position, based upon current ground speed.
DFLT	default	ETA	Estimated Time of Arrival
DGRD	degrade	ETE	Estimated Time Enroute
DH	decision height	EXPIRD	expired
Dilution of Precision	A measure of GPS satellite geometry quality on a scale of one to ten (lower numbers equal better geometry, where higher numbers equal poorer geometry).	°F	degrees Fahrenheit
DIR	direction	FA	Course From Fix to Altitude
DIS	distance	FAA	Federal Aviation Administration
Distance	The 'great circle' distance from the present position to a destination waypoint.	FADEC	Full Authority Digital Engine Control
DME	Distance Measuring Equipment	FAF	Final Approach Fix
DOP	Dilution of Precision	FAIL	failure
DP	Departure Procedure	FC	Course From Fix to Distance
DPRT	departure	FCC	Federal Communication Commission
DR	dead reckoning	FCST	forecast
DSBL	disabled	FD	Course From Fix to DME Distance
DTK	Desired Track	FD	flight director
E	empty, east	FDE	Fault Detection and Exclusion
ECU	Engine Control Unit	FFLOW	fuel flow
Efficiency	A measure of fuel consumption, expressed in distance per unit of fuel.	FIS-B	Flight Information Services-Broadcast
EGT	Exhaust Gas Temperature	FISDL	Flight Information Service Data Link
EIS	Engine Indication System	FL	flight level
EGNOS	European Geostationary Navigation Overlay Service	FLC	Flight Level Change
ELEV	elevation	FM	Course From Fix to Manual Termination
ELEV	elevator	FMS	Flight Management System
EMERGCY	emergency	FOB	Fuel On Board
EMI	Electromagnetic Interference	FPL	flight plan
ENDUR	endurance	fpm	feet per minute
Endurance	Flight endurance, or total possible flight time based on available fuel on board.	FREQ	frequency
ENG	engine	FRZ	freezing
ENGD	engaged	FSS	Flight Service Station
ENR	enroute	ft	foot/feet
Enroute Safe Altitude	The recommended minimum altitude within ten miles left or right of the desired course on an active flight plan or direct-to.	Fuel Flow	The fuel flow rate, expressed in units of fuel per hour.
		Fuel On Board	The total amount of usable fuel on board the aircraft.

G/S, GS	glideslope	HSI	Horizontal Situation Indicator
GA	go-around	HT	heat
gal, gl	gallon(s)	HUL	Horizontal Uncertainty Level
GBOX	gearbox	Hz	Hertz
GDC	Garmin Air Data Computer	I	Inner Marker
GDL	Garmin Satellite Data Link	IAF	Initial Approach Fix
GDU	Garmin Display Unit	IAT	Indicated Air Temperature
GEA	Garmin Engine/Airframe Unit	IAU	Integrated Avionics Unit
GEO	geographic	ICAO	International Civil Aviation Organization
GFC	Garmin Flight Control	ICS	Intercom System
GIA	Garmin Integrated Avionics Unit	ID	Identification/Morse Code Identifier
GLS	Global Navigation Satellite Landing System	IDENT, IDNT	identification
		IF	Initial Fix
GMA	Garmin Audio Panel System	IFR	Instrument Flight Rules
GMC	Garmin Mode Controller	IG	Imperial gallon
GMT	Greenwich Mean Time	IGRF	International Geomagnetic Reference Field
GMU	Garmin Magnetometer Unit		
GND	ground	ILS	Instrument Landing System
gph	gallons per hour	IMC	Instrument Meteorological Conditions
GPS	Global Positioning System	in	inch
Grid MORA	Grid Minimum Off-Route Altitude; one degree latitude by one degree longitude in size and clears the highest elevation reference point in the grid by 1000 feet for all areas of the grid	INACTV	inactive
		INC FUEL	increase fuel
		IND	indicated
		Indicated	Information provided by properly calibrated and set instrumentation on the aircraft panel.
Groundspeed	The velocity that the aircraft is travelling relative to a ground position.	INFO	information
Ground Track	<i>see Track</i>	in HG	inches of mercury
GRS	Garmin Reference System	INT	intersection(s)
GS	Ground speed	INTEG	integrity (RAIM unavailable)
GTX	Garmin Transponder	IrDA, IRDA	Infrared Data Association
HA	Hold Terminating at Altitude	KEYSTK	key stuck
HDG	heading	kg	kilogram
Heading	The direction an aircraft is pointed, based upon indications from a magnetic compass or a properly set directional gyro.	kHz	kilohertz
		km	kilometer
		kt	knot
HF	Hold Terminating at Fix	L	left, left runway
HFOM	Horizontal Figure of Merit	LAT	latitude
Hg	mercury	LBL	label
HI	high	lb	pound
HI SENS	High Sensitivity	LCD	Liquid Crystal Display
HM	Hold with Manual Termination	LCL	local
Horizontal Figure of Merit	A measure of the uncertainty in the aircraft's horizontal position.	LED	Light Emitting Diode
		Left Over Fuel On Board	The amount of fuel remaining on board after the completion of one or more legs of a flight plan or direct-to.
hPa	hectopascal		
HPL	Horizontal Protection Level		
hr	hour		
HSDB	High-Speed Data Bus		

Left Over Fuel Reserve	The amount of flight time remaining, based on the amount of fuel on board after the completion of one or more legs of a flight plan or direct-to, and a known consumption rate.	MSG	message
		MSL	Mean Sea Level
		MT	meter
		mV	millivolt(s)
		MV DB	Magnetic Field Variation Database
Leg	The portion of a flight plan between two waypoints.	MVFR	Marginal Visual Flight Rules
LIFR	Low Instrument Flight Rules	N	north
LNAV	Lateral Navigation	NAV	navigation
LO	low	NAVAID	NAVigation AID
LOC	localizer	NDB	Non-directional Beacon
LOI	loss of integrity (GPS)	NEXRAD	Next Generation Radar
LON	longitude	nm	nautical mile(s)
LPV	Localizer Performance with Vertical guidance	NoPT	No Procedure Turn Required (procedure shall not be executed without ATC clearance)
LRU	Line Replaceable Unit		
LT	left	NRST	nearest
LTNG	lightning		
LVL	level	O	Outer Marker
		OAT	Outside Air Temperature
M	Middle Marker	OBS	Omni Bearing Selector
m	meter	OFST	offset
MAG	Magnetic	OXY	oxygen
MAG VAR	Magnetic Variation		
MAHP	Missed Approach Hold Point	P ALT	pressure altitude
MAN IN	manifold pressure (inches Hg)	PA	Passenger Address
MAN SQ	Manual Squelch	PA	Proximity Advisory
MAP	Missed Approach Point	PASS	passenger(s)
MASQ	Master Avionics Squelch	PC	personal computer
MAX	maximum	PFD	Primary Flight Display
MAXSPD	maximum speed (overspeed)	PI	Procedure Turn to Course Intercept
MDA	barometric minimum descent altitude	PIT, PTCH	pitch
MET	manual electric trim	POSN	position
METAR	Meteorological Aviation Routine	PPM	parts per million
MEPT	manual electric pitch trim	P. POS	Present Position
MFD	Multi Function Display	PRES, PRESS	pressure
MGRS	Military Grid Reference System	PROC	procedure(s), procedure turn
MHz	megahertz	psi	pounds per square inch
MIC	microphone	PT	Procedure Turn
MIN	minimum	PTK	parallel track
Minimum Safe Altitude	Uses Grid MORAs to determine a safe altitude within ten miles of the aircraft present position.	PTT	Push-to-Talk
		PWR	power
MKR	marker beacon	QTY	quantity
MOA	Military Operations Area		
MOV	movement	R	right, right runway
mpm	meters per minute	RAD	radial
MSA	Minimum Safe Altitude	RAIM	Receiver Autonomous Integrity Monitoring
MSAS	Multi-functional Satellite Augmentation System	RAM	random access memory

REF	reference	SW	software
REM	remaining (fuel remaining above Reserve)	SYS	system
REQ	required	T	true
RES	reserve (fuel reserve entered by pilot)	TA	Traffic Advisory
REV	reverse, revision, revise	TACAN	Tactical Air Navigation System
RF	Constant Radius Turn to Fix	TAF	Terminal Aerodrome Forecast
RMI	Radio Magnetic Indicator	TAS	True Airspeed
RMT	remote	TAS	Traffic Advisory System, true airspeed
RNG	range	TAT	Total Air Temperature
RNWY	runway	TAWS	Terrain Awareness and Warning System
ROL	roll	TCA	Terminal Control Area
ROM	read only memory	TCAS	Traffic Collision Avoidance System
rpm	revolutions per minute	TEL	telephone
RST FUEL	reset fuel	TEMP	temperature
RSV	reserve (fuel reserve entered by pilot)	TERM	terminal
RT	right	TF	Track Between Two Fixes
RVRSNRY	reversionary	TFR	Temporary Flight Restriction
RX	receive	T HDG	True Heading
S	south	TIS	Traffic Information System
SA	Selective Availability	TIT	Turbine Inlet Temperature
SAT	Static Air Temperature	TKE	Track Angle Error
SBAS	Satellite-Based Augmentation System	TMA	Terminal Maneuvering Area
SCIT	Storm Cell Identification and Tracking	TMR/REF	Timer/Reference
SD	Secure Digital	Topo	topographic
sec	second(s)	Track	Direction of aircraft movement relative to a ground position; also 'Ground Track'
SEL, SLCT	select	Track Angle Error	The angle difference between the desired track and the current track.
SFC	surface	TRG	target
SIAP	Standard Instrument Approach Procedures	TRK	track
SID	Standard Instrument Departure	TRSA	Terminal Radar Service Area
SIGMET	Significant Meteorological Information	TRUNC	truncated
Sim	simulator	TTL	total
SLP/SKD	slip/skid	TURN	procedure turn
SMBL	symbol	TX	transmit
SPD	speed		
SPI	Special Position Identification	UNAVAIL	unavailable
SPKR	speaker	USR	user
SQ	squelch	UTC	Coordinated Universal Time
SRVC, SVC	service	UTM/UPS	Universal Transverse Mercator / Universal Polar Stereographic Grid
STAL	stall		
STAR	Standard Terminal Arrival Route	V, Vspeed	velocity (airspeed)
STATS	statistics	VA	Heading Vector to Altitude
STBY	standby	VAPP	VOR approach
STD	standard	VAR	variation
STRMSCP	Stormscope	VD	Heading Vector to DME Distance
SUA	Special Use Airspace	Vdc	volts, direct current
SUSP	suspend		
SVS	Synthetic Vision System		

VERT	vertical
Vertical Figure of Merit	A measure of the uncertainty in the aircraft's vertical position.
Vertical Speed Required	The vertical speed necessary to descend/climb from a current position and altitude to a defined target position and altitude, based upon current groundspeed.
VFOM	Vertical Figure of Merit
VFR	Visual Flight Rules
VHF	Very High Frequency
VI	Heading Vector to Intercept
VLOC	VOR/Localizer Receiver
VM	Heading Vector to Manual Termination
VMC	Visual Meteorological Conditions
VNAV, VNV	vertical navigation
VOL	volume
VOR	VHF Omni-directional Range
VORTAC	very high frequency omnidirectional range station and tactical air navigation
VPL	Vertical Protection Level
VPROF	VNV profile, vertical profile
VPTH	VNV path, vertical path
VR	Heading Vector to Radial
VS	vertical speed
VSI	Vertical Speed Indicator
VSR	Vertical Speed Required
VTF	vector to final
W	watt(s), west
WAAS	Wide Area Augmentation System
WARN	warning (GPS position error)
WGS-84	World Geodetic System - 1984
WPT	waypoint(s)
WW	world wide
WX	weather
XFER, XFR	transfer
XPDR	transponder
XTALK	cross-talk
XTK	cross-track

FREQUENTLY ASKED QUESTIONS

If a particular aspect of G1000 operational capability is not addressed by these commonly asked questions or in the index, contact Garmin (see the copyright page or back cover for contact information) or a Garmin-authorized dealer. Garmin is dedicated to supporting its products and customers.

WHAT IS SBAS?

The Satellite Based Augmentation System (SBAS) uses a system of ground stations to correct any GPS signal errors. These ground stations correct for errors caused by ionospheric disturbances, timing, and satellite orbit errors. It also provides vital integrity information regarding the health of each GPS satellite. The signal correction is then broadcast through geostationary satellites. This correction information can then be received by any SBAS-enabled GPS receiver.

SBAS is designed to provide the additional accuracy, availability, and integrity necessary to enable users to rely on GPS for all phases of flight.

There are several SBAS systems serving different parts of the world. The Wide Area Augmentation System (WAAS) is currently available in the United States, including Alaska and Hawaii. The European Geostationary Navigation Overlay Service (EGNOS) offers coverage of Europe, parts of the middle east and northern Africa. The Multi-functional Satellite Augmentation System (MSAS) covers mainly Japan and parts of northern Australia.

HOW DOES SBAS AFFECT APPROACH OPERATIONS?

Both LNAV/VNAV and LPV approaches use the accuracy of SBAS to include vertical (glide path) guidance capability. The additional accuracy and vertical guidance capability allows improved instrument approaches to an expanded number of airports throughout the U.S.

The implementation of LPV approaches further improves precision approach capabilities. LPV approaches are designed to make full use of the improved GPS signal from the SBAS. This approach combines the LNAV/VNAV vertical accuracy with lateral guidance similar to the typical Instrument Landing System (ILS). LPV approaches allow lower approach minimums.

WHAT IS RAIM AND HOW DOES IT AFFECT APPROACH OPERATIONS?

RAIM is an acronym for Receiver Autonomous Integrity Monitoring. RAIM is a GPS receiver function that performs the following functions:

- Monitors and verifies integrity and geometry of tracked GPS satellites
- Notifies the pilot when satellite conditions do not provide the necessary coverage to support a certain phase of flight
- Predicts satellite coverage of a destination area to determine whether the number of available satellites is sufficient to satisfy requirements



NOTE: If RAIM is not predicted to be available for the final approach course, the approach does not become active, as indicated by the "RAIM not available from FAF to MAP" message and the LOI annunciation flagging on the HSI.

For RAIM to work correctly, the GPS receiver must track at least five satellites. A minimum of six satellites is required to allow RAIM to eliminate a single corrupt satellite from the navigation solution.

RAIM ensures that satellite geometry allows for a navigation solution calculation within a specified protection limit (2.0 nm for oceanic and en route, 1.0 nm for terminal, and 0.3 nm for non-precision approaches). The G1000 System monitors RAIM and issues an alert message when RAIM is not available (see Appendix A). Without RAIM, GPS position accuracy cannot be monitored. If RAIM is not available when crossing the FAF, the pilot must fly the missed approach procedure.

WHY ARE THERE NOT ANY APPROACHES AVAILABLE FOR A FLIGHT PLAN?

Approaches are available for the final destination airport in a flight plan or as a direct-to (keep in mind that some VOR/VORTAC identifiers are similar to airport identifiers). If a destination airport does not have a published approach, the G1000 indicates “NONE” for the available procedures.

WHAT HAPPENS WHEN AN APPROACH IS SELECTED? CAN A FLIGHT PLAN WITH AN APPROACH, A DEPARTURE, OR AN ARRIVAL BE STORED?

When an approach, departure, or arrival is loaded into the active flight plan, a set of approach, departure, or arrival waypoints is inserted into the flight plan, along with a header line showing the title of the selected instrument procedure. The original en route portion of the flight plan remains active, unless the instrument procedure is activated. This may be done either when the procedure is loaded or at a later time.

Flight plans can also be stored with an approach, a departure, or an arrival. Note that the active flight plan is erased when the system is turned off. Also, the active flight plan is overwritten when another flight plan is activated. When storing flight plans with an approach, a departure, or an arrival, the G1000 uses the waypoint information from the current database to define the waypoints. If the database is changed or updated, the G1000 System automatically updates the information, provided the procedure has not been modified. Should an approach, departure, or arrival procedure no longer be available, the flight plan becomes locked until the procedure is deleted from the flight plan.

CAN “SLANT GOLF” (“/G”) BE FILED USING THE G1000?

“/G” may be filed for a flight plan. The G1000 System meets the requirements of TSO-C145a Class 3 and ETSO C145 Class 3 installations. GPS approaches are not to be flown with an expired database. See the approved Pilot’s Operating Handbook (POH) as well as the Aeronautical Information Manual (AIM) for more information.

WHAT DOES THE OBS SOFTKEY DO?

The **OBS** Softkey is used to select manual sequencing of waypoints. Activating OBS mode sets the current active-to waypoint as the primary navigation reference and prevents the system from sequencing to the next waypoint in a flight plan. When OBS mode is cancelled, automatic waypoint sequencing is continued, and the G1000 automatically activates the next waypoint in the flight plan once the aircraft has crossed the present active waypoint.

Normal (OBS not activated)

- Automatic sequencing of waypoints
- Manual course change on HSI not possible
- Always navigates ‘TO’ the active waypoint
- Must be in this mode for final approach course

OBS

- Manual sequencing - ‘holds’ on selected waypoint
- Manually select course to waypoint from HSI
- Indicates ‘TO’ or ‘FROM’ waypoint
- Cannot be set for final approach course or published holding patterns

When OBS mode is active, the G1000 allows the pilot to set a desired course to/from a waypoint using the **CRS/BARO** Knob and HSI (much like a VOR).

The most common application for using the **OBS** Softkey is the missed approach. The G1000 suspends automatic waypoint sequencing (indicated by a ‘SUSP’ annunciation placed on the HSI) when the missed approach point (MAP) is crossed. This prevents the G1000 from automatically sequencing to the missed approach holding point (MAHP). During this time, the **OBS** Softkey designation changes to **SUSP**. Pressing the **SUSP** Softkey reactivates automatic waypoint sequencing. The **OBS** Softkey then resumes its normal functionality.

WHY DOES THE G1000 NOT AUTOMATICALLY SEQUENCE TO THE NEXT WAYPOINT?

The G1000 only sequences flight plan waypoints when automatic sequencing is enabled (i.e., no “OBS” or “SUSP” annunciation). For automatic sequencing to occur, the aircraft must also cross the “bisector” of the turn being navigated. The bisector is a line passing through the waypoint common to two flight plan legs at an equal angle from each leg.

HOW CAN A WAYPOINT BE SKIPPED IN AN APPROACH, A DEPARTURE, OR AN ARRIVAL?

The G1000 allows the pilot to manually select any approach, departure, or arrival leg as the active leg of the flight plan. This procedure is performed on the MFD from the Active Flight Plan Page by highlighting the desired waypoint and selecting the **ACT LEG** Softkey then the **ENT** Key to approve the selection. The GPS then provides navigation along the selected flight plan leg.

WHEN DOES TURN ANTICIPATION BEGIN?

The G1000 smooths adjacent leg transitions based on a normal 15° bank angle (with the ability to roll up to 30°) and provides three pilot cues for turn anticipation:

- A waypoint alert (‘Next DTK ###° in # seconds’ or ‘Next HDG ###° in # seconds’) appears on the PFD 10 seconds before the turn point and flashes as it counts down to zero.
- A flashing turn advisory (‘Turn [right/left] to ###° in # seconds’) appears on the PFD 10 seconds before the turn and flashes as it counts down to zero. ‘Turn [right/left] to ###° now’ or ‘Next [DTK/HDG] to ###° now’ is displayed when the pilot is to begin the turn and the HSI (GPS mode) automatically sequences to the next DTK or HDG value.
- The To/From indicator on the HSI flips momentarily to indicate that the midpoint of the turn has been crossed.

WHEN DOES THE CDI SCALE CHANGE?

Once a departure is activated, the G1000 Course Deviation Indicator (CDI) full scale deflection is set to 0.3 nm. The CDI scale changes to 1.0 nm (terminal mode) then ramps up to 2.0 nm (enroute mode) at 30 nm from the departure airport. When 31 nm from the destination, the CDI scale smoothly transition from 2.0 nm back to 1.0 nm (terminal mode). At 2.0 nm before the FAF during an active approach, the CDI scale transitions down further based on the type of approach activated (LNAV, LNAV/VNAV, LPV). When a missed approach is activated, the CDI is set to 0.3 nm. See the Flight Instruments Section for more details on CDI scaling.

WHY DOES THE HSI NOT RESPOND LIKE A VOR WHEN OBS MODE IS ACTIVE?

Unlike a VOR, the CDI scale used on GPS equipment is based on the crosstrack distance to the desired course, not on the angular relationship to the destination. Therefore, the CDI deflection on the GPS is constant regardless of the distance to the destination and does not become less sensitive when further away from the destination.

WHAT IS THE CORRECT MISSED APPROACH PROCEDURE? HOW IS THE MISSED APPROACH HOLDING POINT SELECTED?

To comply with TSO specifications, the G1000 does not automatically sequence past the MAP. The first waypoint in the missed approach procedure becomes the active waypoint when the **SUSP** Softkey is selected *after* crossing the MAP. All published missed approach procedures must be followed, as indicated on the approach plate.

To execute the missed approach procedure prior to the MAP (not recommended), select the Active Flight Plan Page and use the **ACT LEG** Softkey to activate the missed approach portion of the procedure.

AFTER A MISSED APPROACH, HOW CAN THE SAME APPROACH BE RE-SELECTED? HOW CAN A NEW APPROACH BE ACTIVATED?



NOTE: Do not attempt to reactivate the current approach prior to crossing the missed approach point (MAP). If an attempt to do so is made, an alert message “Are you sure you want to discontinue the current approach?” appears. The G1000 directs the pilot back to the transition waypoint and does not take into consideration any missed approach procedures, if the current approach is reactivated.

After flying the missed approach procedure, the pilot may reactivate the same approach for another attempt by pressing the **PROC** Key. Once the clearance is given for another attempt, activate the approach by highlighting ‘ACTIVATE APPROACH’ using the large **FMS** Knob and pressing the **ENT** Key. The G1000 provides navigation along the desired course to the waypoint and rejoins the approach in sequence from that point.

To activate a new approach for the same airport, select the new procedure by pressing the **PROC** Key. Choose ‘SELECT APPROACH’, select the desired approach from the list shown, and press the **ENT** Key. Select the desired transition, then activate the approach using the **ENT** Key.

To activate a new approach to a different airport, press the **Direct-to** Key and select the desired airport using the **FMS** Knobs. Press the **ENT** Key to accept the selected airport, then follow the steps in the preceding paragraph to select an approach for the new airport.

MAP SYMBOLS



NOTE: Refer to the Flight Management Section for the topography legend and the Hazard Avoidance Section for XM WX Satellite Weather Product legends.

AIRPORT

Item	Symbol
Unknown Airport	
Non-towered, Non-serviced Airport	
Towered, Non-serviced Airport	
Non-towered, Serviced Airport	
Towered, Serviced Airport	
Restricted (Private) Airport	
Heliport	















NAVAIDS

Item	Symbol
Intersection	
LOM (compass locator at outer marker)	
NDB (non-directional radio beacon)	
VOR	
VOR/DME	
VOR/ILS	
VORTAC	
TACAN	





LINE SYMBOLS

Item	Symbol
ICAO Control Area Class B Airspace	
Mode C Tower Area	
Warning Area Alert Area Caution Area Danger Area	
Prohibited Area Restricted Area Training Area Unknown Area	
Class C Terminal Radar Service Area Mode C Area	
Military Operations Area (MOA)	
State or Province Border	
International Border	
Road	
Railroad	
Latitude/Longitude	





MISCELLANEOUS

Item	Symbol
ARTCC Frequency or FSS Frequency	
Default Map Pointer	
Elevation Pointer	
Wind Vector	
Measuring Pointer	
Overzoom Indicator	
Terrain Proximity or TAWS Enabled	
Traffic Enabled	
User Waypoint	
Vertical Navigation Along Track Waypoint	
Parallel Track Waypoint	
Unanchored Flight Path Waypoint	
Top of Descent (TOD)	
Bottom of Descent (BOD)	
Navigating using Dead Reckoning	

STORMSCOPE LIGHTNING STRIKES

Item	Symbol
Lightning Strike (0-6 sec ago)	
Lightning Strike (6-20 sec ago)	
Lightning Strike (20-60 sec ago)	
Lightning Strike (60-120 sec ago)	

TRAFFIC

Item	Symbol
Non-threat Traffic (hollow diamond)	
Proximity Advisory (TAS only)	
Traffic Advisory, Out of Range	
Traffic Advisory	

TERRAIN AVOIDANCE COLORS AND SYMBOLS

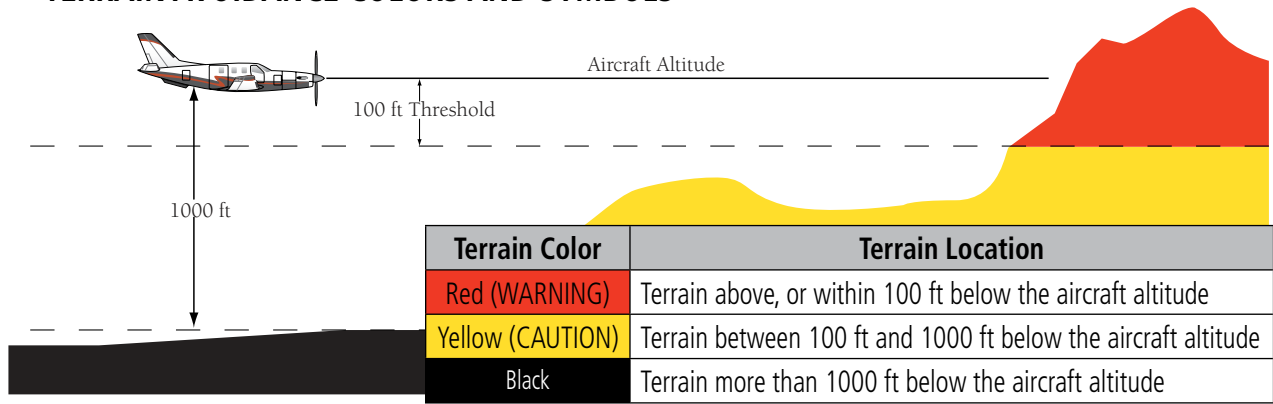

Terrain Proximity Color Chart

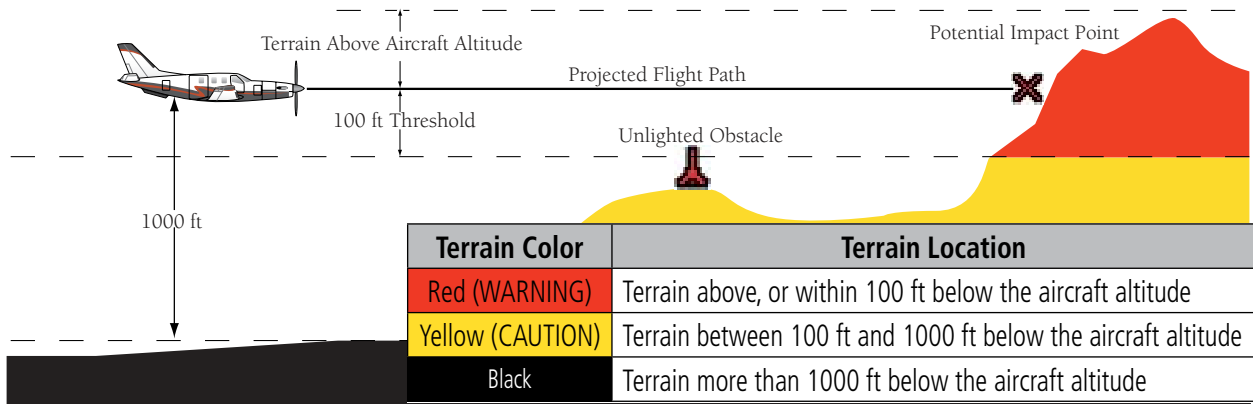

Terrain-SVS & TAWS Color Chart























Terrain-SVS & TAWS Potential Impact Points

Height	Unlighted Obstacle		Lighted Obstacle		Obstacle Color	Obstacle Location
	< 1000 ft AGL	> 1000 ft AGL	< 1000 ft AGL	> 1000 ft AGL		
Obstacle Symbol					Red (WARNING)	Obstacle within 100 ft of or above aircraft altitude
					Yellow (CAUTION)	Obstacle within 1000 ft of aircraft altitude
					Gray	Obstacle more than 1000 ft below aircraft altitude

Obstacle Symbols and Colors

HAZARD AVOIDANCE FEATURES

Feature	Symbol
Terrain Proximity/TAWS display enabled	
Traffic display enabled	
NEXRAD display enabled	
Cloud Top display enabled	
Echo Top display enabled	
XM Lightning display enabled	
Cell Movement display enabled	
SIGMETs/AIRMETs display enabled	
METARs display enabled	
City Forecast display enabled	
Surface Analysis display enabled	
Freezing Levels display enabled	
Winds Aloft display enabled	
County Warnings display enabled	
Cyclone Warnings display enabled	
Icing Potential (CIP and SLD) (ICNG)	
Pilot Weather Report (PIREPs)	
Air Report (AIREPs)	
Turbulence (TURB)	
Loss of hazard avoidance feature (due to loss of GPS position)	

A

- Access code----- 345, 346
- Activate a Flight Plan-----234
- Active database ----- 638, 639
- Active frequency ----- 112, 122
 - ADF-----131
- ADF
 - ADF mode ----- 131, 133
 - ANT mode-----133
 - Volume-----131
- ADF audio-----123
- ADF/BFO -----133
- ADF/DME tuning -----134
- ADF frequency tuning -----132
- ADF volume-----133
- AFCS status annunciation ----- 53
- AFCS status box-----52
- AFCS Status Box -----473
- AHRS----- 19, 21, 617, 626, 627, 629
- Air Data Computer -----1, 21, 616, 617
- AIRMET-----326
- Airport
 - Information -----191
 - Nearest -----44
- Airspace alerts-----207
- Airspace Alerts ----- 208, 305
- Airspeed indicator -----52, 54
- Airspeed Reference -----470, 481–482
- Airways ----- 27
 - Collapsed-----247
 - Expanded-----247
- Alerts
 - Airspace ----- 41
 - Arrival-----42
 - Audio voice -----42
- Alerts, Aircraft -----613
- Along Track Offset ----- 238, 239
- ALT -----301
- Altimeter -----52, 57–60
- Altitude
 - Constraints-----287
- Altitude alerting-----82
- Altitude buffer-----41
- Altitude constraints-----250
- Altitude Hold Mode -----479
- Altitude Reference ----- 478, 479, 487
- Annunciations
 - Test tone-----47
- Annunciations, G1000 System-----21
- Annunciator lights-----142
- ANT/BFO -----133
- Antenna stabilization -----393
- Antenna tilt-----390

- AOPA Airport Directory----- 519, 576, 577, 591, 641
- Approach-----654
 - Activating -----263
 - ILS -----512
 - Loading -----231, 260, 262
 - Missed -----515
 - Removing-----263
 - WAAS -----514
- Approach Mode-----497, 512
- Approach Mode, AFCS -----514
- APR softkey -----262, 268
- Arc HSI-----63
- Arrival procedure-----215, 229, 257, 259, 285, 287, 297
- Attitude-----1
- Attitude & Heading Reference System-----616
- Attitude indicator -----52, 56
- Audio Panel fail-safe operation-----151
- Aural alerts-----635
- Automatic Flight Control System (AFCS)-----469–518
 - Alerts-----632
 - Alerts and annunciations -----517–518
 - Controls -----470–471
 - Status Annunciations -----517
 - Status Box-----473
- Automatic squelch-----121
- Autopilot -----469, 500–502
- Autopilot Disconnect -----471, 491, 502
- Auto-tuning-----129
- Auto-tuning, COM -----115
- Auto-tuning, NAV-----125
- Auto Zoom-----159
- Auxiliary Pages (AUX) -----36
- AUX - system status page 537, 539, 558, 559, 573, 574, 575, 577
- Aviation Symbols-----171, 215

B

- Backlighting -----48, 49
- Barometric setting -----52, 58–59
- Basic Empty Weight -----269
- Basic Operating Weight -----269
- Battery
 - Alerts-----106, 614
 - Current-----91, 95
 - Overheat warning-----105, 613
 - Voltage -----91, 95
- Bearing/distance, measuring-----166
- Bearing information -----53, 65–66
- Bearing line-----388, 392

C

- Cabin pressure altitude -----91, 94
 - Warning -----105, 613

Cabin speaker	142
Calibrated Airspeed	266
Cargo	270
CDI	259, 276, 287, 296, 303, 630
Chart Not Available	541, 561
Chart options	549, 568
CHART SETUP box	555, 571
ChartView	519, 540, 558
Checklists	585–586
Checklist softkeys	585
CLD TOP Softkey	361
Clearance recorder	145
Closest Point	247
CNS system	107
Code selection softkeys	139
COM channel spacing	120
COM frequency box	112
COM frequency window	52
Command Bars	475
Comparator	615
Comparator window	79
COM radio	
Channel spacing	44
COM tuning failure	149
Controls	
Softkeys	22–25
Control Wheel Steering (CWS)	471, 501
Copy a Flight Plan	234
Course deviation indicator (CDI)	52, 67–69
Course Deviation Indicator (CDI)	44
Course To Fix	264
Crew Alerting System (CAS)	103–106
Inhibits	104
Messages	105–106
D	
Data Bar fields, MFD	43
Database	16
Databases	637
Database Synchronization	637, 642, 643
Data link	1
Datalink receiver troubleshooting	611
Data logging	590
Date and time	39
Day/Night views	555, 571
Day view	556, 572
DB Mismatch	637
Dead reckoning	86
Decision height (DH)	53
Declutter	27
Declutter, display	87
Delete Flight Plans	235
Deleting an entire airway	236, 237
Deleting an entire procedure	236, 237
Deleting an individual waypoint	236, 237
Deleting Flight Plan Items	236
Density Altitude	267
Departure	
Select	254, 257, 260, 263
Departure procedure	227, 241, 254, 256
Departure Time	265
Differential cabin pressure	91, 94
Warning	105, 613
Digital audio entertainment	4
Dilution of Precision (DOP)	30
Direct-to	184, 209, 210, 211, 212, 213, 248, 249, 285, 287, 303
Display backup	18, 111
Diversity transponder	135
DME	
HOLD mode	134
NAV1 mode	134
NAV2 mode	134
Tuning mode	131, 134
DME audio	123
DME information window	53, 66
Door status	102
Dual navigation database	638
E	
Electrical indications	97
Electronic checklists	519–520, 585–586
Emergency frequency	149
Engine Indication System (EIS)	91–94
Entertainment inputs	146
Essential bus voltage	91, 95
Estimated Landing Fuel	271
Estimated Position Error (EPE)	30
Ethernet	17
Excess Fuel Weight	271
F	
Failure	
Input	20
Field of View (SVS)	182
Flap position	91, 95
Asymmetrical deflection warning	105, 613
Flight director	469, 472–473
Modes, lateral	492–518
Modes, vertical	476–490
Flight director (FD)	
Switching	474
Flight ID	141
Flight Level Change Mode	481, 508

Flight plan	
Closest point to reference	247
Storing	654
FliteCharts	519, 560
FliteCharts®	519
FliteCharts cycle	574
FliteCharts expiration	574
FliteCharts functions	560
FPA	250, 293
Frequency	
Nearest	204
Frequency spacing	120
Frequency transfer arrow	113
Frequently asked questions	653
Fuel	
Alerts	105–106, 613–614
Efficiency	267
Endurance	267
Flow	91, 94
Pressure	91, 94
Quantity	91, 94
Remaining	267
Required	267
Fuel indications	100
Fuel on Board	267, 270, 271
Fuel Statistics	267
G	
Gain	391
GDC 74A	1
GDL 69/69A	1, 308
GDU 1040	1
GEA 71	1
Generator	
Current	91, 95
Speed	91, 93
geodetic sea level	404, 409, 419
GFC 700	469
GIA 63	1
Glidepath	301
Glidepath indicator	61
Glidepath Mode	488, 497
Glidepath Mode (GP)	514
Glideslope	301
Glideslope indicator	61
Glideslope Mode	490, 512
Global Positioning System (GPS)	
Navigation	209–306
Receiver information	29–31
GMA 1347	1, 16, 48
GMU 44	1
Go Around Mode	491, 515–516
GPS Window	643

Ground mapping	396
GRS 77	1
GSL	404, 409, 419
GTX 33	1
GTX 33/33D Transponder	135

H

Heading	52
Heading Select Mode	494
HI SENS	130
Horizontal scan	386, 387, 388, 389, 390, 394, 395
Horizontal situation indicator (HSI)	52, 62–74
HSI double green arrow	122
HSI magenta arrow	122
HSI single green arrow	122

I

ID indicator	124
ILS approach	512
Indicated airspeed	54
Indicated Altitude	266
Initialization (system)	16
Inset map	53
Inset Map	23, 27
Intercom	143
Intersection	
Information	192–193
Interturbine Temperature (ITT)	91, 93
Warning	105, 613
Inverting a flight plan	234, 244
IOI	416, 427, 633, 634
Iridium	591, 592, 594, 595, 596, 598
Iridium satellite network	591, 598

J

Jeppesen aviation database	637
----------------------------	-----

K

Key(s)	9, 11
--------	-------

L

Land Symbols	170
Lateral modes, flight director	492–518
LNAV	276
LO SENS	130
Low altitude annunciation	82
Low Altitude Annunciation	82
LPV	276, 303, 503

M

Magnetometer	1, 20
Map pages	35

Map Panning	161
Map symbols	657
Marker beacon	130
Marker beacon annunciations	80
MASQ processing	107
Measurement units, changing displayed	40
Menus	33
Message advisories	619, 620, 621, 622, 623, 625, 626, 627, 628, 629, 630, 631
Messages window	584
METAR	327
MFD Data Bar fields	43
Minimum descent altitude, barometric	83
Minimum descent altitude (MDA)	53
Minimums	635
MISCOMP	615
Missed approach	515
Missed Approach	215, 264, 272, 276, 303
MKR/MUTE	130
Mode S	24, 135, 137
Mode selection softkeys	136, 137, 139
Morse code identifier	124
Multi Function Display (MFD)	
Softkeys	27
Music 1	146
Music 1 muting	146
Music 2	146
N	
National Weather Service	336
NAV1 audio	123
NAV2 audio	123
NAV frequency window	52
Navigation database	250, 251
Navigation Map	212
Navigation Mode	495–496, 506–507
Navigation mode selection	122
Navigation source	67–69
Navigation status box	52
Nav radio selection	122
Nearest	
Airports	44, 204–207
VOR	204–205
nearest airport	188, 189, 190
Nearest Airport	188, 189, 190, 191, 262
Minimum Runway Length	191
Surface Matching	191
Nearest airports, frequency tuning	115
Nearest Airports Page	189, 190, 191
Nearest Pages (NRST)	37
NEXRAD	23, 27
NEXRAD Softkey	358
Night view	556, 572
NO COMP	615
Non-path descent	486, 510–511
Normal operating mode	17
O	
OBS mode	73–74
Obstacles	622, 624
Oil, engine	
Alerts	105, 613
Pressure	91, 93
Temperature	91, 93
Omni Bearing Selector (OBS)	654–655
Other Statistics	265, 267
Overspeed protection, autopilot	476
Overview	1
Oxygen	
Pressure	91, 94
Warning	105, 613
P	
Page groups	34–37
Parallel Track	240, 241
Passenger	270
Passenger address (PA) system	144
Passengers	270
PFD failure	150
Pilot and Stores Weight	269
Pilot profiles	45–46
PIREP	370
Pitch Hold Mode	477
Pitch indication	56
Power ON settings	142
Predefined message	602, 603, 605
Primary Flight Display (PFD)	
Softkeys	22–24
Procedures	
GFC 700	503–516
Propeller speed	91, 92
Q	
Quick tuning 121.500 MHz	114
R	
Radar	376
Antenna Tilt Setup	381
Attenuation	378
Interpretation	383
Operation	386
Reflectivity	378
Safe Operating Distance	380
Radar altitude	83, 84

RAIM	259, 272, 273, 274, 275
Range	180
Receiver Autonomous Integrity Monitoring (RAIM)	30–31, 272, 653
Register	346
Required Vertical Speed	294
Required Vertical Speed Indicator	294
Reversionary mode	151
Reversionary Mode	
EICAS	90, 91, 103
Reversionary sensor	616
Reversionary sensor window	79
ROC	416, 427, 633, 634
Roll Hold Mode	493
RS-232	4
RS-485	3
Runway	
Minimum length	44
Surface	44
RVSI	294, 295
RX indicator	113

S

SafeTaxi	519, 534, 537
SafeTaxi®	519
SafeTaxi database	539
SBAS	272, 274, 275, 624, 625, 651, 653
Scheduler	519–520, 583
SD card	15
Sector scan	392
Secure Digital (SD) card	585, 637
Selected altitude	52, 57
Selected Altitude	477, 478, 480, 481, 483, 487
Selected Altitude Capture Mode	477, 478, 479, 480, 483
Selected Altitude Intercept Arc	183
Selected course	53, 63
Selected Course	496, 498, 499
Selected heading	53, 63
Selected Heading	470, 494
Selecting a COM radio	112
Sensor	615, 616
Sequencing, automatic	655
SIGMET	326, 363
Simultaneous COM operation	144
SiriusXM	
Radio	308
SiriusXM radio	578, 580
SiriusXM radio active channel	580
SiriusXM radio channel list	580
SiriusXM radio entertainment	146
SiriusXM radio presets	582
SiriusXM radio service class	579
SiriusXM radio troubleshooting	611

SiriusXM weather/radio	4
Slip/Skid indicator	52, 56
SMS	591, 598, 599, 603
Softkeys	22–25
PFD	52
Synoptics Pages	96
Speaker	142
STAB	393
Standby frequency	112, 115, 122
ADF	131
Standby frequency field	112
Standby Navigation Database	639, 640
Stereo headsets	142
Stormscope	397
Cell and Strike Mode	399
Setup	397
Stuck microphone	149
Sunrise	266
Sunset	266
SVS	631
SVS troubleshooting	609
Symbols, map	657
Synoptics	96–103
Synthetic vision (SVS)	519, 520
System annunciations	21, 616
System Setup Page	38
System Status Page	47
System time	39, 52

T

TA	635
TAF	327, 364, 365
Takeoff Mode	491
TAS	386, 387, 389, 390, 391, 392, 626, 635
TAS (Traffic Advisory System)	
Alerts	466
Operation	461
TAWS	81, 410, 412, 414, 424, 425, 433, 634
Excessive Descent Rate	428
Five-Hundred Aural Alert	430
Forward Looking Terrain Avoidance	428
Inhibiting	430
Negative Climb Rate After Takeoff	430
Premature Descent Alerting	429
System Status	432
TAWS-B	419
TCAS I Traffic	
symbology	447
Telephone	519, 591, 593
Terminal procedures charts	541, 561
Terrain	27, 414, 425, 622, 634
Color indications	659
Terrain Awareness and Warning System	419

Terrain Proximity	404
TERRAIN-SVS	81, 409
Forward Looking Terrain Avoidance	417
System Status	418
Text message	598, 599, 602, 605
Text messaging	598
Tilt	389, 390
Tilt line	390
Time, system	39
TIS (Traffic Information Service)	438
Traffic Map Page	441
TIS (Traffic Information Services)	
System Status	444
TOD	293, 294, 300
TOPO DATA	167, 168, 177
Top of Descent	293, 294
Topographical data	27
TOPO SCALE	169
Torque	91, 92
Warning	105, 613
Track	52, 62
Traffic	27
Annunciation	53, 80
Voice alerts	80
Traffic advisory	386
Traffic Advisory	635
Traffic Information Service (TIS)	
TIS Alerts	443
Transponder code entry	139
Transponder data box	107
Transponder ground mode	137
Transponder mode field	107, 137, 138
Transponder standby mode	137
Transponder status box	52
Trend vector	
Turn Rate	65
Trim	91, 95
Trip Planning	265, 266, 267
Trip Statistics	266, 267
True airspeed	54
True Airspeed	267
Turn anticipation	655
Turn rate indicator	52, 65
TX indicator	113
U	
Unable to display chart	541, 561
Updating Garmin databases	539
V	
VDI	294, 295
Vertical deviation	58, 485
Vertical deviation guidance	251
Vertical Deviation Indicator	294
Vertical deviation indicator (VDI)	61
Vertical navigation	250
Direct-to	249, 250
Vertical Navigation flight control	483–487
Vertical Path Tracking Mode	483–484, 509
Vertical scan	389, 390
Vertical speed guidance	251
Vertical speed indicator (VSI)	52, 61
Vertical Speed Mode	480
Vertical Speed Reference	480
Vertical track	635
VFR code	140
VNAV	213
VNAV Target Altitude	483–486
VNAV Target Altitude Capture Mode	487
VNV	293, 630, 652
VNV guidance	
Disabling	249
Enabling	248
VNV indications, PFD	78
VNV target altitude	61
Voice alerts, TIS Traffic	443, 466
Volume	582
Volume level	
ADF	131, 133
VOR	
Nearest	204–205
VOR selection	122
VSI	295
Vspeeds	55–56
VS TGT	250, 293
W	
WAAS	276, 503, 652, 653
WAAS precision approach	514
WATCH	394, 395
Waypoint	
Automatic sequencing	655
Skipping	655
Waypoint Pages (WPT)	35
Waypoint Selection Submenu	210, 218, 222, 223, 273
Weather Attenuated Color Highlight	394
Weather (real-time)	4
Wind	156, 179
Wind data	53, 77
Winds Aloft	366
WIND Softkey	366
X	
XM WX lightning	23, 27
XM WX Satellite Weather	308
AIRMETs	363

Airrep -----340
 Cell Movement -----325
 City Forecast -----330
 Cloud Tops -----323
 County Warning -----336
 Cyclone (Hurricane) -----337
 Echo Tops-----322
 Freezing Level-----332
 Icing (CIP & SLD) -----338
 Lightning -----324
 NEXRAD -----318
 Limitations -----320
 Pirep-----340
 PIREPs-----340
 SIGMETs -----363
 Surface Analysis -----330
 Turbulence-----339
 Winds Aloft-----333

Z

Zoom
 Auto-----159

BLANK PAGE



GARMIN®



Garmin International, Inc.
1200 East 151st Street
Olathe, KS 66062, U.S.A.
p:913.397.8200
f:913.397.8282

Garmin AT, Inc.
2345 Turner Road SE
Salem, OR 97302, U.S.A.
p:503.391.3411
f:503.364.2138

Garmin (Europe) Ltd.
Liberty House, Bulls Copse Road
Houndsdown Business Park
Southampton, SO40 9RB, U.K.
p:44/0870.8501241
f:44/0870.8501251

Garmin Corporation
No. 68, Jangshu 2nd Road
Shijr, Taipei County, Taiwan
p:886/02.2642.9199
f:886/02.2642.9099

www.garmin.com

