



G1000® Integrated Flight Deck

Cockpit Reference Guide for the Diamond DA42NG



System Software 0670.02 or later

GARMIN ▲

FLIGHT INSTRUMENTS

ENGINE INDICATION SYSTEM

NAV/COM/TRANSPONDER/AUDIO PANEL

AUTOMATIC FLIGHT CONTROL SYSTEM

GPS NAVIGATION

FLIGHT PLANNING

PROCEDURES

HAZARD AVOIDANCE

ADDITIONAL FEATURES

ABNORMAL OPERATION

ANNUNCIATIONS & ALERTS

APPENDIX

INDEX

Copyright © 2009 Garmin Ltd. or its subsidiaries. All rights reserved.

This manual reflects the operation of System Software version 0670.02 or later for the Diamond DA42NG. Some differences in operation may be observed when comparing the information in this manual to earlier or later software versions.

Garmin International, Inc., 1200 East 151st Street, Olathe, Kansas 66062, U.S.A.
Tel: 913/397.8200 Fax: 913/397.8282

Garmin AT, Inc., 2345 Turner Road SE, Salem, OR 97302, U.S.A.
Tel: 503/391.3411 Fax 503/364.2138

Garmin (Europe) Ltd, Liberty House, Bulls Copse Road, Hounslow Business Park,
Southampton, SO40 9RB, U.K.
Tel: 44/0870.8501241 Fax: 44/0870.8501251

Garmin Corporation, No. 68, Jangshu 2nd Road, Shijr, Taipei County, Taiwan
Tel: 886/02.2642.9199 Fax: 886/02.2642.9099

Web Site Address: www.garmin.com

Except as expressly provided herein, no part of this manual may be reproduced, copied, transmitted, disseminated, downloaded or stored in any storage medium, for any purpose without the express written permission of Garmin. Garmin hereby grants permission to download a single copy of this manual and of any revision to this manual onto a hard drive or other electronic storage medium to be viewed for personal use, provided that such electronic or printed copy of this manual or revision must contain the complete text of this copyright notice and provided further that any unauthorized commercial distribution of this manual or any revision hereto is strictly prohibited.

Garmin® and G1000® are registered trademarks of Garmin Ltd. or its subsidiaries. FliteCharts® and SafeTaxi® are trademarks of Garmin Ltd. or its subsidiaries. These trademarks may not be used without the express permission of Garmin.

NavData® is a registered trademark of Jeppesen, Inc.; Stormscope® is a registered trademark of L-3 Communications; and XM® is a registered trademark of XM Satellite Radio, Inc.



WARNING: *Navigation and terrain separation must NOT be predicated upon the use of the terrain avoidance feature. The terrain avoidance feature is NOT intended to be used as a primary reference for terrain avoidance and does not relieve the pilot from the responsibility of being aware of surroundings during flight. The terrain avoidance feature is only to be used as an aid for terrain avoidance. Terrain data is obtained from third party sources. Garmin is not able to independently verify the accuracy of the terrain data.*



WARNING: *The displayed minimum safe altitudes (MSAs) are only advisory in nature and should not be relied upon as the sole source of obstacle and terrain avoidance information. Always refer to current aeronautical charts for appropriate minimum clearance altitudes.*



WARNING: *The altitude calculated by G1000 GPS receivers is geometric height above Mean Sea Level and could vary significantly from the altitude displayed by pressure altimeters, such as the GDC 74A Air Data Computer, or other altimeters in the aircraft. GPS altitude should never be used for vertical navigation. Always use pressure altitude displayed by the G1000 PFD or other pressure altimeters in aircraft.*



WARNING: *Do not use outdated database information. Databases used in the G1000 system must be updated regularly in order to ensure that the information remains current. Pilots using any outdated database do so entirely at their own risk.*



WARNING: *Do not use basemap (land and water data) information for primary navigation. Basemap data is intended only to supplement other approved navigation data sources and should be considered as an aid to enhance situational awareness.*



WARNING: *Traffic information shown on system displays is provided as an aid in visually acquiring traffic. Pilots must maneuver the aircraft based only upon ATC guidance or positive visual acquisition of conflicting traffic.*



WARNING: *XM Weather should not be used for hazardous weather penetration. Weather information provided by the GDL 69A is approved only for weather avoidance, not penetration.*



WARNING: NEXRAD weather data is to be used for long-range planning purposes only. Due to inherent delays in data transmission and the relative age of the data, NEXRAD weather data should not be used for short-range weather avoidance.



WARNING: Use of the Stormscope is not intended for hazardous weather penetration (thunderstorm penetration). Stormscope information, as displayed on the G1000 MFD, is to be used only for weather avoidance, not penetration.



WARNING: The Garmin G1000, as installed in the Diamond DA42NG aircraft, has a very high degree of functional integrity. However, the pilot must recognize that providing monitoring and/or self-test capability for all conceivable system failures is not practical. Although unlikely, it may be possible for erroneous operation to occur without a fault indication shown by the G1000. It is thus the responsibility of the pilot to detect such an occurrence by means of cross-checking with all redundant or correlated information available in the cockpit.



WARNING: For safety reasons, G1000 operational procedures must be learned on the ground.



WARNING: The United States government operates the Global Positioning System and is solely responsible for its accuracy and maintenance. The GPS system is subject to changes which could affect the accuracy and performance of all GPS equipment. Portions of the Garmin G1000 utilize GPS as a precision electronic NAVigation AID (NAVAID). Therefore, as with all NAVAIDs, information presented by the G1000 can be misused or misinterpreted and, therefore, become unsafe.



WARNING: To reduce the risk of unsafe operation, carefully review and understand all aspects of the G1000 Pilot's Guide documentation and the Diamond DA42NG Pilot's Operating Handbook (POH). Thoroughly practice basic operation prior to actual use. During flight operations, carefully compare indications from the G1000 to all available navigation sources, including the information from other NAVAIDs, visual sightings, charts, etc. For safety purposes, always resolve any discrepancies before continuing navigation.



WARNING: The illustrations in this guide are only examples. Never use the G1000 to attempt to penetrate a thunderstorm. Both the FAA Advisory Circular, Subject: Thunderstorms, and the Aeronautical Information Manual (AIM) recommend avoiding “by at least 20 miles any thunderstorm identified as severe or giving an intense radar echo.”



WARNING: Lamp(s) inside this product may contain mercury (HG) and must be recycled or disposed of according to local, state, or federal laws. For more information, refer to our website at www.garmin.com/aboutGarmin/environment/disposal.jsp.



WARNING: Because of anomalies in the earth’s magnetic field, operating the G1000 within the following areas could result in loss of reliable attitude and heading indications. North of 70° North latitude and south of 70° South latitude. An area north of 65° North latitude between longitude 75° West and 120° West. An area south of 55° South latitude between longitude 120° East and 165° East.



CAUTION: The PFD and MFD displays use a lens coated with a special anti-reflective coating that is very sensitive to skin oils, waxes, and abrasive cleaners. **CLEANERS CONTAINING AMMONIA WILL HARM THE ANTI-REFLECTIVE COATING.** It is very important to clean the lens using a clean, lint-free cloth and an eyeglass lens cleaner that is specified as safe for anti-reflective coatings.



CAUTION: The Garmin G1000 does not contain any user-serviceable parts. Repairs should only be made by an authorized Garmin service center. Unauthorized repairs or modifications could void both the warranty and the pilot’s authority to operate this device under FAA/FCC regulations.



NOTE: All visual depictions contained within this document, including screen images of the G1000 panel and displays, are subject to change and may not reflect the most current G1000 system and aviation databases. Depictions of equipment may differ slightly from the actual equipment.



NOTE: This device complies with part 15 of the FCC Rules. Operation is subject to the following two conditions: (1) this device may not cause harmful interference, and (2) this device must accept any interference received, including interference that may cause undesired operation.



NOTE: *The data contained in the terrain and obstacle databases comes from government agencies. Garmin accurately processes and cross-validates the data, but cannot guarantee the accuracy and completeness of the data.*



NOTE: *This product, its packaging, and its components contain chemicals known to the State of California to cause cancer, birth defects, or reproductive harm. This notice is being provided in accordance with California's Proposition 65. If you have any questions or would like additional information, please refer to our web site at www.garmin.com/prop65.*



NOTE: *Interference from GPS repeaters operating inside nearby hangars can cause an intermittent loss of attitude and heading displays while the aircraft is on the ground. Moving the aircraft more than 100 yards away from the source of the interference should alleviate the condition.*



NOTE: *Use of polarized eyewear may cause the flight displays to appear dim or blank.*



NOTE: *The purpose of this Cockpit Reference Guide is to provide the pilot a resource with which to find operating instructions on the major features of the G1000 system more easily. It is not intended to be a comprehensive operating guide. Complete operating procedures for the system are found in the G1000 Pilot's Guide for this aircraft.*

Blank Page

Part Number	Change Summary		
190-00963-00 Rev A	Initial release at GDU 9.05		

Revision	Date of Revision	Affected Pages	Description
Rev B	4/09	i-Index-4	Added Synthetic Vision System

- FLIGHT INSTRUMENTS** 1
 - Selecting the Altimeter Barometric Pressure Setting 1
 - Selecting Standard Barometric Pressure (29.92 in Hg) 1
 - Change Altimeter Barometric Pressure Setting Units 1
 - Change Navigation Sources 1
 - Enable/Disable OBS Mode While Navigating with GPS 2
 - Generic Timer 2
 - Configure Vspeed Bugs 2
 - Set Barometric Minimum Descent Altitude 3
 - Displaying Wind Data 3
 - Changing HSI Format 3
- ENGINE INDICATION SYSTEM** 5
 - Engine Display 5
 - System Display 6
 - Fuel Display 6
- NAV/COM/TRANSPONDER/AUDIO PANEL** 9
 - Enter or Change Flight ID 9
 - ADF Tuning (Optional) 9
 - DME Tuning (Optional) 9
 - Enter a Transponder Code 10
 - Selecting a COM Radio 10
 - Selecting a NAV Radio 10
 - NAV/COM Tuning 10
 - Digital Clearance Recorder and Player 11
 - Intercom System (ICS) Isolation 11
- GFC 700 AUTOMATIC FLIGHT CONTROL SYSTEM** 13
 - Flight Director Activation 13
 - Vertical Modes 14
 - Lateral Modes 15
- GPS NAVIGATION** 17
 - Direct-to Navigation 17
 - Activate a Stored Flight Plan 18
 - Activate a Flight Plan Leg 18
 - Stop Navigating a Flight Plan 19
 - Vertical Navigation (VNAV) 19
- FLIGHT PLANNING** 21
 - Trip Planning 21
 - Create a New User Waypoint 23
 - Delete a User Waypoint 24

Create a New Flight Plan	24
Insert a Waypoint in the Active Flight Plan	25
Enter an Airway in a Flight Plan	26
Invert An Active Flight Plan	26
Remove a Departure, Arrival, Approach, or Airway from a Flight Plan	27
Store a Flight Plan	27
Edit a Stored Flight Plan	27
Delete a Waypoint from the Flight Plan	28
Invert and Activate a Stored Flight Plan	28
Copy a Flight Plan	29
Delete a Flight Plan	29
Graphical Flight Plan Creation	29
PROCEDURES	31
Load and Activate a Departure Procedure	31
Activate A Departure Leg	31
Load An Arrival Procedure	31
Activate An Arrival Leg	32
Load and/or Activate an Approach Procedure	32
Activate An Approach in the Active Flight Plan	33
Activate a Vector to Final Approach Fix	34
Activate A Missed Approach in the Active Flight Plan	34
HAZARD AVOIDANCE	35
Customizing the Hazard Displays on the Navigation Map	35
STORMSCOPE® (Optional)	35
XM Weather (Optional)	37
Traffic Systems	38
Terrain And Obstacle Proximity	40
Terrain-SVS	41
ADDITIONAL FEATURES	43
Synthetic Vision	43
Terminal Procedure Charts	44
XM® Radio Entertainment	46
ABNORMAL OPERATION	49
Reversionary Mode	49
Abnormal COM Operation	49
Hazard Displays with Loss of GPS Position	49
Unusual Attitudes	50
Dead Reckoning	50

- ANNUNCIATIONS & ALERTS** 53
 - WARNING Alerts** 53
 - CAUTION Alerts** 54
 - Annunciation Advisory** 55
 - Message Advisory Alerts** 55
 - AFCS Alerts** 56
 - Terrain-SVS Alerts** 57
 - Terrain-SVS System Status Annunciations** 57
 - Voice Alerts** 58
 - MFD & PFD Message Advisories** 58
 - Database Message Advisories** 59
 - GMA 1347 Message Advisories** 62
 - GIA 63W Message Advisories** 62
 - GEA 71 Message Advisories** 65
 - GTX 33 Message Advisories** 65
 - GRS 77 Message Advisories** 66
 - GMU 44 Message Advisories** 66
 - GDL 69A Message Advisories** 67
 - GDC 74A Message Advisories** 67
 - Miscellaneous Message Advisories** 67

- APPENDIX** 71
 - PFD Softkey Map** 71
 - MFD Softkey Map** 76

- INDEX** Index-1

Blank Page

FLIGHT INSTRUMENTS

SELECTING THE ALTIMETER BAROMETRIC PRESSURE SETTING

Turn the **BARO** Knob to select the desired setting.

SELECTING STANDARD BAROMETRIC PRESSURE (29.92 IN HG)

- 1) Press the **PFD** Softkey.
- 2) Press the **STD BARO** Softkey to set standard barometric pressure.

CHANGE ALTIMETER BAROMETRIC PRESSURE SETTING UNITS

- 1) Press the **PFD** Softkey to display the second-level softkeys.
- 2) Press the **ALT UNIT** Softkey.
- 3) Press the **IN** Softkey to display the barometric pressure setting in inches of mercury (in Hg).

Or:

Press the **HPA** Softkey to display the barometric pressure setting in hectopascals.

- 4) Press the **BACK** Softkey to return to the top-level softkeys.

CHANGE NAVIGATION SOURCES

- 1) Press the **CDI** Softkey to change from GPS to VOR1 or LOC1. This places the light blue tuning box over the NAV1 standby frequency in the upper left corner of the PFD.
- 2) Press the **CDI** Softkey again to change from VOR1 or LOC1 to VOR2 or LOC2. This places the light blue tuning box over the NAV2 standby frequency.
- 3) Press the **CDI** Softkey a third time to return to GPS.

ENABLE/DISABLE OBS MODE WHILE NAVIGATING WITH GPS

- 1) Press the **OBS** Softkey to select OBS Mode.
- 2) Turn a **CRS** Knob to select the desired course to/from the waypoint. Press a **CRS** Knob to synchronize the Selected Course with the bearing to the next waypoint.
- 3) Press the **OBS** Softkey again to disable OBS Mode.

GENERIC TIMER

- 1) Press the **TMR/REF** Softkey, then turn the large **FMS** Knob to select the time field (hh/mm/ss). Turn the **FMS** Knobs to set the desired time, then press the **ENT** Key. The UP/DOWN field is now highlighted.
- 2) Turn the small **FMS** Knob to display the UP/DOWN window. Turn the **FMS** Knob to select 'UP' or 'DOWN', then press the **ENT** Key. 'START?' is now highlighted.
- 3) Press the **ENT** Key to START, STOP, or RESET the timer (if the timer is counting DOWN, it starts counting UP after reaching zero). Press the **CLR** Key or the **TMR/REF** Softkey to remove the window.

CONFIGURE VSPEED BUGS

- 1) Press the **TMR/REF** Softkey.
- 2) Turn the large **FMS** Knob to highlight the desired Vspeed.
- 3) Use the small **FMS** Knob to change the Vspeed in 1-kt increments (when a speed has been changed from a default value, an asterisk appears next to the speed).
- 4) Press the **ENT** Key or turn the large **FMS** Knob to highlight the ON/OFF field
- 5) Turn the small **FMS** Knob clockwise to ON or counterclockwise to OFF.
- 6) To remove the window, press the **CLR** Key or the **TMR/REF** Softkey.

SET BAROMETRIC MINIMUM DESCENT ALTITUDE

- 1) Press the **TMR/REF** Softkey.
- 2) Turn the large **FMS** Knob to highlight the OFF/BARO field to the right of 'MINIMUMS'.
- 3) Turn the small **FMS** Knob clockwise to BARO.
- 4) Press the **ENT** Key.
- 5) Use the small **FMS** Knob to enter the desired altitude.
- 6) Press the **ENT** Key.
- 7) To remove the window, press the **CLR** Key or press the **TMR/REF** Softkey.

DISPLAYING WIND DATA

- 1) Press the **PFD** Softkey.
- 2) Press the **WIND** Softkey to display wind data to the left of the HSI.
- 3) Press one of the **OPTN** softkeys to change how wind data is displayed.
- 4) To remove the Wind Data Window, press the **OFF** Softkey.

CHANGING HSI FORMAT

- 1) Press the **PFD** Softkey.
 - 2) Press the **HSI FRMT** Softkey.
 - 3) Press the **360 HSI** Softkey to display the full size HSI.
- Or:**
Press the **ARC HSI** Softkey to display the arc style HSI.

- Flight Instruments
- EIS
- Nav/Com/XPDR/Audio
- AFCs
- GPS Nav
- Flight Planning
- Procedures
- Hazard Avoidance
- Additional Features
- Abnormal Operation
- Annun/Alerts
- Appendix
- Index

Blank Page

ENGINE INDICATION SYSTEM

ENGINE DISPLAY

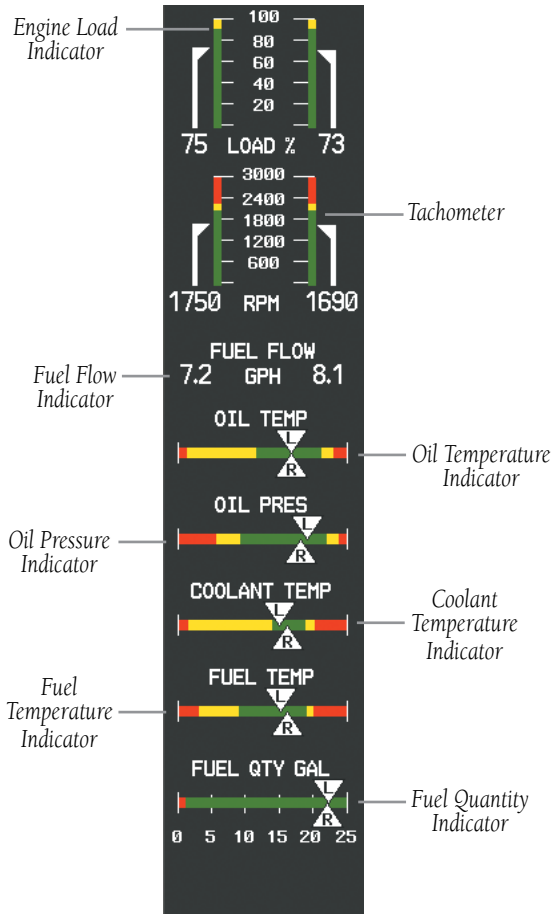

ENGINE Display

SYSTEM DISPLAY

Pressing the **ENGINE** Softkey displays the **SYSTEM** and **FUEL** softkeys. Press the **SYSTEM** Softkey to show the System Display.

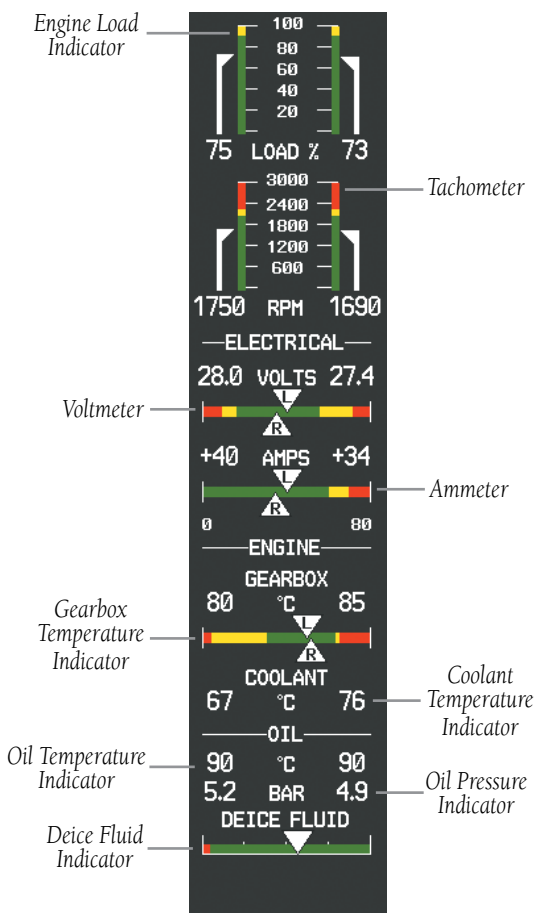

SYSTEM Display

FUEL DISPLAY

Pressing the **ENGINE** Softkey displays the **SYSTEM** and **FUEL** softkeys. Press the **FUEL** Softkey to show the Fuel Display.

Fuel used (GAL USED), endurance (ENDUR), and range (RANGE NM) are all calculated based on the last manual adjustment of the fuel remaining (GAL REM).

Measured fuel quantity has no effect on fuel calculations. Fuel calculations are based on sensed fuel flow and the last manual adjustment of the fuel remaining.

- **DEC FUEL** – Allows the pilot to decrease the gallons of fuel remaining (GAL REM) in 1-gallon increments
- **INC FUEL** – Allows the pilot to increase the gallons of fuel remaining in 1-gallon increments
- **RST FUEL** – Resets the fuel remaining to 50.0 gallons with standard fuel tanks or 76.4 gallons with auxiliary fuel tanks.

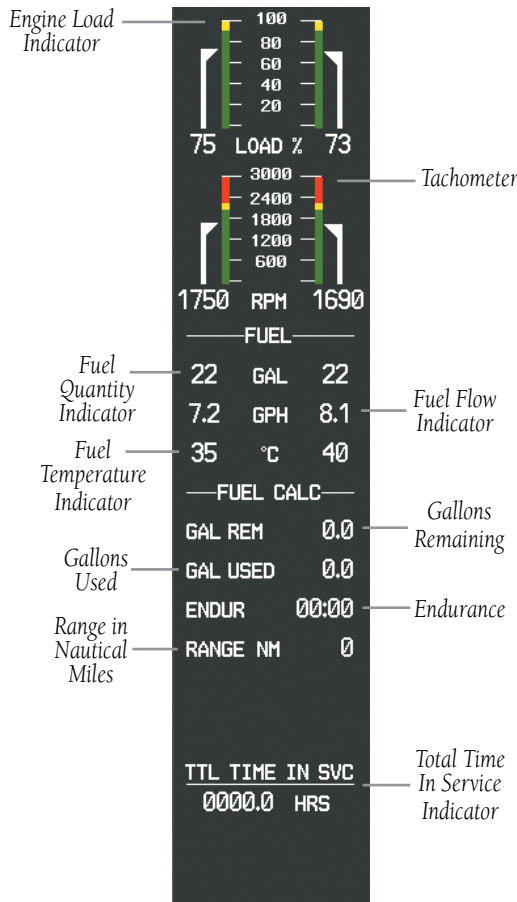

FUEL Display

- Flight Instruments
- EIS
- Nav/Com/XPDR/Audio
- AFCS
- GPS Nav
- Flight Planning
- Procedures
- Hazard Avoidance
- Additional Features
- Abnormal Operation
- Annun/Alerts
- Appendix
- Index

Flight
Instruments

EIS

Nav/Com/
XPDR/Audio

AFCs

GPS Nav

Flight
Planning

Procedures

Hazard
Avoidance

Additional
Features

Abnormal
Operation

Annun/
Alerts

Appendix

Index

Blank Page

NAV/COM/TRANSPONDER/AUDIO PANEL

ENTER OR CHANGE FLIGHT ID

- 1) Press the **TMR/REF** Softkey, then turn the large **FMS** Knob to highlight the Flight ID field.
- 2) Turn the small **FMS** Knob to enter the first character.
- 3) Turn the large **FMS** Knob to select the next field.
- 4) Turn the small **FMS** Knob to enter the next desired character.
- 5) Repeat steps 3 and 4 until the desired Flight ID is entered.
- 6) Press the **ENT** Key to update the Flight ID.

ADF TUNING (OPTIONAL)

- 1) Press the **ADF/DME** Softkey.
- 2) Turn the small **FMS** Knob to enter the first digit of the desired ADF frequency.
- 3) Turn the large **FMS** Knob to select the next desired field.
- 4) Turn the small **FMS** Knob to enter the desired number.
- 5) Repeat steps 3 and 4 until the desired ADF frequency is entered.
- 6) Press the **ENT** Key to accept the new frequency.
- 7) Press the **ENT** Key again to transfer the frequency to the active field.
- 8) Turn the large **FMS** Knob to select the MODE field.
- 9) Turn the small **FMS** Knob to select ANT, ADF, ADF/BFO, or ANT/BFO.
- 10) Press the **ENT** Key to complete the selection.

DME TUNING (OPTIONAL)

- 1) Press the **ADF/DME** or **DME** Softkey.
- 2) Turn the large **FMS** to select the DME source field.
- 3) Turn the small **FMS** Knob to select the desired Nav radio.
- 4) Press the **ENT** Key to complete the selection.

ENTER A TRANSPONDER CODE

- 1) Press the **XPDR** Softkey to display the transponder mode selection softkeys.
- 2) Press the **CODE** Softkey to display the transponder code selection softkeys, for digit entry.
- 3) Press the digit softkeys to enter the code in the code field. When entering the code, the next key in sequence must be pressed within 10 seconds, or the entry is cancelled and restored to the previous code. Five seconds after the fourth digit has been entered, the transponder code becomes active.

SELECTING A COM RADIO

Transmit/Receive

Press the **COM1 MIC**, **COM2 MIC**, or **COM3 MIC** Key (optional COM, if installed) on the audio panel.

Receive Only

Press the **COM1**, **COM2**, or **COM3** Key (optional COM, if installed) on the audio panel.

SELECTING A NAV RADIO

- 1) To begin navigating using a navigation radio, press the **CDI** Softkey on the PFD to select VOR1/LOC1 (NAV1) or VOR2/LOC2 (NAV2).
- 2) Press the **NAV1**, **NAV2**, **DME**, or **ADF** Key on the audio panel to select or deselect the navigation radio audio source. All radio keys can be selected individually or together.

NAV/COM TUNING

- 1) Press the small tuning knob to select the desired radio for tuning. A light blue box highlights the radio frequency to be tuned.
- 2) Turn the respective tuning knobs to enter the desired frequency into the standby frequency field. The large knob enters MHz and the small knob enters kHz.
- 3) Press the **Frequency Transfer** Key to place the frequency into the active frequency field.

DIGITAL CLEARANCE RECORDER AND PLAYER



NOTE: Only the audio for the selected **COM MIC** Key is recorded. Audio is not recorded for COM3 MIC.

- Pressing the **PLAY** Key once plays the latest recorded memory block, then returns to normal operation.
- Pressing the **MKR/MUTE** Key while playing a memory block stops play.
- Pressing the **PLAY** Key during play begins playing the previously recorded memory block. Each subsequent press of the **PLAY** Key begins playing the next previously recorded block.

INTERCOM SYSTEM (ICS) ISOLATION

Press the **PILOT** and/or **COPLT** Key to select those isolated from hearing the Nav/Com radios and music.

Mode	PILOT KEY ANNUNCIATOR	COPLT KEY ANNUNCIATOR	Pilot Hears	Copilot Hears	Passenger Hears
ALL	OFF	OFF	Selected radios; pilot; copilot; passengers; music	Selected radios; pilot; copilot; passengers; music	Selected radios; pilot; copilot; passengers; music
PILOT	ON	OFF	Selected radios; pilot	Copilot; passengers; music	Copilot; passengers; music
COPILOT	OFF	ON	Selected radios; pilot; passengers; music	Copilot	Selected radios; pilot; passengers; music
CREW	ON	ON	Selected radios; pilot; copilot	Selected radios; pilot; copilot	Passengers; music

- Flight Instruments
- EIS
- Nav/Com/XPDR/Audio**
- AFCs
- GPS Nav
- Flight Planning
- Procedures
- Hazard Avoidance
- Additional Features
- Abnormal Operation
- Annun/Alerts
- Appendix
- Index

Blank Page

GFC 700 AUTOMATIC FLIGHT CONTROL SYSTEM



NOTE: If sensor information (other than attitude) required for a flight director mode becomes invalid or unavailable, the flight director automatically reverts to the default mode for that axis.



NOTE: If the attitude information required for the default flight director modes becomes invalid or unavailable, the autopilot automatically disengages.

FLIGHT DIRECTOR ACTIVATION

An initial press of a key listed in the following table (when the flight director is not active) activates the pilot-side flight director in the listed modes.

Control Pressed	Modes Selected			
	Lateral		Vertical	
FD Key	Roll Hold (default)	ROL	Pitch Hold (default)	PIT
AP Key	Roll Hold (default)	ROL	Pitch Hold (default)	PIT
CWS Button	Roll Hold (default)	ROL	Pitch Hold (default)	PIT
GA Button	Takeoff (on ground)	TO	Takeoff (on ground)	TO
	Go Around (in air)	GA	Go Around (in air)	GA
ALT Key	Roll Hold (default)	ROL	Altitude Hold	ALT
VS Key	Roll Hold (default)	ROL	Vertical Speed	VS
VNV Key	Roll Hold (default)	ROL	Vertical Path Tracking*	VPTH
NAV Key	Navigation**	GPS	Pitch Hold (default)	PIT
		VOR		
		LOC		
		BC		
APR Key	Approach**	GPS	Pitch Hold (default)	PIT
		VOR		
		LOC		
HDG Key	Heading Select	HDG	Pitch Hold (default)	PIT

*Valid VNV flight plan must be entered before **VNV** Key press activates flight director.

The selected navigation receiver must have a valid VOR or LOC signal or active GPS course before **NAV or **APR** Key press activates flight director.

VERTICAL MODES

Vertical Mode	Description	Control	Annunciation
Pitch Hold	Holds the current aircraft pitch attitude; may be used to climb/descend to the Selected Altitude	(default)	PIT
Selected Altitude Armed	Captures the Selected Altitude	*	ALTS
Altitude Hold	Holds the current Altitude Reference	ALT Key	ALT nnnnn FT
Vertical Speed	Holds aircraft vertical speed; may be used to climb/descend to the Selected Altitude	VS Key	VS nnnn FPM
Flight Level Change	Holds aircraft airspeed while aircraft is climbing/descending to the Selected Altitude	FLC Key	FLC nnn KT
Vertical Path Tracking	Captures and tracks descent legs of an active vertical profile	VNV Key	VPTH
VNAV Target Altitude Capture	Captures the Vertical Navigation (VNV) Target Altitude	**	ALTV
Glidepath ***	Captures and tracks the WAAS glidepath on approach	APR Key	GP
Glideslope	Captures and tracks the ILS glideslope on approach		GS
Go Around	Disengages the autopilot and commands a constant pitch attitude and wings level in the air	GA Button	GA

* ALTS armed automatically when PIT, VS, FLC, or GA active, and under VPTH when Selected Altitude is to be captured instead of VNAV Target Altitude

** ALTV armed automatically under VPTH when VNAV Target Altitude is to be captured instead of Selected Altitude

***GP is available in installations with GIA 63W IAUs when WAAS is available. Refer to the Airplane Flight Manual to determine whether WAAS functionality is approved.

LATERAL MODES

Lateral Mode	Description	Control	Annunciation
Roll Hold	Holds the current aircraft roll attitude or rolls the wings level, depending on the commanded bank angle	(default)	ROL
Heading Select	Captures and tracks the Selected Heading	HDG Key	HDG
Navigation, GPS	Captures and tracks the selected navigation source (GPS, VOR, LOC)	NAV Key	GPS
Navigation, VOR Enroute Capture/Track			VOR
Navigation, LOC Capture/Track (No Glideslope)			LOC
Navigation, Backcourse Capture/Track	Captures and tracks a localizer signal for backcourse approaches		BC
Approach, GPS	Captures and tracks the selected navigation source (GPS, VOR, LOC)	APR Key	GPS
Approach, VOR Capture/Track			VAPP
Approach, LOC (Glideslope Mode automatically armed)			LOC
Go Around	Disengages the autopilot and commands a constant pitch angle and wings level	GA Button	GA

- Flight Instruments
- EIS
- Nav/Com/XPDR/Audio
- AFCS**
- GPS Nav
- Flight Planning
- Procedures
- Hazard Avoidance
- Additional Features
- Abnormal Operation
- Annun/Alerts
- Appendix
- Index

Blank Page

GPS NAVIGATION

DIRECT-TO NAVIGATION

Direct-to Navigation from the MFD

- 1) Press the **Direct-to** () Key.
- 2) Enter the waypoint identifier.
- 3) Press the **ENT** Key to confirm the identifier. The 'Activate?' field is highlighted.
- 4) If no altitude constraint or course is desired, press the **ENT** Key to activate. To enter an altitude constraint, proceed to step 5.
- 5) Turn the large **FMS** Knob to place the cursor over the 'VNV' altitude field.
- 6) Enter the desired altitude.
- 7) Press the **ENT** Key. If the waypoint entered is an airport, the option to select MSL or AGL is now displayed. If the waypoint is not an airport, proceed to step 9.
- 8) Turn the small **FMS** Knob to select 'MSL' or 'AGL'.
- 9) Press the **ENT** Key. The cursor is now flashing in the VNV offset distance field.
- 10) Enter the desired offset distance before (-) the waypoint.
- 11) Press the **ENT** Key. The 'Activate?' field is highlighted.
- 12) Press the **ENT** Key to activate.

Direct-to Navigation from the PFD

- 1) Press the **Direct-to** Key () .
- 2) Turn the large **FMS** Knob to place the cursor in the desired selection field.
- 3) Turn the small **FMS** Knob to begin selecting the desired identifier, location, etc.
- 4) Press the **ENT** Key.
- 5) The cursor is now flashing on 'ACTIVATE?'. If no altitude constraint or course is desired, press the **ENT** Key to activate. To enter an altitude constraint, proceed to step 6.
- 6) Turn the large **FMS** Knob to place the cursor over the 'ALT' altitude field.

- 7) Turn the small **FMS** Knob to enter the desired altitude.
- 8) Press the **ENT** Key. If the waypoint entered is an airport, the option to select MSL or AGL is now displayed. If the waypoint is not an airport, proceed to step 10.
- 9) Turn the small **FMS** Knob to select 'MSL' or 'AGL'.
- 10) Press the **ENT** Key. The cursor is placed in the 'OFFSET' field.
- 11) Turn the small **FMS** Knob to enter the desired target altitude offset from the selected Direct-to.
- 12) Press the **ENT** Key to highlight 'Activate?' or turn the large **FMS** Knob to highlight the 'CRS' field.
- 13) Turn the small **FMS** Knob to enter the desired course to the waypoint.
- 14) Press the **ENT** Key to highlight 'ACTIVATE?'.
- 15) Press the **ENT** again to activate the Direct-to.

ACTIVATE A STORED FLIGHT PLAN

- 1) Press the **FPL** Key on the MFD and turn the small **FMS** Knob to display the Flight Plan Catalog Page.
- 2) Press the **FMS** Knob to activate the cursor.
- 3) Turn the large **FMS** Knob to highlight the desired flight plan
- 4) Press the **ACTIVE** Softkey. The confirmation window is now displayed.
- 5) With 'OK' highlighted, press the **ENT** Key to activate the flight plan. To cancel the flight plan activation, turn the large **FMS** Knob to highlight 'CANCEL' and press the **ENT** Key.

ACTIVATE A FLIGHT PLAN LEG

- 1) From the Active Flight Plan Page, press the **FMS** Knob to activate the cursor and turn the large **FMS** Knob to highlight the desired waypoint.
- 2) On the MFD, press the **ACT LEG** Softkey.

OR

Press the **MENU** Key, select the 'Activate Leg' option from the page menu and press the **ENT** Key. This step must be used when activating a leg from the PFD.

- 3) With 'Activate' highlighted, press the **ENT** Key.

STOP NAVIGATING A FLIGHT PLAN

- 1) Press the **FPL** Key to display the Active Flight Plan Page.
- 2) Press the **MENU** Key to display the Page Menu Window.
- 3) Turn the large **FMS** Knob to highlight 'Delete Flight Plan' and press the **ENT** Key. With 'OK' highlighted, press the **ENT** Key to deactivate the flight plan. This does not delete the stored flight plan, only the active flight plan.

VERTICAL NAVIGATION (VNAV)

The navigation database only contains altitudes for procedures that call for “Cross at” altitudes. If the procedure states “Expect to cross at,” the altitude is not in the database. In this case the altitude may be entered manually.

ACTIVE FLIGHT PLAN			
KIXD / KDFW			
	DTK	DIS	ALT
KARLA	221°	11.7NM	13000FT
COVIE	221°	9.0NM	12400FT
LEMYN	220°	8.0NM	9900FT
Approach - KDFW-RNAV 17L GPS LPV			
RIVET iaf	259°	18.8NM	4000FT
DRAAK	176°	3.3NM	2000FT
INWOD	176°	3.2NM	3000FT
MENOL faf	176°	3.9NM	2300FT
RW17L map	176°	5.3NM	
990FT	174°	0.8NM	990FT
POLKE			

5000FT

Cross AT or ABOVE 5,000 ft

2300FT

Cross AT 2,300 ft

3000FT

Cross AT or BELOW 3,000 ft

Altitudes associated with approach procedures are “auto-designated”. This means the system automatically uses the altitudes loaded with the approach for giving vertical flight path guidance outside the FAF. Note these altitudes are displayed as small light blue text.

Altitudes associated with arrival procedures are “manually-designated”. This means the system does not use the altitudes loaded with the arrival for giving vertical flight path guidance until designated to do so by the pilot. Note that these altitudes are initially displayed as white text. These altitudes may be “designated” by placing the cursor over the desired altitude and pressing the **ENT** Key. After designation, the text changes to light blue.

Altitudes that have been designated for use in vertical navigation may also be made “non-designated” by placing the cursor over the desired altitude and pressing the **CLR** Key. The altitude is now displayed only as a reference. It will not be used to give vertical flight path guidance. Other displayed altitudes may change due to re-calculations or rendered invalid as a result of manually changing an altitude to a non-designated altitude.

	White Text	Light Blue Text	Light Blue Subdued Text
Large Text	Altitude calculated by the system estimating the altitude of the aircraft as it passes over the navigation point. This altitude is provided as a reference and is not designated to be used in determining vertical flight path guidance.	Altitude has been entered by the pilot. Altitude is designated for use in giving vertical flight path guidance. Altitude does not match the published altitude in navigation database or no published altitude exists.	The system cannot use this altitude in determining vertical flight path guidance.
Small Text	Altitude is not designated to be used in determining vertical flight path guidance. Altitude has been retrieved from the navigation database and is provided as a reference.	Altitude is designated for use in giving vertical flight path guidance. Altitude has been retrieved from the navigation database or has been entered by the pilot and matches a published altitude in the navigation database.	The system cannot use this altitude in determining vertical flight path guidance.

FLIGHT PLANNING

TRIP PLANNING

- 1) Turn the large **FMS** Knob to select the 'AUX' page group.
- 2) Turn the small **FMS** Knob to select the first rectangular page icon.
- 3) The current 'PAGE MODE' is displayed at the top of the page: 'AUTOMATIC' or 'MANUAL'. To change the page mode, press the **AUTO** or **MANUAL** Softkey.
- 4) For Direct-to planning:
 - a) Press the **WPTS** Softkey and verify that the starting waypoint field indicates 'P.POS' (present position).
 - b) If necessary, press the **MENU** Key and select 'Set WPT to Present Position' to display 'P.POS'.
 - c) Press the **ENT** Key and the flashing cursor moves to the ending waypoint field.
 - d) Enter the identifier of the ending waypoint and press the **ENT** Key to accept the waypoint.

Or:

For point-to-point planning:

 - a) Enter the identifier of the starting waypoint.
 - b) Once the waypoint's identifier is entered, press the **ENT** Key to accept the waypoint. The flashing cursor moves to the ending waypoint.
 - c) Again, enter the identifier of the ending waypoint.
 - d) Press the **ENT** Key to accept the waypoint.

Or:

For flight plan leg planning:

 - a) Press the **FPL** Softkey (at the bottom of the display).
 - b) Turn the small **FMS** Knob to select the desired flight plan (already stored in memory), by number.
 - c) Turn the large **FMS** Knob to highlight the 'LEG' field.
 - d) Turn the small **FMS** Knob to select the desired leg of the flight plan, or select 'CUM' to apply trip planning calculations to the entire flight plan.

Selecting 'FPL 00' displays the active flight plan. If an active flight plan is selected, 'REM' is an available option to display planning data for the remainder of the flight plan.



NOTE: The page mode must be set to 'MANUAL' to perform the following steps.

- 5) Turn the large **FMS** Knob to highlight the departure time (DEP TIME) field.



NOTE: The departure time on the Trip Planning Page is used for preflight planning. Refer to the Utility Page for the actual flight departure time.

- 6) Enter the departure time. Press the **ENT** Key when finished. Departure time may be entered in local or UTC time, depending upon system settings.
- 7) The flashing cursor moves to the ground speed (GS) field. Enter the ground speed. Press the **ENT** Key when finished. Note that in 'automatic' page mode, ground speed is provided by the system.
- 8) The flashing cursor moves to the fuel flow field. Enter the fuel flow. Press the **ENT** Key when finished. Note that in 'AUTOMATIC' page mode, fuel flow is provided by the system.
- 9) The flashing cursor moves to the fuel onboard field. Enter the fuel onboard. Press the **ENT** Key when finished. Note that in 'AUTOMATIC' page mode, fuel onboard is provided by the fuel totalizer.
- 10) The flashing cursor moves to the calibrated airspeed (CALIBRATED AS) field. Enter the calibrated airspeed. Press the **ENT** Key when finished. Note that in 'AUTOMATIC' page mode, calibrated airspeed is provided by the system.
- 11) The flashing cursor moves to the altitude (IND ALTITUDE) field. Enter the altitude. Press the **ENT** Key when finished. Note that in 'AUTOMATIC' page mode, altitude is provided by the system.
- 12) The flashing cursor moves to the barometric setting (PRESSURE) field. Enter the desired baro setting. Press the **ENT** Key when finished. Note that in 'AUTOMATIC' page mode, the baro setting is provided by the setting entered on the PFD.
- 13) The flashing cursor moves to the air temperature (TOTAL AIR TEMP) field. Enter the desired air temperature. Press the **ENT** Key when finished. Note that in 'AUTOMATIC' page mode, air temperature is provided by the system outside air temperature.

CREATE A NEW USER WAYPOINT

- 1) Turn the large **FMS** Knob to select the 'WPT' page group.
- 2) Turn the small **FMS** Knob to select the User WPT Information Page.
- 3) Press the **NEW** Softkey. A waypoint is created at the current aircraft position.
- 4) Enter the desired waypoint name.
- 5) Press the **ENT** Key.
- 6) The cursor is now in the 'REFERENCE WAYPOINTS' field. If desired, the waypoint can be defined by a reference waypoint. Use one of the following methods to enter the reference waypoint:
 - a) Turn the small **FMS** Knob to the left to display a list of flight plan waypoints. This list is populated only when there is an active flight plan.
 - b) Turn the large **FMS** Knob to select the desired waypoint.
 - c) Press the **ENT** Key.

Or:

 - a) Turn the small **FMS** Knob to the left. Initially, a flight plan waypoint list is displayed.
 - b) Turn the small **FMS** Knob to the right to display the 'NRST' waypoints to the aircraft's current position.
 - c) Turn the large **FMS** Knob to select the desired waypoint.
 - d) Press the **ENT** Key.

Or:

 - a) Turn the small **FMS** Knob to the left. Initially, a flight plan waypoint list is displayed.
 - b) Turn the small **FMS** Knob to the right to display the 'RECENT' waypoints.
 - c) Turn the large **FMS** Knob to select the desired waypoint.
 - d) Press the **ENT** Key.
- 7) After pressing the **ENT** Key, the cursor is displayed in the 'RAD' (radial) field. Enter the desired radial from the reference waypoint.
- 8) Press the **ENT** Key.

- 9) The cursor is now displayed in the 'DIS' (distance) field. Enter the desired distance from the reference waypoint.
- 10) Press the **ENT** Key. The cursor is now placed for entering another reference waypoint, if desired.
- 11) Press the **FMS** Knob to remove the flashing cursor.

DELETE A USER WAYPOINT

- 1) Turn the large **FMS** Knob to select the 'WPT' page group.
- 2) Turn the small **FMS** Knob to select the User WPT Information Page.
- 3) Press the **FMS** Knob to activate the cursor.
- 4) Turn the large **FMS** Knob to the place the cursor in the 'USER WAYPOINT LIST' field.
- 5) Turn the small **FMS** Knob to highlight the desired waypoint.
- 6) Press the **DELETE** Softkey.
- 7) The message 'Would you like to delete the user waypoint?' is displayed. With 'YES' highlighted, press the **ENT** Key.

CREATE A NEW FLIGHT PLAN



NOTE: When creating a new flight plan in the Active Flight Plan Window, the first leg is activated automatically after it is created.

Using the MFD

- 1) Press the **FPL** Key.
- 2) Turn the small **FMS** Knob to display the Flight Plan Catalog Page.
- 3) Press the **NEW** Softkey to display a blank flight plan for the first empty storage location.
- 4) Turn the small **FMS** Knob to display the Waypoint Information Window.
- 5) Enter the identifier of the departure waypoint.
- 6) Press the **ENT** Key.
- 7) Repeat step number 4, 5, and 6 to enter the identifier for each additional flight plan waypoint.
- 8) When all waypoints have been entered, press the **FMS** Knob to return to the Flight Plan Catalog Page. The new flight plan is now in the list.

Using the PFD



NOTE: If a flight plan is active, an additional flight plan cannot be entered using the PFD.

- 1) Press the **FPL** Key.
- 2) Turn the small **FMS** Knob to display the Waypoint Information Page.
- 3) Turn the small **FMS** Knob to enter the first letter of the destination waypoint identifier.
- 4) Turn the large **FMS** Knob to the right to move the cursor to the next character position.
- 5) Repeat step 3 and 4 to spell out the rest of the waypoint identifier.
- 6) Press the **ENT** Key and the cursor is now ready for entering of the next flight plan waypoint.
- 7) Repeat steps 3 through 6 to enter the identifier for each additional flight plan waypoint.
- 8) Once all waypoints have been entered, press the **FMS** Knob to remove the cursor. The new flight plan is now active.

INSERT A WAYPOINT IN THE ACTIVE FLIGHT PLAN

- 1) Press the **FPL** Key to display the active flight plan.
- 2) If necessary, press the **FMS** Knob to activate the cursor.
- 3) Turn the large **FMS** Knob to highlight the desired flight plan waypoint. The new waypoint is inserted before the highlighted waypoint.
- 4) Turn the small **FMS** Knob. The Waypoint Information Window is now displayed.
- 5) Enter the new flight plan waypoint by one of the following:
 - a) Enter the user waypoint identifier, facility, or city.
 - b) Press the **ENT** Key.

Or:

 - a) Turn the small **FMS** Knob to the left. Initially, a flight plan waypoint list is displayed.
 - b) Turn the small **FMS** Knob to the right to display the 'NRST' airport waypoints to the aircraft's current position.

- c) Turn the large **FMS** Knob to select the desired waypoint.
- d) Press the **ENT** Key.

Or:

- a) Turn the small **FMS** Knob to the left. Initially, a flight plan waypoint list is displayed.
- b) Turn the small **FMS** Knob to the right to display the 'RECENT' waypoints.
- c) Turn the large **FMS** Knob to select the desired waypoint.
- d) Press the **ENT** Key.
- e) Press the **ENT** Key again to "accept" the waypoint.

ENTER AN AIRWAY IN A FLIGHT PLAN

- 1) Press the **FPL** Key.
- 2) Press the **FMS** Knob to activate the cursor (not required on the PFD).
- 3) Turn the large **FMS** Knob to highlight the waypoint after the desired airway entry point. If this waypoint is not a valid airway entry point, a valid entry point should be entered at this time.
- 4) Turn the small **FMS** Knob one click clockwise and press the **LD AIRWY** Softkey, or press the **MENU** Key and select "Load Airway". The Select Airway Page is displayed. The **LD AIRWY** Softkey or the "Load Airway" menu item is available only when an acceptable airway entry waypoint has been chosen (the waypoint ahead of the cursor position).
- 5) Turn the **FMS** Knob to select the desired airway from the list, and press the **ENT** Key. Low altitude airways are shown first in the list, followed by "all" altitude airways, and then high altitude airways.
- 6) Turn the **FMS** Knob to select the desired airway exit point from the list, and press the **ENT** Key. 'LOAD?' is highlighted.
- 7) Press the **ENT** Key. The system returns to editing the flight plan with the new airway inserted.

INVERT AN ACTIVE FLIGHT PLAN

- 1) Press the **FPL** Key to display the active flight plan.
- 2) Press the **MENU** Key to display the Page Menu.

- 3) Turn the large **FMS** Knob to highlight 'Invert Flight Plan'.
- 4) Press the **ENT** Key. The original flight plan remains intact in its flight plan catalog storage location.
- 5) With 'OK' highlighted, press the **ENT** Key to invert the flight plan.

REMOVE A DEPARTURE, ARRIVAL, APPROACH, OR AIRWAY FROM A FLIGHT PLAN

- 1) Press the **FPL** Key to display the active flight plan. Press the **FMS** Knob to activate the cursor.

Or, for a stored flight plan:

- a) Press the **FPL** Key on the MFD and turn the small **FMS** Knob to select the Flight Plan Catalog Page.
 - b) Press the **FMS** Knob to activate the cursor.
 - c) Turn the large **FMS** Knob to highlight the desired flight plan.
 - d) Press the **EDIT** Softkey.
- 2) Turn the large **FMS** Knob to highlight the title for the approach, departure, arrival, or airway to be deleted. Titles appear in white directly above the procedure's waypoints.
 - 3) Press the **CLR** Key to display a confirmation window.
 - 4) With 'OK' highlighted, press the **ENT** Key to remove the selected procedure or airway.

STORE A FLIGHT PLAN

- 1) After creating a flight plan on either the PFD or MFD, it may be saved by pressing the **MENU** Key.
- 2) Turn the large **FMS** Knob to highlight 'Store Flight Plan' and press the **ENT** Key.
- 3) With 'OK' highlighted, press the **ENT** Key to store the flight plan.

EDIT A STORED FLIGHT PLAN

- 1) Press the **FPL** Key on the MFD and turn the small **FMS** Knob to display the Flight Plan Catalog Page.
- 2) Press the **FMS** Knob to activate the cursor.
- 3) Turn the large **FMS** Knob to highlight the desired flight plan.

- 4) Press the **EDIT** Softkey.
- 5) Turn the large **FMS** Knob to place the cursor in the desired location.
- 6) Enter the changes, then press the **ENT** Key.
- 7) Press the **FMS** Knob to return to the Flight Plan Catalog Page.

DELETE A WAYPOINT FROM THE FLIGHT PLAN

- 1) Press the **FPL** Key to display the active flight plan. Press the **FMS** Knob to activate the cursor.

Or, for a stored flight plan:

- a) Press the **FPL** Key on the MFD and turn the small **FMS** Knob to select the Flight Plan Catalog Page.
 - b) Press the **FMS** Knob to activate the cursor.
 - c) Turn the large **FMS** Knob to highlight the desired flight plan.
 - d) Press the **EDIT** Softkey.
- 2) Turn the large **FMS** Knob to highlight the waypoint to be deleted.
 - 3) Press the **CLR** Key to display a 'REMOVE (Wpt Name)?' confirmation window.
 - 4) With 'OK' highlighted, press the **ENT** Key to remove the waypoint. To cancel the delete request, turn the large **FMS** Knob to highlight 'CANCEL' and press the **ENT** Key.
 - 5) Once all changes have been made, press the **FMS** Knob to remove the cursor.

INVERT AND ACTIVATE A STORED FLIGHT PLAN

- 1) Press the **FPL** Key on the MFD.
- 2) Turn the small **FMS** Knob to select the Flight Plan Catalog Page.
- 3) Press the **FMS** Knob to activate the cursor.
- 4) Turn the large **FMS** Knob to highlight the desired flight plan.
- 5) Press the **INVERT** Softkey. 'Invert and activate stored flight plan?' is displayed.
- 6) With 'OK' highlighted, press the **ENT** Key. The selected flight plan is now inverted and activated. The original flight plan remains intact in its flight plan catalog storage location.

COPY A FLIGHT PLAN

- 1) Press the **FPL** Key on the MFD.
- 2) Turn the small **FMS** Knob to select the Flight Plan Catalog Page.
- 3) Press the **FMS** Knob to activate the cursor.
- 4) Turn the large **FMS** Knob to highlight the flight plan to be copied.
- 5) Press the **COPY** Softkey. A 'Copy to flight plan #' confirmation window is displayed.
- 6) With 'OK' highlighted, press the **ENT** Key to copy the flight plan. To cancel, turn the large **FMS** Knob to highlight 'CANCEL' and press the **ENT** Key.

DELETE A FLIGHT PLAN

- 1) Press the **FPL** Key on the MFD.
- 2) Turn the small **FMS** Knob to select the Flight Plan Catalog Page.
- 3) Press the **FMS** Knob to activate the cursor.
- 4) Turn the large **FMS** Knob to highlight the flight plan to be deleted.
- 5) Press the **DELETE** Softkey. A 'Delete flight plan #' confirmation window is displayed.
- 6) With 'OK' highlighted, press the **ENT** Key to delete the flight plan. To cancel, turn the large **FMS** Knob to highlight 'CANCEL' and press the **ENT** Key.

GRAPHICAL FLIGHT PLAN CREATION

- 1) Press the **FPL** Key to display the Active Flight Plan Page on the MFD.
- 2) Press the **Joystick** to activate the map pointer. Use the **Joystick** to move the pointer to the desired point on the map to be inserted as a waypoint in the flight plan.
- 3) The default insertion point is at the end of the flight plan. If the selected waypoint is to be placed anywhere other than the end of the flight plan, press the **FMS** Knob to activate the cursor. Waypoints are inserted *ABOVE* the cursor. Turn the large **FMS** Knob to select the desired insertion point.
- 4) Press the **LD WPT** Softkey. The selected waypoint is inserted at the selected point. The default user waypoint naming is USR000, USR001, USR002, and so on.
- 5) To change the user waypoint name, follow the procedure for modifying a user waypoint.

- Flight Instruments
- EIS
- Nav/Com/XPDR/Audio
- AFCs
- GPS Nav
- Flight Planning**
- Procedures
- Hazard Avoidance
- Additional Features
- Abnormal Operation
- Annun/Alerts
- Appendix
- Index

Blank Page

PROCEDURES

LOAD AND ACTIVATE A DEPARTURE PROCEDURE

- 1) Press the **PROC** Key.
- 2) Turn the large **FMS** Knob to highlight 'SELECT DEPARTURE'.
- 3) Press the **ENT** Key. The cursor is displayed in the 'DEPARTURE' field with a list of available departures.
- 4) Turn the large **FMS** Knob to highlight the desired departure.
- 5) Press the **ENT** Key. A list of runways may be displayed for the departure. If so, turn either **FMS** Knob to select the desired runway.
- 6) Press the **ENT** Key. The cursor is displayed in the 'TRANSITION' field with a list of available transitions.
- 7) Turn the large **FMS** Knob to highlight the desired transition.
- 8) Press the **ENT** Key.
- 9) With 'LOAD?' highlighted, press the **ENT** Key. The departure is active when the flight plan is active.

ACTIVATE A DEPARTURE LEG

- 1) Press the **FPL** Key on the MFD to display the active flight plan.
- 2) Press the **FMS** Knob to activate the cursor.
- 3) Turn the large **FMS** Knob to highlight the desired waypoint within the departure.
- 4) Press the **ACT LEG** Softkey. A confirmation window showing the selected leg is displayed.
- 5) With 'ACTIVATE' highlighted, press the **ENT** Key.

LOAD AN ARRIVAL PROCEDURE

- 1) Press the **PROC** Key.
- 2) Turn the large **FMS** Knob to highlight 'SELECT ARRIVAL'.
- 3) Press the **ENT** Key. The cursor is displayed in the 'ARRIVAL' field with a list of available arrivals.

- 4) Turn the large **FMS** Knob to highlight the desired arrival.
- 5) Press the **ENT** Key. A list of transitions is displayed for the selected arrival.
- 6) Turn either **FMS** Knob to select the desired transition.
- 7) Press the **ENT** Key. A list of runways may be displayed for the selected arrival.
- 8) Turn the large **FMS** Knob to highlight the desired runway.
- 9) Press the **ENT** Key.
- 10) With 'LOAD?' highlighted, press the **ENT** Key.
- 11) The arrival becomes part of the active flight plan.
- 12) If an altitude associated with a waypoint in an arrival procedure is to be used to calculate vertical guidance perform the following steps:
 - a) Press the **FMS** Knob to activate the cursor.
 - b) Turn the large **FMS** Knob to highlight the desired waypoint altitude.
 - c) Press the **ENT** Key to designate the altitude for use in giving vertical guidance.

ACTIVATE AN ARRIVAL LEG

- 1) Press the **FPL** Key to display the active flight plan.
- 2) Press the **FMS** Knob to activate the cursor.
- 3) Turn the large **FMS** Knob to highlight the desired waypoint within the arrival.
- 4) Press the **ACT LEG** Softkey. A confirmation window showing the selected leg is displayed.
- 5) With 'ACTIVATE' highlighted, press the **ENT** Key.

LOAD AND/OR ACTIVATE AN APPROACH PROCEDURE



NOTE: *If certain GPS parameters (WAAS, RAIM, etc.) are not available, some published approach procedures for the desired airport may not be displayed in the list of available approaches.*

- 1) Press the **PROC** Key.
- 2) Turn the large **FMS** Knob to highlight 'SELECT APPROACH'.

- 3) Press the **ENT** Key. A list of available approaches for the destination airport is displayed.
- 4) Turn either **FMS** Knob to highlight the desired approach.
- 5) Press the **ENT** Key. A list of available transitions for the selected approach procedure is now displayed.
- 6) Turn either **FMS** Knob to select the desired transition. The “Vectors” option assumes vectors will be received to the final course segment of the approach and will provide navigation guidance relative to the final approach course.
- 7) Press the **ENT** Key. The cursor moves to the MINIMUMS field.
- 8) If desired, the DA/MDA for the selected approach procedure may be entered and displayed on the PFD. Turn the small **FMS** Knob in the direction of the green arrow to change the display from OFF to BARO.
- 9) Press the **ENT** Key. The cursor moves to the altitude field. Turn the small **FMS** Knob to enter the published DA/MDA for the selected approach procedure.
- 10) Press the **ENT** Key. ‘LOAD?’ or ‘ACTIVATE?’ is now displayed with ‘LOAD?’ highlighted.
- 11) Turn the large **FMS** Knob to select either ‘LOAD?’ or ‘ACTIVATE?’.
 Selecting ‘LOAD?’ enters the selected approach procedure into the active flight plan, but is not currently active. Selecting ‘ACTIVATE?’ enters the selected approach procedure into the active flight plan and activates the first leg of the approach.
- 12) Press the **ENT** Key.

ACTIVATE AN APPROACH IN THE ACTIVE FLIGHT PLAN

- 1) Press the **PROC** Key.
- 2) Turn the large **FMS** Knob to highlight ‘ACTIVATE APPROACH’.
- 3) Press the **ENT** Key.

ACTIVATE A VECTOR TO FINAL APPROACH FIX

- 1) Press the **PROC** Key.
- 2) Turn the large **FMS** Knob to highlight 'ACTIVATE VECTOR-TO-FINAL'.
- 3) Press the **ENT** Key.
- 4) The final approach course becomes the active leg.

ACTIVATE A MISSED APPROACH IN THE ACTIVE FLIGHT PLAN

- 1) Press the **PROC** Key.
- 2) Turn the large **FMS** Knob to highlight 'ACTIVATE MISSED APPROACH'.
- 3) Press the **ENT** Key. A confirmation window is displayed.
- 4) With 'ACTIVATE' highlighted, press the **ENT** Key.

Or:

Press the Go-around Switch:

HAZARD AVOIDANCE

CUSTOMIZING THE HAZARD DISPLAYS ON THE NAVIGATION MAP

- 1) With the Navigation Map Page displayed, press the **MENU** Key to display the Navigation Map Page Menu. The cursor flashes on the 'Map Setup' option.
- 2) Press the **ENT** Key. The Map Setup Menu is displayed. Turn the small **FMS** Knob to select 'Weather' to customize the display of weather features. Select 'Traffic' to customize the display of traffic.
- 3) Press the small **FMS** Knob to return to the Navigation Map Page.





STORMSCOPE® (OPTIONAL)



WARNING: The Stormscope system is not intended to be used for hazardous thunderstorm penetration. Weather information on the G1000 MFD is approved for weather avoidance only. Refer to the WX-500 Pilot's Guide for detailed operation.

Displaying Stormscope Lightning Data on the Navigation Map Page

- 1) Press the **MAP** Softkey.
- 2) Press the **STRMSCP** Softkey. Press the **STRMSCP** Softkey again to remove Stormscope Lightning Data from the Navigation Map Page.

Lightning Age	Symbol
Strike is less than 6 seconds old	
Strike is between 6 and 60 seconds old	
Strike is between 1 and 2 minutes old	
Strike is between 2 and 3 minutes old	

Select 'Cell' or 'Strike' as the Stormscope Lightning Mode

- 1) With the Weather Group selected, press the **ENT** Key. The cursor flashes on 'STRMSCP LTNG'.
- 2) Turn the large **FMS** Knob to select 'STRMSCP MODE'.

- 3) Turn the small **FMS** Knob to display the 'Cell/Strike' window.
- 4) Turn either **FMS** Knob to select 'Cell' or 'Strike'. Press the **ENT** Key.
- 5) Push the **FMS** Knob to return to the Navigation Map Page.

Clear Stormscope Lightning Data from the Navigation Map Page

- 1) Press the **MENU** Key (with the Navigation Map Page displayed).
- 2) Turn either **FMS** Knob to highlight the 'Clear Stormscope® Lightning' field and press the **ENT** Key.



NOTE: If heading input is lost, strikes and/or cells must be cleared manually after the execution of each turn. This is to ensure that the strike and/or cell positions are depicted accurately in relation to the nose of the aircraft.

Stormscope Page

- 1) Turn the large **FMS** Knob until the Map Page group is selected.
- 2) Turn the small **FMS** Knob until the Stormscope Page is selected.

Change the Stormscope Lightning Mode Between 'Cell' and 'Strike'

- 1) Select the Stormscope Page.
- 2) Press the **MODE** Softkey. The **CELL** and **STRIKE** Softkeys are displayed. Press the **CELL** Softkey to display 'CELL' data or press the **STRIKE** Softkey to display 'STRIKE' data. 'CELL' or 'STRIKE' is displayed in the mode box located in the upper left corner of the Stormscope Page.



NOTE: "Cell mode" uses a clustering program to identify clusters of electrical activity that indicate cells.

Change the Viewing Mode Between 360° and 120°

- 1) Select the Stormscope Page.
- 2) Press the **VIEW** Softkey. The **360** and **ARC** Softkeys are displayed. Press the **360** Softkey to display a 360° viewing area or press the **ARC** Softkey to display a 120° viewing area.

Press the **CLEAR** Softkey to remove all Stormscope lightning data from the display.

XM WEATHER (OPTIONAL)



WARNING: Use of XM weather for hazardous weather penetration is not recommended. Weather information provided by XM Radio Service is approved only for weather avoidance, not penetration.

Displaying XM Weather on the Navigation Map Page

- 1) Press the **MAP** Softkey.
- 2) Press the **NEXRAD** or **XM LTNG** Softkey to display the desired weather. Press the applicable softkey again to remove weather data from the Navigation Map Page.

Display METAR and TAF information on the Airport Information Page

- 1) Turn the large **FMS** Knob to select the WPT Page Group.
- 2) Turn the small **FMS** Knob to select the Airport Information Page.
- 3) Press the **WX** Softkey to display METAR and TAF text (METAR and TAF information is updated every 12 minutes).

Displaying Weather on the Weather Data Link Page

- 1) Turn the large **FMS** Knob to select the Map Page Group.
- 2) Turn the small **FMS** Knob to select the Weather Data Link Page.
- 3) Press the available softkeys to select the desired XM weather product.
- 4) Press the **LEGEND** Softkey to view the legends for the selected products. If necessary, turn either **FMS** Knob to scroll through the list. Press the small **FMS** Knob or the **ENT** Key to return to the map.

Map Panning Information – Weather Data Link Page

- 1) Push in the **Joystick** to display the panning arrow.
- 2) Move the **Joystick** to place the panning arrow on AIRMETS, TFRs, METARs, or SIGMETs.
- 3) Press the **ENT** Key to display pertinent information for the selected product.

Note that pressing the **ENT** Key when panning over an AIRMET or a SIGMET displays an information box that shows the text of the report. Panning over an airport with METAR information does not display more information but allows the user to press the **ENT** Key and select that

Airport's Information Page to display the text of the report. Pressing the **ENT** Key when panning over a TFR displays TFR specific information.

Weather Products and Symbols

Echo Top (Cloud Top and Echo Top Mutually Exclusive)

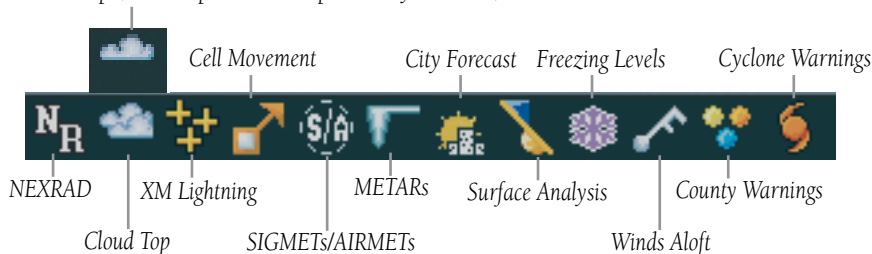

TRAFFIC SYSTEMS

- If Traffic information Service (TIS) is configured, **STANDBY**, **OPERATE**, and **TNA MUTE** softkeys are displayed.
- If a Traffic Advisory System (TAS) is configured, **MUTE** and **ALT MODE** softkeys are displayed.

Traffic Symbol	Description
	Non-Threat Traffic (intruder is beyond 5 nm and greater than 1200' vertical separation)
	Proximity Advisory (PA) (Not available with TIS system) (intruder is within 5 nm and less than 1200' vertical separation)
	Traffic Advisory (TA) (closing rate, distance, and vertical separation meet TA criteria)
	Traffic Advisory Off Scale

Traffic Symbol Description

Traffic Information Service (TIS)



NOTE: If the G1000 is configured to use an optional Traffic Advisory System (TAS), TIS is not available for use.



NOTE: *Traffic Information Service (TIS) is only available when the aircraft is within the service volume of a TIS capable terminal radar site.*

Displaying Traffic on the Traffic Map Page

- 1) Turn the large **FMS** Knob to select the Map Page Group.
- 2) Turn the small **FMS** Knob to select the Traffic Map Page.
- 3) Press the **OPERATE** Softkey to begin displaying traffic. 'OPERATING' is displayed in the Traffic Mode field.
- 4) Press the **STANDBY** Softkey to place the system in the Standby Mode. 'STANDBY' is displayed in the Traffic Mode field.
- 5) Rotate the **Joystick** clockwise to display a larger area or rotate counter-clockwise to display a smaller area.
- 6) Press the **TNA MUTE** Softkey to mute the "Traffic Not Available" aural alert.

Displaying Traffic on the Navigation Map

- 1) Ensure TIS is operating. With the Navigation Map displayed, press the **MAP** Softkey.
- 2) Press the **TRAFFIC** Softkey. Traffic is now displayed on the map.

Traffic Advisory System (TAS) (Optional)

Displaying Traffic on the Traffic Map Page

- 1) Turn the large **FMS** Knob to select the Map Page Group.
- 2) Turn the small **FMS** Knob to select the Traffic Map Page. 'OPERATING' is displayed in the Traffic Mode field.
- 3) Press the **ALT MODE** Softkey to change the altitude volume. Select the desired altitude volume by pressing the **BELOW**, **NORMAL**, **ABOVE**, or **UNREST** (unrestricted) Softkey. The selection is displayed in the Altitude Mode field.
- 4) Rotate the **Joystick** clockwise to display a larger area or rotate counter-clockwise to display a smaller area.
- 5) Press the **MUTE** Softkey to mute TAS voice alerts.

Displaying Traffic on the Navigation Map

- 1) Ensure TAS is operating.
- 2) With the Navigation Map displayed, press the **MAP** Softkey.
- 3) Press the **TRAFFIC** Softkey. Traffic is now displayed on the map.

TERRAIN AND OBSTACLE PROXIMITY



NOTE: Terrain data is not displayed when the aircraft latitude is greater than 75 degrees north or 60 degrees south.

Displaying Terrain and Obstacles on the Terrain Proximity Page

- 1) Turn the large **FMS** Knob to select the Map Page Group.
- 2) Turn the small **FMS** Knob to select the last rectangular page icon.
- 3) If desired, press the **VIEW** Softkey to access the **ARC** and **360** Softkeys. When the **ARC** Softkey is pressed, a radar-like 120° view is displayed. Press the **360** Softkey to return to the 360° default display.
- 4) Rotate the **Joystick** clockwise to display a larger area or rotate counter-clockwise to display a smaller area.

Color	Terrain/Obstacle Location
Red	Terrain/Obstacle above or within 100' below current aircraft altitude.
Yellow	Terrain/Obstacle between 100' and 1000' below current aircraft altitude.
Black	Terrain/Obstacle is more than 1000' below aircraft altitude.

Displaying Terrain and Obstacles on the Navigation Map

- 1) With the Navigation Map displayed, press the **MAP** Softkey.
- 2) Press the **TERRAIN** Softkey. Terrain and obstacle proximity will now be displayed on the map.

TERRAIN-SVS



NOTE: Terrain-SVS is only available when the Synthetic Vision System (SVS) option is installed.



NOTE: Terrain data is not displayed when the aircraft latitude is greater than 75 degrees north or 60 degrees south.

Display Terrain on the TERRAIN-SVS Page

- 1) Turn the large **FMS** Knob to select the Map Page Group.
- 2) Turn the small **FMS** Knob to select the Terrain-SVS Page.
- 3) If desired, press the **VIEW** Softkey to access the **ARC** and **360** softkeys. When the **ARC** Softkey is selected, a radar-like 120° view is displayed. Press the **360** Softkey to return to the 360° default display.
- 4) Rotate the **Joystick** clockwise to display a larger area or rotate counter-clockwise to display a smaller area.

Color	Terrain/Obstacle Location
Red	Terrain/Obstacle above or within 100' below current aircraft altitude.
Yellow	Terrain/Obstacle between 100' and 1000' below current aircraft altitude.
Black	Terrain/Obstacle is more than 1000' below aircraft altitude.

Enable/Disable Aviation Data

- 1) While the Terrain-SVS Page is displayed, press the **MENU** Key.
- 2) Turn the small **FMS** Knob to select "Show (or Hide) Aviation Data".
- 3) Press the **ENT** Key.

Terrain-SVS Inhibit

Inhibit Terrain

While the Terrain-SVS Page is displayed, press the **INHIBIT** Softkey.

Or:

- 1) Press the **MENU** Key.
- 2) Turn the small **FMS** Knob to select 'Inhibit Terrain'.
- 3) Press the **ENT** Key.

Enable Terrain

While the Terrain-SVS Page is displayed, press the **INHIBIT** Softkey.

Or:

- 1) While the Terrain-SVS Page is displayed, press the **MENU** Key.
- 2) Turn the small **FMS** Knob to select 'Enable Terrain'.
- 3) Press the **ENT** Key.

ADDITIONAL FEATURES

SYNTHETIC VISION



WARNING: Use appropriate primary systems for navigation, and for terrain, obstacle, and traffic avoidance. SVS is intended as an aid to situational awareness only and may not provide the accuracy and/or fidelity upon which to solely base decisions and/or plan maneuvers to avoid terrain, obstacles, or traffic.



WARNING: Do not use SVS runway depiction as the sole means for determining the proximity of the aircraft to the runway or for maintaining the proper approach path angle during landing.

Synthetic Vision System (SVS) functionality is offered as an optional enhancement to the G1000 Integrated Flight Deck System.

SVS is primarily comprised of a computer-generated forward-looking, attitude aligned view of the topography immediately in front of the aircraft from the pilot's perspective. SVS information is shown on the primary flight display (PFD).

SVS offers a three-dimensional view of terrain and obstacles. Terrain and obstacles that pose a threat to the aircraft in flight are shaded yellow or red.

In addition to SVS enhancement to the PFD, the following feature enhancements have been added to the PFD:

- Pathways
- Flight Path Marker
- Horizon Heading Marks
- Terrain and Obstacle Alerting
- Three-dimensional Traffic
- Airport Signs
- Runway Display

Displaying SVS Terrain

- 1) Press the **PFD** Softkey.
- 2) Press the **SYN VIS** Softkey.
- 3) Press the **SYN TERR** Softkey.
- 4) Press the **BACK** Softkey to return to the previous page.

Displaying Pathways

- 1) Press the **PFD** Softkey.
- 2) Press the **SYN VIS** Softkey.
- 3) If not already enabled, press the **SYN TERR** Softkey.
- 4) Press the **PATHWAY** Softkey.
- 5) Press the **BACK** Softkey to return to the previous page.

Displaying Heading on the Horizon

- 1) Press the **PFD** Softkey.
- 2) Press the **SYN VIS** Softkey.
- 3) If not already enabled, press the **SYN TERR** Softkey.
- 4) Press the **HRZN HDG** Softkey.
- 5) Press the **BACK** Softkey to return to the previous page.

Displaying Airport Signs

- 1) Press the **PFD** Softkey.
- 2) Press the **SYN VIS** Softkey.
- 3) If not already enabled, press the **SYN TERR** Softkey.
- 4) Press the **APTSIGNS** Softkey.
- 5) Press the **BACK** Softkey to return to the previous page.

TERMINAL PROCEDURE CHARTS



NOTE: With the availability of SafeTaxi®, ChartView, or FliteCharts® in electronic form, it is still advisable to carry another source of charts on-board the aircraft.

SafeTaxi®

SafeTaxi® is an enhanced feature that gives greater map detail as the map range is adjusted in on the airport. The airport display on the map reveals runways with numbers, taxiways identifiers, and airport landmarks including ramps, buildings, control towers, and other prominent features. Resolution is greater at lower map ranges. The aircraft symbol provides situational awareness while taxiing.

Pressing the **DCLTR** Softkey (declutter) once removes the taxiway markings and airport identification labels. Pressing the **DCLTR** Softkey twice removes VOR station

ID, the VOR symbol, and intersection names if within the airport plan view. Pressing the **DCLTR** Softkey a third time removes the airport runway layout, unless the airport in view is part of an active route structure. Pressing the **DCLTR** Softkey again cycles back to the original map detail.

The SafeTaxi database contains detailed airport diagrams for selected airports. These diagrams aid in following ground control instructions by accurately displaying the aircraft position on the map in relation to taxiways, ramps, runways, terminals, and services. This database is updated on a 56-day cycle.

ChartView

ChartView resembles the paper version of Jeppesen terminal procedures charts. The charts are displayed in full color with high-resolution. The MFD depiction shows the aircraft position on the moving map in the plan view of most approach charts and on airport diagrams.

The ChartView database is updated on a 14-day cycle. If the ChartView database is not updated within 70 days of the expiration date, ChartView will no longer function.

FliteCharts®

FliteCharts® resemble the paper version of National Aeronautical Charting Office (NACO) terminal procedures charts. The charts are displayed with high-resolution and in color for applicable charts. Current aircraft position is not displayed on FliteCharts.

The FliteCharts database contains procedure charts for the United States only. This database is updated on a 28-day cycle. If not updated within 180 days of the expiration date, FliteCharts will no longer function.

View Charts from the Navigation Map Page

- 1) Press the **SHW CHRT** Softkey when displayed.

Or:

Move the map pointer to point to a desired point on the map and press the **SHW CHRT** Softkey.

- 2) Press the **DP, STAR, APR, WX,** and **NOTAM** softkeys to access charts for departures, arrivals, approaches, weather and NOTAMS. Note that NOTAMS are only available with ChartView.
- 3) Press the **GO BACK** Softkey to return to the previous page.

View Charts from the Active Flight Plan Page

- 1) While viewing the Active Flight Plan Page, press the **FMS** Knob to activate the cursor.
- 2) Turn the large **FMS** Knob to select the departure airport, destination airport, departure, arrival, or approach.
- 3) Press the **SHW CHRT** Softkey. The appropriate chart is displayed, if available for the item selected.
- 4) Press the **GO BACK** Softkey to return to the previous page.

Change Day/Night View

- 1) While viewing a chart press the **MENU** Key to display the Page Menu **OPTIONS**.
- 2) Turn the large **FMS** Knob to highlight the 'Chart Setup' Menu Option and press the **ENT** Key.
- 3) Turn the large **FMS** Knob to move between the 'FULL SCREEN' and 'COLOR SCHEME' Options.
- 4) Turn the small **FMS** Knob to choose between the 'On' and 'Off' Full Screen Options.
- 5) Turn the small **FMS** Knob to choose between 'Day', 'Auto', and 'Night' Options.
- 6) In Auto Mode, turn the large **FMS** Knob to select the percentage field and change percentage with the small **FMS** Knob. The percentage of change is the day/night crossover point based on backlighting intensity.
- 7) Press the **FMS** Knob when finished to remove the Chart Setup Menu.

XM® RADIO ENTERTAINMENT

The XM® Radio Page provides information and control of the audio entertainment features of the XM Satellite Radio.

Selecting the XM Radio Page

- 1) Turn the large **FMS** Knob to select the Auxiliary Page Group.
- 2) Turn the small **FMS** Knob to select the displayed AUX - XM Information Page.
- 3) Press the **RADIO** Softkey to show the XM Radio Page where audio entertainment is controlled.

Active Channel and Channel List

The Active Channel Box on the XM Radio Page displays the currently selected channel. The Channels List Box of the XM Radio Page shows a list of the available channels for the selected category.

Selecting a Category

The Category Box of the XM Radio Page displays the currently selected category of audio.

- 1) Press the **CATGRY** Softkey on the XM Radio Page.
- 2) Press the **CAT +** and **CAT -** Softkeys to cycle through the categories.

Or:

Turn the small **FMS** Knob to display the 'Categories' list. Highlight the desired category with the small **FMS** Knob.

- 3) Press the **ENT** Key.

Select an Available Channel within the Selected Category

- 1) While on the XM Radio Page, press the **CHNL** Softkey.
- 2) Press the **CH +** Softkey to go up through the list in the Channel Box, or move down the list with the **CH -** Softkey.

Or:

Press the **FMS** Knob to highlight the channel list and turn the large **FMS** Knob to scroll through the channels.

- 3) With the desired channel highlighted, press the **ENT** Key.

Entering a Channel Directly

- 1) While on the XM Radio Page, press the **CHNL** Softkey.
- 2) Press the **DIR CH** Softkey. The channel number in the Active Channel Box is highlighted.
- 3) Press the numbered softkeys located on the bottom of the display to directly select the desired channel number.
- 4) Press the **ENT** Key to activate the selected channel.

Assigning Channel Presets

Up to 15 channels from any category can be assigned a preset number.

- 1) On the XM Radio Page, with the desired channel active, press the **PRESETS** Softkey to access the first five preset channels (**PS1 - PS5**).
- 2) Press the **MORE** Softkey to access the next five channels (**PS6 – PS10**), and again to access the last five channels (**PS11 – PS15**). Pressing the **MORE** Softkey repeatedly cycles through the preset channels.
- 3) Press any one of the (**PS1 - PS15**) softkeys to assign a number to the active channel.
- 4) Press the **SET** Softkey on the desired channel number to save the channel as a preset.

Adjusting Volume

- 1) On the XM Radio Page, press the **RADIO** Softkey.
- 2) Press the **VOL** Softkey to access the volume control softkeys.
- 3) Press **VOL +** or **VOL -** softkeys to adjust the volume level.
- 4) Press the **MUTE** Softkey to mute the radio audio.

ABNORMAL OPERATION

REVERSIONARY MODE

Should a system detected failure occur in either display, the G1000 automatically enters reversionary mode. In reversionary mode, critical flight instrumentation is combined with engine instrumentation on the remaining display.

Reversionary display mode can be manually activated by pressing the **DISPLAY BACKUP** Button on the audio panel.



NOTE: *The Diamond DA42NG Pilot's Operating Handbook (POH) always takes precedence over the information found in this section.*

ABNORMAL COM OPERATION

When a COM tuning failure is detected by the system, the emergency frequency (121.500 MHz) is automatically loaded into the active frequency field of the COM radio for which the tuning failure was detected.

HAZARD DISPLAYS WITH LOSS OF GPS POSITION

If GPS position is lost, or becomes invalid, selected hazards being displayed on the Navigation Map Page are removed until GPS position is again established.



Loss of Hazard Functions with Loss of GPS Position

UNUSUAL ATTITUDES

The PFD ‘declutters’ when the aircraft enters an unusual attitude. Only the primary functions are displayed in these situations.

The following information is removed from the PFD (and corresponding softkeys are disabled) when the aircraft experiences unusual attitudes:

- Traffic Annunciations
- AFCS Annunciations
- Flight Director Command Bars
- Inset Map
- Temperatures
- DME Information Window
- Wind Data
- Selected Heading Box
- Selected Course Box
- Transponder Status Box
- System Time
- PFD Setup Menu
- Windows displayed in the lower right corner of the PFD:
 - Timer/References
 - Nearest Airports
 - Flight Plan
 - Messages
 - Procedures
 - ADF/DME Tuning
- Barometric Minimum Descent Altitude Box
- Glideslope, Glide-path, and Vertical Deviation Indicators
- Altimeter Barometric Setting
- Selected Altitude
- VNV Target Altitude

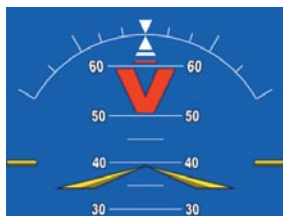

Extreme Pitch Indication

DEAD RECKONING

While in Enroute or Oceanic phase of flight, if the G1000 detects an invalid GPS solution or is unable to calculate a GPS position, the system automatically reverts to Dead Reckoning (DR) Mode. In DR Mode, the G1000 uses its last-known position combined with continuously updated airspeed and heading data (when available) to calculate and display the aircraft's current estimated position.



NOTE: Dead Reckoning Mode only functions in Enroute (ENR) or Oceanic (OCN) phase of flight. In all other phases, an invalid GPS solution produces a “NO GPS POSITION” annunciation on the map and the G1000 stops navigating in GPS Mode.

DR Mode is indicated on the G1000 by the appearance of the letters ‘DR’ superimposed in yellow over the ‘own aircraft’ symbol as shown in the following figure. In addition, ‘DR’ is prominently displayed, also in yellow, on the HSI slightly above and to the right of the aircraft symbol on the CDI as shown in the following figure. Also, the CDI deviation bar is removed from the display. Lastly, but at the same time, a ‘GPS NAV LOST’ alert message appears on the PFD.

Normal navigation using GPS data resumes automatically once a valid GPS solution is restored.

It is important to note that estimated navigation data supplied by the G1000 in DR Mode may become increasingly unreliable and must not be used as a sole means of navigation. If, while in DR Mode, airspeed and/or heading data is also lost or not available, the DR function is not capable of estimating your position and, consequently, the system may display a path that is different than the actual movement of the aircraft. Estimated position information displayed by the G1000 through DR while there is no heading and/or airspeed data available should not be used for navigation.

DR Mode is inherently less accurate than the standard GPS Mode due to the lack of satellite measurements needed to determine a position. Changes in wind speed and/or wind direction compounds the relative inaccuracy of DR Mode. Because of this degraded accuracy, the crew must maintain position awareness using other navigation equipment until GPS-derived position data is restored.



CDI ‘DR’ Indication on PFD



Symbolic Aircraft
(Map pages and Inset Map)

Dead Reckoning Indications

As a result of operating in DR Mode, all GPS-derived data is computed based upon an estimated position and is displayed as yellow text on the display to denote degraded navigation source information. This data includes the following:

- Navigation Status Box fields except Active Leg, TAS, and DTK
- GPS Bearing Pointer
- Wind data and pointers in the Wind Data Box on the PFD
- Track Indicator
- All Bearing Pointer Distances
- Active Flight Plan distances, bearings, and ETE values

Also, while the G1000 is in DR Mode, the autopilot will not couple to GPS, and Terrain Proximity is disabled. Additionally, the accuracy of all nearest information (airports, airspaces, and waypoints) is questionable. Finally, airspace alerts continue to function, but with degraded accuracy.

Flight Instruments

EIS

Nav/Com/XPDR/Audio

AFC

GPS Nav

Flight Planning

Procedures

Hazard Avoidance

Additional Features

Abnormal Operation

Annun/Alerts

Appendix

Index

ANNUNCIATIONS & ALERTS

WARNING ALERTS

Annunciation Window Text	Alerts Window Message	Audio Alert
L ENG TEMP	Left engine coolant temp is >105 deg C.	Continuous Aural Tone
R ENG TEMP	Right engine coolant temp is >105 deg C.	
L OIL TEMP	Left engine oil temp is greater than 140 deg C.	
R OIL TEMP	Right engine oil temp is greater than 140 deg C.	
L OIL PRES	Left engine oil pressure is less than 1.5 bar.	
R OIL PRES	Right engine oil pressure is less than 1.5 bar.	
L ENG FIRE	Left engine fire detected.	
R ENG FIRE	Right engine fire detected.	
L GBOX TEMP	Left engine gearbox temp is >120 deg C.	
R GBOX TEMP	Right engine gearbox temp is >120 deg C.	
L ALTN AMPS	Left engine alternator output is >70 amps.	
R ALTN AMPS	Right engine alternator output is >70 amps.	
L STARTER	Left engine starter is engaged.	
R STARTER	Right engine starter is engaged.	
L FUEL TEMP	Left fuel temp is greater than 60 deg C.	
R FUEL TEMP	Right fuel temp is greater than 60 deg C.	
L FUEL PRESS	Left engine fuel pressure is low.	
R FUEL PRESS	Right engine fuel pressure is low.	
DOOR OPEN	Front, rear, or baggage door is not closed.	

CAUTION ALERTS

Annunciation Window Text	Alerts Window Message	Audio Alert
CHECK GEAR	Landing gear is not down and locked	Single Aural Tone
L ECU A FAIL	Left engine ECU A has failed.	
R ECU A FAIL	Right engine ECU A has failed.	
L ECU B FAIL	Left engine ECU B has failed.	
R ECU B FAIL	Right engine ECU B has failed.	
L FUEL LOW	Left engine main tank fuel quantity is low.	
R FUEL LOW	Right engine main tank fuel quantity is low.	
L ALTN FAIL	Left engine alternator has failed.	
R ALTN FAIL	Right engine alternator has failed.	
L VOLTS LOW	Left bus voltage is less than 25 volts.	
R VOLTS LOW	Right bus voltage is less than 25 volts.	
L COOL LVL	Left engine coolant level is low.	
R COOL LVL	Right engine coolant level is low.	
L AUX FUEL E	Left auxiliary fuel tank is empty. (optional)	
R AUX FUEL E	Right auxiliary fuel tank is empty. (optional)	
PITOT FAIL	Pitot heat has failed.	
PITOT HT OFF	Pitot heat is off.	
STAL HT FAIL	Stall warning heat has failed.	
STAL HT OFF	Stall warning heat is off.	
DEICE LVL LO⁺	De-icing fluid level is low.	
DEIC PRES HI⁺	De-icing pressure is high.	
DEIC PRES LO⁺	De-icing pressure is low.	
STICK LIMIT	Stick limiting system has failed.	
✦ Optional		

ANNUNCIATION ADVISORY

Annunciation Window Text	Alerts Window Message	Audio Alert
L GLOW ON	Left engine glow plug active.	No Tone
R GLOW ON	Right engine glow plug active.	
L AUXPUMP ON ⁺	Left fuel transfer from aux to main in progress.	
R AUXPUMP ON ⁺	Right fuel transfer from aux to main in progress.	
✦ Optional		

MESSAGE ADVISORY ALERTS

Alerts Window Message	Audio Alert
PFD FAN FAIL – The cooling fan for the PFD is inoperative.	None
MFD FAN FAIL – The cooling fan for the MFD is inoperative.	
GIA FAN FAIL – The cooling fan for the GIAs is inoperative.	

AFCS ALERTS

Condition	Annunciation	Description
Pitch Failure	PTCH	Pitch axis control failure. AP is inoperative.
Roll Failure	ROLL	Roll axis control failure. AP is inoperative.
MET Switch Stuck, or Pitch Trim Axis Control Failure	PTRM	If annunciated when AP is engaged, take control of the aircraft and disengage the autopilot. If annunciated when AP is not engaged, move each half of the MET switch separately to check if a stuck switch is causing the annunciation.
Yaw Damper Failure	YAW	YD control failure; AP still operative
System Failure	AFCS	AP and MET are unavailable. FD may still be available.
Rudder Mistrim Right	RUD→	Yaw servo providing sustained force in the indicated direction
Rudder Mistrim Left	←RUD	
Elevator Mistrim Up	↑ELE	Pitch servo providing sustained force in the indicated direction.
Elevator Mistrim Down	↓ELE	
Aileron Mistrim Left	←AIL	Roll servo providing sustained force in indicated direction.
Aileron Mistrim Right	AIL→	
Preflight Test	PFT	Performing preflight system test. Upon completion, the aural alert will be heard.
	PFT	Preflight system test has failed.

TERRAIN-SVS ALERTS

Alert Type	PFD/MFD TERRAIN-SVS Page Annunciation	MFD Pop-Up Alert	Aural Message
Reduced Required Terrain Clearance Warning (RTC)	TERRAIN	WARNING TERRAIN	"Warning; Terrain, Terrain"
Imminent Terrain Impact Warning (ITI)	TERRAIN	WARNING TERRAIN	"Warning; Terrain, Terrain"
Reduced Required Obstacle Clearance Warning (ROC)	TERRAIN	WARNING OBSTACLE	"Warning; Obstacle, Obstacle"
Imminent Obstacle Impact Warning (IOI)	TERRAIN	WARNING OBSTACLE	"Warning; Obstacle, Obstacle"
Reduced Required Terrain Clearance Caution (RTC)	TERRAIN	CAUTION TERRAIN	"Caution; Terrain, Terrain"
Imminent Terrain Impact Caution (ITI)	TERRAIN	CAUTION TERRAIN	"Caution; Terrain, Terrain"
Reduced Required Obstacle Clearance Caution (ROC)	TERRAIN	CAUTION OBSTACLE	"Caution; Obstacle, Obstacle"
Imminent Obstacle Impact Caution (IOI)	TERRAIN	CAUTION OBSTACLE	"Caution; Obstacle, Obstacle"

TERRAIN-SVS SYSTEM STATUS ANNUNCIATIONS

Alert Type	PFD/MFD TERRAIN-SVS Page Annunciation	Aural Message
System Test fail	TER FAIL	"Terrain System Failure"
Terrain Alerting is disabled	TER INHB	None
No GPS position or excessively degraded GPS signal	TER N/A	"Terrain System Not Available" "Terrain System Available" will be heard when sufficient GPS signal is re-established.
System Test in progress	TER TEST	None
System Test pass	None	"Terrain System Test OK"

VOICE ALERTS

Voice Alert	Description
"Minimums, minimums"	The aircraft has descended below the preset barometric minimum descent altitude.
"Vertical track"	The aircraft is one minute from Top of Descent. Issued only when vertical navigation is enabled.
"Traffic"	Played when a Traffic Advisory (TA) is issued.
"Traffic Not Available"	The aircraft is outside the Traffic Information Service (TIS) coverage area.
"Traffic, Traffic"	Played when a Traffic Advisory (TA) is issued (TAS system).
"Traffic Advisory System Test Passed"	Played when the TAS system passes a pilot-initiated self test.
"Traffic Advisory System Test Failed"	Played when the TAS system fails a pilot-initiated self test.

MFD & PFD MESSAGE ADVISORIES

Message	Comments
DATA LOST – Pilot stored data was lost. Recheck settings.	The pilot profile data was lost. System reverts to default pilot profile and settings. The pilot may reconfigure the MFD & PFDs with preferred settings, if desired.
XTALK ERROR – A flight display crosstalk error has occurred.	The MFD and PFDs are not communicating with each other. The G1000 system should be serviced.
PFD1 SERVICE – PFD1 needs service. Return unit for repair.	The PFD and/or MFD self-test has detected a problem. The G1000 system should be serviced.
MFD1 SERVICE – MFD1 needs service. Return unit for repair.	
MANIFEST – PFD1 software mismatch, communication halted.	The PFD and/or MFD has incorrect software installed. The G1000 system should be serviced.
MANIFEST – MFD1 software mismatch, communication halted.	
PFD1 CONFIG – PFD1 config error. Config service req'd.	The PFD configuration settings do not match backup configuration memory. The G1000 system should be serviced.

MFD & PFD MESSAGE ADVISORIES (CONT.)

Message	Comments
MFD1 CONFIG – MFD1 config error. Config service req'd.	The MFD configuration settings do not match backup configuration memory. The G1000 system should be serviced.
SW MISMATCH – GDU software version mismatch. Xtalk is off.	The MFD and PFDs have different software versions installed. The G1000 system should be serviced.
PFD1 COOLING – PFD1 has poor cooling. Reducing power usage.	The PFD and/or MFD is overheating and is reducing power consumption by dimming the display. If problem persists, the G1000 system should be serviced.
MFD1 COOLING – MFD1 has poor cooling. Reducing power usage.	
PFD1 KEYSTK – PFD1 [key name] Key is stuck.	A key is stuck on the PFD and/or MFD bezel. Attempt to free the stuck key by pressing it several times. The G1000 system should be serviced if the problem persists.
MFD1 KEYSTK – MFD [key name] Key is stuck.	
CNFG MODULE – PFD1 configuration module is inoperative.	The PFD1 configuration module backup memory has failed. The G1000 system should be serviced.
PFD1 VOLTAGE – PFD1 has low voltage. Reducing power usage	The PFD1 voltage is low. The G1000 system should be serviced.
MFD1 VOLTAGE – MFD1 has low voltage. Reducing power usage	The MFD voltage is low. The G1000 system should be serviced.

DATABASE MESSAGE ADVISORIES

Message	Comments
MFD1 DB ERR – MFD1 aviation database error exists.	The MFD and/or PFD detected a failure in the aviation database. Attempt to reload the aviation database. If problem persists, the G1000 system should be serviced.
PFD1 DB ERR – PFD1 aviation database error exists.	
MFD1 DB ERR – MFD1 basemap database error exists.	The MFD and/or PFD detected a failure in the basemap database.
PFD1 DB ERR – PFD1 basemap database error exists.	

DATABASE MESSAGE ADVISORIES (CONT.)

Message	Comments
MFD1 DB ERR – MFD1 terrain database error exists.	The MFD and/or PFD detected a failure in the terrain database. Ensure that the terrain card is properly inserted in display. Replace terrain card. If problem persists, The G1000 system should be serviced.
PFD1 DB ERR – PFD1 terrain database error exists.	
MFD1 DB ERR – MFD1 terrain database missing.	The terrain database is present on another LRU, but is missing on the specified LRU.
PFD1 DB ERR – PFD1 terrain database missing.	
MFD1 DB ERR – MFD1 obstacle database error exists.	The MFD and/or PFD detected a failure in the obstacle database. Ensure that the data card is properly inserted. Replace data card. If problem persists, The G1000 system should be serviced.
PFD1 DB ERR – PFD1 obstacle database error exists.	
MFD1 DB ERR – MFD1 obstacle database missing.	The obstacle database is present on another LRU, but is missing on the specified LRU.
PFD1 DB ERR – PFD1 obstacle database missing.	
MFD1 DB ERR – MFD1 airport terrain database error exists.	The MFD and/or PFD detected a failure in the airport terrain database. Ensure that the data card is properly inserted. Replace data card. If problem persists, The G1000 system should be serviced.
PFD1 DB ERR – PFD1 airport terrain database error exists.	
MFD1 DB ERR – MFD1 airport terrain database missing.	The airport terrain database is present on another LRU, but is missing on the specified LRU.
PFD1 DB ERR – PFD1 airport terrain database missing.	
MFD1 DB ERR – MFD1 Safe Taxi database error exists.	The MFD and/or PFD detected a failure in the Safe Taxi database. Ensure that the data card is properly inserted. Replace data card. If problem persists, The G1000 system should be serviced.
PFD1 DB ERR – PFD1 Safe Taxi database error exists.	

DATABASE MESSAGE ADVISORIES (CONT.)

Message	Comments
MFD1 DB ERR – MFD1 Chartview database error exists.	The MFD and/or PFDs detected a failure in the ChartView database (optional feature). Ensure that the data card is properly inserted. Replace data card. If problem persists, The G1000 system should be serviced.
MFD1 DB ERR – MFD1 FliteCharts database error exists.	The MFD and/or PFDs detected a failure in the FliteCharts database (optional feature). Ensure that the data card is properly inserted. Replace data card. If problem persists, The G1000 system should be serviced.
DB MISMATCH – Aviation database version mismatch. Xtalk is off.	The PFDs and MFD have different aviation database versions installed. Crossfill is off. Install correct aviation database version in all displays.
DB MISMATCH – Aviation database type mismatch. Xtalk is off.	The PFDs and MFD have different aviation database types installed (Americas, European, etc.). Crossfill is off. Install correct aviation database type in all displays.
DB MISMATCH – Terrain database version mismatch.	The PFDs and MFD have different terrain database versions installed. Install correct terrain database version in all displays.
DB MISMATCH – Terrain database type mismatch.	The PFDs and MFD have different terrain database types installed. Install correct terrain database type in all displays.
DB MISMATCH – Obstacle database version mismatch.	The PFDs and MFD have different obstacle database versions installed. Install correct obstacle database version in all displays.
DB MISMATCH – Airport Terrain database mismatch.	The PFDs and MFD have different airport terrain databases installed. Install correct airport terrain database in all displays.

GMA 1347 MESSAGE ADVISORIES

Message	Comments
GMA1 FAIL – GMA1 is inoperative.	The audio panel self-test has detected a failure. The audio panel is unavailable. The G1000 system should be serviced.
GMA1 CONFIG – GMA1 config error. Config service req'd.	The audio panel configuration settings do not match backup configuration memory. The G1000 system should be serviced.
MANIFEST – GMA1 software mismatch, communication halted.	The audio panel has incorrect software installed. The G1000 system should be serviced.
GMA1 SERVICE – GMA1 needs service. Return unit for repair.	The audio panel self-test has detected a problem in the unit. Certain audio functions may still be available, and the audio panel may still be usable. The G1000 system should be serviced when possible.

GIA 63W MESSAGE ADVISORIES

Message	Comments
GIA1 CONFIG – GIA1 config error. Config service req'd.	The GIA1 and/or GIA2 configuration settings do not match backup configuration memory. The G1000 system should be serviced.
GIA2 CONFIG – GIA2 config error. Config service req'd.	
GIA1 CONFIG – GIA1 audio config error. Config service req'd.	The GIA1 and/or GIA2 have an error in the audio configuration. The G1000 system should be serviced.
GIA2 CONFIG – GIA2 audio config error. Config service req'd.	
GIA1 COOLING – GIA1 temperature too low.	The GIA1 and/or GIA2 temperature is too low to operate correctly. Allow units to warm up to operating temperature.
GIA2 COOLING – GIA2 temperature too low.	
GIA1 COOLING – GIA1 over temperature.	The GIA1 and/or GIA2 temperature is too high. If problem persists, the G1000 system should be serviced.
GIA2 COOLING – GIA2 over temperature.	

GIA 63W MESSAGE ADVISORIES (CONT.)

Message	Comments
GIA1 SERVICE – GIA1 needs service. Return the unit for repair.	The GIA1 and/or GIA2 self-test has detected a problem in the unit. The G1000 system should be serviced.
GIA2 SERVICE – GIA2 needs service. Return the unit for repair.	
HW MISMATCH – GIA hardware mismatch. GIA1 communication halted.	A GIA mismatch has been detected, where only one is WAAS capable.
HW MISMATCH – GIA hardware mismatch. GIA2 communication halted.	
MANIFEST – GIA1 software mismatch, communication halted.	The GIA1 and/or GIA 2 has incorrect software installed. The G1000 system should be serviced.
MANIFEST – GIA2 software mismatch, communication halted.	
MANIFEST – GFC software mismatch, communication halted.	Incorrect servo software is installed, or gain settings are incorrect.
COM1 TEMP – COM1 over temp. Reducing transmitter power.	The system has detected an over temperature condition in COM1 and/or COM2. The transmitter is operating at reduced power. If the problem persists, the G1000 system should be serviced.
COM2 TEMP – COM2 over temp. Reducing transmitter power.	
COM1 SERVICE – COM1 needs service. Return unit for repair.	The system has detected a failure in COM1 and/or COM2. COM1 and/or COM2 may still be usable. The G1000 system should be serviced when possible.
COM2 SERVICE – COM2 needs service. Return unit for repair.	
COM1 PTT – COM1 push-to-talk key is stuck.	The COM1 and/or COM2 external push-to-talk switch is stuck in the enable (or “pressed”) position. Press the PTT switch again to cycle its operation. If the problem persists, the G1000 system should be serviced.
COM2 PTT – COM2 push-to-talk key is stuck.	

Flight Instruments

EIS

Nav/Com/XPDR/Audio

AFCS

GPS Nav

Flight Planning

Procedures

Hazard Avoidance

Additional Features

Abnormal Operation

Annun/Alerts

Appendix

Index

GIA 63W MESSAGE ADVISORIES (CONT.)

Message	Comments
COM1 RMT XFR – COM1 remote transfer key is stuck.	The COM1 and/or COM2 transfer switch is stuck in the enabled (or “pressed”) position. Press the transfer switch again to cycle its operation. If the problem persists, the G1000 system should be serviced.
COM2 RMT XFR – COM2 remote transfer key is stuck.	
LOI – GPS integrity lost. Crosscheck with other NAVS.	GPS integrity is insufficient for the current phase of flight.
GPS NAV LOST – Loss of GPS navigation. Insufficient satellites.	Loss of GPS navigation due to insufficient satellites.
GPS NAV LOST – Loss of GPS navigation. Position error.	Loss of GPS navigation due to position error.
GPS NAV LOST – Loss of GPS navigation. GPS fail.	Loss of GPS navigation due to GPS failure.
ABORT APR – Loss of GPS navigation. Abort approach.	Abort approach due to loss of GPS navigation.
APR DWNGRADE – Approach downgraded.	Vertical guidance generated by WAAS is unavailable, use LNAV only minimums. (This message will not be generated when SBAS is disabled.)
TRUE APR – True north approach. Change HDG reference to TRUE.	Displayed after passing the first waypoint of a true north approach when the nav angle is set to ‘AUTO’.
GPS1 SERVICE – GPS1 needs service. Return unit for repair.	A failure has been detected in the GPS1 and/or GPS2 receiver. The receiver may still be available. The G1000 system should be serviced.
GPS2 SERVICE – GPS2 needs service. Return unit for repair.	
NAV1 SERVICE – NAV1 needs service. Return unit for repair.	A failure has been detected in the NAV1 and/or NAV2 receiver. The receiver may still be available. The G1000 system should be serviced.
NAV2 SERVICE – NAV2 needs service. Return unit for repair.	

GIA 63W MESSAGE ADVISORIES (CONT.)

Message	Comments
NAV1 RMT XFR – NAV1 remote transfer key is stuck.	The remote NAV1 and/or NAV2 transfer switch is stuck in the enabled (or “pressed”) state. Press the transfer switch again to cycle its operation. If the problem persists, the G1000 system should be serviced.
NAV2 RMT XFR – NAV2 remote transfer key is stuck.	
G/S1 FAIL – G/S1 is inoperative.	A failure has been detected in glideslope receiver 1 and/or receiver 2. The G1000 system should be serviced.
G/S2 FAIL – G/S2 is inoperative.	
G/S1 SERVICE – G/S1 needs service. Return unit for repair.	A failure has been detected in glideslope receiver 1 and/or receiver 2. The receiver may still be available. The G1000 system should be serviced when possible.
G/S2 SERVICE – G/S2 needs service. Return unit for repair.	

GEA 71 MESSAGE ADVISORIES

Message	Comments
GEA1 CONFIG – GEA1 config error. Config service req’d.	The GEA1 configuration settings do not match those of backup configuration memory. The G1000 system should be serviced.
MANIFEST – GEA1 software mismatch, communication halted.	The #1 GEA 71 has incorrect software installed. The G1000 system should be serviced.

GTX 33 MESSAGE ADVISORIES

Message	Comments
XPDR1 CONFIG – XPDR1 config error. Config service req’d.	The transponder configuration settings do not match those of backup configuration memory. The G1000 system should be serviced.
MANIFEST – GTX1 software mismatch, communication halted.	The transponder has incorrect software installed. The G1000 system should be serviced.
XPDR1 SRVC – XPDR1 needs service. Return unit for repair.	The #1 transponder should be serviced when possible.
XPDR1 FAIL – XPDR1 is inoperative.	There is no communication with the #1 transponder.

GRS 77 MESSAGE ADVISORIES

Message	Comments
AHRS1 TAS – AHRS1 not receiving valid airspeed.	The #1 AHRS is not receiving true airspeed from the air data computer. The AHRS relies on GPS information to augment the lack of airspeed. The G1000 system should be serviced.
AHRS1 GPS – AHRS1 using backup GPS source.	The #1 AHRS is using the backup GPS path. Primary GPS path has failed. The G1000 system should be serviced when possible.
AHRS1 GPS – AHRS1 not receiving any GPS information.	The #1 AHRS is not receiving any or any useful GPS information. Check AFMS limitations. The G1000 system should be serviced.
AHRS1 GPS – AHRS1 not receiving backup GPS information.	The #1 AHRS is not receiving backup GPS information. The G1000 system should be serviced.
AHRS1 GPS – AHRS1 operating exclusively in no-GPS mode.	The #1 AHRS is operating exclusively in no-GPS mode. The G1000 system should be serviced.
AHRS1 SRVC – AHRS1 Magnetic-field model needs update.	The #1 AHRS earth magnetic field model is out of date. Update magnetic field model when practical.
GEO LIMITS – AHRS1 too far North/South, no magnetic compass.	The aircraft is outside geographical limits for approved AHRS operation. Heading is flagged as invalid.
MANIFEST – GRS1 software mismatch, communication halted.	The #1 AHRS has incorrect software installed. The G1000 system should be serviced.

GMU 44 MESSAGE ADVISORIES

Message	Comments
HDG FAULT – AHRS1 magnetometer fault has occurred.	A fault has occurred in the #1 GMU 44. Heading is flagged as invalid. The AHRS uses GPS for backup mode operation. The G1000 system should be serviced.
MANIFEST – GMU1 software mismatch, communication halted.	The GMU 44 has incorrect software installed. The G1000 system should be serviced.

GDL 69A MESSAGE ADVISORIES

Message	Comments
GDL69 CONFIG – GDL 69 config error. Config service req'd.	GDL 69 configuration settings do not match those of backup configuration memory. The G1000 system should be serviced.
GDL69 FAIL – GDL 69 has failed.	A failure has been detected in the GDL 69. The receiver is unavailable. The G1000 system should be serviced
MANIFEST – GDL software mismatch, communication halted.	The GDL 69 has incorrect software installed. The G1000 system should be serviced.

GDC 74A MESSAGE ADVISORIES

Message	Comments
MANIFEST – GDC1 software mismatch, communication halted.	The GDC 74A has incorrect software installed. The G1000 system should be serviced.

MISCELLANEOUS MESSAGE ADVISORIES

Message	Comments
FPL WPT LOCK – Flight plan waypoint is locked.	Upon power-up, the G1000 system detects that a stored flight plan waypoint is locked. This occurs when an aviation database update eliminates an obsolete waypoint. The flight plan cannot find the specified waypoint and flags this message. This can also occur with user waypoints in a flight plan that is deleted. Remove the waypoint from the flight plan if it no longer exists in any database, Or update the waypoint name/identifier to reflect the new information.

MISCELLANEOUS MESSAGE ADVISORIES (CONT.)

Message	Comments
FPL WPT MOVE – Flight plan waypoint moved.	The system has detected that a waypoint coordinate has changed due to a new aviation database update. Verify that stored flight plans contain correct waypoint locations.
TIMER EXPIRD – Timer has expired.	The system notifies the pilot that the timer has expired.
DB CHANGE – Database changed. Verify user modified procedures.	This occurs when a stored flight plan contains procedures that have been manually edited. This alert is issued only after an aviation database update. Verify that the user-modified procedures in stored flight plans are correct and up to date.
DB CHANGE – Database changed. Verify stored airways.	This occurs when a stored flight plan contains an airway that is no longer consistent with the aviation database. This alert is issued only after an aviation database update. Verify use of airways in stored flight plans and reload airways as needed.
FPL TRUNC – Flight plan has been truncated.	This occurs when a newly installed aviation database eliminates an obsolete approach or arrival used by a stored flight plan. The obsolete procedure is removed from the flight plan. Update flight plan with current arrival or approach.
LOCKED FPL – Cannot navigate locked flight plan.	This occurs when the pilot attempts to activate a stored flight plan that contains locked waypoint. Remove locked waypoint from flight plan. Update flight plan with current waypoint.
WPT ARRIVAL – Arriving at waypoint -[xxxx]	Arriving at waypoint [xxxx], where [xxxx] is the waypoint name.
STEEP TURN – Steep turn ahead.	A steep turn is 15 seconds ahead. Prepare to turn.

MISCELLANEOUS MESSAGE ADVISORIES (CONT.)

Message	Comments
INSIDE ARSPC – Inside airspace.	The aircraft is inside the airspace.
ARSPC AHEAD – Airspace ahead less than 10 minutes.	Special use airspace is ahead of aircraft. The aircraft will penetrate the airspace within 10 minutes.
ARSPC NEAR – Airspace near and ahead.	Special use airspace is near and ahead of the aircraft position.
ARSPC NEAR – Airspace near – less than 2 nm.	Special use airspace is within 2 nm of the aircraft position.
APR INACTV – Approach is not active.	The system notifies the pilot that the loaded approach is not active. Activate approach when required.
SLCT FREQ – Select appropriate frequency for approach.	The system notifies the pilot to load the approach frequency for the appropriate NAV receiver. Select the correct frequency for the approach.
SLCT NAV – Select NAV on CDI for approach.	The system notifies the pilot to set the CDI to the correct NAV receiver. Set the CDI to the correct NAV receiver.
PTK FAIL – Parallel track unavailable: bad geometry.	Bad parallel track geometry.
PTK FAIL – Parallel track unavailable: invalid leg type.	Invalid leg type for parallel offset.
PTK FAIL – Parallel track unavailable: past IAF.	IAF waypoint for parallel offset has been passed.
UNABLE V WPT – Can't reach current vertical waypoint.	The current vertical waypoint can not be reached within the maximum flight path angle and vertical speed constraints. The system automatically transitions to the next vertical waypoint.

Flight Instruments

EIS

Nav/Com/XPDR/Audio

AFCS

GPS Nav

Flight Planning

Procedures

Hazard Avoidance

Additional Features

Abnormal Operation

Annun/Alerts

Appendix

Index

MISCELLANEOUS MESSAGE ADVISORIES (CONT.)

Message	Comments
VNV – Unavailable. Unsupported leg type in flight plan.	The lateral flight plan contains a procedure turn, vector, or other unsupported leg type prior to the active vertical waypoint. This prevents vertical guidance to the active vertical waypoint.
VNV – Unavailable. Excessive track angle error.	The current track angle error exceeds the limit, causing the vertical deviation to go invalid.
VNV – Unavailable. Excessive crosstrack error.	The current crosstrack exceeds the limit, causing vertical deviation to go invalid.
VNV – Unavailable. Parallel course selected.	A parallel course has been selected, causing the vertical deviation to go invalid.
NO WGS84 WPT – Non WGS 84 waypoint for navigation -[xxxx]	The selected waypoint [xxxx] does not use the WGS 84 datum. Cross-check position with alternate navigation sources.
TRAFFIC FAIL – Traffic device has failed.	The G1000 is no longer receiving data from the traffic system. The traffic device should be serviced.
STRMSCP FAIL – Stormscope has failed.	Stormscope has failed. The G1000 system should be serviced.
FAILED PATH – A data path has failed.	A data path connected to the GDU or the GIA 63/W has failed.
MAG VAR WARN – Large magnetic variance. Verify all course angles.	The GDU's internal model cannot determine the exact magnetic variance for geographic locations near the magnetic poles. Displayed magnetic course angles may differ from the actual magnetic heading by more than 2°.
SVS – SVS DISABLED: Out of available terrain region.	Synthetic Vision is disabled because the aircraft is not within the boundaries of the installed terrain database.
SVS – SVS DISABLED: Terrain DB resolution too low.	Synthetic Vision is disabled because a terrain database of sufficient resolution (9 arc-second or better) is not currently installed.
SCHEDULER [#] – <message>.	Message criteria entered by the user.

APPENDIX

PFD SOFTKEY MAP

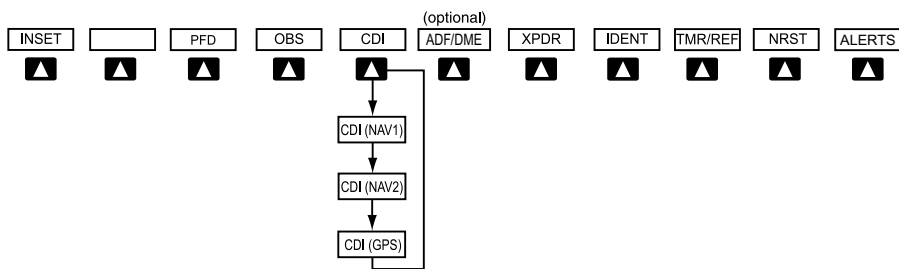

Top Level PFD Softkeys

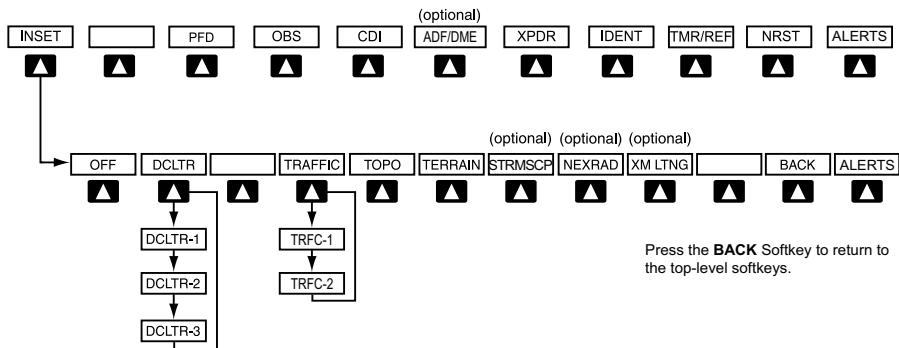

Inset Map Softkeys

INSET		Displays Inset Map in PFD lower left corner
	OFF	Removes Inset Map
	DCLTR (3)	<p>Selects desired amount of map detail; cycles through declutter levels:</p> <ul style="list-style-type: none"> DCLTR (No Declutter): All map features visible DCLTR-1: Declutters land data DCLTR-2: Declutters land and SUA data DCLTR-3: Removes everything except the active flight plan

Flight Instruments	TRAFFIC	Cycles through traffic display options: TRFC-1: Traffic displayed on inset map TRFC-2: Traffic Map Page is displayed in the inset map window OFF: No traffic displayed on inset map
EIS	TOPO	Displays topographical data (e.g., coastlines, terrain, rivers, lakes) and elevation scale on Inset Map
Nav/Com/XPDR/Audio	TERRAIN	Displays terrain information on Inset Map
AFCs	STRMSCP	Select to display the Stormscope lightning data on the Inset Map (within a 200 nm radius of the aircraft)(optional)
GPS Nav	NEXRAD	Displays NEXRAD weather and coverage information on Inset Map (optional feature)
Flight Planning	XM LTNG	Displays XM lightning information on Inset Map (optional feature)

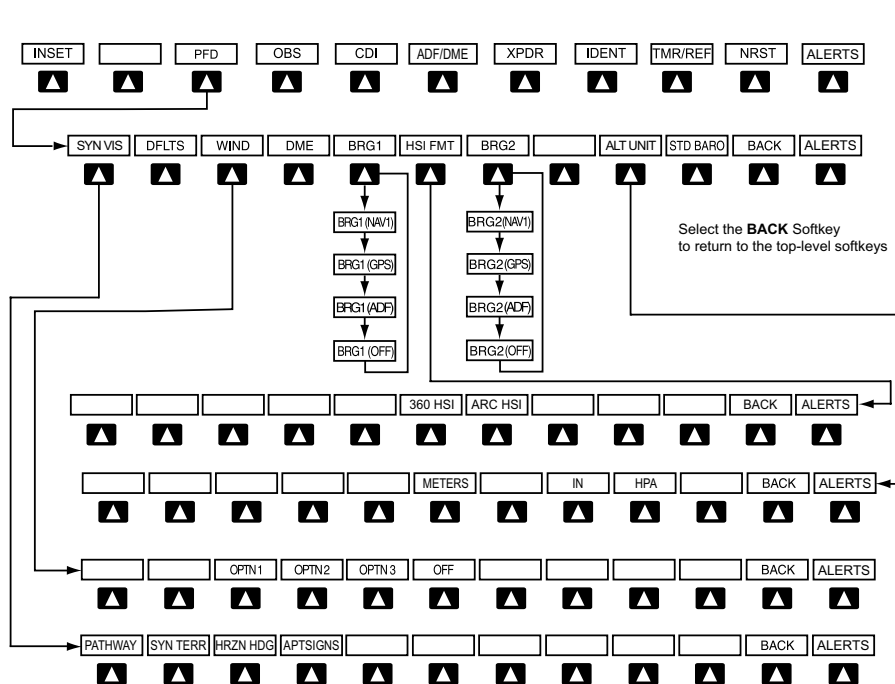

PFD Configuration Softkeys

PFD			Displays second-level softkeys for additional PFD configurations
	SYN VIS		Displays the softkeys for enabling or disabling Synthetic Vision features
		PATHWAY	Displays rectangular boxes representing the horizontal and vertical flight path of the active flight plan
		SYN TERR	Enables synthetic terrain depiction
		HRZN HDG	Displays compass heading along the Zero-Pitch line
		APTSIGNS	Displays position markers for airports within approximately 15 nm of the current aircraft position. Airport identifiers are displayed when the airport is within approximately 9 nm.
	DFLT		Resets PFD to default settings, including changing units to standard
	WIND		Displays softkeys to select wind data parameters
		OPTN 1	Wind direction arrows with headwind and crosswind components
		OPTN 2	Wind direction arrow and speed
		OPTN 3	Wind direction arrow with headwind/tailwind and crosswind components
		OFF	Information not displayed
	DME		Displays the DME Information Window
	BRG1		Cycles the Bearing 1 Information Window through NAV1 or GPS/waypoint identifier and GPS-derived distance information, and ADF/frequency.
	HSI FRMT		Displays the HSI formatting softkeys
		360 HSI	Displays the HSI in a 360 degree format
		ARC HSI	Displays the HSI in an arc format

Flight Instruments

EIS

Nav/Com/XPDR/Audio

AFCS

GPS Nav

Flight Planning

Procedures

Hazard Avoidance

Additional Features

Abnormal Operation

Annun./Alerts

Appendix

Index

Flight Instruments	BRG2		Cycles the Bearing 2 Information Window through NAV2 or GPS/waypoint identifier and GPS-derived distance information, and ADF/frequency.
EIS	ALT UNIT		Displays softkeys for setting the altimeter and BARO settings to metric units
Nav/Com/XPDR/Audio		METERS	When enabled, displays altimeter in meters
AFCs		IN	Press to display the BARO setting as inches of mercury
GPS Nav		HPA	Press to display the BARO setting as hectopascals
Flight Planning	STD BARO		Sets barometric pressure to 29.92 in Hg (1013 hPa)

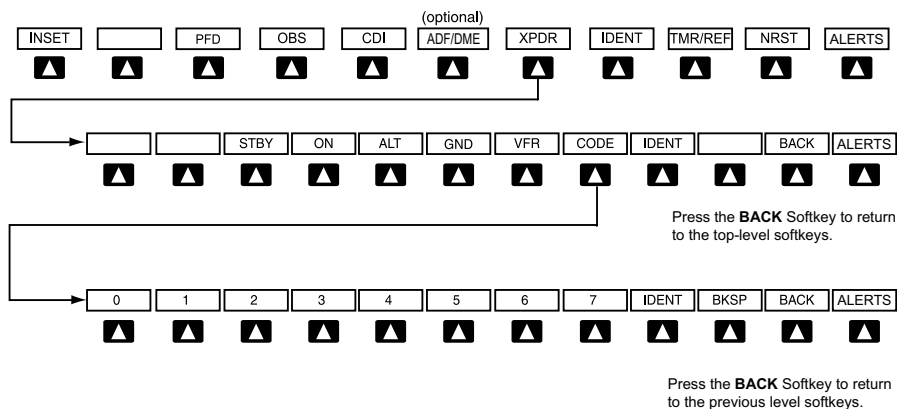

Transponder Softkeys

XPDR		Displays transponder mode selection softkeys
	STBY	Selects Standby Mode (transponder does not reply to any interrogations)
	ON	Selects Mode A (transponder replies to interrogations)

	ALT		Selects Mode C – Altitude Reporting Mode (transponder replies to identification and altitude interrogations)
	GND		Manually selects Ground Mode, the transponder does not allow Mode A and Mode C replies, but it does permit acquisition squitter and replies to discretely addressed Mode S interrogations.
	VFR		Automatically enters the VFR code (1200 in the U.S.A. only)
	CODE		Displays transponder code selection softkeys 0-7
		0 — 7	Use numbers to enter code
		BKSP	Removes numbers entered, one at a time
IDENT			Activates the Special Position Identification (SPI) pulse for 18 seconds, identifying the transponder return on the ATC screen
TMR/REF			Displays Timer/References Window
NRST			Displays Nearest Airports Window
ALERTS			Displays Alerts Window

Flight Instruments

EIS

Nav/Com/XPDR/Audio

AFCS

GPS Nav

Flight Planning

Procedures

Hazard Avoidance

Additional Features

Abnormal Operation

Annun/Alerts

Appendix

Index

MFD SOFTKEY MAP

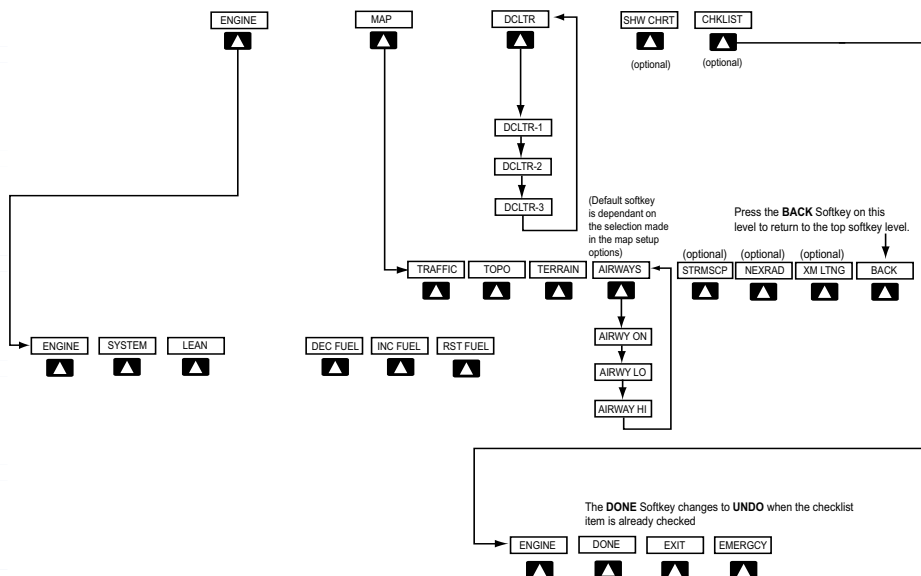

MFD Softkeys

ENGINE			Displays EIS-Engine Page
	SYSTEM		Displays the Engine System Display
	FUEL		Displays the fuel softkeys
		DEC FUEL	Press to decrease remaining fuel quantity in 1-gallon increments
		INC FUEL	Press to increase remaining fuel quantity in 1-gallon increments
		RST FUEL	Press to reset fuel to full
MAP			Enables second-level Navigation Map softkeys
	TRAFFIC		Displays traffic information on Navigation Map
	TOPO		Displays topographical data (e.g., coastlines, terrain, rivers, lakes) and elevation scale on Navigation Map

	TERRAIN		Displays terrain information on Navigation Map
	AIRWAYS		Displays airways on the map; cycles through the following: AIRWAYS: No airways are displayed AIRWY ON: All airways are displayed AIRWY LO: Only low altitude airways are displayed AIRWY HI: Only high altitude airways are displayed
	STRMSCP		Displays Stormscope weather and coverage information on Navigation Map (optional)
	NEXRAD		Displays NEXRAD weather and coverage information on Navigation Map (optional)
	XM LTNG		Displays XM lightning information on Navigation Map (optional)
	BACK		Returns to top-level softkeys
DCLTR (3)			Selects desired amount of map detail; cycles through declutter levels: DCLTR (No Declutter): All map features visible DCLTR-1: Declutters land data DCLTR-2: Declutters land and SUA data DCLTR-3: Removes everything except the active flight plan
SHW CHRT			When available, displays optional airport and terminal procedure charts
CHKLIST			When available, displays optional checklists

Flight Instruments

EIS

Nav/Com/XPDR/Audio

AFCs

GPS Nav

Flight Planning

Procedures

Hazard Avoidance

Additional Features

Abnormal Operation

Annun./Alerts

Appendix

Index

- Flight Instruments
- EIS
- Nav/Com/XPDR/Audio
- AFC
- GPS Nav
- Flight Planning
- Procedures
- Hazard Avoidance
- Additional Features
- Abnormal Operation
- Annun/Alerts
- Appendix
- Index

Blank Page

A

Activate a flight plan 18
 Active Channel 47
 ADF 9, 10, 50, 73, 74
 Advisory alerts 55
 AHRS 66
 Airport Signs 43, 44
 Airways 77
 AP 56
 Audio panel controls
 NAV1, NAV2 10

B

Barometric Altitude Minimums 3
 Barometric pressure 74

C

CDI 1, 10, 69
 Cell 35, 36
 Cell mode 36
 Channel Presets 48
 ChartView 44, 45
 Clearance player 11
 Clearance Recorder 11
 Code selection softkeys 10
 COM 10, 11, 49

D

DCLTR Softkey 44
 Dead Reckoning 50
 Declutter 50, 71, 77
 Direct-to 17
 DME 9, 10
 DR mode 50, 51, 52

E

Edit a flight plan 27
 Enable Terrain 42
 Endurance 7

F

FD 56
 Flight Director 13
 Flight ID 9
 Flight path marker 43
 FliteCharts® 44, 45
 Frequency Transfer 10
 Fuel remaining 7
 Fuel used 7

H

Horizon heading 43

I

Inhibit 42
 Inhibit Terrain 42
 Inset Map 71, 72
 IOI 57

J

Jeppesen 45

L

Lightning 35, 36, 72

M

Map panning 37
 Message advisories 58–70
 MET 56
 METAR 37
 Minimums 58
 Mistrim 56

MKR/MUTE 11

Mode S 75

Mode selection softkeys 10

Multi Function Display (MFD)

Softkeys 76

N

NACO 45

NAV 10

NAV1 1, 10

NAV2 1, 10

Navigation database 19, 20

NEXRAD 37, 38, 72, 77

O

OBS 2

Obstacles 61, 63

Overspeed Protection 14

P

Pathways 43, 44

R

Reversionary mode 49

ROC 57

S

SafeTaxi® 44

Store Flight Plan 27

Stormscope lightning data 35, 36, 72

Strike 35

Strike mode 36

SVS 43, 70

Synthetic Vision System 43

T

TA 58

TAF 37

TAS 39, 58, 66

TAWS 57

Terrain 40, 41, 61, 72, 76, 77

Terrain-SVS 41, 42

Timer 68

Topographical data 72, 76

Traffic 35, 39, 76

Traffic Advisory 58

Traffic advisory 38

Traffic map page 39, 40

Transponder 9, 10, 74, 75

V

Vertical speed guidance 20

Vertical track 58

VNV 17, 50, 70

Vspeed 2

W

WAAS 14, 32, 63, 64

Weather data link page 37

Wind data 73

X

XM lightning 72, 77

XM weather 37



GARMIN



Garmin International, Inc.
1200 East 151st Street
Olathe, KS 66062, U.S.A.
p: 913.397.8200 f: 913.397.8282

Garmin AT, Inc.
2345 Turner Road SE
Salem, OR 97302, U.S.A.
p: 503.391.3411 f: 503.364.2138

Garmin (Europe) Ltd
Liberty House, Bulls Copse Road
Hounslow Business Park
Southampton, SO40 9RB, U.K.
p: 44/0870.8501241 f: 44/0870.8501251

Garmin Corporation
No. 68, Jangshu 2nd Road
Shijr, Taipei County, Taiwan
p: 886/2.2642.9199 f: 886/2.2642.9099

www.garmin.com