



## GMI 10 Installation Instructions

To obtain the best possible performance, install your GMI 10 Marine Instrument according to the following instructions. If you experience difficulty during the installation, contact Garmin Product Support, or seek the advice of a professional installer.

The GMI 10 will communicate with NMEA 2000- or NMEA 0183-compatible sensors and devices, and can show information such as speed, heading, water depth, and fuel information when connected to the appropriate sensors.

### Product Registration

Help us better support you by completing our online registration today. Go to <http://my.garmin.com>. Keep the original sales receipt, or a photocopy, in a safe place.

For future reference, write down the serial number assigned to your GMI 10 in the space provided below. The serial number is located on a sticker on the back of the GMI 10.

**Serial number** \_\_\_\_\_

### Contact Garmin

Contact Garmin Product Support if you have any questions while installing or using your GMI 10. In the USA, go to [www.garmin.com/support](http://www.garmin.com/support), or contact Garmin USA by phone at (913) 397.8200 or (800) 800.1020.

In the UK, contact Garmin (Europe) Ltd. by phone at 0808 2380000.

In Europe, go to [www.garmin.com/support](http://www.garmin.com/support) and click **Contact Support** for in-country support information, or contact Garmin (Europe) Ltd. by phone at +44 (0) 870.8501241.

### Packing List and Accessories

Before installing your GMI 10, confirm that your package includes the following items. If any parts are missing, contact your Garmin dealer immediately.

#### Standard Package

- GMI 10 unit
- Protective cover
- Flush mount hardware
- NMEA 0183 data wiring harness
- 2 NMEA 2000 T-connectors
- 2 NMEA 2000 terminators (1 male, 1 female)
- 1 NMEA 2000 drop cable (2 m)
- 1 NMEA 2000 power cable (2 m), (3 A fuse)
- Installation instructions

#### Optional Accessories

- Additional NMEA 2000 network components

#### Tools Needed

- Jigsaw or 3 <sup>17</sup>/<sub>32</sub> in. (90 mm) hole saw,
- Drill and drill bits
- Center punch and hammer
- Scissors
- File and sandpaper
- Phillips screwdriver
- Anti-seize lubricant (optional)

#### To install and use your GMI 10

1. Select a location ([page 2](#)).
2. Flush mount the GMI 10 ([page 2](#)).
3. Connect the GMI 10 to the sensors and to power ([page 3](#)).

## Step 1: Select a Location for the GMI 10

Consider the following when you select an installation location:

- Provides optimal viewing as you operate your vessel.
- Allows easy access to the keypad on the GMI 10.
- Is strong enough to support the weight of the GMI 10 and protect it from excessive vibration or shock.
- Allows room for the routing and connection of the cables. There should be at least a 3 inch (8 cm) clearance behind the case.
- Is at least 9 1/2 in. (241 mm) from a magnetic compass, to avoid interference.
- Mount the GMI 10 in an area that is not exposed to extreme temperature conditions.

**NOTE:** The temperature range for the GMI 10 is from 5°F to 158°F (from -15°C to 70°C). Extended exposure to temperatures outside this range (in storage or operating conditions) may cause failure of the LCD screen or other components. This type of failure and related consequences are not covered by the manufacturer's limited warranty.

## Step 2: Flush Mounting the GMI 10

In addition to four of the included mounting screws (number 8 ANSI (4.2 × 1.4 DIN7981)), flush mounting the GMI 10 requires the following tools:

- Phillips screwdriver
- Drill and 1/8 in. (3.2 mm) drill bit for mounting holes
- 3 17/32 in. (90 mm) hole saw for pilot hole
- Scissors
- Center punch and hammer
- File and sandpaper
- Anti-seize lubricant (optional)
- Counterbore bit (for fiberglass installations)

**NOTE:** Ensure that the surface on which you mount the GMI 10 has sufficient open space behind it to accommodate the GMI 10 and the connected wires.

### To flush mount the GMI 10:

1. The flush-mount template is included in the product box. Trim the template and ensure that it will fit in the location at which you want to flush mount the GMI 10.
2. The flush-mount template has adhesive on the back. Remove the protective liner and apply the template to the location where you want to flush mount the GMI 10.
3. Using the 3 17/32 in. (90 mm) hole saw, cut the mounting surface along the inside of the dashed line indicated on the flush-mount template. Use a file and sandpaper to refine the size of the hole.
4. Place the GMI 10 into the cutout to confirm that the four mounting-holes are correct after refining the hole. If not, mark the correct locations of the four mounting holes. Remove the GMI 10 from the cutout.
5. Using the center punch, indent the center of each of the four mounting-hole locations.
6. Using a 1/8 in. (3.2 mm) drill bit, drill the four mounting holes.

**NOTE:** If you are mounting the chartplotter in fiberglass, it is recommended to use a countersink bit to drill a clearance-counterbore through only the top gel-coat layer. This will help to avoid any cracking in the gel-coat layer when the screws are tightened.



7. Place the GMI 10 into the cutout.
8. Securely tighten the four mounting screws through the GMI 10 into the drilled mounting holes.  
**NOTE:** Stainless-steel screws may bind when screwed into fiberglass and overtightened. Garmin recommends applying an anti-galling, stainless anti-seize lubricant to the screw before using.
9. Install the mounting covers by snapping them into place.

### Step 3: Connect the GMI 10 to Sensors and to Power

The GMI 10 can connect to sensors using either NMEA 2000 or NMEA 0183.

#### Connecting the GMI 10 through NMEA 2000

The GMI 10 is packaged with the necessary NMEA 2000 connectors and cable to either connect the GMI 10 to your existing NMEA 2000 network or to build a basic NMEA 2000 network. For more information on NMEA 2000, visit [www.garmin.com](http://www.garmin.com). Follow the directions and reference the diagrams on [page 4](#) to either connect the GMI 10 to your existing NMEA 2000 network or to build a basic NMEA 2000 network.

#### To connect the GMI 10 to your existing NMEA 2000 network:

1. Determine where you would like to connect the GMI 10 to your existing NMEA 2000 backbone.
2. Disconnect one side of a NMEA 2000 T-connector from the backbone at an appropriate location.  
 If you need to extend the NMEA 2000 backbone, connect an appropriate NMEA 2000 backbone extension cable (not included) to the side of the T-connector you disconnected.
3. Add the included T-connector for the GMI 10 in the NMEA 2000 backbone by connecting it to the side of the T-connector you disconnected.
4. Route the included drop cable to the bottom of the T-connector you just added to your NMEA 2000 network.  
 If the included drop cable is not long enough, you can use a drop cable up to 20 ft. (6 m) long (not included).
5. Connect the drop cable to the T-connector and the GMI 10.

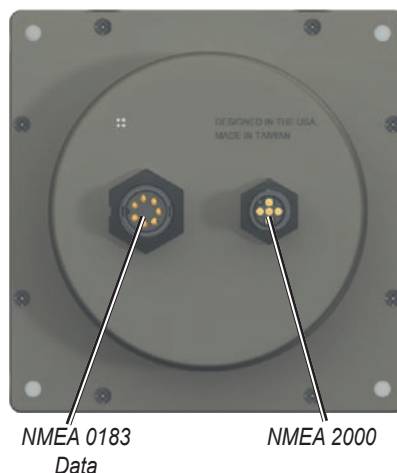

#### NOTICE

If you have an existing NMEA 2000 network on your boat, it should already be connected to power. Do not connect the included NMEA 2000 power cable to an existing NMEA 2000 network, because only one power source should be connected to a NMEA 2000 network.

#### To create a basic NMEA 2000 Network

1. Connect the two T-connectors together by their sides.
2. The included NMEA 2000 power cable must be connected to a 12 Vdc power source through a switch. Connect to the ignition switch of the boat if possible, or through an appropriate additional switch (not included).
3. Connect the NMEA 2000 power cable to one of the T-connectors.
4. Connect the included NMEA 2000 drop cable to the other T-connector and to the GMI 10.
5. Add additional T-connectors for each sensor (not included) you want to add to the NMEA 2000 network, and connect each sensor to a T-connector with the appropriate drop cable (not included).
6. Connect the appropriate terminators to each end of the combined T-connectors.

#### NOTICE

You must connect the included NMEA 2000 power cable to the ignition switch of the boat, or through an external switch. The GMI 10 will drain your battery if it is connected directly.

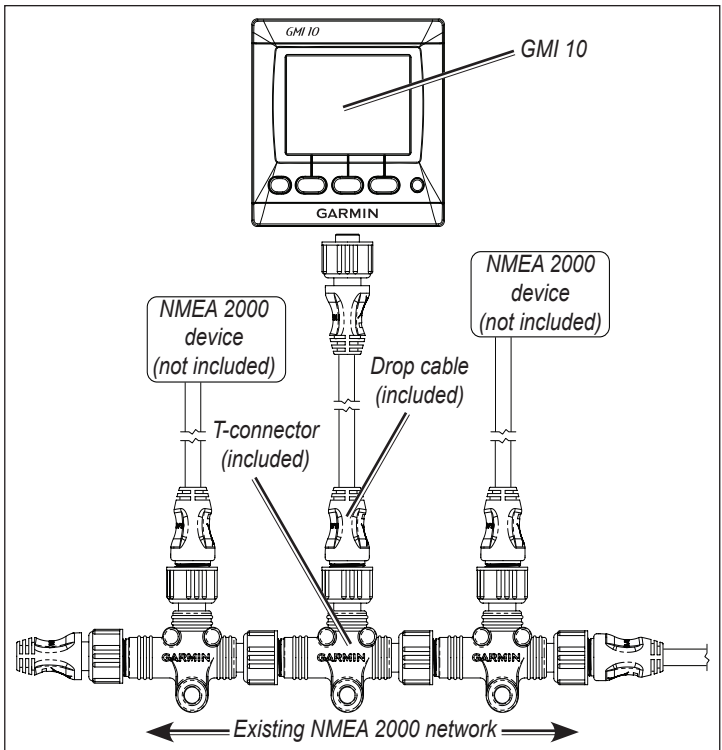

**Connecting the GMI 10 to an Existing NMEA 2000 Network**

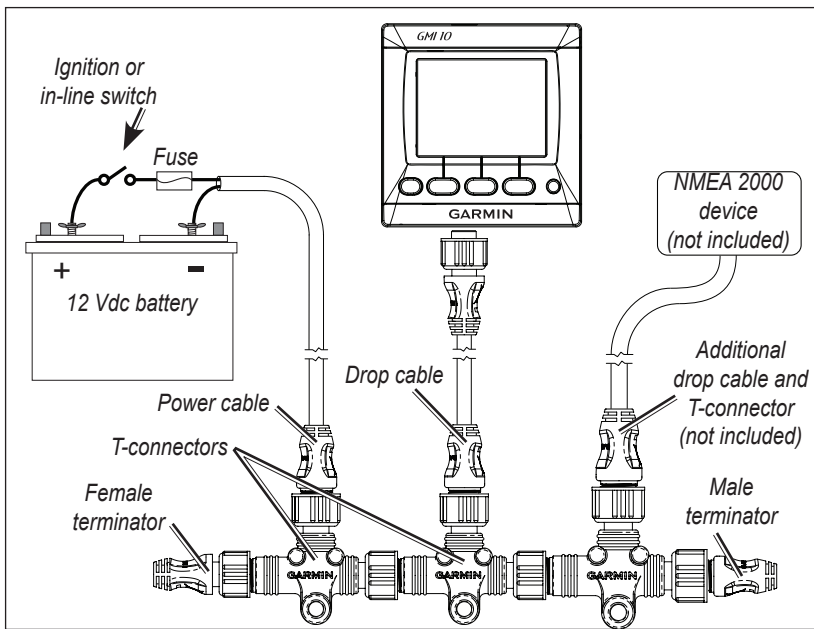

**Creating a Basic NMEA 2000 Network**

**Notes:**

- To add additional sensors to your NMEA 2000 network, follow the instructions included with the sensor.
- To learn more about NMEA 2000 and building a NMEA 2000 network, visit [www.garmin.com](http://www.garmin.com).
- The GMI 10 is powered by the NMEA 2000 network.

## Connecting the GMI 10 through NMEA 0183

The GMI 10 can receive NMEA 0183 data from one device. The GMI 10 displays the received data, but cannot transmit the data to another NMEA 0183 device or transmit the data to a NMEA 2000 network.

Use the diagrams to wire a NMEA 0183 device to your GMI 10. Use 22 AWG, shielded, twisted-pair wiring for extended runs of wire. Solder all connections and seal them with heat-shrink tubing.

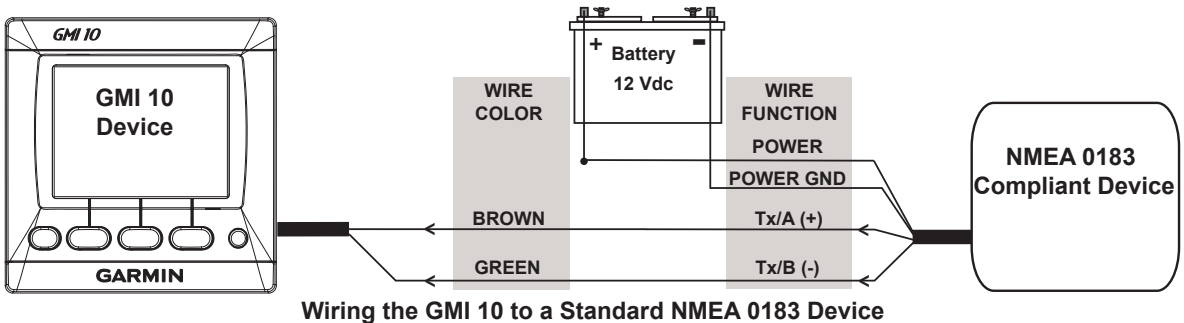
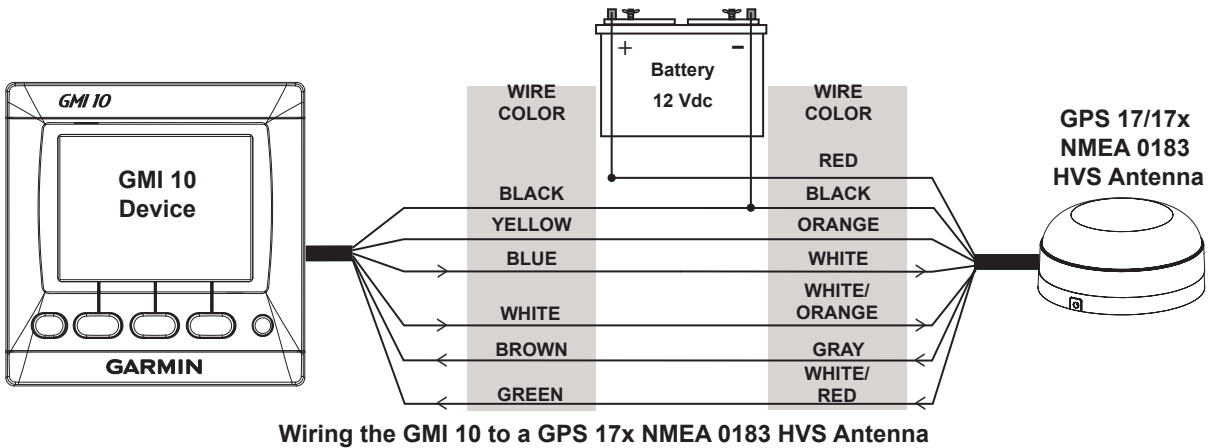
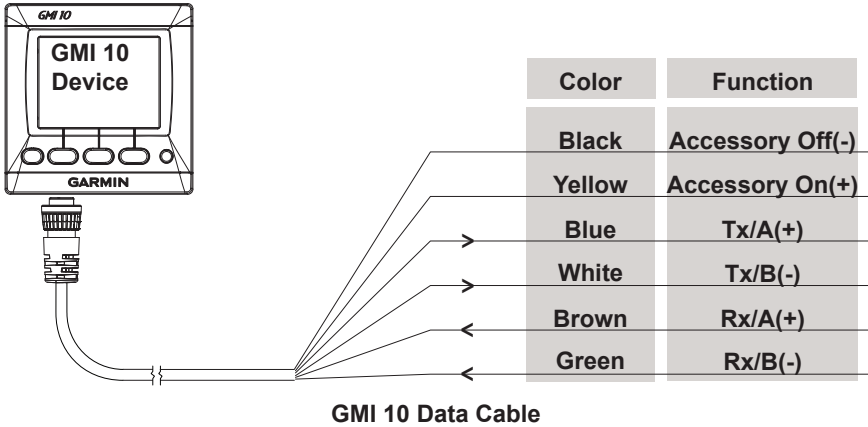

### Notes:

- Consult the instructions for your NMEA 0183-compliant device to identify the Tx/A(+) and Tx/ B(-) wires.
- When connecting NMEA 0183 devices with two transmitting and two receiving lines, it is not necessary for the NMEA 2000 bus and the NMEA 0183 device to connect to a common ground.
- The yellow (accessory on) wire and the black (accessory ground) wire are used only when wiring the GMI 10 to a Garmin GPS 17/17x antenna.

If your NMEA 0183-compatible device has only one transmitting wire (Tx), connect it to the brown wire (Rx/A) from the GMI 10, and connect the green wire (Rx/B) from the GMI 10 to NMEA ground.

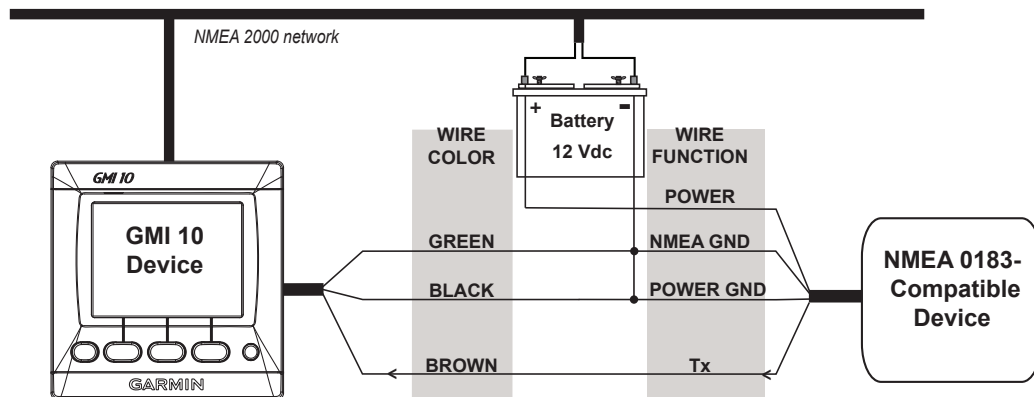

**Wiring the GMI 10 to a NMEA 0183 Device with One Transmitting Wire**

**NOTE:** When connecting a NMEA 0183 device with only one transmitting (Tx) line or with only one receiving (Rx) line, the NMEA 2000 bus and the NMEA 0183 device must be connected to a common ground.

## NMEA 2000 PGN Information

Use this table to determine the approved NMEA 2000 PGN information that can be received and transmitted by a GMI 10 when communicating with a NMEA 2000-compliant device.

Receive		Transmit	
059392	ISO Acknowledgment	059392	ISO Acknowledgment
059904	ISO Request	059904	ISO Request
060928	ISO Address Claim	060928	ISO Address Claim
126208	NMEA - Command/Request/Acknowledge Group Function	126208	NMEA - Command/Request/Acknowledge Group Function
126464	Transmit/Receive PGN List Group Function	126464	Transmit/Receive PGN List Group Function
126992	System Time	126996	Product Information
126996	Product Information		
127250	Vessel Heading		
127489	Engine Parameters - Dynamic		
127505	Fluid Level		
128259	Speed - Water Referenced		
128267	Water Depth		
129025	Position - Rapid Update		
129026	COG & SOG - Rapid Update		
129029	GNSS Position Data		
129044	Datum		
129283	Cross Track Error		
129284	Navigation Data		
129285	Navigation - Route/WP information		
129539	GNSS DOPs		
129540	GNSS Sats in View		
130306	Wind Data		
130310	Environmental Parameters		



The GMI 10 is  
NMEA 2000 certified

Receive		Transmit
130311	Environmental Parameters	
130312	Temperature	
130313	Humidity	
130314	Actual Pressure	

## NMEA 0183 Sentence Information

The GMI 10 can receive the following approved NMEA 0183 sentences from a NMEA 0183-compliant device:

BOD, BWC, DBT, DPT, GGA, GLL, GSA, GSV, HDG, HDM, MDA, MTW, MWD, MWV, RMB, RMC, VHW, WPL, and XTE.

## Specifications

### Physical

**Dimensions:** W × H × D: 4 <sup>5</sup>/<sub>16</sub> × 4 <sup>3</sup>/<sub>8</sub> × 1 <sup>29</sup>/<sub>32</sub> in (109 × 111 × 48 mm)

**Weight:** 9.6 oz. (272 g)

**Cables:** NMEA 0183 data cable - 6 ft. (1.8 m)  
NMEA 2000 drop cable and power cable- 6 <sup>1</sup>/<sub>2</sub> ft. (2 m)

**Temp range:** From 5°F to 158°F (from -15°C to 70°C)

**Compass Safe Distance:** 9 <sup>1</sup>/<sub>2</sub> in. (241 mm)

**Case Material:** Fully gasketed, high-impact plastic alloy, waterproof to IEC 529 IPX7 standards

### Power

**GMI 10 power usage:** 2.5 W max

**NMEA 2000 Power Input:** 9–16 Vdc

**NMEA 2000 Load Equivalency Number (LEN):** 6 (300 mA)

## Declaration of Conformity

Hereby, Garmin, declares that this product is in compliance with the essential requirements and other relevant provisions of Directive 1999/5/EC. To view the full Declaration of Conformity, go to [www.garmin.com/compliance](http://www.garmin.com/compliance).



## Software License Agreement

BY USING THE GMI 10, YOU AGREE TO BE BOUND BY THE TERMS AND CONDITIONS OF THE FOLLOWING SOFTWARE LICENSE AGREEMENT. PLEASE READ THIS AGREEMENT CAREFULLY.

Garmin Ltd. and its subsidiaries (“Garmin”) grant you a limited license to use the software embedded in this device (the “Software”) in binary executable form in the normal operation of the product. Title, ownership rights, and intellectual property rights in and to the Software remain in Garmin and/or its third-party providers.

You acknowledge that the Software is the property of Garmin and/or its third-party providers and is protected under the United States of America copyright laws and international copyright treaties. You further acknowledge that the structure, organization, and code of the Software, for which source code is not provided, are valuable trade secrets of Garmin and/or its third-party providers and that the Software in source code form remains a valuable trade secret of Garmin and/or its third-party providers. You agree not to decompile, disassemble, modify, reverse assemble, reverse engineer, or reduce to human readable form the Software or any part thereof or create any derivative works based on the Software. You agree not to export or re-export the Software to any country in violation of the export control laws of the United States of America or the export control laws of any other applicable country.

For the latest free software updates (excluding map data) throughout the life of your  
Garmin products, visit the Garmin Web site at [www.garmin.com](http://www.garmin.com).



© 2011 Garmin Ltd. or its subsidiaries

Garmin International, Inc.  
1200 East 151<sup>st</sup> Street, Olathe, Kansas 66062, USA

Garmin (Europe) Ltd.  
Liberty House, Hounsdown Business Park, Southampton, Hampshire, SO40 9LR UK

Garmin Corporation  
No. 68, Zhangshu 2<sup>nd</sup> Road, Xizhi Dist., New Taipei City, 221, Taiwan (R.O.C.)

[www.garmin.com](http://www.garmin.com)