

Starting to Navigate

Basic navigation with your eTrex Legend requires only three steps: mark, move, and return. Mark your location as a waypoint, move a distance away, and then return after choosing one of several methods to help you find your way.

To mark a waypoint:

1. Press in and hold the **THUMB STICK** for two seconds to display the Mark Waypoint Page. Your current location is marked as a waypoint and automatically assigned a three digit number.
2. The 'OK' button is highlighted so press the **THUMB STICK** to save the

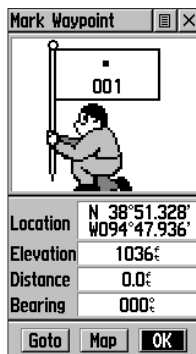

To move about with the Map Page:

1. Use the **PAGE** button to access the Map Page and view the new waypoint.  
Press the **ZOOM IN** button to get a more detailed view of the map.
2. Walk or drive around for a few minutes, make a right or left turn, then continue for a few more minutes and then stop.  
The 'position icon' shows your location and the dotted line shows your path of travel (a Track).

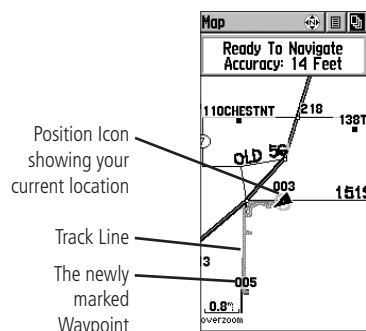

To return to a waypoint using Goto:

1. Press the **FIND** button to display the Find Menu.
2. Use the **THUMB STICK** to highlight 'Waypoints' and then press it in.
3. Use the **THUMB STICK** to highlight 'Nearest' and then press it in.
4. Use the **THUMB STICK** to highlight the waypoint and then press it in to display the Information Page.
5. With the on-screen 'Goto' button highlighted, press the **THUMB STICK** to activate the Goto navigation feature.

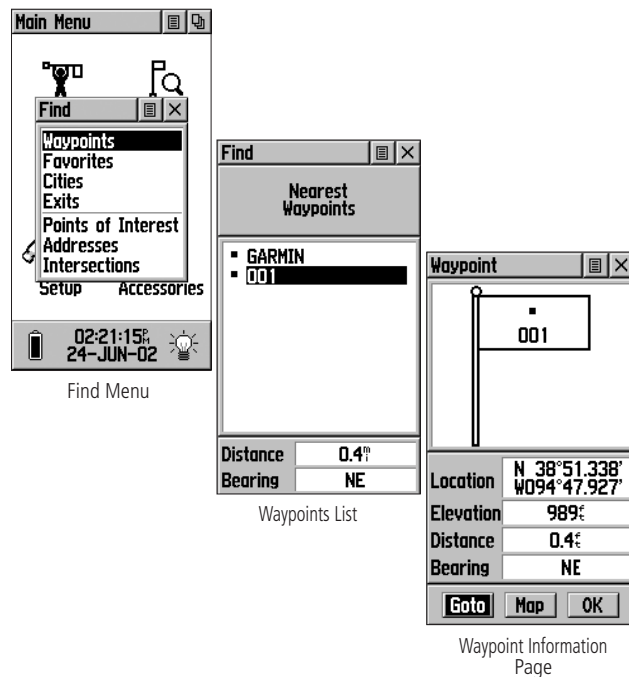

Returning to a Waypoint with a Goto

To finish your return:

1. The Navigation Page displays the 'Bearing Pointer' indicating the direction to go. Because you can't always travel in a straight line, refer to the Bearing Pointer from time to time. As you move and whenever possible, turn in the direction the Bearing Pointer directs.
2. Use the **PAGE** button to move to the Map Page to see your location marked by the Position Icon and a straight dark line leading to the waypoint.  
Move back and forth between the Map Page and the Navigation page to check your progress and verify your bearing.
3. To stop navigating, highlight the Options Menu button on either page, press the **THUMB STICK**, select 'Stop Navigation', and then press the **THUMB STICK**.

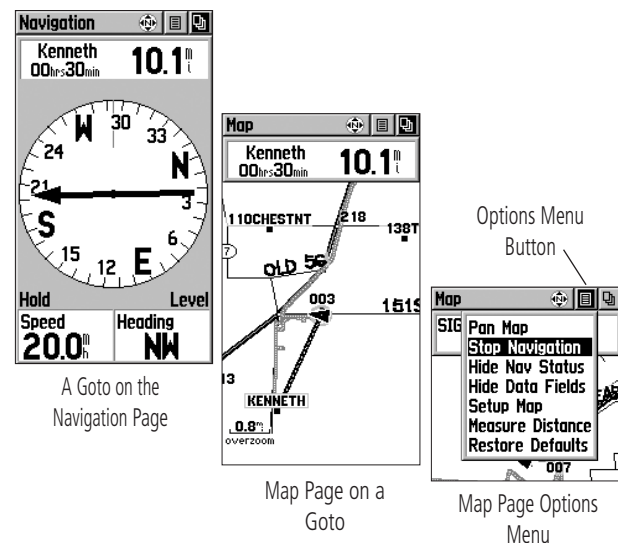

QUICK START GUIDE



## Operating the eTrex Legend

## Operating the eTrex Legend

## The Main Pages, Setting the Time Zone

## Backlighting/Contrast Adjustment

### 1 Installing the Batteries

The eTrex Legend operates on two AA batteries (not included), which are placed in the back of the unit. Rechargeable Alkaline, NiMH, NiCad or Lithium batteries may be used, but cannot be charged in the unit.

Stored data will not be lost when changing the batteries.

#### To install the batteries:

1. Remove the battery cover from the back of the unit by turning the D-ring 1/4 turn counter-clockwise and pulling out.
2. Insert the batteries observing proper polarity as shown at the right.
3. Reinstall the battery cover by turning the D-ring 1/4 turn clockwise.

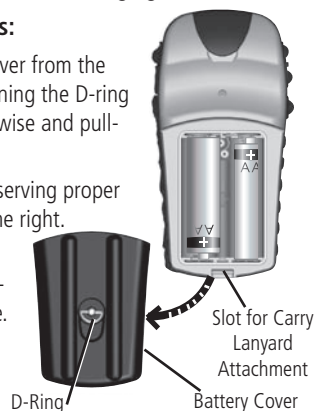

### 2 Using the Button Functions

The ZOOM IN and OUT buttons:

- When on the Map Page, press to Zoom in and out.
- When on the Satellite Page, press to adjust the screen contrast.

The FIND button:

- Press to access the Find Menu.

The THUMB STICK:  
(When moved or pressed in, button 'clicks')

- Press to enter highlighted options or confirm messages.
- Move Up/Down or Right/Left to move through lists, highlight fields, on-screen buttons, icons, en/er data or move the map panning arrow.
- Press in and hold for two seconds to mark your current location as a waypoint.



### 3 Start Up Sequence

To turn the unit On:

1. Press and hold the **POWER** button.
2. Press the **PAGE** button to acknowledge the copyright.
3. Carefully read the warning message and press the **PAGE** button to acknowledge and proceed to the Satellite Page.

The unit may take up to 5 minutes to establish a position the first time you use it outside with a clear view of the sky. After that, it should take only 15 to 45 seconds. When the Legend has acquired enough satellite signals to determine your location, a "Ready To Navigate" message and your location coordinates and elevation are shown.

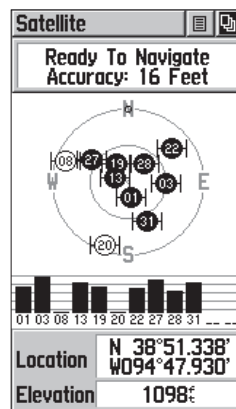

Satellite Page: displaying Satellite Position, Signal Strength, Location, and Elevation

### 4 Previewing the Main Pages

All of the information you need to operate the eTrex Legend is found on the five Main Pages (or display screens). To preview these pages, press the PAGE button to cycle from one page to the next. The five pages are shown in order below.

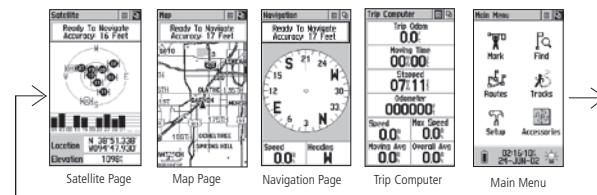

Satellite Page - Provides a visual reference of satellites being tracked.  
Map Page - Displays your movements and nearby map features.  
Navigation Page - Provides guidance to your destination.  
Trip Computer - Provides a variety of trip and navigation data.  
Main Menu - A directory of advanced features and settings.

### 5 Setting the Time Zone

If the Legend is "Ready to Navigate" (Step 3) but the time shown is not correct, you may need to change the Time Zone selection.

To change the Time Zone:

1. Use the **PAGE** button to access the Main Menu.
2. Use the **THUMB STICK** to highlight the SetUp icon and then press it in to display the SetUp Menu.
3. Use the **THUMB STICK** to highlight the Time icon and then press it in to display the Time Page.
4. Use the **THUMB STICK** to highlight the 'Time Zone' field then press it in to display the list of time
5. Highlight a time zone and then press the **THUMB STICK**.
6. The correct time is displayed at the bottom of the page.

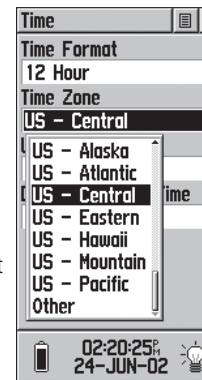

### Adjusting Backlight/Contrast

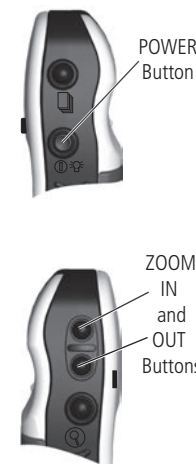

To turn the backlight On and Off:

1. Press the **POWER** button to turn the backlight On.
2. Press again to turn the backlight Off.
3. If no button is pressed (after 15 seconds\*), the backlight will turn Off automatically.

To adjust the screen contrast:

1. Use the **PAGE** button to access the Satellite Page.
2. Use the **ZOOM IN** and **OUT** buttons to adjust the contrast.

\*To set the backlight feature for longer On Time, refer to the Owner's Manual.

### Additional Map Data Available

You can transfer optional detailed map data to the eTrex Legend from a GARMIN MapSource® CD-ROM. Available choices include the MetroGuide, Points of Interest (Businesses, Landmarks, Cities, and Marine nav aids), BlueChart™, Fishing Hot Spots, Topographic maps, Roads and Recreation, and WorldMap mapping guides.

See your Owner's Manual for connection details.



Points of Interest List

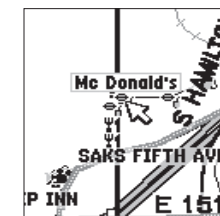

Map Showing Restaurant Choice

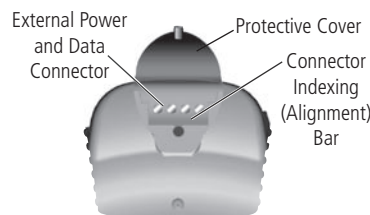

NOTE: While designed to be held and operated in the left hand, the unit can be used with the right hand, if preferred.